

TPS82150 17V 输入、1A 降压转换器 MicroSiP™ 模块

1 特性

- 3.0mm x 2.8mm x 1.5mm MicroSiP™ 封装
- 输入电压范围：3.0V 至 17V
- 1A 持续输出电流
- DCS-Control™ 拓扑技术
- 在轻负载条件下实现高效率的省电模式
- 20 μ A 静态工作电流
- 0.9V 至 6V 可调节输出电压
- 可实现最低压降的 100% 占空比
- 电源正常输出
- 具有跟踪功能的可编程软启动
- 热关断保护
- 与 TPS82130 和 TPS82140 引脚对引脚兼容
- -40°C 至 125°C 的工作温度范围
- 使用 TPS82150 并借助 WEBENCH® 电源设计器创建定制设计方案

2 应用

- 工业 应用
- 电信和网络 应用
- 固态硬盘
- 逆变电源

3 说明

TPS82150 是一款 17V 输入、1A 降压转换器 MicroSiP™ 电源模块，经优化兼具小型解决方案尺寸和高效率优势。该模块集成了同步降压转换器和电感，可简化设计、减少外部元件数量并节省印刷电路板 (PCB) 的面积。该器件采用紧凑的薄型封装，适合通过标准表面贴装设备自动组装。

为了最大限度地提高效率，该转换器以 2.0MHz 的标称开关频率在脉宽调制 (PWM) 模式下工作，并且会在轻负载电流条件下自动进入节能工作模式。在节能模式下，该器件静态工作电流的典型值为 20 μ A。凭借 DCS-Control™ 拓扑，器件可获得出色的负载瞬态性能和精确的输出稳压。

器件信息(1)

| 器件型号 | 封装 | 封装尺寸 (标称值) |
|-------------|---------------|-----------------------|
| TPS82150SIL | μ SiL (8) | 3.0mm x 2.8mm x 1.5mm |

(1) 要了解所有可用封装，请见数据表末尾的可订购产品附录。

典型应用电路原理图

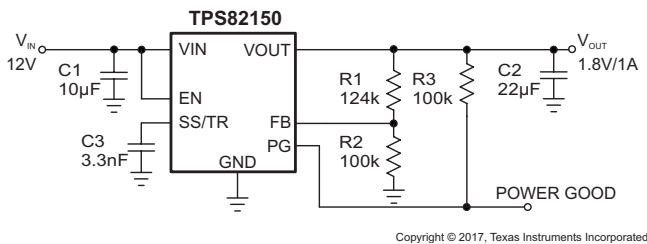

效率与输出电流, $V_{IN}=12V$

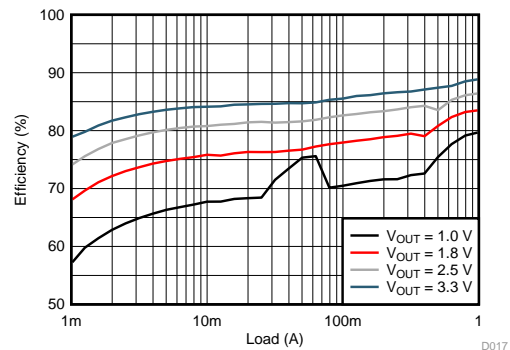

D017



目录

| | | | | | |
|----------|--|----------|-----------|---|-----------|
| 1 | 特性 | 1 | 8 | Application and Implementation | 11 |
| 2 | 应用 | 1 | 8.1 | Application Information..... | 11 |
| 3 | 说明 | 1 | 8.2 | Typical Applications | 11 |
| 4 | 修订历史记录 | 2 | 8.3 | System Examples | 17 |
| 5 | Pin Configuration and Functions | 3 | 9 | Power Supply Recommendations | 18 |
| 6 | Specifications | 4 | 10 | Layout | 18 |
| 6.1 | Absolute Maximum Ratings | 4 | 10.1 | Layout Guidelines | 18 |
| 6.2 | ESD Ratings..... | 4 | 10.2 | Layout Example | 18 |
| 6.3 | Recommend Operating Conditions..... | 4 | 10.3 | Thermal Consideration..... | 19 |
| 6.4 | Thermal Information | 4 | 11 | 器件和文档支持 | 20 |
| 6.5 | Electrical Characteristics..... | 5 | 11.1 | 器件支持 | 20 |
| 6.6 | Typical Characteristics | 6 | 11.2 | 接收文档更新通知 | 20 |
| 7 | Detailed Description | 7 | 11.3 | 社区资源 | 20 |
| 7.1 | Overview | 7 | 11.4 | 商标 | 20 |
| 7.2 | Functional Block Diagram | 7 | 11.5 | 静电放电警告 | 20 |
| 7.3 | Feature Description..... | 8 | 11.6 | Glossary | 20 |
| 7.4 | Device Functional Modes..... | 9 | 12 | 机械、封装和可订购信息 | 21 |

4 修订历史记录

| 日期 | 修订版本 | 注意 |
|------------|------|--------|
| 2017 年 6 月 | * | 初始发行版。 |

5 Pin Configuration and Functions

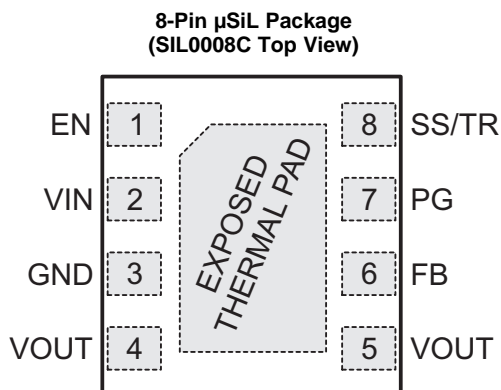

Pin Functions

| PIN | | I/O | DESCRIPTION |
|---------------------|-----|-----|---|
| NAME | NO. | | |
| EN | 1 | I | Enable pin. Pull High to enable the device. Pull Low to disable the device. This pin has an internal pull-down resistor of typically 400k Ω when the device is disabled. |
| VIN | 2 | PWR | Input pin. |
| GND | 3 | | Ground pin. |
| VOUT | 4,5 | PWR | Output pin. |
| FB | 6 | I | Feedback reference pin. An external resistor divider connected to this pin programs the output voltage. |
| PG | 7 | O | Power good open drain output pin. A pull-up resistor can be connected to any voltage less than 6V. Leave it open if it is not used. |
| SS/TR | 8 | I | Soft startup and voltage tracking pin. An external capacitor connected to this pin sets the internal reference voltage rising time. |
| Exposed Thermal Pad | | | The exposed thermal pad must be connected to the GND pin. Must be soldered to achieve appropriate power dissipation and mechanical reliability. |

6 Specifications

6.1 Absolute Maximum Ratings⁽¹⁾

| | | MIN | MAX | UNIT |
|--------------------------------|------------------|------|-----------------------|------|
| Voltage at pins ⁽²⁾ | V _{IN} | -0.3 | 20 | V |
| | EN, SS/TR | -0.3 | V _{IN} + 0.3 | |
| | PG, FB | -0.3 | 7 | |
| | V _{OUT} | 0 | 7 | |
| Sink current | PG | | 10 | mA |
| Module operating temperature | | -40 | 125 | °C |
| Storage temperature | | -55 | 125 | °C |

- (1) Stresses beyond those listed under absolute maximum ratings may cause permanent damage to the device. These are stress ratings only, and functional operation of the device at these or any other conditions beyond those indicated under recommended operating conditions is not implied. Exposure to absolute-maximum-rated conditions for extended periods may affect device reliability.
- (2) All voltage values are with respect to network ground pin.

6.2 ESD Ratings

| | | VALUE | UNIT |
|--|--|-------|------|
| V _(ESD) Electrostatic discharge | Human body model (HBM), per ANSI/ESDA/JEDEC JS-001 ⁽¹⁾ | ±2000 | V |
| | Charged device model (CDM), per JEDEC specification JESD22-C101 ⁽²⁾ | ±1000 | |

- (1) JEDEC document JEP155 states that 500-V HBM allows safe manufacturing with a standard ESD control process.
- (2) JEDEC document JEP157 states that 250-V CDM allows safe manufacturing with a standard ESD control process.

6.3 Recommend Operating Conditions

| | | MIN | MAX | UNIT |
|------------------|--|-----|-----|------|
| V _{IN} | Input voltage | 3 | 17 | V |
| V _{PG} | Power good pull-up resistor voltage | | 6 | V |
| V _{OUT} | Output voltage | 0.9 | 6 | V |
| I _{OUT} | Output current | 0 | 1 | A |
| T _J | Module operating temperature range for 100,000 hours lifetime ⁽¹⁾ | -40 | 110 | °C |

- (1) The module operating temperature range includes module self temperature rise and IC junction temperature rise. In applications where high power dissipation is present, the maximum operating temperature or maximum output current must be derated. For applications where the module operates continuously at 125 °C temperature, the maximum lifetime is reduced to 50,000 hours.

6.4 Thermal Information

| THERMAL METRIC ⁽¹⁾ | TPS82150 | | UNIT | |
|-------------------------------|--|------|------|------|
| | 8-Pin SIL | | | |
| | JEDEC 51-5 | EVM | | |
| R _{θJA} | Junction-to-ambient thermal resistance | 58.2 | 46.1 | °C/W |
| R _{θJC(top)} | Junction-to-case (top) thermal resistance | 9.4 | 9.4 | °C/W |
| R _{θJB} | Junction-to-board thermal resistance | 14.4 | 14.4 | °C/W |
| ψ _{JT} | Junction-to-top characterization parameter | 0.9 | 0.9 | °C/W |
| ψ _{JB} | Junction-to-board characterization parameter | 14.2 | 14.0 | °C/W |
| R _{θJC(bot)} | Junction-to-case (bottom) thermal resistance | 21.3 | 21.3 | °C/W |

- (1) For more information about traditional and new thermal metrics, see the IC Package Thermal Metrics application report, [SPRA953](#). Theta-JA can be improved with a custom PCB design containing thermal vias where possible.

6.5 Electrical Characteristics

$T_J = -40^{\circ}\text{C}$ to 125°C and $V_{IN} = 3.0\text{V}$ to 17V . Typical values are at $T_J = 25^{\circ}\text{C}$ and $V_{IN} = 12\text{V}$, unless otherwise noted.

| PARAMETER | | TEST CONDITIONS | MIN | TYP | MAX | UNIT | |
|-----------------------------|------------------------------------|--|--|-------|-----|--------------------|----|
| SUPPLY | | | | | | | |
| I_Q | Quiescent current into VIN | No load, device not switching | | 20 | 35 | μA | |
| I_{SD} | Shutdown current into VIN | EN = Low | | 1.5 | 7.4 | μA | |
| V_{UVLO} | Under voltage lock out threshold | V_{IN} falling | 2.6 | 2.7 | 2.8 | V | |
| | | V_{IN} rising | 2.8 | 2.9 | 3.0 | V | |
| T_{JSD} | Thermal shutdown threshold | T_J rising | | 160 | | $^{\circ}\text{C}$ | |
| | | T_J falling | | 140 | | $^{\circ}\text{C}$ | |
| LOGIC INTERFACE (EN) | | | | | | | |
| V_{IH} | High-level input voltage | | 0.9 | 0.65 | | V | |
| V_{IL} | Low-level input voltage | | | 0.45 | 0.3 | V | |
| $I_{lkq(EN)}$ | Input leakage current into EN pin | EN = High | | 0.01 | 1 | μA | |
| CONTROL (SS/TR, PG) | | | | | | | |
| $I_{SS/TR}$ | SS/TR pin source current | | 2.1 | 2.5 | 2.8 | μA | |
| V_{PG} | Power good threshold | V_{OUT} rising, referenced to V_{OUT} nominal | 92% | 95% | 99% | | |
| | | V_{OUT} falling, referenced to V_{OUT} nominal | 87% | 90% | 94% | | |
| $V_{PG,OL}$ | Power good low-level voltage | $I_{sink} = 2\text{mA}$ | | 0.1 | 0.3 | V | |
| $I_{lkq(PG)}$ | Input leakage current into PG pin | $V_{PG} = 1.8\text{V}$ | | 1 | 400 | nA | |
| OUTPUT | | | | | | | |
| V_{FB} | Feedback regulation voltage | PWM mode | | 785 | 800 | 815 | mV |
| | | | $T_J = 0^{\circ}\text{C}$ to 85°C | 788 | 800 | 812 | |
| | | PSM | $C_{OUT} = 22\mu\text{F}$ | 785 | 800 | 823 | |
| | | | $C_{OUT} = 2 \times 22\mu\text{F}$, $T_J = 0^{\circ}\text{C}$ to 85°C | 788 | 800 | 815 | |
| $I_{lkq(FB)}$ | Feedback input leakage current | $V_{FB} = 0.8\text{V}$ | | 1 | 100 | nA | |
| | Line regulation | $I_{OUT} = 1\text{A}$, $V_{OUT} = 1.8\text{V}$ | | 0.002 | | %/V | |
| | Load regulation | $I_{OUT} = 0.5\text{A}$ to 1A , $V_{OUT} = 1.8\text{V}$ | | 0.12 | | %/A | |
| POWER SWITCH | | | | | | | |
| $R_{DS(on)}$ | High-side FET on-resistance | $I_{SW} = 500\text{mA}$, $V_{IN} \geq 6\text{V}$ | | 90 | 170 | m Ω | |
| | | $I_{SW} = 500\text{mA}$, $V_{IN} = 3\text{V}$ | | 120 | | | |
| | Low-side FET on-resistance | $I_{SW} = 500\text{mA}$, $V_{IN} \geq 6\text{V}$ | | 40 | 70 | | |
| | | $I_{SW} = 500\text{mA}$, $V_{IN} = 3\text{V}$ | | 50 | | | |
| R_{DP} | Dropout resistance | 100% mode, $V_{IN} \geq 6\text{V}$ | | 125 | | m Ω | |
| | | 100% mode, $V_{IN} = 3\text{V}$ | | 160 | | | |
| I_{LIMF} | High-side FET switch current limit | $V_{IN} = 6\text{V}$, $T_J = 25^{\circ}\text{C}$ | 1.7 | 2.2 | 2.7 | A | |
| f_{SW} | PWM switching frequency | $I_{OUT} = 1\text{A}$, $V_{OUT} = 1.8\text{V}$ | | 2.0 | | MHz | |

6.6 Typical Characteristics



图 1. Dropout Resistance



图 2. Quiescent Current

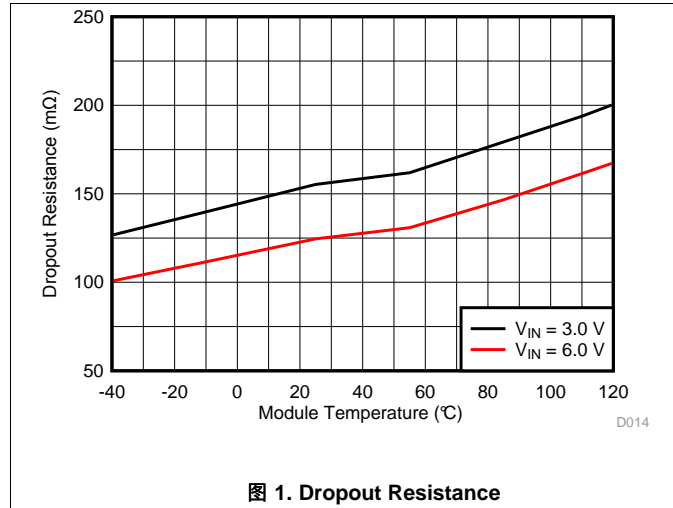

图 3. Shutdown Current

7 Detailed Description

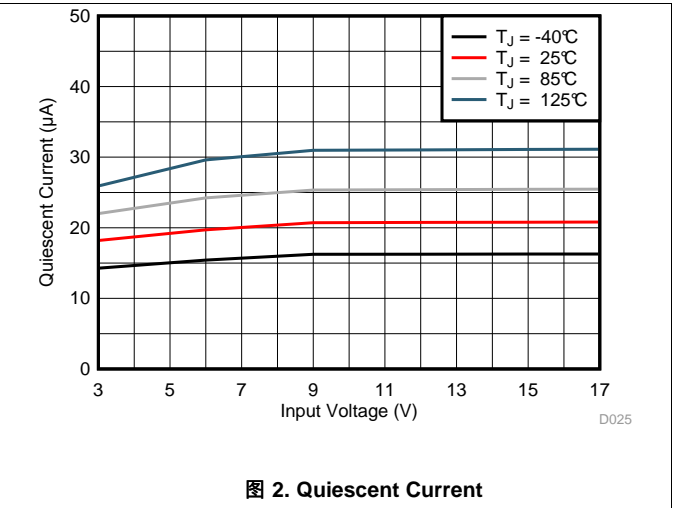
7.1 Overview

The TPS82150 synchronous step-down converter MicroSiP™ power module is based on DCS-Control™ (Direct Control with Seamless transition into Power Save Mode). This is an advanced regulation topology that combines the advantages of hysteretic and voltage mode control.

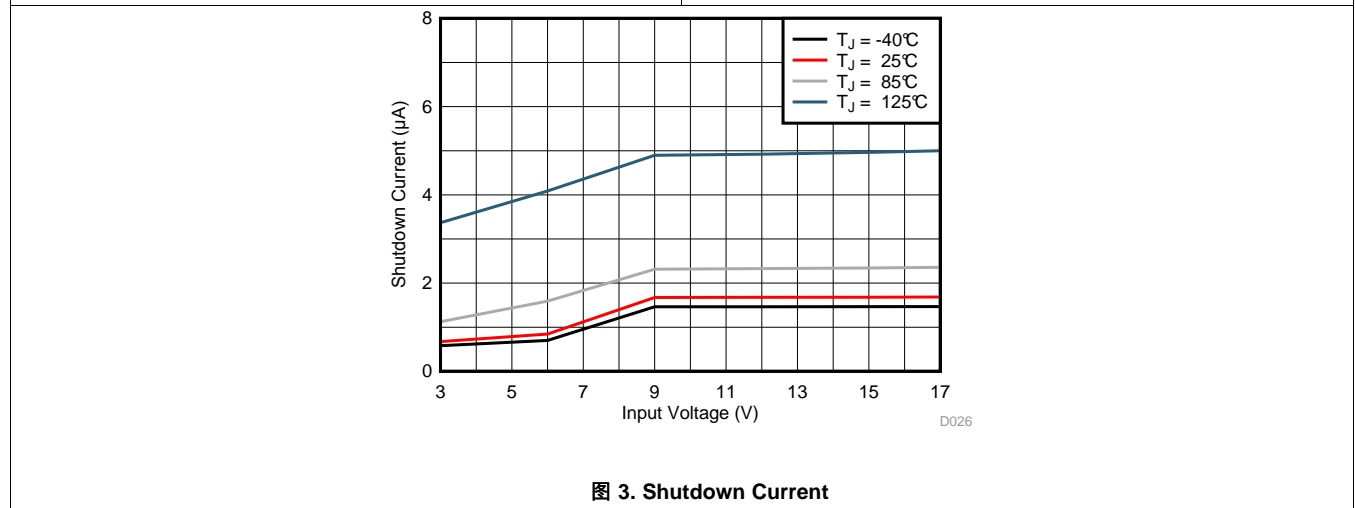
The DCS-Control™ topology operates in PWM (Pulse Width Modulation) mode for medium to heavy load conditions and in PSM (Power Save Mode) at light load currents. In PWM mode, the converter operates with its nominal switching frequency of 2.0 MHz having a controlled frequency variation over the input voltage range. As the load current decreases, the converter enters Power Save Mode, reducing the switching frequency and minimizing the IC's quiescent current to achieve high efficiency over the entire load current range. DCS-Control™ supports both operation modes using a single building block and therefore has a seamless transition from PWM to PSM without effects on the output voltage. The TPS82150 offers excellent DC voltage regulation and load transient regulation, combined with low output voltage ripple, minimizing interference with RF circuits.

7.2 Functional Block Diagram

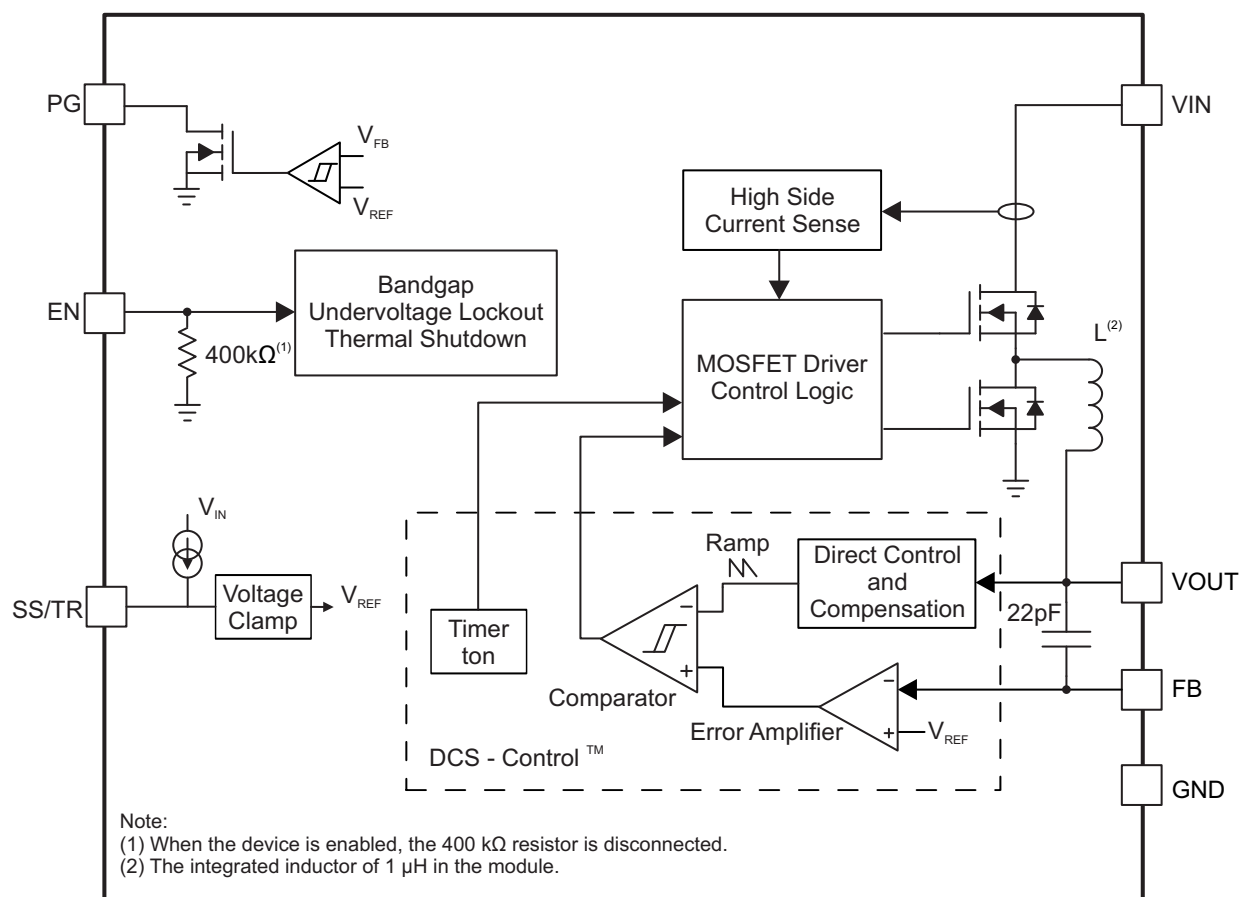

Copyright © 2016, Texas Instruments Incorporated

7.3 Feature Description

7.3.1 PWM and PSM Operation

The TPS82150 includes an on-time (t_{ON}) circuitry. This t_{ON} , in steady-state operation in PWM and PSM modes, is estimated as:

$$t_{ON} = 500\text{ns} \times \frac{V_{OUT}}{V_{IN}} \quad (1)$$

In PWM mode, the TPS82150 operates with pulse width modulation in continuous conduction mode (CCM) with a t_{ON} shown in 公式 1 at medium and heavy load currents. A PWM switching frequency of typically 2.0MHz is achieved by this t_{ON} circuitry. The device operates in PWM mode as long as the output current is higher than half the inductor's ripple current estimated by 公式 2.

$$\Delta I_L = t_{ON} \times \frac{V_{IN} - V_{OUT}}{L} \quad (2)$$

To maintain high efficiency at light loads, the device enters Power Save Mode seamlessly when the load current decreases. This happens when the load current becomes smaller than half the inductor's ripple current. In PSM, the converter operates with reduced switching frequency and with a minimum quiescent current to maintain high efficiency. PSM is also based on the t_{ON} circuitry. The switching frequency in PSM is estimated as:

$$f_{PSM} = \frac{2 \times I_{OUT}}{t_{ON}^2 \times \frac{V_{IN}}{V_{OUT}} \times \frac{V_{IN} - V_{OUT}}{L}} \quad (3)$$

In PSM, the output voltage rises slightly above the nominal output voltage in PWM mode. This effect is reduced by increasing the output capacitance. The output voltage accuracy in PSM operation is reflected in the electrical specification table and given for a 22- μ F output capacitor.

For very small output voltages, an absolute minimum on-time of about 80ns is kept to limit switching losses. The operating frequency is thereby reduced from its nominal value, which keeps efficiency high. Also the off-time can reach its minimum value at high duty cycles. The output voltage remains regulated in such cases.

When V_{IN} decreases to typically 15% above V_{OUT} , the TPS82150 can't enter Power Save Mode, regardless of the load current. The device maintains output regulation in PWM mode.

7.3.2 Low Dropout Operation (100% Duty Cycle)

The TPS82150 offers a low input to output voltage differential by entering 100% duty cycle mode. In this mode, the high-side MOSFET switch is constantly turned on. This is particularly useful in battery powered applications to achieve longest operation time by taking full advantage of the whole battery voltage range. The minimum input voltage to maintain a minimum output voltage is given by:

$$V_{IN(\min)} = V_{OUT(\min)} + I_{OUT} \times R_{DP} \quad (4)$$

Where

R_{DP} = Resistance from V_{IN} to V_{OUT} , including high-side FET on-resistance and DC resistance of the inductor

$V_{OUT(\min)}$ = Minimum output voltage the load can accept.

Feature Description (接下页)

7.3.3 Switch Current Limit

The switch current limit prevents the device from high inductor current and from drawing excessive current from the battery or input voltage rail. Excessive current might occur with a heavy load/shorted output circuit condition. If the inductor peak current reaches the switch current limit after a propagation delay of typically 30ns, the high-side FET is turned off and the low-side FET is turned on to ramp down the inductor current.

7.3.4 Undervoltage Lockout

To avoid mis-operation of the device at low input voltages, an under voltage lockout is implemented, which shuts down the devices at voltages lower than V_{UVLO} with a hysteresis of 200mV.

7.3.5 Thermal Shutdown

The device goes into thermal shutdown and stops switching once the junction temperature exceeds T_{JSD} . Once the device temperature falls below the threshold by 20°C, the device returns to normal operation automatically.

7.4 Device Functional Modes

7.4.1 Enable and Disable (EN)

The device is enabled by setting the EN pin to a logic High. Accordingly, the shutdown mode is forced if the EN pin is pulled Low with a shutdown current of typically 1.5 μ A.

An internal pull-down resistor of 400k Ω is connected to the EN pin when the EN pin is Low. The pull-down resistor is disconnected when the EN pin is High.

7.4.2 Soft Startup (SS/TR)

The internal voltage clamp controls the output voltage slope during startup. This avoids excessive inrush current and ensures a controlled output voltage rise time. When the EN pin is pulled high, the device starts switching after a delay of typically 55 μ s and the output voltage rises with a slope controlled by an external capacitor connected to the SS/TR pin. Using a very small capacitor or leaving the SS/TR pin floating provides fastest startup time.

The TPS82150 is able to start into a pre-biased output capacitor. During the pre-biased startup, both the power MOSFETs are not allowed to turn on until the internal voltage clamp sets an output voltage above the pre-bias voltage.

When the device is in shutdown, undervoltage lockout or thermal shutdown, the capacitor connected to SS/TR pin is discharged by an internal resistor. Returning from those states causes a new startup sequence.

7.4.3 Voltage Tracking (SS/TR)

The SS/TR pin is externally driven by another voltage source to achieve output voltage tracking. The application circuit is shown in 图 4.



图 4. Output Voltage Tracking

Device Functional Modes (接下页)

When the SS/TR pin voltage is between 50 mV and 1.2 V, the VOUT2 tracks the VOUT1 as described in [公式 5](#).

$$\frac{V_{OUT2}}{V_{OUT1}} \approx 0.64 \times \frac{R2}{R1+R2} \times \frac{R3+R4}{R4} \quad (5)$$

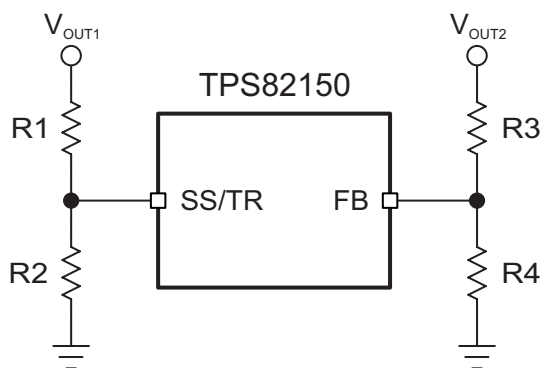
When the SS/TR pin voltage is above 1.2 V, the voltage tracking is disabled and the FB pin voltage is regulated at 0.8 V. For decreasing SS/TR pin voltage, the device doesn't sink current from the output. So the resulting decreases of the output voltage may be slower than the SS/TR pin voltage if the load is light. When driving the SS/TR pin with an external voltage, do not exceed the voltage rating of the SS/TR pin which is VIN+0.3V.

Details about tracking and sequencing circuits are found in [SLVA470](#).

7.4.4 Power Good Output (PG)

The device has a power good (PG) output. The PG pin goes high impedance once the output is above 95% of the nominal voltage, and is driven low once the output voltage falls below typically 90% of the nominal voltage. The PG pin is an open drain output and is specified to sink up to 2mA. The power good output requires a pull-up resistor connecting to any voltage rail less than 6V.

The PG pin goes low when the device is in shutdown or thermal shutdown. When the device is in UVLO, the PG pin is high impedance. The PG signal can be used for sequencing of multiple rails by connecting it to the EN pin of other converters. Leave the PG pin floating when it is not used. [表 1](#) shows the PG pin logic.

表 1. Power Good Pin Logic

| Device State | | PG Logic Status | |
|----------------------|------------------------------------|-----------------|-----|
| | | High Impedance | Low |
| Enable (EN=High) | $V_{FB} \geq V_{TH_PG}$ | √ | |
| | $V_{FB} \leq V_{TH_PG}$ | | √ |
| Shutdown (EN=Low) | | | √ |
| UVLO | $0.7\text{ V} < V_{IN} < V_{UVLO}$ | | √ |
| Thermal Shutdown | $T_J > T_{SD}$ | | √ |
| Power Supply Removal | $V_{IN} < 0.7\text{ V}$ | √ | |

8 Application and Implementation

注

Information in the following applications sections is not part of the TI component specification, and TI does not warrant its accuracy or completeness. TI's customers are responsible for determining suitability of components for their purposes. Customers should validate and test their design implementation to confirm system functionality.

8.1 Application Information

The output voltage of the TPS82150 is adjusted by component selection. The following section discusses the design of the external components to complete the power supply design for several input and output voltage options by using typical applications as a reference.

8.2 Typical Applications

8.2.1 1.8-V Output Application

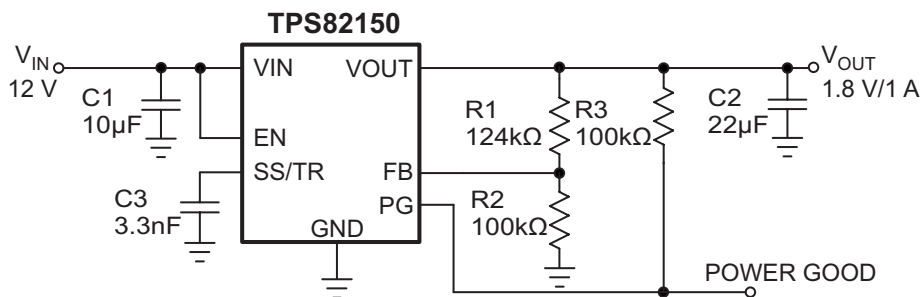

Copyright © 2016, Texas Instruments Incorporated

图 5. 1.8-V Output Application

8.2.1.1 Design Requirements

For this design example, use the following as the input parameters.

表 2. Design Parameters

| DESIGN PARAMETER | EXAMPLE VALUE |
|-----------------------|---------------|
| Input voltage range | 12V |
| Output voltage | 1.8V |
| Output ripple voltage | < 20mV |
| Output current rating | 1A |

The components used for measurements are given in the following table.

表 3. List of Components

| REFERENCE | DESCRIPTION ⁽¹⁾ | MANUFACTURER |
|------------|--|--------------|
| C1 | 10 µF, 25 V, X7R, ±20%, size 1206, C3216X7R1E106M160AE | TDK |
| C2 | 22 µF, 10 V, X7S, ±20%, size 0805, C2012X7S1A226M125AC | TDK |
| C3 | 3300 pF, 50 V, ±5%, C0G/NP0, size 0603, GRM1885C1H332JA01D | Murata |
| R1, R2, R3 | Standard | |

(1) See [Third-party Products Disclaimer](#)

8.2.1.2 Detailed Design Procedure

8.2.1.2.1 Custom Design with WEBENCH® Tools

[Click here](#) to create a custom design using the TPS82150 device with the WEBENCH® Power Designer.

1. Start by entering your V_{IN} , V_{OUT} , and I_{OUT} requirements.
2. Optimize your design for key parameters like efficiency, footprint and cost using the optimizer dial and compare this design with other possible solutions from Texas Instruments.
3. The WEBENCH Power Designer provides you with a customized schematic along with a list of materials with real time pricing and component availability.
4. In most cases, you will also be able to:
 - Run electrical simulations to see important waveforms and circuit performance
 - Run thermal simulations to understand the thermal performance of your board
 - Export your customized schematic and layout into popular CAD formats
 - Print PDF reports for the design, and share your design with colleagues
5. Get more information about WEBENCH tools at www.ti.com/WEBENCH.

8.2.1.2.2 Setting the Output Voltage

The output voltage is set by an external resistor divider according to the following equations:

$$V_{OUT} = V_{FB} \times \left(1 + \frac{R1}{R2}\right) = 0.8 \text{ V} \times \left(1 + \frac{R1}{R2}\right) \quad (6)$$

$R2$ should not be higher than 100k Ω to achieve high efficiency at light load while providing acceptable noise sensitivity. Larger currents through $R2$ improve noise sensitivity and output voltage accuracy. [图 5](#) shows the external resistor divider value for a 1.8-V output. Choose appropriate resistor values for other outputs.

In case the FB pin gets opened, the device clamps the output voltage at the VOUT pin internally to about 7V.

8.2.1.2.3 Input and Output Capacitor Selection

For best output and input voltage filtering, low ESR ceramic capacitors are required. The input capacitor minimizes input voltage ripple, suppresses input voltage spikes and provides a stable system rail for the device. A 10- μF or larger input capacitor is required. The output capacitor value can range from 22 μF up to more than 400 μF . Higher values are possible as well and can be evaluated through the transient response. Larger soft start times are recommended for higher output capacitances.

High capacitance ceramic capacitors have a DC Bias effect, which will have a strong influence on the final effective capacitance. Therefore the right capacitor value has to be chosen carefully. Package size and voltage rating in combination with dielectric material are responsible for differences between the rated capacitor value and the effective capacitance.

8.2.1.2.4 Soft Startup Capacitor Selection

A capacitance connected between the SS/TR pin and the GND allows programming the startup slope of the output voltage. A constant current of 2.5 μA charges the external capacitor. The capacitance required for a given soft startup time for the output voltage is given by:

$$C_{SS/TR} = t_{SS/TR} \times \frac{I_{SS/TR}}{1.25\text{V}} \quad (7)$$

8.2.1.3 Application Performance Curves

$T_A = 25^\circ\text{C}$, $V_{IN} = 12\text{ V}$, $V_{OUT} = 1.8\text{ V}$, unless otherwise noted.



图 6. Efficiency, $V_{OUT} = 1.0\text{ V}$



图 7. Efficiency, $V_{OUT} = 1.0\text{ V}$

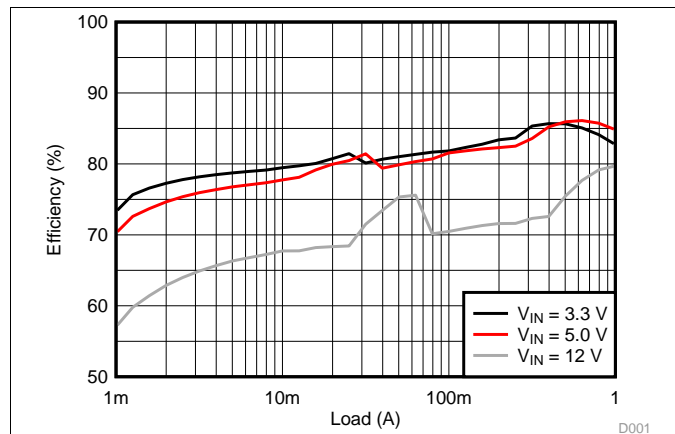

图 8. Efficiency, $V_{OUT} = 1.8\text{ V}$

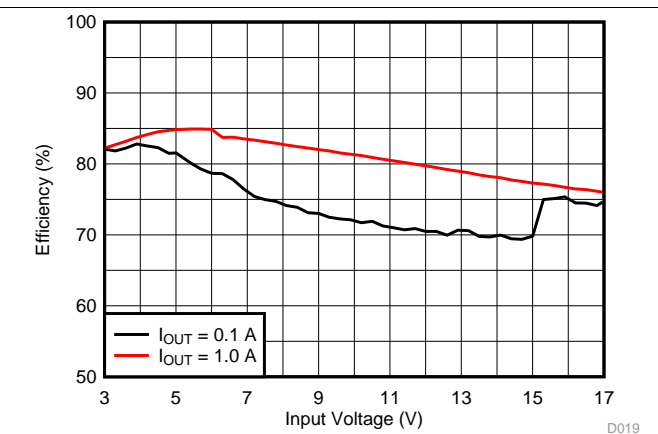

图 9. Efficiency, $V_{OUT} = 1.8\text{ V}$

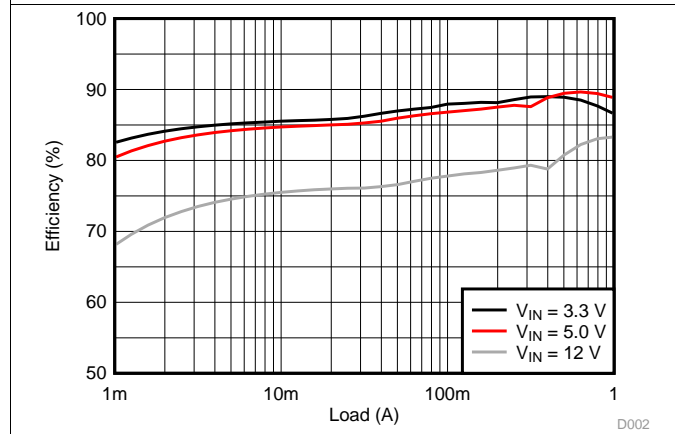

图 10. Efficiency, $V_{OUT} = 2.5\text{ V}$

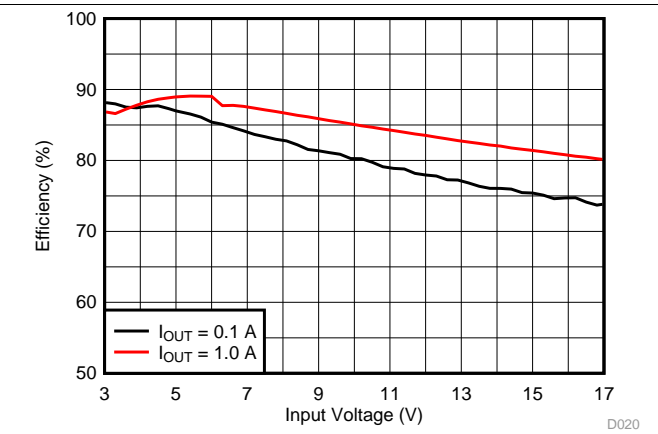

图 11. Efficiency, $V_{OUT} = 2.5\text{ V}$

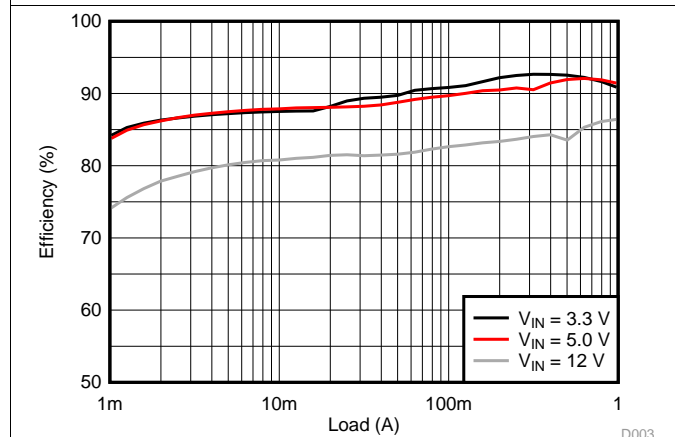

图 12. Efficiency, $V_{OUT} = 3.3\text{ V}$

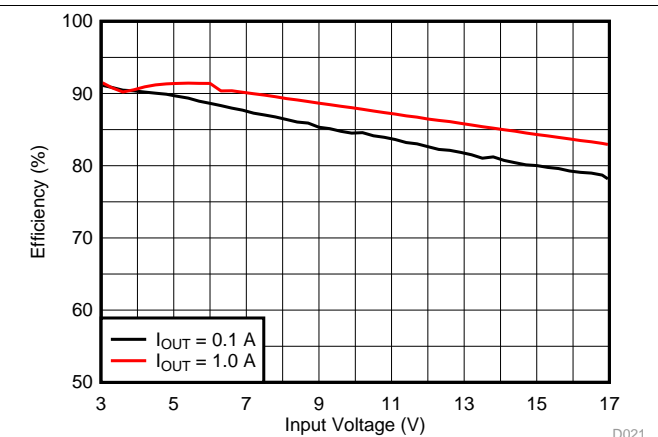

图 13. Efficiency, $V_{OUT} = 3.3\text{ V}$

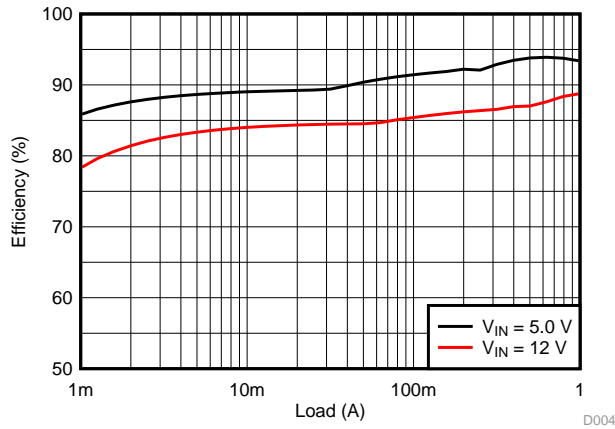

图 14. Efficiency, $V_{OUT} = 5.0\text{ V}$

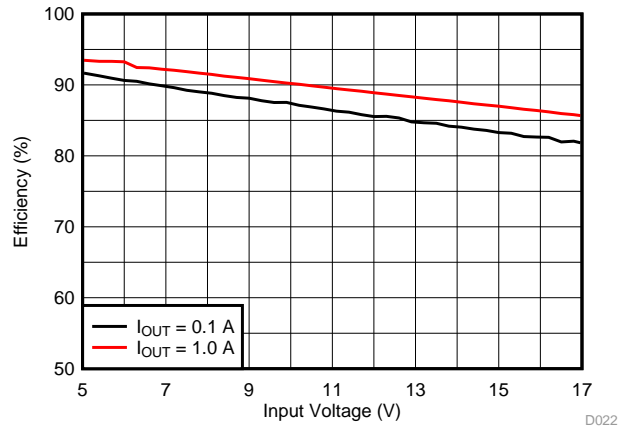

图 15. Efficiency, $V_{OUT} = 5.0\text{ V}$

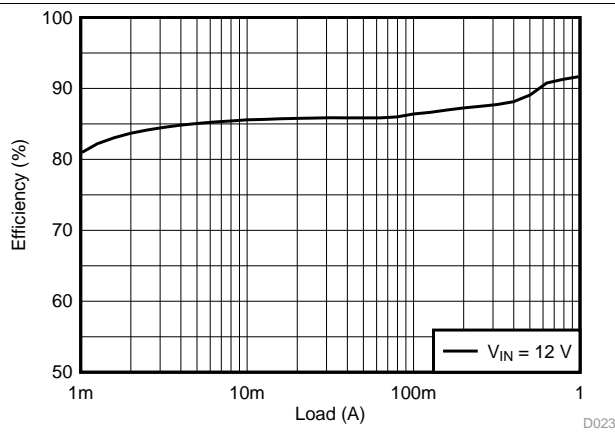

$\theta_{JA} = 46.1\text{ }^{\circ}\text{C/W}$

图 16. Thermal Derating, $V_{OUT} = 1\text{ V}$

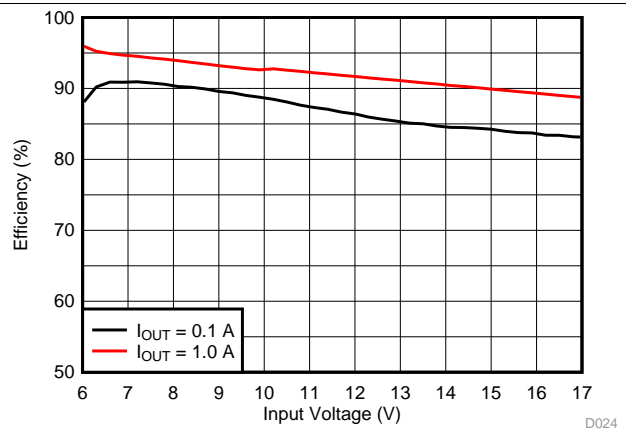
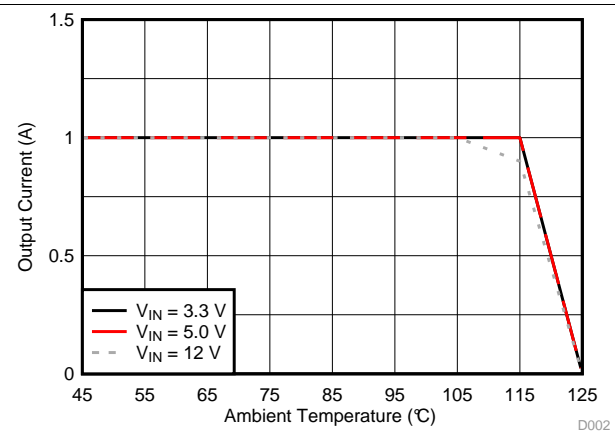
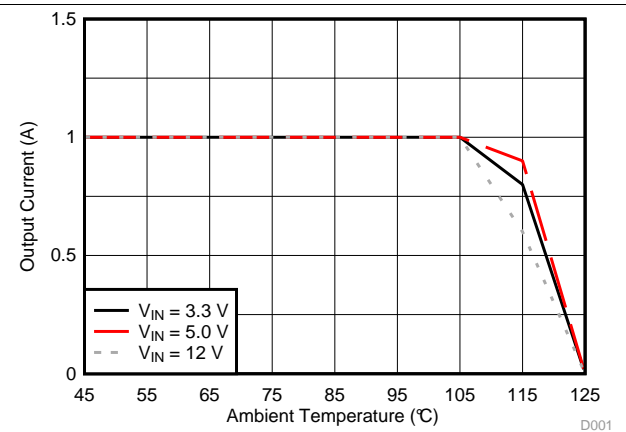

$\theta_{JA} = 46.1\text{ }^{\circ}\text{C/W}$

图 17. Thermal Derating, $V_{OUT} = 1.8\text{ V}$

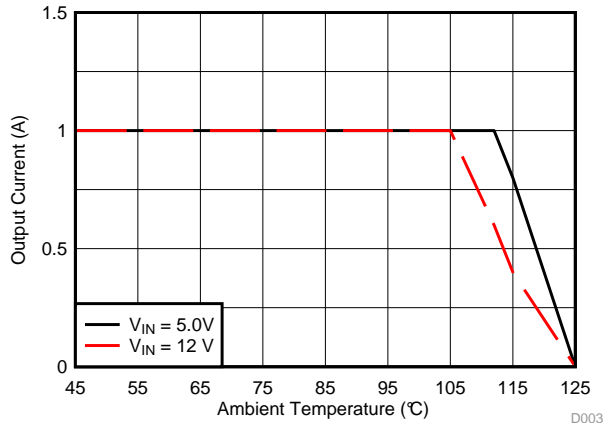

$\theta_{JA} = 46.1 \text{ } ^\circ\text{C/W}$

图 18. Thermal Derating, $V_{OUT} = 3.3 \text{ V}$

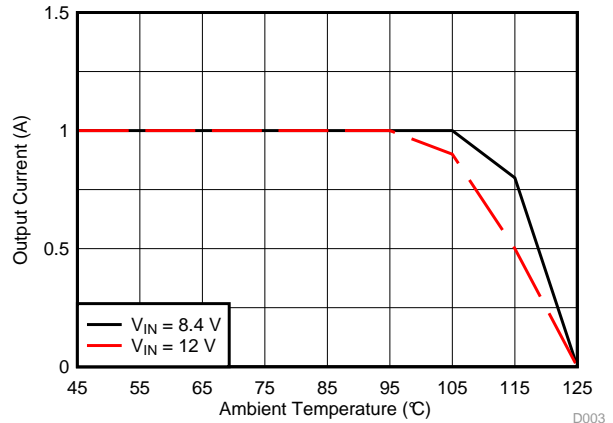

$\theta_{JA} = 46.1 \text{ } ^\circ\text{C/W}$

图 19. Thermal Derating, $V_{OUT} = 5 \text{ V}$



图 20. Load Regulation



$I_{OUT} = 1 \text{ A}$

图 21. Line Regulation

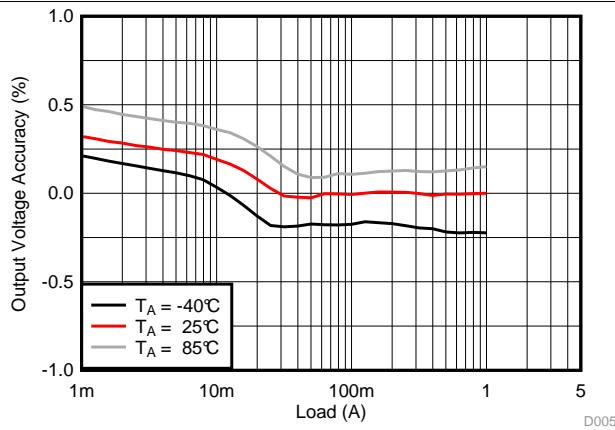
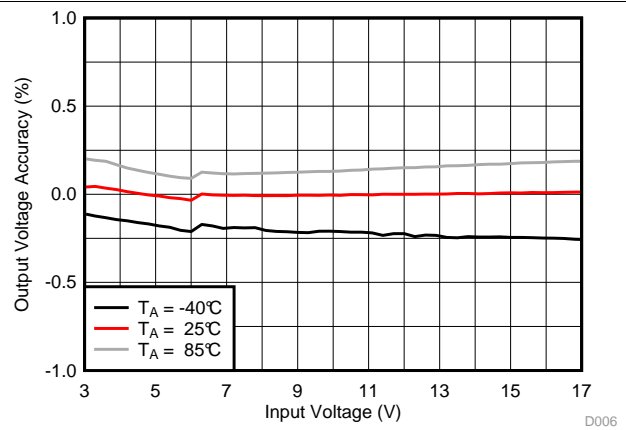
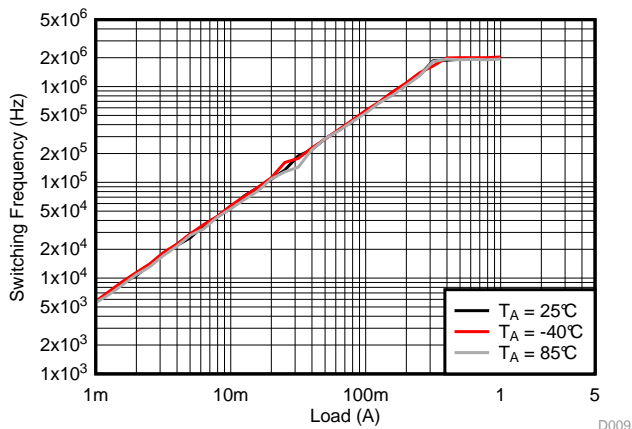

$V_{OUT} = 1.8 \text{ V}$

图 22. Switching Frequency

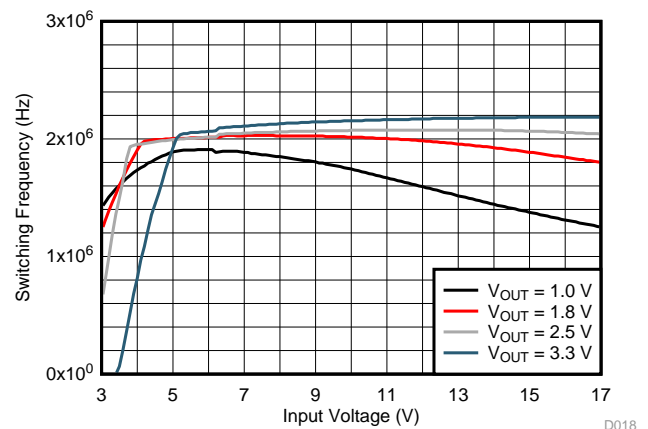

$I_{OUT} = 1 \text{ A}$

图 23. Switching Frequency



图 24. Input and Output Ripple in PWM Mode



图 25. Input and Output Ripple in PSM Mode

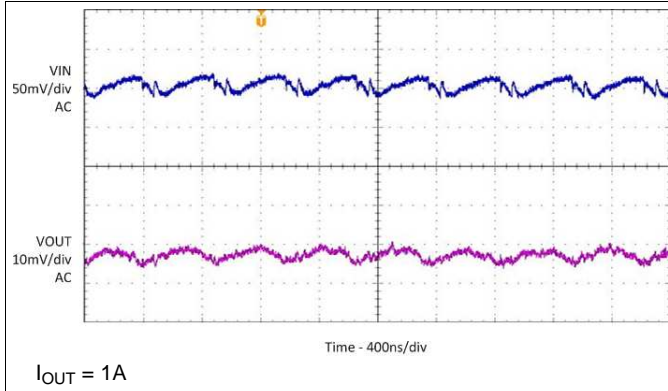

图 26. Load Transient

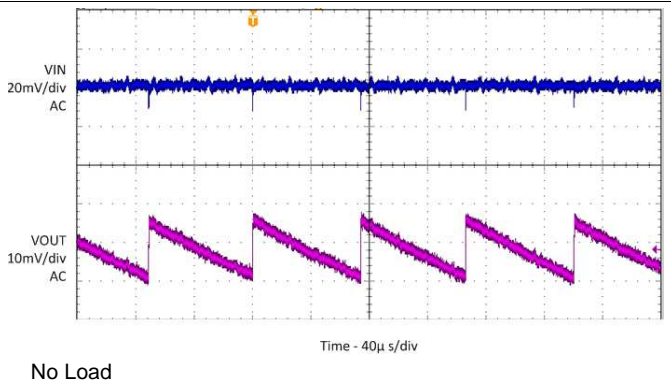

图 27. Load Transient

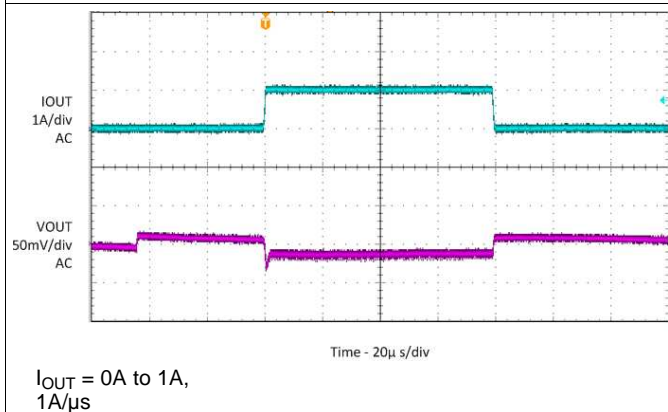

图 28. Startup without Load

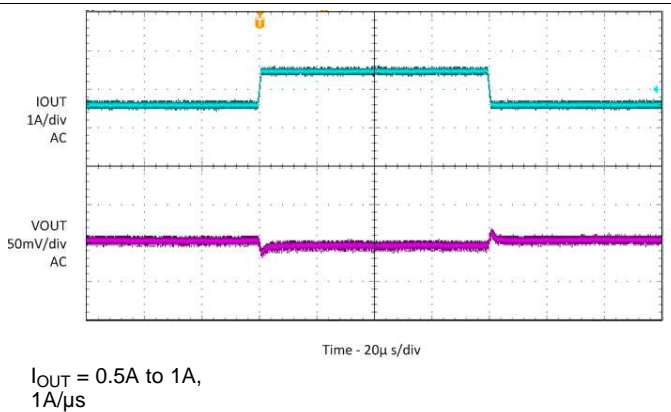

图 29. Startup / Shutdown with Resistance Load

8.3 System Examples

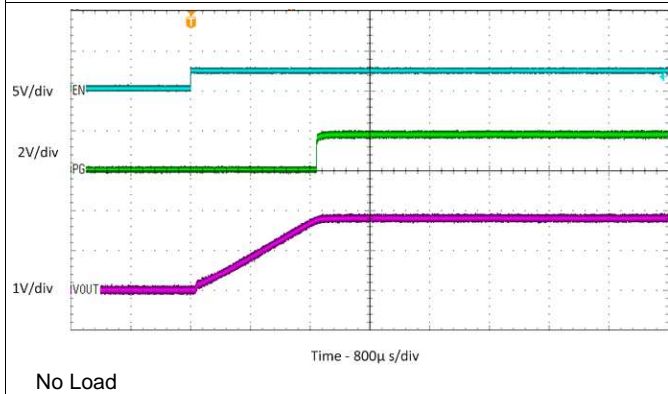
8.3.1 Inverting Power Supply

The TPS82150 can be used as inverting power supply by rearranging external circuitry as shown in 图 30. As the former GND node now represents a voltage level below system ground, the voltage difference between V_{IN} and V_{OUT} has to be limited for operation to the maximum supply voltage of 17V (see 公式 8).

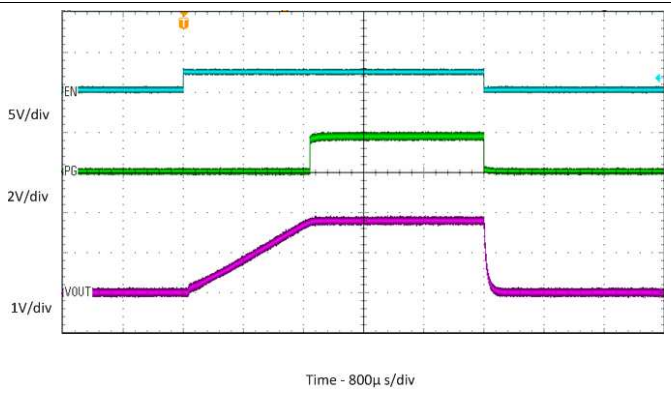
$$V_{IN} + |V_{OUT}| \leq V_{INmax} \quad (8)$$

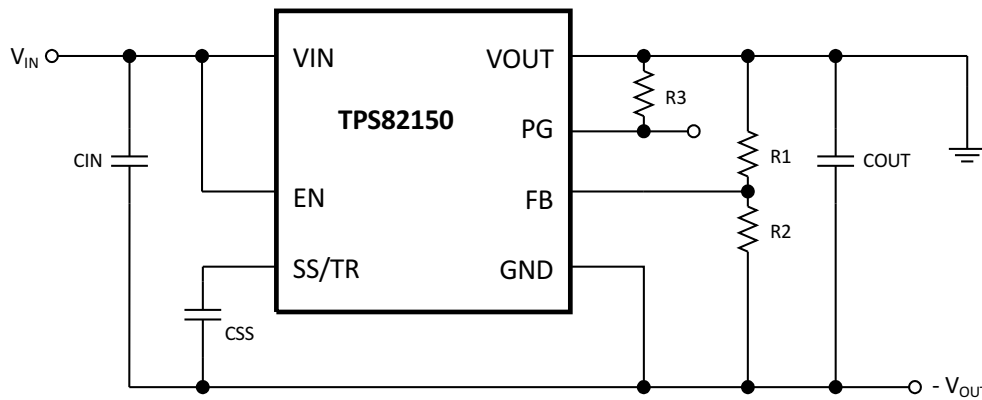

Copyright © 2017, Texas Instruments Incorporated

图 30. Inverting Power Supply Schematic

The transfer function of the inverting power supply configuration differs from the buck mode transfer function, incorporating a Right Half Plane Zero additionally. Therefore the loop stability has to be adapted. More detailed information is given in [TIDUCV2](#).

9 Power Supply Recommendations

The devices are designed to operate from an input voltage supply range between 3V and 17V. The average input current of the TPS82150 is calculated as:

$$I_{IN} = \frac{1}{\eta} \times \frac{V_{OUT} \times I_{OUT}}{V_{IN}} \quad (9)$$

Ensure that the power supply has a sufficient current rating for the applications.

10 Layout

10.1 Layout Guidelines

- TI recommends placing all components as close as possible to the IC. The input capacitor placement specifically, must be closest to the VIN and GND pins of the device.
- Use wide and short traces for the main current paths to reduce the parasitic inductance and resistance.
- To enhance heat dissipation of the device, the exposed thermal pad should be connected to bottom or internal layer ground planes using vias.
- Refer to [图 31](#) for an example of component placement, routing and thermal design.

10.2 Layout Example



图 31. TPS82150 PCB Layout

10.3 Thermal Consideration

The output current of the TPS82150 needs to be derated when the device operates in a high ambient temperature or delivers high output power. The amount of current derating is dependent upon the input voltage, output power, PCB layout design and environmental thermal condition. Care should especially be taken in applications where the localized PCB temperature exceeds 65°C.

The TPS82150 module temperature must be kept less than the maximum rating of 125°C. Three basic approaches for enhancing thermal performance are below:

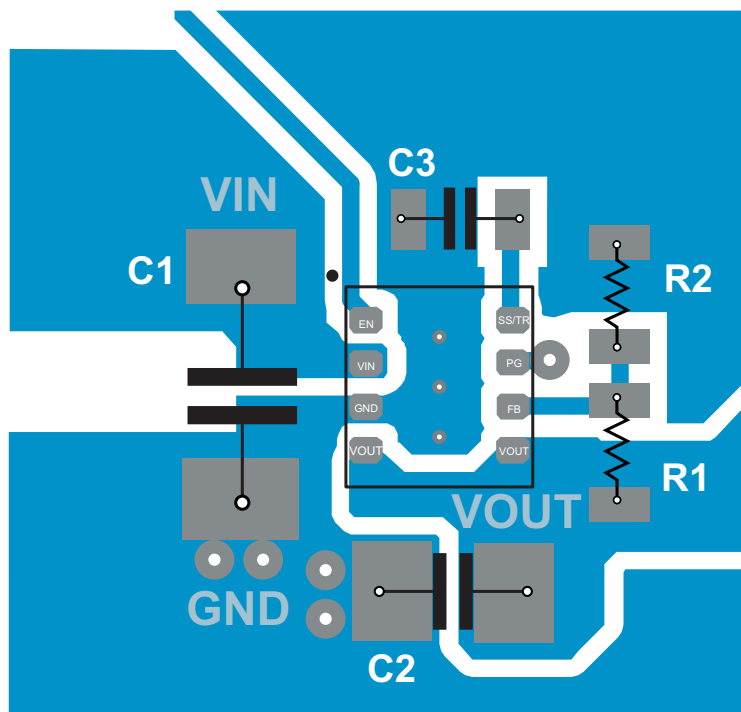
- Improve the power dissipation capability of the PCB design.
- Improve the thermal coupling of the TPS82150 to the PCB.
- Introduce airflow into the system.

To estimate approximate module temperature of TPS82150, apply the typical efficiency stated in this datasheet to the desired application condition to find the module's power dissipation. Then calculate the module temperature rise by multiplying the power dissipation by its thermal resistance. For more details on how to use the thermal parameters in real applications, see the application notes: [SZZA017](#) and [SPRA953](#).

11 器件和文档支持

11.1 器件支持

11.1.1 Third-Party Products Disclaimer

TI'S PUBLICATION OF INFORMATION REGARDING THIRD-PARTY PRODUCTS OR SERVICES DOES NOT CONSTITUTE AN ENDORSEMENT REGARDING THE SUITABILITY OF SUCH PRODUCTS OR SERVICES OR A WARRANTY, REPRESENTATION OR ENDORSEMENT OF SUCH PRODUCTS OR SERVICES, EITHER ALONE OR IN COMBINATION WITH ANY TI PRODUCT OR SERVICE.

11.1.2 开发支持

11.1.2.1 使用 **WEBENCH®** 工具定制设计方案

单击[此处](#)，使用 TPS82150 器件并借助 WEBENCH® 电源设计器创建定制设计方案。

1. 在开始阶段键入输入电压 (V_{IN})、输出电压 (V_{OUT}) 和输出电流 (I_{OUT}) 要求。
2. 使用优化器拨盘优化关键设计参数，如效率、封装和成本。
3. 将生成的设计与德州仪器 (TI) 的其他解决方案进行比较。

WEBENCH Power Designer 提供一份定制原理图以及罗列实时价格和组件可用性的物料清单。

在多数情况下，可执行以下操作：

- 运行电气仿真，观察重要波形以及电路性能
- 运行热性能仿真，了解电路板热性能
- 将定制原理图和布局方案导出至常用 CAD 格式
- 打印设计方案的 PDF 报告并与同事共享

有关 WEBENCH 工具的详细信息，请访问 www.ti.com/WEBENCH。

11.2 接收文档更新通知

要接收文档更新通知，请导航至 TI.com 上的器件产品文件夹。请单击右上角的 **通知我** 进行注册，即可收到任意产品信息更改每周摘要。有关更改的详细信息，请查看任意已修订文档中包含的修订历史记录。

11.3 社区资源

下列链接提供到 TI 社区资源的连接。链接的内容由各个分销商“按照原样”提供。这些内容并不构成 TI 技术规范，并且不一定反映 TI 的观点；请参阅 TI 的 [《使用条款》](#)。

TI E2E™ 在线社区 *TI 的工程师对工程师 (E2E) 社区*。此社区的创建目的在于促进工程师之间的协作。在 e2e.ti.com 中，您可以咨询问题、分享知识、拓展思路并与同行工程师一道帮助解决问题。

设计支持 *TI 参考设计支持* 可帮助您快速查找有帮助的 E2E 论坛、设计支持工具以及技术支持的联系信息。

11.4 商标

MicroSiP, DCS-Control, E2E are trademarks of Texas Instruments.
WEBENCH is a registered trademark of Texas Instruments.

11.5 静电放电警告



这些装置包含有限的内置 ESD 保护。存储或装卸时，应将导线一起截短或将装置放置于导电泡棉中，以防止 MOS 门极遭受静电损伤。

11.6 Glossary

SLYZ022 — *TI Glossary*.

This glossary lists and explains terms, acronyms, and definitions.

12 机械、封装和可订购信息

以下页面包括机械、封装和可订购信息。这些信息是指定器件的最新可用数据。这些数据发生变化时，我们可能不会另行通知或修订此文档。如欲获取此产品说明书的浏览器版本，请参见左侧的导航栏。

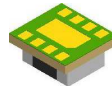

PACKAGE OUTLINE

SIL0008D

MicroSiP™ - 1.53 mm max height

MICRO SYSTEM IN PACKAGE

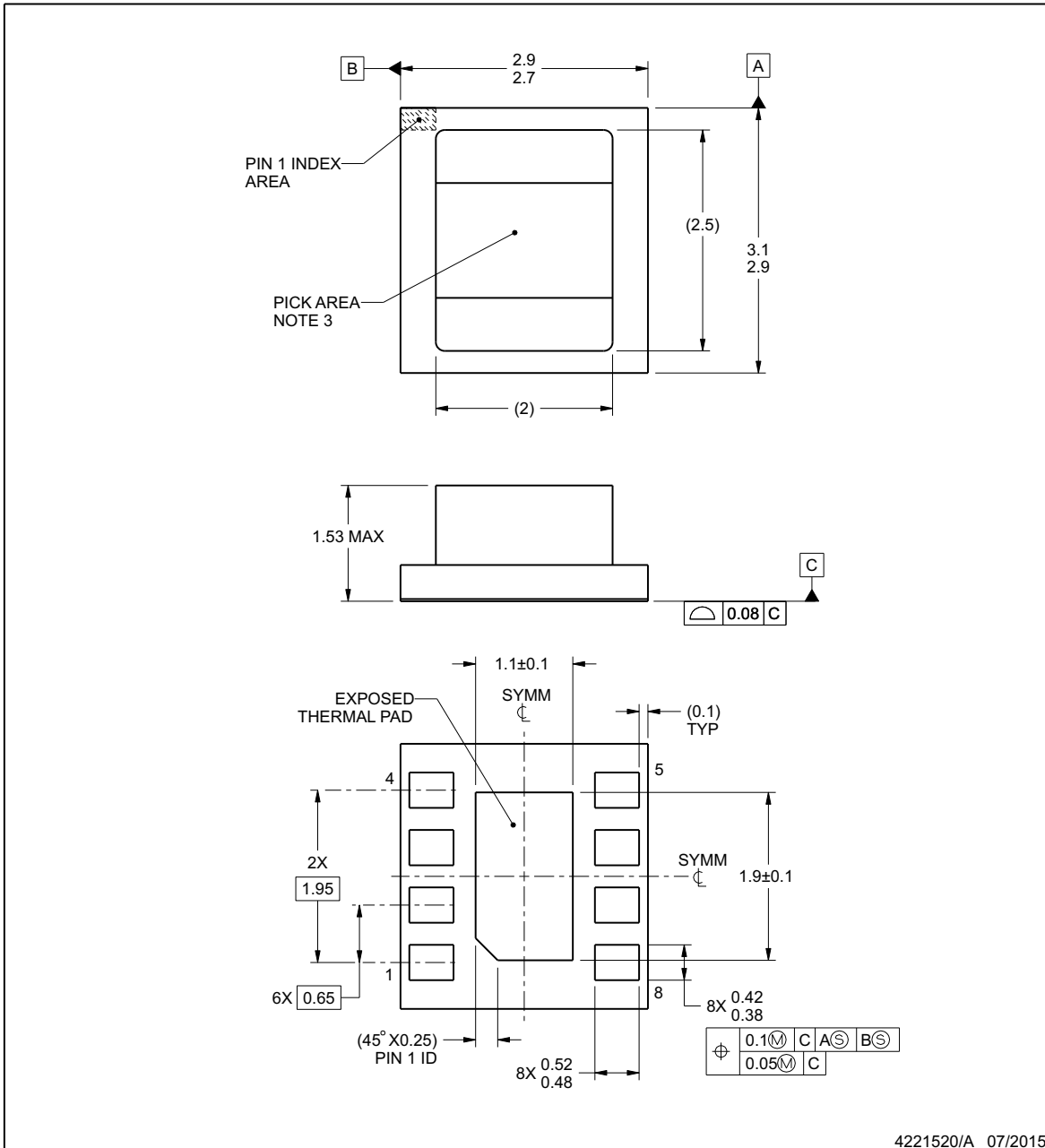

4221520/A 07/2015

MicroSiP is a trademark of Texas Instruments

NOTES:

1. All linear dimensions are in millimeters. Any dimensions in parenthesis are for reference only. Dimensioning and tolerancing per ASME Y14.5M.
2. This drawing is subject to change without notice.
3. Pick and place nozzle \varnothing 1.3 mm or smaller recommended.
4. The package thermal pad must be soldered to the printed circuit board for thermal and mechanical performance.

EXAMPLE BOARD LAYOUT

SIL0008D

MicroSiP™ - 1.53 mm max height

MICRO SYSTEM IN PACKAGE

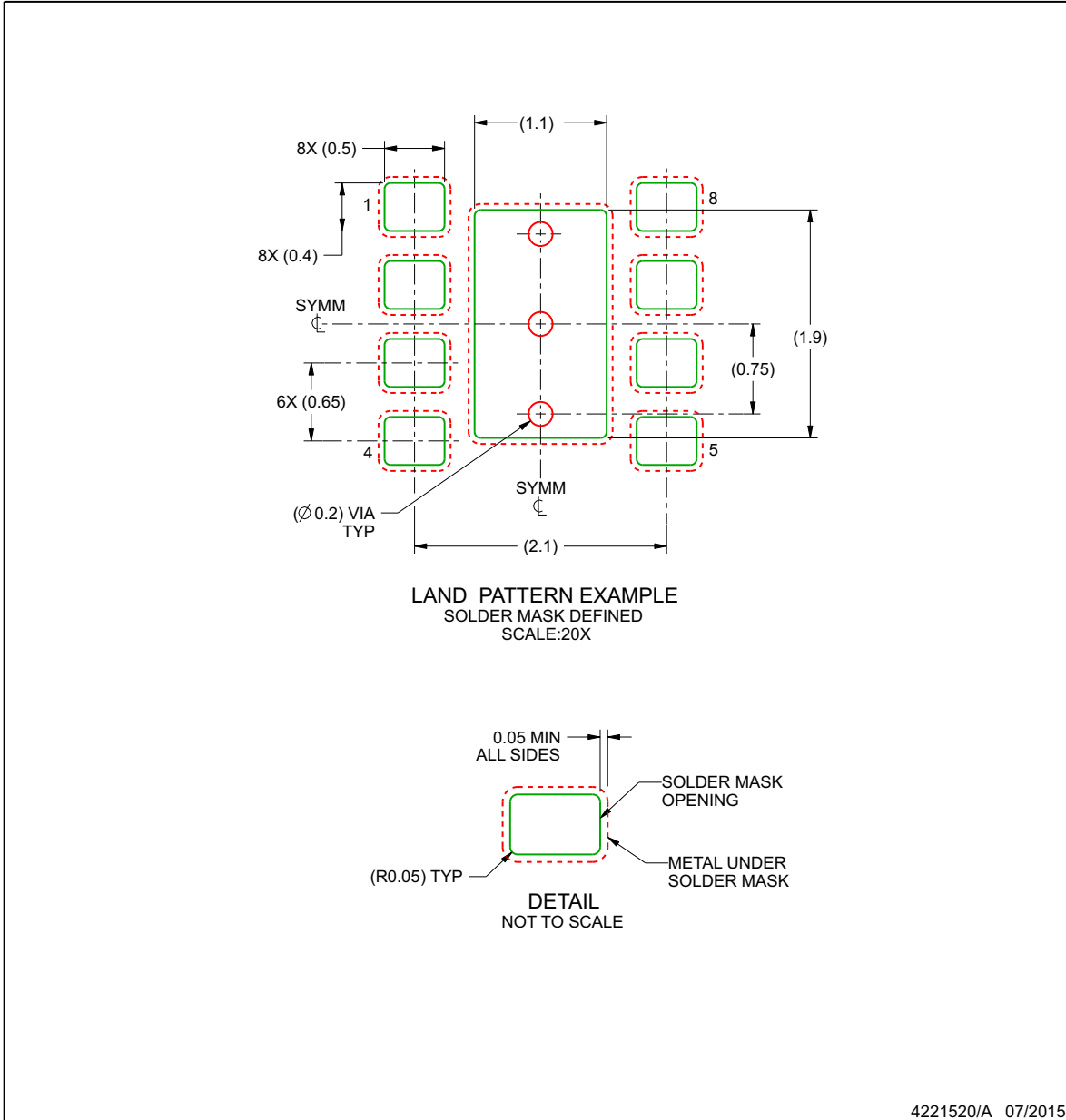

NOTES: (continued)

5. This package is designed to be soldered to a thermal pad on the board. For more information, see Texas Instruments literature number SLUA271 (www.ti.com/lit/sl原因271).

EXAMPLE STENCIL DESIGN

SIL0008D

MicroSiP™ - 1.53 mm max height

MICRO SYSTEM IN PACKAGE

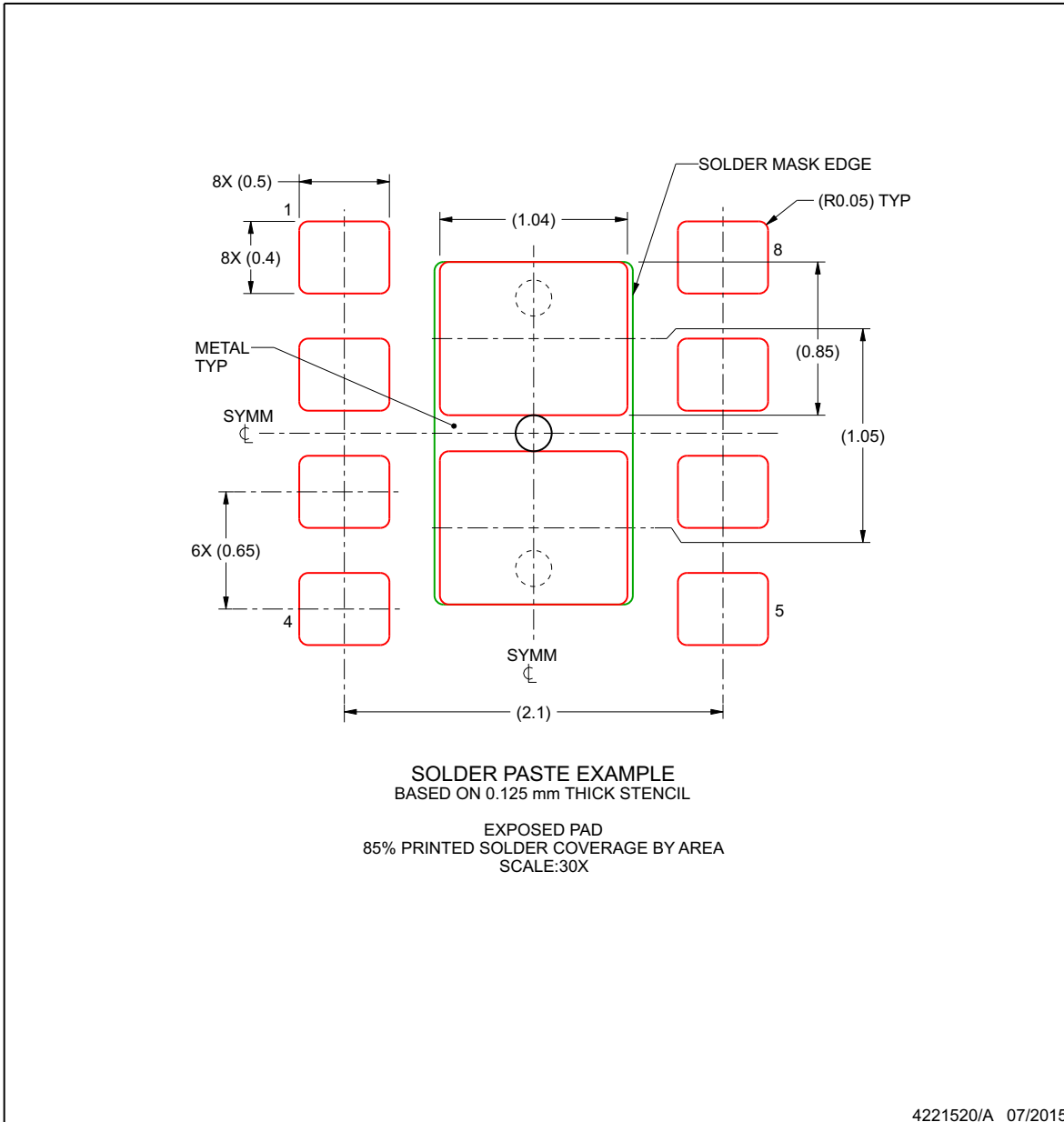

NOTES: (continued)

6. Laser cutting apertures with trapezoidal walls and rounded corners may offer better paste release. IPC-7525 may have alternate design recommendations.

PACKAGING INFORMATION

| Orderable Device | Status (1) | Package Type | Package Drawing | Pins | Package Qty | Eco Plan (2) | Lead finish/ Ball material (6) | MSL Peak Temp (3) | Op Temp (°C) | Device Marking (4/5) | Samples |
|------------------|---------------|--------------|-----------------|------|-------------|-----------------|--------------------------------------|----------------------|--------------|-------------------------|-------------------------|
| TPS82150SILR | ACTIVE | uSiP | SIL | 8 | 3000 | RoHS & Green | NIAU | Level-2-260C-1 YEAR | -40 to 125 | 5S | Samples |
| TPS82150SILT | ACTIVE | uSiP | SIL | 8 | 250 | RoHS & Green | NIAU | Level-2-260C-1 YEAR | -40 to 125 | 5S | Samples |

(1) The marketing status values are defined as follows:

ACTIVE: Product device recommended for new designs.

LIFEBUY: TI has announced that the device will be discontinued, and a lifetime-buy period is in effect.

NRND: Not recommended for new designs. Device is in production to support existing customers, but TI does not recommend using this part in a new design.

PREVIEW: Device has been announced but is not in production. Samples may or may not be available.

OBSOLETE: TI has discontinued the production of the device.

(2) **RoHS:** TI defines "RoHS" to mean semiconductor products that are compliant with the current EU RoHS requirements for all 10 RoHS substances, including the requirement that RoHS substance do not exceed 0.1% by weight in homogeneous materials. Where designed to be soldered at high temperatures, "RoHS" products are suitable for use in specified lead-free processes. TI may reference these types of products as "Pb-Free".

RoHS Exempt: TI defines "RoHS Exempt" to mean products that contain lead but are compliant with EU RoHS pursuant to a specific EU RoHS exemption.

Green: TI defines "Green" to mean the content of Chlorine (Cl) and Bromine (Br) based flame retardants meet JS709B low halogen requirements of <=1000ppm threshold. Antimony trioxide based flame retardants must also meet the <=1000ppm threshold requirement.

(3) MSL, Peak Temp. - The Moisture Sensitivity Level rating according to the JEDEC industry standard classifications, and peak solder temperature.

(4) There may be additional marking, which relates to the logo, the lot trace code information, or the environmental category on the device.

(5) Multiple Device Markings will be inside parentheses. Only one Device Marking contained in parentheses and separated by a "~" will appear on a device. If a line is indented then it is a continuation of the previous line and the two combined represent the entire Device Marking for that device.

(6) Lead finish/Ball material - Orderable Devices may have multiple material finish options. Finish options are separated by a vertical ruled line. Lead finish/Ball material values may wrap to two lines if the finish value exceeds the maximum column width.

Important Information and Disclaimer:The information provided on this page represents TI's knowledge and belief as of the date that it is provided. TI bases its knowledge and belief on information provided by third parties, and makes no representation or warranty as to the accuracy of such information. Efforts are underway to better integrate information from third parties. TI has taken and continues to take reasonable steps to provide representative and accurate information but may not have conducted destructive testing or chemical analysis on incoming materials and chemicals. TI and TI suppliers consider certain information to be proprietary, and thus CAS numbers and other limited information may not be available for release.

In no event shall TI's liability arising out of such information exceed the total purchase price of the TI part(s) at issue in this document sold by TI to Customer on an annual basis.

重要声明和免责声明

TI 提供技术和可靠性数据（包括数据表）、设计资源（包括参考设计）、应用或其他设计建议、网络工具、安全信息和其他资源，不保证没有瑕疵且不做任何明示或暗示的担保，包括但不限于对适销性、某特定用途方面的适用性或不侵犯任何第三方知识产权的暗示担保。

这些资源可供使用 TI 产品进行设计的熟练开发人员使用。您将自行承担以下全部责任：(1) 针对您的应用选择合适的 TI 产品，(2) 设计、验证并测试您的应用，(3) 确保您的应用满足相应标准以及任何其他安全、安保或其他要求。这些资源如有变更，恕不另行通知。TI 授权您仅可将这些资源用于研发本资源所述的 TI 产品的应用。严禁对这些资源进行其他复制或展示。您无权使用任何其他 TI 知识产权或任何第三方知识产权。您应全额赔偿因在这些资源的使用中对 TI 及其代表造成的任何索赔、损害、成本、损失和债务，TI 对此概不负责。

TI 提供的产品受 TI 的销售条款 (<https://www.ti.com.cn/zh-cn/legal/termsofsale.html>) 或 [ti.com.cn](https://www.ti.com.cn) 上其他适用条款/TI 产品随附的其他适用条款的约束。TI 提供这些资源并不会扩展或以其他方式更改 TI 针对 TI 产品发布的适用的担保或担保免责声明。

邮寄地址：上海市浦东新区世纪大道 1568 号中建大厦 32 楼，邮政编码：200122

Copyright © 2021 德州仪器半导体技术（上海）有限公司