

## TRF37x32 具有集成 IF 放大器的双通道下变频混频器

### 1 特性

- 此器件系列支持宽射频输入范围
  - TRF37A32: 400 - 1700MHz
  - TRF37B32: 700 - 2700MHz
  - TRF37C32: 1700 - 3800MHz
- 增益: 10dB
- 噪声系数: 9.5dB
- 输入 IP3: 30dBm
- 每通道 500mW 功耗
- 单端射频输入
- 中频频率范围为 30MHz 至 600MHz
- 通道间 45dB 隔离
- 低功耗模式选项
- 独立的断电控制
- 3.3V 单电源
- 无需外部匹配组件

### 2 应用

- 无线基础设施
  - WCDMA, TD-SCDMA
  - LTE, TD-LTE
  - 多载波 GSM (MC-GSM)
- 点对点微波回程
- 软件定义无线电 (SDR)
- 雷达接收器
- 卫星通信

### 4 简化电路原理图

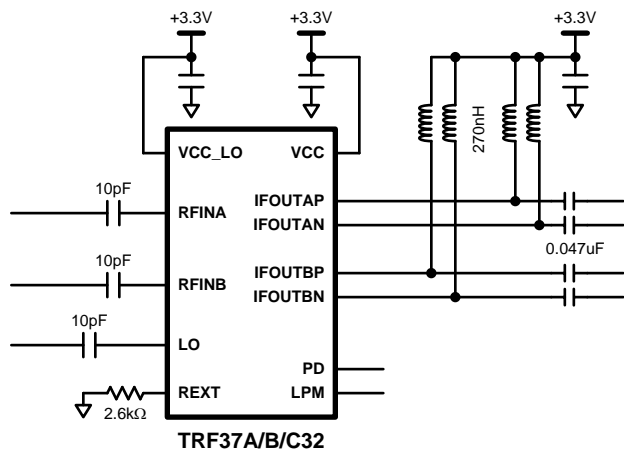

### 3 说明

TRF37x32 是具有集成中频放大器的宽带双通道下变频混频器。该器件采用集成式平衡-非平衡变压器进行单端射频和 LO 输入。中频放大器在集电极开路拓扑结构中的工作频率为 30MHz 至 600MHz，支持多种中频频率和带宽。TRF37x32 提供出色的混频器线性度和噪声性能，并在通道间提供良好的隔离，以便用于多种应用。该器件具有低功耗特性，此外还为功率敏感型应用提供了低功耗模式选项。各个通道均可单独降频并快速响应，因而非常适用于时域双工 (TDD) 应用。

器件信息<sup>(1)</sup>

器件型号	封装	封装尺寸 (标称值)
TRF37A32	WQFN (32)	5.00mm x 5.00mm
TRF37B32		
TRF37C32		

(1) 要了解所有可用封装，请见数据表末尾的可订购产品附录。

频率间的 IIP3 性能

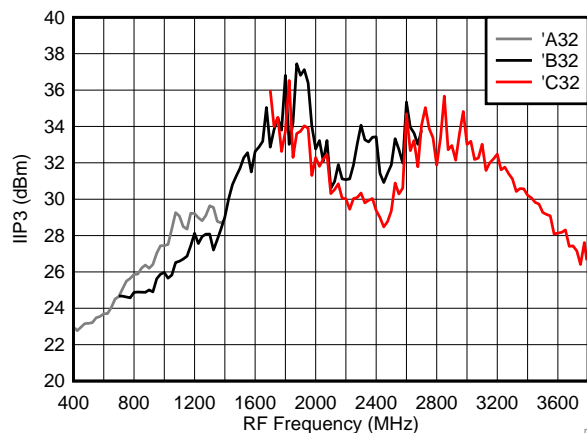

## 目录

<b>1</b>	特性 .....	<b>1</b>	8.1	Overview .....	<b>22</b>
<b>2</b>	应用 .....	<b>1</b>	8.2	Functional Block Diagram .....	<b>22</b>
<b>3</b>	说明 .....	<b>1</b>	8.3	Feature Description .....	<b>23</b>
<b>4</b>	简化电路原理图 .....	<b>1</b>	8.4	Device Functional Modes .....	<b>24</b>
<b>5</b>	修订历史记录 .....	<b>2</b>	<b>9</b>	<b>Applications and Implementation</b> .....	<b>25</b>
<b>6</b>	<b>Pin Configuration and Functions</b> .....	<b>3</b>	9.1	Application Information .....	<b>25</b>
<b>7</b>	<b>Specifications</b> .....	<b>5</b>	9.2	Typical Application .....	<b>25</b>
7.1	Absolute Maximum Ratings .....	<b>5</b>	<b>10</b>	<b>Power Supply Recommendations</b> .....	<b>27</b>
7.2	ESD Ratings .....	<b>5</b>	10.1	Power Up Sequence .....	<b>27</b>
7.3	Recommended Operating Conditions .....	<b>5</b>	<b>11</b>	<b>Layout</b> .....	<b>28</b>
7.4	Thermal Information .....	<b>5</b>	11.1	Layout Guidelines .....	<b>28</b>
7.5	Electrical Characteristics, TRF37A32 .....	<b>6</b>	11.2	Layout Example .....	<b>28</b>
7.6	Electrical Characteristics, TRF37B32 .....	<b>7</b>	<b>12</b>	<b>器件和文档支持</b> .....	<b>29</b>
7.7	Electrical Characteristics, TRF37C32 .....	<b>8</b>	12.1	相关链接 .....	<b>29</b>
7.8	Timing Requirements .....	<b>9</b>	12.2	商标 .....	<b>29</b>
7.9	Typical Characteristics (TRF37A32) .....	<b>10</b>	12.3	静电放电警告 .....	<b>29</b>
7.10	Typical Characteristics (TRF37B32) .....	<b>14</b>	12.4	术语表 .....	<b>29</b>
7.11	Typical Characteristics (TRF37C32) .....	<b>18</b>	<b>13</b>	<b>机械、封装和可订购信息</b> .....	<b>29</b>
<b>8</b>	<b>Detailed Description</b> .....	<b>22</b>			

## 5 修订历史记录

### Changes from Original (May 2014) to Revision A

**Page**

- 添加了典型特征，特性描述部分，器件功能模式，应用和实施部分，电源相关建议部分和布局部分 ..... **1**
- Replaced the *Handling Ratings* table with the *ESD Ratings* table ..... **5**

## 6 Pin Configuration and Functions

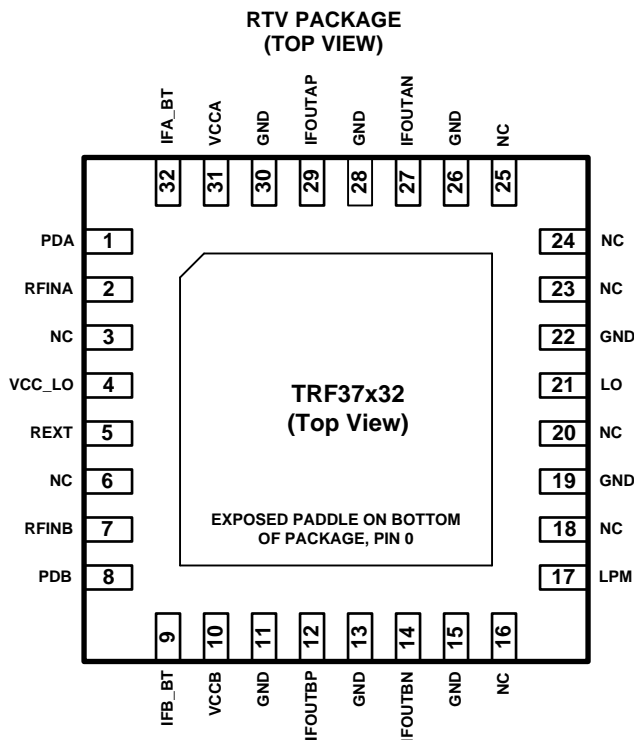

### Pin Functions

PIN		I/O	DESCRIPTION
NAME	NO.		
PDA	1	Digital Input	Power down for channel A (1 = PD; 0 or open = powered)
RFINA	2	Analog Input	RF input for channel A
NC	3	N/A	No connect
VCC_LO	4	Supply	V <sub>CC</sub> supply for the LO circuitry
REXT	5	Bias	External bias resistor
NC	6	N/A	No connect
RFINB	7	Analog Input	RF input for channel B
PDB	8	Digital Input	Power down for channel B (1 = PD; 0 or open = powered)
IFB_BT	9	N/A	IF channel B bias control; leave unconnected
VCCB	10	Supply	Power supply for channel B
GND	11	Ground	Ground
IFOUTBP	12	Analog Output	IF out channel B: positive
GND	13	Ground	Ground
IFOUTBN	14	Analog Output	IF out channel B: negative
GND	15	Ground	Ground
NC	16	N/A	No connect
LPM	17	Digital Input	Low power mode (0 = normal; 1 = low power)
NC	18	N/A	No connect
GND	19	Ground	Ground
NC	20	N/A	No connect
LO	21	Analog Input	Local oscillator (LO) input

**Pin Functions (continued)**

PIN		I/O	DESCRIPTION
NAME	NO.		
GND	22	Ground	Ground
NC	23	N/A	No connect
NC	24	N/A	No connect
NC	25	N/A	No connect
GND	26	Ground	Ground
IFOUTAN	27	Analog Output	IF out channel A: negative
GND	28	Ground	Ground
IFOUTAP	29	Analog Output	IF out channel A: positive
GND	30	Ground	Ground
VCCA	31	Supply	Power supply for channel A
IFA_BT	32	N/A	IF channel A bias control; leave unconnected

## 7 Specifications

### 7.1 Absolute Maximum Ratings

over operating free-air temperature range (unless otherwise noted) <sup>(1)</sup>

	MIN	MAX	UNIT
Input voltage	-0.3	3.6	V
Storage temperature, T <sub>STG</sub>	-40	150	°C

(1) Stresses beyond those listed under *Absolute Maximum Ratings* may cause permanent damage to the device. These are stress ratings only, which do not imply functional operation of the device at these or any other conditions beyond those indicated under *Recommended Operating Conditions*. Exposure to absolute-maximum-rated conditions for extended periods may affect device reliability.

### 7.2 ESD Ratings

			VALUE	UNIT
V <sub>(ESD)</sub> Electrostatic discharge	Human-body model (HBM), per ANSI/ESDA/JEDEC JS-001 <sup>(1)</sup>	All pins except XIFOUTAP, IFOUTAN, IFOUTBP, and IFOUTBN	±2500	V
		Pins XIFOUTAP, IFOUTAN, IFOUTBP, and IFOUTBN <sup>(2)</sup>	±100	
	Charged-device model (CDM), per JEDEC specification JESD22-C101 <sup>(3)</sup>	±1000		

(1) JEDEC document JEP155 states that 500-V HBM allows safe manufacturing with a standard ESD control process.

(2) High Linearity IFOUT pins are susceptible to low voltage HBM damage.

(3) JEDEC document JEP157 states that 250-V CDM allows safe manufacturing with a standard ESD control process.

### 7.3 Recommended Operating Conditions

over operating free-air temperature range (unless otherwise noted)

	MIN	NOM	MAX	UNIT
Operating virtual junction temperature range, T <sub>J</sub>	-40		125	°C

### 7.4 Thermal Information

THERMAL METRIC <sup>(1)</sup>		RTV	UNIT
		32 PINS	
R <sub>θJA</sub>	Junction-to-ambient thermal resistance	32.3	°C/W
R <sub>θJctop</sub>	Junction-to-case (top) thermal resistance	19.8	
R <sub>θJB</sub>	Junction-to-board thermal resistance	5.9	
Ψ <sub>JT</sub>	Junction-to-top characterization parameter	0.2	
Ψ <sub>JB</sub>	Junction-to-board characterization parameter	5.9	
R <sub>θJcbot</sub>	Junction-to-case (bottom) thermal resistance	1.3	

(1) For more information about traditional and new thermal metrics, see the *IC Package Thermal Metrics* application report, [SPRA953](#).

## 7.5 Electrical Characteristics, TRF37A32

 $T_A = 25^\circ\text{C}$ ,  $V_{CC} = 3.3\text{ V}$ ;  $P_{RF} = -10\text{ dBm}$ ;  $P_{LO} = 0\text{ dBm}$ ;  $F_{IF} = 200\text{ MHz}$ ; Low Side Injection,  $LPM = 0$  (unless otherwise noted)

PARAMETER		TEST CONDITIONS	MIN	TYP	MAX	UNIT
<b>DC Parameters</b>						
$V_{CC}$	Supply Voltage		3.15	3.3	3.45	V
$I_{CC}$	Supply Current	$F_{LO} = 750\text{ MHz}$		280		mA
$P_{diss}$	Total Power Dissipation	$F_{LO} = 750\text{ MHz}$		0.92		W
	Power Down Current				2	mA
<b>RF Frequency Range</b>						
$F_{RF}$	Frequency Range		400		1700	MHz
<b>RF Specifications</b>						
G	Gain	$F_{RF} = 950\text{ MHz (LSI)}$		9.6		dB
$G_{var}$	Gain Variation over Frequency	within any 200 MHz Band		0.5		dB
NF	SSB Noise Figure	$F_{RF} = 950\text{ MHz (LSI)}$		9.6		dB
	SSB Noise Figure with Blocker	5 dBm blocker signal $\Delta f > 50\text{ MHz}$		17		dB
IIP3	Input 3rd Order Intercept Point	$F_{RF} = 950\text{ MHz (LSI)}$ , $F_{spacing} = 20\text{ MHz}$		26		dBm
OIP3	Output 3rd Order Intercept Point	$F_{RF} = 950\text{ MHz (LSI)}$ , $F_{spacing} = 20\text{ MHz}$		35.6		dBm
OIP2	Output 2nd Order Intercept Point	$F_{RF} = 950\text{ MHz (LSI)}$		65		dBm
IP1dB	Input 1 dB Compression Point	$F_{RF} = 950\text{ MHz (LSI)}$		11		dBm
$Z_{IN}$	Input Impedance			50		$\Omega$
RLi	Input Return Loss	$F_{RF} = 800 - 1400\text{ MHz (LSI)}$		15		dB
<b>LO Input</b>						
$P_{LO}$	LO Drive Level		-3	0	6	dBm
$F_{LO}$	LO Frequency Range		600		1400	MHz
$Z_{IN}$	Input Impedance			50		$\Omega$
RLi	Input Return Loss	$F_{RF} = 750 - 1150\text{ MHz}$		15		dB
<b>Low Power Mode: LPM = 1</b>						
$I_{CC}$	Supply Current	$F_{LO} = 750\text{ MHz}$		200		mA
$P_{diss}$	Total Power Dissipation	$F_{LO} = 750\text{ MHz}$		0.66		W
G	Gain	$F_{RF} = 950\text{ MHz (LSI)}$		9.2		dB
NF	SSB Noise Figure	$F_{RF} = 950\text{ MHz (LSI)}$		9.6		dB
IIP3	Input 3rd Order Intercept Point	$F_{RF} = 950\text{ MHz (LSI)}$ , $F_{spacing} = 20\text{ MHz}$		26		dBm
IP1dB	Input 1 dB Compression Point	$F_{RF} = 950\text{ MHz (LSI)}$		11		dBm
<b>Isolation</b>						
	Channel Isolation	Drive RFinA/B IFoutA/B-IFoutB/A $F_{RF} = 950\text{ MHz}$		50		dB
	RF to IF Isolation	$F_{RF} = 950\text{ MHz}$		20		dB
	LO to RF Leakage	$P_{LO} = 0\text{ dBm}$		-55		dBm
	LO to IF Leakage	$P_{LO} = 0\text{ dBm}$		-45		dBm
<b>Spurious</b>						
	2x2 Spurious Product	2RF - 2LO		65		dBc
	3x3 Spurious Product	3RF - 3LO		70		dBc
<b>IF Output</b>						
$Z_L$	Differential Output Impedance Load			200		$\Omega$
$F_{IF}$	Frequency Range	1 dB corner frequency	30		600	MHz
	DC Bias Range	Externally supplied DC bias through RF choke		3.3		V

## 7.6 Electrical Characteristics, TRF37B32

 $T_A = 25^\circ\text{C}$ ,  $V_{CC} = 3.3\text{ V}$ ;  $P_{RF} = -10\text{ dBm}$ ;  $P_{LO} = 0\text{ dBm}$ ;  $F_{IF} = 200\text{ MHz}$ ; Low Side Injection,  $LPM = 0$  (unless otherwise noted)

PARAMETER		TEST CONDITIONS	MIN	TYP	MAX	UNIT
<b>DC Parameters</b>						
$V_{CC}$	Supply Voltage		3.15	3.3	3.45	V
$I_{CC}$	Supply Current	$F_{LO} = 1750\text{ MHz}$		305		mA
$P_{diss}$	Total Power Dissipation	$F_{LO} = 1750\text{ MHz}$		1		W
	Power Down Current				2	mA
<b>RF Frequency Range</b>						
$F_{RF}$	Frequency Range		700		2700	MHz
<b>RF Specifications</b>						
G	Gain	$F_{RF} = 1950\text{ MHz (LSI)}$		10		dB
$G_{var}$	Gain Variation over Frequency	within any 200 MHz Band		0.5		dB
NF	SSB Noise Figure	$F_{RF} = 1950\text{ MHz (LSI)}$		9.2		dB
	SSB Noise Figure with Blocker	5 dBm blocker signal $\Delta f > 50\text{ MHz}$		15.5		dB
IIP3	Input 3rd Order Intercept Point	$F_{RF} = 1950\text{ MHz (LSI)}$ , $F_{spacing} = 20\text{ MHz}$		32		dBm
OIP3	Output 3rd Order Intercept Point	$F_{RF} = 1950\text{ MHz (LSI)}$ , $F_{spacing} = 20\text{ MHz}$		42		dBm
OIP2	Output 2nd Order Intercept Point	$F_{RF} = 1950\text{ MHz (LSI)}$		70		dBm
IP1dB	Input 1 dB Compression Point	$F_{RF} = 1950\text{ MHz (LSI)}$		10.8		dBm
$Z_{IN}$	Input Impedance			50		$\Omega$
RLi	Input Return Loss	$F_{RF} = 1700 - 2700\text{ MHz (LSI)}$		10		dB
<b>LO Input</b>						
$P_{LO}$	LO Drive Level		-3	0	6	dBm
$F_{LO}$	LO Frequency Range		500		2900	MHz
$Z_{IN}$	Input Impedance			50		$\Omega$
RLi	Input Return Loss	$F_{RF} = 1500 - 2450\text{ MHz}$		15		dB
<b>Low Power Mode: LPM = 1</b>						
$I_{CC}$	Supply Current	$F_{LO} = 1750\text{ MHz}$		220		mA
$P_{diss}$	Total Power Dissipation	$F_{LO} = 1750\text{ MHz}$		0.73		W
G	Gain	$F_{RF} = 1950\text{ MHz (LSI)}$		9.2		dB
NF	SSB Noise Figure	$F_{RF} = 1950\text{ MHz (LSI)}$		9.2		dB
IIP3	Input 3rd Order Intercept Point	$F_{RF} = 1950\text{ MHz (LSI)}$ , $F_{spacing} = 20\text{ MHz}$		23		dBm
IP1dB	Input 1 dB Compression Point	$F_{RF} = 1950\text{ MHz (LSI)}$		10.7		dBm
<b>Isolation</b>						
	Channel Isolation	Drive RFinA/B IFoutA/B-IFoutB/A $F_{RF} = 1950\text{ MHz}$		45		dB
	RF to IF Isolation	$F_{RF} = 1950\text{ MHz}$		22		dB
	LO to RF Leakage	$P_{LO} = 0\text{ dBm}$		-50		dBm
	LO to IF Leakage	$P_{LO} = 0\text{ dBm}$		-42		dBm
<b>Spurious</b>						
	2x2 Spurious Product	2RF - 2LO		70		dBc
	3x3 Spurious Product	3RF - 3LO		75		dBc
<b>IF Output</b>						
$Z_L$	Differential Output Impedance Load			200		$\Omega$
$F_{IF}$	Frequency Range	1 dB corner frequency	30		600	MHz
	DC Bias Range	Externally supplied DC bias through RF choke		3.3		V

## 7.7 Electrical Characteristics, TRF37C32

 $T_A = 25^\circ\text{C}$ ,  $V_{CC} = 3.3\text{ V}$ ;  $P_{RF} = -10\text{ dBm}$ ;  $P_{LO} = 0\text{ dBm}$ ;  $F_{IF} = 200\text{ MHz}$ ; Low Side Injection,  $LPM = 0$  (unless otherwise noted)

PARAMETER		TEST CONDITIONS	MIN	TYP	MAX	UNIT
<b>DC Parameters</b>						
$V_{CC}$	Supply Voltage		3.15	3.3	3.45	V
$I_{CC}$	Supply Current	$F_{LO} = 2300\text{ MHz}$		325		mA
$P_{diss}$	Total Power Dissipation	$F_{LO} = 2300\text{ MHz}$		1.1		W
	Power Down Current				2	mA
<b>RF Frequency Range</b>						
$F_{RF}$	Frequency Range		1700		3800	MHz
<b>RF Specifications</b>						
G	Gain	$F_{RF} = 2500\text{ MHz (LSI)}$		9.8		dB
$G_{var}$	Gain Variation over Frequency	within any 200 MHz Band		0.5		dB
NF	SSB Noise Figure	$F_{RF} = 2500\text{ MHz (LSI)}$		9.9		dB
	SSB Noise Figure with Blocker	5 dBm blocker signal $\Delta f > 50\text{ MHz}$		17.5		dB
IIP3	Input 3rd Order Intercept Point	$F_{RF} = 2500\text{ MHz (LSI)}$ $F_{spacing} = 20\text{ MHz}$		29		dBm
OIP3	Output 3rd Order Intercept Point	$F_{RF} = 2500\text{ MHz (LSI)}$ $F_{spacing} = 20\text{ MHz}$		38.8		dBm
OIP2	Output 2nd Order Intercept Point	$F_{RF} = 2500\text{ MHz (LSI)}$		65		dBm
IP1dB	Input 1 dB Compression Point	$F_{RF} = 2500\text{ MHz (LSI)}$		11.5		dBm
$Z_{IN}$	Input Impedance			50		$\Omega$
RLi	Input Return Loss			8		dB
<b>LO Input</b>						
$P_{LO}$	LO Drive Level		-3	0	6	dBm
$F_{LO}$	LO Frequency Range		1500		3600	MHz
$Z_{IN}$	Input Impedance			50		$\Omega$
RLi	Input Return Loss	$F_{RF} = 2800 - 3400\text{ MHz}$		10		dB
<b>Low Power Mode: LPM = 1</b>						
$I_{CC}$	Supply Current	$F_{LO} = 2300\text{ MHz}$		230		mA
$P_{diss}$	Total Power Dissipation	$F_{LO} = 2300\text{ MHz}$		0.76		W
G	Gain	$F_{RF} = 2500\text{ MHz (LSI)}$		9.2		dB
NF	SSB Noise Figure	$F_{RF} = 2500\text{ MHz (LSI)}$		9.9		dB
IIP3	Input 3rd Order Intercept Point	$F_{RF} = 2500\text{ MHz (LSI)}$ , $F_{spacing} = 20\text{ MHz}$		22		dBm
IP1dB	Input 1 dB Compression Point	$F_{RF} = 2500\text{ MHz (LSI)}$		11.5		dBm
<b>Isolation</b>						
	Channel Isolation	Drive RFinA/B IFoutA/B-IFoutB/A $F_{RF} = 2500\text{ MHz}$		48		dB
	RF to IF Isolation	$F_{RF} = 2500\text{ MHz}$		21		dB
	LO to RF Leakage	$P_{LO} = 0\text{ dBm}$		-55		dBm
	LO to IF Leakage	$P_{LO} = 0\text{ dBm}$		-45		dBm
<b>Spurious</b>						
	2x2 Spurious Product	2RF - 2LO		65		dBc
	3x3 Spurious Product	3RF - 3LO		70		dBc
<b>IF Output</b>						
$Z_L$	Differential Output Impedance Load			200		$\Omega$
$F_{IF}$	Frequency Range	1 dB corner frequency	30		600	MHz
	DC Bias Range	Externally supplied DC bias through RF choke		3.3		V



## 7.8 Timing Requirements

			MIN	TYP	MAX	UNIT
<b>Power Control</b>						
P <sub>D</sub>	Turn-on Time	P <sub>D</sub> = low to 90% final output power		100		ns
	Turn-off Time	P <sub>D</sub> = high to initial output power –30 dB		100		ns

### 7.9 Typical Characteristics (TRF37A32)

$T_A = 25^\circ\text{C}$ ,  $V_{CC} = 3.3\text{ V}$ ;  $P_{RF} = -10\text{ dBm}$ ;  $F_{RF} = 950\text{ MHz}$ ;  $P_{LO} = 0\text{ dBm}$ ;  $F_{IF} = 200\text{ MHz}$ ; Low Side Injection, LPM = 0 (unless otherwise noted)

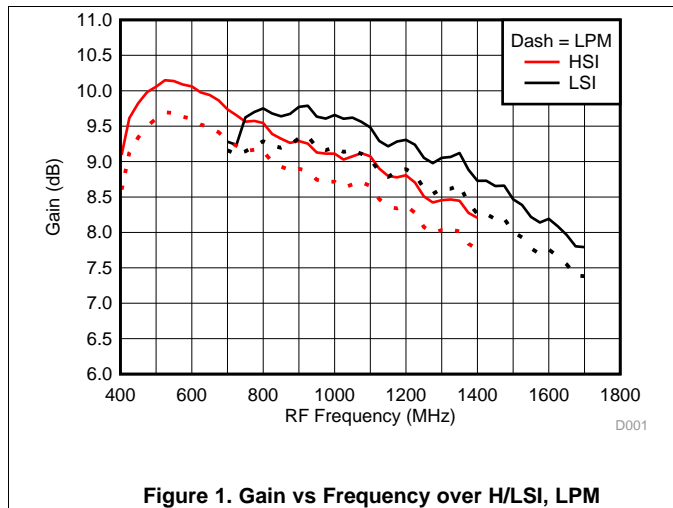

Figure 1. Gain vs Frequency over H/LSI, LPM

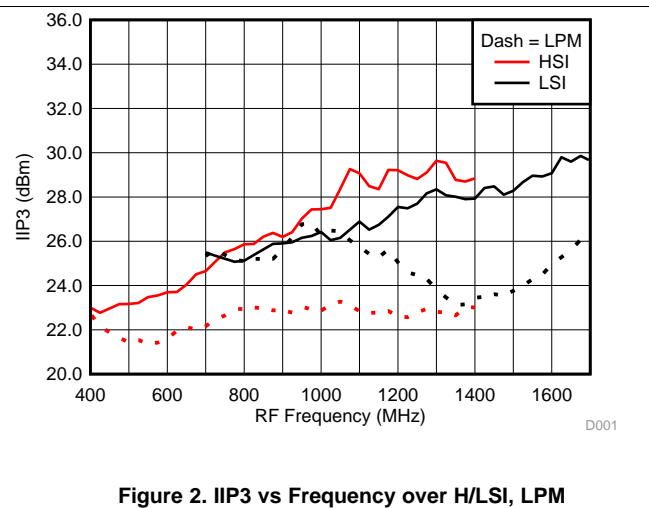

Figure 2. IIP3 vs Frequency over H/LSI, LPM

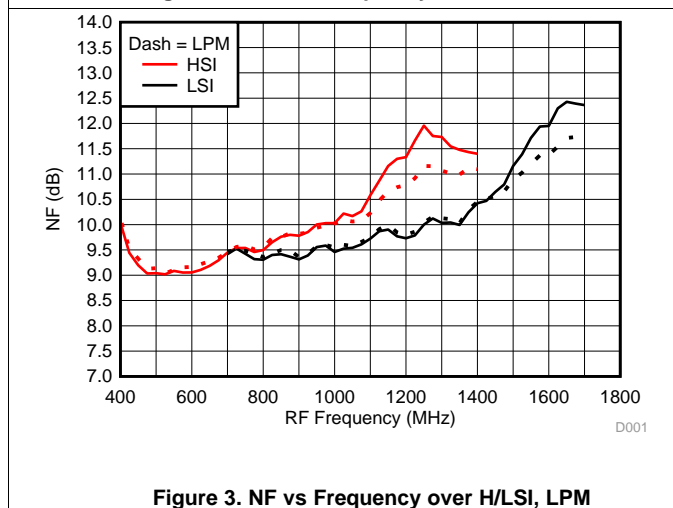

Figure 3. NF vs Frequency over H/LSI, LPM

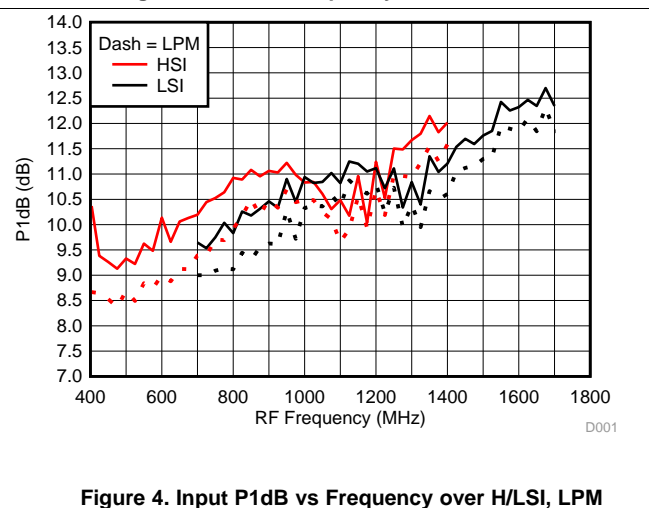

Figure 4. Input P1dB vs Frequency over H/LSI, LPM

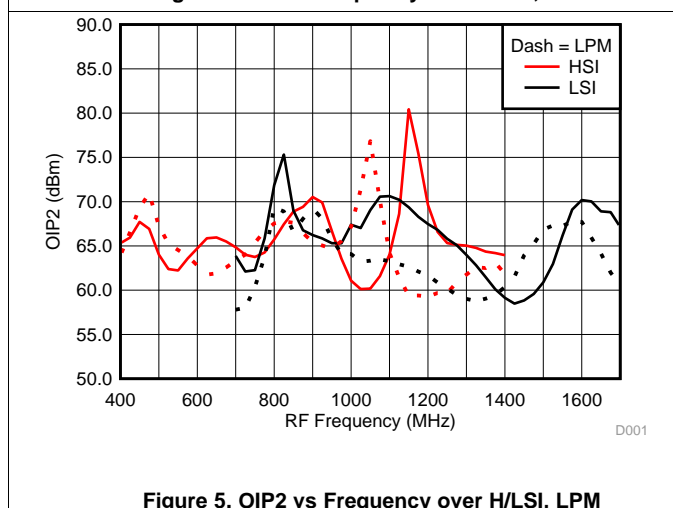

Figure 5. OIP2 vs Frequency over H/LSI, LPM

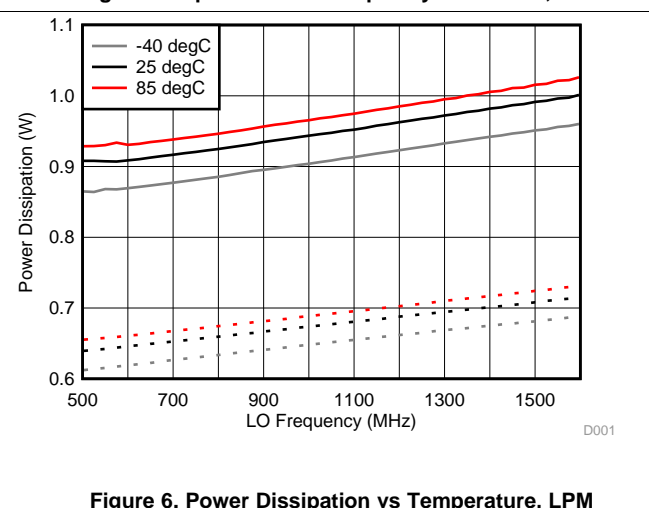
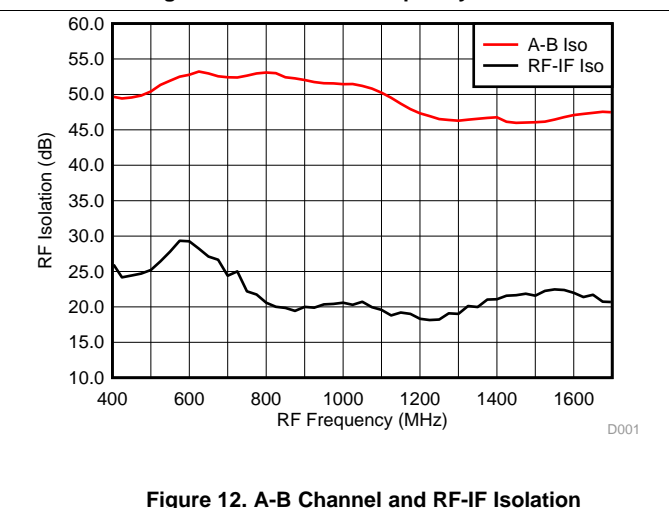
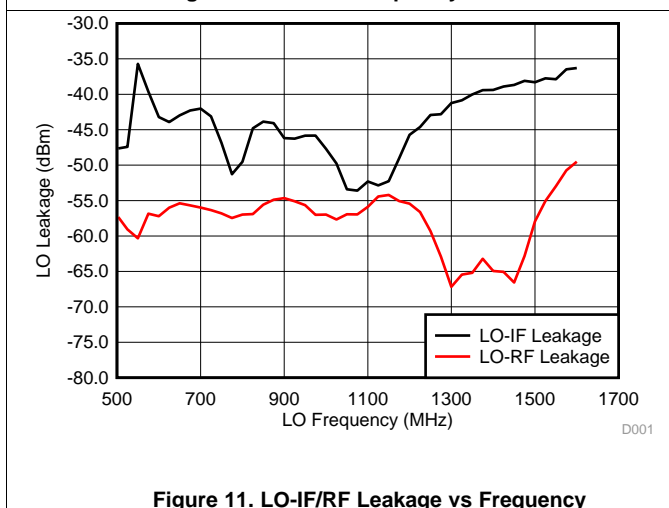
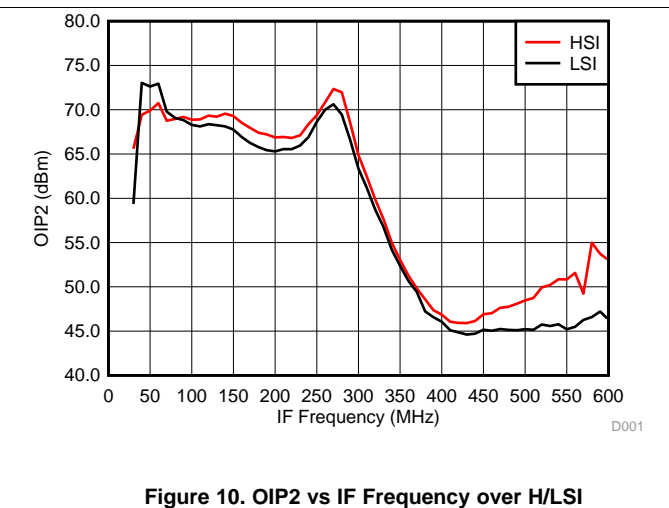
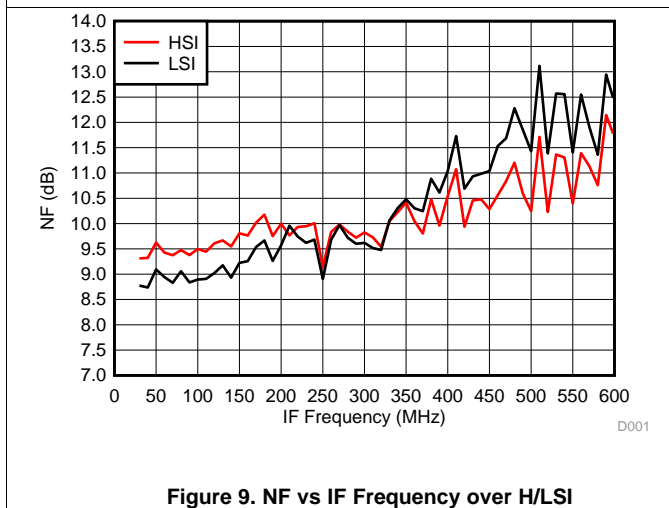
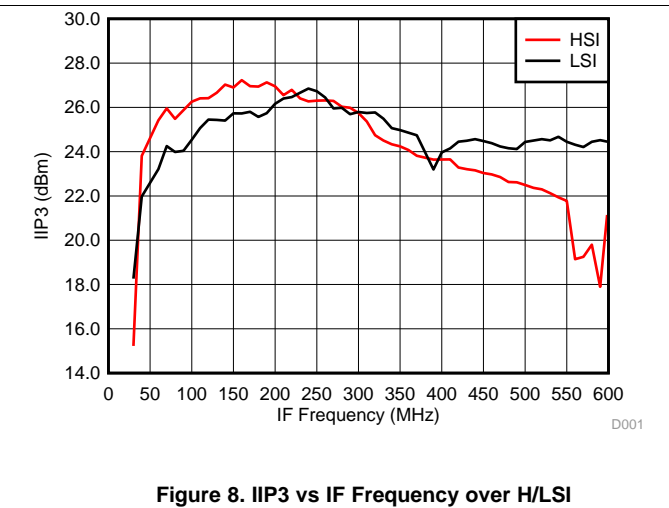
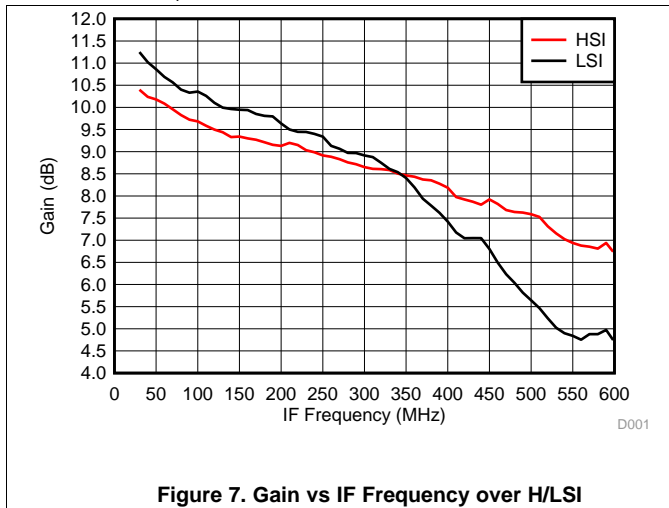

Figure 6. Power Dissipation vs Temperature, LPM

**Typical Characteristics (TRF37A32) (continued)**

$T_A = 25^\circ\text{C}$ ,  $V_{CC} = 3.3\text{ V}$ ;  $P_{RF} = -10\text{ dBm}$ ;  $F_{RF} = 950\text{ MHz}$ ;  $P_{LO} = 0\text{ dBm}$ ;  $F_{IF} = 200\text{ MHz}$ ; Low Side Injection,  $LPM = 0$  (unless otherwise noted)



### Typical Characteristics (TRF37A32) (continued)

$T_A = 25^\circ\text{C}$ ,  $V_{CC} = 3.3\text{ V}$ ;  $P_{RF} = -10\text{ dBm}$ ;  $F_{RF} = 950\text{ MHz}$ ;  $P_{LO} = 0\text{ dBm}$ ;  $F_{IF} = 200\text{ MHz}$ ; Low Side Injection, LPM = 0 (unless otherwise noted)

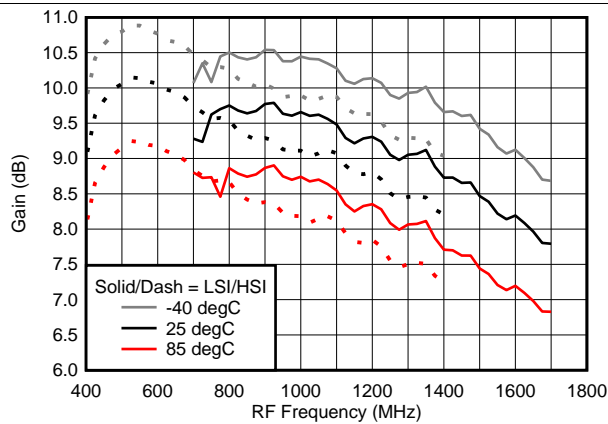

Figure 13. Gain vs Frequency over Temperature (HSI/LSI)

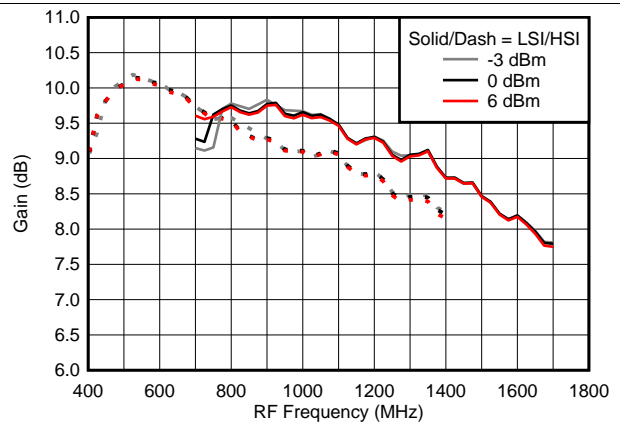

Figure 14. Gain vs Frequency over LO Drive (H/LSI)

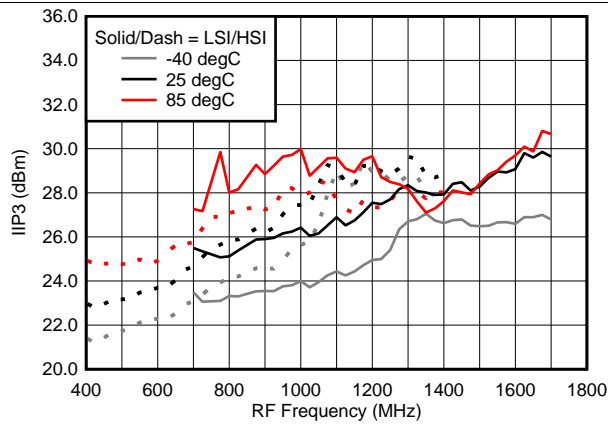

Figure 15. IIP3 vs Frequency over Temperature (HSI/LSI)

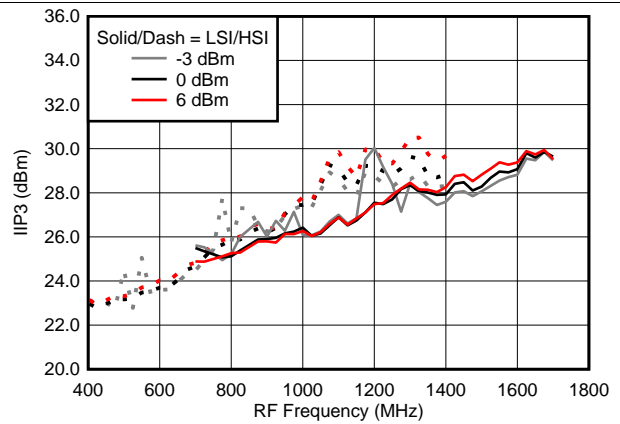

Figure 16. IIP3 vs Frequency over LO Drive (H/LSI)

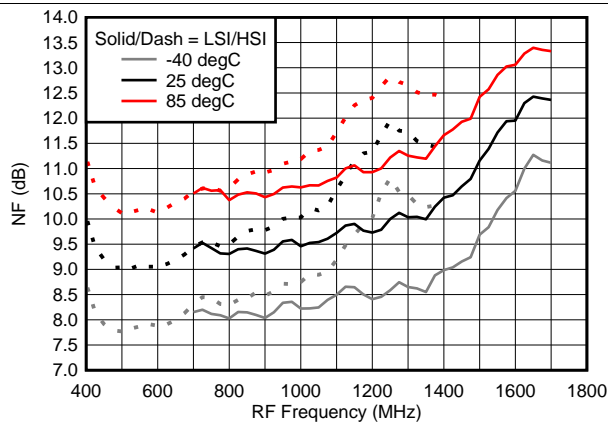

Figure 17. NF vs Frequency over Temperature (HSI/LSI)

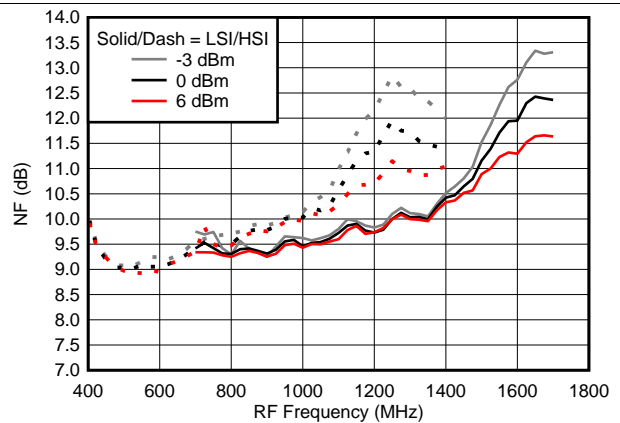

Figure 18. NF vs Frequency over LO Drive (H/LSI)

Typical Characteristics (TRF37A32) (continued)

$T_A = 25^\circ\text{C}$ ,  $V_{CC} = 3.3\text{ V}$ ;  $P_{RF} = -10\text{ dBm}$ ;  $F_{RF} = 950\text{ MHz}$ ;  $P_{LO} = 0\text{ dBm}$ ;  $F_{IF} = 200\text{ MHz}$ ; Low Side Injection, LPM = 0 (unless otherwise noted)

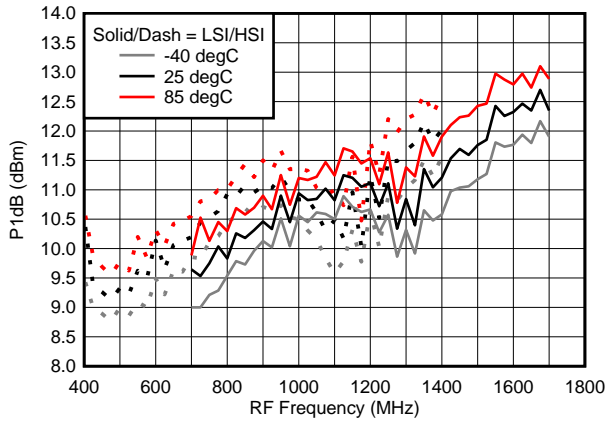

Figure 19. Input P1dB vs Frequency over Temperature (HSI/LSI)

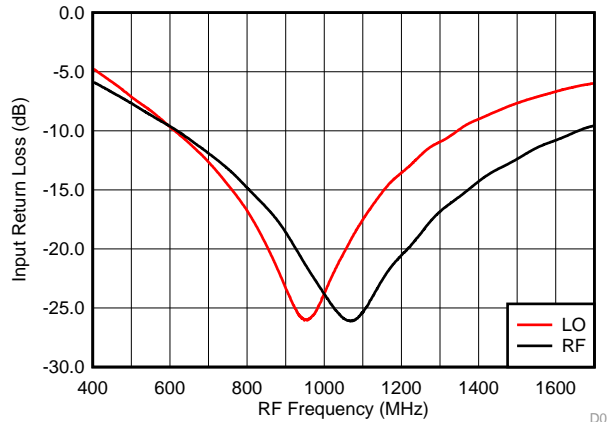

Figure 20. RF/LO Input Return Loss

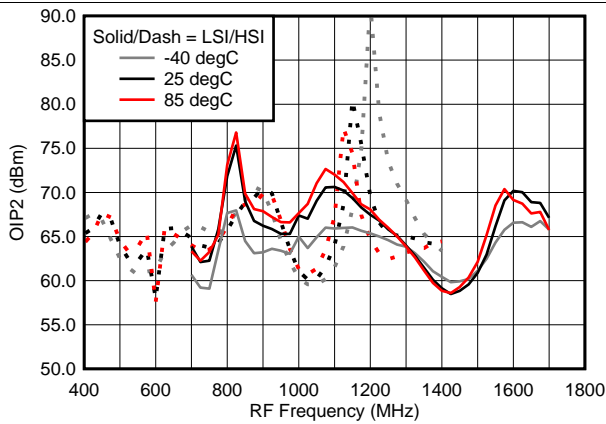

Figure 21. OIP2 vs Frequency over Temperature (HSI/LSI)

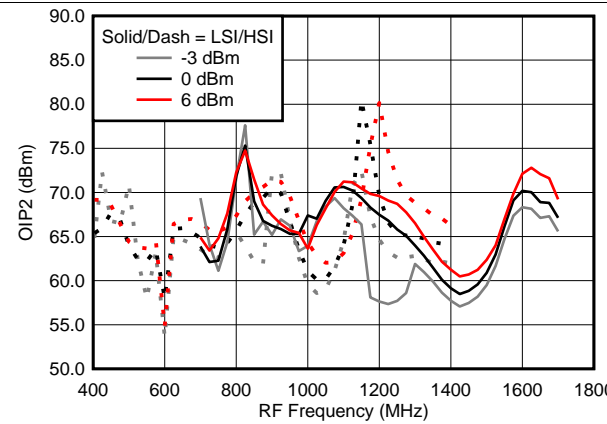

Figure 22. OIP2 vs Frequency over LO Drive (H/LSI)

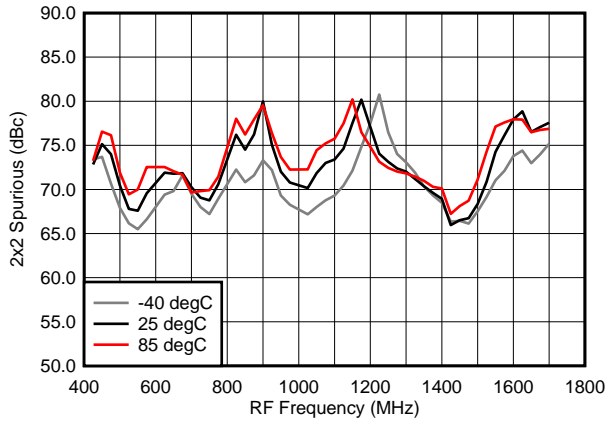

Figure 23. 2 x 2 Spurious over Temperature (H/LSI)

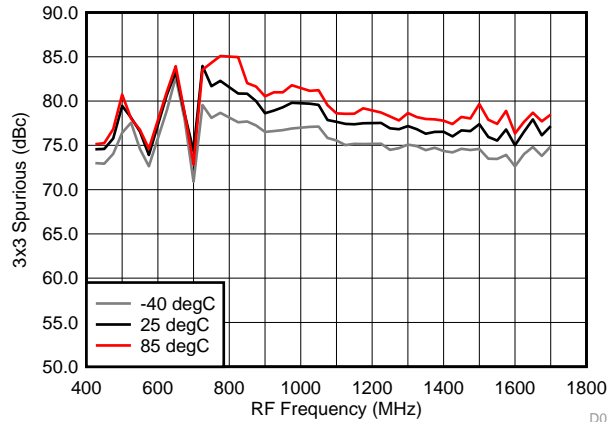

Figure 24. 3 x 3 Spurious over Temperature (H/LSI)

### 7.10 Typical Characteristics (TRF37B32)

$T_A = 25^\circ\text{C}$ ,  $V_{CC} = 3.3\text{ V}$ ;  $P_{RF} = -10\text{ dBm}$ ;  $F_{RF} = 1950\text{ MHz}$ ;  $P_{LO} = 0\text{ dBm}$ ;  $F_{IF} = 200\text{ MHz}$ ; Low Side Injection, LPM = 0 (unless otherwise noted)

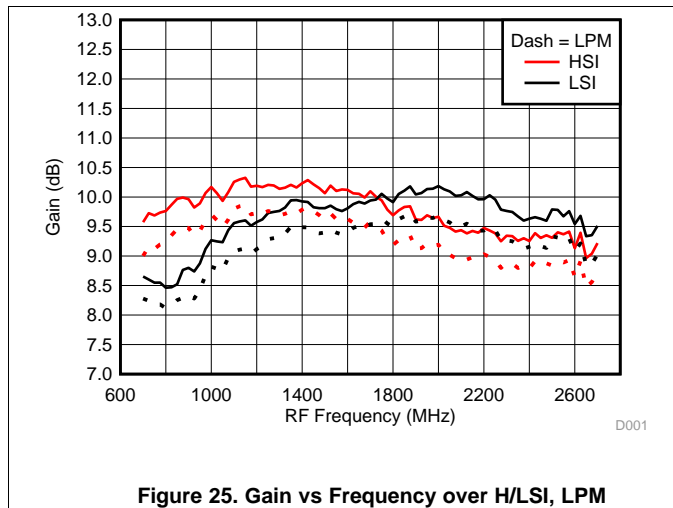

Figure 25. Gain vs Frequency over H/LSI, LPM

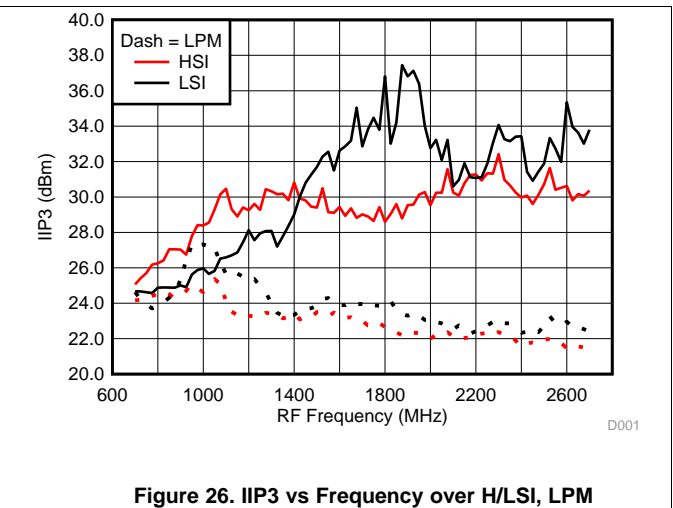

Figure 26. IIP3 vs Frequency over H/LSI, LPM

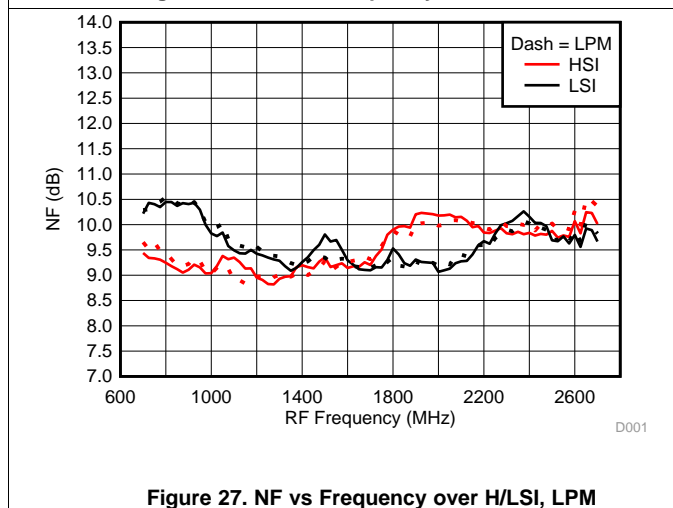

Figure 27. NF vs Frequency over H/LSI, LPM

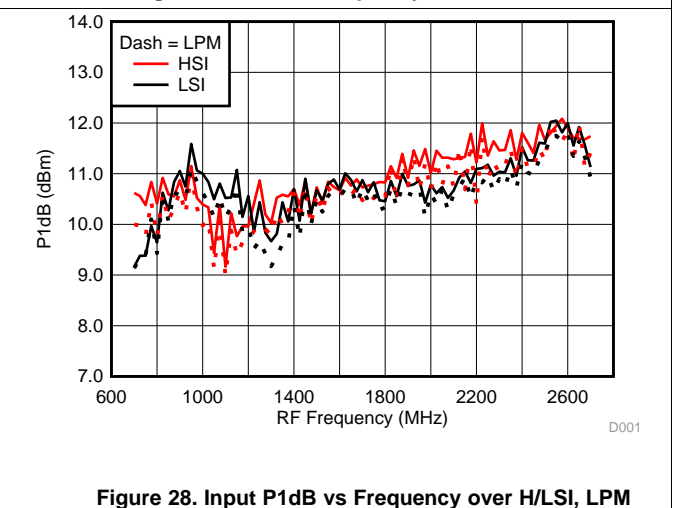

Figure 28. Input P1dB vs Frequency over H/LSI, LPM

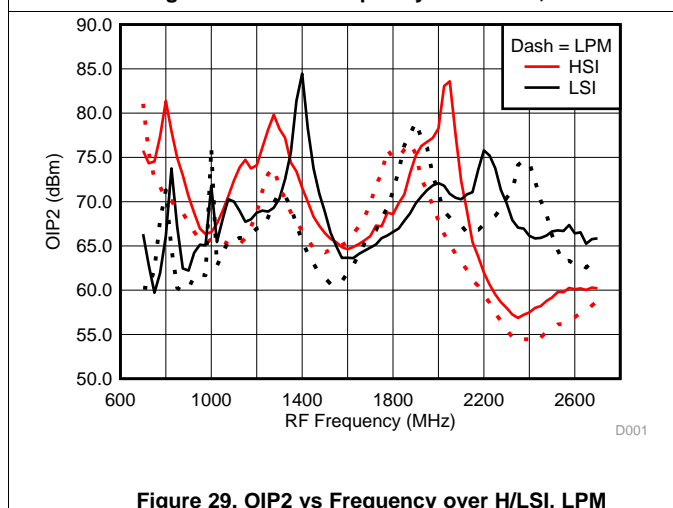

Figure 29. OIP2 vs Frequency over H/LSI, LPM

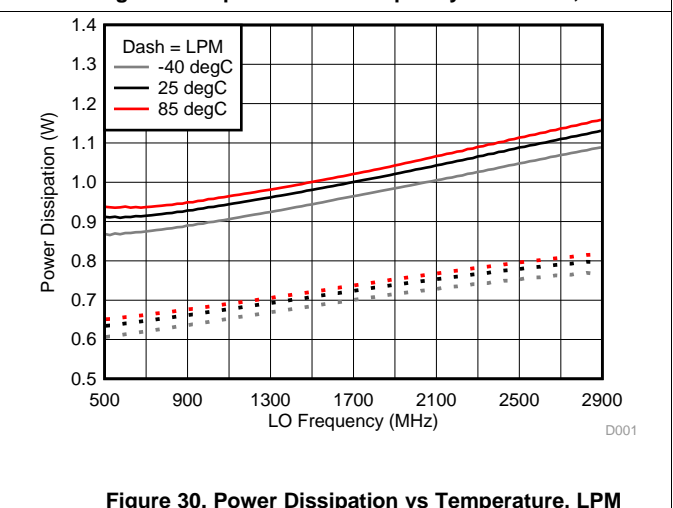
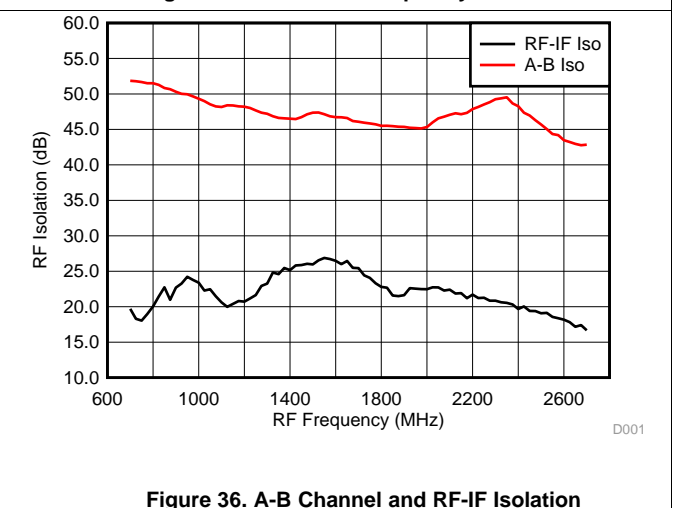
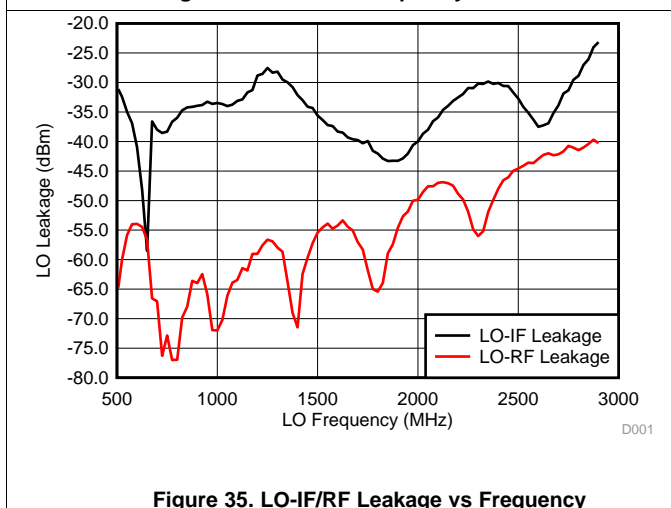
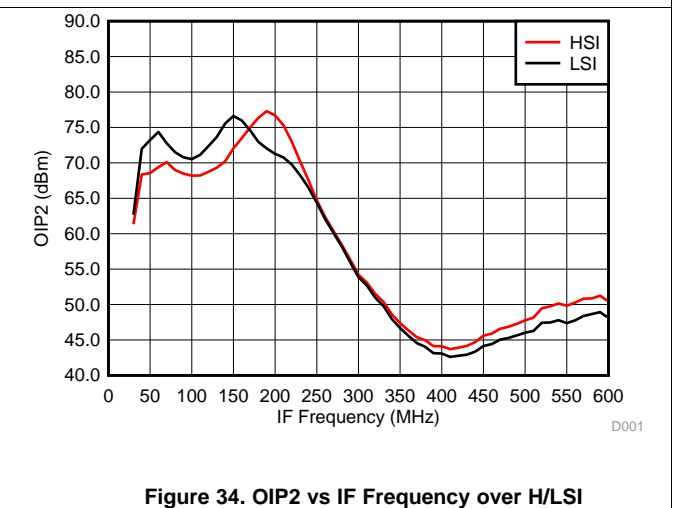
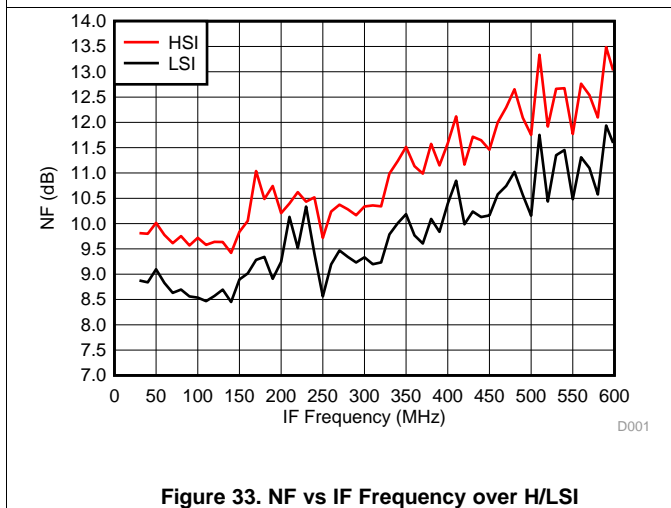
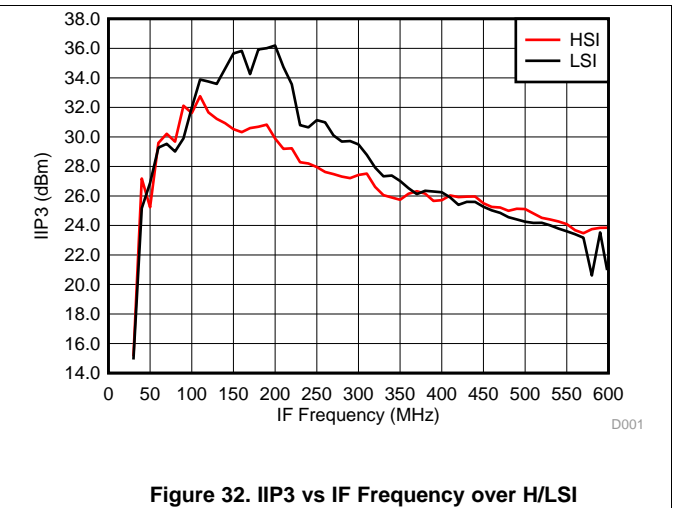
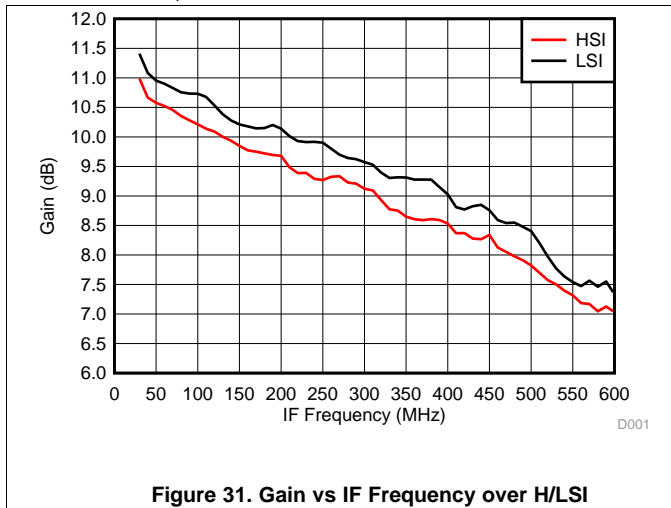

Figure 30. Power Dissipation vs Temperature, LPM

**Typical Characteristics (TRF37B32) (continued)**

$T_A = 25^\circ\text{C}$ ,  $V_{CC} = 3.3\text{ V}$ ;  $P_{RF} = -10\text{ dBm}$ ;  $F_{RF} = 1950\text{ MHz}$ ;  $P_{LO} = 0\text{ dBm}$ ;  $F_{IF} = 200\text{ MHz}$ ; Low Side Injection, LPM = 0 (unless otherwise noted)



### Typical Characteristics (TRF37B32) (continued)

$T_A = 25^\circ\text{C}$ ,  $V_{CC} = 3.3\text{ V}$ ;  $P_{RF} = -10\text{ dBm}$ ;  $F_{RF} = 1950\text{ MHz}$ ;  $P_{LO} = 0\text{ dBm}$ ;  $F_{IF} = 200\text{ MHz}$ ; Low Side Injection, LPM = 0 (unless otherwise noted)

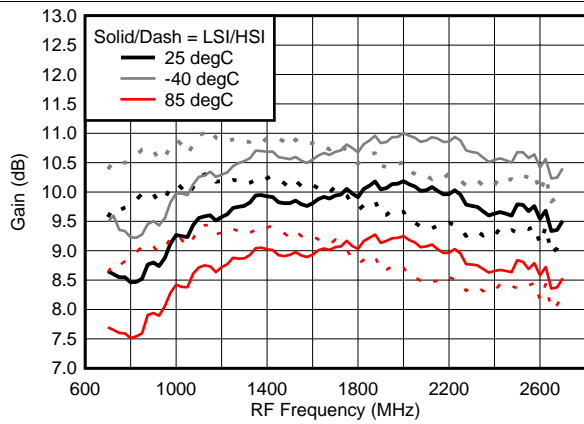

Figure 37. Gain vs Frequency over Temperature (HSI/LSI)

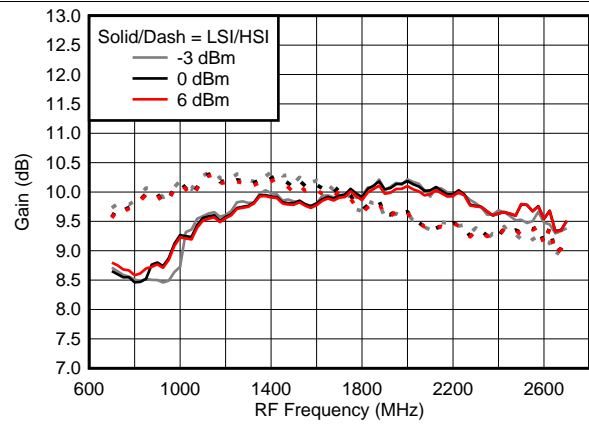

Figure 38. Gain vs Frequency over LO Drive (H/LSI)

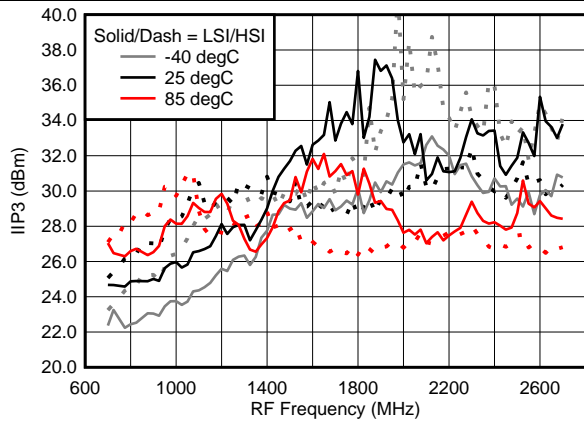

Figure 39. IIP3 vs Frequency over Temperature (HSI/LSI)

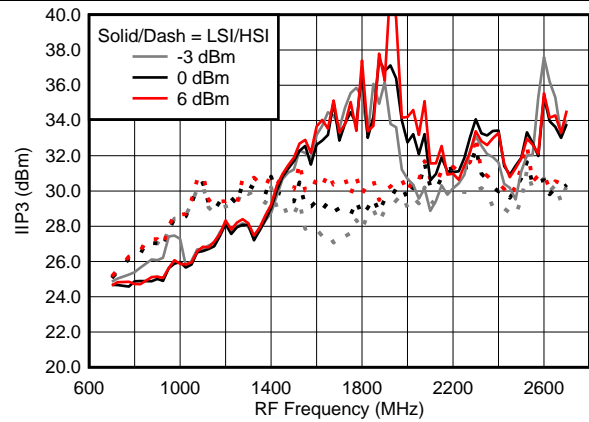

Figure 40. IIP3 vs Frequency over LO Drive (H/LSI)

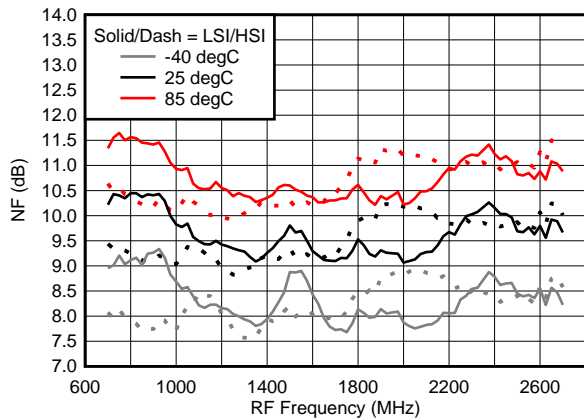

Figure 41. NF vs Frequency over Temperature (HSI/LSI)

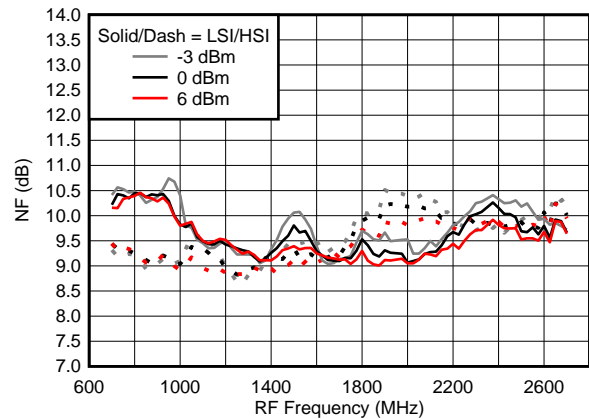
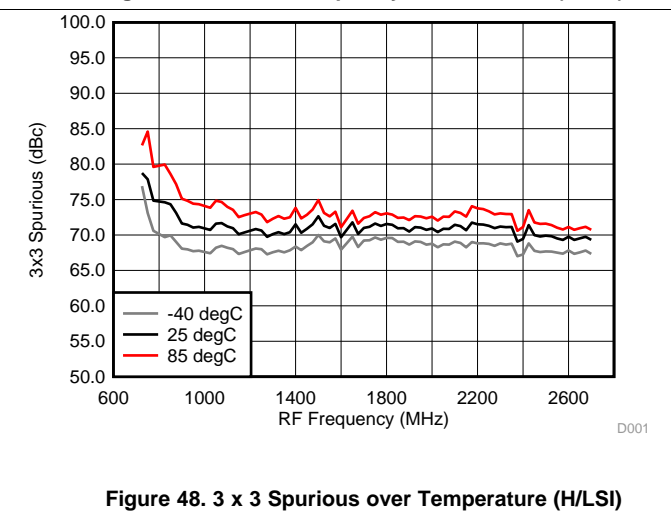
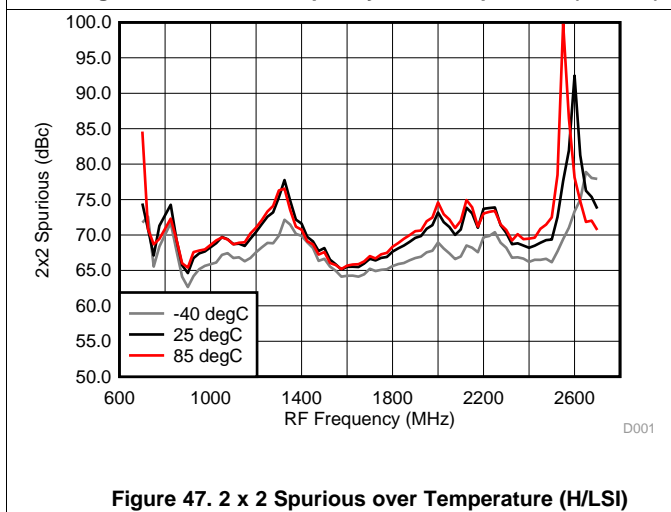
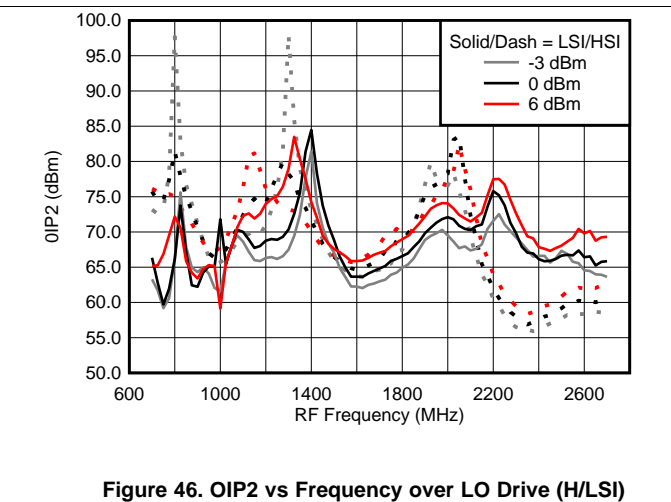
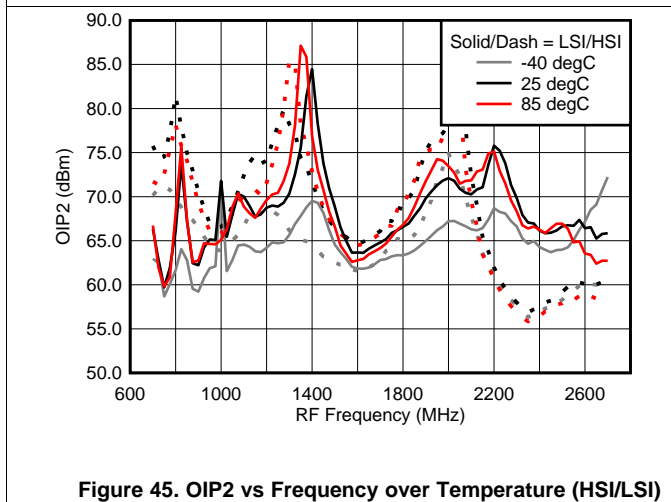
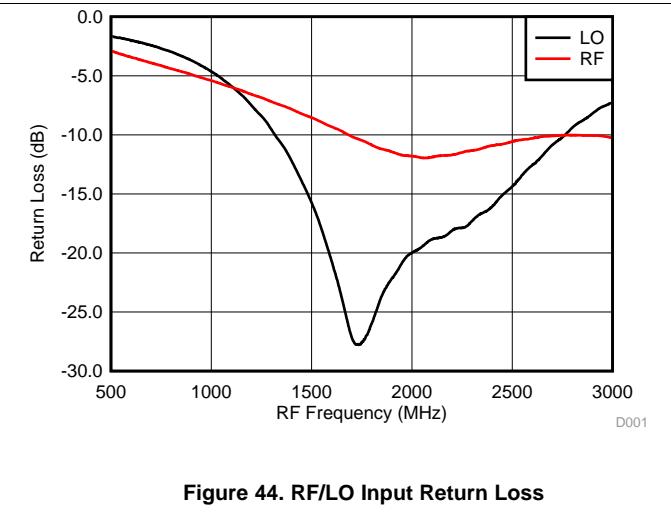
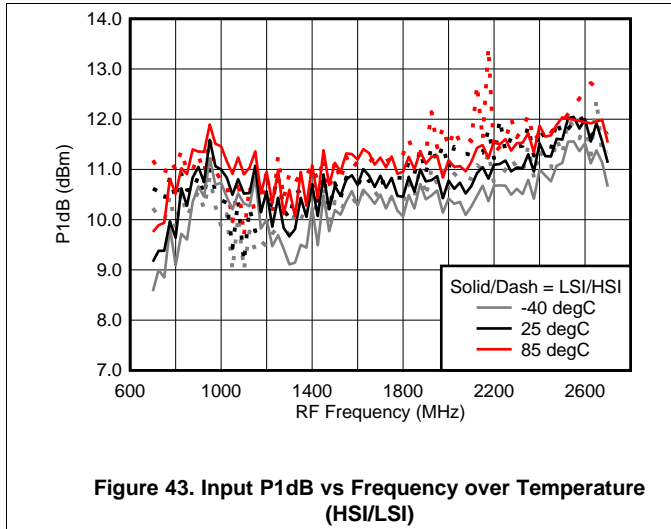

Figure 42. NF vs Frequency over LO Drive (H/LSI)



Typical Characteristics (TRF37B32) (continued)

$T_A = 25^\circ\text{C}$ ,  $V_{CC} = 3.3\text{ V}$ ;  $P_{RF} = -10\text{ dBm}$ ;  $F_{RF} = 1950\text{ MHz}$ ;  $P_{LO} = 0\text{ dBm}$ ;  $F_{IF} = 200\text{ MHz}$ ; Low Side Injection, LPM = 0 (unless otherwise noted)



### 7.11 Typical Characteristics (TRF37C32)

$T_A = 25^\circ\text{C}$ ,  $V_{CC} = 3.3\text{ V}$ ;  $P_{RF} = -10\text{ dBm}$ ;  $F_{RF} = 2500\text{ MHz}$ ;  $P_{LO} = 0\text{ dBm}$ ;  $F_{IF} = 200\text{ MHz}$ ; Low Side Injection, LPM = 0 (unless otherwise noted)

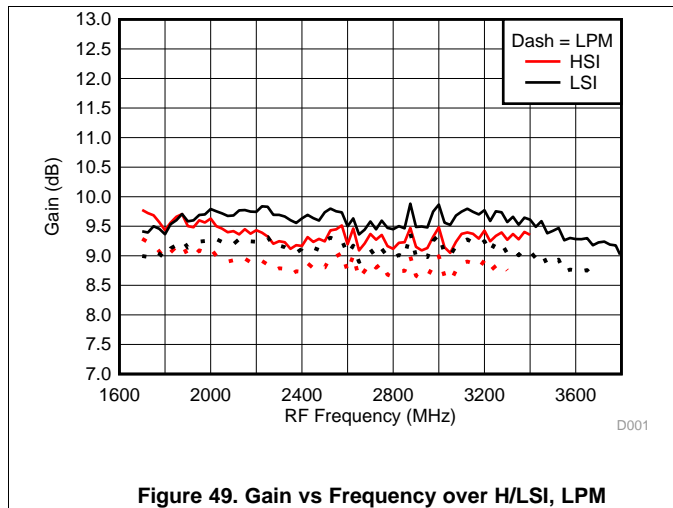

Figure 49. Gain vs Frequency over H/LSI, LPM

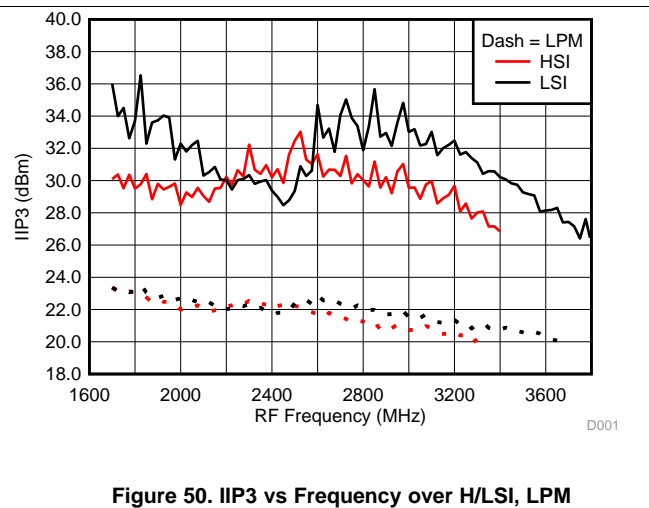

Figure 50. IIP3 vs Frequency over H/LSI, LPM

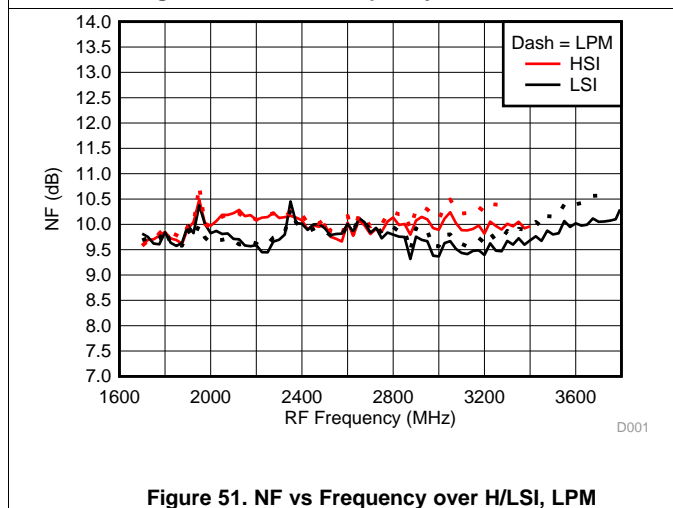

Figure 51. NF vs Frequency over H/LSI, LPM

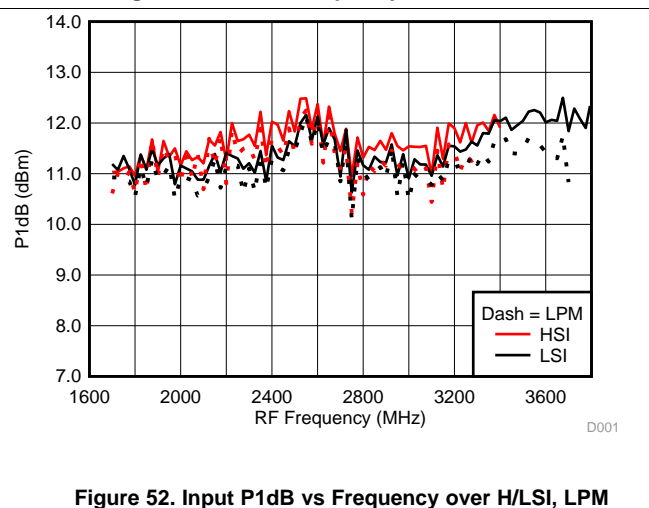

Figure 52. Input P1dB vs Frequency over H/LSI, LPM

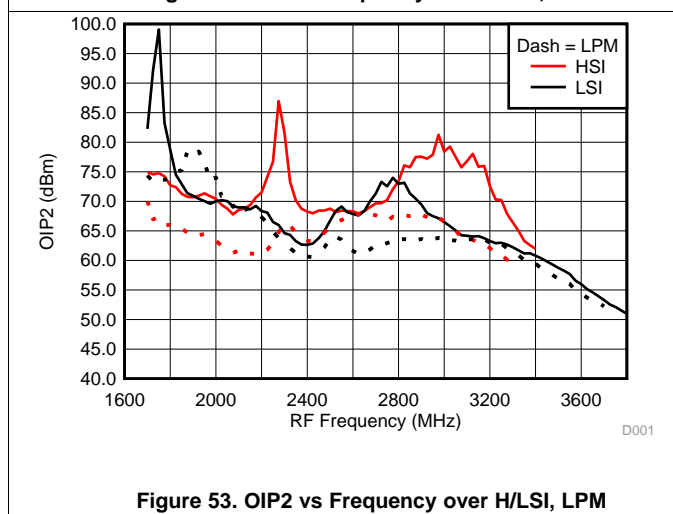

Figure 53. OIP2 vs Frequency over H/LSI, LPM

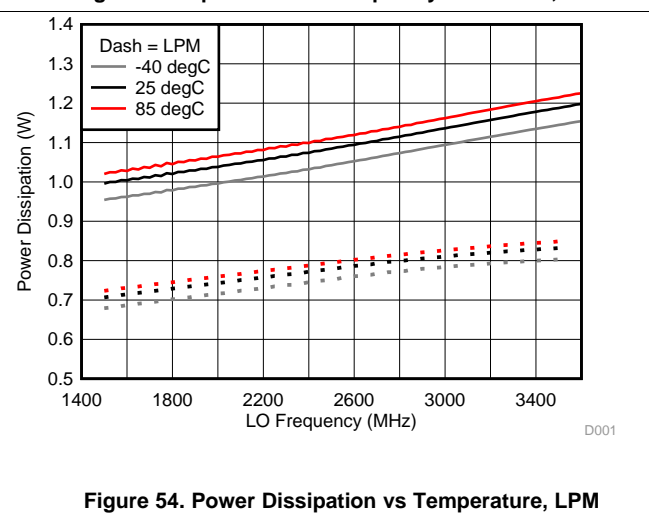
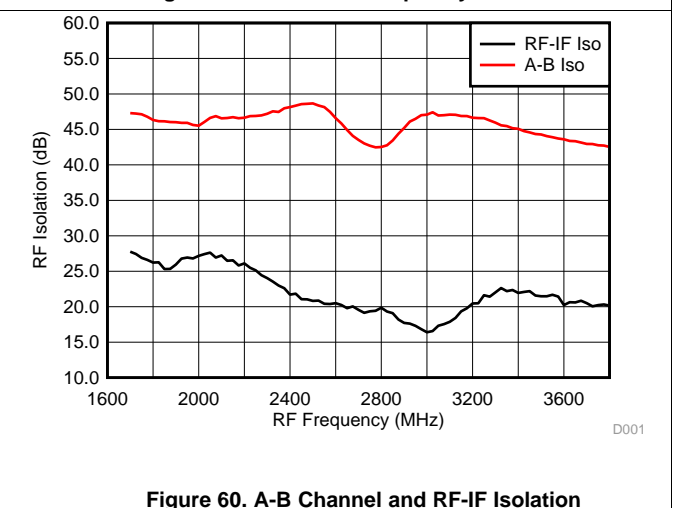
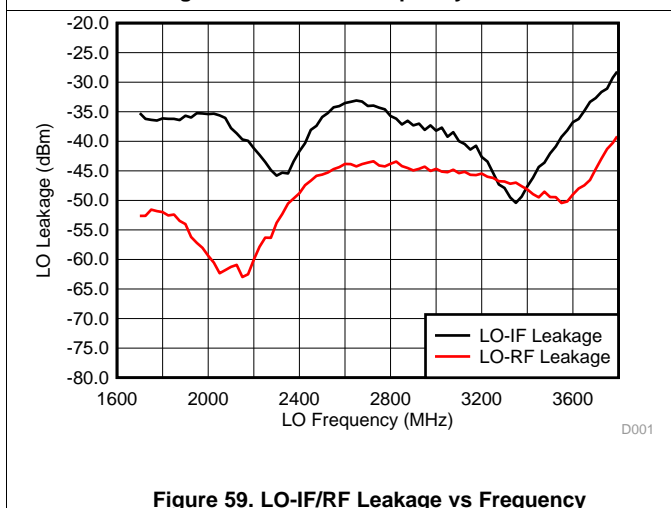
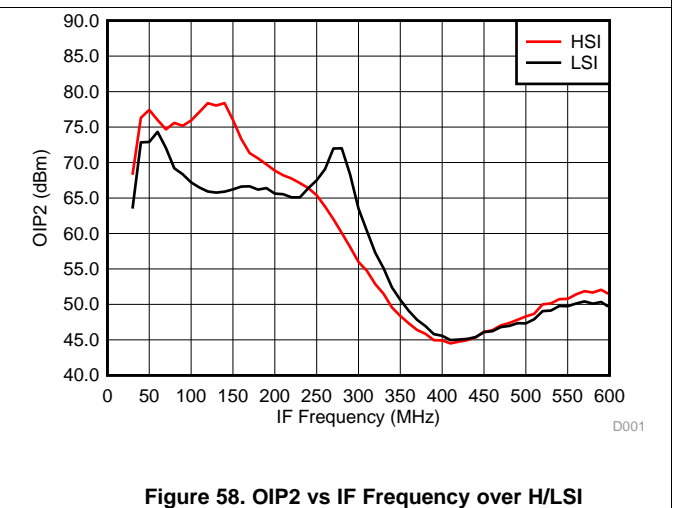
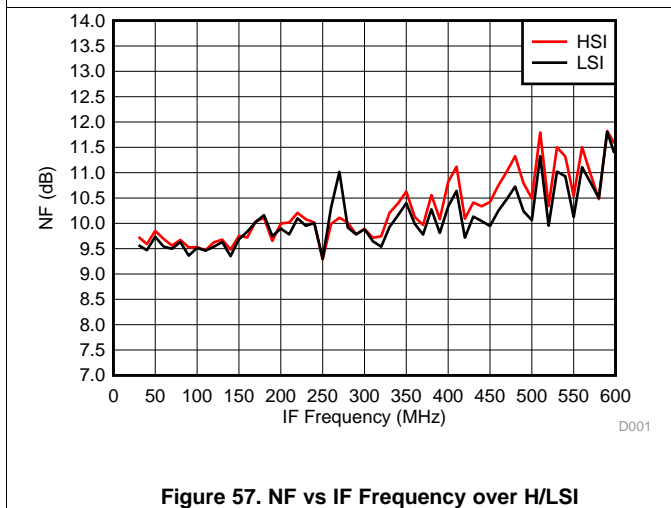
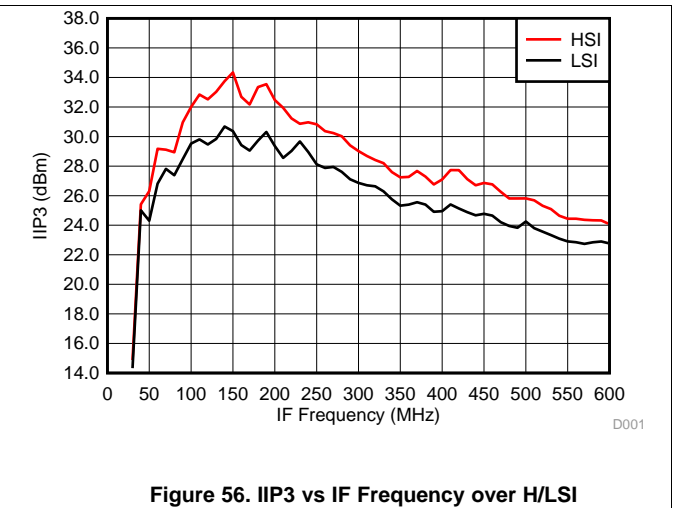
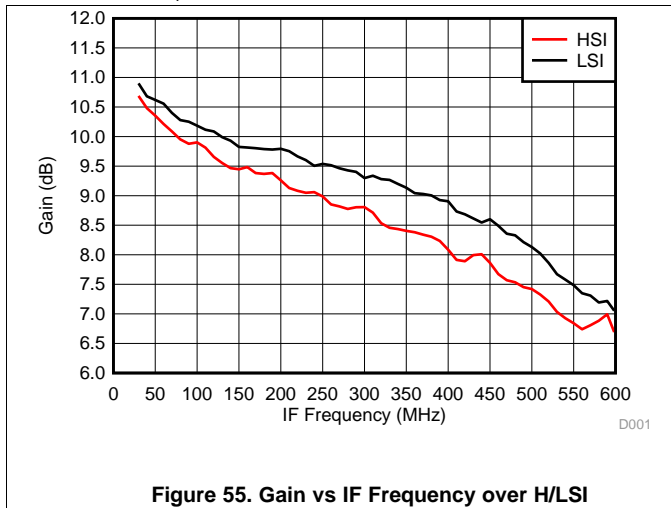

Figure 54. Power Dissipation vs Temperature, LPM

**Typical Characteristics (TRF37C32) (continued)**

$T_A = 25^\circ\text{C}$ ,  $V_{CC} = 3.3\text{ V}$ ;  $P_{RF} = -10\text{ dBm}$ ;  $F_{RF} = 2500\text{ MHz}$ ;  $P_{LO} = 0\text{ dBm}$ ;  $F_{IF} = 200\text{ MHz}$ ; Low Side Injection, LPM = 0 (unless otherwise noted)



### Typical Characteristics (TRF37C32) (continued)

$T_A = 25^\circ\text{C}$ ,  $V_{CC} = 3.3\text{ V}$ ;  $P_{RF} = -10\text{ dBm}$ ;  $F_{RF} = 2500\text{ MHz}$ ;  $P_{LO} = 0\text{ dBm}$ ;  $F_{IF} = 200\text{ MHz}$ ; Low Side Injection, LPM = 0 (unless otherwise noted)

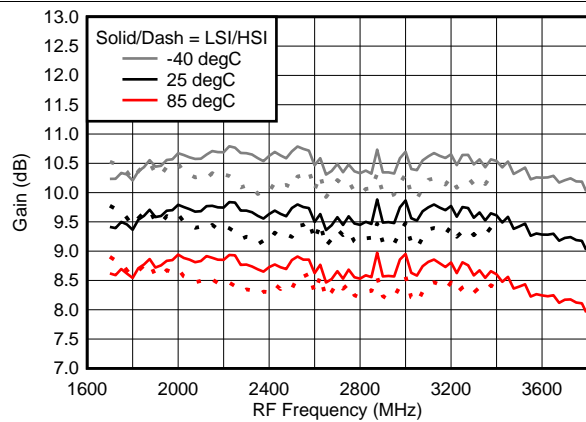

Figure 61. Gain vs Frequency over Temperature (HSI/LSI)

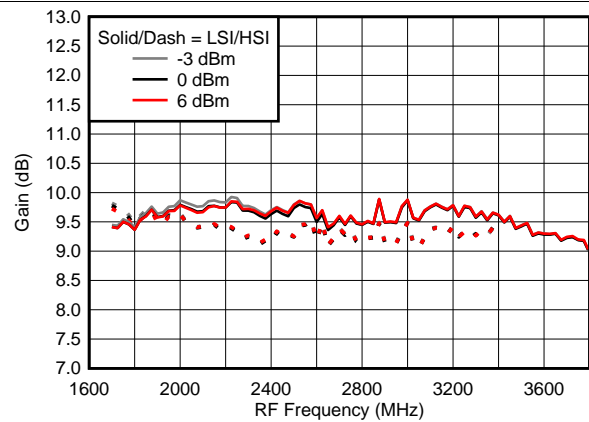

Figure 62. Gain vs Frequency over LO Drive (H/LSI)

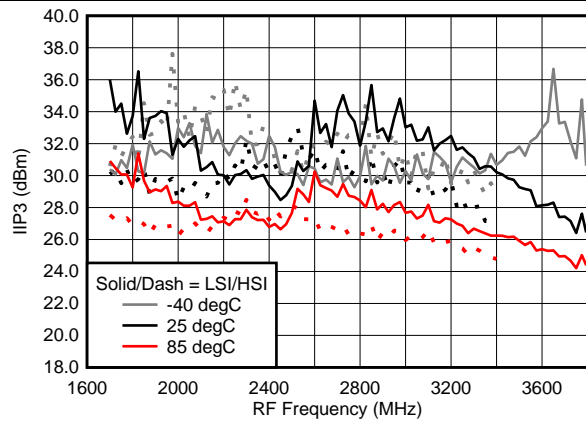

Figure 63. IIP3 vs Frequency over Temperature (HSI/LSI)

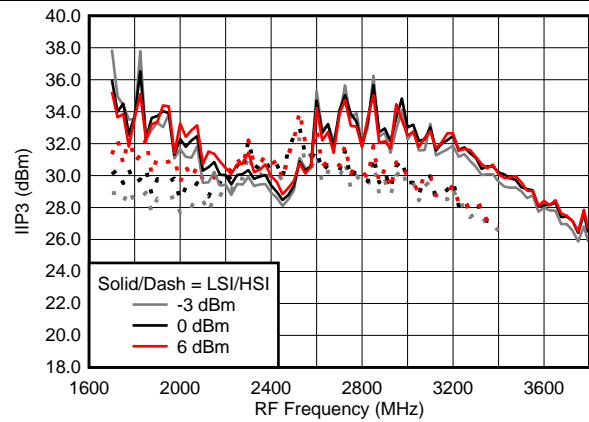

Figure 64. IIP3 vs Frequency over LO Drive (H/LSI)

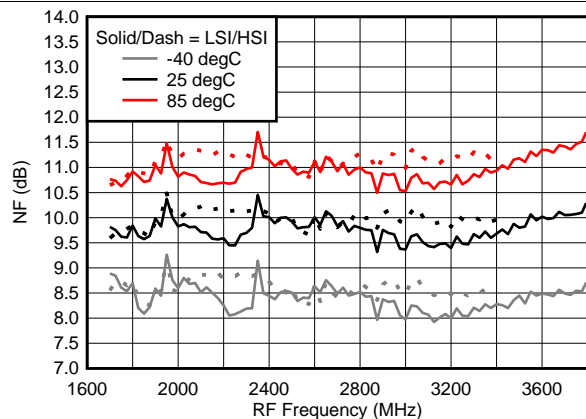

Figure 65. NF vs Frequency over Temperature (HSI/LSI)

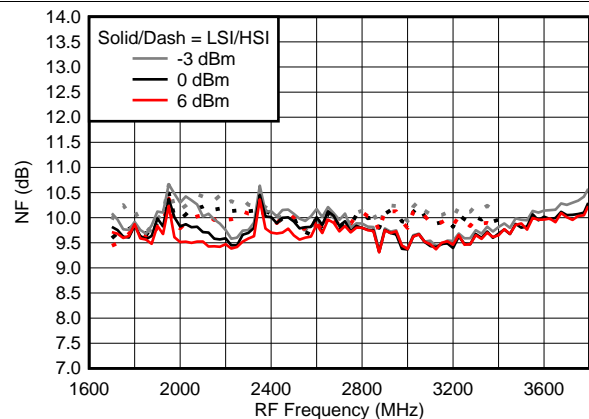

Figure 66. NF vs Frequency over LO Drive (H/LSI)

Typical Characteristics (TRF37C32) (continued)

$T_A = 25^\circ\text{C}$ ,  $V_{CC} = 3.3\text{ V}$ ;  $P_{RF} = -10\text{ dBm}$ ;  $F_{RF} = 2500\text{ MHz}$ ;  $P_{LO} = 0\text{ dBm}$ ;  $F_{IF} = 200\text{ MHz}$ ; Low Side Injection, LPM = 0 (unless otherwise noted)

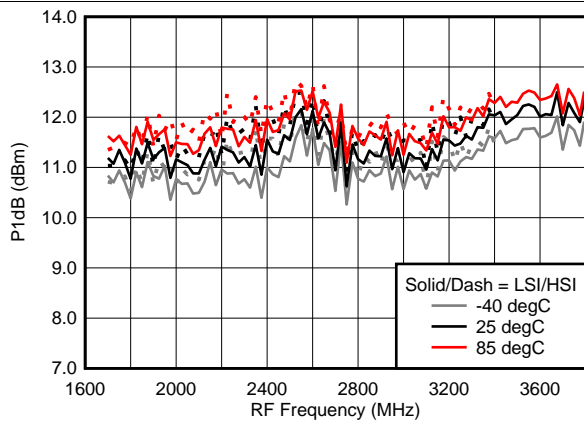

Figure 67. Input P1dB vs Frequency over Temperature (HSI/LSI)

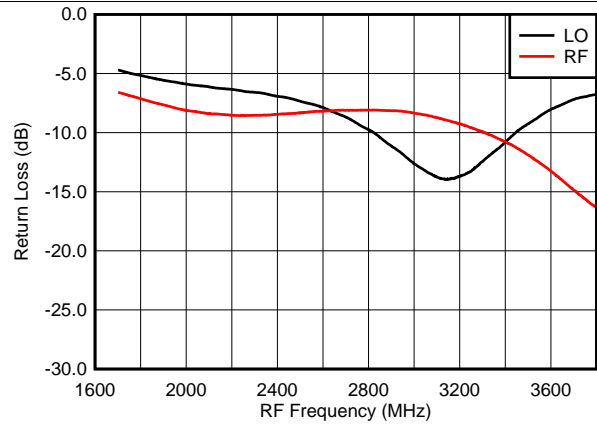

Figure 68. RF/LO Input Return Loss

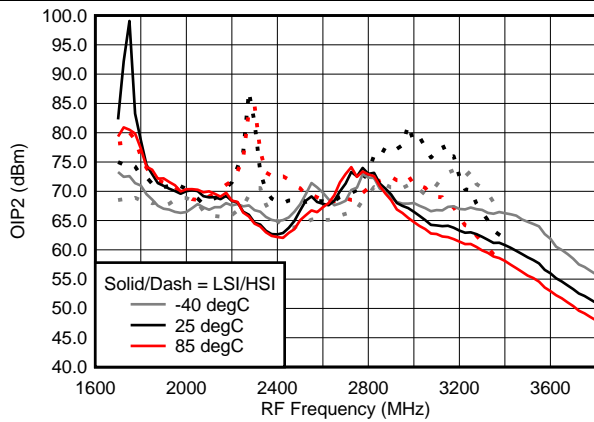

Figure 69. OIP2 vs Frequency over Temperature (HSI/LSI)

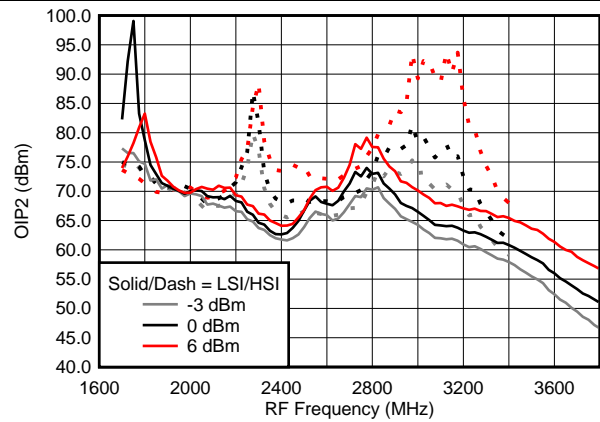

Figure 70. OIP2 vs Frequency over LO Drive (H/LSI)

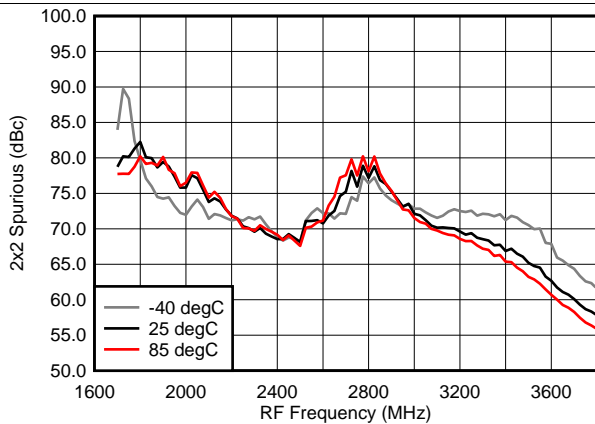

Figure 71. 2 x 2 Spurious over Temperature (H/LSI)

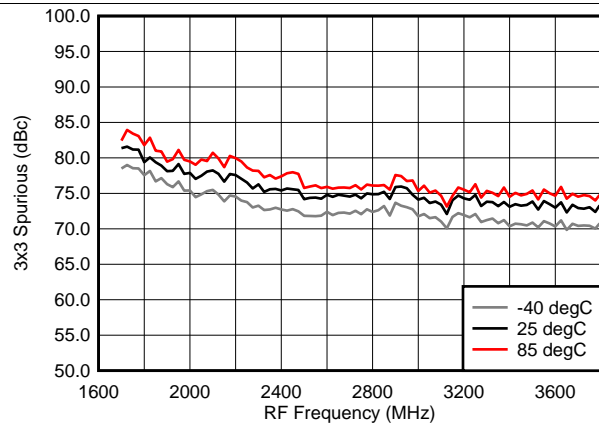

Figure 72. 3 x 3 Spurious over Temperature (H/LSI)

## 8 Detailed Description

### 8.1 Overview

The TRF37x32 family is a dual-channel, down convert receive mixer. It provides high-linearity over wide RF and IF bandwidths while also consuming low power. The device comes in three varieties, A, B, and C, to cover an extremely wide frequency band and can operate with either low side injection (LSI) or high side injection (HSI). The IF output is optimized for 200 MHz but operates from 30 MHz to 600 MHz with appropriate external components.

The device consists of a passive mixer core buffered by an LO amplifier and a high-linearity IF amplifier. There is an on-chip LDO to regulate VCC to the voltages needed for the small-geometry SiGe BiCMOS components. The single-ended RF and LO inputs each have a wideband internal balun. The balun's center tap is internally grounded.

Each channel offers an external power down terminal control which disables the IF circuitry. The device has a low power mode controlled through an external terminal control. Low power mode reduces bias current in the LO circuitry. Both power down and low power mode controls are internally biased to a normal operating state. The IFA/B\_BT terminals are self-biased and require no external components.

The TRF37x32 uses a single 3.3 V power supply and draws exceptionally low current for its performance node.

### 8.2 Functional Block Diagram

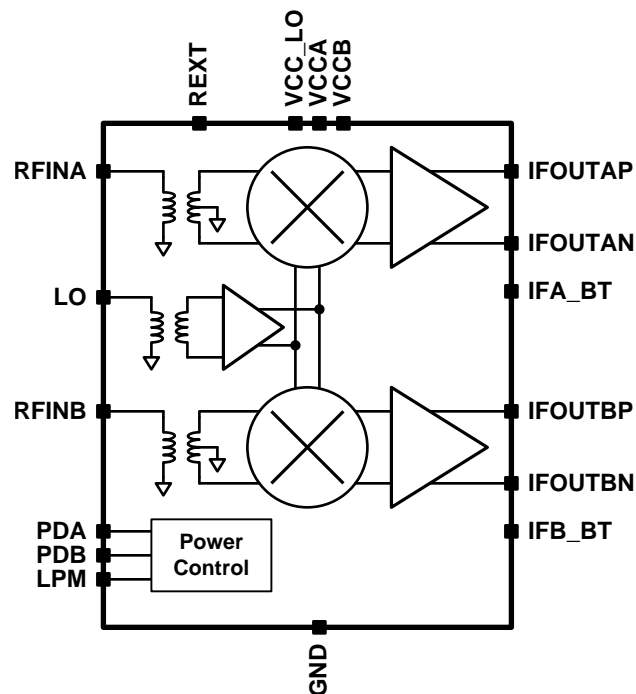

Figure 73. Block Diagram

### 8.3 Feature Description

#### 8.3.1 Low Power Mode

Low power mode is enabled by setting the active-high LPM terminal to a logic high. The device contains an internal pull-down to engage normal operation when the terminal is left unconnected or floating.

Low power mode reduces the bias current in the LO amplifier portion of the device and affects both channels. Total current consumption is reduced 30% while lowering analog performance metrics.

#### 8.3.2 Power Down

Each channel is powered down individually through the active-high PDA and PDB terminals. A logic high sets the respective channel in power down. The device contains an internal pull-down to engage normal operation when the terminal is left unconnected or floating.

Power down is implemented by removing bias in the IF amplifier. Operation of the opposite channel is not affected when either channel is turned off. Turn-on and turn-off time is fast enough to serve in most TDD applications.

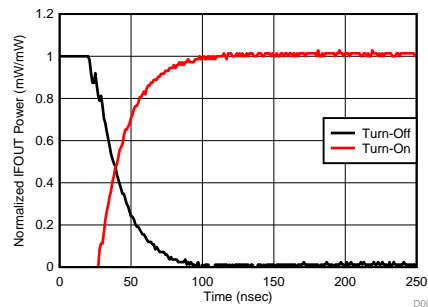

Figure 74. Device power down turn-on and turn-off time

#### 8.3.3 Single Ended RF Input

Each RF input is single-ended with a wideband internal balun to convert the input to a differential signal, as shown in Figure 73. The center tap of the balun is internally grounded and is not available external to the device. The RF input should be ac coupled to driving circuitry according to the chart in Table 1.

Table 1. RF Input AC coupling capacitor

Device	Blocking Cap Value
TRF37A32	20 pF
TRF37B32	10 pF
TRF37C32	10 pF

#### 8.3.4 Single Ended LO Input

The LO input is single ended with an internal balun to convert the input to a differential signal. The LO drive path includes a high frequency dual-mode oscillation inhibitor circuitry to ensure stable operation. For best operation it is recommended to keep the LO drive level at 0 dBm or higher to ensure inhibitor circuit does not falsely engage. At lower LO drive level, keep the LO power engaged to the device at power-up. At lower drive level the inhibitor may engage within certain frequency bands when the LO power transitions.

At the extreme RF frequencies the LO input bandwidth will force operation to either high side injection (HSI) or low side injection (LSI). Table 2 provides the operating range of the LO for each device.

Table 2. LO Input Frequency Operating Range

Device	Operating Range
TRF37A32	600 - 1400 MHz
TRF37B32	500 - 2900 MHz

**Table 2. LO Input Frequency Operating Range (continued)**

	Device	Operating Range
TRF37C32	Low Power mode (LPM) disabled	1500 - 3600 MHz
	Low Power mode (LPM) enabled	1500 - 3500 MHz

### 8.3.5 IF Amplifier

The output of the device is driven by a high-linearity IF amplifier. The output nodes must be pulled up to VCC with high-Q inductors. It is designed to provide 200  $\Omega$  differential / 100  $\Omega$  single-ended output impedance. Layout should include symmetry for the differential output signal paths.

The IF output circuitry is optimized for performance at 200 MHz but operates over 30 MHz – 600 MHz.

## 8.4 Device Functional Modes

### 8.4.1 Low Power Mode

Low power mode is activated through the low power terminal, as described in the features description. It is designed for extremely low power consumption.

### 8.4.2 Single Channel and Shutdown Modes

The device may be operated as a single channel device by disabling one channel or in complete shutdown by disabling both channels.



## 9 Applications and Implementation

### NOTE

Information in the following applications and implementation sections is not part of the TI component specification, and TI does not warrant its accuracy or completeness. TI's customers are responsible for determining suitability of components for their purposes. Customers should validate and test their design implementation to confirm system functionality.

### 9.1 Application Information

The devices are high-linearity, wideband receive mixers. They are typically implemented to convert frequencies from the range 400 MHz to 3800 MHz into the range 30 MHz to 600 MHz.

### 9.2 Typical Application

The TRF37x32 device is typically placed in a system as illustrated in [Figure 75](#).

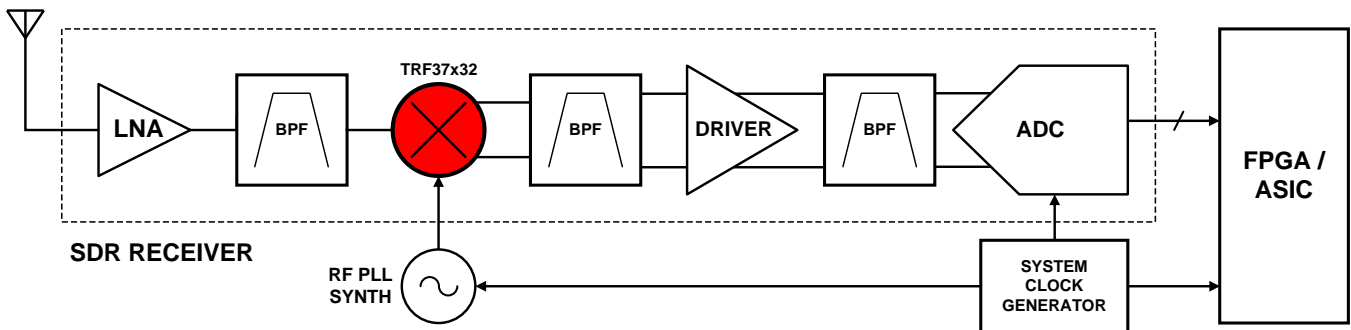

Figure 75. Typical System Implementation of TRF37x32

A typical schematic for the TRF37x32 is shown in [Figure 76](#).

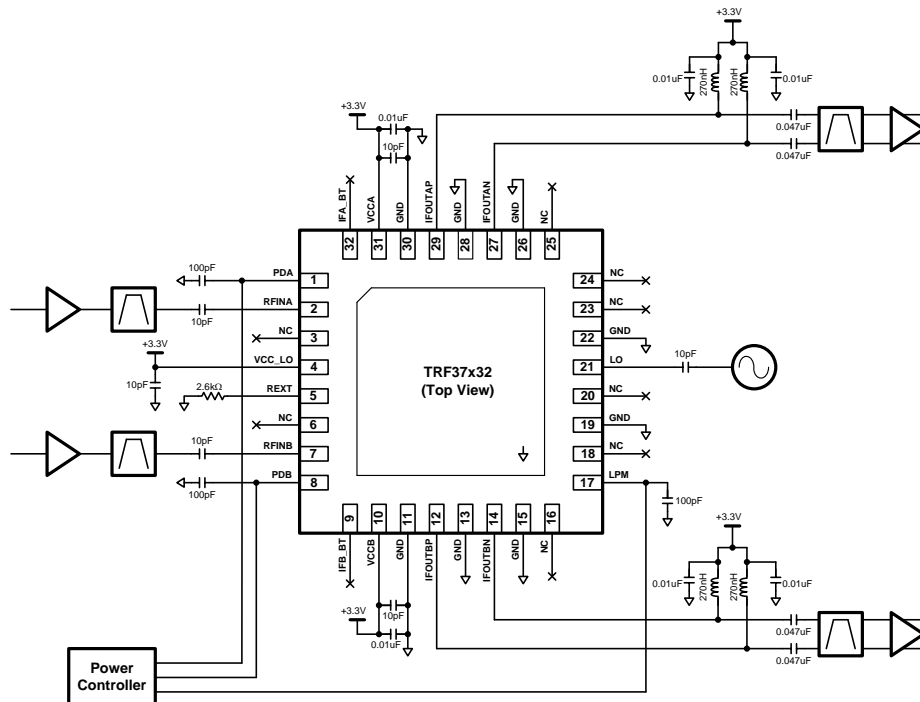

Figure 76. Typical Application Schematic for TRF37x32

## Typical Application (continued)

### 9.2.1 Design Requirements

For this design example, use the parameters shown in [Table 3](#).

**Table 3. Design Parameters**

MIXER PARAMETER	EXAMPLE APPLICATION REQUIREMENTS <sup>(1)</sup>	TRF37B32 PERFORMANCE (TYPICAL)
RF Frequency Range	2300 - 2400 MHz	700 - 2700 MHz
IF Frequency Range	318.64 - 418.64 MHz	30 - 600 MHz
Gain	9 - 10 dB	9.7 dB at $F_{RF} = 2300$ MHz
NF	< 12 dB	10 dB at $F_{RF} = 2300$ MHz
IIP3	> 28 dBm	30 dBm at $F_{RF} = 2300$ MHz
IP1dB	> 8 dBm	11 dBm at $F_{RF} = 2300$ MHz

(1) The example application requirements are derived from a hypothetical application and do not reflect the performance of the TRF37x32.

### 9.2.2 Detailed Design Procedure

#### 9.2.2.1 Power Level

Input power should back off from the TRF37x32 compression point for linear operation, ideally by 10dB or more. Choose LNA gain and gain scheduling in order to set the appropriate power level at the RF input to the TRF37x32.

Given the expected input power level, use the expected gain through the mixer and other elements, such as SAW filter and matching networks, to calculate the voltage expected at the ADC. Adjust gain and loss elements to maximize the utilization of ADC dynamic range.

#### 9.2.2.2 Matching

Although the TRF37x32 was designed to interface with 50  $\Omega$  RF and LO and 200  $\Omega$  differential signal lines, some elements in the signal chain may not present a wideband real impedance. Matching components are optional but may be used at these ports to improve impedance alignment, thereby increasing power delivered to the RF node and decreasing reflected and radiated power. Good matching maximizes isolation and linearity performance.

#### 9.2.2.3 RF Input Component Selection

The blocking capacitor value on the RF input should be selected according to [Table 1](#).

#### 9.2.2.4 IF Output Component Selection

Use high Q inductors for pull-up biasing on the IF output. 270 nH 0805-size wirewound inductors provides excellent linearity and gain. Larger inductor values may compress the IF bandwidth, while smaller package sizes tend to introduce lower inductor Q ratings.

Connect the supply nodes of both inductors for a given channel symmetrically to the VCC net with close proximity to ensure balanced connection to the supply.

#### 9.2.2.5 Frequency Planning

The LO and RF inputs are both designed for wideband behavior, and either high-side or low-side injection may be used interchangeably across most of the RF band. At the extreme RF frequencies the LO input bandwidth will force operation to either high side injection (HSI) or low side injection (LSI). [Table 2](#) provides the operating range of the LO for each device. Where possible it is recommended to utilize low side injection to keep the power dissipation to a minimum.

#### 9.2.2.6 Control Terminal Transients

Decoupling capacitors reduce terminal noise but also slow transient response. Adjust external capacitors in order to meet specified power-on and power-off response times. Apply transmission line matching techniques to achieve the fastest response times.

### 9.2.3 Application Curves

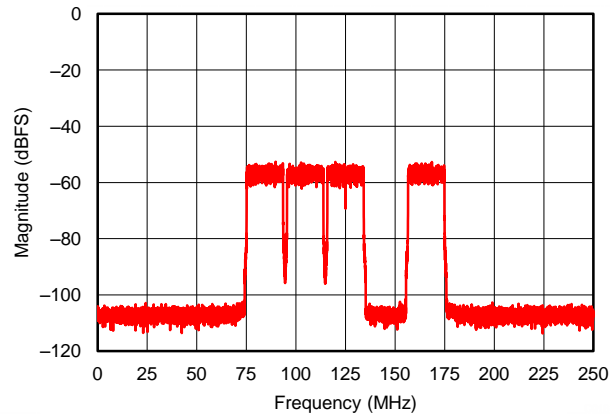

**Figure 77. 4-Carrier Receiver Application**

## 10 Power Supply Recommendations

The nominal voltage supply is 3.3 V; however, the TRF37x32 offers very consistent performance across the entire recommended voltage range. Signal isolation depends partly on power supply isolation. All supplies may be generated from a common source but should be isolated through decoupling capacitors placed close to the device. The typical application schematic in [Figure 76](#) is an excellent example. Select capacitors with self-resonant frequency near the application frequency or noise frequency. When multiple capacitors are used in parallel to create a broadband decoupling network, place the capacitor with the higher self-resonant frequency closer to the device.

### 10.1 Power Up Sequence

No power up sequence is required.

## 11 Layout

### 11.1 Layout Guidelines

Good layout practice helps to enable excellent linearity and isolation performance. An example of good layout is shown in [Figure 78](#). In the example, only the top signal layer and its adjacent ground reference plane are shown. Some recommended layout principles include the following:

- Excellent electrical connection from the PowerPAD™ to the board ground is essential. Use the recommended footprint, solder the pad to the board, and do not include solder mask under the pad
- Connect pad ground to device terminal ground on the top board layer.
- Verify that the return current path follows the primary current path by including topside terminal to pour ground connection and vias close to any reference layer transition.
- Do not route signal lines over breaks in the reference plane.
- Maintain symmetry as much as possible between lines in a differential pair. Match electrical lengths.
- Avoid routing clocks and digital control lines near signal lines.
- Do not route signal lines over noisy power planes. Ground is the best reference, although clean power planes can serve where necessary.
- Place supply decoupling close to the device.
- Keep channels physically separated to improve isolation.

### 11.2 Layout Example

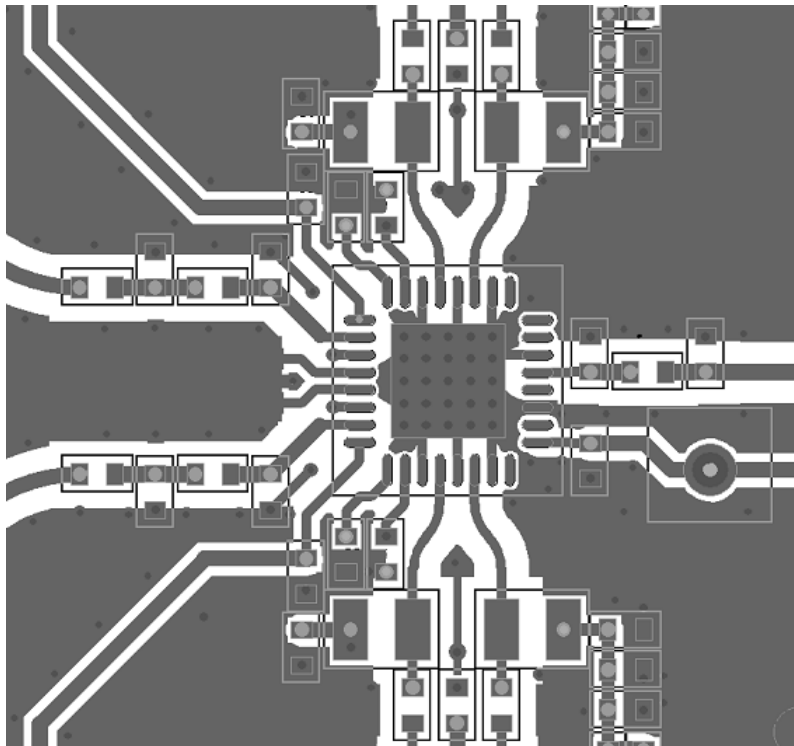

**Figure 78.**

## 12 器件和文档支持

### 12.1 相关链接

以下表格列出了快速访问链接。范围包括技术文档、支持与社区资源、工具和软件，并且可以快速访问样片或购买链接。

表 4. 相关链接

器件	产品文件夹	样片与购买	技术文档	工具与软件	支持与社区
TRF37A32	<a href="#">请单击此处</a>	<a href="#">请单击此处</a>	<a href="#">请单击此处</a>	<a href="#">请单击此处</a>	<a href="#">请单击此处</a>
TRF37B32	<a href="#">请单击此处</a>	<a href="#">请单击此处</a>	<a href="#">请单击此处</a>	<a href="#">请单击此处</a>	<a href="#">请单击此处</a>
TRF37C32	<a href="#">请单击此处</a>	<a href="#">请单击此处</a>	<a href="#">请单击此处</a>	<a href="#">请单击此处</a>	<a href="#">请单击此处</a>

### 12.2 商标

PowerPAD is a trademark of Texas Instruments.  
 All other trademarks are the property of their respective owners.

### 12.3 静电放电警告



这些装置包含有限的内置 ESD 保护。存储或装卸时，应将导线一起截短或将装置放置于导电泡棉中，以防止 MOS 门极遭受静电损伤。

### 12.4 术语表

[SLYZ022](#) — TI 术语表。

这份术语表列出并解释术语、首字母缩略词和定义。

## 13 机械、封装和可订购信息

以下页中包括机械、封装和可订购信息。 这些信息是针对指定器件可提供的最新数据。 这些数据会在无通知且不对本文档进行修订的情况下发生改变。 欲获得该数据表的浏览器版本，请查阅左侧的导航栏。

**PACKAGING INFORMATION**

Orderable part number	Status (1)	Material type (2)	Package   Pins	Package qty   Carrier	RoHS (3)	Lead finish/ Ball material (4)	MSL rating/ Peak reflow (5)	Op temp (°C)	Part marking (6)
<a href="#">TRF37A32IRTVR</a>	Active	Production	WQFN (RTV)   32	3000   LARGE T&R	Yes	NIPDAUAG	Level-2-260C-1 YEAR	-40 to 85	TR37A32 IRTV
TRF37A32IRTVR.A	Active	Production	WQFN (RTV)   32	3000   LARGE T&R	Yes	NIPDAUAG	Level-2-260C-1 YEAR	-40 to 85	TR37A32 IRTV
<a href="#">TRF37A32IRTVT</a>	Active	Production	WQFN (RTV)   32	250   SMALL T&R	Yes	NIPDAUAG	Level-2-260C-1 YEAR	-40 to 85	TR37A32 IRTV
TRF37A32IRTVT.A	Active	Production	WQFN (RTV)   32	250   SMALL T&R	Yes	NIPDAUAG	Level-2-260C-1 YEAR	-40 to 85	TR37A32 IRTV
<a href="#">TRF37B32IRTVR</a>	Active	Production	WQFN (RTV)   32	3000   LARGE T&R	Yes	NIPDAUAG	Level-2-260C-1 YEAR	-40 to 85	TR37B32 IRTV
TRF37B32IRTVR.A	Active	Production	WQFN (RTV)   32	3000   LARGE T&R	Yes	NIPDAUAG	Level-2-260C-1 YEAR	-40 to 85	TR37B32 IRTV
<a href="#">TRF37B32IRTVT</a>	Active	Production	WQFN (RTV)   32	250   SMALL T&R	Yes	NIPDAUAG	Level-2-260C-1 YEAR	-40 to 85	TR37B32 IRTV
TRF37B32IRTVT.A	Active	Production	WQFN (RTV)   32	250   SMALL T&R	Yes	NIPDAUAG	Level-2-260C-1 YEAR	-40 to 85	TR37B32 IRTV
<a href="#">TRF37C32IRTVR</a>	Active	Production	WQFN (RTV)   32	3000   LARGE T&R	Yes	NIPDAUAG	Level-2-260C-1 YEAR	-40 to 85	TR37C32 IRTV
TRF37C32IRTVR.A	Active	Production	WQFN (RTV)   32	3000   LARGE T&R	Yes	NIPDAUAG	Level-2-260C-1 YEAR	-40 to 85	TR37C32 IRTV
<a href="#">TRF37C32IRTVT</a>	Active	Production	WQFN (RTV)   32	250   SMALL T&R	Yes	NIPDAUAG	Level-2-260C-1 YEAR	-40 to 85	TR37C32 IRTV
TRF37C32IRTVT.A	Active	Production	WQFN (RTV)   32	250   SMALL T&R	Yes	NIPDAUAG	Level-2-260C-1 YEAR	-40 to 85	TR37C32 IRTV

(1) **Status:** For more details on status, see our [product life cycle](#).

(2) **Material type:** When designated, preproduction parts are prototypes/experimental devices, and are not yet approved or released for full production. Testing and final process, including without limitation quality assurance, reliability performance testing, and/or process qualification, may not yet be complete, and this item is subject to further changes or possible discontinuation. If available for ordering, purchases will be subject to an additional waiver at checkout, and are intended for early internal evaluation purposes only. These items are sold without warranties of any kind.

(3) **RoHS values:** Yes, No, RoHS Exempt. See the [TI RoHS Statement](#) for additional information and value definition.

(4) **Lead finish/Ball material:** Parts may have multiple material finish options. Finish options are separated by a vertical ruled line. Lead finish/Ball material values may wrap to two lines if the finish value exceeds the maximum column width.

(5) **MSL rating/Peak reflow:** The moisture sensitivity level ratings and peak solder (reflow) temperatures. In the event that a part has multiple moisture sensitivity ratings, only the lowest level per JEDEC standards is shown. Refer to the shipping label for the actual reflow temperature that will be used to mount the part to the printed circuit board.

(6) **Part marking:** There may be an additional marking, which relates to the logo, the lot trace code information, or the environmental category of the part.

Multiple part markings will be inside parentheses. Only one part marking contained in parentheses and separated by a "~" will appear on a part. If a line is indented then it is a continuation of the previous line and the two combined represent the entire part marking for that device.

**Important Information and Disclaimer:** The information provided on this page represents TI's knowledge and belief as of the date that it is provided. TI bases its knowledge and belief on information provided by third parties, and makes no representation or warranty as to the accuracy of such information. Efforts are underway to better integrate information from third parties. TI has taken and continues to take reasonable steps to provide representative and accurate information but may not have conducted destructive testing or chemical analysis on incoming materials and chemicals. TI and TI suppliers consider certain information to be proprietary, and thus CAS numbers and other limited information may not be available for release.

In no event shall TI's liability arising out of such information exceed the total purchase price of the TI part(s) at issue in this document sold by TI to Customer on an annual basis.

**TAPE AND REEL INFORMATION**

**QUADRANT ASSIGNMENTS FOR PIN 1 ORIENTATION IN TAPE**

\*All dimensions are nominal

Device	Package Type	Package Drawing	Pins	SPQ	Reel Diameter (mm)	Reel Width W1 (mm)	A0 (mm)	B0 (mm)	K0 (mm)	P1 (mm)	W (mm)	Pin1 Quadrant
TRF37A32IRTVR	WQFN	RTV	32	3000	330.0	12.4	5.3	5.3	1.5	8.0	12.0	Q2
TRF37A32IRTVT	WQFN	RTV	32	250	180.0	12.4	5.3	5.3	1.5	8.0	12.0	Q2
TRF37B32IRTVR	WQFN	RTV	32	3000	330.0	12.4	5.3	5.3	1.5	8.0	12.0	Q2
TRF37B32IRTVT	WQFN	RTV	32	250	180.0	12.4	5.3	5.3	1.5	8.0	12.0	Q2
TRF37C32IRTVR	WQFN	RTV	32	3000	330.0	12.4	5.3	5.3	1.5	8.0	12.0	Q2
TRF37C32IRTVT	WQFN	RTV	32	250	180.0	12.4	5.3	5.3	1.5	8.0	12.0	Q2



**TAPE AND REEL BOX DIMENSIONS**

\*All dimensions are nominal

Device	Package Type	Package Drawing	Pins	SPQ	Length (mm)	Width (mm)	Height (mm)
TRF37A32IRTVR	WQFN	RTV	32	3000	350.0	350.0	43.0
TRF37A32IRTVT	WQFN	RTV	32	250	210.0	185.0	35.0
TRF37B32IRTVR	WQFN	RTV	32	3000	350.0	350.0	43.0
TRF37B32IRTVT	WQFN	RTV	32	250	210.0	185.0	35.0
TRF37C32IRTVR	WQFN	RTV	32	3000	350.0	350.0	43.0
TRF37C32IRTVT	WQFN	RTV	32	250	210.0	185.0	35.0

RTV (S-PWQFN-N32)

PLASTIC QUAD FLATPACK NO-LEAD



4206245/C 10/11

- NOTES:
- All linear dimensions are in millimeters. Dimensioning and tolerancing per ASME Y14.5-1994.
  - This drawing is subject to change without notice.
  - Quad Flatpack, No-Leads (QFN) package configuration.
  - The package thermal pad must be soldered to the board for thermal and mechanical performance.
  - See the additional figure in the Product Data Sheet for details regarding the exposed thermal pad features and dimensions.
  - Falls within JEDEC MO-220.

RTV (S-PWQFN-N32)

PLASTIC QUAD FLATPACK NO-LEAD

## THERMAL INFORMATION

This package incorporates an exposed thermal pad that is designed to be attached directly to an external heatsink. The thermal pad must be soldered directly to the printed circuit board (PCB). After soldering, the PCB can be used as a heatsink. In addition, through the use of thermal vias, the thermal pad can be attached directly to the appropriate copper plane shown in the electrical schematic for the device, or alternatively, can be attached to a special heatsink structure designed into the PCB. This design optimizes the heat transfer from the integrated circuit (IC).

For information on the Quad Flatpack No-Lead (QFN) package and its advantages, refer to Application Report, QFN/SON PCB Attachment, Texas Instruments Literature No. SLUA271. This document is available at [www.ti.com](http://www.ti.com).

The exposed thermal pad dimensions for this package are shown in the following illustration.

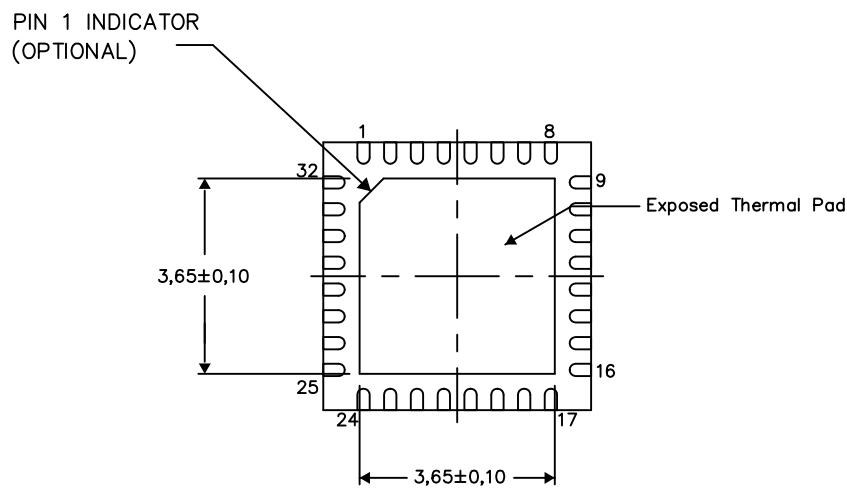

Bottom View

Exposed Thermal Pad Dimensions

4206250-7/Q 05/15

NOTE: All linear dimensions are in millimeters

## 重要通知和免责声明

TI“按原样”提供技术和可靠性数据（包括数据表）、设计资源（包括参考设计）、应用或其他设计建议、网络工具、安全信息和其他资源，不保证没有瑕疵且不做任何明示或暗示的担保，包括但不限于对适销性、与某特定用途的适用性或不侵犯任何第三方知识产权的暗示担保。

这些资源可供使用 TI 产品进行设计的熟练开发人员使用。您将自行承担以下全部责任：(1) 针对您的应用选择合适的 TI 产品，(2) 设计、验证并测试您的应用，(3) 确保您的应用满足相应标准以及任何其他安全、安保法规或其他要求。

这些资源如有变更，恕不另行通知。TI 授权您仅可将这些资源用于研发本资源所述的 TI 产品的相关应用。严禁以其他方式对这些资源进行复制或展示。您无权使用任何其他 TI 知识产权或任何第三方知识产权。对于因您对这些资源的使用而对 TI 及其代表造成的任何索赔、损害、成本、损失和债务，您将全额赔偿，TI 对此概不负责。

TI 提供的产品受 [TI 销售条款](#)、[TI 通用质量指南](#) 或 [ti.com](#) 上其他适用条款或 TI 产品随附的其他适用条款的约束。TI 提供这些资源并不会扩展或以其他方式更改 TI 针对 TI 产品发布的适用的担保或担保免责声明。除非德州仪器 (TI) 明确将某产品指定为定制产品或客户特定产品，否则其产品均为按确定价格收入目录的标准通用器件。

TI 反对并拒绝您可能提出的任何其他或不同的条款。

版权所有 © 2025，德州仪器 (TI) 公司

最后更新日期：2025 年 10 月