

TUSB1046A-DCI USB Type-C™ DisplayPort™ 交替模式 10Gbps 线性转接驱动器交叉点开关

1 特性

- USB Type-C™交叉点开关支持
 - USB 3.1 SSP + 2 条 DisplayPort 信道
 - 4 条 DisplayPort™信道
- USB 3.1 Gen 1/Gen 2 高达 10Gbps
- DisplayPort 1.4 高达 8.1Gbps (HBR3)
- VESA®支持 c、d、e 和 f 配置的 DisplayPort 交替模式 DFP 转接驱动交叉点开关
- 超低功耗架构
- 具有高达 14dB 均衡功能的线性转接驱动器
- 透明呈现 DisplayPort 链路训练
- 自动 LFPS 去加重控制，满足 USB 3.1 认证要求
- 可通过 GPIO 或 I²C 进行配置
- 基于 USB Type-C 的 Intel 专有 DCI 功能，可实现不开箱调试
- 支持热插拔
- 工业级温度范围：-40°C 至 85°C (TUSB1046AI-DCI)
- 商业级温度范围：0°C 至 70°C (TUSB1046-DCI)
- 4mm x 6mm、0.4mm 间距 WQFN 封装

2 应用

- 平板电脑
- 笔记本电脑
- 台式机
- 扩展坞

3 说明

TUSB1046A-DCI 是一种 VESA USB Type-C™ 交替模式转接驱动开关，对于下行端口（主机），支持高达 10Gbps 的 USB 3.1 数据速率以及高达 8.1Gbps 的 DisplayPort 1.4 数据速率。这款 VESA DisplayPort Alt 模式器件支持基于 USB Type-C 标准 1.1 版本的配置 C、D、E 和 F。此线性转接驱动器与协议无关，并且还支持其他 USB Type-C Alt 模式接口。

TUSB1046A-DCI 提供多个接收线性均衡级别，用于补偿由于线缆或电路板走线损耗而产生的码间串扰 (ISI)。该器件由 3.3V 单电源供电运行，支持商业级温度范围和工业级温度范围。

器件信息⁽¹⁾

器件型号	封装	封装尺寸 (标称值)
TUSB1046A-DCI	WQFN (40)	4.00mm x 6.00mm
TUSB1046AI-DCI		

(1) 如需了解所有可用封装，请参阅数据表末尾的可订购产品附录。

简化电路原理图

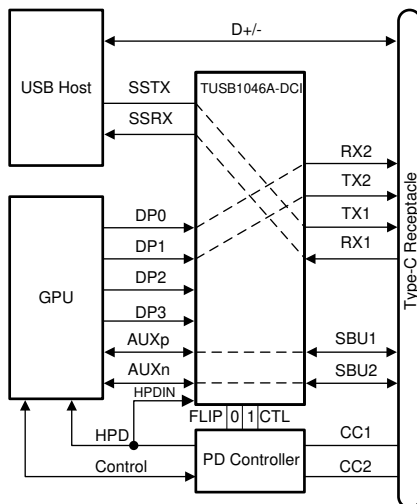

Copyright © 2017, Texas Instruments Incorporated

TUSB1046A-DCI 眼图

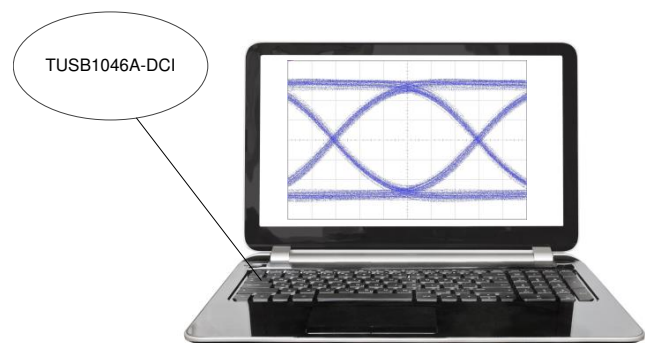

目录

1	特性	1	8.3	Feature Description	16
2	应用	1	8.4	Device Functional Modes	17
3	说明	1	8.5	Programming	22
4	修订历史记录	2	8.6	Register Maps	24
5	Pin Configuration and Functions	3	9	Application and Implementation	29
6	Specifications	5	9.1	Application Information	29
6.1	Absolute Maximum Ratings	5	9.2	Typical Application	29
6.2	ESD Ratings	5	9.3	System Examples	33
6.3	Recommended Operating Conditions	5	10	Power Supply Recommendations	38
6.4	Thermal Information	5	11	Layout	39
6.5	Power Supply Characteristics	6	11.1	Layout Guidelines	39
6.6	DC Electrical Characteristics	6	11.2	Layout Example	39
6.7	AC Electrical Characteristics	7	12	器件和文档支持	40
6.8	DCI Specific Electrical Characteristics	8	12.1	相关链接	40
6.9	Timing Requirements	9	12.2	接收文档更新通知	40
6.10	Switching Characteristics	9	12.3	社区资源	40
6.11	Typical Characteristics	10	12.4	商标	40
7	Parameter Measurement Information	12	12.5	静电放电警告	40
8	Detailed Description	14	12.6	术语表	40
8.1	Overview	14	13	机械、封装和可订购信息	40
8.2	Functional Block Diagram	15			

4 修订历史记录

Changes from Revision A (April 2018) to Revision B	Page
• Added following to pin 11 description: If I2C_EN = "F", then this pin must be set to "F" or "0".	4

Changes from Original (June 2017) to Revision A	Page
• Changed the appearance of the pinout image in the <i>Pin Configuration and Function</i> section	3
• Added Note 1 to the <i>Pin Functions</i> table	3
• Changed the USB3.1 Control/Status Registers reset value From: 00000000 To: 00000100	28
• Changed the Reset value of bit 3:2 From: 00 To: 01 in Table 18	28

5 Pin Configuration and Functions

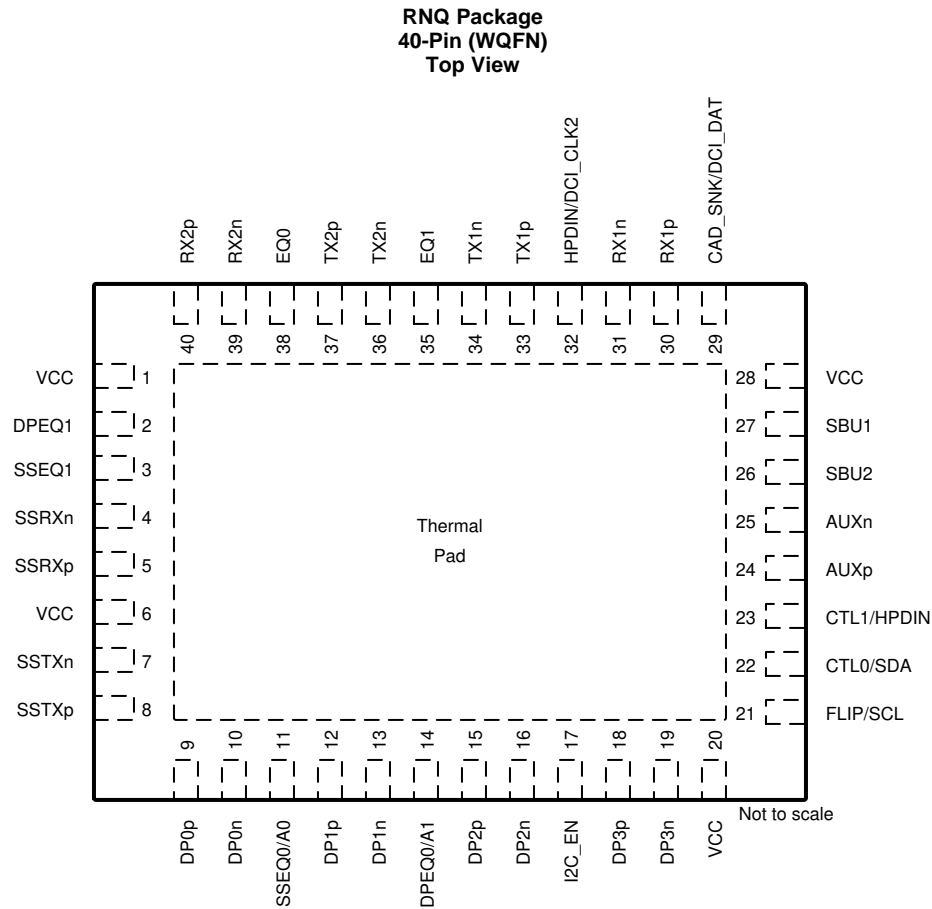

Pin Functions

PIN		I/O	DESCRIPTION
NAME	NO.		
DP0p	9	Diff I	DP Differential positive input for DisplayPort Lane 0.
DP0n	10	Diff I	DP Differential negative input for DisplayPort Lane 0.
DP1p	12	Diff I	DP Differential positive input for DisplayPort Lane 1.
DP1n	13	Diff I	DP Differential negative input for DisplayPort Lane 1.
DP2p	15	Diff I	DP Differential positive input for DisplayPort Lane 2.
DP2n	16	Diff I	DP Differential negative input for DisplayPort Lane 2.
DP3p	18	Diff I	DP Differential positive input for DisplayPort Lane 3.
DP3n	19	Diff I	DP Differential negative input for DisplayPort Lane 3.
RX1n	31	Diff I/O	Differential negative output for DisplayPort or differential negative input for USB3.1 Downstream Facing port.
RX1p	30	Diff I/O	Differential positive output for DisplayPort or differential positive input for USB3.1 Downstream Facing port.
TX1n	34	Diff O	Differential negative output for DisplayPort or USB3.1 downstream facing port.
TX1p	33	Diff O	Differential positive output for DisplayPort or USB 3.1 downstream facing port.
TX2p	37	Diff O	Differential positive output for DisplayPort or USB 3.1 downstream facing port.
TX2n	36	Diff O	Differential negative output for DisplayPort or USB 3.1 downstream facing port.
RX2p	40	Diff I/O	Differential positive output for DisplayPort or differential positive input for USB3.1 Downstream Facing port.
RX2n	39	Diff I/O	Differential negative output for DisplayPort or differential negative input for USB3.1 Downstream Facing port.

Pin Functions (continued)

PIN		I/O	DESCRIPTION
NAME	NO.		
SSTXp	8	Diff I	Differential positive input for USB3.1 upstream facing port.
SSTXn	7	Diff I	Differential negative input for USB3.1 upstream facing port.
SSRXp	5	Diff O	Differential positive output for USB3.1 upstream facing port.
SSRXn	4	Diff O	Differential negative output for USB3.1 upstream facing port.
EQ1	35	4 Level I	This pin along with EQ0 sets the USB receiver equalizer gain for downstream facing RX1 and RX2 when USB used.
EQ0	38	4 Level I	This pin along with EQ1 sets the USB receiver equalizer gain for downstream facing RX1 and RX2 when USB used.
CAD_SNK/DCI_DAT ⁽¹⁾	29	I/O (PD)	When I2C_EN != 0, this pin functions as DCI data output Leave open if not used. When I2C_EN = 0, this pin is CAD_SNK (L = AUX snoop enabled and H = AUX snoop disabled with all lanes active).
HPDIN/DCI_CLK ⁽¹⁾	32	I/O (PD)	When I2C_EN != 0, this pin functions as DCI clock output Leave open if not used. When I2C_EN = 0, this pin is an input for Hot Plug Detect received from DisplayPort sink. When HPDIN is Low for greater than 2ms, all DisplayPort lanes are disabled while the AUX to SBU switch will remain closed.
I2C_EN	17	4 Level I	I ² C Programming Mode or GPIO Programming Select. I2C is only disabled when this pin is '0'. 0 = GPIO mode (I ² C disabled) R = TI Test Mode (I ² C enabled at 3.3 V) F = I ² C enabled at 1.8 V 1 = I ² C enabled at 3.3 V.
SBU1	27	I/O, CMOS	SBU1. This pin should be DC coupled to the SBU1 pin on the Type-C receptacle. A 2-M ohm resistor to GND is also recommended.
SBU2	26	I/O, CMOS	SBU2. This pin should be DC coupled to the SBU2 pin on the Type-C receptacle. A 2-M ohm resistor to GND is also recommended.
AUXp	24	I/O, CMOS	AUXp. DisplayPort AUX positive I/O connected to the DisplayPort source through a AC coupling capacitor. In addition to AC coupling capacitor, this pin also requires a 100K resistor to GND. This pin along with AUXN is used by the TUSB1046A-DCI for AUX snooping and is routed to SBU1/2 based on the orientation of the Type-C.
AUXn	25	I/O, CMOS	AUXn. DisplayPort AUX negative I/O connected to the DisplayPort source through a AC coupling capacitor. In addition to AC coupling capacitor, this pin also requires a 100K resistor to DP_PWR (3.3V). This pin along with AUXP is used by the TUSB1046A-DCI for AUX snooping and is routed to SBU1/2 based on the orientation of the Type-C.
DPEQ1	2	4 Level I	DisplayPort Receiver EQ. This along with DPEQ0 will select the DisplayPort receiver equalization gain.
DPEQ0/A1	14	4 Level I	DisplayPort Receiver EQ. This along with DPEQ1 will select the DisplayPort receiver equalization gain. When I2C_EN is not '0', this pin will also set the TUSB1046A-DCI I ² C address.
SSEQ1	3	4 Level I	Along with SSEQ0, sets the USB receiver equalizer gain for upstream facing SSTXP/N.
SSEQ0/A0	11	4 Level I	Along with SSEQ1, sets the USB receiver equalizer gain for upstream facing SSTXP/N. When I2C_EN is not '0', this pin will also set the TUSB1046A-DCI I ² C address. If I2C_EN = "F", then this pin must be set to "F" or "0".
FLIP/SCL	21	2 Level I	When I2C_EN='0' this is Flip control pin, otherwise this pin is I ² C clock. . When used for I ² C clock pullup to I ² C master's VCC I2C supply.
CTL0/SDA	22	2 Level I	When I2C_EN='0' this is a USB3.1 Switch control pin, otherwise this pin is I ² C data. When used for I ² C data pullup to I ² C master's VCC I2C supply.
CTL1/HPDIN	23	2 Level I (Failsafe) (PD)	DP Alt mode Switch Control Pin. When I2C_EN = '0', this pin will enable or disable DisplayPort functionality. Otherwise, when I2C_EN is not "0", DisplayPort functionality is enabled and disabled through I ² C registers. L = DisplayPort Disabled. H = DisplayPort Enabled. When I2C_EN is not "0" this pin is an input for Hot Plug Detect received from DisplayPort sink. When this HPDIN is Low for greater than 2 ms, all DisplayPort lanes are disabled and AUX to SBU switch will remain closed.
VCC	1, 6, 20, 28	P	3.3-V Power Supply
Thermal Pad		G	Ground

(1) Not a fail-safe I/O. Actively driving pin high while VCC is removed results in leakage voltage on VCC pins.

6 Specifications

6.1 Absolute Maximum Ratings

over operating free-air temperature range (unless otherwise noted)⁽¹⁾

		MIN	MAX	UNIT
Supply Voltage Range ⁽²⁾ , V_{CC}		-0.3	4	V
Voltage Range at any input or output pin	Differential voltage between positive and negative inputs		±2.5	V
	Voltage at differential inputs	-0.5	$V_{CC} + 0.5$	V
	CMOS Inputs	-0.5	$V_{CC} + 0.5$	V
Maximum junction temperature, T_J			125	°C
Storage temperature, T_{stg}		-65	150	°C

- (1) Stresses beyond those listed under *Absolute Maximum Ratings* may cause permanent damage to the device. These are stress ratings only, which do not imply functional operation of the device at these or any other conditions beyond those indicated under *Recommended Operating Conditions*. Exposure to absolute-maximum-rated conditions for extended periods may affect device reliability.
- (2) All voltage values are with respect to the GND terminals.

6.2 ESD Ratings

		VALUE	UNIT
$V_{(ESD)}$ Electrostatic discharge	Human-body model (HBM), per ANSI/ESDA/JEDEC JS-001 ⁽¹⁾	±5000	V
	Charged-device model (CDM), per JEDEC specification JESD22-C101 ⁽²⁾	±1500	

- (1) JEDEC document JEP155 states that 500-V HBM allows safe manufacturing with a standard ESD control process.
- (2) JEDEC document JEP157 states that 250-V CDM allows safe manufacturing with a standard ESD control process.

6.3 Recommended Operating Conditions

over operating free-air temperature range (unless otherwise noted)

		MIN	NOM	MAX	UNIT
V_{CC}	Main power supply	3	3.3	3.6	V
	Supply Ramp Requirement			100	ms
$V_{(12C)}$	Supply that external resistors are pulled up to on SDA and SCL	1.7		3.6	V
$V_{(PSN)}$	Supply Noise on V_{CC} pins			100	mV
T_A	Operating free-air temperature	TUSB1046A-DCI	0	70	°C
		TUSB1046AI-DCI	-40	85	°C

6.4 Thermal Information

THERMAL METRIC ⁽¹⁾		TUSB1046A-DCI	UNIT
		RNQ (WQFN)	
		40 PINS	
$R_{\theta JA}$	Junction-to-ambient thermal resistance	37.6	°C/W
$R_{\theta JC(top)}$	Junction-to-case (top) thermal resistance	20.7	°C/W
$R_{\theta JB}$	Junction-to-board thermal resistance	9.5	°C/W
Ψ_{JT}	Junction-to-top characterization parameter	0.2	°C/W
Ψ_{JB}	Junction-to-board characterization parameter	9.4	°C/W
$R_{\theta JC(bot)}$	Junction-to-case (bottom) thermal resistance	2.3	°C/W

- (1) For more information about traditional and new thermal metrics, see the [Semiconductor and IC Package Thermal Metrics](#) application report.

6.5 Power Supply Characteristics

over operating free-air temperature range (unless otherwise noted)

PARAMETER		TEST CONDITIONS	MIN	TYP	MAX	UNIT
$P_{CC(ACTIVE-USB)}$	Average active power USB Only	Link in U0 with GEN2 data transmission. EN, EQ cntrl pins = NC, k28.5 pattern at 10 Gbps, $V_{ID} = 1000$ mV _{PP} ; CTL1 = L; CTL0 = H		335		mW
$P_{CC(ACTIVE-USB-DP1)}$	Average active power USB + 2 Lane DP	Link in U0 with GEN2 data transmission. EN, EQ cntrl pins = NC, k28.5 pattern at 10 Gbps, $V_{ID} = 1000$ mV _{PP} ; CTL1 = H; CTL0 = H		634		mW
$P_{CC(ACTIVE-DP)}$	Average active power 4 Lane DP Only	Four active DP lanes operating at 8.1Gbps; CTL1 = H; CTL0 = L;		660		mW
$P_{CC(NC-USB)}$	Average power with no connection	No GEN1 device is connected to TXP/TXN; CTL1 = L; CTL0 = H;		2.4		mW
$P_{CC(U2U3)}$	Average power in U2/U3	Link in U2 or U3 USB Mode Only; CTL1 = L; CTL0 = H;		3		mW
$P_{CC(SHUTDOWN)}$	Device Shutdown	CTL1 = L; CTL0 = L; I2C_EN = 0;		0.85		mW

6.6 DC Electrical Characteristics

over operating free-air temperature range (unless otherwise noted)

PARAMETER		TEST CONDITIONS	MIN	TYP	MAX	UNIT
4-State CMOS Inputs(EQ[1:0], SSEQ[1:0], DPEQ[1:0], I2C_EN)						
I_{IH}	High level input current	$V_{CC} = 3.6$ V; $V_{IN} = 3.6$ V	20		80	μ A
I_{IL}	Low level input current	$V_{CC} = 3.6$ V; $V_{IN} = 0$ V	-160		-40	μ A
4-Level V_{TH}	Threshold 0 / R	$V_{CC} = 3.3$ V		0.55		V
	Threshold R/ Float	$V_{CC} = 3.3$ V		1.65		V
	Threshold Float / 1	$V_{CC} = 3.3$ V		2.7		V
R_{PU}	Internal pull-up resistance			35		k Ω
R_{PD}	Internal pull-down resistance			95		k Ω
2-State CMOS Input (CTL0, CTL1, FLIP, CAD_SNK, HPDIN) CTL1, CTL0 and FLIP are Failsafe.						
V_{IH}	High-level input voltage		2		3.6	V
V_{IL}	Low-level input voltage		0		0.8	V
R_{PD}	Internal pull-down resistance for CTL1			500		k Ω
$R_{(ENPD)}$	Internal pull-down resistance for CAD_SNK (pin 29), and HPDIN (pin 32)			150		k Ω
I_{IH}	High-level input current	$V_{IN} = 3.6$ V	-25		25	μ A
I_{IL}	Low-level input current	$V_{IN} = GND$, $V_{CC} = 3.6$ V	-25		25	μ A
I²C Control Pins SCL, SDA						
V_{IH}	High-level input voltage	I2C_EN = 0	$0.7 \times V_{(I2C)}$		3.6	V
V_{IL}	Low-level input voltage	I2C_EN = 0	0	$0.3 \times V_{(I2C)}$		V
V_{OL}	Low-level output voltage	I2C_EN = 0; $I_{OL} = 3$ mA	0		0.4	V
I_{OL}	Low-level output current	I2C_EN = 0; $V_{OL} = 0.4$ V	20			mA
$I_{I(I2C)}$	Input current on SDA pin	$0.1 \times V_{(I2C)} < \text{Input voltage} < 3.3$ V	-10		10	μ A
$C_{I(I2C)}$	Input capacitance				10	pF
$C_{(I2C_FM+_BUS)}$	I2C bus capacitance for FM+ (1MHz)				150	pF
$C_{(I2C_FM_BUS)}$	I2C bus capacitance for FM (400kHz)				150	pF
$R_{(EXT_I2C_FM+)}$	External resistors on both SDA and SCL when operating at FM+ (1MHz)	$C_{(I2C_FM+_BUS)} = 150$ pF	620	820	910	Ω
$R_{(EXT_I2C_FM)}$	External resistors on both SDA and SCL when operating at FM (400kHz)	$C_{(I2C_FM_BUS)} = 150$ pF	620	1500	2200	Ω

6.7 AC Electrical Characteristics

over operating free-air temperature range (unless otherwise noted)

PARAMETER		TEST CONDITIONS	MIN	TYP	MAX	UNIT
USB Gen 2 Differential Receiver (RX1P/N, RX2P/N, SSTXP/N)						
$V_{(RX-DIFF-PP)}$	Input differential peak-peak voltage swing linear dynamic range	AC-coupled differential peak-to-peak signal measured post CTLE through a reference channel		2000		mVpp
$V_{(RX-DC-CM)}$	Common-mode voltage bias in the receiver (DC)			0		V
$R_{(RX-DIFF-DC)}$	Differential input impedance (DC)	Present after a GEN2 device is detected on TXP/TXN	72		120	Ω
$R_{(RX-CM-DC)}$	Receiver DC common mode impedance	Present after a GEN2 device is detected on TXP/TXN	18		30	Ω
$Z_{(RX-HIGH-IMP-DC-POS)}$	Common-mode input impedance with termination disabled (DC)	Present when no GEN2 device is detected on TXP/TXN. Measured over the range of 0-500mV with respect to GND.	25			k Ω
$V_{(SIGNAL-DET-DIFF-PP)}$	Input differential peak-to-peak signal detect assert level	At 10 Gbps, no input loss, PRBS7 pattern		80		mV
$V_{(RX-IDLE-DET-DIFF-PP)}$	Input differential peak-to-peak signal detect de-assert Level	At 10 Gbps, no input loss, PRBS7 pattern		60		mV
$V_{(RX-LFPS-DET-DIFF-PP)}$	Low frequency periodic signaling (LFPS) detect threshold	Below the minimum is squelched	100		300	mV
$V_{(RX-CM-AC-P)}$	Peak RX AC common-mode voltage	Measured at package pin			150	mV
$C_{(RX)}$	RX input capacitance to GND	At 5 GHz		0.5	1	pF
$R_{L(RX-DIFF)}$	Differential return Loss	50 MHz – 1.25 GHz at 90 Ω 5 GHz at 90 Ω		-19 -10		dB dB
$R_{L(RX-CM)}$	Common-mode return loss	50 MHz – 5 GHz at 90 Ω		-10		dB
$E_{Q(SS_TX)}$	Receiver equalization for upstream facing port	SSEQ[1:0] at 5 GHz		11		dB
$E_{Q(SS_RX)}$	Receiver equalization for downstream facing ports	EQ[1:0] at 5 GHz		9		dB
USB Gen 2 Differential Transmitter (TX1P/N, TX2P/N, SSRXP/N)						
$V_{TX(DIFF-PP)}$	Transmitter dynamic differential voltage swing range.			1600		mVpp
$V_{TX(RCV-DETECT)}$	Amount of voltage change allowed during receiver detection				600	mV
$V_{TX(CM-IDLE-DELTA)}$	Transmitter idle common-mode voltage change while in U2/U3 and not actively transmitting LFPS		-600		600	mV
$V_{TX(DC-CM)}$	Common-mode voltage bias in the transmitter (DC)			1.75		V
$V_{TX(CM-AC-PP-ACTIVE)}$	Tx AC common-mode voltage active	Max mismatch from Txp + Txn for both time and amplitude			100	mVpp
$V_{TX(IDLE-DIFF-AC-PP)}$	AC electrical idle differential peak-to-peak output voltage	At package pins	0		10	mV
$V_{TX(IDLE-DIFF-DC)}$	DC electrical idle differential output voltage	At package pins after low pass filter to remove AC component	0		14	mV
$V_{TX(CM-DC-ACTIVE-IDLE-DELTA)}$	Absolute DC common-mode voltage between U1 and U0	At package pin			200	mV
$R_{TX(DIFF)}$	Differential impedance of the driver		75		120	Ω
$C_{AC(COUPLING)}$	AC coupling capacitor		75		265	nF
$R_{TX(CM)}$	Common-mode impedance of the driver	Measured with respect to AC ground over 0–500 mV	18		30	Ω
$I_{TX(SHORT)}$	TX short circuit current	TX \pm shorted to GND			67	mA
$C_{TX(PARASITIC)}$	TX input capacitance for return loss	At package pins, at 5 GHz			1.25	pF
$R_{LTX(DIFF)}$	Differential return loss	50 MHz – 1.25 GHz at 90 Ω 5 GHz at 90 Ω		-15 -13		dB dB
$R_{LTX(CM)}$	Common-mode return loss	50 MHz – 5 GHz at 90 Ω		-13		dB
AC Characteristics						
Crosstalk	Differential crosstalk between TX and RX signal pairs	at 5 GHz		-30		dB
$C_{(P1dB-LF)}$	Low frequency 1-dB compression point	at 100 MHz, 200 mVpp < V_{ID} < 2000 mVpp		1300		mVpp

AC Electrical Characteristics (continued)

over operating free-air temperature range (unless otherwise noted)

PARAMETER		TEST CONDITIONS	MIN	TYP	MAX	UNIT
$C_{(P1dB-HF)}$	High frequency 1-dB compression point	at 5 GHz, $200\text{ mV}_{PP} < V_{ID} < 2000\text{ mV}_{PP}$		1000		mV_{PP}
f_{LF}	Low frequency cutoff	$200\text{ mV}_{PP} < V_{ID} < 2000\text{ mV}_{PP}$		20	50	kHz
	TX output deterministic jitter	$200\text{ mV}_{PP} < V_{ID} < 2000\text{ mV}_{PP}$, PRBS7, 10 Gbps		0.11		U _{lpp}
		$200\text{ mV}_{PP} < V_{ID} < 2000\text{ mV}_{PP}$, PRBS7, 8.1 Gbps		0.08		U _{lpp}
	TX output total jitter	$200\text{ mV}_{PP} < V_{ID} < 2000\text{ mV}_{PP}$, PRBS7, 10 Gbps		0.15		U _{lpp}
		$200\text{ mV}_{PP} < V_{ID} < 2000\text{ mV}_{PP}$, PRBS7, 8.1 Gbps		0.135		U _{lpp}
DisplayPort Receiver (DP[3:0]p or DP[3:0]n)						
$V_{ID(PP)}$	Peak-to-peak input differential dynamic voltage range			2000		V
V_{IC}	Input common mode voltage			0		V
$C_{(AC)}$	AC coupling capacitance		75		200	nF
$E_{Q(DP)}$	Receiver equalization	DPEQ[1:0] at 4.05 GHz			14	dB
d_R	Data rate	HBR3			8.1	Gbps
$R_{(ti)}$	Input termination resistance		80	100	120	Ω
DisplayPort Transmitter (TX1p or TX1n, TX2p or TX2n, RX1p or RX1n, RX2p or RX2n)						
$I_{TX(SHORT)}$	TX short circuit current	TX_{\pm} shorted to GND			67	mA
$V_{TX(DC-CM)}$	Common-mode voltage bias in the transmitter (DC)			1.75		V
AUXp or AUXn and SBU1 or SBU2						
R_{ON}	Output ON resistance	$V_{CC} = 3.3\text{V}$; $V_I = 0$ to 0.4 V for AUXp; $V_I = 2.7\text{ V}$ to 3.6 V for AUXn		5	10	Ω
ΔR_{ON}	ON resistance mismatch within pair	$V_{CC} = 3.3\text{ V}$; $V_I = 0$ to 0.4 V for AUXp; $V_I = 2.7\text{ V}$ to 3.6 V for AUXn			2.5	Ω
$R_{ON(FLAT)}$	ON resistance flatness ($R_{ON\text{ max}} - R_{ON\text{ min}}$) measured at identical VCC and temperature	$V_{CC} = 3.3\text{ V}$; $V_I = 0$ to 0.4 V for AUXp; $V_I = 2.7\text{ V}$ to 3.6 V for AUXn			2	Ω
$V_{(AUXP_DC_CM)}$	AUX Channel DC common mode voltage for AUXp and SBU1.	$V_{CC} = 3.3\text{ V}$	0		0.4	V
$V_{(AUXN_DC_CM)}$	AUX Channel DC common mode voltage for AUXn and SBU2	$V_{CC} = 3.3\text{ V}$	2.7		3.6	V
$C_{(AUX_ON)}$	ON-state capacitance	$V_{CC} = 3.3\text{ V}$; CTL1 = 1; $V_I = 0\text{ V}$ or 3.3 V		4	7	pF
$C_{(AUX_OFF)}$	OFF-state capacitance	$V_{CC} = 3.3\text{ V}$; CTL1 = 0; $V_I = 0\text{ V}$ or 3.3 V		3	6	pF

6.8 DCI Specific Electrical Characteristics

over operating free-air temperature range (unless otherwise noted)

PARAMETER		TEST CONDITIONS	MIN	TYP	MAX	UNIT
DCI_CLK and DCI_DAT LVCMOS Outputs						
V_{OL}	Low-Level output voltage	$V_{CC} = 3\text{ V}$; $I_{OL} = 2\text{ mA}$; $C_L = 10\text{ pF}$			0.45	V
V_{OH}	High-Level output voltage	$V_{CC} = 3\text{ V}$; $I_{OL} = -2\text{ mA}$;	2.4			V
R_{DCI}	Output characteristic impedance		21	25	33	Ω
t_{PERIOD}	DCI Clock period	Measured at 50%	6.67			ns
t_{VALID}	Rising edge of DCI clock to DCI data valid				1	ns
t_{DCI_RISE}	DCI output rise time	Measured at 20% to 80%.	350			ps
t_{DCI_FALL}	DCI output fall time	Measured at 80% to 20%	350			ps

6.9 Timing Requirements

			MIN	NOM	MAX	UNIT
USB Gen 1						
$t_{IDLEEntry}$	Delay from U0 to electrical idle	See Figure 14		10		ns
$t_{IDLEExit_U1}$	U1 exist time: break in electrical idle to the transmission of LFPS	See Figure 14		6		ns
$t_{IDLEExit_U2U3}$	U2/U3 exit time: break in electrical idle to transmission of LFPS			10		μ s
t_{RXDET_INTVL}	RX detect interval while in Disconnect				12	ms
$t_{IDLEExit_DISC}$	Disconnect Exit Time			10		μ s
t_{Exit_SHTDN}	Shutdown Exit Time			1		ms
t_{DIFF_DLY}	Differential Propagation Delay	See Figure 13			300	ps
t_R, t_F	Output Rise/Fall time (see Figure 15)	20%-80% of differential voltage measured 1.7 inch from the output pin		35		ps
t_{RF_MM}	Output Rise/Fall time mismatch	20%-80% of differential voltage measured 1.7 inch from the output pin			2.6	ps

6.10 Switching Characteristics

over operating free-air temperature range (unless otherwise noted)

PARAMETER	TEST CONDITIONS	MIN	TYP	MAX	UNIT
AUXp or AUXn and SBU1 or SBU2					
t_{AUX_PD}	Switch propagation delay			400	ps
$t_{AUX_SW_OFF}$	Switching time CTL1 to switch OFF. Not including TCTL1_DEBOUNCE.			500	ns
$t_{AUX_SW_ON}$	Switching time CTL1 to switch ON			500	ns
t_{AUX_INTRA}	Intra-pair output skew			100	ps
USB3.1 and DisplayPort mode transition requirement GPIO mode					
$t_{GP_USB_4DP}$	Min overlap of CTL0 and CTL1 when transitioning from USB 3.1 only mode to 4-Lane DisplayPort mode or vice versa.	4			μ s
CTL1 and HPDIN					
$t_{CTL1_DEBOUNCE}$	CTL1 and HPDIN debounce time when transitioning from H to L.	2		10	ms
I²C (Refer to Figure 11)					
f_{SCL}	I ² C clock frequency			1	MHz
t_{BUF}	Bus free time between START and STOP conditions	0.5			μ s
t_{HDSTA}	Hold time after repeated START condition. After this period, the first clock pulse is generated	0.26			μ s
t_{LOW}	Low period of the I ² C clock	0.5			μ s
t_{HIGH}	High period of the I ² C clock	0.26			μ s
t_{SUSTA}	Setup time for a repeated START condition	0.26			μ s
t_{HDDAT}	Data hold time	0			μ s
t_{SUDAT}	Data setup time	50			ns
t_R	Rise time of both SDA and SCL signals			120	ns
t_F	Fall time of both SDA and SCL signals		$20 \times (V_{(I2C)}/5.5V)$	120	ns
t_{SUSTO}	Setup time for STOP condition	0.26			μ s
C_b	Capacitive load for each bus line			150	pF

6.11 Typical Characteristics

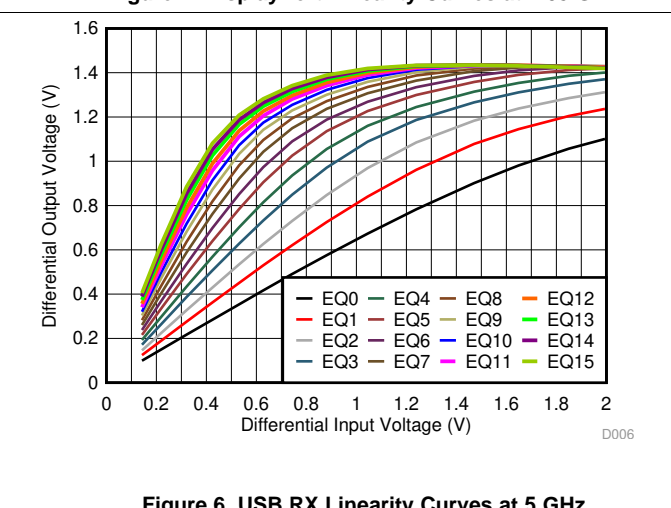
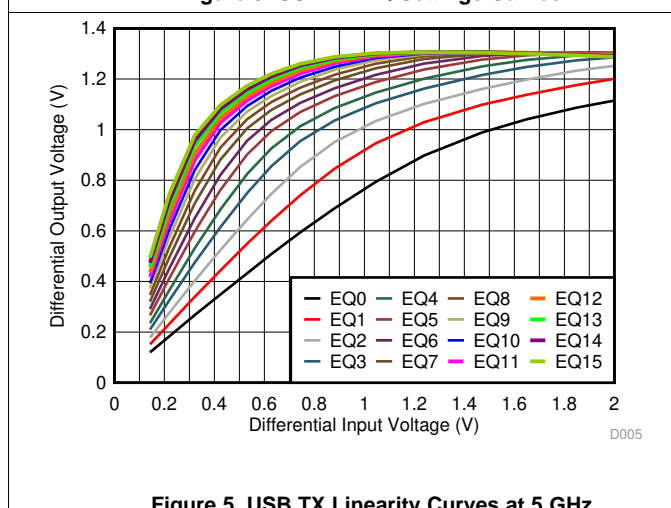
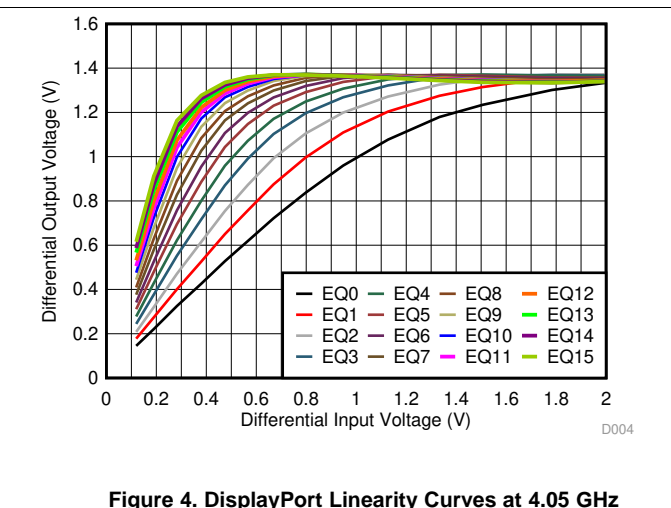
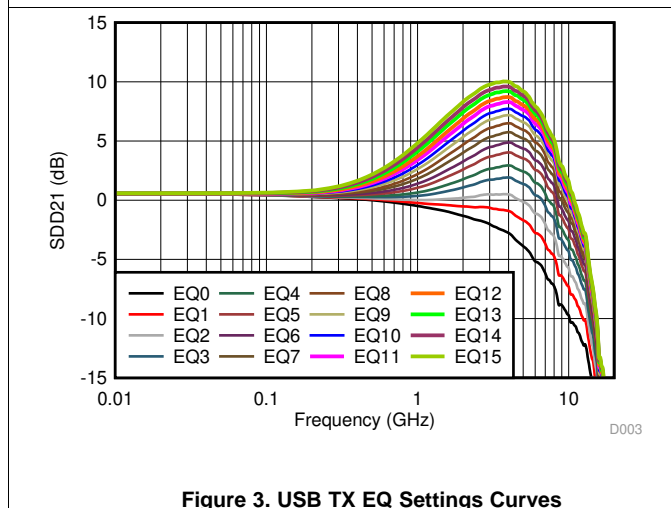
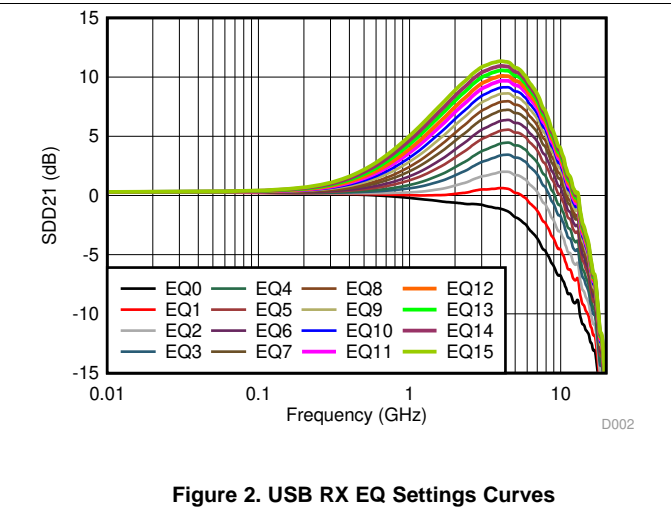
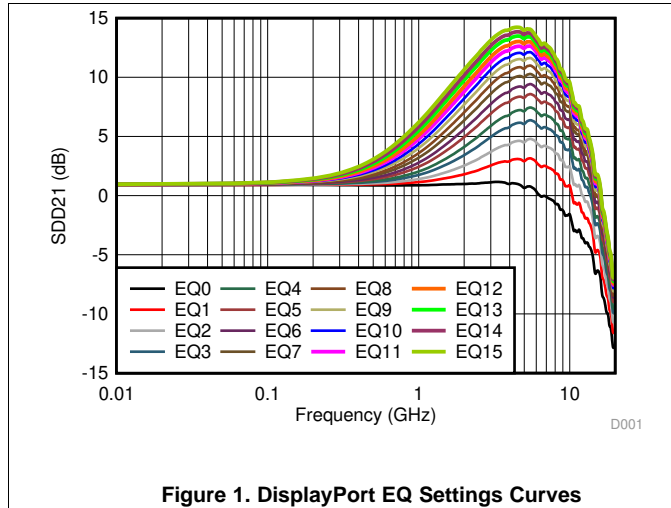

Typical Characteristics (continued)

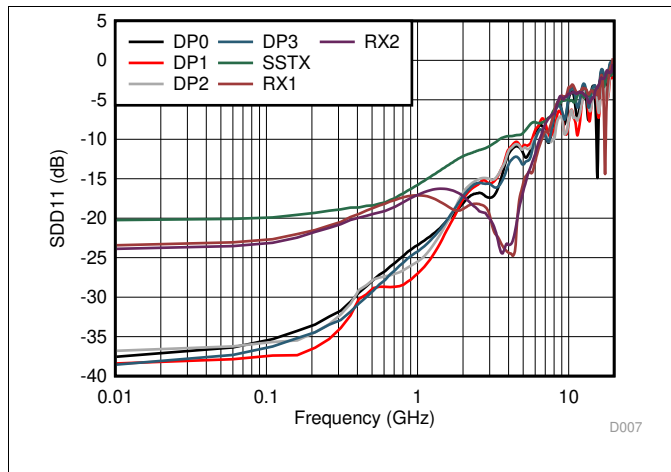

Figure 7. Input Return Loss Performance

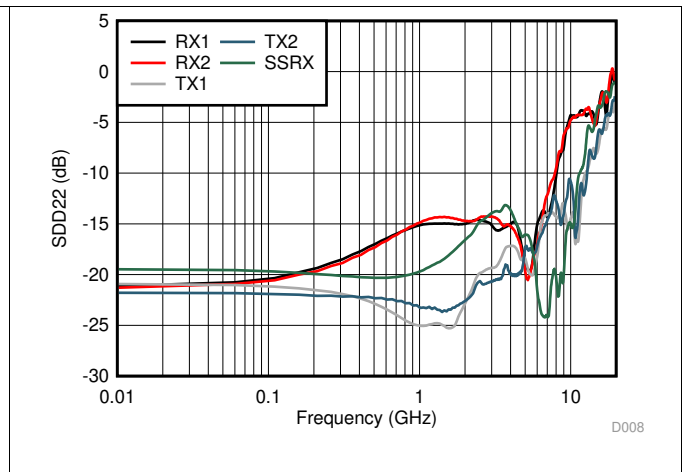

Figure 8. Output Return Loss Performance

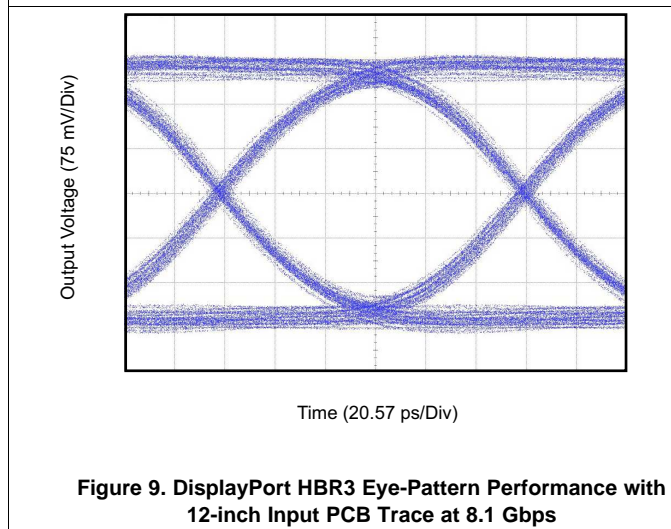

Figure 9. DisplayPort HBR3 Eye-Pattern Performance with 12-inch Input PCB Trace at 8.1 Gbps

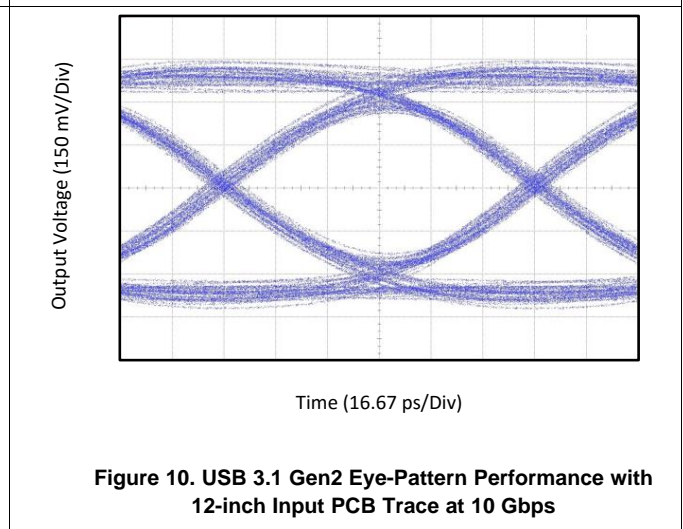

Figure 10. USB 3.1 Gen2 Eye-Pattern Performance with 12-inch Input PCB Trace at 10 Gbps

7 Parameter Measurement Information

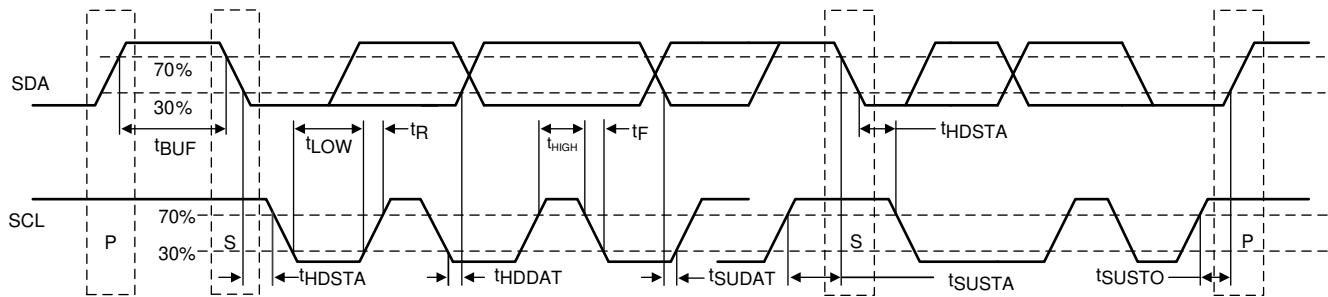

Figure 11. I²C Timing Diagram Definitions

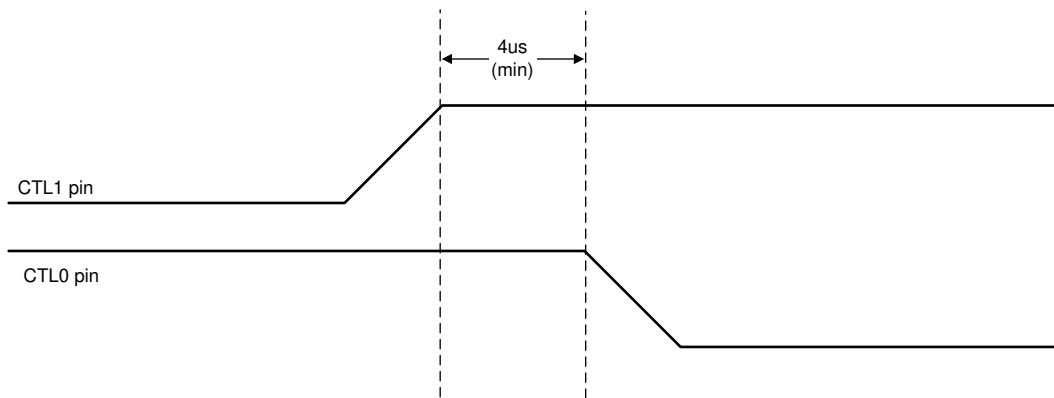

Figure 12. USB3.1 to 4-Lane DisplayPort in GPIO Mode

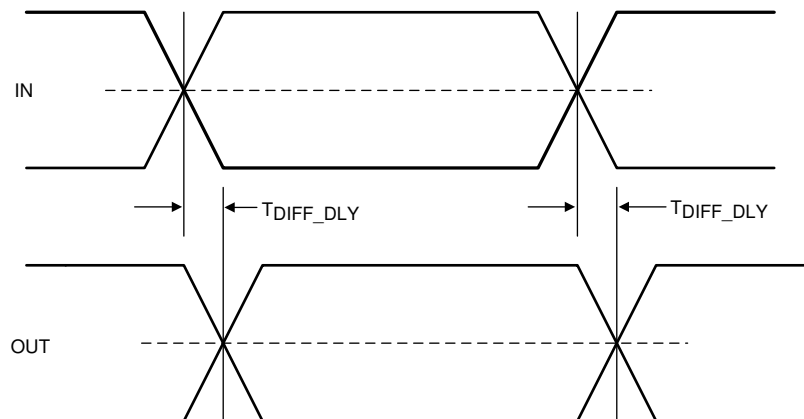

Figure 13. Propagation Delay

Parameter Measurement Information (continued)

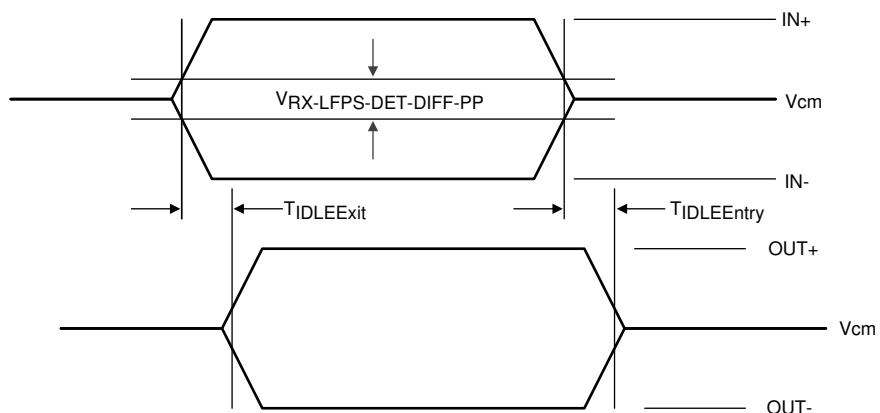

Figure 14. Electrical Idle Mode Exit and Entry Delay

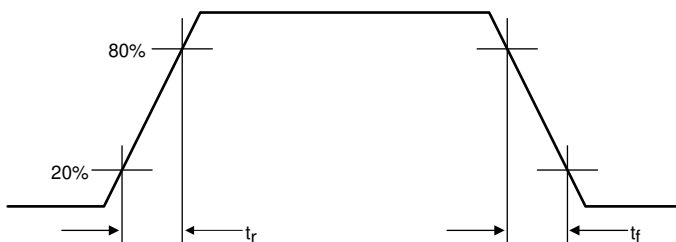

Figure 15. Output Rise and Fall Times

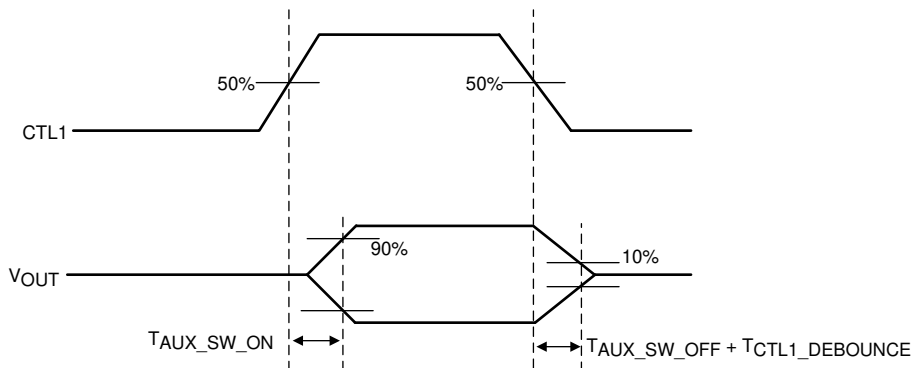

Figure 16. AUX and SBU Switch ON and OFF Timing Diagram

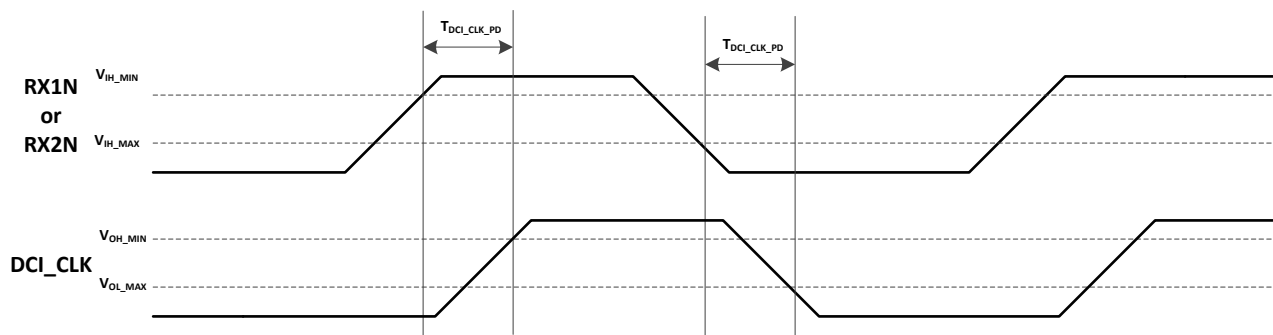

Figure 17. DCI Clock Propagation Delay

8 Detailed Description

8.1 Overview

The TUSB1046A-DCI is a VESA USB Type-C Alt Mode re-driving switch supporting data rates up to 8.1 Gbps for downstream facing port. These devices utilize 5th generation USB re-driver technology. The devices are utilized for DFP configurations C, D, E, and F from the VESA DisplayPort Alt Mode on USB Type-C.

The TUSB1046A-DCI provides several levels of receive equalization to compensate for cable and board trace loss due to inter-symbol interference (ISI) when USB 3.1 Gen1/Gen2 or DisplayPort 1.4 signals travel across a PCB or cable. This device requires a 3.3-V power supply. It comes in a commercial temperature range and industrial temperature range.

For a host application the TUSB1046A-DCI enables the system to pass both transmitter compliance and receiver jitter tolerance tests for USB 3.1 Gen1/Gen2 and DisplayPort version 1.4 HBR3. The re-driver recovers incoming data by applying equalization that compensates for channel loss, and drives out signals with a high differential voltage. Each channel has a receiver equalizer with selectable gain settings. The equalization should be set based on the amount of insertion loss before the TUSB1046A-DCI receivers. Independent equalization control for each channel can be set using EQ[1:0], SSEQ[1:0], and DPEQ[1:0] pins.

The TUSB1046A-DCI advanced state machine makes it transparent to hosts and devices. After power up, the TUSB1046A-DCI periodically performs receiver detection on the TX pairs. If it detects a USB 3.1 Gen1/Gen2 receiver, the RX termination is enabled, and the TUSB1046A-DCI is ready to re-drive.

The device ultra-low-power architecture operates at a 3.3-V power supply and achieves enhanced performance. The automatic LFPS de-emphasis control further enables the system to be USB3.1 compliant.

8.3 Feature Description

8.3.1 USB 3.1

The TUSB1046A-DCI supports USB 3.1 Gen1/Gen2 datarates up to 10 Gbps. The TUSB1046A-DCI supports all the USB defined power states (U0, U1, U2, and U3). Because the TUSB1046A-DCI is a linear redriver, it can't decode USB3.1 physical layer traffic. The TUSB1046A-DCI monitors the actual physical layer conditions like receiver termination, electrical idle, LFPS, and SuperSpeed signaling rate to determine the USB power state of the USB 3.1 interface.

The TUSB1046A-DCI features an intelligent low frequency periodic signaling (LFPS) detector. The LFPS detector automatically senses the low frequency signals and disables receiver equalization functionality. When not receiving LFPS, the TUSB1046A-DCI will enable receiver equalization based on the EQ[1:0] and SSEQ[1:0] pins or values programmed into EQ1_SEL, EQ2_SEL, and SSEQ_SEL registers.

8.3.2 DisplayPort

The TUSB1046A-DCI supports up to 4 DisplayPort lanes at datarates up to 8.1Gbps (HBR3). The TUSB1046A-DCI, when configured in DisplayPort mode, monitors the native AUX traffic as it traverses between DisplayPort source and DisplayPort sink. For the purposes of reducing power, the TUSB1046A-DCI manages the number of active DisplayPort lanes based on the content of the AUX transactions. The TUSB1046A-DCI snoops native AUX writes to DisplayPort sink's DPCD registers 0x00101 (LANE_COUNT_SET) and 0x00600 (SET_POWER_STATE). TUSB1046A-DCI disables/enables lanes based on value written to LANE_COUNT_SET. The TUSB1046A-DCI disables all lanes when SET_POWER_STATE is in the D3. Otherwise active lanes will be based on value of LANE_COUNT_SET.

DisplayPort AUX snooping is enabled by default but can be disabled by changing the AUX_SNOOP_DISABLE register. Once AUX snoop is disabled, management of TUSB1046A-DCI DisplayPort lanes are controlled through various configuration registers. When TUSB1046A-DCI is enabled for GPIO mode (I2C_EN = "0"), the CAD_SNK pin can be used to disable AUX snooping. When CAD_SNK pin is high, the AUX snooping functionality is disabled and all four DisplayPort lanes will be active.

8.3.3 4-level Inputs

The TUSB1046A-DCI has (I2C_EN, EQ[1:0], DPEQ[1:0], and SSEQ[1:0]) 4-level inputs pins that are used to control the equalization gain and place TUSB1046A-DCI into different modes of operation. These 4-level inputs utilize a resistor divider to help set the 4 valid levels and provide a wider range of control settings. There is an internal 30 k Ω pull-up and a 94 k Ω pull-down. These resistors, together with the external resistor connection combine to achieve the desired voltage level.

Table 1. 4-Level Control Pin Settings

LEVEL	SETTINGS
0	Option 1: Tie 1 K Ω 5% to GND. Option 2: Tie directly to GND.
R	Tie 20 K Ω 5% to GND.
F	Float (leave pin open)
1	Option 1: Tie 1 K Ω 5%to V _{CC} . Option 2: Tie directly to V _{CC} .

NOTE

All four-level inputs are latched on rising edge of internal reset. After $t_{\text{cfg_hd}}$, the internal pull-up and pull-down resistors will be isolated in order to save power.

8.3.4 Receiver Linear Equalization

The purpose of receiver equalization is to compensate for channel insertion loss and inter-symbol interference in the system before the input of the TUSB1046A-DCI. The receiver overcomes these losses by attenuating the low frequency components of the signals with respect to the high frequency components. The proper gain setting should be selected to match the channel insertion loss before the input of the TUSB1046A-DCI receivers. Two 4-level inputs pins enable up to 16 possible equalization settings. USB3.1 upstream path, USB3.1 downstream path, and DisplayPort each have their own two 4-level inputs. The TUSB1046A-DCI also provides the flexibility of adjusting settings through I²C registers.

8.4 Device Functional Modes
8.4.1 Device Configuration in GPIO Mode

The TUSB1046A-DCI is in GPIO configuration when I2C_EN = “0”. The TUSB1046A-DCI supports the following configurations: USB 3.1 only, 2 DisplayPort lanes + USB 3.1, or 4 DisplayPort lanes (no USB 3.1). The CTL1 pin controls whether DisplayPort is enabled. The combination of CTL1 and CTL0 selects between USB 3.1 only, 2 lanes of DisplayPort, or 4-lanes of DisplayPort as detailed in [Table 2](#). The AUXp or AUXn to SBU1 or SBU2 mapping is controlled based on [Table 3](#).

After power-up (V_{CC} from 0 V to 3.3 V), the TUSB1046A-DCI defaults to USB3.1 mode. The USB PD controller upon detecting no device attached to Type-C port or USB3.1 operation not required by attached device must take TUSB1046A-DCI out of USB3.1 mode by transitioning the CTL0 pin from L to H and back to L.

Table 2. GPIO Configuration Control

CTL1 PIN	CTL0 PIN	FLIP PIN	TUSB1046A-DCI CONFIGURATION	VESA DisplayPort ALT MODE DFP_D CONFIGURATION
L	L	L	Power Down	—
L	L	H	Power Down	—
L	H	L	One Port USB 3.1 - No Flip	—
L	H	H	One Port USB 3.1 – With Flip	—
H	L	L	4 Lane DP - No Flip	C and E
H	L	H	4 Lane DP – With Flip	C and E
H	H	L	One Port USB 3.1 + 2 Lane DP- No Flip	D and F
H	H	H	One Port USB 3.1 + 2 Lane DP– With Flip	D and F

Table 3. GPIO AUXp or AUXn to SBU1 or SBU2 Mapping

CTL1 PIN	FLIP PIN	MAPPING
H	L	AUXp → SBU1 AUXn → SBU2
H	H	AUXp → SBU2 AUXn → SBU1
L > 2 ms	X	Open

Table 4 Details the TUSB1046A-DCI’s mux routing. This table is valid for both I²C and GPIO configuration modes.

Table 4. INPUT to OUTPUT Mapping

CTL1 PIN	CTL0 PIN	FLIP PIN	FROM	TO
			INPUT PIN	OUTPUT PIN
L	L	L	NA	NA
L	L	H	NA	NA
L	H	L	RX1P	SSRXP
			RX1N	SSRXN
			SSTXP	TX1P
			SSTXN	TX1N
L	H	H	RX2P	SSRXP
			RX2N	SSRXN
			SSTXP	TX2P
			SSTXN	TX2P
H	L	L	DP0P	RX2P
			DP0N	RX2N
			DP1P	TX2P
			DP1N	TX2N
			DP2P	TX1P
			DP2N	TX1N
			DP3P	RX1P
			DP3N	RX1N
H	L	H	DP0P	RX1P
			DP0N	RX1N
			DP1P	TX1P
			DP1N	TX1N
			DP2P	TX2P
			DP2N	TX2N
			DP3P	RX2P
			DP3N	RX2N
H	H	L	RX1P	SSRXP
			RX1N	SSRXN
			SSTXP	TX1P
			SSTXN	TX1N
			DP0P	RX2P
			DP0N	RX2N
			DP1P	TX2P
			DP1N	TX2N
H	H	H	RX2P	SSRXP
			RX2N	SSRXN
			SSTXP	TX2P
			SSTXN	TX2N
			DP0P	RX1P
			DP0N	RX1N
			DP1P	TX1P
			DP1N	TX1N

8.4.2 Device Configuration In I²C Mode

The TUSB1046A-DCI is in I²C mode when I2C_EN is not equal to “0”. The same configurations defined in GPIO mode are also available in I²C mode. The TUSB1046A-DCI USB3.1 and DisplayPort configuration is controlled based on [Table 5](#). The AUXp or AUXn to SBU1 or SBU2 mapping control is based on [Table 6](#).

Table 5. I²C Configuration Control

REGISTERS			TUSB1046A-DCI CONFIGURATION	VESA DisplayPort ALT MODE DFP_D CONFIGURATION
CTLSEL1	CTLSEL0	FLIPSEL		
0	0	0	Power Down	—
0	0	1	Power Down	—
0	1	0	One Port USB 3.1 - No Flip	—
0	1	1	One Port USB 3.1 – With Flip	—
1	0	0	4 Lane DP - No Flip	C and E
1	0	1	4 Lane DP – With Flip	C and E
1	1	0	One Port USB 3.1 + 2 Lane DP- No Flip	D and F
1	1	1	One Port USB 3.1 + 2 Lane DP– With Flip	D and F

Table 6. I²C AUXp or AUXn to SBU1 or SBU2 Mapping

REGISTERS				MAPPING
AUX_SBU_OVR1	AUX_SBU_OVR0	CTLSEL1	FLIPSEL	
0	0	1	0	AUXp → SBU1 AUXn → SBU2
0	0	1	1	AUXp → SBU2 AUXn → SBU1
0	0	0	X	Open
0	1	X	X	AUXp → SBU1 AUXn → SBU2
1	0	X	X	AUXp → SBU2 AUXn → SBU1
1	1	X	X	Open

8.4.3 DisplayPort Mode

The TUSB1046A-DCI supports up to four DisplayPort lanes at datarates up to 8.1 Gbps. TUSB1046A-DCI can be enabled for DisplayPort through GPIO control or through I²C register control. When I2C_EN is ‘0’, DisplayPort is controlled based on [Table 2](#). When not in GPIO mode, enable of DisplayPort functionality is controlled through I²C registers.

8.4.4 Linear EQ Configuration

Each of the TUSB1046A-DCI receiver lanes has individual controls for receiver equalization. The receiver equalization gain value can be controlled either through I²C registers or through GPIOs. Table 7 details the gain value for each available combination when TUSB1046A-DCI is in GPIO mode. These same options are also available in I²C mode by updating registers DP0EQ_SEL, DP1EQ_SEL, DP2EQ_SEL, DP3EQ_SEL, EQ1_SEL, EQ2_SEL, and SSEQ_SEL.

Table 7. TUSB1046A-DCI Receiver Equalization GPIO Control

Equalization Setting #	USB3.1 DOWNSTREAM FACING PORTS			USB 3.1 UPSTREAM FACING PORT			ALL DISPLAYPORT LANES		
	EQ1 PIN LEVEL	EQ0 PIN LEVEL	EQ GAIN at 5 GHz (dB)	SSEQ1 PIN LEVEL	SSEQ0 PIN LEVEL	EQ GAIN at 5 GHz (dB)	DPEQ1 PIN LEVEL	DPEQ0 PIN LEVEL	EQ GAIN at 4.05 GHz (dB)
0	0	0	-3.9	0	0	-1.8	0	0	1.0
1	0	R	-1.7	0	R	0.2	0	R	3.3
2	0	F	-0.1	0	F	1.7	0	F	4.9
3	0	1	1.4	0	1	3.2	0	1	6.5
4	R	0	2.4	R	0	4.2	R	0	7.5
5	R	R	3.5	R	R	5.3	R	R	8.6
6	R	F	4.4	R	F	6.1	R	F	9.5
7	R	1	5.2	R	1	7.0	R	1	10.4
8	F	0	5.9	F	0	7.7	F	0	11.1
9	F	R	6.6	F	R	8.3	F	R	11.7
10	F	F	7.1	F	F	8.8	F	F	12.3
11	F	1	7.6	F	1	9.3	F	1	12.8
12	1	0	8.0	1	0	9.7	1	0	13.2
13	1	R	8.5	1	R	10.1	1	R	13.6
14	1	F	8.8	1	F	10.4	1	F	14.0
15	1	1	9.2	1	1	10.8	1	1	14.4

8.4.5 USB3.1 Modes

The TUSB1046A-DCI monitors the physical layer conditions like receiver termination, electrical idle, LFPS, and SuperSpeed signaling rate to determine the state of the USB3.1 interface. Depending on the state of the USB 3.1 interface, the TUSB1046A-DCI can be in one of four primary modes of operation when USB 3.1 is enabled (CTL0 = H or CTLSEL0 = 1b1): Disconnect, U2/U3, U1, and U0.

The Disconnect mode is the state in which TUSB1046A-DCI has not detected far-end termination on both upstream facing port (UFP) or downstream facing port (DFP). The disconnect mode is the lowest power mode of each of the four modes. The TUSB1046A-DCI remains in this mode until far-end receiver termination has been detected on both UFP and DFP. The TUSB1046A-DCI immediately exits this mode and enter U0 once far-end termination is detected.

Once in U0 mode, the TUSB1046A-DCI will redrive all traffic received on UFP and DFP. U0 is the highest power mode of all USB3.1 modes. The TUSB1046A-DCI remains in U0 mode until electrical idle occurs on both UFP and DFP. Upon detecting electrical idle, the TUSB1046A-DCI immediately transitions to U1.

The U1 mode is the intermediate mode between U0 mode and U2/U3 mode. In U1 mode, the TUSB1046A-DCI UFP and DFP receiver termination remains enabled. The UFP and DFP transmitter DC common mode is maintained. The power consumption in U1 is similar to power consumption of U0.

Next to the disconnect mode, the U2/U3 mode is next lowest power state. While in this mode, the TUSB1046A-DCI periodically performs far-end receiver detection. Anytime the far-end receiver termination is not detected on either UFP or DFP, the TUSB1046A-DCI leaves the U2/U3 mode and transitions to the Disconnect mode. It also monitors for a valid LFPS. Upon detection of a valid LFPS, the TUSB1046A-DCI immediately transitions to the U0 mode. In U2/U3 mode, the TUSB1046A-DCI receiver terminations remain enabled but the TX DC common mode voltage is not maintained.

8.4.6 Operation Timing – Power Up

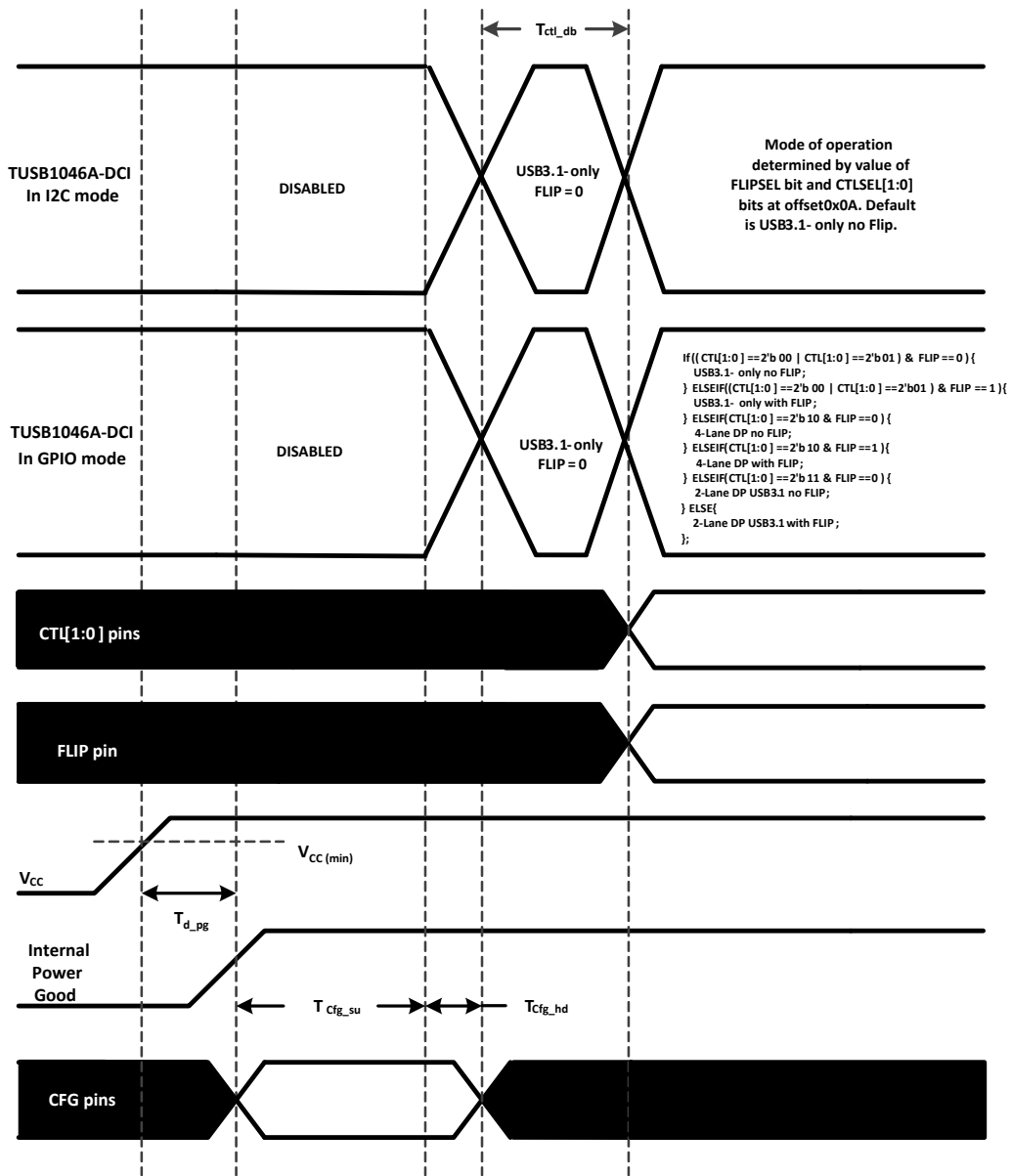

Figure 18. Power-Up Timing

Table 8. Power-Up Timing⁽¹⁾⁽²⁾

PARAMETER		MIN	MAX	UNIT
t _{d_pg}	V _{CC} (minimum) to Internal Power Good asserted high		500	µs
t _{cfg_su}	CFG(1) pins setup(2)	250		µs
t _{cfg_hd}	CFG(1) pins hold	10		µs
t _{CTL_DB}	CTL[1:0] and FLIP pin debounce		16	ms
t _{VCC_RAMP}	V _{CC} supply ramp requirement		100	ms

(1) Following pins comprise CFG pins: I2C_EN, EQ[1:0], SSEQ[1:0], and DPEQ[1:0].
 (2) Recommend CFG pins are stable when V_{CC} is at min.

8.5 Programming

For further programmability, the TUSB1046A-DCI can be controlled using I²C. The SCL and SDA pins are used for I²C clock and I²C data respectively.

Table 9. TUSB1046A-DCI I²C Target Address

DPEQ0/A1 PIN LEVEL	SSEQ0/A0 PIN LEVEL	Bit 7 (MSB)	Bit 6	Bit 5	Bit 4	Bit 3	Bit 2	Bit 1	Bit 0 (W/R)
0	0	1	0	0	0	1	0	0	0/1
0	R	1	0	0	0	1	0	1	0/1
0	F	1	0	0	0	1	1	0	0/1
0	1	1	0	0	0	1	1	1	0/1
R	0	0	1	0	0	0	0	0	0/1
R	R	0	1	0	0	0	0	1	0/1
R	F	0	1	0	0	0	1	0	0/1
R	1	0	1	0	0	0	1	1	0/1
F	0	0	0	1	0	0	0	0	0/1
F	R	0	0	1	0	0	0	1	0/1
F	F	0	0	1	0	0	1	0	0/1
F	1	0	0	1	0	0	1	1	0/1
1	0	0	0	0	1	1	0	0	0/1
1	R	0	0	0	1	1	0	1	0/1
1	F	0	0	0	1	1	1	0	0/1
1	1	0	0	0	1	1	1	1	0/1

The following procedure should be followed to write to TUSB1046A-DCI I²C registers:

1. The master initiates a write operation by generating a start condition (S), followed by the TUSB1046A-DCI 7-bit address and a zero-value “W/R” bit to indicate a write cycle.
2. The TUSB1046A-DCI acknowledges the address cycle.
3. The master presents the sub-address (I²C register within TUSB1046A-DCI) to be written, consisting of one byte of data, MSB-first.
4. The TUSB1046A-DCI acknowledges the sub-address cycle.
5. The master presents the first byte of data to be written to the I²C register.
6. The TUSB1046A-DCI acknowledges the byte transfer.
7. The master may continue presenting additional bytes of data to be written, with each byte transfer completing with an acknowledge from the TUSB1046A-DCI.
8. The master terminates the write operation by generating a stop condition (P).

The following procedure should be followed to read the TUSB1046A-DCI I²C registers:

1. The master initiates a read operation by generating a start condition (S), followed by the TUSB1046A-DCI 7-bit address and a one-value “W/R” bit to indicate a read cycle.
2. The TUSB1046A-DCI acknowledges the address cycle.
3. The TUSB1046A-DCI transmit the contents of the memory registers MSB-first starting at register 00h or last read sub-address+1. If a write to the T I²C register occurred prior to the read, then the TUSB1046A-DCI shall start at the sub-address specified in the write.
4. The TUSB1046A-DCI shall wait for either an acknowledge (ACK) or a not-acknowledge (NACK) from the master after each byte transfer; the I²C master acknowledges reception of each data byte transfer.
5. If an ACK is received, the TUSB1046A-DCI transmits the next byte of data.
6. The master terminates the read operation by generating a stop condition (P).

The following procedure should be followed for setting a starting sub-address for I²C reads:

1. The master initiates a write operation by generating a start condition (S), followed by the TUSB1046A-DCI 7-bit address and a zero-value “W/R” bit to indicate a write cycle.
2. The TUSB1046A-DCI acknowledges the address cycle.
3. The master presents the sub-address (I²C register within TUSB1046A-DCI) to be written, consisting of one byte of data, MSB-first.

4. The TUSB1046A-DCI acknowledges the sub-address cycle.
5. The master terminates the write operation by generating a stop condition (P).

NOTE

If no sub-addressing is included for the read procedure, and reads start at register offset 00h and continue byte by byte through the registers until the I²C master terminates the read operation. If a I²C address write occurred prior to the read, then the reads start at the sub-address specified by the address write.

Table 10. Register Legend

ACCESS TAG	NAME	MEANING
R	Read	The field may be read by software
W	Write	The field may be written by software
S	Set	The field may be set by a write of one. Writes of zeros to the field have no effect.
C	Clear	The field may be cleared by a write of one. Write of zero to the field have no effect.
U	Update	Hardware may autonomously update this field.
NA	No Access	Not accessible or not applicable

8.6 Register Maps

8.6.1 General Register (address = 0x0A) [reset = 00000001]

Figure 19. General Registers

7	6	5	4	3	2	1	0
Reserved		SWAP_HPDI	EQ_OVERRID	HPDIN_OVRR	FLIPSEL	CTLSEL[1:0].	
R		R/W	R/W	R/W	R/W	R/W	

LEGEND: R/W = Read/Write; R = Read only; -n = value after reset

Table 11. General Registers

Bit	Field	Type	Reset	Description
7:6	Reserved.	R	00	Reserved.
5	SWAP_HPDI	R/W	0	0 – HPDI is in default location (Default) 1 – HPDI location is swapped (PIN 23 to PIN 32, or PIN 32 to PIN23).
4	EQ_OVERRIDE	R/W	0	Setting of this field will allow software to use EQ settings from registers instead of value sample from pins. 0 – EQ settings based on sampled state of the EQ pins (SSEQ[1:0], EQ[1:0], and DPEQ[1:0]). 1 – EQ settings based on programmed value of each of the EQ registers
3	HPDIN_OVRRIDE	R/W	0	0 – HPDI IN based on state of HPDI_IN pin (Default) 1 – HPDI_IN high.
2	FLIPSEL	R/W	0	FLIPSEL. Refer to Table 5 and Table 6 for this field functionality.
1:0	CTLSEL[1:0].	R/W	01	00 – Disabled. All RX and TX for USB3 and DisplayPort are disabled. 01 – USB3.1 only enabled. (Default) 10 – Four DisplayPort lanes enabled. 11 – Two DisplayPort lanes and one USB3.1

8.6.2 DisplayPort Control/Status Registers (address = 0x10) [reset = 00000000]

Figure 20. DisplayPort Control/Status Registers (0x10)

7	6	5	4	3	2	1	0
DP1EQ_SEL				DP0EQ_SEL			
R/W/U				R/W/U			

LEGEND: R/W = Read/Write; R = Read only; -n = value after reset

Table 12. DisplayPort Control/Status Registers (0x10)

Bit	Field	Type	Reset	Description
7:4	DP1EQ_SEL	R/W/U	0000	Field selects between 0 to 14dB of EQ for DP lane 1. When EQ_OVERRIDE = 1'b0, this field reflects the sampled state of DPEQ[1:0] pins. When EQ_OVERRIDE = 1'b1, software can change the EQ setting for DP lane 1 based on value written to this field.
3:0	DP0EQ_SEL	R/W/U	0000	Field selects between 0 to 14dB of EQ for DP lane 0. When EQ_OVERRIDE = 1'b0, this field reflects the sampled state of DPEQ[1:0] pins. When EQ_OVERRIDE = 1'b1, software can change the EQ setting for DP lane 0 based on value written to this field.

8.6.3 DisplayPort Control/Status Registers (address = 0x11) [reset = 00000000]

Figure 21. DisplayPort Control/Status Registers (0x11)

7	6	5	4	3	2	1	0
DP3EQ_SEL				DP2EQ_SEL			
R/W/U				R/W/U			

LEGEND: R/W = Read/Write; R = Read only; -n = value after reset

Table 13. DisplayPort Control/Status Registers (0x11)

Bit	Field	Type	Reset	Description
7:4	DP3EQ_SEL	R/W/U	0000	Field selects between 0 to 14dB of EQ for DP lane 3. When EQ_OVERRIDE = 1'b0, this field reflects the sampled state of DPEQ[1:0] pins. When EQ_OVERRIDE = 1'b1, software can change the EQ setting for DP lane 3 based on value written to this field.
3:0	DP2EQ_SEL	R/W/U	0000	Field selects between 0 to 14dB of EQ for DP lane 2. When EQ_OVERRIDE = 1'b0, this field reflects the sampled state of DPEQ[1:0] pins. When EQ_OVERRIDE = 1'b1, software can change the EQ setting for DP lane 2 based on value written to this field.

8.6.4 DisplayPort Control/Status Registers (address = 0x12) [reset = 00000000]

Figure 22. DisplayPort Control/Status Registers (0x12)

7	6	5	4	3	2	1	0
Reserved	SET_POWER_STATE		LANE_COUNT_SET				
R	RU		RU				

LEGEND: R/W = Read/Write; R = Read only; -n = value after reset

Table 14. DisplayPort Control/Status Registers (0x12)

Bit	Field	Type	Reset	Description
7	Reserved	R	0	Reserved
6:5	SET_POWER_STATE	R/U	00	This field represents the snooped value of the AUX write to DPCD address 0x00600. When AUX_SNOOP_DISABLE = 1'b0, the TUSB1046A-DCI will enable/disable DP lanes based on the snooped value. When AUX_SNOOP_DISABLE = 1'b1, then DP lane enable/disable are determined by state of DPx_DISABLE registers, where x = 0, 1, 2, or 3. This field is reset to 2'b00 by hardware when CTLSEL1 changes from a 1'b1 to a 1'b0.
4:0	LANE_COUNT_SET	R/U	00000	This field represents the snooped value of AUX write to DPCD address 0x00101 register. When AUX_SNOOP_DISABLE = 1'b0, TUSB1046-DCI will enable DP lanes specified by the snoop value. Unused DP lanes will be disabled to save power. When AUX_SNOOP_DISABLE = 1'b1, then DP lanes enable/disable are determined by DPx_DISABLE registers, where x = 0, 1, 2, or 3. This field is reset to 0x0 by hardware when CTLSEL1 changes from a 1'b1 to a 1'b0.

8.6.5 DisplayPort Control/Status Registers (address = 0x13) [reset = 00000000]

Figure 23. DisplayPort Control/Status Registers (0x13)

7	6	5	4	3	2	1	0
AUX_SNOOP_DISABLE	Reserved	AUX_SBU_OVR		DP3_DISABLE	DP2_DISABLE	DP1_DISABLE	DP0_DISABLE
R/W	R	R/W		R/W	R/W	R/W	R/W

LEGEND: R/W = Read/Write; R = Read only; -n = value after reset

Table 15. DisplayPort Control/Status Registers (0x13)

Bit	Field	Type	Reset	Description
7	AUX_SNOOP_DISABLE	R/W	0	0 – AUX snoop enabled. (Default) 1 – AUX snoop disabled.
6	Reserved	R	0	Reserved
5:4	AUX_SBU_OVR	R/W	00	This field overrides the AUXp or AUXn to SBU1 or SBU2 connect and disconnect based on CTL1 and FLIP. Changing this field to 1'b1 will allow traffic to pass through AUX to SBU regardless of the state of CTLSEL1 and FLIPSEL register 00 – AUX to SBU connect/disconnect determined by CTLSEL1 and FLIPSEL (Default) 01 – AUXp -> SBU1 and AUXn -> SBU2 connection always enabled. 10 – AUXp -> SBU2 and AUXn -> SBU1 connection always enabled. 11 = AUX to SBU open.
3	DP3_DISABLE	R/W	0	When AUX_SNOOP_DISABLE = 1'b1, this field can be used to enable or disable DP lane 3. When AUX_SNOOP_DISABLE = 1'b0, changes to this field will have no effect on lane 3 functionality. 0 – DP Lane 3 Enabled (default) 1 – DP Lane 3 Disabled.
2	DP2_DISABLE	R/W	0	When AUX_SNOOP_DISABLE = 1'b1, this field can be used to enable or disable DP lane 2. When AUX_SNOOP_DISABLE = 1'b0, changes to this field will have no effect on lane 2 functionality. 0 – DP Lane 2 Enabled (default) 1 – DP Lane 2 Disabled.
1	DP1_DISABLE	R/W	0	When AUX_SNOOP_DISABLE = 1'b1, this field can be used to enable or disable DP lane 1. When AUX_SNOOP_DISABLE = 1'b0, changes to this field will have no effect on lane 1 functionality. 0 – DP Lane 1 Enabled (default) 1 – DP Lane 1 Disabled.
0	DP0_DISABLE	R/W	0	DISABLE. When AUX_SNOOP_DISABLE = 1'b1, this field can be used to enable or disable DP lane 0. When AUX_SNOOP_DISABLE = 1'b0, changes to this field will have no effect on lane 0 functionality. 0 – DP Lane 0 Enabled (default) 1 – DP Lane 0 Disabled.

8.6.6 USB3.1 Control/Status Registers (address = 0x20) [reset = 00000000]

Figure 24. USB3.1 Control/Status Registers (0x20)

7	6	5	4	3	2	1	0
EQ2_SEL				EQ1_SEL			
R/W/U				R/W/U			

LEGEND: R/W = Read/Write; R = Read only; -n = value after reset

Table 16. USB3.1 Control/Status Registers (0x20)

Bit	Field	Type	Reset	Description
7:4	EQ2_SEL	R/W/U	0000	Field selects between 0 to 9 dB of EQ for USB3.1 RX2 receiver. When EQ_OVERRIDE = 1'b0, this field reflects the sampled state of EQ[1:0] pins. When EQ_OVERRIDE = 1'b1, software can change the EQ setting for USB3.1 RX2 receiver based on value written to this field.
3:0	EQ1_SEL	R/W/U	0000	Field selects between 0 to 9 dB of EQ for USB3.1 RX1 receiver. When EQ_OVERRIDE = 1'b0, this field reflects the sampled state of EQ[1:0] pins. When EQ_OVERRIDE = 1'b1, software can change the EQ setting for USB3.1 RX1 receiver based on value written to this field.

8.6.7 USB3.1 Control/Status Registers (address = 0x21) [reset = 00000000]

Figure 25. USB3.1 Control/Status Registers (0x21)

7	6	5	4	3	2	1	0
Reserved				SSEQ_SEL			
R				R/W/U			

LEGEND: R/W = Read/Write; R = Read only; -n = value after reset

Table 17. USB3.1 Control/Status Registers (0x21)

Bit	Field	Type	Reset	Description
7:4	Reserved	R	0000	Reserved
3:0	SSEQ_SEL	R/W/U	0000	Field selects between 0 to 11 dB of EQ for USB3.1 SSTXP/N receiver. When EQ_OVERRIDE = 1'b0, this field reflects the sampled state of SSEQ[1:0] pins. When EQ_OVERRIDE = 1'b1, software can change the EQ setting for USB3.1 SSTXP/N receiver based on value written to this field.

8.6.8 USB3.1 Control/Status Registers (address = 0x22) [reset = 0000100]
Figure 26. USB3.1 Control/Status Registers (0x22)

7	6	5	4	3	2	1	0
CM_ACTIVE	LFPS_EQ	U2U3_LFPS_D EBOUNCE	DISABLE_U2U 3_RXDET	DFP_RXDET_INTERVAL		USB3_COMPLIANCE_CTRL	
R/U	R/W	R/W	R/W	R/W		R/W	

LEGEND: R/W = Read/Write; R = Read only; -n = value after reset

Table 18. USB3.1 Control/Status Registers (0x22)

Bit	Field	Type	Reset	Description
7	CM_ACTIVE	R/U	0	0 – device not in USB 3.1 compliance mode. (Default) 1 – device in USB 3.1 compliance mode
6	LFPS_EQ	R/W	0	Controls whether settings of EQ based on EQ1_SEL, EQ2_SEL and SSEQ_SEL applies to received LFPS signal. 0 – EQ set to zero when receiving LFPS (default) 1 – EQ set to EQ1_SEL, EQ2_SEL, and SSEQ_SEL when receiving LFPS.
5	U2U3_LFPS_DEBOUNCE	R/W	0	0 – No debounce of LFPS before U2/U3 exit. (Default) 1 – 200us debounce of LFPS before U2/U3 exit.
4	DISABLE_U2U3_RXDET	R/W	0	0 – Rx.Detect in U2/U3 enabled. (Default) 1 – Rx.Detect in U2/U3 disabled.
3:2	DFP_RXDET_INTERVAL	R/W	01	This field controls the Rx.Detect interval for the Downstream facing port (TX1P/N and TX2P/N). 00 – 8 ms 01 – 12 ms (default) 10 – 48 ms 11 – 96 ms
1:0	USB3_COMPLIANCE_CTRL	R/W	00	00 – FSM determined compliance mode. (Default) 01 – Compliance Mode enabled in DFP direction (SSTX -> TX1/TX2) 10 – Compliance Mode enabled in UFP direction (RX1/RX2 -> SSRX) 11 – Compliance Mode Disabled.

9 Application and Implementation

NOTE

Information in the following applications sections is not part of the TI component specification, and TI does not warrant its accuracy or completeness. TI's customers are responsible for determining suitability of components for their purposes. Customers should validate and test their design implementation to confirm system functionality.

9.1 Application Information

The TUSB1046-DCI is a linear redriver designed specifically to compensation for intersymbol interference (ISI) jitter caused by signal attenuation through a passive medium like PCB traces and cables. Because the TUSB1046-DCI has four independent DisplayPort 1.4 inputs, one upstream facing USB 3.1 Gen1/Gen2 input, and two downstream facing USB 3.1 Gen1/Gen2 inputs, it can be optimized to correct ISI on all those seven inputs through 16 different equalization choices. Placing the TUSB1046-DCI between a USB3.1 Host/DisplayPort 1.4 GPU and a USB3.1 Type-C receptacle can correct signal integrity issues resulting in a more robust system.

9.2 Typical Application

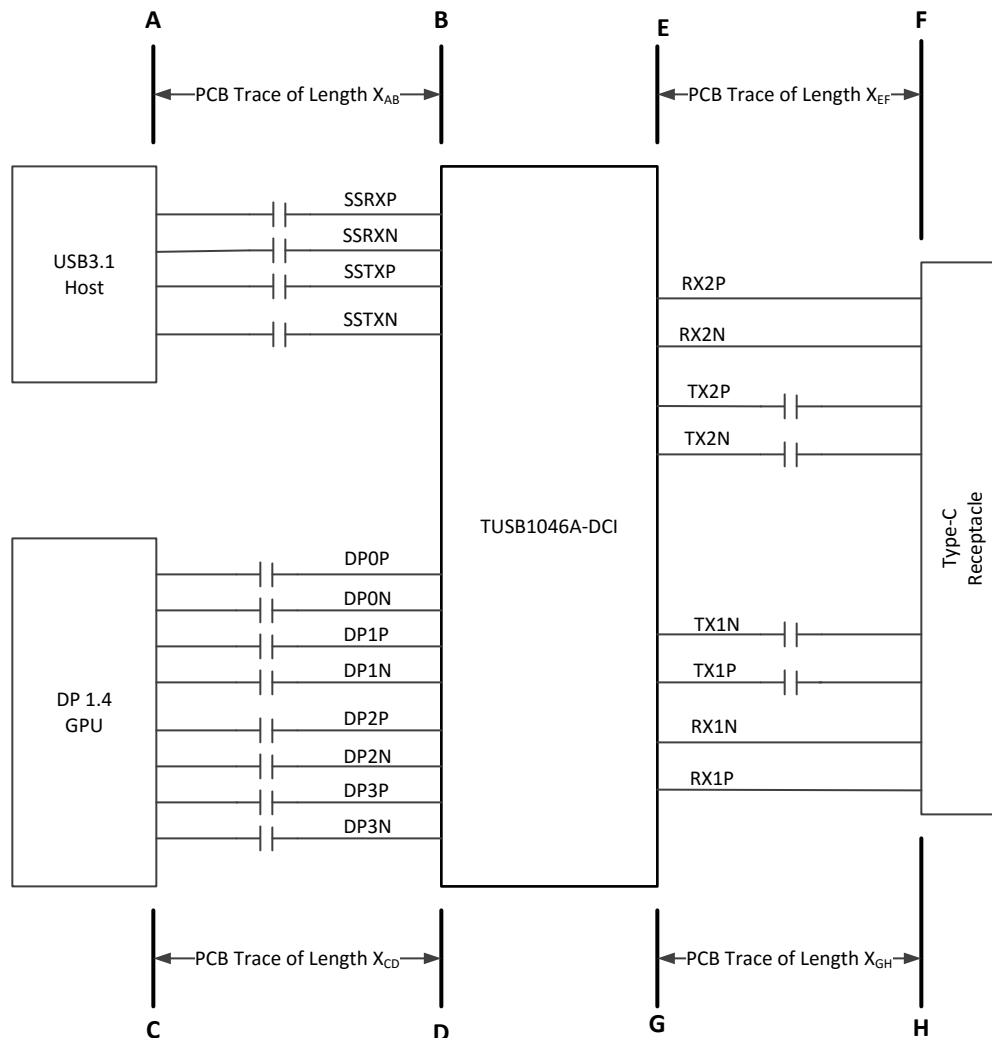

Copyright © 2017, Texas Instruments Incorporated

Figure 27. TUSB1046-DCI in a Host Application

Typical Application (continued)

9.2.1 Design Requirements

For this design example, use the parameters shown in [Table 19](#).

Table 19. Design Parameters

PARAMETER	VALUE
A to B PCB trace length, X_{AB}	12 inches
C to D PCB trace length, X_{CD}	12 inches
E to F PCB trace length, X_{EF}	2 inches
G to H PCB trace length, X_{GH}	2 inches
PCB trace width	4 mils
AC-coupling capacitor (75 nF to 265 nF)	100 nF
VCC supply (3 V to 3.6 V)	3.3 V
I2C Mode or GPIO Mode	I2C Mode. (I2C_EN pin != "0")
1.8V or 3.3V I2C Interface	3.3V I2C. Pull-up the I2C_EN pin to 3.3V with a 1K ohm resistor.

9.2.2 Detailed Design Procedure

A typical usage of the TUSB1046-DCI device is shown in [Figure 28](#). The device can be controlled either through its GPIO pins or through its I²C interface. In the example shown below, a Type-C PD controller is used to configure the device through the I²C interface. When configured for I2C mode, pins 29 (RSVD1) and 32 (RSVD2) can be left unconnected. In I2C mode, the equalization settings for each receiver can be independently controlled through I2C registers. For this reason, all of the equalization pins (EQ[1:0], SSEQ[1:0], and DPEQ[1:0]) can be left unconnected. If these pins are left unconnected, the TUSB1046-DCI 7-bit I2C slave address will be 0x12 because both DPEQ/A1 and SSEQ0/A0 will be at pin level "F". If a different I2C slave address is desired, DPEQ/A1 and SSEQ0/A0 pins should be set to a level which produces the desired I2C slave address.

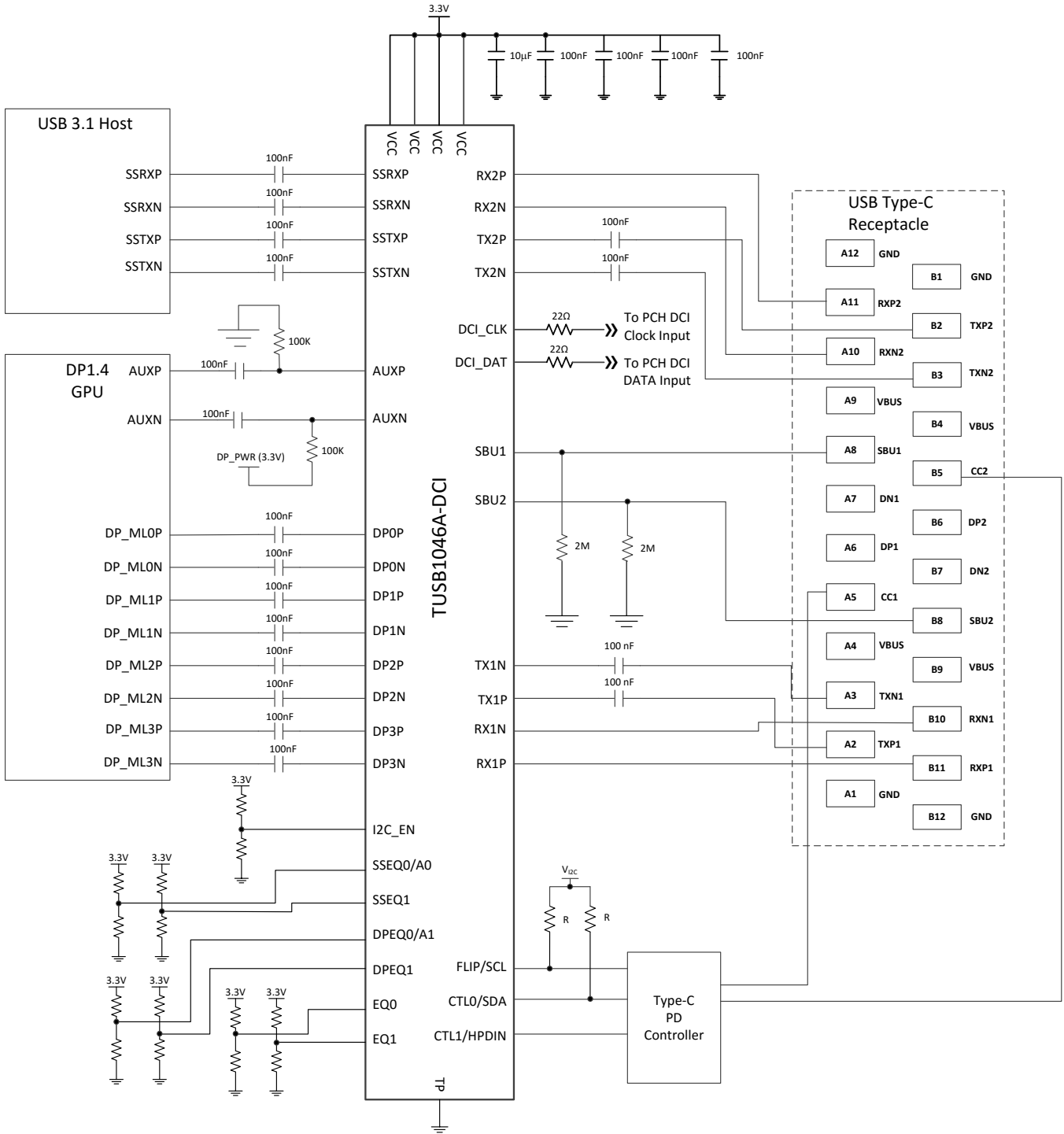

Copyright © 2016, Texas Instruments Incorporated

Figure 28. Application Circuit

9.2.3 Application Curve

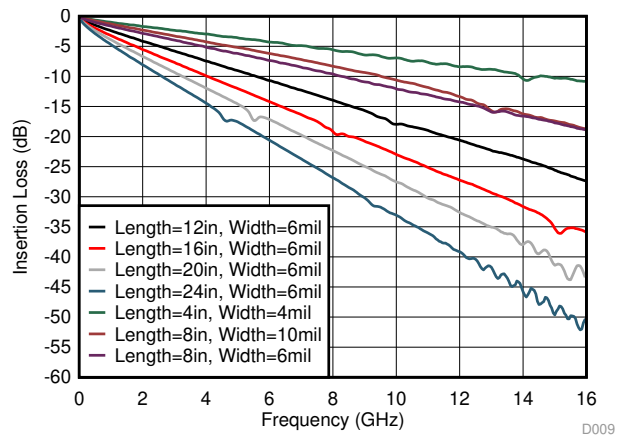
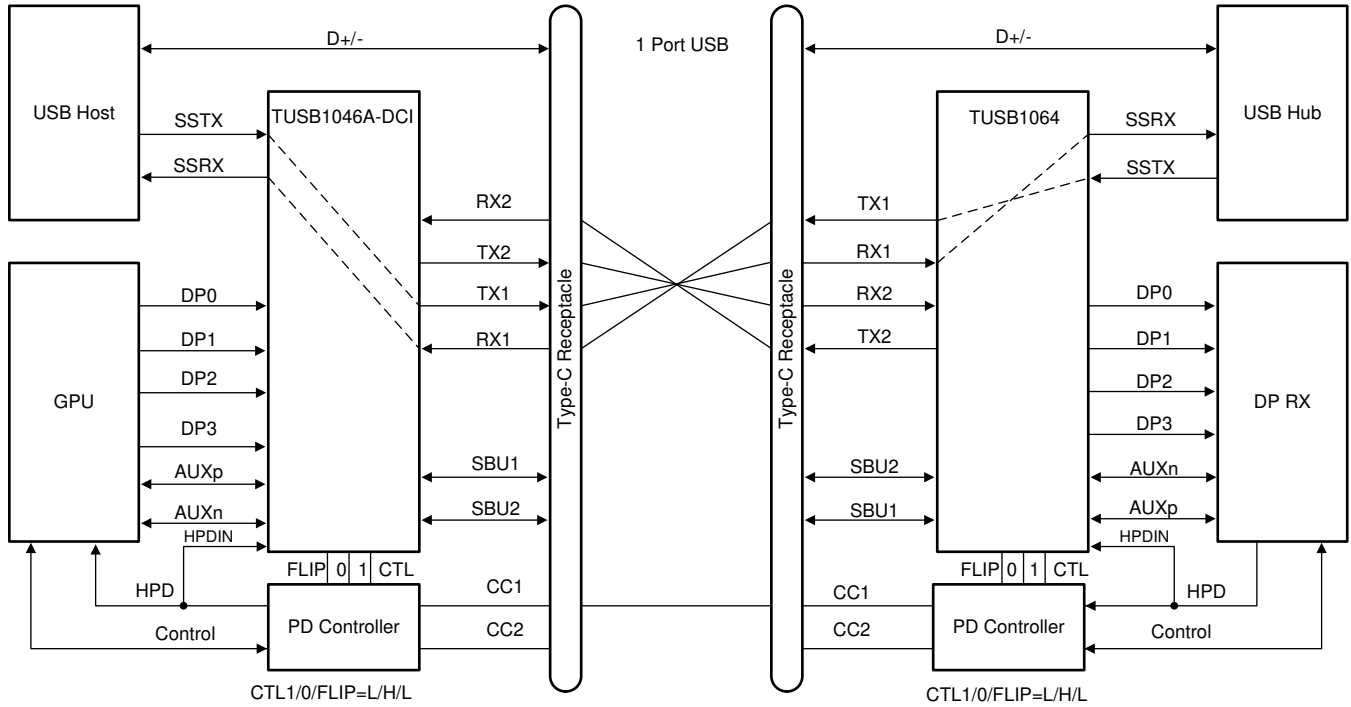

Figure 29. Insertion Loss of FR4 PCB Traces

9.3 System Examples

9.3.1 USB 3.1 Only

The TUSB1046-DCI is in USB3.1 only when the CTL1 pin is low and CTL0 pin is high.



Copyright © 2017, Texas Instruments Incorporated

Figure 30. USB3.1 Only – No Flip (CTL1 = L, CTL0 = H, FLIP = L)

System Examples (continued)

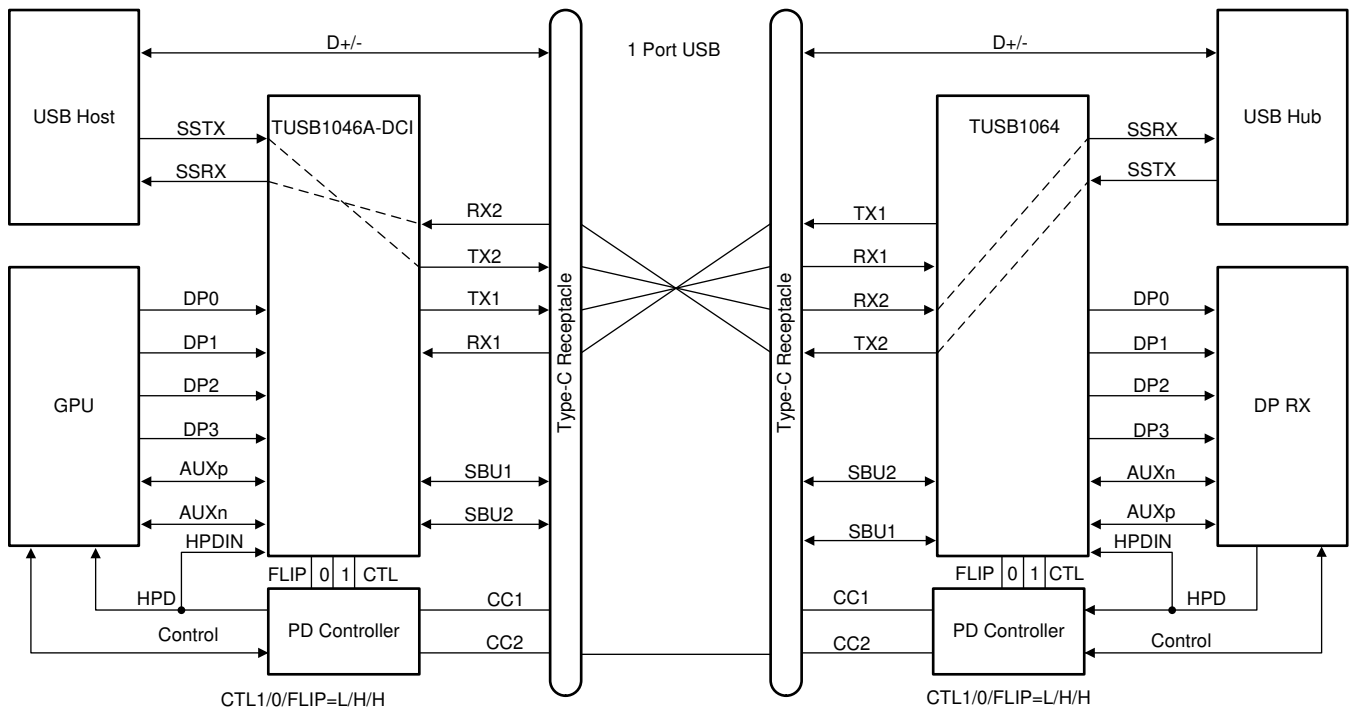

Copyright © 2017, Texas Instruments Incorporated

Figure 31. USB3.1 Only – With Flip (CTL1 = L, CTL0 = H, FLIP = H)

System Examples (continued)

9.3.2 USB 3.1 and 2 Lanes of DisplayPort

The TUSB1046-DCI operates in USB3.1 and 2 Lanes of DisplayPort mode when the CTL1 pin is high and CTL0 pin is high.

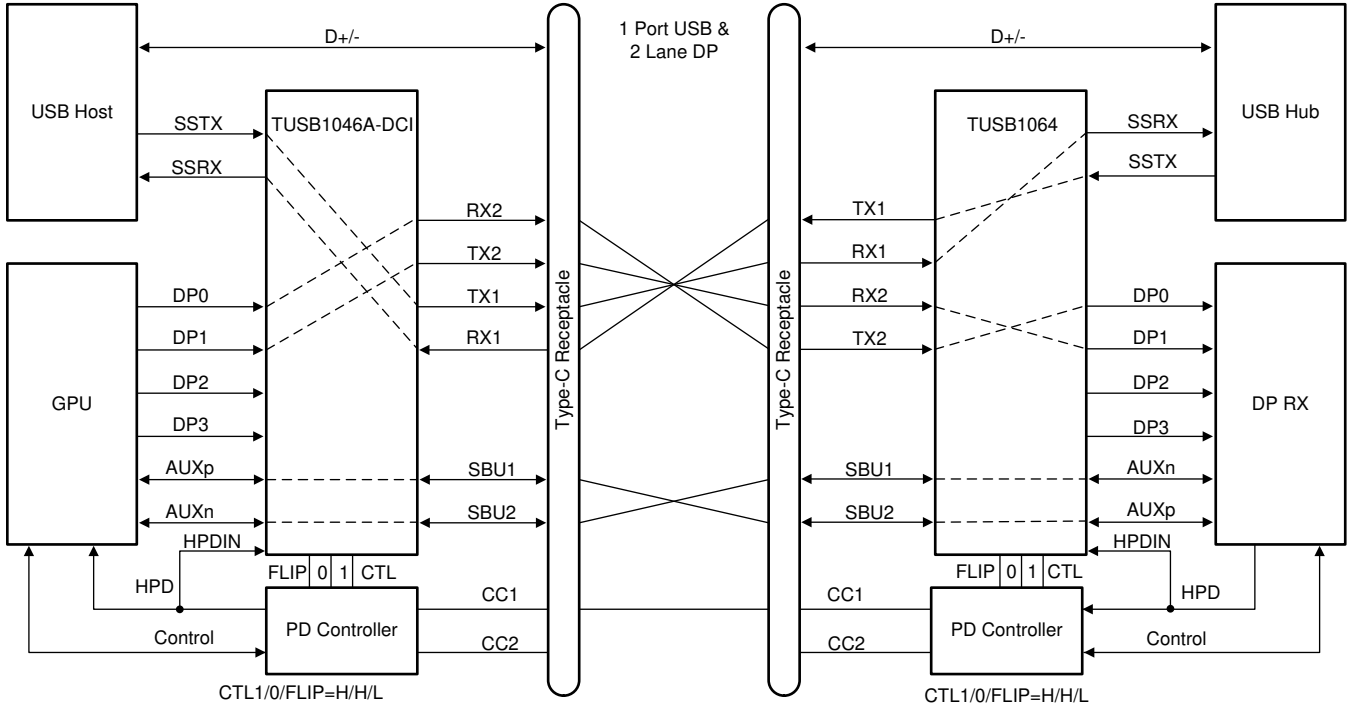

Copyright © 2016, Texas Instruments Incorporated

Figure 32. USB3.1 + 2 Lane DP – No Flip (CTL1 = H, CTL0 = H, FLIP = L)

System Examples (continued)

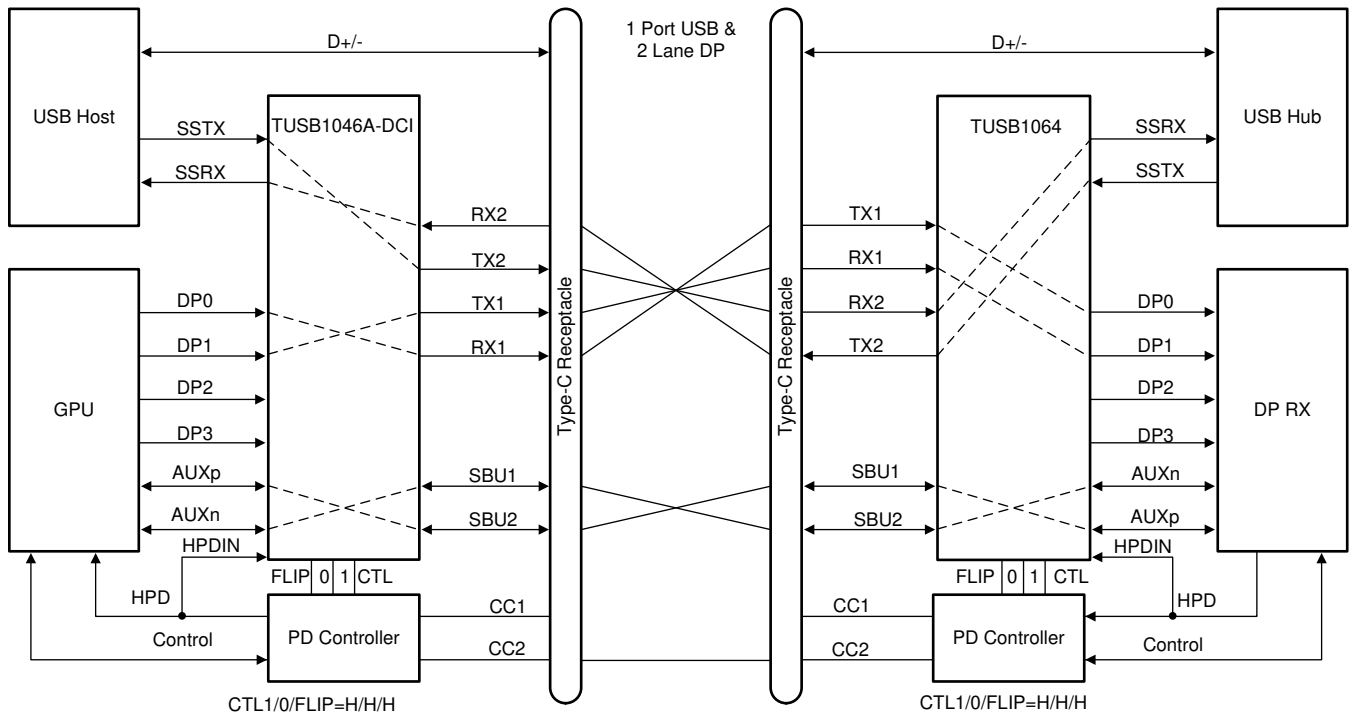

Copyright © 2016, Texas Instruments Incorporated

Figure 33. USB 3.1 + 2 Lane DP – Flip (CTL1 = H, CTL0 = H, FLIP = H)

System Examples (continued)

9.3.3 DisplayPort Only

The TUSB1046-DCI operates in 4 Lanes of DisplayPort only mode when the CTL1 pin is high and CTL0 pin is low.

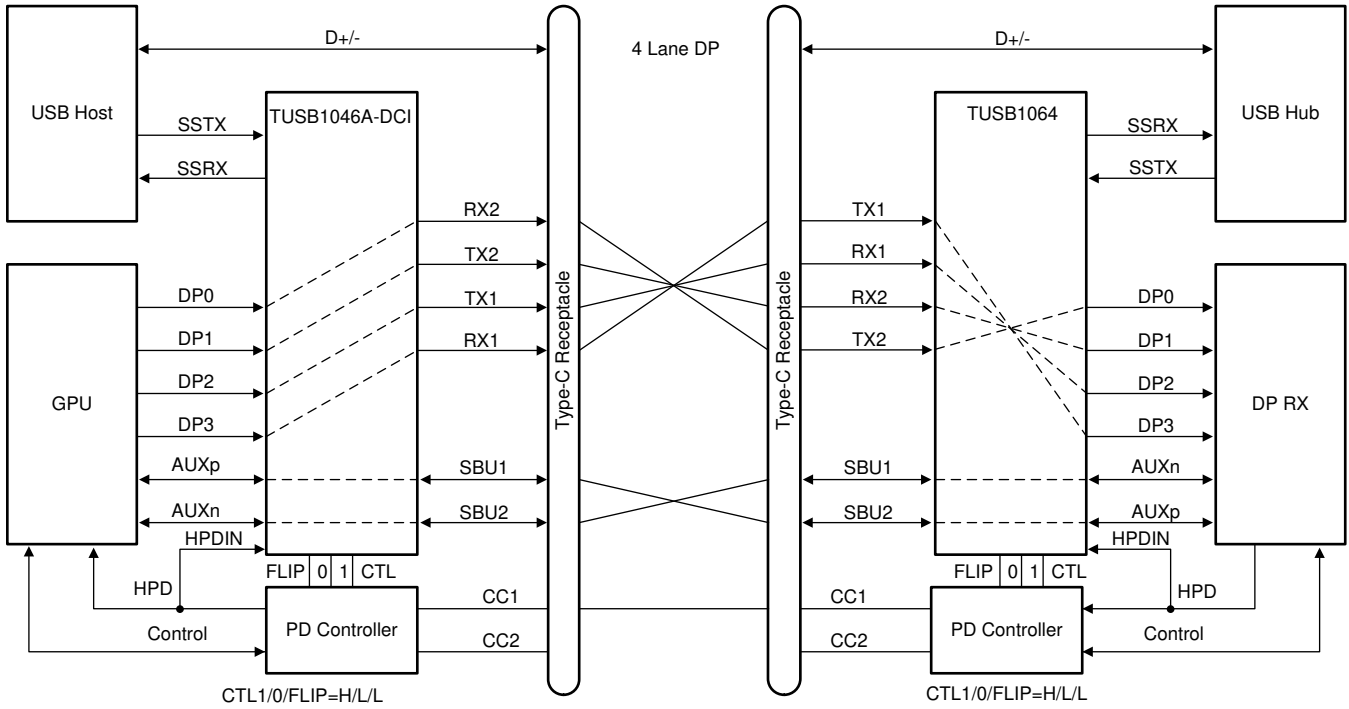

Copyright © 2017, Texas Instruments Incorporated

Figure 34. Four Lane DP – No Flip (CTL1 = H, CTL0 = L, FLIP = L)

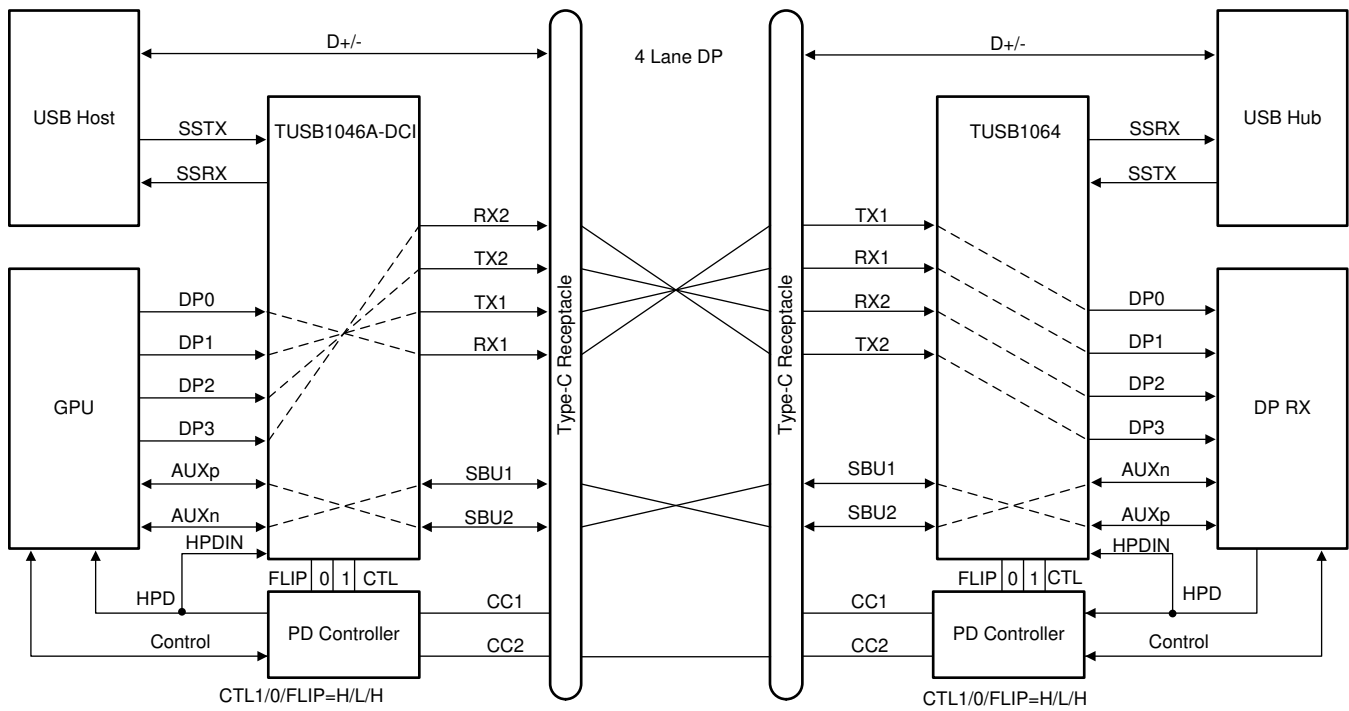
System Examples (continued)

Copyright © 2017, Texas Instruments Incorporated

Figure 35. Four Lane DP – With Flip (CTL1 = H, CTL0 = L, FLIP = H)

10 Power Supply Recommendations

The TUSB1046-DCI is designed to operate with a 3.3-V power supply. Levels above those listed in the [Absolute Maximum Ratings](#) table should not be used. If using a higher voltage system power supply, a voltage regulator can be used to step down to 3.3 V. Decoupling capacitors should be used to reduce noise and improve power supply integrity. A 0.1- μ F capacitor should be used on each power pin.

11 Layout

11.1 Layout Guidelines

1. RXP/N and TXP/N pairs should be routed with controlled 90-Ω differential impedance ($\pm 15\%$).
2. Keep away from other high speed signals.
3. Intra-pair routing should be kept to within 2 mils.
4. Length matching should be near the location of mismatch.
5. Each pair should be separated at least by 3 times the signal trace width.
6. The use of bends in differential traces should be kept to a minimum. When bends are used, the number of left and right bends should be as equal as possible and the angle of the bend should be ≥ 135 degrees. This will minimize any length mismatch causes by the bends and therefore minimize the impact bends have on EMI.
7. Route all differential pairs on the same of layer.
8. The number of vias should be kept to a minimum. It is recommended to keep the vias count to 2 or less.
9. Keep traces on layers adjacent to ground plane.
10. Do not route differential pairs over any plane split.
11. Adding Test points will cause impedance discontinuity, and therefore, negatively impact signal performance. If test points are used, they should be placed in series and symmetrically. They must not be placed in a manner that causes a stub on the differential pair.

11.2 Layout Example

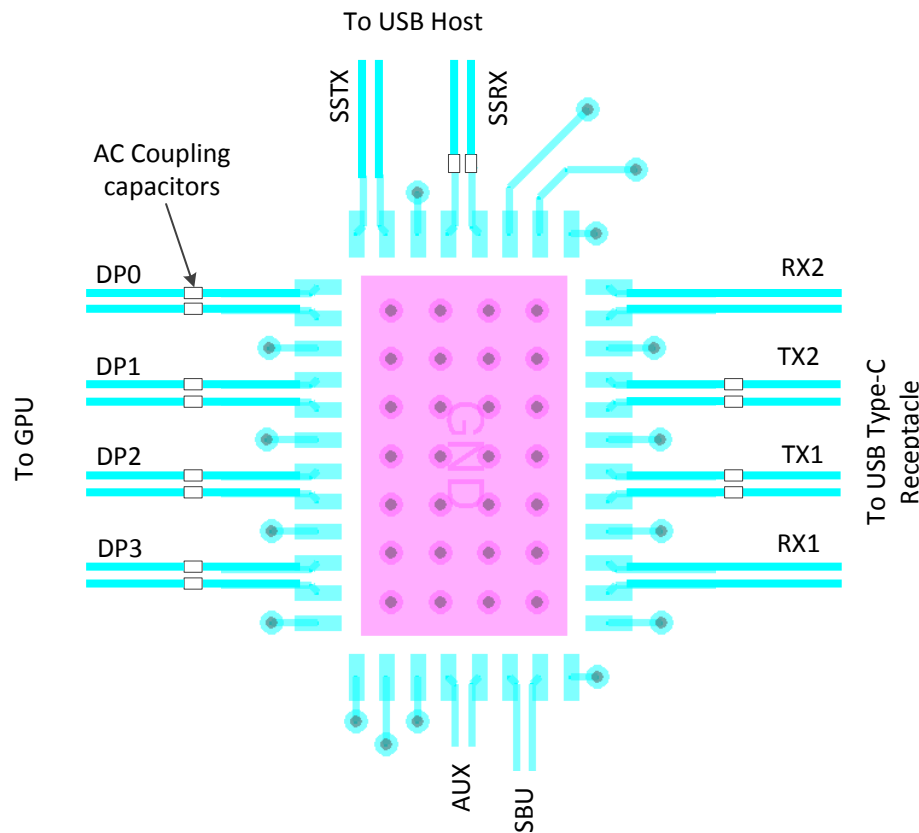

Figure 36. Layout Example

12 器件和文档支持

12.1 相关链接

下表列出了快速访问链接。类别包括技术文档、支持与社区资源、工具和软件，以及申请样片或购买产品的快速链接。

表 20. 相关链接

器件	产品文件夹	样片与购买	技术文档	工具与软件	支持和社区
TUSB1046A-DCI	单击此处	单击此处	单击此处	单击此处	单击此处
TUSB1046AI-DCI	单击此处	单击此处	单击此处	单击此处	单击此处

12.2 接收文档更新通知

要接收文档更新通知，请导航至 TI.com.cn 上的器件产品文件夹。单击右上角的 [通知我](#) 进行注册，即可每周接收产品信息更改摘要。有关更改的详细信息，请查看任何已修订文档中包含的修订历史记录。

12.3 社区资源

The following links connect to TI community resources. Linked contents are provided "AS IS" by the respective contributors. They do not constitute TI specifications and do not necessarily reflect TI's views; see TI's [Terms of Use](#).

TI E2E™ Online Community *TI's Engineer-to-Engineer (E2E) Community*. Created to foster collaboration among engineers. At e2e.ti.com, you can ask questions, share knowledge, explore ideas and help solve problems with fellow engineers.

Design Support *TI's Design Support* Quickly find helpful E2E forums along with design support tools and contact information for technical support.

12.4 商标

E2E is a trademark of Texas Instruments.

USB Type-C is a trademark of USB Implementers Forum.

DisplayPort is a trademark of VESA.

VESA is a registered trademark of Video Electronics Standards Association Corporation California.

All other trademarks are the property of their respective owners.

12.5 静电放电警告



ESD 可能会损坏该集成电路。德州仪器 (TI) 建议通过适当的预防措施处理所有集成电路。如果不遵守正确的处理措施和安装程序，可能会损坏集成电路。

ESD 的损坏小至导致微小的性能降级，大至整个器件故障。精密的集成电路可能更容易受到损坏，这是因为非常细微的参数更改都可能会导致器件与其发布的规格不相符。

12.6 术语表

[SLYZ022](#) — *TI 术语表*。

这份术语表列出并解释术语、缩写和定义。

13 机械、封装和可订购信息

以下页面包含机械、封装和可订购信息。这些信息是指定器件的最新可用数据。数据如有变更，恕不另行通知，且不会对此文档进行修订。如需获取此数据表的浏览器版本，请查阅左侧的导航栏。

PACKAGING INFORMATION

Orderable Device	Status (1)	Package Type	Package Drawing	Pins	Package Qty	Eco Plan (2)	Lead finish/ Ball material (6)	MSL Peak Temp (3)	Op Temp (°C)	Device Marking (4/5)	Samples
TUSB1046A-DCIRNQR	ACTIVE	WQFN	RNQ	40	3000	RoHS & Green	NIPDAU	Level-1-260C-UNLIM	0 to 70	TUSB46	Samples
TUSB1046A-DCIRNQT	ACTIVE	WQFN	RNQ	40	250	RoHS & Green	NIPDAU	Level-1-260C-UNLIM	0 to 70	TUSB46	Samples
TUSB1046AI-DCIRNQR	ACTIVE	WQFN	RNQ	40	3000	RoHS & Green	NIPDAU	Level-1-260C-UNLIM	-40 to 85	TUSB46	Samples
TUSB1046AI-DCIRNQT	ACTIVE	WQFN	RNQ	40	250	RoHS & Green	NIPDAU	Level-1-260C-UNLIM	-40 to 85	TUSB46	Samples

(1) The marketing status values are defined as follows:

ACTIVE: Product device recommended for new designs.

LIFEBUY: TI has announced that the device will be discontinued, and a lifetime-buy period is in effect.

NRND: Not recommended for new designs. Device is in production to support existing customers, but TI does not recommend using this part in a new design.

PREVIEW: Device has been announced but is not in production. Samples may or may not be available.

OBSELETE: TI has discontinued the production of the device.

(2) **RoHS:** TI defines "RoHS" to mean semiconductor products that are compliant with the current EU RoHS requirements for all 10 RoHS substances, including the requirement that RoHS substance do not exceed 0.1% by weight in homogeneous materials. Where designed to be soldered at high temperatures, "RoHS" products are suitable for use in specified lead-free processes. TI may reference these types of products as "Pb-Free".

RoHS Exempt: TI defines "RoHS Exempt" to mean products that contain lead but are compliant with EU RoHS pursuant to a specific EU RoHS exemption.

Green: TI defines "Green" to mean the content of Chlorine (Cl) and Bromine (Br) based flame retardants meet JS709B low halogen requirements of <=1000ppm threshold. Antimony trioxide based flame retardants must also meet the <=1000ppm threshold requirement.

(3) MSL, Peak Temp. - The Moisture Sensitivity Level rating according to the JEDEC industry standard classifications, and peak solder temperature.

(4) There may be additional marking, which relates to the logo, the lot trace code information, or the environmental category on the device.

(5) Multiple Device Markings will be inside parentheses. Only one Device Marking contained in parentheses and separated by a "-" will appear on a device. If a line is indented then it is a continuation of the previous line and the two combined represent the entire Device Marking for that device.

(6) Lead finish/Ball material - Orderable Devices may have multiple material finish options. Finish options are separated by a vertical ruled line. Lead finish/Ball material values may wrap to two lines if the finish value exceeds the maximum column width.

Important Information and Disclaimer:The information provided on this page represents TI's knowledge and belief as of the date that it is provided. TI bases its knowledge and belief on information provided by third parties, and makes no representation or warranty as to the accuracy of such information. Efforts are underway to better integrate information from third parties. TI has taken and

continues to take reasonable steps to provide representative and accurate information but may not have conducted destructive testing or chemical analysis on incoming materials and chemicals. TI and TI suppliers consider certain information to be proprietary, and thus CAS numbers and other limited information may not be available for release.

In no event shall TI's liability arising out of such information exceed the total purchase price of the TI part(s) at issue in this document sold by TI to Customer on an annual basis.

TAPE AND REEL INFORMATION

QUADRANT ASSIGNMENTS FOR PIN 1 ORIENTATION IN TAPE

*All dimensions are nominal

Device	Package Type	Package Drawing	Pins	SPQ	Reel Diameter (mm)	Reel Width W1 (mm)	A0 (mm)	B0 (mm)	K0 (mm)	P1 (mm)	W (mm)	Pin1 Quadrant
TUSB1046A-DCIRNQR	WQFN	RNQ	40	3000	330.0	12.4	4.3	6.3	1.1	8.0	12.0	Q2
TUSB1046A-DCIRNQT	WQFN	RNQ	40	250	180.0	12.4	4.3	6.3	1.1	8.0	12.0	Q2
TUSB1046AI-DCIRNQR	WQFN	RNQ	40	3000	330.0	12.4	4.3	6.3	1.1	8.0	12.0	Q2
TUSB1046AI-DCIRNQT	WQFN	RNQ	40	250	180.0	12.4	4.3	6.3	1.1	8.0	12.0	Q2

TAPE AND REEL BOX DIMENSIONS

*All dimensions are nominal

Device	Package Type	Package Drawing	Pins	SPQ	Length (mm)	Width (mm)	Height (mm)
TUSB1046A-DCIRNQR	WQFN	RNQ	40	3000	367.0	367.0	35.0
TUSB1046A-DCIRNQT	WQFN	RNQ	40	250	210.0	185.0	35.0
TUSB1046AI-DCIRNQR	WQFN	RNQ	40	3000	367.0	367.0	35.0
TUSB1046AI-DCIRNQT	WQFN	RNQ	40	250	210.0	185.0	35.0

EXAMPLE BOARD LAYOUT

RNQ0040A

WQFN - 0.8 mm max height

PLASTIC QUAD FLATPACK - NO LEAD

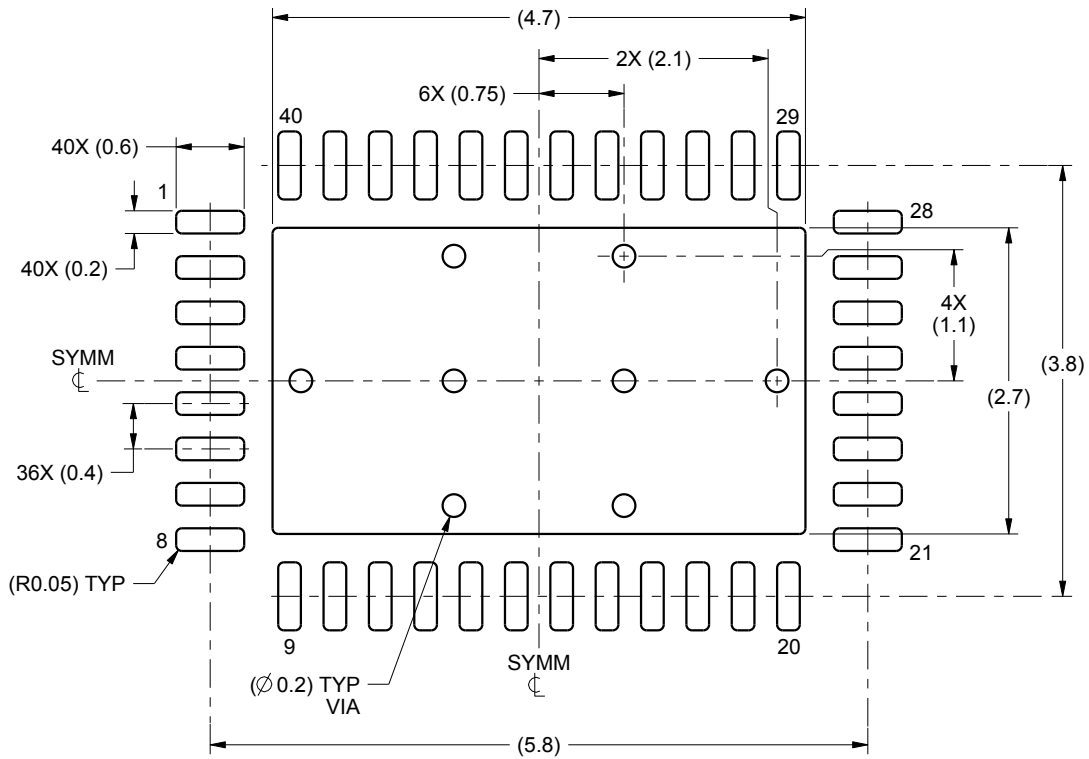

LAND PATTERN EXAMPLE
SCALE:15X

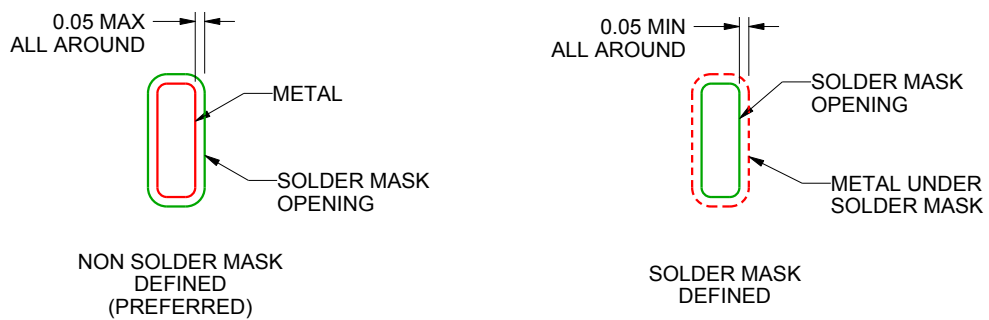

SOLDER MASK DETAILS

4222125/B 01/2016

NOTES: (continued)

- This package is designed to be soldered to a thermal pad on the board. For more information, see Texas Instruments literature number SLUA271 (www.ti.com/lit/slua271).

EXAMPLE STENCIL DESIGN

RNQ0040A

WQFN - 0.8 mm max height

PLASTIC QUAD FLATPACK - NO LEAD

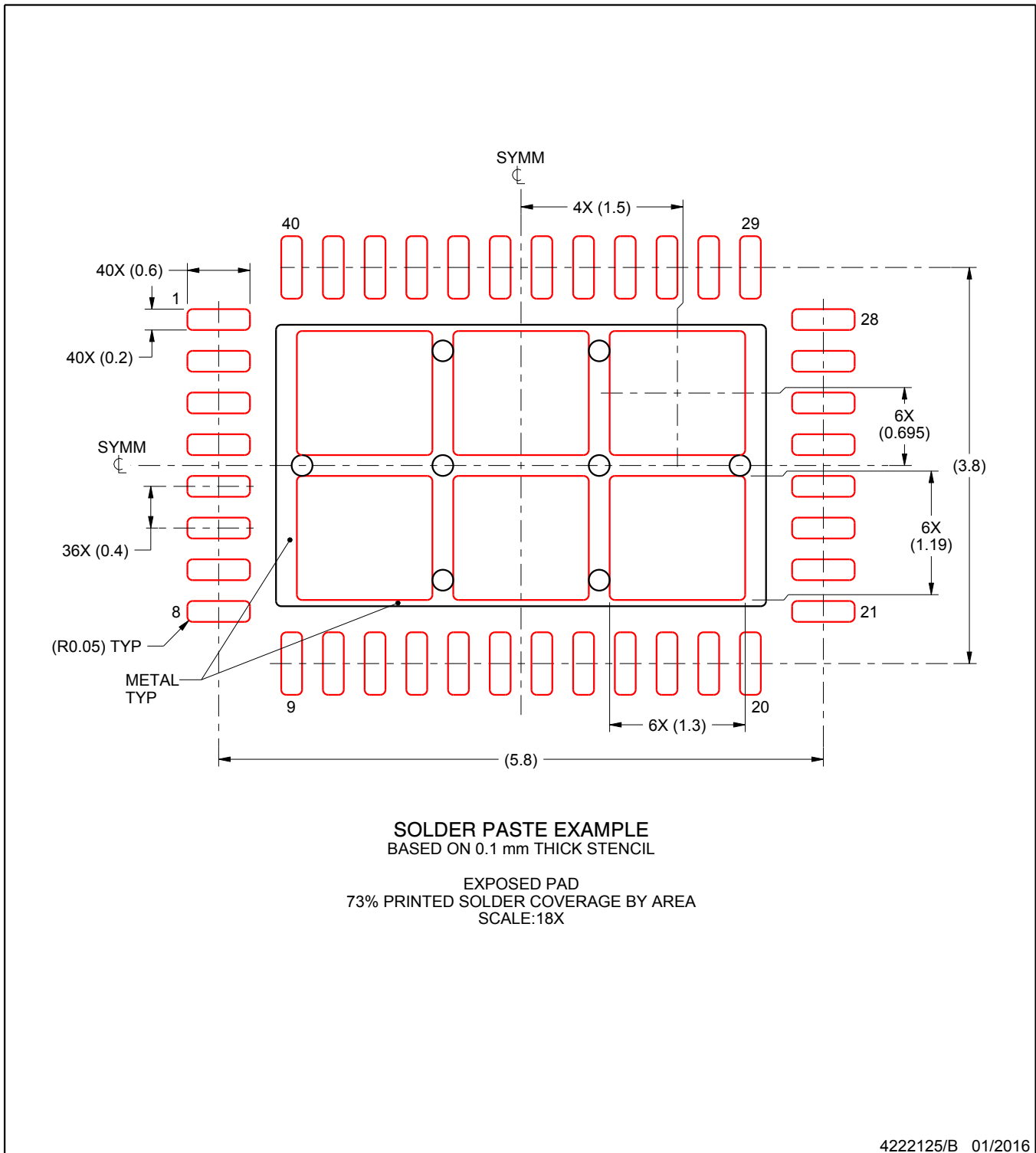

NOTES: (continued)

5. Laser cutting apertures with trapezoidal walls and rounded corners may offer better paste release. IPC-7525 may have alternate design recommendations.

重要声明和免责声明

TI“按原样”提供技术和可靠性数据（包括数据表）、设计资源（包括参考设计）、应用或其他设计建议、网络工具、安全信息和其他资源，不保证没有瑕疵且不做任何明示或暗示的担保，包括但不限于对适销性、某特定用途方面的适用性或不侵犯任何第三方知识产权的暗示担保。

这些资源可供使用 TI 产品进行设计的熟练开发人员使用。您将自行承担以下全部责任：(1) 针对您的应用选择合适的 TI 产品，(2) 设计、验证并测试您的应用，(3) 确保您的应用满足相应标准以及任何其他功能安全、信息安全、监管或其他要求。

这些资源如有变更，恕不另行通知。TI 授权您仅可将这些资源用于研发本资源所述的 TI 产品的应用。严禁对这些资源进行其他复制或展示。您无权使用任何其他 TI 知识产权或任何第三方知识产权。您应全额赔偿因在这些资源的使用中对 TI 及其代表造成的任何索赔、损害、成本、损失和债务，TI 对此概不负责。

TI 提供的产品受 [TI 的销售条款](#) 或 [ti.com](#) 上其他适用条款/TI 产品随附的其他适用条款的约束。TI 提供这些资源并不会扩展或以其他方式更改 TI 针对 TI 产品发布的适用的担保或担保免责声明。

TI 反对并拒绝您可能提出的任何其他或不同的条款。

邮寄地址：Texas Instruments, Post Office Box 655303, Dallas, Texas 75265

Copyright © 2022，德州仪器 (TI) 公司