

UCC12041-Q1 高效、低 EMI、3kV_{RMS} Basic 隔离式直流/直流转换器

1 特性

- 采用集成变压器技术的高效直流/直流转换器
- 具有符合 AEC-Q100 标准的下列特性：
 - 器件温度等级 1：-40°C 至 125°C 的工作环境温度范围
- 提供功能安全型
 - 可帮助进行功能安全系统设计的文档
- 输出功率（典型值）：500mW
- 5V 或 3.3V 稳压输出，具有可选的 400mV 净空电压为 LDO 供电
- 输入电压：4.5V 至 5.5V
- 稳健可靠的隔离栅：
 - 隔离等级：3kV_{RMS}
 - 浪涌能力：6.5kV_{PK}
 - 工作电压：850V_{RMS}
 - 最低 CMTI：100V/ns
- 热关断
- 短路恢复
- 16 引脚宽体 SOIC 封装，爬电距离和间隙大于 8mm
- 工作温度范围：-40°C 至 125°C
- 安全相关认证（计划）：
 - DIN V VDE V 0884-11:2017-01
 - 符合 UL 1577 标准且长达 1 分钟的 3000V_{RMS} 隔离
 - 符合 IEC 60950-1 和 IEC 62368-1 终端设备标准的 UL 认证
 - 符合 GB4943.1-2011 的 CQC 认证

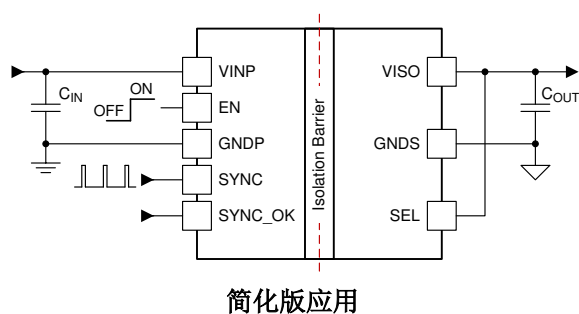

2 应用和用途

- 车载充电器
- 电池管理系统
- 牵引逆变器
- 用于 HEV/EV 的直流/直流转换器

3 说明

UCC12041-Q1 是一款具有 3kV_{RMS} basic 隔离额定值的汽车级直流/直流电源模块，旨在为需要偏置电源及稳压输出电压的隔离电路提供有效的隔离电源。该器件集成了具有专有架构的变压器和直流/直流控制器，可提供 500mW（典型值）的隔离功率，并具有低 EMI。

UCC12041-Q1 集成了保护功能以增强系统稳健性。该器件还具有使能引脚、同步功能以及 5V 或 3.3V 稳压输出选项（带净空电压）。UCC12041-Q1 是一种薄型、小型化解决方案，采用高度为 2.65mm（典型值）的宽体 SOIC 封装。

器件信息(1)

器件型号	封装	封装尺寸（标称值）
UCC12041-Q1	DVE SOIC (16)	10.30mm × 7.50mm

- (1) 如需了解所有可用封装，请参阅数据表末尾的可订购产品附录。

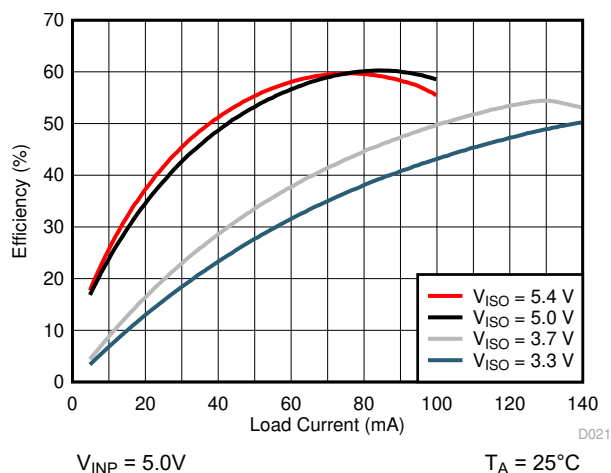

典型效率与负载间的关系



Table of Contents

1 特性	1	7.2 Functional Block Diagram.....	14
2 应用和用途	1	7.3 Feature Description.....	14
3 说明	1	7.4 Device Functional Modes.....	16
4 Revision History	2	8 Application and Implementation	17
5 Pin Configuration and Functions	3	8.1 Application Information.....	17
6 Specifications	4	8.2 Typical Application.....	17
6.1 Absolute Maximum Ratings.....	4	9 Power Supply Recommendations	23
6.2 ESD Ratings.....	4	10 Layout	23
6.3 Recommended Operating Conditions.....	4	10.1 Layout Guidelines.....	23
6.4 Thermal Information.....	4	10.2 Layout Example.....	24
6.5 Power Ratings.....	5	11 Device and Documentation Support	25
6.6 Insulation Specifications.....	5	11.1 Device Support.....	25
6.7 Safety-Related Certifications.....	6	11.2 Documentation Support.....	25
6.8 Safety Limiting Values.....	6	11.3 接收文档更新通知.....	25
6.9 Electrical Characteristics.....	7	11.4 支持资源.....	25
6.10 Switching Characteristics.....	8	11.5 Trademarks.....	25
6.11 Insulation Characteristics Curves.....	9	11.6 Electrostatic Discharge Caution.....	25
6.12 Typical Characteristics.....	10	11.7 术语表.....	25
7 Detailed Description	14	12 Mechanical and Packaging Information	25
7.1 Overview.....	14		

4 Revision History

DATE	REVISION	NOTES
June 2021	*	Initial release

5 Pin Configuration and Functions



图 5-1. DVE Package 16-Pin SOIC Top View

表 5-1. Pin Functions

PIN		TYPE ⁽¹⁾	DESCRIPTION
NAME	NO.		
EN	1	I	Enable pin. Forcing EN low disables the device. Pull high to enable normal device functionality.
GNDP	2	P	Power ground return connection for VINP.
GNDS	9	P	Connect to GNDS plane on printed circuit board. Do not use as only ground connection for VISO. Ensure pin 15 is connected to circuit ground.
	16		
GNDS	15	P	Secondary side ground return connection for VISO. Connect bypass capacitor from VISO to this pin.
NC	6	—	Pins internally connected together. No other electrical connection. Pins belong to primary-side voltage domain. Connect to GNDP on printed circuit board.
	7		
	8		
	10	—	No internal connection. Pin belongs to isolated voltage domain. Connect to GNDS on printed circuit board.
	11		
	12		
SYNC	4	I	Synchronous clock input pin. Provide a clock signal to synchronize multiple UCC12041-Q1 devices or connect to GNDP for standalone operation using the internal oscillator. If the SYNC pin is left open make sure to separate it from any switching noise to avoid false clock coupling.
SYNC_OK	5	O	Active-low, open-drain diagnostic output. Pin is asserted LOW if there is no external SYNC clock or one that is outside of the operating range of the UCC12041-Q1 is detected. In this state, the external clock is ignored and the DC/DC converter is clocked by the internal oscillator. The pin is in high-impedance if a clock is applied on SYNC.
SEL	13	I	V _{ISO} selection pin. V _{ISO} setpoint is 5.0 V when SEL is shorted to V _{ISO} , 5.4 V when SEL is connected to V _{ISO} through a 100-k Ω resistor, 3.3 V when SEL is shorted to GNDS, and 3.7 V when SEL is connected to GNDS through a 100-k Ω resistor. For more information see the §7.4 section.
VINP	3	P	Primary side input supply voltage pin. A 10- μ F ceramic capacitor to GNDP on pin 2, placed close to the device pins, is required.
VISO	14	P	Isolated supply voltage pin. A 10- μ F ceramic capacitor to GNDS on pin 15, placed close to the device pins, is required. See §8.2.2.1 section.

(1) P = Power, G = Ground, I = Input, O = Output

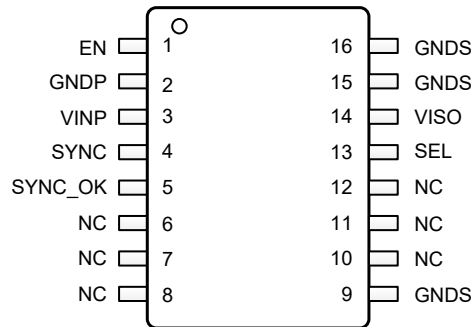
6 Specifications

6.1 Absolute Maximum Ratings

over operating free-air temperature range (unless otherwise noted)⁽¹⁾

	MIN	MAX	UNIT
V _{INP} to GNDP	- 0.3	6.0	V
EN, SYNC, SYNC_OK, to GNDP	- 0.3	V _{INP} + 0.3, ≤ 6.0	V
V _{ISO} to GNDS	- 0.3	6.0	V
SEL to GNDS	- 0.3	V _{ISO} + 0.3, ≤ 6.0	V
V _{ISO} output power at T _a = 25°C, P _{OUT_MAX} ⁽²⁾		675	mW
Operating junction temperature range, T _J	- 40	150	°C
Storage temperature, T _{stg}	- 65	150	°C

- (1) Stresses beyond those listed under *Absolute Maximum Ratings* may cause permanent damage to the device. These are stress ratings only, which do not imply functional operation of the device at these or any other conditions beyond those indicated under *Recommended Operating Conditions*. Exposure to absolute-maximum-rated conditions for extended periods may affect device reliability.
- (2) See the [V_{ISO} Load Recommended Operating Area](#) section for maximum rated values across temperature and V_{INP} conditions for each different V_{ISO} output mode.

6.2 ESD Ratings

			VALUE	UNIT
V _(ESD)	Electrostatic discharge	Human-body model (HBM), per ANSI/ESDA/JEDEC JS-001 ⁽¹⁾	±3000	V
		Charged-device model (CDM), per JEDEC specification JESD22-C101 ⁽²⁾	±1000	

- (1) JEDEC document JEP155 states that 500-V HBM allows safe manufacturing with a standard ESD control process.
- (2) JEDEC document JEP157 states that 250-V CDM allows safe manufacturing with a standard ESD control process.

6.3 Recommended Operating Conditions

over operating free-air temperature range (unless otherwise noted)

		MIN	NOM	MAX	UNIT
V _{INP}	Primary side supply voltage	4.5	5.0	5.5	V
V _{EN}	EN pin input voltage	0		5.5	V
V _{SYNC}	SYNC pin input voltage	0		5.5	V
V _{SYNC-OK}	SYNC_OK pin drain pin voltage	0		5.5	V
V _{ISO}	Isolated power supply voltage	0		5.7	V
V _{SEL}	Input voltage	0		5.7	V
f _{SYNC}	External DC/DC converter synchronization signal frequency	14.4	16.0	17.6	MHz
P _{VISO}	V _{ISO} output power at T _a = 25°C ⁽¹⁾			500	mW
T _a	Ambient temperature	- 40		125	°C
T _J	Junction temperature	- 40		150	°C

- (1) See the [§ 7.3.3](#) section for maximum rated values across temperature and V_{INP} conditions for each different V_{ISO} output mode.

6.4 Thermal Information

THERMAL METRIC ⁽¹⁾		UCC12041-Q1	UNIT
		DVE (SOIC)	
		16 PINS	
R _{θJA}	Junction-to-ambient thermal resistance	57.5	°C/W
R _{θJC(top)}	Junction-to-case (top) thermal resistance	21.6	°C/W
R _{θJB}	Junction-to-board thermal resistance	33.8	°C/W
ψ _{JT}	Junction-to-top characterization parameter	10.2	°C/W
ψ _{JB}	Junction-to-board characterization parameter	33.7	°C/W

6.4 Thermal Information (continued)

THERMAL METRIC ⁽¹⁾		UCC12041-Q1	UNIT
		DVE (SOIC)	
		16 PINS	
$R_{\theta JC(bot)}$	Junction-to-case (bottom) thermal resistance	—	°C/W

(1) The value of $R_{\theta JA}$ given in this table is only valid for comparison with other packages and can not be used for design purposes. This value was calculated in accordance with JESD 51-7, and simulated on a 4-layer JEDEC board when $P_{DP} = 129$ mW, $P_{DS} = 142$ mW and $P_{DT} = 129$ mW. The board temperature is taken from Pin 12. For more information about traditional and new thermal metrics, see the [Semiconductor and IC Package Thermal Metrics](#) application report.

6.5 Power Ratings

$V_{INP} = 5.0$ V, $C_{INP} = C_{OUT} = 10$ μ F, $T_J = 150$ °C, Internal Clock mode

PARAMETER		TEST CONDITIONS	VALUE	UNIT
P_D	Power dissipation	SEL connected to GNDS (3.3-V V_{ISO} output mode), $I_{ISO} = 135$ mA	460	mW
P_{DP}	Power dissipation by driver side (primary)		148	mW
P_{DS}	Power dissipation by rectifier side (secondary)		164	mW
P_{DT}	Power dissipation by transformer		148	mW

6.6 Insulation Specifications

PARAMETER		TEST CONDITIONS	VALUE	UNIT
GENERAL				
CLR	External clearance ⁽¹⁾	Shortest terminal-to-terminal distance through air	> 8	mm
CPG	External creepage ⁽¹⁾	Shortest terminal-to-terminal distance across the package surface	> 8	mm
DTI	Distance through the insulation	Minimum internal gap (internal clearance)	> 120	μ m
CTI	Comparative tracking index	DIN EN 60112 (VDE 0303-11); IEC 60112	> 600	V
	Material group	According to IEC 60664-1	I	
	Overvoltage Category	Rated mains voltage ≤ 300 V_{RMS}	I-IV	
		Rated mains voltage ≤ 600 V_{RMS}	I-IV	
		Rated mains voltage ≤ 1000 V_{RMS}	I-III	
DIN V VDE V 0884-11:2017-01⁽²⁾ (Planned Certification Targets)				
V_{IORM}	Maximum repetitive peak isolation voltage	AC voltage (bipolar)	1202	V_{PK}
V_{IOWM}	Maximum working isolation voltage	AC voltage (sine wave) Time dependent dielectric breakdown (TDDDB) test	850	V_{RMS}
		DC voltage	1202	V_{DC}
V_{IOTM}	Maximum transient isolation voltage	$V_{TEST} = V_{IOTM}$, $t = 60$ s (qualification); $V_{TEST} = 1.2 \times V_{IOTM}$, $t = 1$ s (100% production)	4243	V_{PK}
V_{IOSM}	Maximum surge isolation voltage ⁽³⁾	Test method per IEC 62368-1, 1.2/50 μ s waveform, $V_{TEST} = 1.3 \times V_{IOSM} = 6500$ V_{PK} (qualification)	5000	V_{PK}
q_{pd}	Apparent charge ⁽⁴⁾	Method a: After I/O safety test subgroup 2/3, $V_{ini} = V_{IOTM}$, $t_{ini} = 60$ s; $V_{pd(m)} = 1.2 \times V_{IORM} = 1442$ V_{PK} , $t_m = 10$ s	≤ 5	pC
		Method a: After environmental tests subgroup 1, $V_{ini} = V_{IOTM}$, $t_{ini} = 60$ s; $V_{pd(m)} = 1.2 \times V_{IORM} = 1442$ V_{PK} , $t_m = 10$ s	≤ 5	
		Method b1: At routine test (100% production) and preconditioning (type test) $V_{ini} = 1.2 \times V_{IOTM}$, $t_{ini} = 1$ s; $V_{pd(m)} = 1.5 \times V_{IORM} = 1803$ V_{PK} , $t_m = 1$ s	≤ 5	
C_{IO}	Barrier capacitance, input to output ⁽⁵⁾	$V_{IO} = 0.4 \sin(2\pi ft)$, $f = 1$ MHz	3.5	pF
R_{IO}	Isolation resistance, input to output ⁽⁵⁾	$V_{IO} = 500$ V, $T_A = 25$ °C	$> 10^{12}$	Ω
		$V_{IO} = 500$ V, 100 °C $\leq T_A \leq 125$ °C	$> 10^{11}$	
		$V_{IO} = 500$ V at $T_S = 150$ °C	$> 10^9$	
	Pollution degree		2	
	Climatic category		40/125/21	

6.6 Insulation Specifications (continued)

PARAMETER		TEST CONDITIONS	VALUE	UNIT
UL 1577 (Planned Certification Target)				
V_{ISO}	Withstand isolation voltage	$V_{TEST} = V_{ISO} = 3000 V_{RMS}$, $t = 60$ s (qualification); $V_{TEST} = 1.2 \times V_{ISO} = 3600 V_{RMS}$, $t = 1$ s (100% production)	3000	V_{RMS}

- Creepage and clearance requirements should be applied according to the specific equipment isolation standards of an application. Care should be taken to maintain the creepage and clearance distance of a board design to ensure that the mounting pads of the isolator on the printed-circuit board do not reduce this distance. Creepage and clearance on a printed-circuit board become equal in certain cases. Techniques such as inserting grooves and/or ribs on a printed circuit board are used to help increase these specifications.
- This coupler is suitable for *basic insulation* only within the maximum operating ratings. Compliance with the safety ratings are ensured by means of suitable protective circuits.
- Testing is carried out in air or oil to determine the intrinsic surge immunity of the isolation barrier.
- Apparent charge is electrical discharge caused by a partial discharge (pd).
- All pins on each side of the barrier tied together creating a two-terminal device.

6.7 Safety-Related Certifications

VDE	UL	UL	CQC
Plan to certify according to DIN V VDE V 0884-11:2017-01	Plan to certify according to IEC 60950-1 and IEC 62368-1	Plan to certify under UL 1577 Component Recognition Program	Plan to certify according to GB4943.1-2011
Basic insulation Maximum transient isolation voltage, 4243 VPK; Maximum repetitive peak isolation voltage, 1202 VPK; Maximum surge isolation voltage, 5000 VPK	Basic insulation per UL 60950-1-07+A1+A2, IEC 60950-1 2nd Ed.+A1+A2, UL 62368-1-14 and IEC 62368-1 2nd Ed., 850 VRMS maximum working voltage (pollution degree 1, material group I)	Single protection, 3000 VRMS	Basic insulation, Altitude ≤ 5000 m, Tropical Climate, 595 V_{RMS} maximum working voltage
Certificate number: (planned)	Master contract number: (planned)	File number: (planned)	Certificate number: (planned)

6.8 Safety Limiting Values

Safety limiting intends to minimize potential damage to the isolation barrier upon failure of input or output circuitry, resulting in zero power delivered to V_{ISO} and all the power being dissipated inside the device.

PARAMETER	TEST CONDITIONS	MAX	UNIT	
I_S	Safety input current ⁽¹⁾	$R_{\theta JA} = 57.5^\circ\text{C/W}$, $V_I = 5.5$ V, $T_J = 150^\circ\text{C}$, $T_A = 25^\circ\text{C}$ (see Fig 6-2)	395	mA
		$R_{\theta JA} = 57.5^\circ\text{C/W}$, $V_I = 4.5$ V, $T_J = 150^\circ\text{C}$, $T_A = 25^\circ\text{C}$ (see Fig 6-2)	483	
P_S	Safety input power	$R_{\theta JA} = 57.5^\circ\text{C/W}$, $T_J = 150^\circ\text{C}$, $T_A = 25^\circ\text{C}$ (see Fig 6-3)	2174	mW
T_S	Safety temperature ⁽¹⁾		150	$^\circ\text{C}$

- The maximum safety temperature, T_S , has the same value as the maximum junction temperature, T_J , specified for the device. The I_S and P_S parameters represent the safety current and safety power respectively. The maximum limits of I_S and P_S should not be exceeded. These limits vary with the ambient temperature, T_A .
The junction-to-air thermal resistance, $R_{\theta JA}$, in the [Thermal Information](#) table is that of a device installed on a high-K test board for leaded surface-mount packages. Use these equations to calculate the value for each parameter:
 $T_J = T_A + R_{\theta JA} \times P$, where P is the power dissipated in the device.
 $T_{J(max)} = T_S = T_A + R_{\theta JA} \times P_S$, where $T_{J(max)}$ is the maximum allowed junction temperature.
 $P_S = I_S \times V_I$, where V_I is the maximum input voltage.

6.9 Electrical Characteristics

Over operating temperature range ($T_J = -40^{\circ}\text{C}$ to 150°C), $V_{\text{INP}} = 4.5\text{V}$ to 5.5V , $C_{\text{INP}} = C_{\text{OUT}} = 10\ \mu\text{F}$, internal clock mode, unless otherwise noted. All typical values at $T_A = 25^{\circ}\text{C}$ and $V_{\text{INP}} = 5.0\text{V}$.

	PARAMETER	TEST CONDITIONS	MIN	TYP	MAX	UNIT
INPUT SUPPLY						
I_{VINQ}	VINP quiescent current, disabled	EN=LOW			100	μA
I_{VINO}	VINP operating current, no load	EN=HI; SEL shorted to VISO (5.0-V output)		52	80	mA
		EN=HI; SEL 100 k Ω to VISO (5.4-V output)		48	70	
		EN=HI; SEL shorted to GNDS (3.3-V output)		96	140	
		EN=HI; SEL 100 k Ω to GNDS (3.7-V output)		82	120	
$I_{\text{VIN_SC}}$	DC current from VINP supply under short circuit on VISO	VISO short to GNDS		245		mA
V_{UVPR}	VINP under-voltage lockout rising threshold			4.25	4.45	V
V_{UVPF}	VINP under-voltage lockout falling threshold		3.5	3.75		V
V_{UVPH}	VINP under-voltage lockout hysteresis			0.5		V
EN, SYNC INPUT PINS						
V_{IR}	Input voltage threshold, logic HIGH	Rising edge			2.2	V
V_{IF}	Input voltage threshold, logic LOW	Falling edge	0.8			V
I_{EN}	Enable Pin Input Current	$V_{\text{EN}} = 5.0\ \text{V}$		5	10	μA
I_{SYNC}	SYNC Pin Input Current	$V_{\text{SYNC}} = 5.0\ \text{V}$		0.02	1	μA
SYNC_OK PIN						
V_{OL}	SYNC_OK output low voltage	$I_{\text{SYNC_OK}} = -2\ \text{mA}$		0.15		V
$I_{\text{LKG_SYNC_OK}}$	SYNC_OK pin leakage current	$V_{\text{SYNC_OK}} = 5.0\ \text{V}$			1	μA
DC/DC CONVERTER						
V_{ISO}	Isolated supply output voltage	SEL shorted to VISO (5.0-V output); $I_{\text{ISO}} = 55\ \text{mA}$ ⁽³⁾	4.8	5	5.2	V
		SEL 100 k Ω to VISO (5.4-V output); $I_{\text{ISO}} = 45\ \text{mA}$ ⁽³⁾	5.18	5.4	5.62	V
		SEL shorted to GNDS (3.3-V output); $I_{\text{ISO}} = 100\ \text{mA}$ ⁽³⁾	3.17	3.3	3.43	V
		SEL 100k Ω to GNDS (3.7-V output); $I_{\text{ISO}} = 90\ \text{mA}$ ⁽³⁾	3.55	3.7	3.85	V
$V_{\text{ISO(RIP)}}$	Voltage ripple on isolated supply output (pk-pk) ⁽¹⁾	20-MHz bandwidth, CLOAD = 10 μF 0.1 μF , SEL shorted to VISO (5.0-V output); $I_{\text{ISO}} = 100\ \text{mA}$		50		mV
		20-MHz bandwidth, CLOAD = 10 μF 0.1 μF , SEL 100 k Ω to VISO (5.4-V output); $I_{\text{ISO}} = 90\ \text{mA}$		50		mV
		20-MHz bandwidth, CLOAD = 10 μF 0.1 μF , SEL shorted to GNDS (3.3-V output); $I_{\text{ISO}} = 145\ \text{mA}$		50		mV
		20-MHz bandwidth, CLOAD = 10 μF 0.1 μF , SEL shorted to GNDS (3.7-V output); $I_{\text{ISO}} = 130\ \text{mA}$		50		mV
$V_{\text{ISO(LINE)}}$	V_{ISO} DC line regulation	SEL shorted to VISO (5.0-V output); $I_{\text{ISO}} = 55\ \text{mA}$, $V_{\text{INP}} = 4.5\ \text{V}$ to $5.5\ \text{V}$			1%	
		SEL shorted to GNDS (3.3-V output); $I_{\text{ISO}} = 100\ \text{mA}$, $V_{\text{INP}} = 4.5\ \text{V}$ to $5.5\ \text{V}$			1%	

6.9 Electrical Characteristics (continued)

Over operating temperature range ($T_J = -40^\circ\text{C}$ to 150°C), $V_{INP} = 4.5\text{V}$ to 5.5V , $C_{INP} = C_{OUT} = 10\ \mu\text{F}$, internal clock mode, unless otherwise noted. All typical values at $T_A = 25^\circ\text{C}$ and $V_{INP} = 5.0\text{V}$.

	PARAMETER	TEST CONDITIONS	MIN	TYP	MAX	UNIT
$V_{ISO(Load)}$	V_{ISO} DC load regulation	SEL shorted to VISO (5.0-V output); $I_{ISO} = 0$ to 100 mA		1.5%		
		SEL shorted to GNDS (3.3-V output); $I_{ISO} = 0$ to 145 mA		1.5%		
EFF	Efficiency at maximum recommended load ⁽²⁾	SEL shorted to VISO (5.0-V output); $I_{ISO} = 100$ mA		60%		
		SEL 100 k Ω to VISO (5.4-V output); $I_{ISO} = 90$ mA		60%		
		SEL shorted to GNDS (3.3-V output); $I_{ISO} = 145$ mA		50%		
		SEL 100 k Ω to GNDS (3.7-V output); $I_{ISO} = 130$ mA		53%		
t_{RISE}	VISO rise time, 10% - 90%	EN = change from LO to HI, SEL shorted to VISO (5.0-V output); $I_{ISO} = 1$ mA		750	1000	μs
		EN = change from LO to HI, SEL 100 k Ω to GNDS (3.3-V output); $I_{ISO} = 1$ mA		300	500	μs
THERMAL SHUTDOWN						
TSD_{THR}	Thermal shutdown threshold ⁽¹⁾	Junction Temperature, Rising		165		$^\circ\text{C}$
TSD_{HYST}	Thermal shutdown hysteresis ⁽¹⁾	Junction Temperature, Falling		27		$^\circ\text{C}$

(1) Not tested in production. Ensured by characterization.

(2) Efficiency calculation: $EFF = (V_{ISO} \times I_{ISO}) / (V_{INP} \times I_{INP})$.

(3) See the [VISO Load Recommended Operating Area](#) section for discussion of V_{ISO} regulation across load and temperature conditions for all output voltage settings.

6.10 Switching Characteristics

Over operating temperature range ($T_J = -40^\circ\text{C}$ to 150°C), $V_{INP} = 4.5\text{V}$ to 5.5V , $C_{INP} = C_{OUT} = 10\ \mu\text{F}$, internal clock mode, unless otherwise noted. All typical values at $T_A = 25^\circ\text{C}$ and $V_{INP} = 5.0\text{V}$.

	PARAMETER	TEST CONDITIONS	MIN	TYP	MAX	UNIT
f_{SW_INT}	DC/DC Converter Clock	Internal clock mode		8		MHz
CMTI	Static common-mode transient immunity ⁽¹⁾	Slew Rate of GNDS versus GNDS, $V_{CM} = 1000\ \text{V}$	100			V/ns

(1) Not tested in production. Ensured by characterization.

6.11 Insulation Characteristics Curves

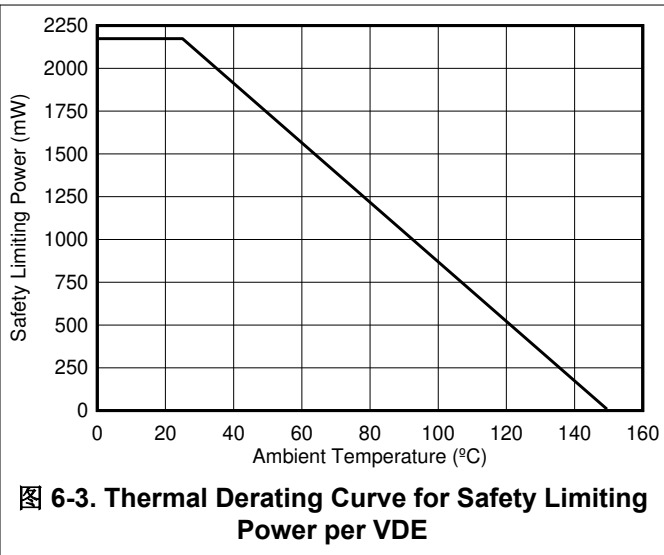
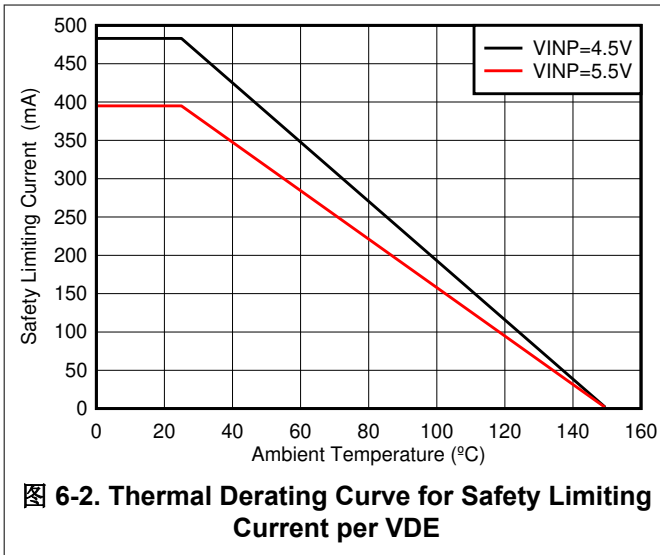
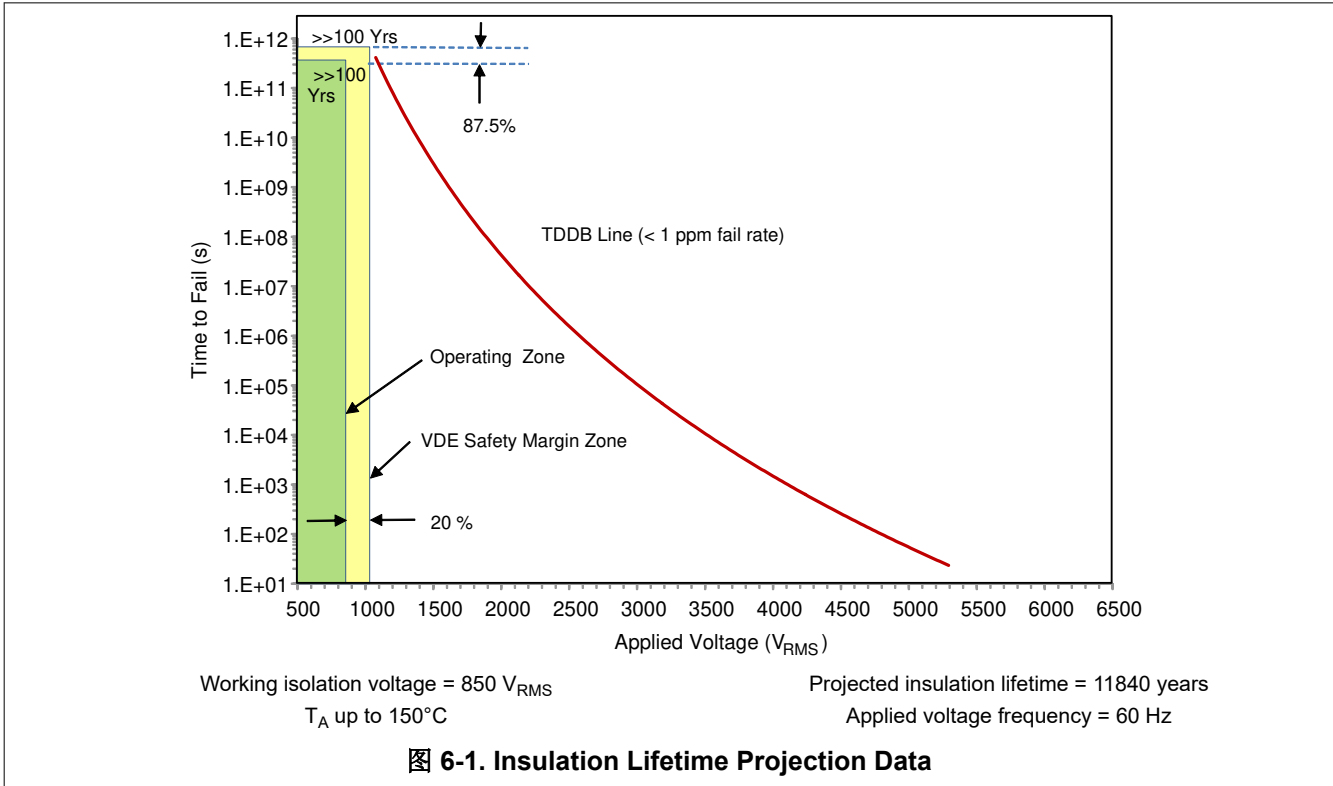

6.12 Typical Characteristics



图 6-4. Maximum V_{ISO} Output Power vs. Temperature



图 6-5. Maximum V_{ISO} Output Power vs. Temperature

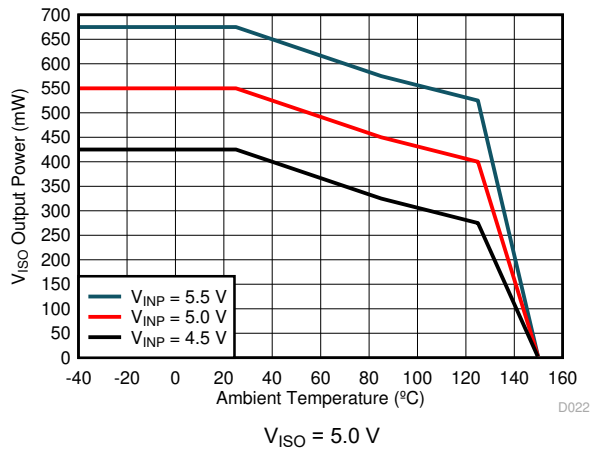

图 6-6. Maximum V_{ISO} Output Power vs. Temperature

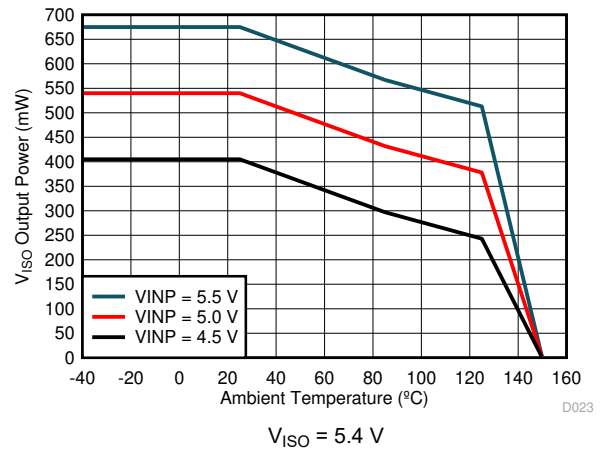

图 6-7. Maximum V_{ISO} Output Power vs. Temperature

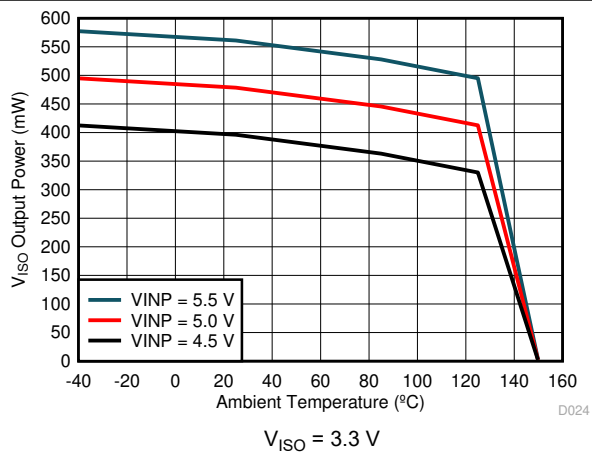

图 6-8. Maximum V_{ISO} Output Current vs. Temperature

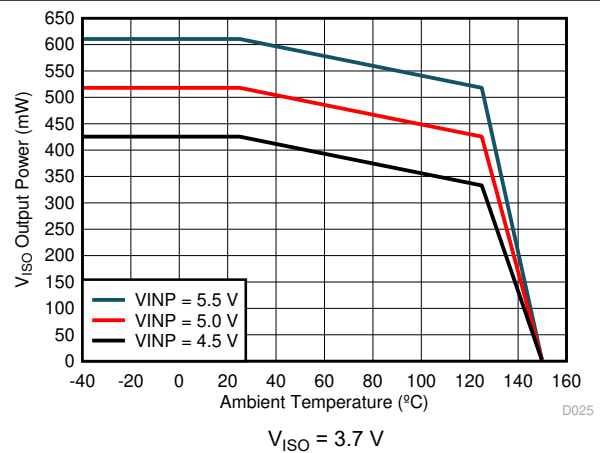

图 6-9. Maximum V_{ISO} Output Current vs. Temperature

6.12 Typical Characteristics (continued)

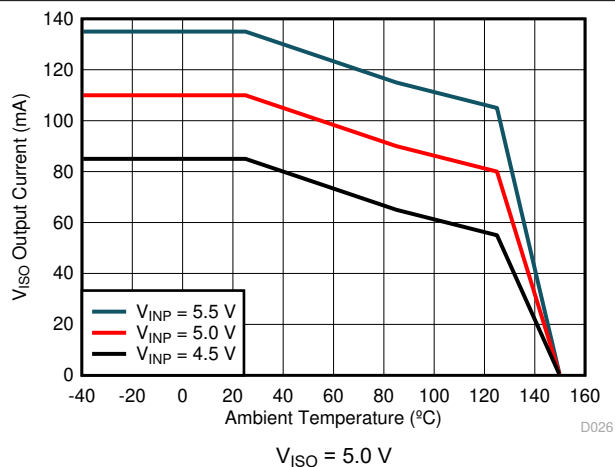

图 6-10. Maximum V_{ISO} Output Current vs. Temperature

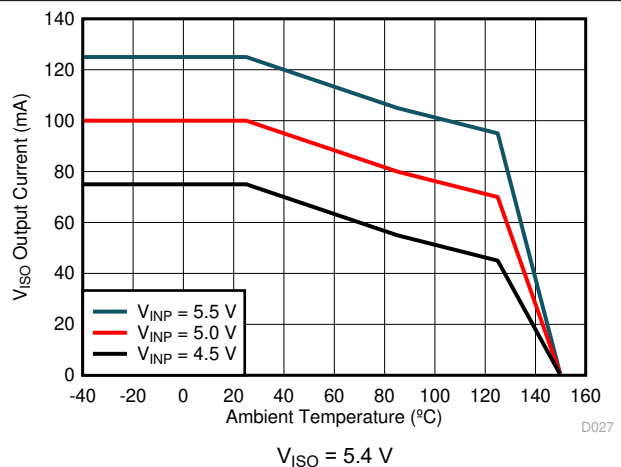

图 6-11. Maximum V_{ISO} Output Current vs. Temperature

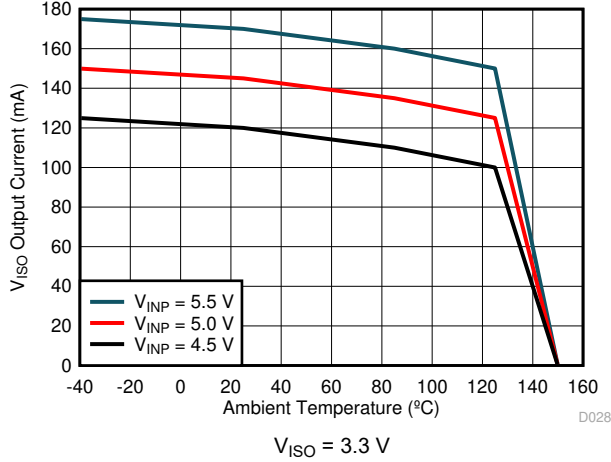

图 6-12. Power Supply Efficiency vs Load Current (I_{ISO})

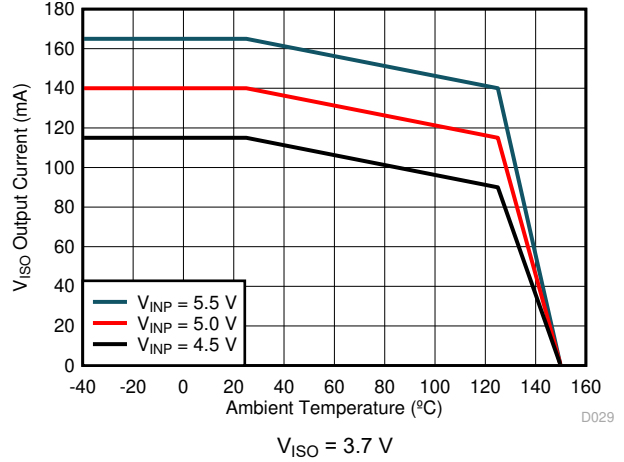

图 6-13. Power Supply Efficiency vs Load Current (I_{ISO})

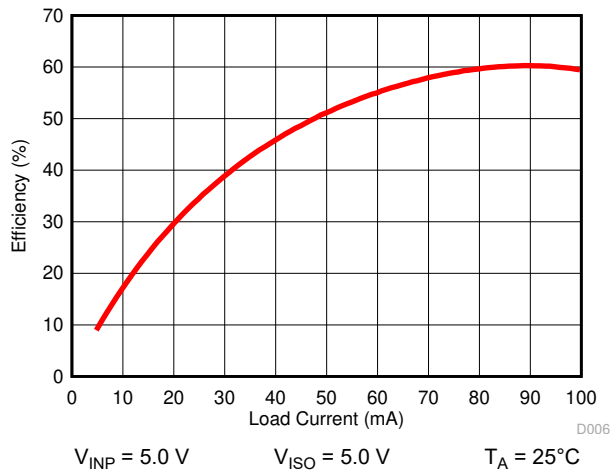

图 6-14. Power Supply Efficiency vs Load Current (I_{ISO})

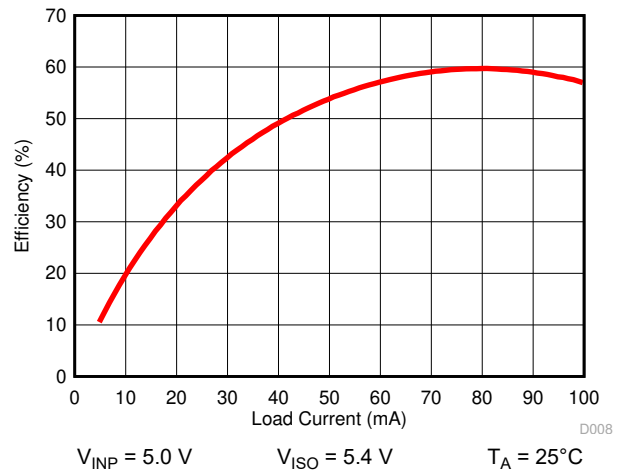

图 6-15. Power Supply Efficiency vs Load Current (I_{ISO})

6.12 Typical Characteristics (continued)

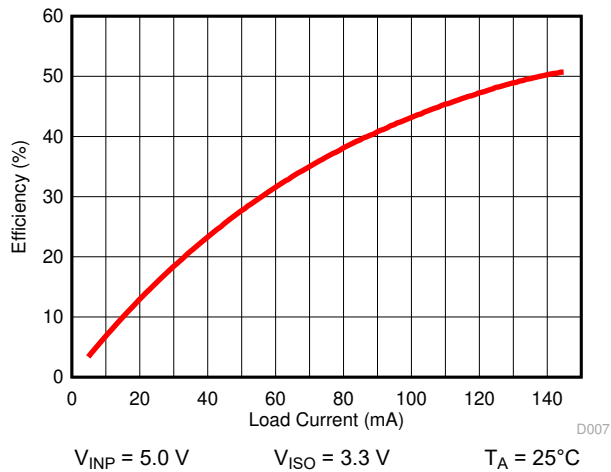

图 6-16. Isolated Supply Voltage (V_{ISO}) vs Load Current (I_{ISO})

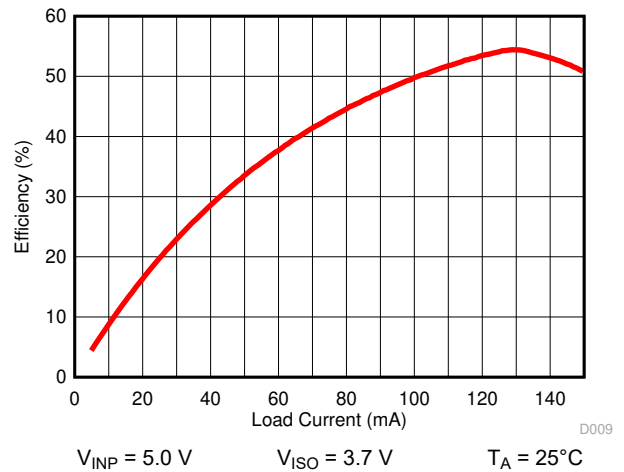

图 6-17. Isolated Supply Voltage (V_{ISO}) vs Load Current (I_{ISO})

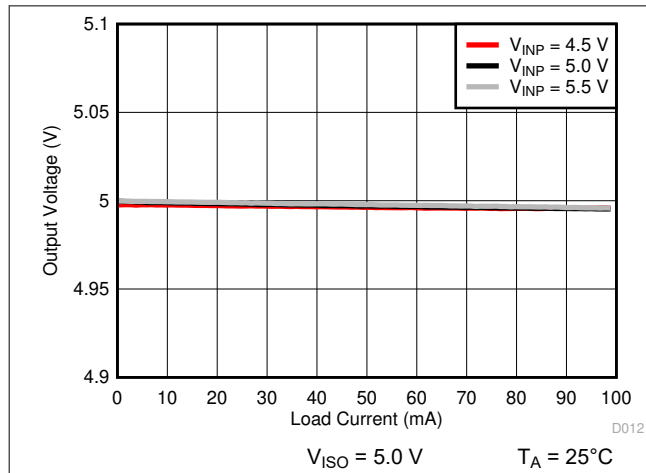

图 6-18. Isolated Supply Voltage (V_{ISO}) vs Load Current (I_{ISO})

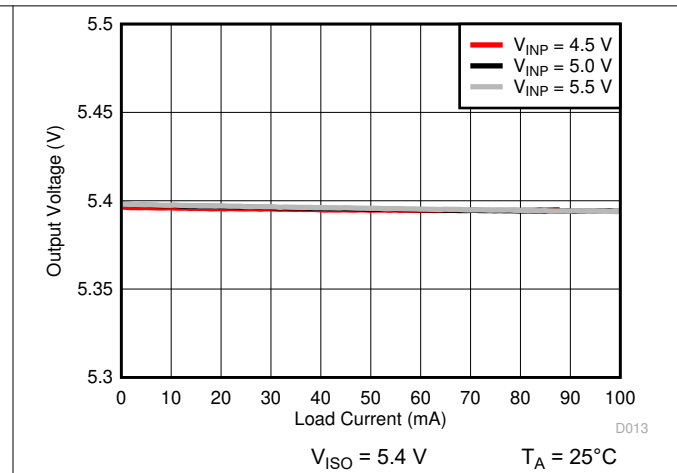

图 6-19. Isolated Supply Voltage (V_{ISO}) vs Load Current (I_{ISO})

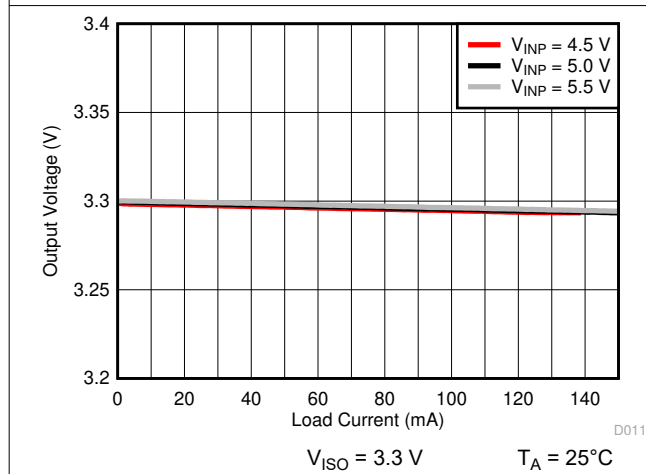

图 6-20. Isolated Supply Voltage (V_{ISO}) vs Free-Air Temperature

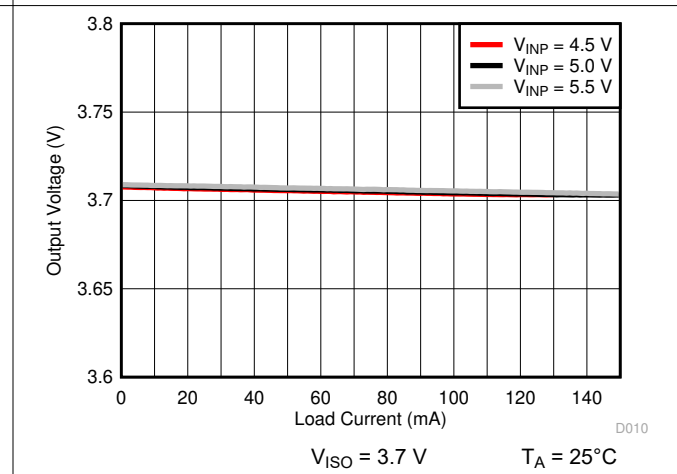

图 6-21. Isolated Supply Voltage (V_{ISO}) vs Free-Air Temperature

6.12 Typical Characteristics (continued)

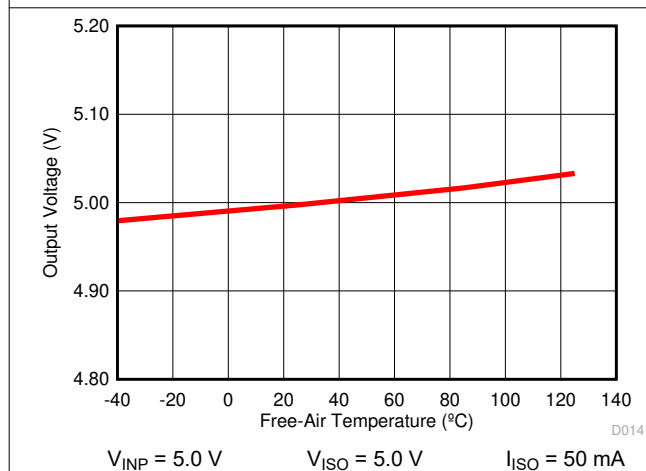

图 6-22. Isolated Supply Voltage (V_{ISO}) vs Free-Air Temperature

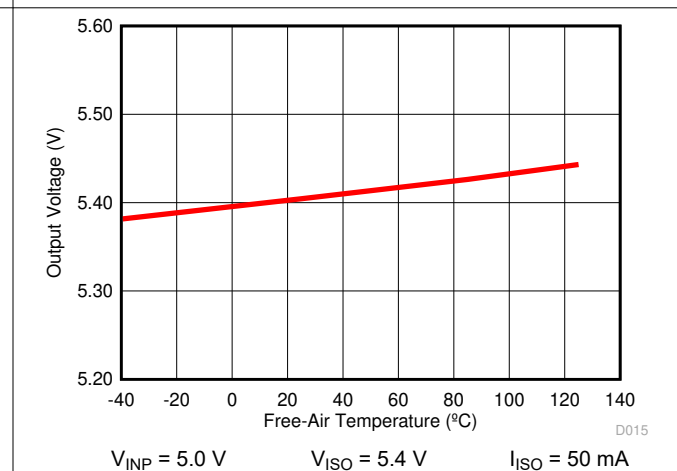

图 6-23. Isolated Supply Voltage (V_{ISO}) vs Free-Air Temperature

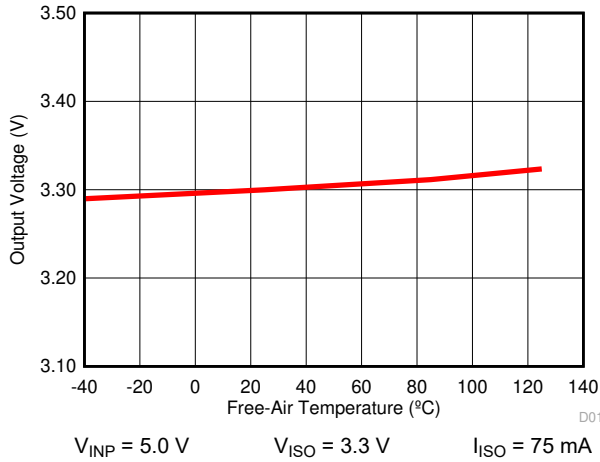

图 6-24. Short-Circuit Supply Current (I_{VIN_SC}) vs Supply Voltage (V_{INP})

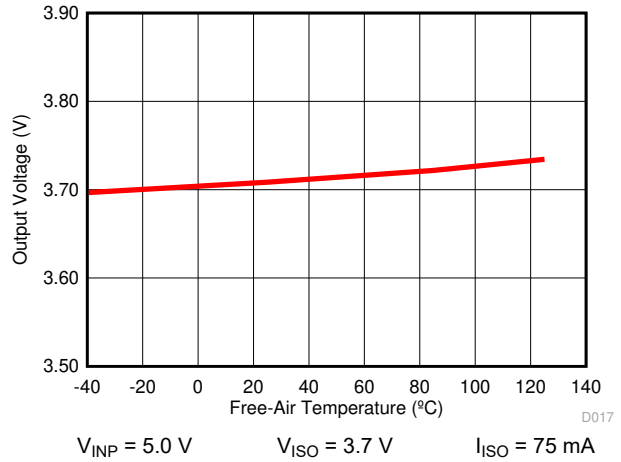

图 6-25. Input Supply Current (I_{VINP}) vs Load Current (I_{ISO})

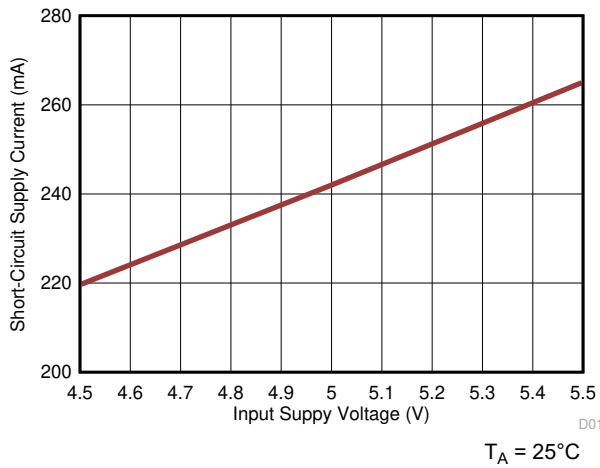

图 6-26. Typical V_{INP} UVLO Threshold vs Junction Temperature (T_J)

7 Detailed Description

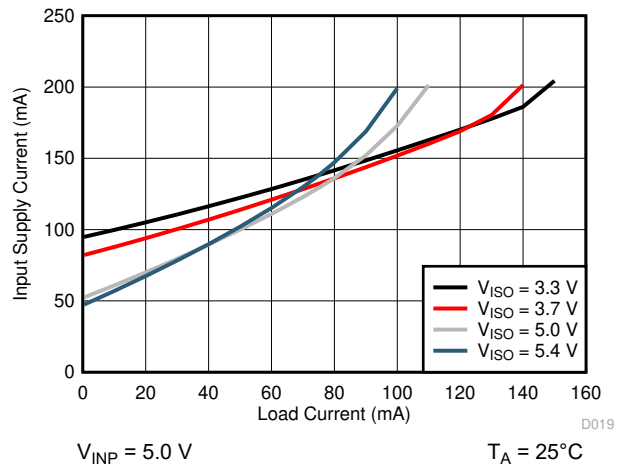
7.1 Overview

The UCC12041-Q1 device integrates a high-efficiency, low-emissions isolated DC/DC converter. This approach provides typically 500 mW of clean, steady power across a 3000- V_{RMS} basic isolation barrier.

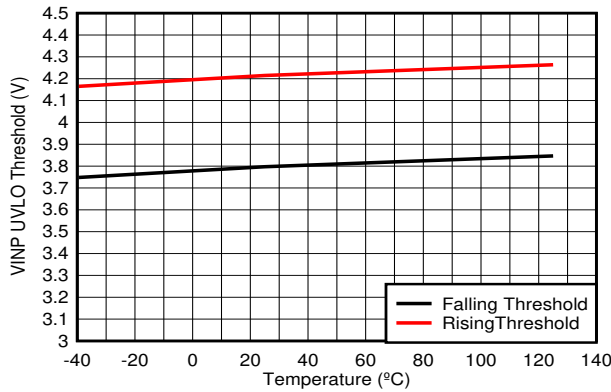
The integrated DC/DC converter uses switched mode operation and proprietary circuit techniques to reduce power losses and boost efficiency. Specialized control mechanisms, clocking schemes, and the use of an on-chip transformer provide high efficiency and low radiated emissions.

The VINP supply is provided to the primary power controller that switches the power stage connected to the integrated transformer. Power is transferred to the secondary side, rectified, and regulated to a level set by the SEL pin condition.

A fast feedback control loop monitors VISO and the output load, and ensures low overshoots and undershoots during load transients. Undervoltage lockout (UVLO) with hysteresis is integrated on the VINP supply, which ensures robust system performance under noisy conditions.

UCC12041-Q1 is suitable for applications that have limited board space and require more integration. These devices are also suitable for very-high voltage applications, where power transformers meeting the required isolation specifications are bulky and expensive.

7.2 Functional Block Diagram

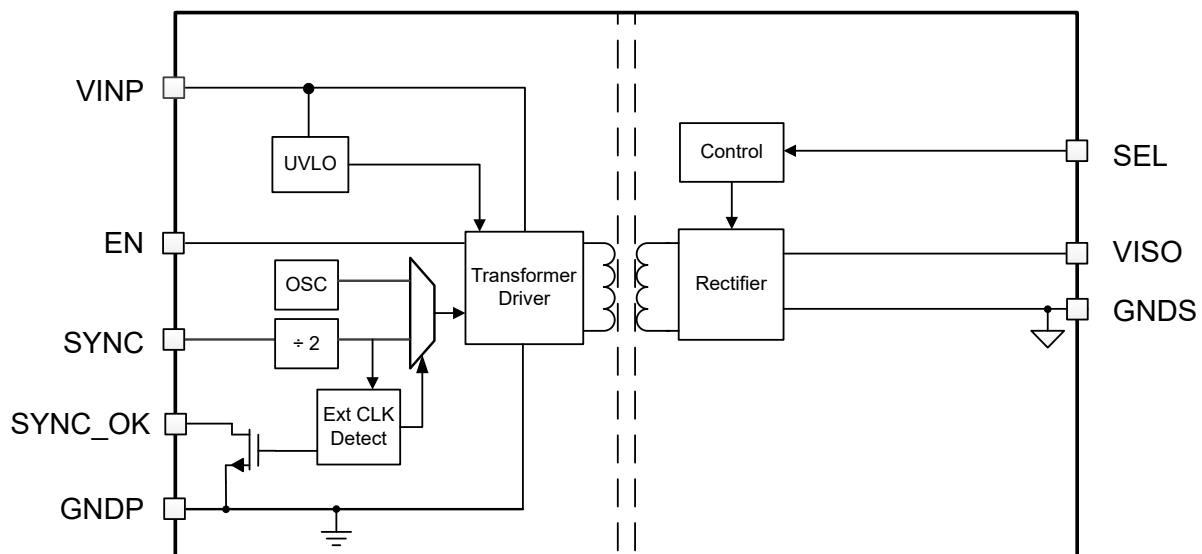

7.3 Feature Description

7.3.1 Enable and Disable

Forcing EN low disables the device, which greatly reduces the VINP power consumption. Pull the EN pin high to enable normal device functionality. The EN pin has a weak internal pull-down resistor, so the device floats to the disable state if the pin is left open.

7.3.2 UVLO, Power-Up, and Power-Down Behavior

The UCC12041-Q1 has an undervoltage lockout (UVLO) on the VINP power supply. Upon power-up, while the VINP voltage is below the threshold voltage V_{UVPR} , the primary side transformer driver is disabled, and VISO output is off. The output powers up once the threshold is met. Likewise, if VINP falls below V_{UVPF} , the converter is disabled and there is no output at VISO. Both UVLO threshold voltages have hysteresis to avoid chattering.

7.3.3 V_{ISO} Load Recommended Operating Area

图 7-1 depicts the device V_{ISO} regulation behavior across the output load range, including when the output is overloaded. For proper device operation, ensure that the device V_{ISO} output load does not exceed the maximum output current (I_{OUT_MAX}). The value for I_{OUT_MAX} over different temperature and V_{INP} conditions are shown from 图 6-8 to 图 6-11. The following protection mechanisms will be engaged if the UCC12041-Q1 is loaded beyond the recommended operating area:

1. The device limits the maximum output power. If a load exceeding I_{OUT_MAX} is applied, V_{ISO} drops accordingly to meet the maximum power limit.
2. If V_{ISO} drops below nominal 3.8 V while operating in the constant power limit region, the over-power fold-back feature will switch the power converter from active rectification to passive rectification, and the built-in recovery hysteresis will ensure the UCC12041-Q1 recovers at a lower output power. The device returns to active rectification when load drops and V_{ISO} increases above nominal 4.3 V.
3. The device triggers a soft-start reset if V_{ISO} drops below the nominal 1.8-V threshold. This reset is designed to protect the device during V_{ISO} short-circuit conditions.
4. Thermal shutdown protection disables the converter if the device is operated in any of the above regions long enough to raise the silicon junction temperature above the thermal shutdown threshold. See the 节 7.3.4 section for more details on this device feature.



图 7-1. V_{ISO} Load Recommended Operating Area Description

7.3.4 Thermal Shutdown

Thermal protection is also integrated to help prevent the device from getting damaged during overload and short-circuit conditions on the isolated output. Under these conditions, the device temperature starts to increase. When the silicon junction temperature T_j sensed at the primary side die goes above the threshold TSD_{THR} (typical $165^{\circ}C$), thermal shutdown activates and the primary controller turns off which removes the energy supplied to the V_{ISO} load, which causes the device to cool off. When the junction temperature drops approximately $27^{\circ}C$ (TSD_{HYST}) from the shutdown point, the device starts to function normally. If an overload or output short-circuit condition prevails, this protection cycle is repeated. Make sure the design prevents the device junction temperatures from reaching such high values.

7.3.5 External Clocking and Synchronization

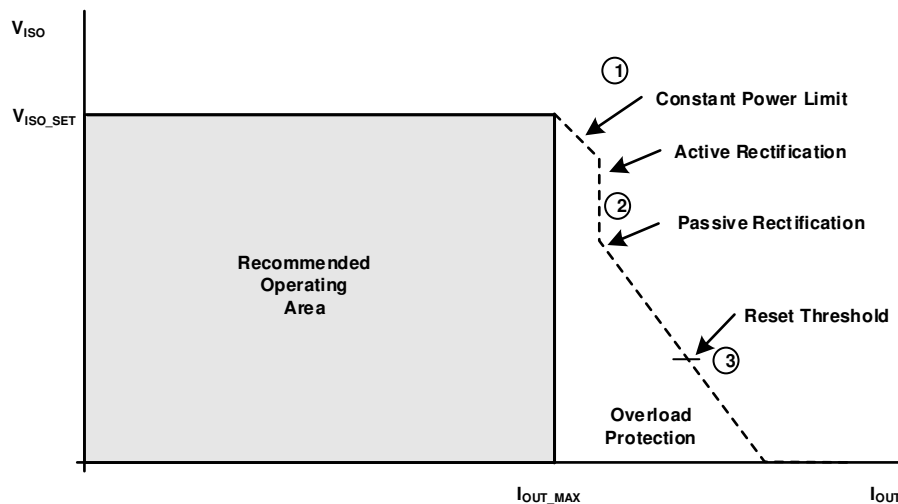
The UCC12041-Q1 has an internal oscillator trimmed to drive the transformer at 8.0 MHz. An external clock may be applied at the SYNC pin to override the internal oscillator. This external clock will be divided by 2, so the target range for the external clock signal at SYNC is 16 MHz $\pm 10\%$. When a valid external clock signal is detected, the internal spread spectrum modulation (SSM) algorithm is disabled. This allows an external clock signal with a unique SSM to be applied. The depth and frequency of SSM is a tradeoff versus low frequency modulated V_{ISO} voltage ripple. The SYNC_OK pin is asserted LOW if there is no external SYNC clock or one

that is outside of the operating range of the device is detected. In this state, the external clock is ignored and the DC/DC converter is clocked by the internal oscillator. The pin is in high-impedance if a valid clock is applied on SYNC.

7.3.6 V_{ISO} Output Voltage Selection

The SEL pin is monitored during power-up — within the first 1 ms after applying VINP above the UVLO rising threshold or enabling via the EN pin — to detect the desired regulation voltage for the VISO output. Note that after this initial monitoring, the SEL pin no longer affects the VISO output level. In order to change the output mode selection, either the EN pin must be toggled or the VINP power supply must be cycled off and back on. Section 6.4 provides more details on the SEL pin functionality.

7.3.7 Electromagnetic Compatibility (EMC) Considerations

UCC12041-Q1 devices use spread spectrum modulation algorithm for the internal oscillator and advanced internal layout scheme to minimize radiated emissions at the system level.

Many applications in harsh industrial environment are sensitive to disturbances such as electrostatic discharge (ESD), electrical fast transient (EFT), surge and electromagnetic emissions. These electromagnetic disturbances are regulated by international standards such as IEC 61000-4-x and CISPR 32. Although system-level performance and reliability depends, to a large extent, on the application board design and layout, the device incorporates many chip-level design improvements for overall system robustness.

7.4 Device Functional Modes

表 7-1 lists the supply functional modes for this device.

表 7-1. Device Functional Modes

INPUTS		Isolated Supply Output Voltage (V _{ISO}) Setpoint
EN	SEL	
HIGH	Shorted to VISO	5.0 V
HIGH	100 k Ω to VISO	5.4 V
HIGH	Shorted to GNDS	3.3 V
HIGH	100 k Ω to GNDS	3.7 V
HIGH	OPEN ⁽¹⁾	UNSUPPORTED
LOW	X	0 V

(1) The SEL pin has an internal weak pull-down resistance to ground, but leaving this pin open is not recommended.

8 Application and Implementation

备注

以下应用部分中的信息不属于 TI 器件规格的范围，TI 不担保其准确性和完整性。TI 的客户应负责确定器件是否适用于其应用。客户应验证并测试其设计，以确保系统功能。

8.1 Application Information

The UCC12041-Q1 device is suitable for applications that have limited board space and desire more integration. This device is also suitable for very high voltage applications, where power transformers meeting the required isolation specifications are bulky and expensive.

8.2 Typical Application

图 8-1 shows the typical application schematic for the UCC12041-Q1 device supplying an isolated load.



图 8-1. Typical Application

8.2.1 Design Requirements

To design using UCC12041-Q1, a few simple design considerations must be evaluated. 表 8-1 shows some recommended values for a typical application. See [Power Supply Recommendations](#) and [Layout](#) sections to review other key design considerations for the UCC12041-Q1.

表 8-1. Design Parameters

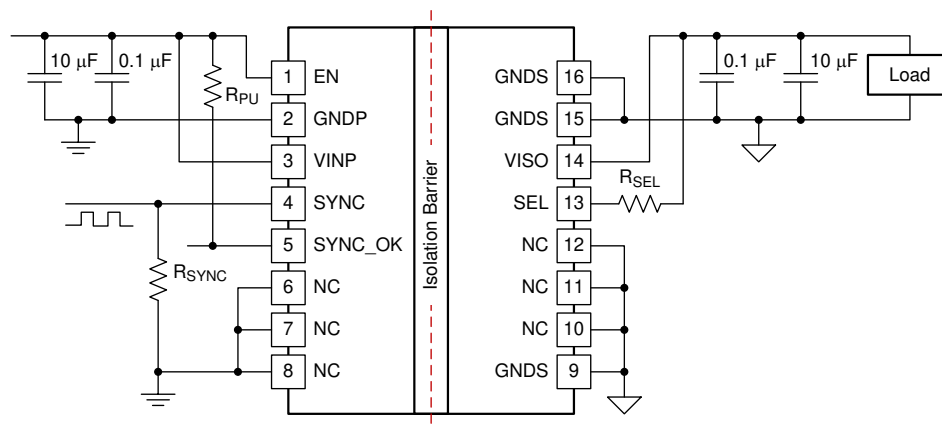
PARAMETER	RECOMMENDED VALUE
Input supply voltage, V_{INP}	4.5 V to 5.5 V
Decoupling capacitance between V_{INP} and GNDP	10 µF, 16 V, ± 10%, X7R
Decoupling capacitance between V_{ISO} and GNDS ⁽¹⁾	10 µF, 16 V, ± 10%, X7R
Optional additional capacitance on V_{ISO} or V_{INP} to reduce high-frequency ripple	0.1 µF, 50 V, ± 10%, X7R
Pull-up resistor from SYNC_OK to V_{INP} , R_{PU}	100 k Ω
Pull-up resistor from SEL to V_{ISO} for 5.0-V output voltage mode, R_{SEL}	0 Ω
Pull-up resistor from SEL to V_{ISO} for 5.4-V output voltage mode, R_{SEL}	100 k Ω
Optional SYNC signal impedance-matching resistor, R_{SYNC}	Match source — typical values are 50 Ω, 75 Ω, 100 Ω, or 1 k Ω
External clock signal applied on SYNC	16 MHz

(1) See [VISO Output Capacitor Selection](#) section.

8.2.2 Detailed Design Procedure

Place ceramic decoupling capacitors as close as possible to the device pins. For the input supply, place the capacitor(s) between pin 3 (VINP) and pin 2 (GNDP). For the isolated output supply, place the capacitor(s) between pin 14 (VISO) and pin 15 (GNDS). This location is of particular importance to the input decoupling capacitor, because this capacitor supplies the transient current associated with the fast switching waveforms of the power drive circuits. The recommended capacitor value is 10 μF . Ensure the capacitor dielectric material is compatible with the target application temperature.

8.2.2.1 VISO Output Capacitor Selection

The UCC12041-Q1 is optimized to run with an effective output capacitance of 5 μF to 20 μF . A ceramic capacitor is recommended. Ceramic capacitors have DC-Bias and temperature derating effects, which both have influence the final effective capacitance. Choose the right capacitor carefully in combination with considering its package size, dielectric and voltage rating. It is good design practice to include one 0.1- μF capacitor close to the device for high-frequency noise reduction.

8.2.3 Application Curves

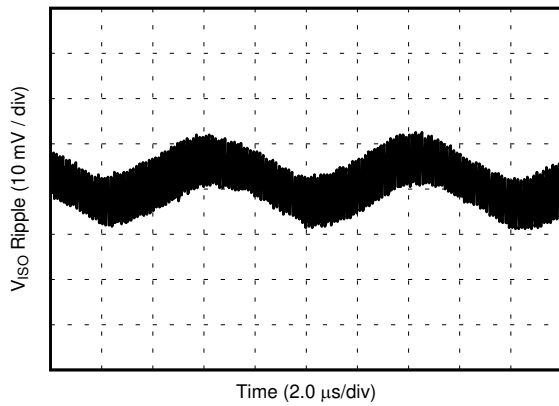

D033

$V_{INP} = 5.0\text{ V}$ $V_{ISO} = 5.4\text{ V}$ Bandwidth = 20 MHz

图 8-2. V_{ISO} Ripple, 5.4-V Output, 10% Load

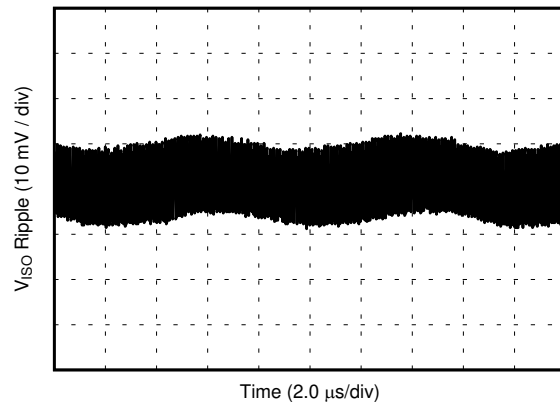

D034

$V_{INP} = 5.0\text{ V}$ $V_{ISO} = 5.4\text{ V}$ Bandwidth = 20 MHz

图 8-3. V_{ISO} Ripple, 5.4-V Output, 90% Load

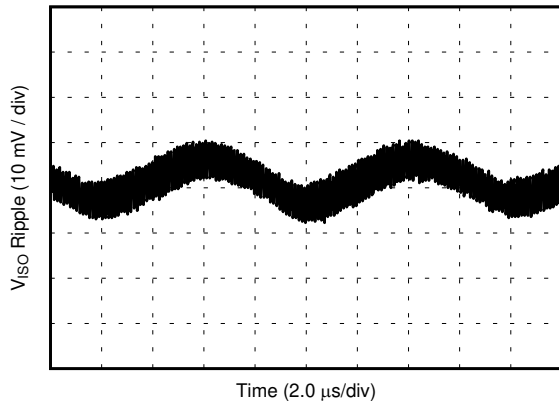

D035

$V_{INP} = 5.0\text{ V}$ $V_{ISO} = 5.0\text{ V}$ Bandwidth = 20 MHz

图 8-4. V_{ISO} Ripple, 5.0-V Output, 10% Load

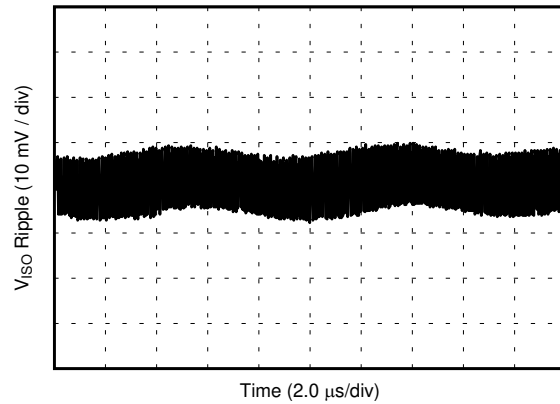

D036

$V_{INP} = 5.0\text{ V}$ $V_{ISO} = 5.0\text{ V}$ Bandwidth = 20 MHz

图 8-5. V_{ISO} Ripple, 5.0-V Output, 90% Load

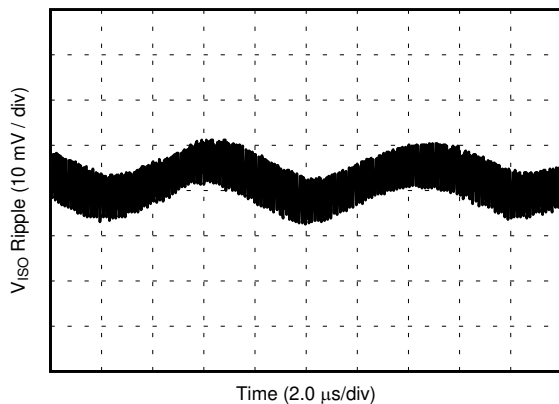

D037

$V_{INP} = 5.0\text{ V}$ $V_{ISO} = 3.7\text{ V}$ Bandwidth = 20 MHz

图 8-6. V_{ISO} Ripple, 3.7-V Output, 10% Load

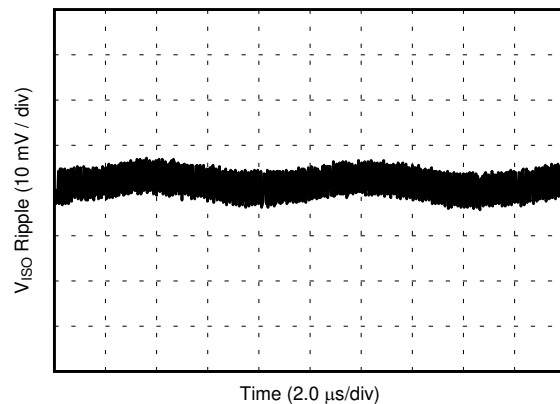

D038

$V_{INP} = 5.0\text{ V}$ $V_{ISO} = 3.7\text{ V}$ Bandwidth = 20 MHz

图 8-7. V_{ISO} Ripple, 3.7-V Output, 90% Load

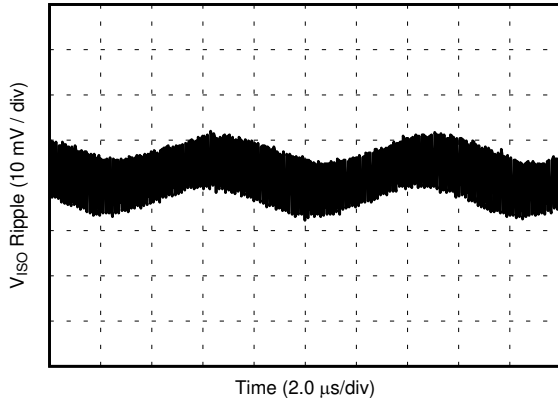

D039
 $V_{INP} = 5.0\text{ V}$ $V_{ISO} = 3.3\text{ V}$ Bandwidth = 20 MHz

图 8-8. V_{ISO} Ripple, 3.3-V Output, 10% Load

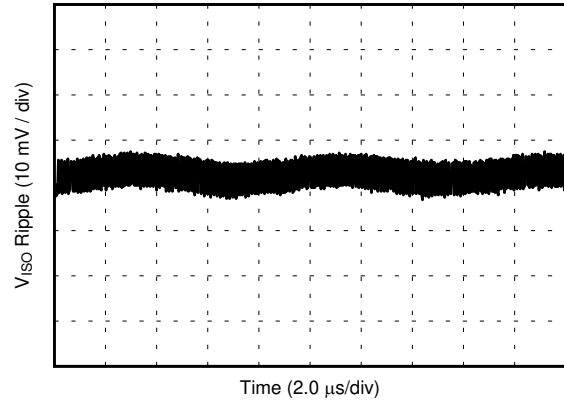

D040
 $V_{INP} = 5.0\text{ V}$ $V_{ISO} = 3.3\text{ V}$ Bandwidth = 20 MHz

图 8-9. V_{ISO} Ripple, 3.3-V Output, 90% Load

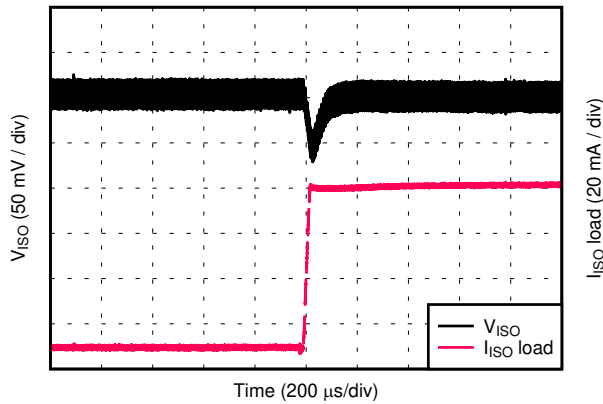

D041
图 8-10. V_{ISO} Load Transient Response, 10% to 90% Load Step, 5.0-V Input, 5.4-V Output

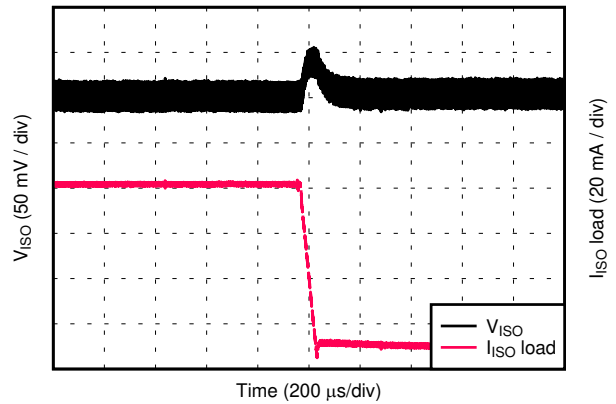

D042
图 8-11. V_{ISO} Load Transient Response, 90% to 10% Load Step, 5.0-V Input, 5.4-V Output

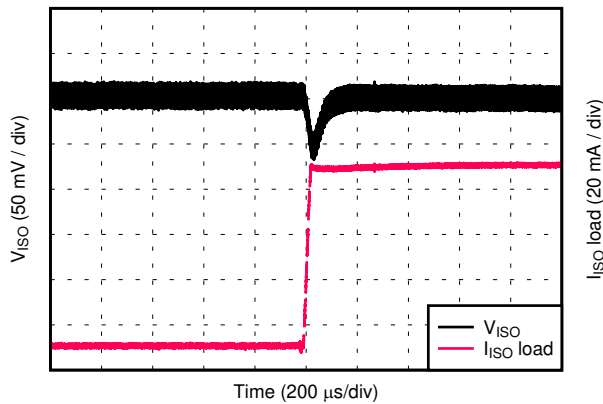

D043
图 8-12. V_{ISO} Load Transient Response, 10% to 90% Load Step, 5.0-V Input, 5.0-V Output

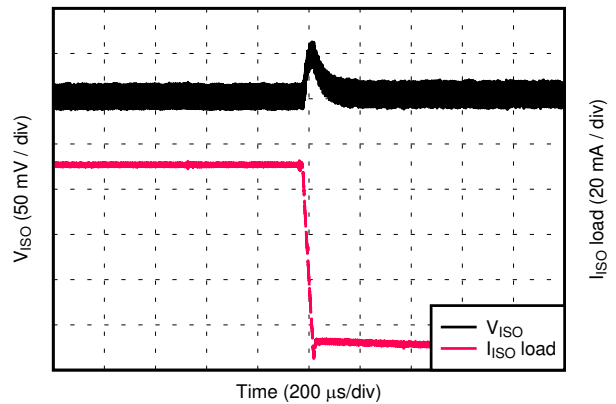

D044
图 8-13. V_{ISO} Load Transient Response, 90% to 10% Load Step, 5.0-V Input, 5.0-V Output



图 8-14. V_{ISO} Load Transient Response, 10% to 90% Load Step, 5.0-V Input, 3.7-V Output

D045

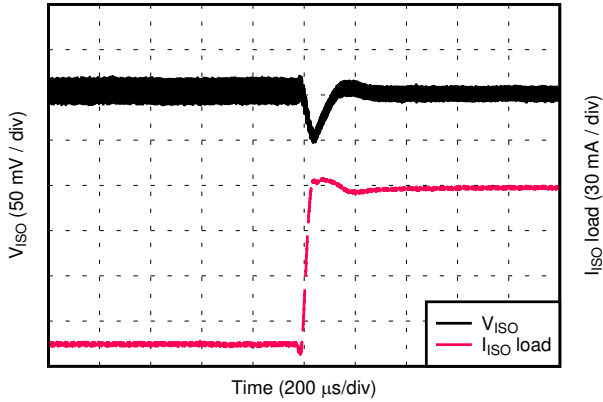

图 8-15. V_{ISO} Load Transient Response, 90% to 10% Load Step, 5.0-V Input, 3.7-V Output

D046

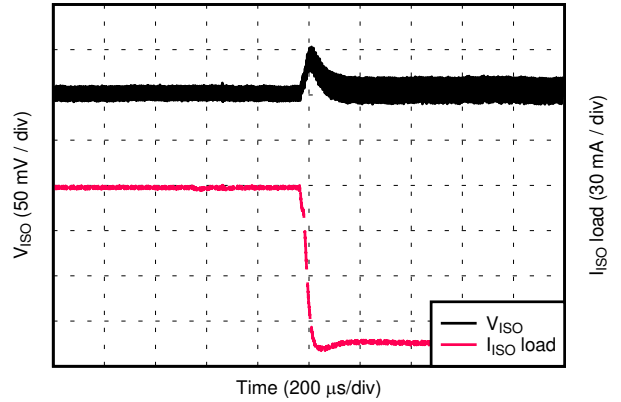

图 8-16. V_{ISO} Load Transient Response, 10% to 90% Load Step, 5.0-V Input, 3.3-V Output

D047

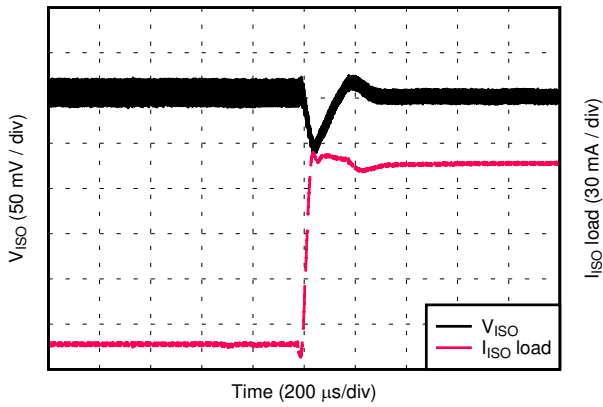

图 8-17. V_{ISO} Load Transient Response, 90% to 10% Load Step, 5.0-V Input, 3.3-V Output

D047

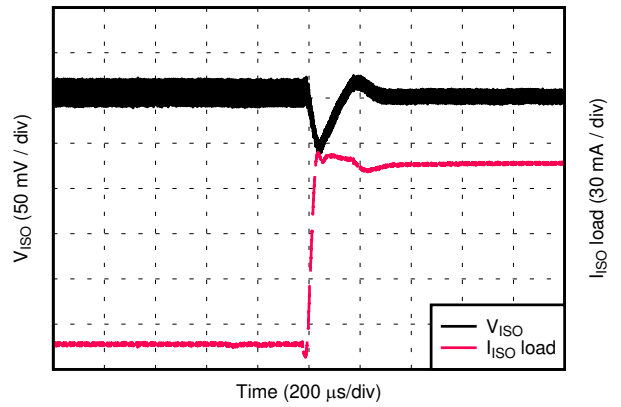

图 8-18. V_{ISO} Soft Start at 10% Rated Load, 5.0-V Input, 5.4-V Output

D049

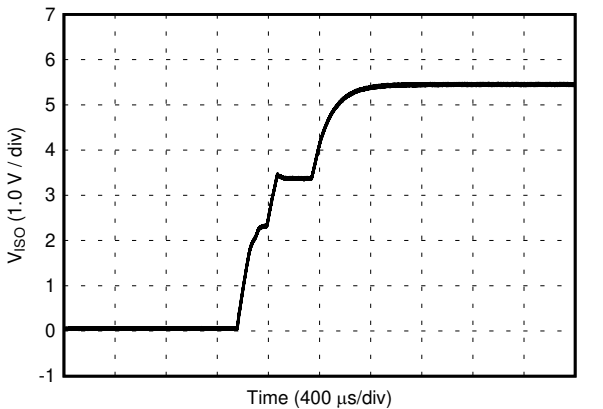

图 8-19. V_{ISO} Soft Start at 90% Rated Load, 5.0-V Input, 5.4-V Output

D050

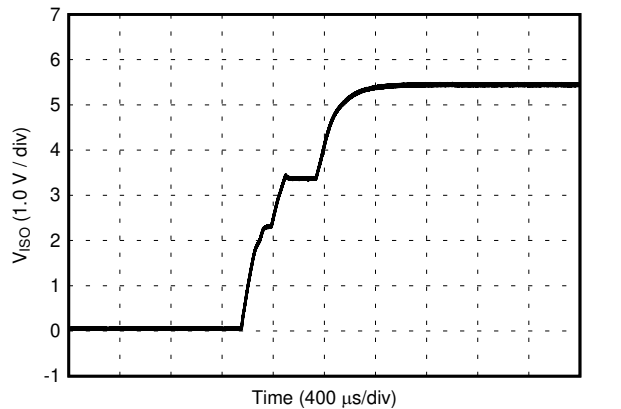
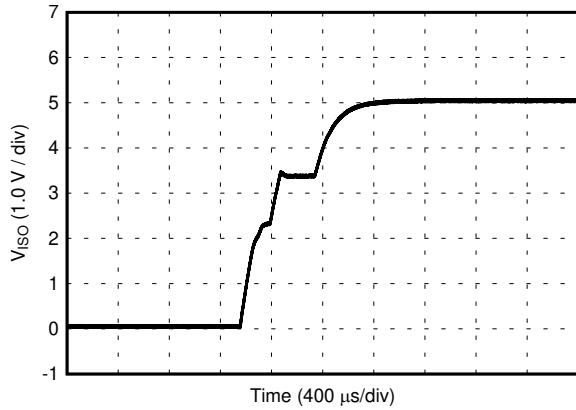

D051

图 8-20. V_{ISO} Soft Start at 10% Rated Load, 5.0-V Input, 5.0-V Output

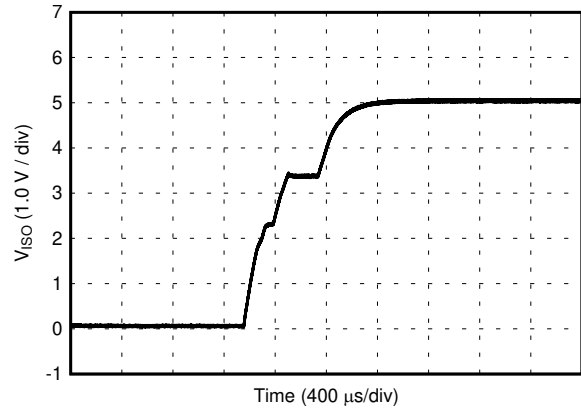

D052

图 8-21. V_{ISO} Soft Start at 90% Rated Load, 5.0-V Input, 5.0-V Output

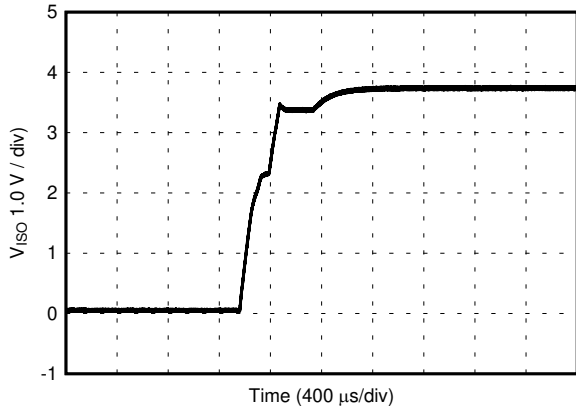

D053

图 8-22. V_{ISO} Soft Start at 10% Rated Load, 5.0-V Input, 3.7-V Output

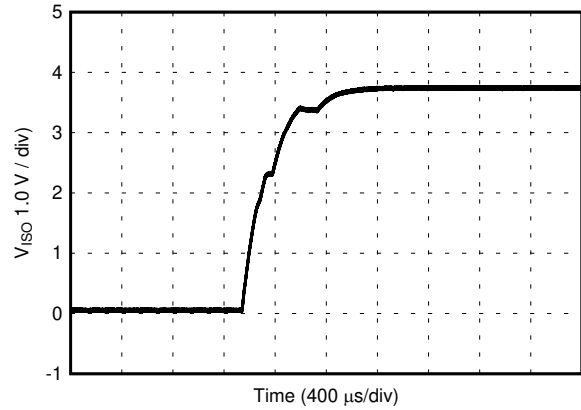

D054

图 8-23. V_{ISO} Soft Start at 90% Rated Load, 5.0-V Input, 3.7-V Output

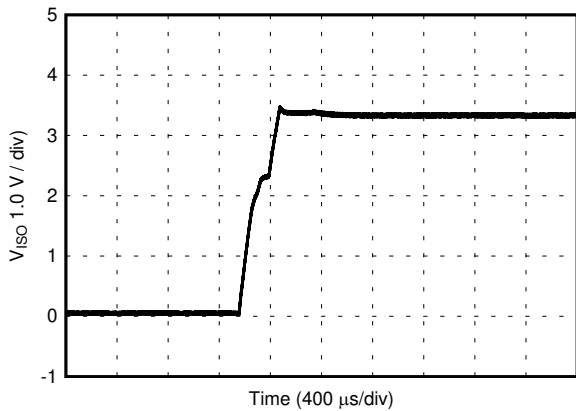

D055

图 8-24. V_{ISO} Soft Start at 10% Rated Load, 5.0-V Input, 3.3-V Output

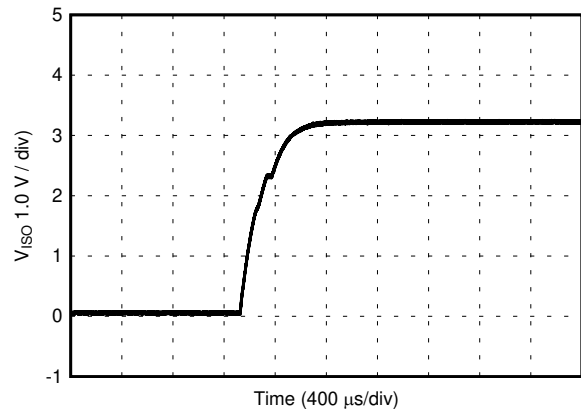

D056

图 8-25. V_{ISO} Soft Start at 90% Rated Load, 5.0-V Input, 3.3-V Output

9 Power Supply Recommendations

The recommended input supply voltage (VINP) for the UCC12041-Q1 is between 4.5 V and 5.5 V. To help ensure reliable operation, adequate decoupling capacitors must be located as close to supply pins as possible. Place local bypass capacitors between the VINP and GNDP pins at the input, and between VISO and GNDS at the isolated output supply. Low ESR, ceramic surface mount capacitors are recommended. It is further suggested that one place two such capacitors: one with a value of 10 μ F for supply bypassing, and an additional 100-nF capacitor in parallel for high frequency filtering. The input supply must have an appropriate current rating to support output load required by the end application.

10 Layout

10.1 Layout Guidelines

The UCC12041-Q1 integrated isolated power solution simplifies system design and reduces board area usage. Proper PCB layout is important in order to achieve optimum performance. Here is a list of recommendations:

1. Place decoupling capacitors as close as possible to the device pins. For the input supply, place the capacitor(s) between pin 3 (VINP) and pin 2 (GNDP). For the isolated output supply, place the capacitor(s) between pin 14 (VISO) and pin 15 (GNDS). This location is of particular importance to the input decoupling capacitor, because this capacitor supplies the transient current associated with the fast switching waveforms of the power drive circuits.
2. Because the device does not have a thermal pad for heat-sinking, the device dissipates heat through the respective GND pins. Ensure that enough copper (preferably a connection to the ground plane) is present on all GNDP and GNDS pins for best heat-sinking.
3. If space and layer count allow, it is also recommended to connect the VINP, GNDP, VISO and GNDS pins to internal ground or power planes through multiple vias of adequate size. Alternatively, make traces for these nets as wide as possible to minimize losses.
4. TI also recommends grounding the no-connect pins (NC) to their respective ground planes. For pins 6, 7, and 8, connect to GNDP. For pins 10, 11, and 12, connect to GNDS. This will allow more continuous ground planes and larger thermal mass for heat-sinking.
5. A minimum of four layers is recommended to accomplish a low-EMI PCB design. Inner layers can be spaced closer than outer layers and used to create a high-frequency bypass capacitor between GNDP and GNDS to reduce radiated emissions. Ensure proper spacing, both inter-layer and layer-to-layer, is implemented to avoid reducing isolation capabilities. These spacings will vary based on the printed circuit board construction parameters, such as dielectric material and thickness.
6. Pay close attention to the spacing between primary ground plane (GNDP) and secondary ground plane (GNDS) on the PCB outer layers. The effective creepage and or clearance of the system will be reduced if the two ground planes have a lower spacing than that of the device package.
7. To ensure isolation performance between the primary and secondary side, avoid placing any PCB traces or copper below the UCC12041-Q1 device on the outer copper layers.

10.2 Layout Example



图 10-1. Layout Example

11 Device and Documentation Support

11.1 Device Support

11.1.1 Development Support

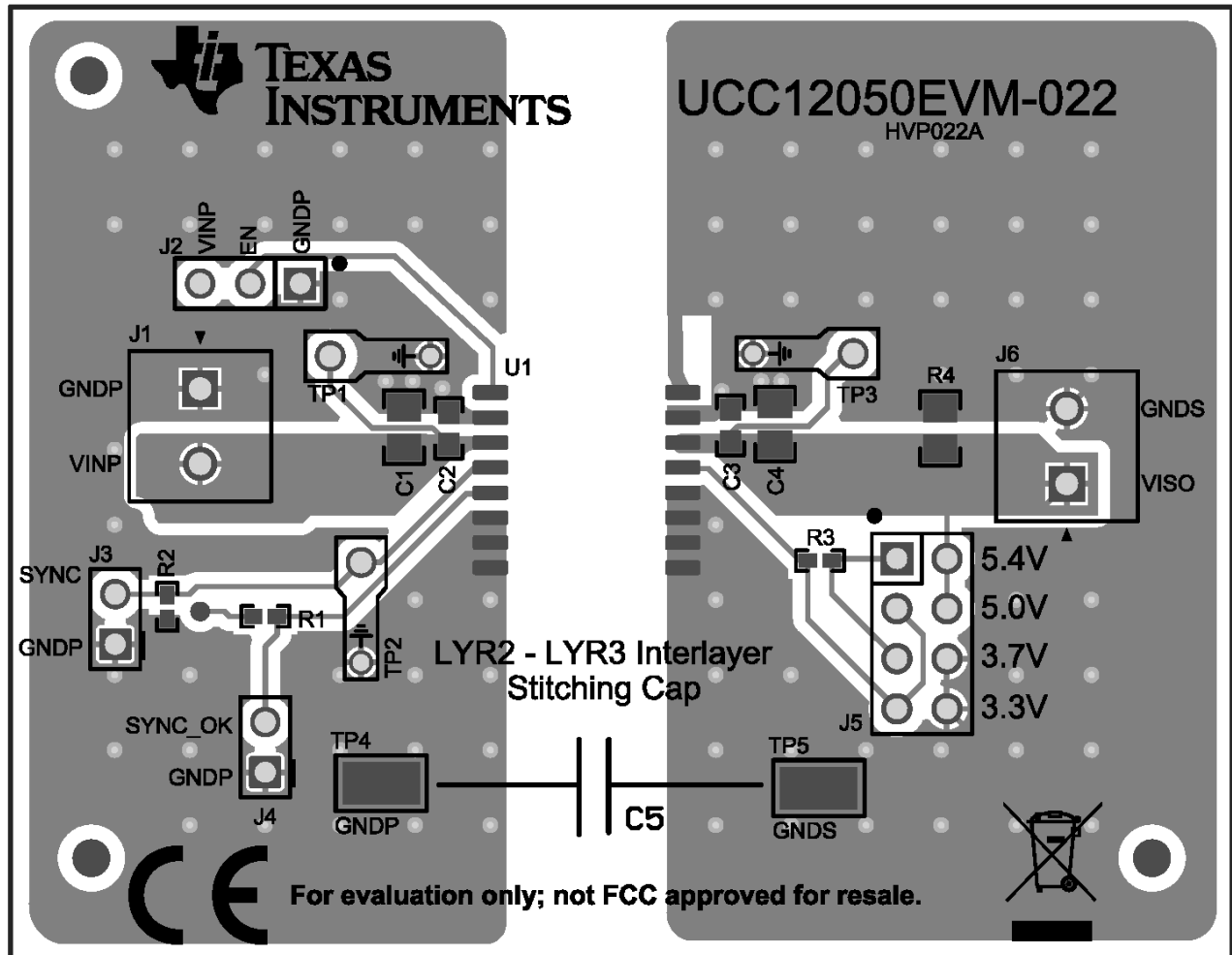
For development support, refer to:

- [Isolated 5-V bias supply for automotive CISPR 25, class 5 emissions, reference design](#)

11.2 Documentation Support

11.2.1 Related Documentation

For related documentation see the following:

- [UCC12050 Evaluation Module User Guide](#)
- [Isolation Glossary](#)

11.3 接收文档更新通知

要接收文档更新通知，请导航至 [ti.com](#) 上的器件产品文件夹。点击 [订阅更新](#) 进行注册，即可每周接收产品信息更改摘要。有关更改的详细信息，请查看任何已修订文档中包含的修订历史记录。

11.4 支持资源

[TI E2E™ 支持论坛](#) 是工程师的重要参考资料，可直接从专家获得快速、经过验证的解答和设计帮助。搜索现有解答或提出自己的问题可获得所需的快速设计帮助。

链接的内容由各个贡献者“按原样”提供。这些内容并不构成 TI 技术规范，并且不一定反映 TI 的观点；请参阅 TI 的《[使用条款](#)》。

11.5 Trademarks

TI E2E™ is a trademark of Texas Instruments.

所有商标均为其各自所有者的财产。

11.6 Electrostatic Discharge Caution



This integrated circuit can be damaged by ESD. Texas Instruments recommends that all integrated circuits be handled with appropriate precautions. Failure to observe proper handling and installation procedures can cause damage.

ESD damage can range from subtle performance degradation to complete device failure. Precision integrated circuits may be more susceptible to damage because very small parametric changes could cause the device not to meet its published specifications.

11.7 术语表

[TI 术语表](#) 本术语表列出并解释了术语、首字母缩略词和定义。

12 Mechanical and Packaging Information

The following pages include mechanical, packaging, and orderable information. This information is the most current data available for the designated devices. This data is subject to change without notice and revision of this document. For browser-based versions of this data sheet, refer to the left-hand navigation.

重要声明和免责声明

TI 提供技术和可靠性数据 (包括数据表)、设计资源 (包括参考设计)、应用或其他设计建议、网络工具、安全信息和其他资源, 不保证没有瑕疵且不做任何明示或暗示的担保, 包括但不限于对适销性、某特定用途方面的适用性或不侵犯任何第三方知识产权的暗示担保。

这些资源可供使用 TI 产品进行设计的熟练开发人员使用。您将自行承担以下全部责任: (1) 针对您的应用选择合适的 TI 产品, (2) 设计、验证并测试您的应用, (3) 确保您的应用满足相应标准以及任何其他安全、安保或其他要求。这些资源如有变更, 恕不另行通知。TI 授权您仅可将这些资源用于研发本资源所述的 TI 产品的应用。严禁对这些资源进行其他复制或展示。您无权使用任何其他 TI 知识产权或任何第三方知识产权。您应全额赔偿因在这些资源的使用中对 TI 及其代表造成的任何索赔、损害、成本、损失和债务, TI 对此概不负责。

TI 提供的产品受 TI 的销售条款 (<https://www.ti.com/legal/termsofsale.html>) 或 [ti.com](https://www.ti.com) 上其他适用条款/TI 产品随附的其他适用条款的约束。TI 提供这些资源并不会扩展或以其他方式更改 TI 针对 TI 产品发布的适用的担保或担保免责声明。

邮寄地址: Texas Instruments, Post Office Box 655303, Dallas, Texas 75265
Copyright © 2021, 德州仪器 (TI) 公司

PACKAGING INFORMATION

Orderable Device	Status (1)	Package Type	Package Drawing	Pins	Package Qty	Eco Plan (2)	Lead finish/ Ball material (6)	MSL Peak Temp (3)	Op Temp (°C)	Device Marking (4/5)	Samples
UCC12041QDVERQ1	ACTIVE	SO-MOD	DVE	16	2000	RoHS & Green	NIPDAU	Level-3-260C-168 HR	-40 to 125	UCC12041Q1	Samples

(1) The marketing status values are defined as follows:

ACTIVE: Product device recommended for new designs.

LIFEBUY: TI has announced that the device will be discontinued, and a lifetime-buy period is in effect.

NRND: Not recommended for new designs. Device is in production to support existing customers, but TI does not recommend using this part in a new design.

PREVIEW: Device has been announced but is not in production. Samples may or may not be available.

OBSOLETE: TI has discontinued the production of the device.

(2) **RoHS:** TI defines "RoHS" to mean semiconductor products that are compliant with the current EU RoHS requirements for all 10 RoHS substances, including the requirement that RoHS substance do not exceed 0.1% by weight in homogeneous materials. Where designed to be soldered at high temperatures, "RoHS" products are suitable for use in specified lead-free processes. TI may reference these types of products as "Pb-Free".

RoHS Exempt: TI defines "RoHS Exempt" to mean products that contain lead but are compliant with EU RoHS pursuant to a specific EU RoHS exemption.

Green: TI defines "Green" to mean the content of Chlorine (Cl) and Bromine (Br) based flame retardants meet JS709B low halogen requirements of <=1000ppm threshold. Antimony trioxide based flame retardants must also meet the <=1000ppm threshold requirement.

(3) MSL, Peak Temp. - The Moisture Sensitivity Level rating according to the JEDEC industry standard classifications, and peak solder temperature.

(4) There may be additional marking, which relates to the logo, the lot trace code information, or the environmental category on the device.

(5) Multiple Device Markings will be inside parentheses. Only one Device Marking contained in parentheses and separated by a "-" will appear on a device. If a line is indented then it is a continuation of the previous line and the two combined represent the entire Device Marking for that device.

(6) Lead finish/Ball material - Orderable Devices may have multiple material finish options. Finish options are separated by a vertical ruled line. Lead finish/Ball material values may wrap to two lines if the finish value exceeds the maximum column width.

Important Information and Disclaimer:The information provided on this page represents TI's knowledge and belief as of the date that it is provided. TI bases its knowledge and belief on information provided by third parties, and makes no representation or warranty as to the accuracy of such information. Efforts are underway to better integrate information from third parties. TI has taken and continues to take reasonable steps to provide representative and accurate information but may not have conducted destructive testing or chemical analysis on incoming materials and chemicals. TI and TI suppliers consider certain information to be proprietary, and thus CAS numbers and other limited information may not be available for release.

In no event shall TI's liability arising out of such information exceed the total purchase price of the TI part(s) at issue in this document sold by TI to Customer on an annual basis.

EXAMPLE BOARD LAYOUT

DVE0016A

SO-MOD - 2.65 mm max height

SMALL OUTLINE INTEGRATED CIRCUIT

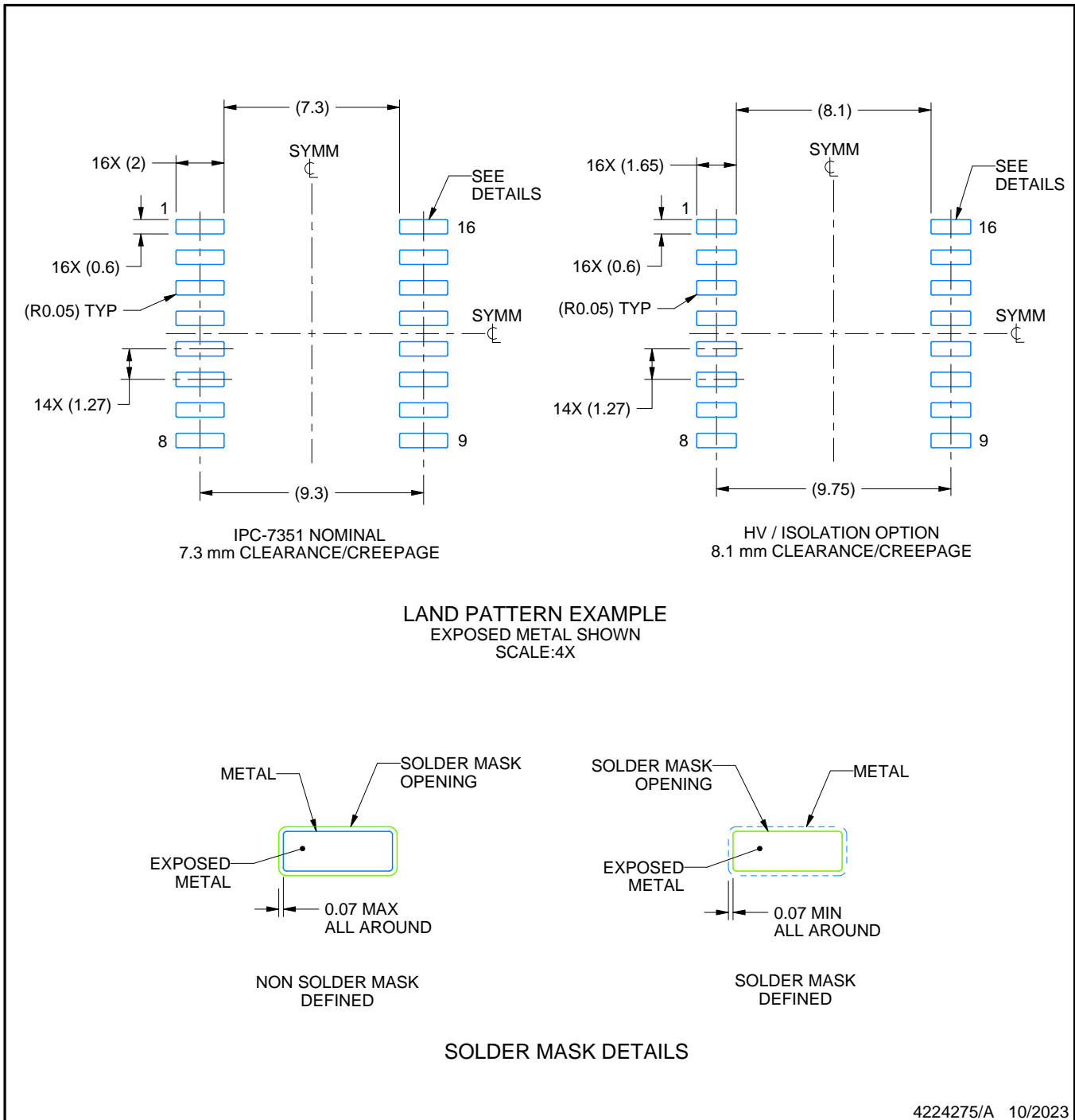

NOTES: (continued)

- 6. Publication IPC-7351 may have alternate designs.
- 7. Solder mask tolerances between and around signal pads can vary based on board fabrication site.

EXAMPLE STENCIL DESIGN

DVE0016A

SO-MOD - 2.65 mm max height

SMALL OUTLINE INTEGRATED CIRCUIT

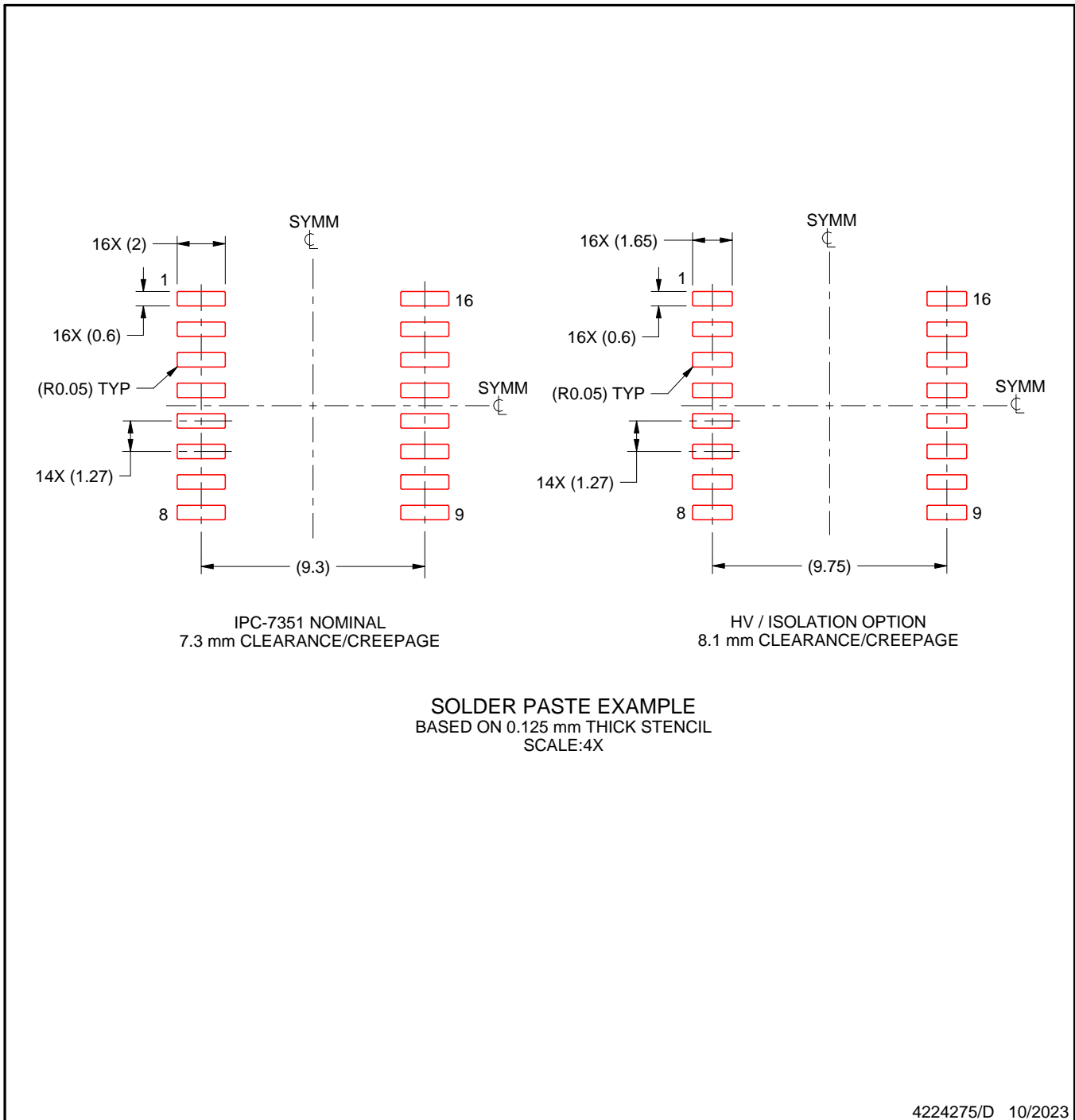

NOTES: (continued)

8. Laser cutting apertures with trapezoidal walls and rounded corners may offer better paste release. IPC-7525 may have alternate design recommendations.
9. Board assembly site may have different recommendations for stencil design.

重要声明和免责声明

TI“按原样”提供技术和可靠性数据（包括数据表）、设计资源（包括参考设计）、应用或其他设计建议、网络工具、安全信息和其他资源，不保证没有瑕疵且不做任何明示或暗示的担保，包括但不限于对适销性、某特定用途方面的适用性或不侵犯任何第三方知识产权的暗示担保。

这些资源可供使用 TI 产品进行设计的熟练开发人员使用。您将自行承担以下全部责任：(1) 针对您的应用选择合适的 TI 产品，(2) 设计、验证并测试您的应用，(3) 确保您的应用满足相应标准以及任何其他功能安全、信息安全、监管或其他要求。

这些资源如有变更，恕不另行通知。TI 授权您仅可将这些资源用于研发本资源所述的 TI 产品的应用。严禁对这些资源进行其他复制或展示。您无权使用任何其他 TI 知识产权或任何第三方知识产权。您应全额赔偿因在这些资源的使用中对 TI 及其代表造成的任何索赔、损害、成本、损失和债务，TI 对此概不负责。

TI 提供的产品受 [TI 的销售条款](#) 或 [ti.com](#) 上其他适用条款/TI 产品随附的其他适用条款的约束。TI 提供这些资源并不会扩展或以其他方式更改 TI 针对 TI 产品发布的适用的担保或担保免责声明。

TI 反对并拒绝您可能提出的任何其他或不同的条款。

邮寄地址：Texas Instruments, Post Office Box 655303, Dallas, Texas 75265

Copyright © 2023，德州仪器 (TI) 公司