

HSDC Pro With Xilinx® KCU105

This user's guide describes the functionality, hardware, operation, and software instructions to implement the High Speed Data Converter Pro Graphic User Interface (HSDC Pro GUI) with the KCU105, a Xilinx® Kintex® UltraScale™ field-programmable gate array (FPGA) evaluation kit.

Contents

1	Introduction	3
2	Functionality	3
3	Required Hardware	3
3.1	Xilinx® KCU105	3
3.2	TI ADC/DAC Evaluation Module	3
3.3	Test Equipment	3
4	Required Software	4
4.1	HSDC Pro GUI	4
4.2	Serial Terminal Emulator	4
5	DAC and ADC GUI Configuration File Changes When Using a Xilinx® Development Platform.....	5
6	KCU105 Quick Start-Up Instructions	6
6.1	USB Interface and Drivers	6
6.2	Programing the FPGA.....	7
6.3	Adjusting FPGA FMC Settings.....	8
6.4	IP Address and Connecting to HSDC Pro.....	8
7	Board Setup Examples	10
7.1	DAC38J84EVM with KCU105 Board Setup Example	10
7.2	ADC12J4000EVM With KCU105 Board Setup Example.....	15
7.3	ADC32RF45EVM With KCU105 Board Setup Example	18
7.4	ADS54J20EVM With KCU105 Board Setup Example.....	22
7.5	ADS42JB49EVM With KCU105 Board Setup Example	25
7.6	DAC38RF82EVM With KCU105 Board Setup Example	27
8	Eyescan Analysis.....	35

List of Figures

1	TI EVM With KCU105 Block Diagram.....	6
2	Passed Calibration in Vivado® 2016.3	7
3	Setting FMC VADJ in Enhanced COM Port.....	8
4	IP Address in Standard COM Port	9
5	HSDC Pro Connecting to KCU105	9
6	DAC38J84EVM Setup With KCU105.....	10
7	DAC38J84EVM GUI Configuration	11
8	Generating a Tone With HSDC Pro GUI	12
9	Analog Output by DAC38J84EVM	12
10	DAC38J84EVM GUI Configuration	13
11	DAC38J84EVM GUI DCLK Divider	14
12	ADC12J4000EVM Setup With KCU105.....	15
13	Configured ADC12J4000EVM GUI	16
14	HSDC Pro ADC12J4000EVM Captured Result	17

15	ADC32RF45EVM Setup With KCU105	18
16	ADC32RF45EVM GUI Quick Setup	19
17	ADC32RFEVM GUI Clock Outputs	20
18	ADC32RF45 GUI Lane De-Emphasis	20
19	ADC32RF45EVM Capture on HSDC Pro	21
20	ADS54J20EVM Setup With KCU105	22
21	Configuration Files for ADS54J20EVM GUI	23
22	HSDC Pro ADS43J20EVM Captured Result	24
23	ADS42JB49EVM Setup With KCU105	25
24	HSDC Pro ADS42JB49EVM Captured Result	26
25	DAC38RF82EVM Setup With KCU105	27
26	DAC38RFXX EVM GUI in External Clock Mode	28
27	DAC38RF82EVM GUI DCLK Divider	29
28	Generating a 150-MHz Tone on HSDC Pro	29
29	Analog Output From DAC38RF82EVM	30
30	DAC38RFXX EVM GUI in PLL Mode	31
31	DAC38RF82EVM GUI NCO Frequency Settings	32
32	HSDC Pro Configuration for PLL Mode	33
33	Analog Output From DAC38RF82EVM	34
34	Eye Diagram Example Plot	35

List of Tables

1	Multiplier Line Rate Ranges	5
---	-----------------------------------	---

Trademarks

Altera is a registered trademark of Intel Corporation.
 Silicon Labs is a registered trademark of Silicon Laboratories Incorporated.
 UltraScale is a trademark of Xilinx Incorporated.
 Xilinx, Kintex, Vivado are registered trademarks of Xilinx Incorporated.
 All other trademarks are the property of their respective owners.

1 Introduction

The Kintex UltraScale FPGA KCU105 evaluation kit is a development board created by Xilinx. The KCU105 uses Ethernet and dual USB-to-UART capabilities to interface with a host computer and set up the FPGA. Texas Instruments has created a platform where the KCU105 can interface with TI's latest and most popular JESD204B-based high speed data converter evaluation modules (EVM) as if it were connected to a TI development board. The platform also allows users to operate the High Speed Data Converter Pro Graphic User Interface (HSDC Pro GUI) software to capture data from an Analog-to-Digital converter (ADC) as well as generate data for a Digital-to-Analog converter (DAC).

2 Functionality

The KCU105 has a standard FMC connector that provides an interface between FMC-based development boards and all TI JESD204B ADC and DAC EVMs. For communicating, the KCU105 uses Ethernet to acquire and receive data, and do register read and writes using a host PC across a Serial Peripheral Interface (SPI). The KCU105 has a dual USB-to-UART bridge interface for system control as well as reading necessary information such as the board IP address. The KCU105 also has an industry-standard JTAG connection for configuring the FPGA using the Vivado® Design Suite, a design tool by Xilinx.

The firmware designed for this integration is used to support HSDC Pro, communication through SPI, and any TI FMC-based JESD204B EVM at any line rate. This user's guide is a starting point, but the firmware is over complicated for designing a regular system. The firmware is located at the following Xilinx web site: https://www.xilinx.com/member/jesd204_eval/uhwd_2016_3_v1_0.zip. The zip file includes documentation of an example design that can be generated in Vivado 2016.3. In the Vivado project, the firmware can be stripped down and designed for a more practical system.

NOTE: Run the command **set TARGET "TI"** before creating the project to generate TI bitstreams.

3 Required Hardware

3.1 Xilinx® KCU105

The Xilinx Kintex UltraScale FPGA KCU105 Evaluation Kit is required to test the TI EVMs. For KCU105 configuration and descriptions, see the product page featuring the KCU105 Evaluation Kit: <https://www.xilinx.com/products/boards-and-kits/kcu105.html>.

3.2 TI ADC/DAC Evaluation Module

A TI JESD204B ADC or DAC EVM is required in the example test instructions in [Section 7](#). For TI's EVM programmable configuration, see the product page featuring the EVM on www.ti.com.

3.3 Test Equipment

Depending on the device under test, the follow test equipment may be required:

- Low-noise RF signal generator. Recommendations:
 - HP 8644B, Rohde & Schwarz SMA100A, or equivalent
- Spectrum analyzer with RF frequency ranges. Recommendations:
 - Agilent E443A, Rohde & Schwarz FSP, or equivalent
- Bandpass filters for desired analog input. Recommendations:
 - Trilithic 5VH-series Tunable BPF, K&L BT-series Tunable BPF, TTE KC6 or KC7-series Fixed BPF
- Signal path cables, SMA or BNC with BNC-SMA adapters

4 Required Software

4.1 HSDC Pro GUI

Download the latest version of the HSDC Pro GUI ([slwc107x.zip](#)) to a local directory on a host PC. This can be found on the TI website by entering “HIGH SPEED DATA CONVERTER PRO GUI INSTALLER” in the search parameter window at [www.ti.com](#).

Unzipping the software package generates a folder called *High Speed Data Converter Pro - Installer vx.xx.exe*, where x.xx is the version number. Run this program to start the installation.

Follow the on-screen instructions during installation.

NOTE: If an older version of the GUI has already been installed, make sure to uninstall it before loading a newer version.

Click on the **Install** button. A new window opens. Click the **Next** button.

Accept the License Agreement. Click on **Next** to start the installation. After the installer has finished, click on **Next** one last time.

The installation is now complete. The GUI executable and associated files will reside in the following directory.

```
C:\Program Files (x86)\Texas Instruments\High Speed Data Converter Pro
```

When new TI high speed data converter EVMs or JESD204B interface modes become available that are not currently supported by the latest release of HSDC Pro GUI, the HSDCProv_xpxx_Patch_setup executable, available on the TI website under the High Speed Data Converter Pro Software product folder (<http://www.ti.com/tool/dataconverterpro-sw>), will allow the user to add these to the GUI device list. After the patch has been downloaded, follow the on-screen instructions to run the patch. The software displays the files that will be added. After running the patch, open HSDC Pro and the new parts and modes will appear in the ADC and DAC device drop-down selection box. The patch is always specific to a core GUI version and will not work for a GUI version for which the patch was not explicitly created.

4.1.1 Xilinx® Vivado® Design Suite

The Vivado Design Suite by Xilinx, is required in order to load firmware to the FPGA. See the Vivado Design Suite on Xilinx.com: <https://www.xilinx.com/products/design-tools/vivado> for more details. The latest build that supports this integration is Vivado 2016.3.

4.2 Serial Terminal Emulator

A serial terminal emulator is required to establish a serial port connection through the KCU105 dual UART interface. Any sort of serial terminal software, such as TeraTerm, PuTTY, or Hercules, can be used. For this user's guide, TeraTerm is used as the main terminal emulator. See the [TeraTerm](#) web page for more details.

5 DAC and ADC GUI Configuration File Changes When Using a Xilinx® Development Platform

The configuration files that come with the TI ADC and DAC EVM GUIs are set up to operate with the Altera® based, TI TSW14J56EVM. With the latest firmware, some GUIs can be configured as if they were connected to the TSW14J56EVM. If that is not the case, then the EVM may be configured with Xilinx-specified configuration files or a couple of changes to the settings of the LMK0482x registers. See [Section 7](#) for details.

The firmware for the Xilinx Development Platforms use a separate clock input for REFCLK and core clock to give maximum flexibility and support all line rates and subclasses with a single programmable design. The Xilinx IP used in the firmware can be driven by a single clock in many circumstances (see the clocking section of the Xilinx IP product guide for more details). THE REFCLK and core clock are determined by the line rate conditions shown in [Table 1](#).

Table 1. Multiplier Line Rate Ranges

	Max Lr (Gbps)	1.2	1.6	1.9	2	2.4	3.2	3.9	4	4.9	6.5	7.9	8.1	8.2	9.8	12.5
	Min Lr (Gbps)	1	1.20	1.60	1.90	2.00	3.20	3.01	3.90	4.00	4.90	6.50	7.90	8.10	8.20	9.80
Multiplier																
2			X	X												
10			X	X	X	X	X	X	X	X	X	X	X	X		
20					X	X	X	X	X	X	X	X	X	X	X	X
40									X	X	X	X	X	X	X	X

Line rate switching is supported across the entire speed range supported by transceivers. The ratio of REFCLK to line rate multipliers is also programmable. The multiplier is programmed by the *.ini* files located in HSDC Pro. Note: REFCLK = line rate / Multiplier

Example: A line rate of 5.0G is in the range between 4.90 Gbps and 6.5 Gbps and is supported by the multiplier values of 10, 20, and 40. Therefore, the possible values for REFCLK are:

$$5.0G / 10 = 500 \text{ MHz}, 5.0G / 20 = 250 \text{ MHz}, 5.0G / 40 = 125 \text{ MHz}$$

6 KCU105 Quick Start-Up Instructions

The following instructions are steps to starting the Xilinx KCU105 board. These instructions are **required** to establish a connection for any EVM being used.

6.1 USB Interface and Drivers

1. Connect the EVM to FMC HPC connector J22 on the KCU105.
2. Connect the power cable to the KCU105 and turn the power switch to "ON".
3. Connect the two USB cables between the KCU105 and a host computer: one between the USB to JTAG interface J1, and the other between the dual USB-UART port J4. Ensure that Silicon Labs® drivers are installed. See the [KCU105 user guide](#) on Xilinx.com for details about the Silicon Labs CP2105GM dual USB-to-UART Bridge interface on the KCU105.
4. Connect a USB cable between the EVM and host computer.
5. Open a serial port connection with any serial terminal emulator.
6. Initialize a serial port communication to Silicon Labs Dual CP210x USB to UART Bridge: **Enhanced** COM Port. Set the baud rate of this serial connection to "115200", and leave all other defaults as set.
7. Open another serial port connection and connect to Silicon Labs Dual CP210x USB to UART Bridge: **Standard** COM Port. Ensure the baud rate of this serial connection is "9600", leaving all other defaults as set.
8. Connect an Ethernet cord from the KCU105 to a port such as an Ethernet switch or router that is in the same local network as the host computer. Other Ethernet interfaces are shown in the *UltraScale Hardware Demonstration* user guide on Xilinx.com.

Figure 1 shows a block diagram of the set up.

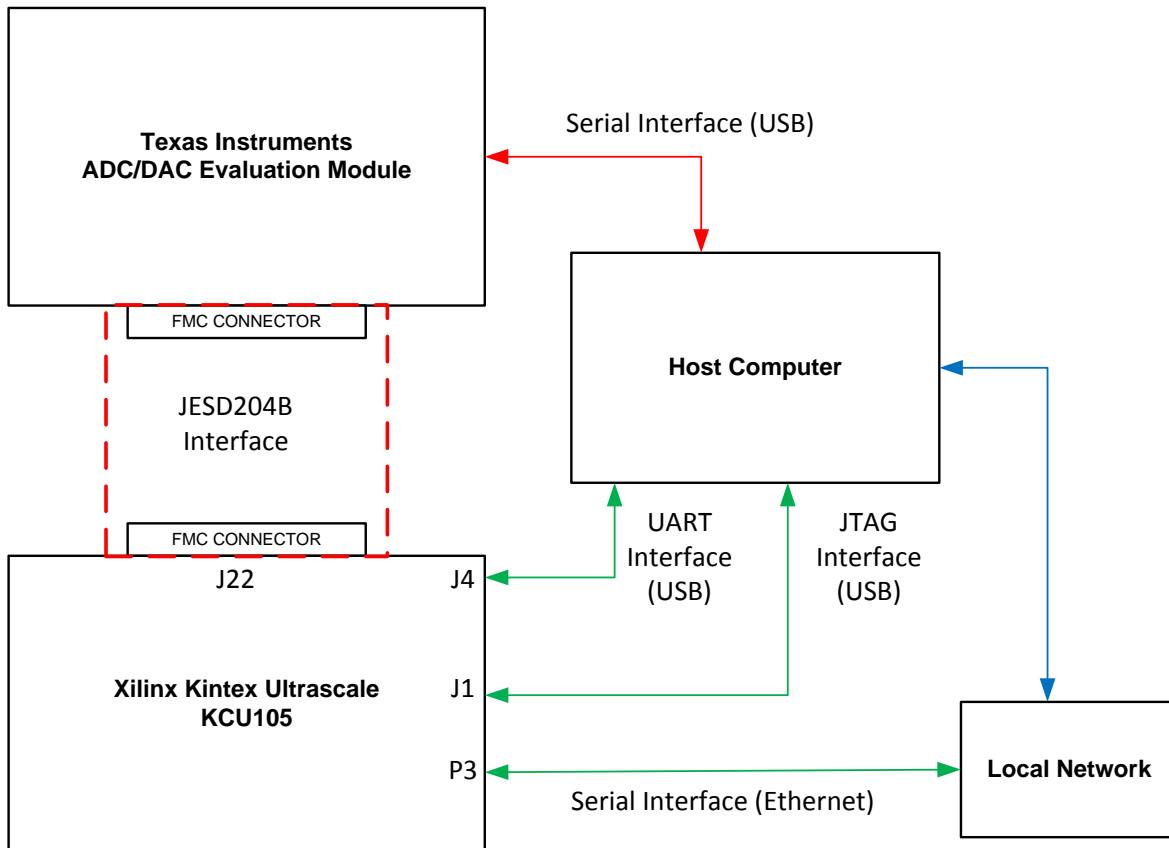

Copyright © 2017, Texas Instruments Incorporated

Figure 1. TI EVM With KCU105 Block Diagram

6.2 Programming the FPGA

Complete the following steps to program the FPGA:

1. Open the Xilinx Vivado 2016.3 design tool.
2. Double click on “Open Hardware Manager”.
3. Click on “Open Target” (located on the green bar), and select “Open New Target” (also at Tools → Open New Target).
4. Click on “Next” twice. Select the Hardware Target, and click “Next” again.
5. Click on “Finish”.
6. Click on “Program device” (located on the green bar). Select "xcku040_0" (also at Tools → Program device).
7. Select the proper bit stream file. The firmware is found in: **“C:\Program Files (x86)\Texas Instruments\High Speed Data Converter Pro\KCU105 Details\Firmware\KCU105_TI_DHCP.bit”**.

NOTE: If there is an error regarding ASCII characters, drag the bit file to the desktop and target the file there.

8. Click on “Program.”
9. A new window will open showing the status of the programming. Once this reaches 100%, the FPGA is programmed. Make sure the calibration passes and that there are no errors.

Vivado 2016.3 should look similar to [Figure 2](#) after programming the KCU105 correctly.

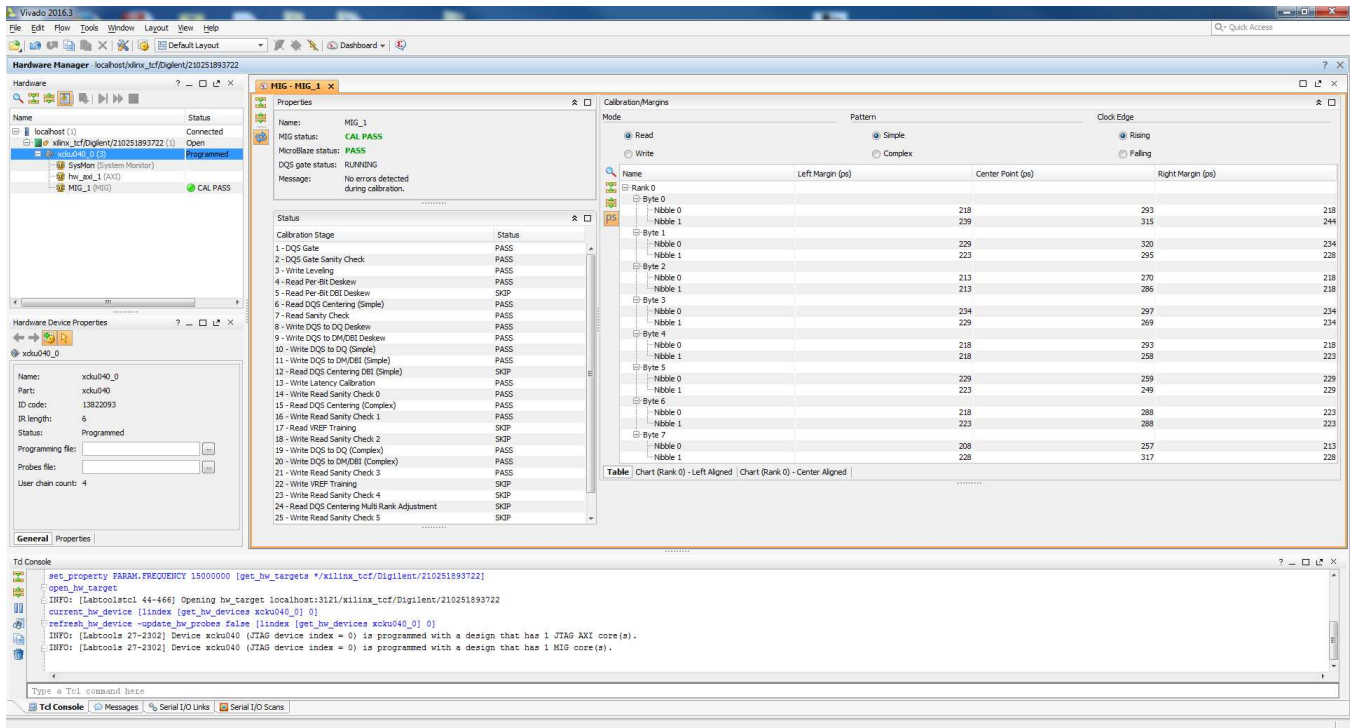

Figure 2. Passed Calibration in Vivado® 2016.3

6.3 Adjusting FPGA FMC Settings

The FMC VADJ voltage must be set to 1.8V in order for the platform to work. This is set in the Enhanced COM Port terminal.

1. Navigate to the Enhanced COM Port window. Return to the main menu by entering "0" in the terminal.
2. Enter **4** to "Adjust FPGA Mezzanine Card (FMC) settings".
3. Enter **4** again to "Set FMC VADJ to 1.8V".
4. Enter **0** to return to the main menu.
5. To check this voltage, enter **2** to "Get the Power Systems Voltages".
6. Enter **7** to "Get VADJ1D8 voltage". The voltage should appear above the menu.
7. Enter **0** to return to the main menu.

Figure 3 highlights setting the FMC VADJ to 1.8V in the Enhanced COM Port terminal.

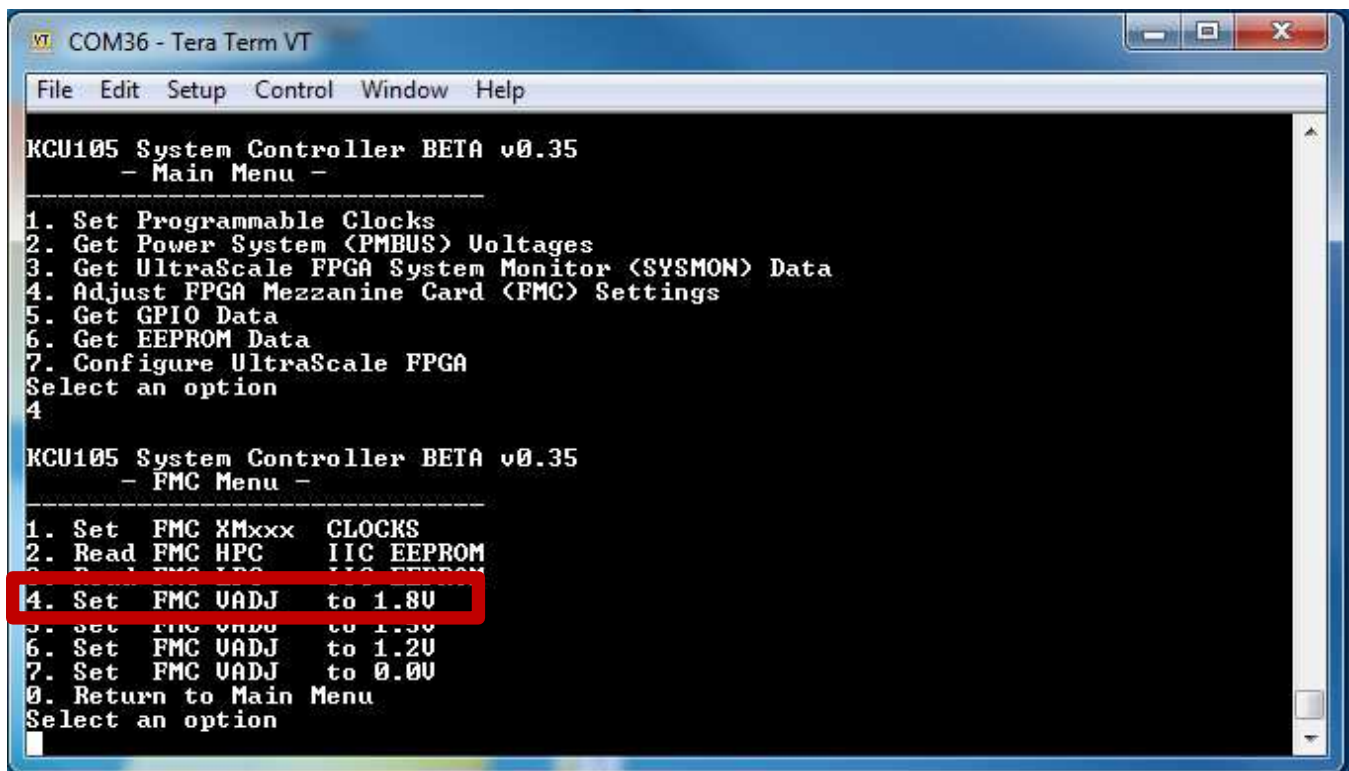

Copyright © 2017, Texas Instruments Incorporated

Figure 3. Setting FMC VADJ in Enhanced COM Port

6.4 IP Address and Connecting to HSDC Pro

Once the firmware has been loaded and the FPGA is programmed, the board IP address and port number will be available on the Standard COM port, shown in Figure 4.

This is required to establish a connection between the KCU105 and HSDC Pro. To connect to HSDC Pro, do the following steps:

1. Open the HSDC Pro GUI as administrator.
2. In the "Select Board" pop up, check "Connect to KCU105". Enter the IP address followed by a colon and port number. There is also an option to select from the drop-down menu. Both IP address and port number can be found in the Standard COM port terminal.
3. Press "OK" to connect to the KCU105.

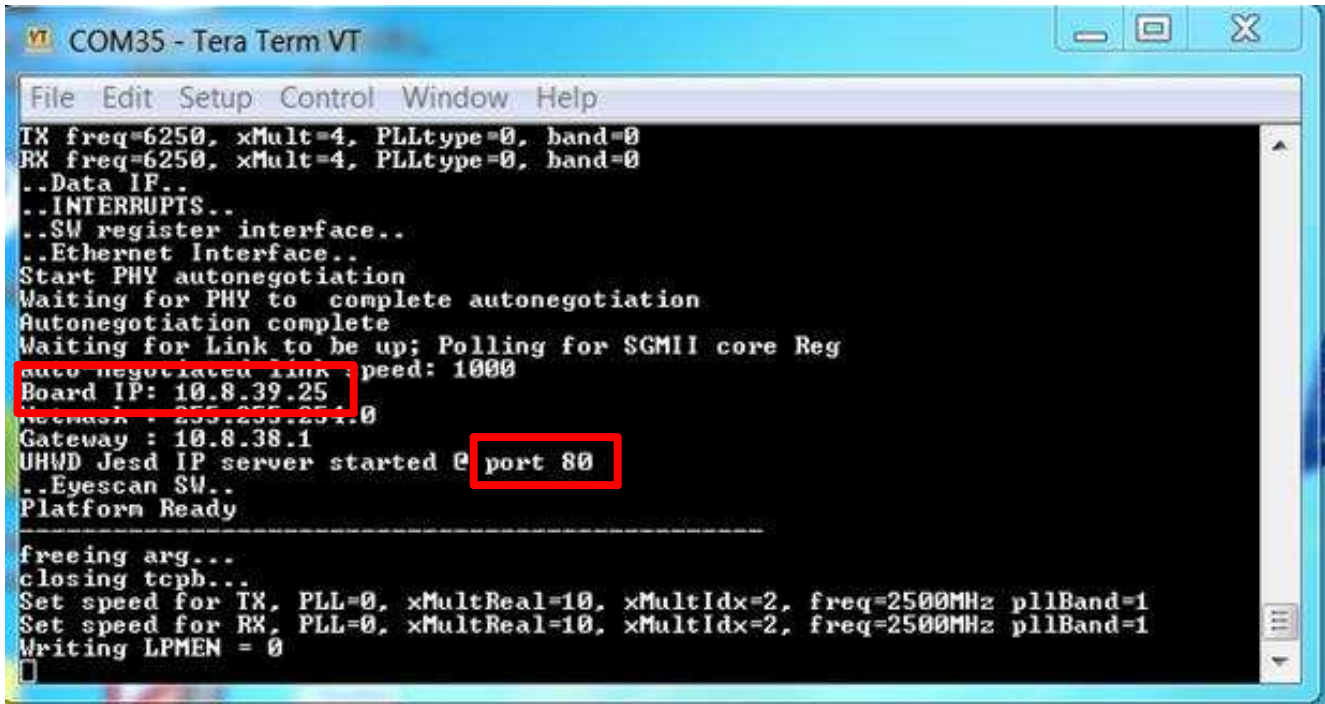

Copyright © 2017, Texas Instruments Incorporated

Figure 4. IP Address in Standard COM Port

Figure 5 is a screenshot of HSDC Pro connecting to the KCU105.

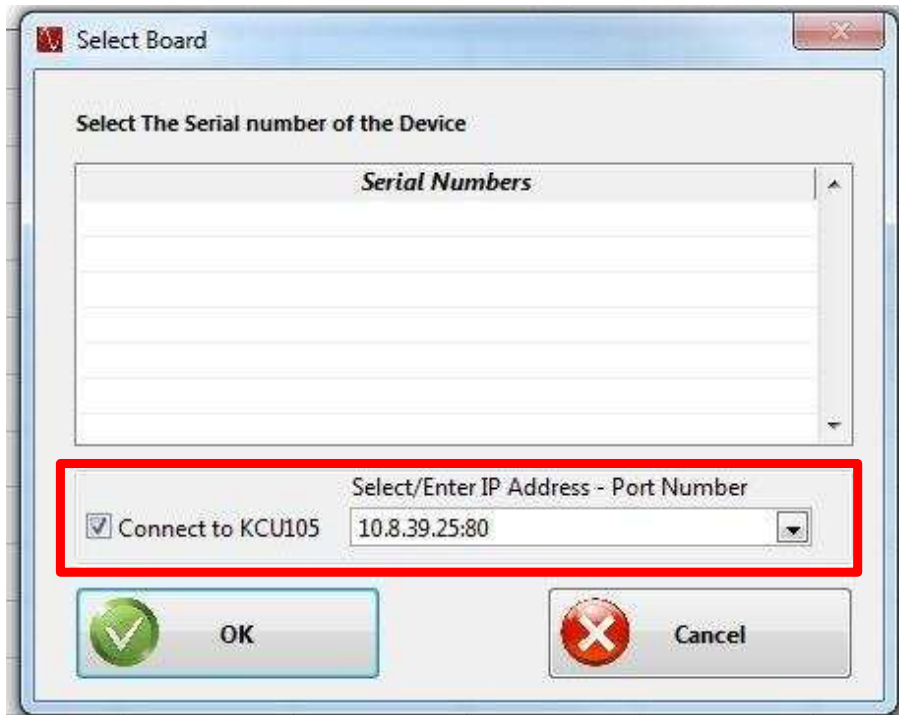

Copyright © 2017, Texas Instruments Incorporated

Figure 5. HSDC Pro Connecting to KCU105

7 Board Setup Examples

This section provides examples using the Xilinx KCU105 development platform with various JESD204B TI EVMs. Based on the EVM, the example will show what needs to be modified in order for the integration to work. The instructions in [Section 6](#) **must be completed** before continuing with the following examples.

7.1 DAC38J84EVM with KCU105 Board Setup Example

The following section provides an example of testing the DAC38J84EVM using a KCU105 development platform. With the updated firmware, users can use the DAC38J84 GUI as if it was connected to TI's TSW14J56. Make sure the instructions in [Section 6](#) are completed before testing the EVM. [Figure 6](#) shows a setup between the DAC38J84EVM and KCU105.

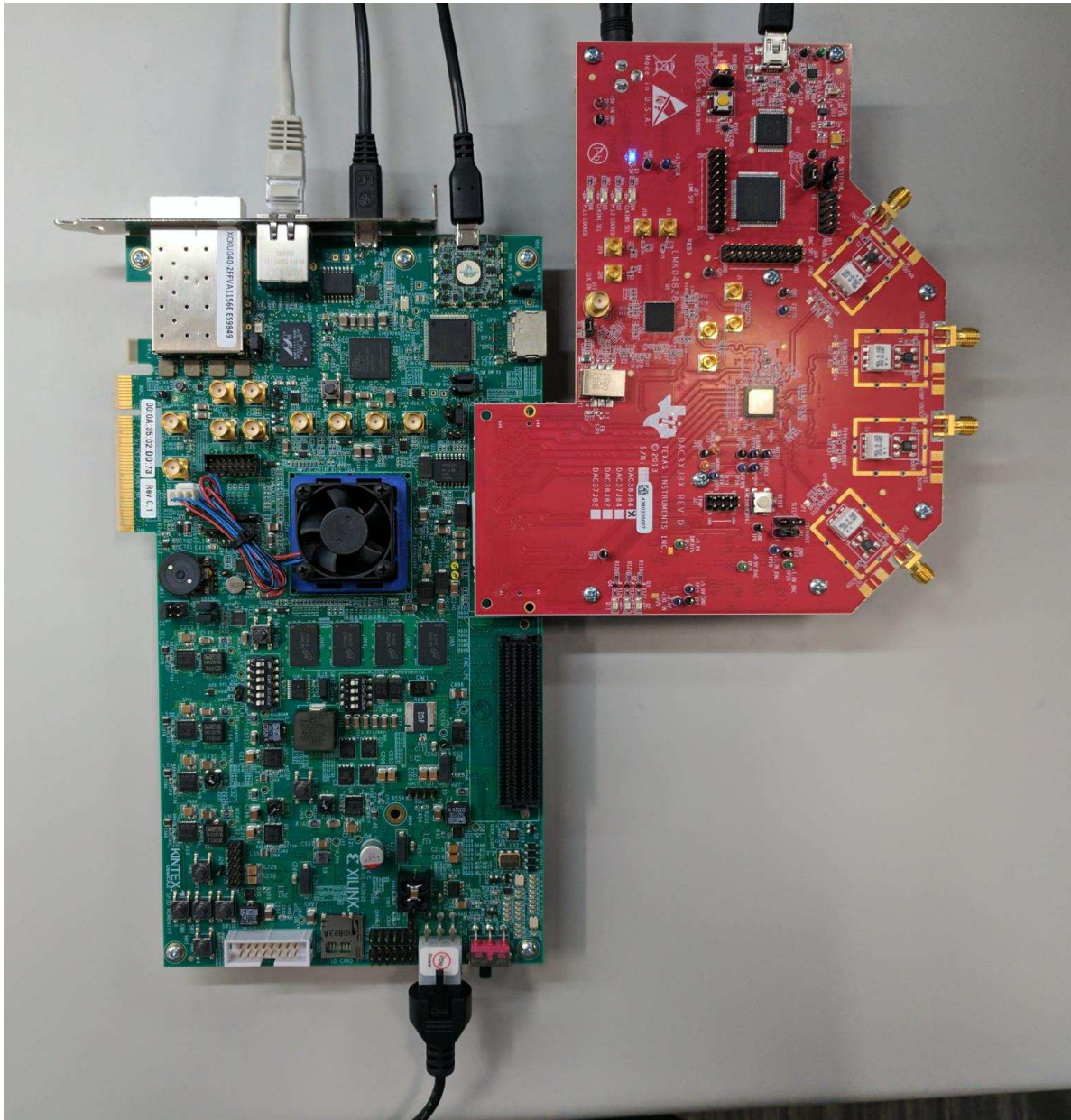

Copyright © 2017, Texas Instruments Incorporated

Figure 6. DAC38J84EVM Setup With KCU105

Set up the hardware as follows:

1. Connect the power cable to the DAC38J84EVM and open the DAC3XJ8X GUI. The GUI is found under "Software" on www.ti.com featuring the [DAC38J84EVM](#).
2. Configure the GUI as done in the following:
 - (a) *EVM Clocking Mode* – "Onboard"
 - (b) *DAC Data Input Rate* – "1228.8" MSPS
 - (c) *Number of SerDes Lanes per DAC* – "8"
 - (d) *Interpolation* – "2"

Figure 7 is a screenshot of a configured GUI for a DAC38J84EVM 8411 JESD204B mode.

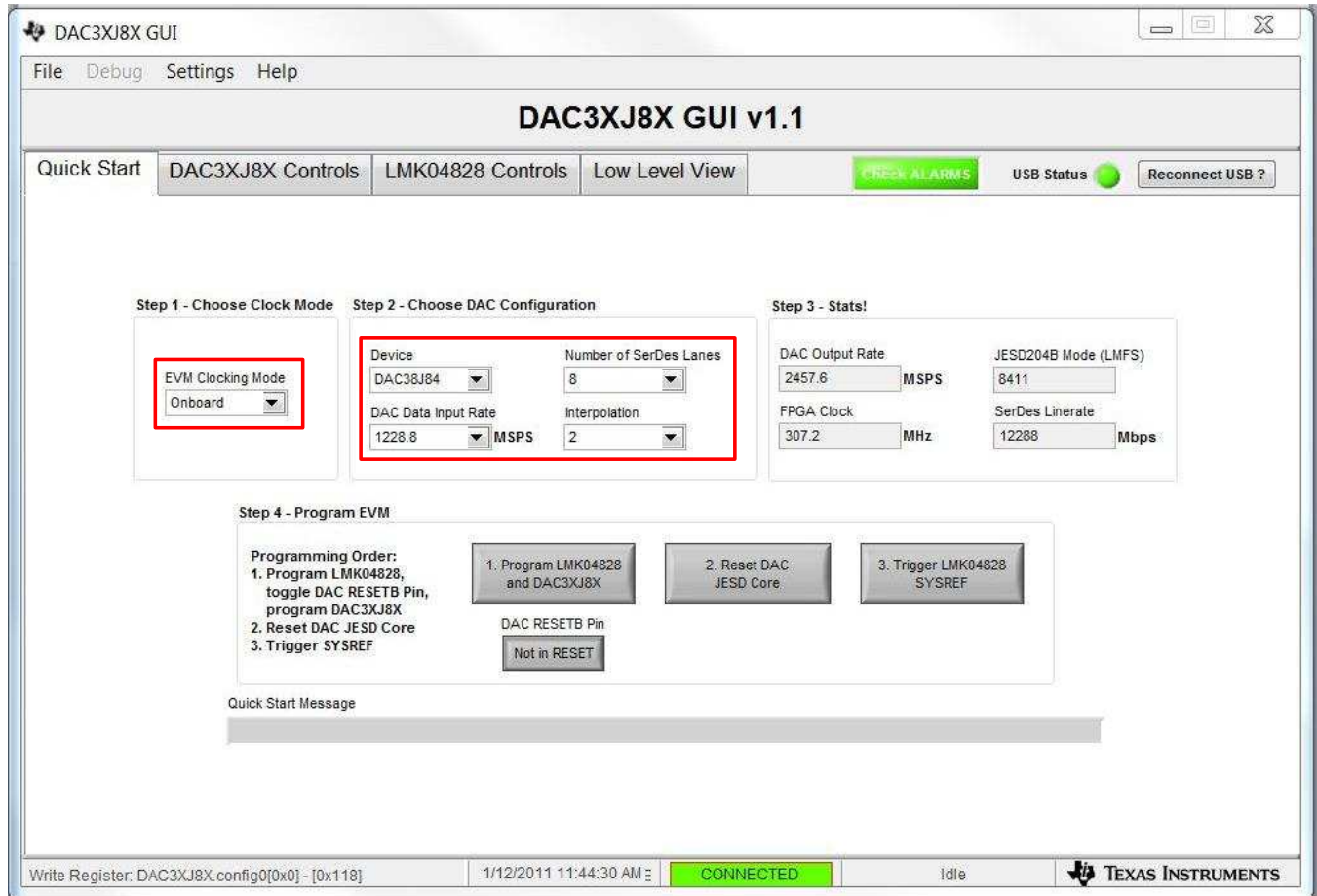

Copyright © 2017, Texas Instruments Incorporated

Figure 7. DAC38J84EVM GUI Configuration

3. Press the **1. Program LMK04828 and DAC3XJ8X** button.
4. Open HSDC Pro, press on the *DAC* tab, and select "DAX3XJ84_LMF_841" from the drop-down menu.
5. Add the *Data Rate (SPS)* and change the *DAC Option* to "2's Complement". Make sure the number of samples is set to at least 8192, but do not exceed 32,768. Figure 8 shows a configured GUI for a 169.35-MHz tone.

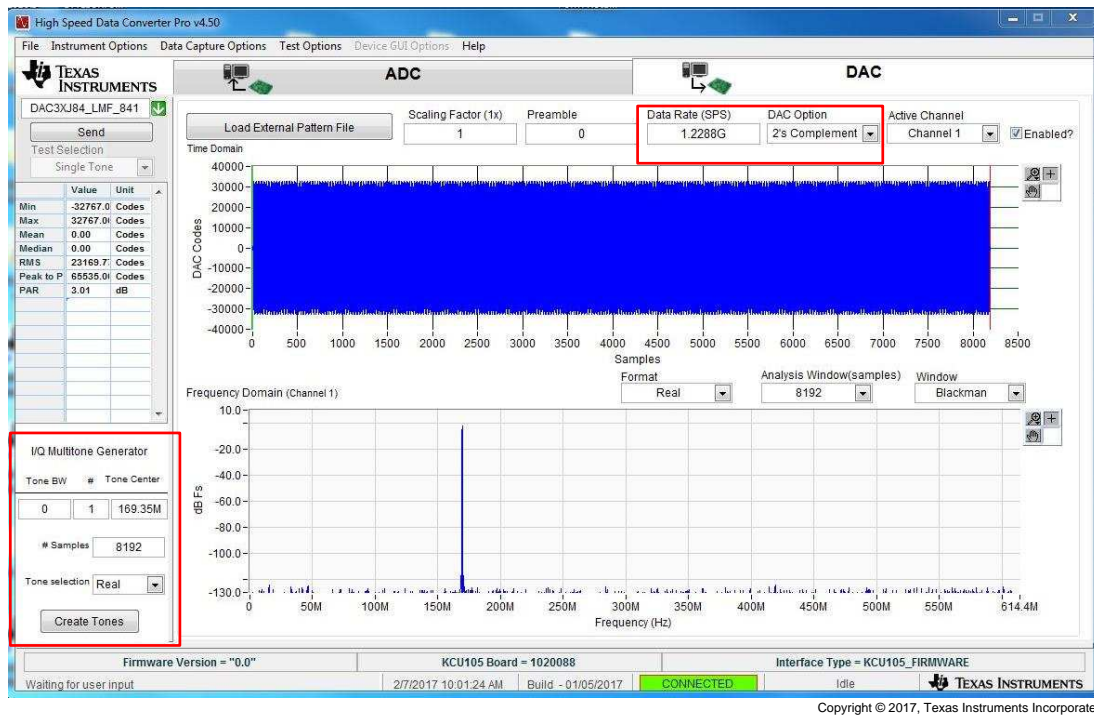

Figure 8. Generating a Tone With HSDC Pro GUI

6. Click the **Create Tones** button and press the **Send** button.
7. The new lane rate (12.288 GHz) and FPGA Clock (307.2 MHz) settings should be shown.
8. Go back to the DAC38J84 GUI and press **2. Reset DAC JESD Core** and **3. Trigger LMK04828 SYSREF**.
9. Connect channel one of the DAC38J84EVM to a spectrum analyzer and verify the signal. **Figure 9** shows the analog output generated by the DAC38J84EVM.

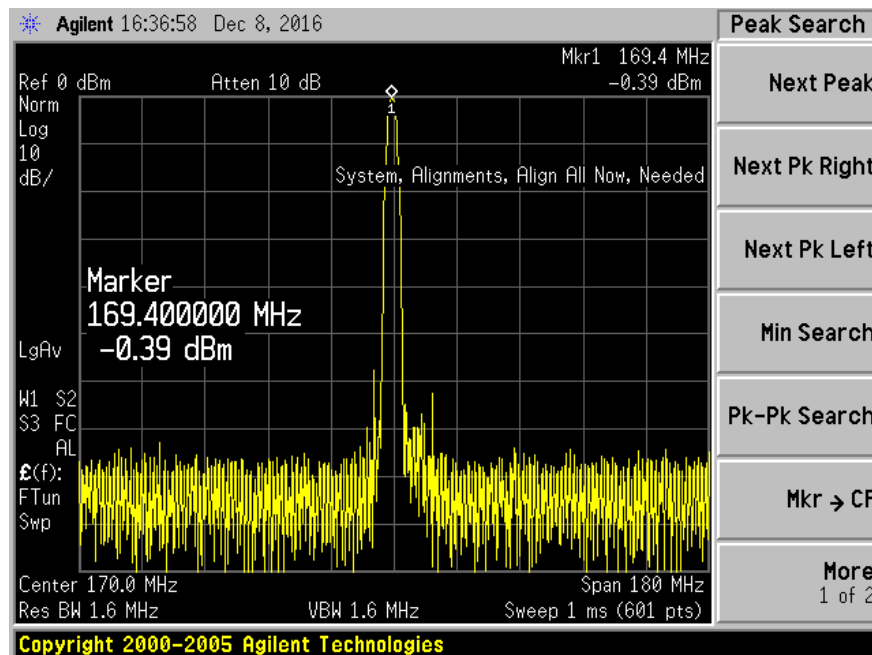
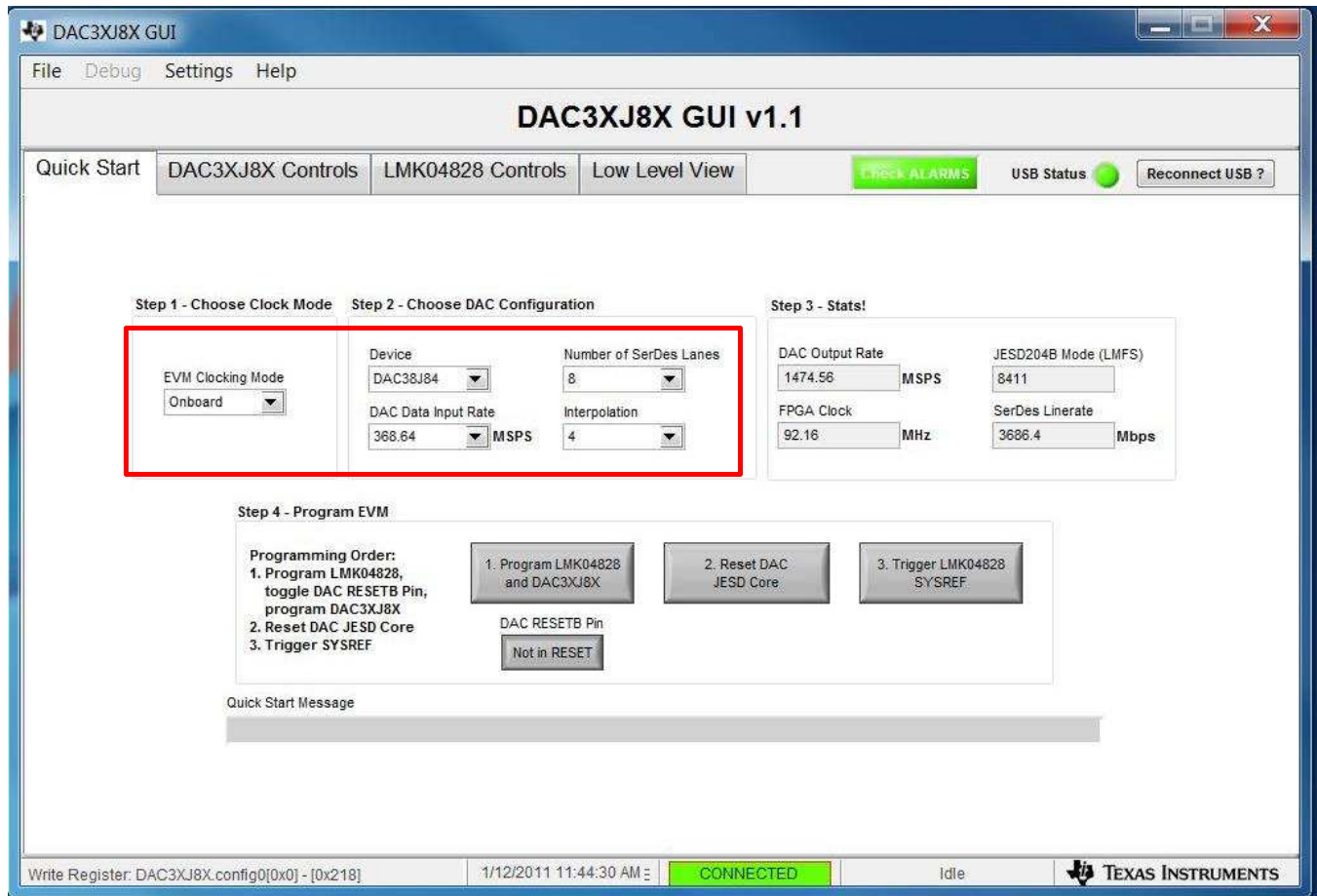

Figure 9. Analog Output by DAC38J84EVM

7.1.1 DAC38J84EVM Second Example

In this example, the same mode is used, but a different configuration that shows the limitations of the KCU105.

1. Configure the GUI as shown in [Figure 10](#):
 - (a) EVM Clocking Mode – "Onboard"
 - (b) DAC Data Input Rate – "368.64" MSPS
 - (c) Number of SerDes Lanes per DAC – "8"
 - (d) Interpolation – "4"



Copyright © 2017, Texas Instruments Incorporated

Figure 10. DAC38J84EVM GUI Configuration

By default, the DAC GUI is configured to generate an FPGA reference clock as line rate/40. Since the linerate is shown to be 3.6G the valid Multiplier line rate is only supported by x10 and x20 (refer to [Table 1](#)). In order to support this mode, the settings of the LMK04828 registers needs to be changed. From the GUI, navigate to the *LMK04828 Controls* tab. Under *Clock Outputs*, update the DCLK Divider to "16" in the DAC GUI as shown in [Figure 11](#).

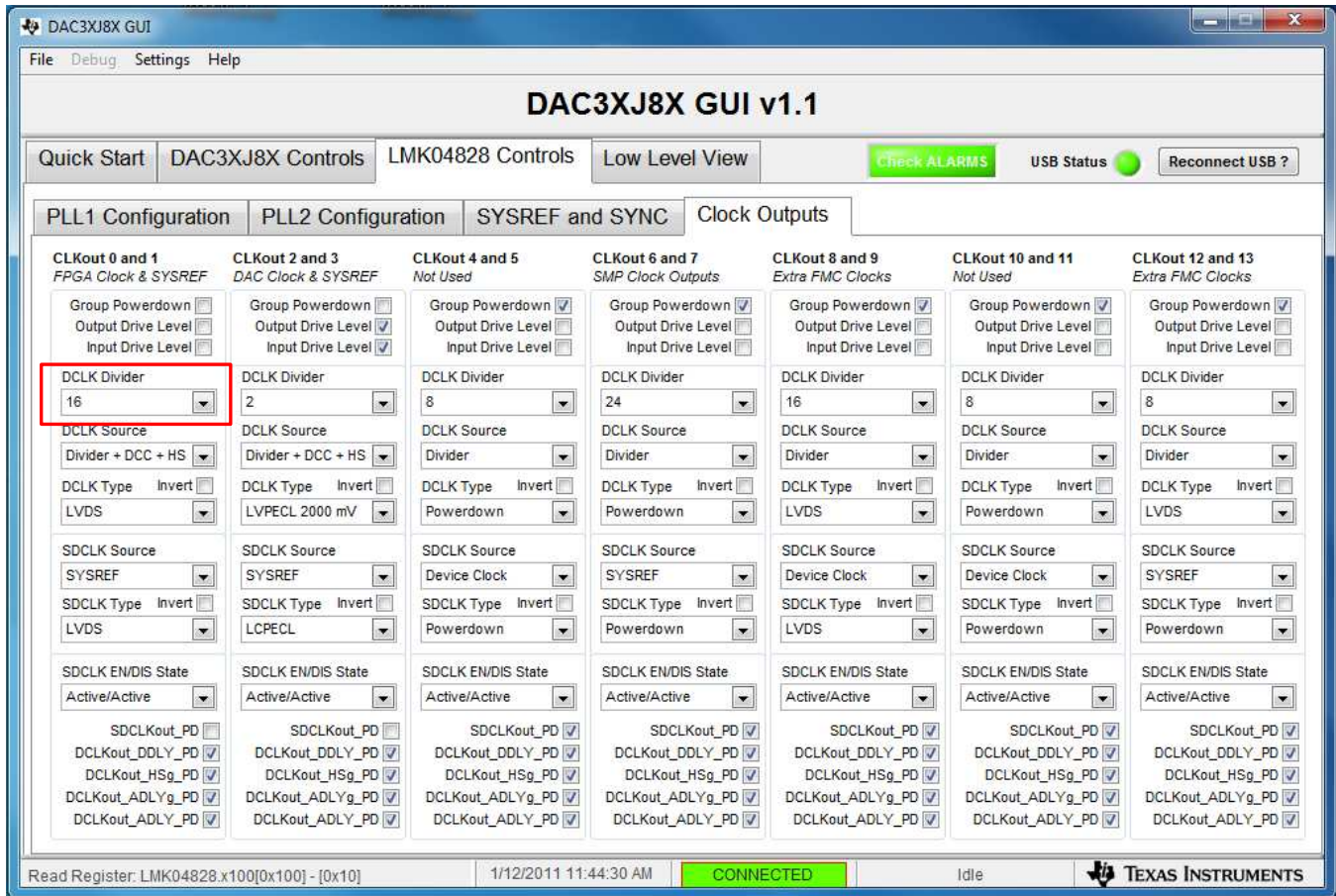

Copyright © 2017, Texas Instruments Incorporated

Figure 11. DAC38J84EVM GUI DCLK Divider

Follow the procedure in [Section 7.1](#) beginning with step number 4 to configure HSDC Pro and produce a tone. Note that the data rate has changed to 1474.56 MSPS.

7.2 ADC12J4000EVM With KCU105 Board Setup Example

The following section provides an example testing the ADC12J4000EVM in bypass mode using a KCU105 development platform.

NOTE: There is a jumper "KC705 JTAG" on the ADC12J4000EVM that will prevent the firmware from downloading if it is not shunted. By default, the board will have this jumper OPEN. The jumper is **required** to be shunted in order for this integration to work. The jumper is located on the top of the board near the FMC connector.

Make sure the instructions in [Section 6](#) are completed before testing the EVM. [Figure 12](#) shows a setup between the ADC12J4000EVM and KCU105.

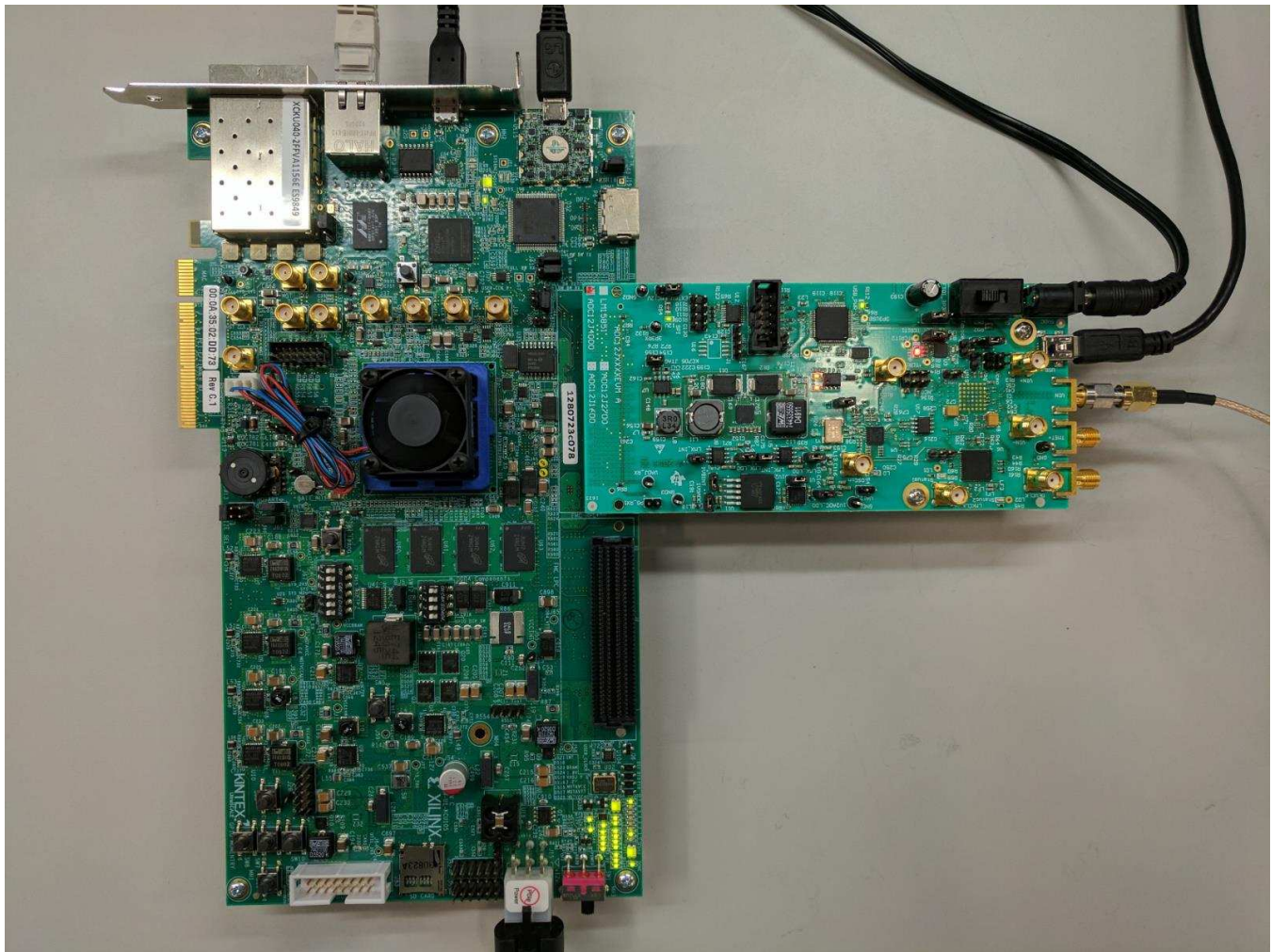

Copyright © 2017, Texas Instruments Incorporated

Figure 12. ADC12J4000EVM Setup With KCU105

Set up the hardware as follows:

1. Connect the power supply cables and power up the ADC12J400.
2. Open the ADC12J4000 GUI. The GUI is found under "Software" on www.ti.com featuring the [ADC12J4000EVM](#).
3. Choose "On-board" as the *Clock Source*, set *On-board Fs Selection* to "Fs = 4000 Msps", and set *Decimation and Serial Data Mode* to "Bypass Mode; DDR".
4. Click **Program Clocks and ADC**. [Figure 13](#) shows a screenshot of the configured GUI.

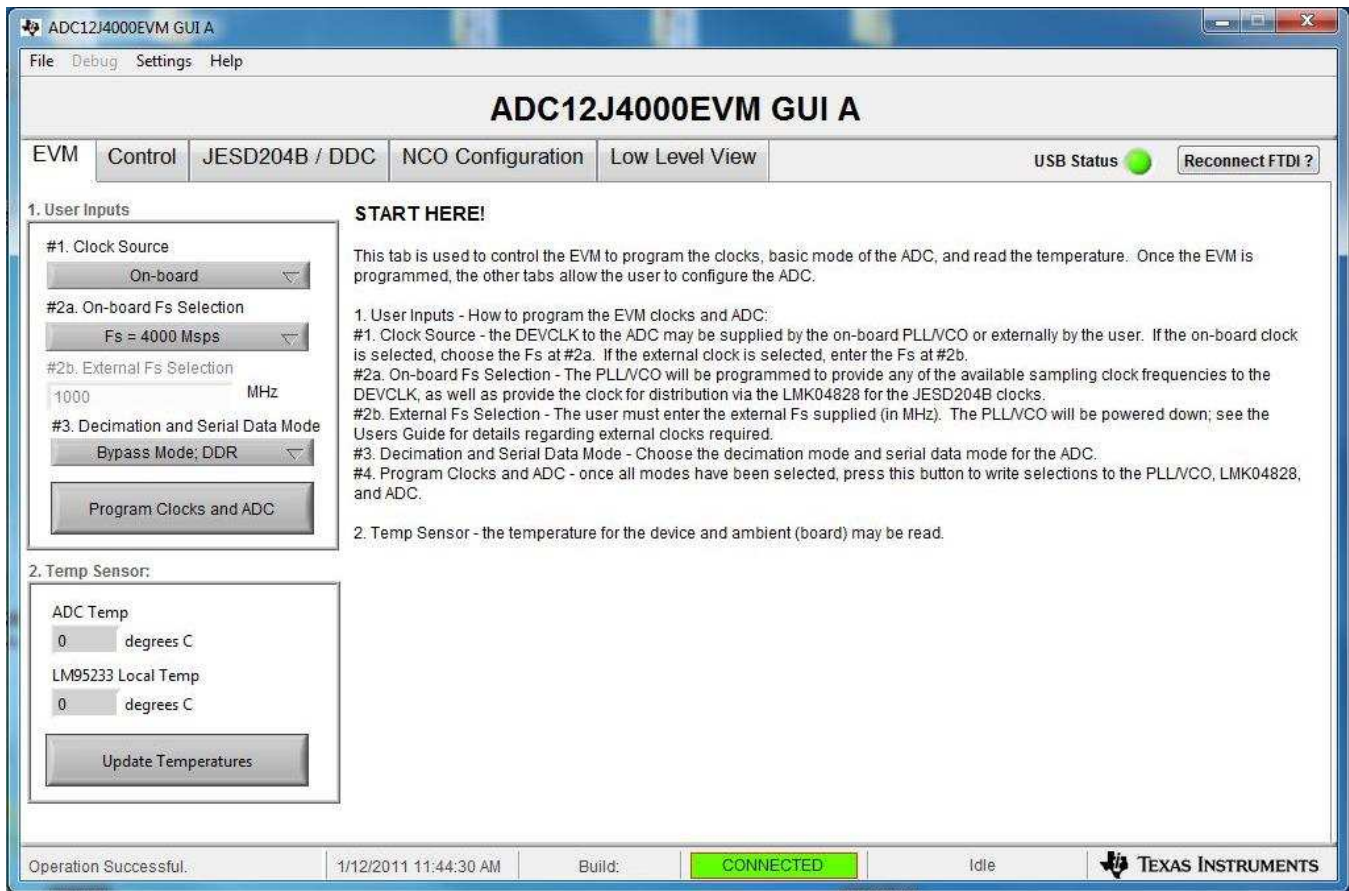

Copyright © 2017, Texas Instruments Incorporated

Figure 13. Configured ADC12J4000EVM GUI

5. Open HSDC Pro, select the *ADC* tab, and select "ADC12J4000_BYPASS" using the device drop-down menu.
6. Enter "4G" in the *ADC Output Data Rate* window. Verify the number of samples do not exceed 32,768.
7. Click the **Capture** button, and the new line rate (8G) and JESD reference clock (200M) should show.

Figure 14 shows a captured result sending a 170-MHz single tone through Vin at -1 dBFS.

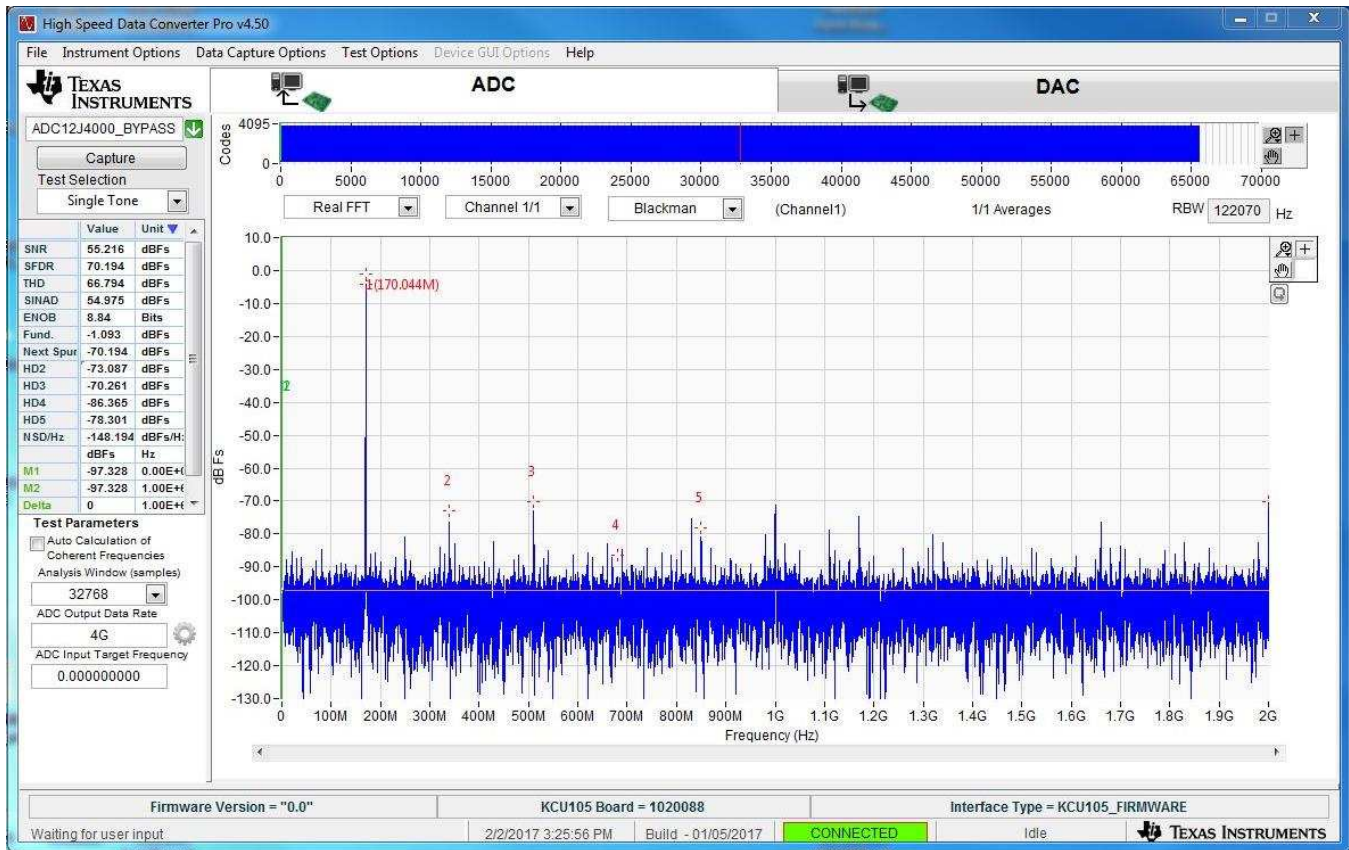

Copyright © 2017, Texas Instruments Incorporated

Figure 14. HSDC Pro ADC12J4000EVM Captured Result

7.3 ADC32RF45EVM With KCU105 Board Setup Example

The following section provides an example testing the ADC32RF45EVM in 8224 mode using an external clock in Bypass mode. Make sure the instructions in [Section 6](#) are completed before testing the EVM. [Figure 15](#) shows a setup between the ADC32RF45EVM and KCU105.

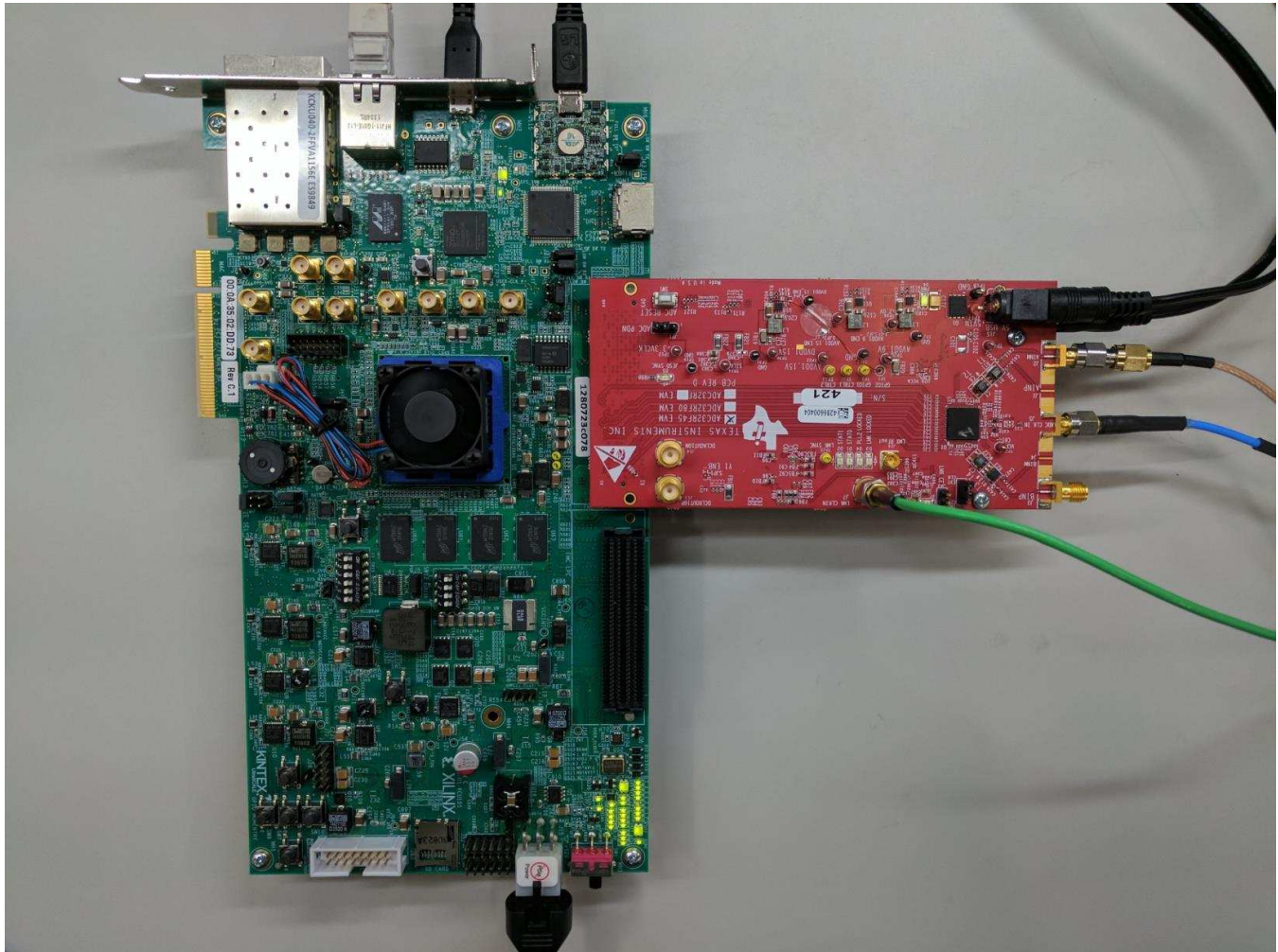

Copyright © 2017, Texas Instruments Incorporated

Figure 15. ADC32RF45EVM Setup With KCU105

Set up the hardware as follows:

1. Connect an external 2 GHz at 12-dBm source to ADC_CLK_IN (J5) of the ADC32RF45EVM.
2. Connect an external 2 GHz at 12-dBm source to LMK_CLKIN (J7) of the ADC32RF45EVM. This source must be synchronized with the ADC_CLK_IN source.
3. Connect the power supply cable to the EVM and open the ADC32RFxx EVM GUI. The GUI is found under "Software" on www.ti.com featuring the [ADC32RF45EVM](#).
4. Go to the *Quick Setup* tab and configure the GUI as shown in [Figure 16](#):
 - (a) *Clock Source to ADC* – "External Clocking"
 - (b) *ADC32RF45 Mode* – "Bypass"
 - (c) *BYPASS* – "14 bit"

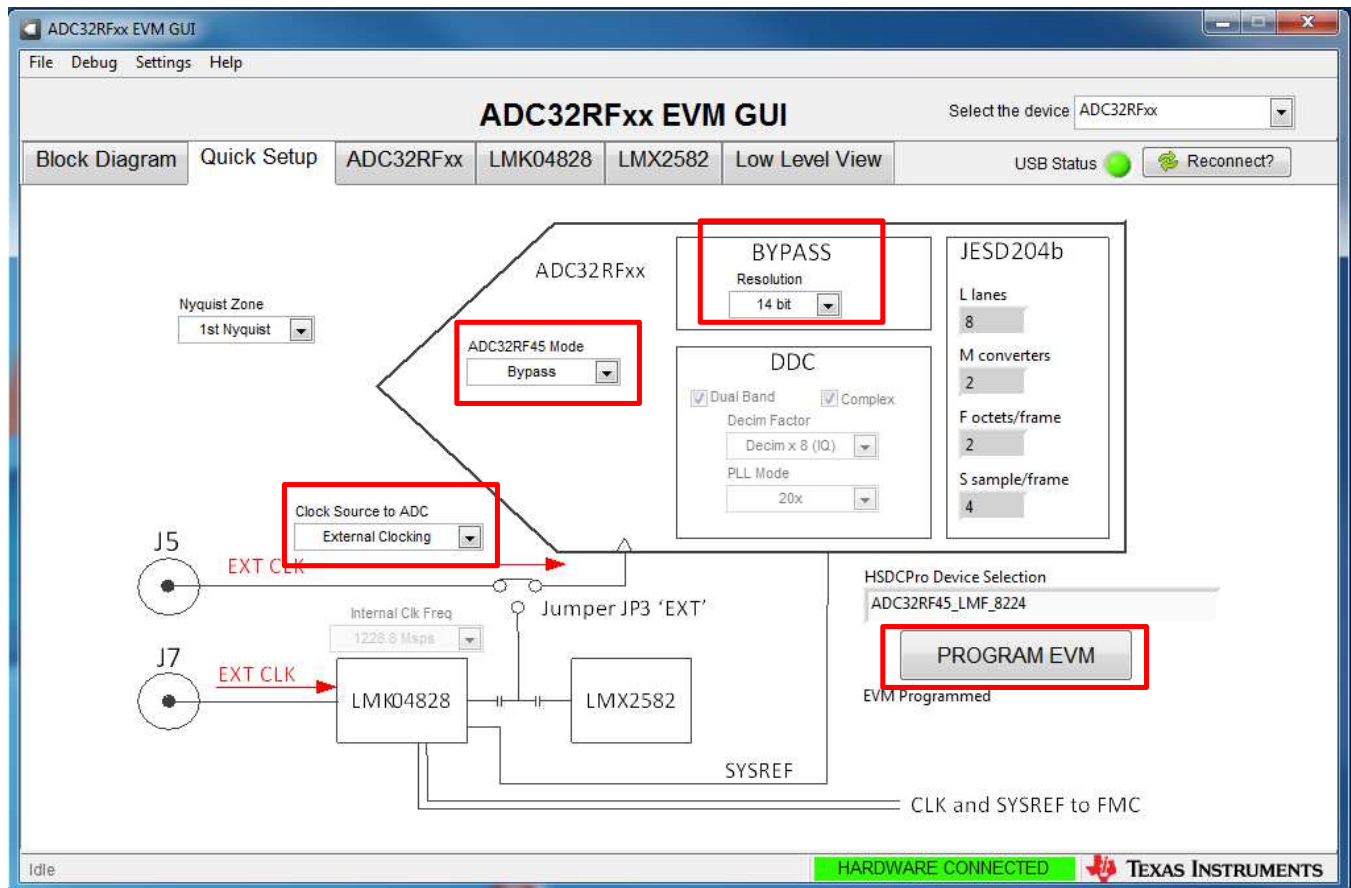

Copyright © 2017, Texas Instruments Incorporated

Figure 16. ADC32RF45EVM GUI Quick Setup

5. Click on **PROGRAM EVM**.
6. Go to the *Clock Outputs* tab under the *LMK04828* tab.
7. Verify *CLKout 0 and 1* divider is set to "8" as shown in [Figure 17](#).

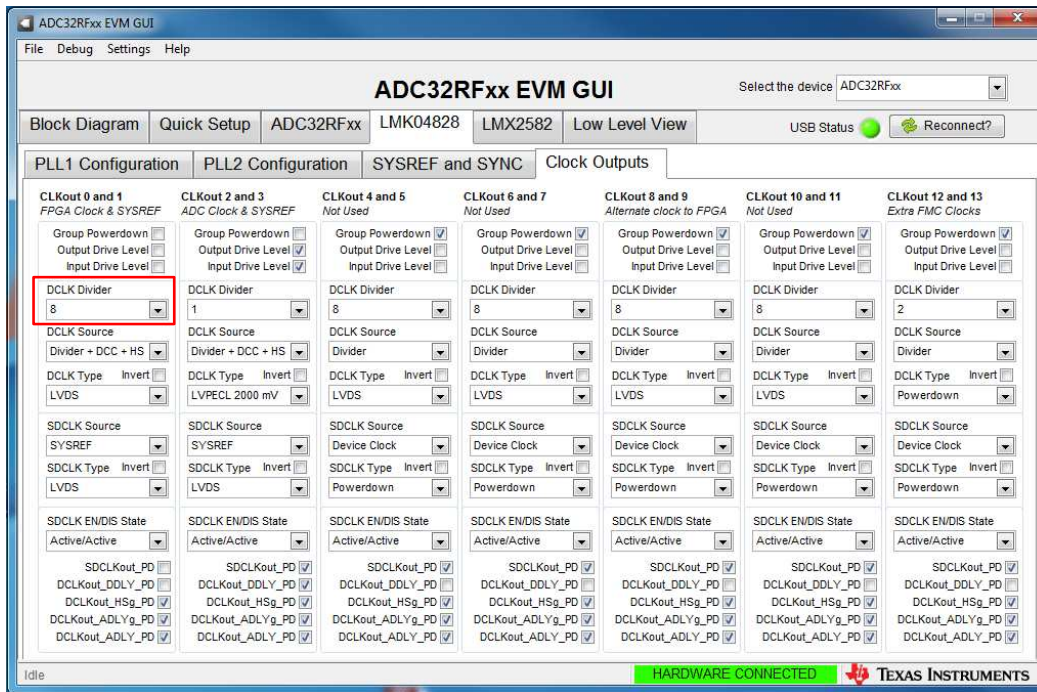

Figure 17. ADC32RFEVM GUI Clock Outputs

8. Click on the *SYSREF and SYNC* tab. Verify the *SYSREF Divider* is set to "1024".
9. In the *ADC Configuration* tab under *ADC32RFxx*, set the *JESD204b Lane De-emphasis* setting to "0" dB for all lanes, as shown in [Figure 18](#).

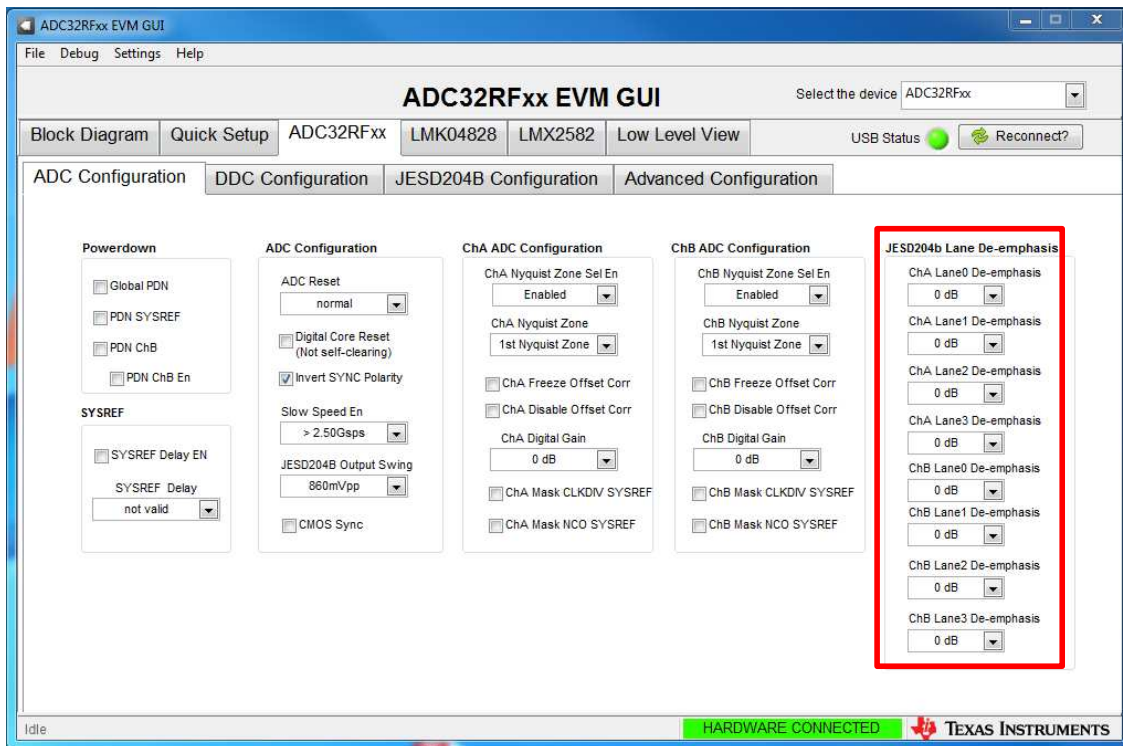
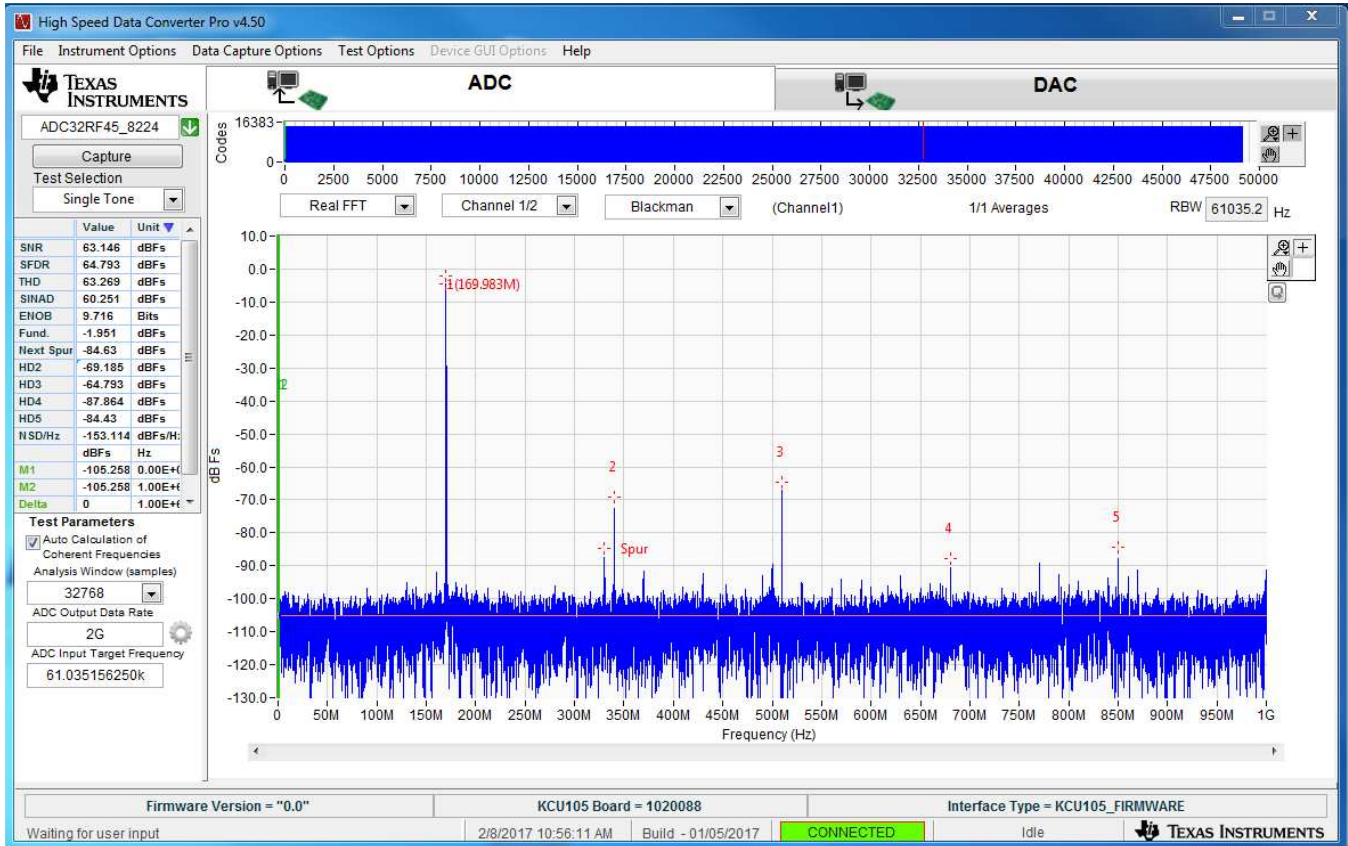

Figure 18. ADC32RF45 GUI Lane De-Emphasis

10. Open HSDC Pro, select the *ADC* tab, and select "ADC32RF34_8224" using the drop-down menu.
11. Enter "2G" for *ADC Output Data Rate*, the new lane rate (10G) and reference clock settings (200M) will be shown. Verify the number of samples do not exceed 32,768.
12. Click the **Capture** button. Figure 19 shows a captured result sending a 170-MHz single tone through Vin at -2 dBFS to AINP (J2).



Copyright © 2017, Texas Instruments Incorporated

Figure 19. ADC32RF45EVM Capture on HSDC Pro

7.4 ADS54J20EVM With KCU105 Board Setup Example

The following section provides an example testing the ADS54J20EVM in 8224 mode with the KCU105 development platform. EVMs in the same family, such as the ADS54J40EVM and ADS54J60EVM, can be configured with the same instructions and proper configuration files. Make sure the instructions in [Section 6](#) are completed before testing the EVM. [Figure 20](#) shows a setup between the ADS54J20EVM and the KCU105.

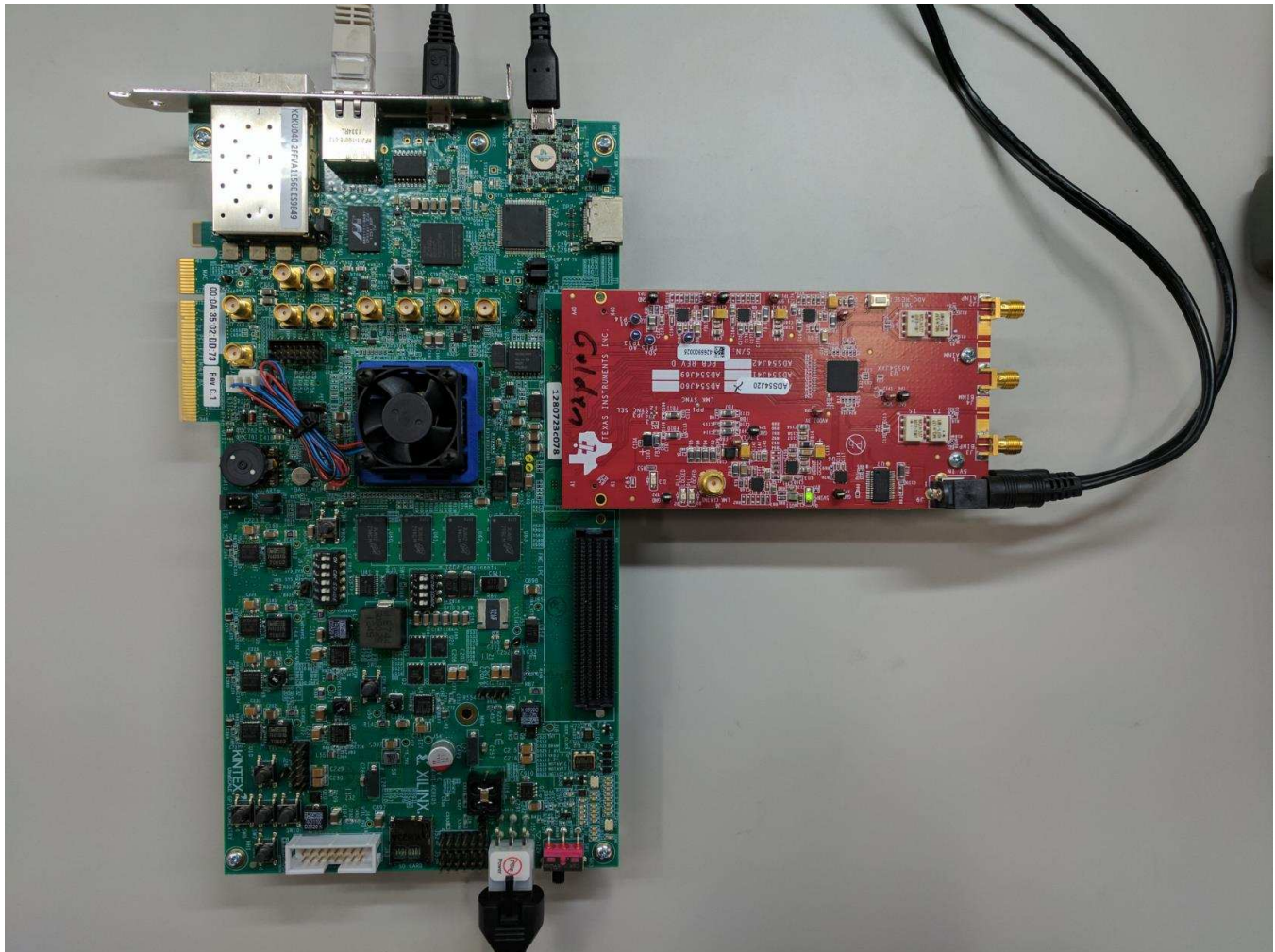

Copyright © 2017, Texas Instruments Incorporated

Figure 20. ADS54J20EVM Setup With KCU105

Set up the hardware as follows:

1. Power up the ADS54J40 and open the ADS54JxxEVM GUI. The GUI is found under "Software" on www.ti.com featuring the [ADS54J20EVM](#).
2. Navigate to the *LMK04828* tab, and click the **RESET** button
3. On the *Low Level View* tab, load the following configuration files: "LMK_983p04_8224_VC707.cfg" as shown in [Figure 21](#).

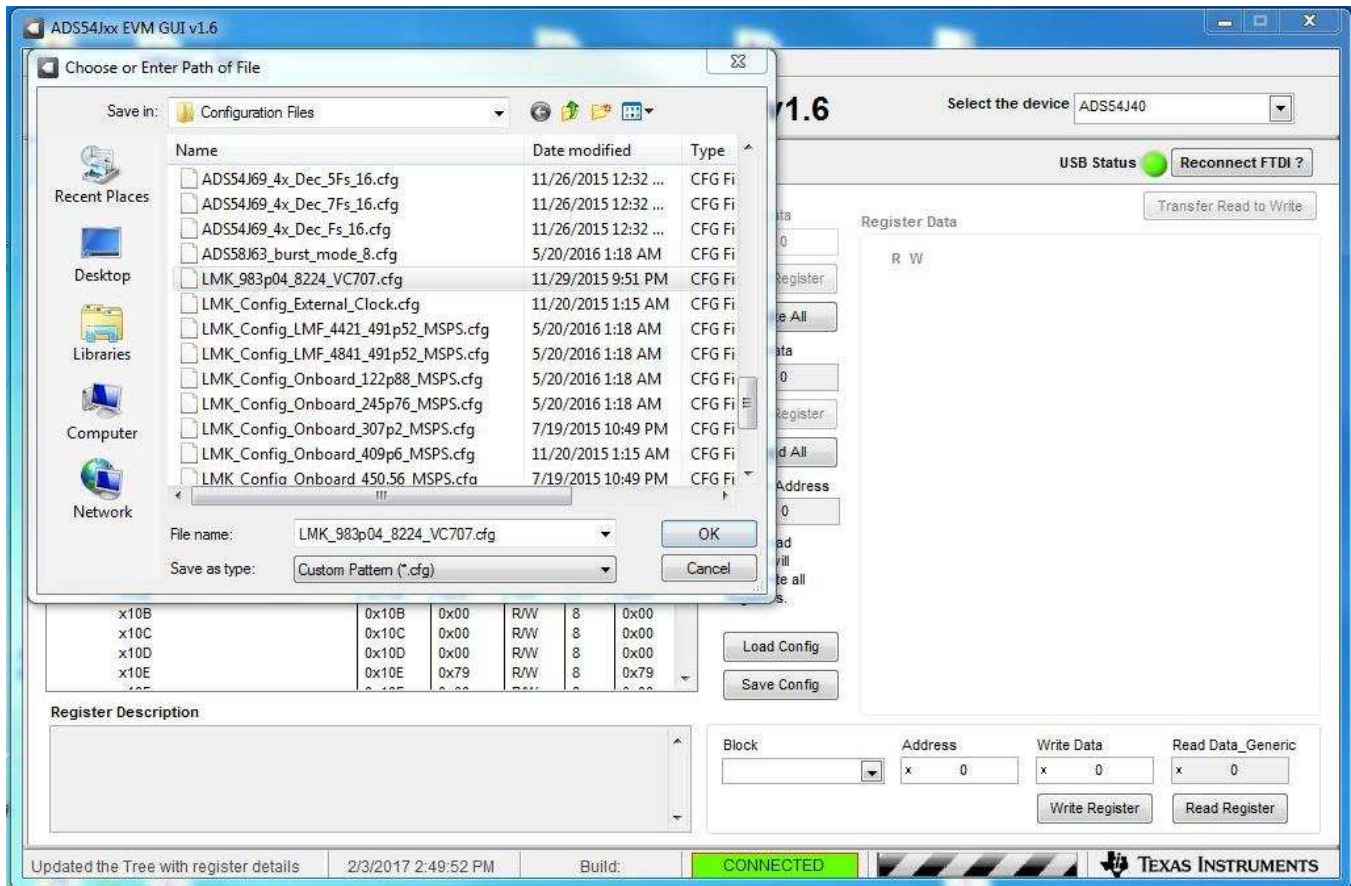

Copyright © 2017, Texas Instruments Incorporated

Figure 21. Configuration Files for ADS54J20EVM GUI

4. Press the **ADC RESET** button (SW1) on the EVM to provide a hardware reset to the ADC
5. On the *Low Level View Tab*, load the ADC configuration file: "ADS54J20_LMF_8224.cfg".

6. Open HSDC Pro, select "ADS54J20_LMF_8224" in the drop-down arrow.
7. Verify the number of samples do not exceed 32,768. Enter "983.04M" in the *ADC Output Data Rate* window.
8. The GUI will display the new lane rate (4.9152G) and JESD reference clock required by the capture platform FPGA (245.76M).
9. Click on **OK**. Click the **Capture** button. [Figure 22](#) shows a captured result sending a 170-MHz single tone through Vin at -1 dBFS.

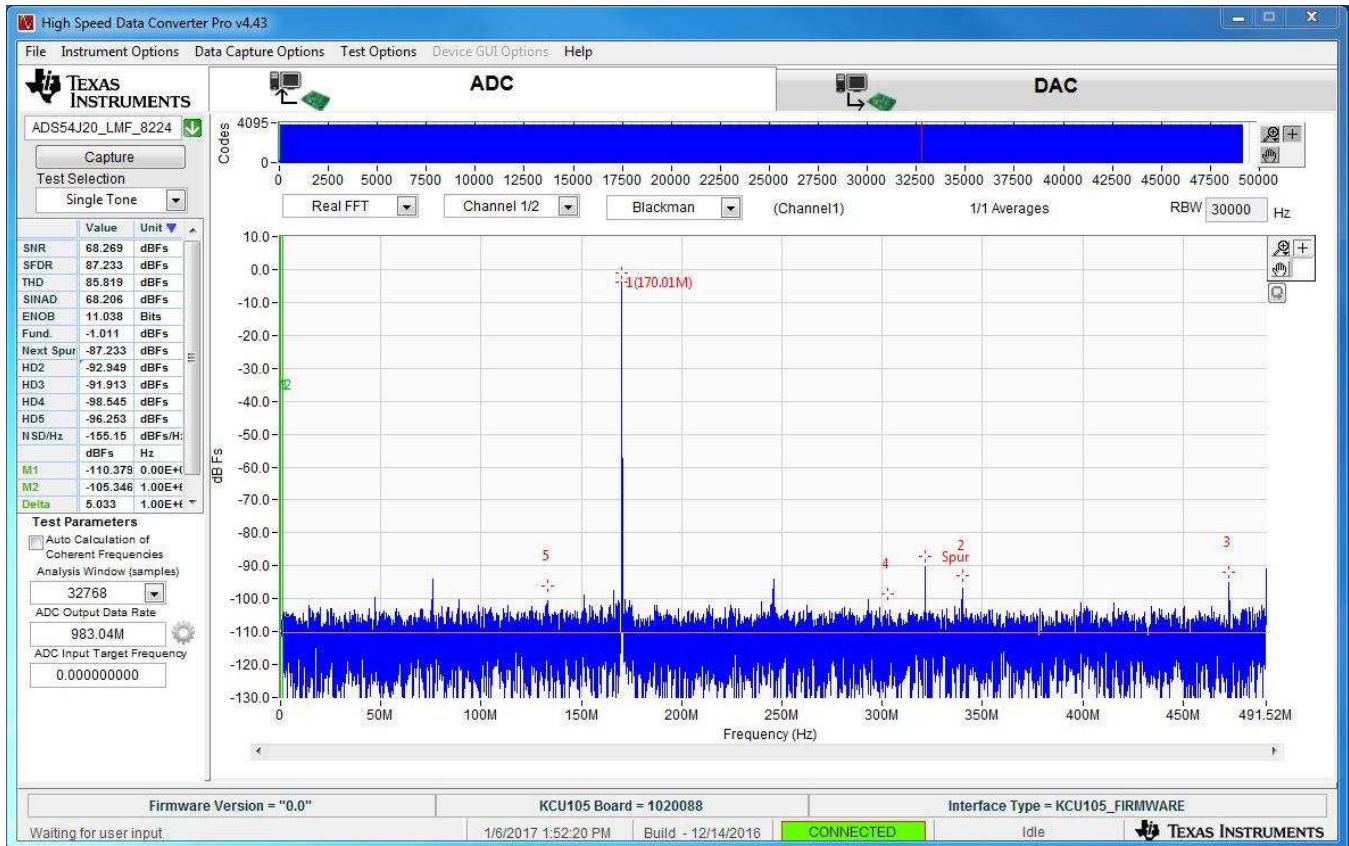

Copyright © 2017, Texas Instruments Incorporated

Figure 22. HSDC Pro ADS43J20EVM Captured Result

7.5 ADS42JB49EVM With KCU105 Board Setup Example

The following section provides an example testing the ADS42JB49EVM in 421 mode with the KCU105 development platform. EVMs in the same family, such as the ADS42JB69EVM, can be configured with the same instructions and proper configuration files. Make sure the instructions in [Section 6](#) are completed before testing the EVM. [Figure 23](#) shows a setup between the ADS42JB49EVM and the KCU105.

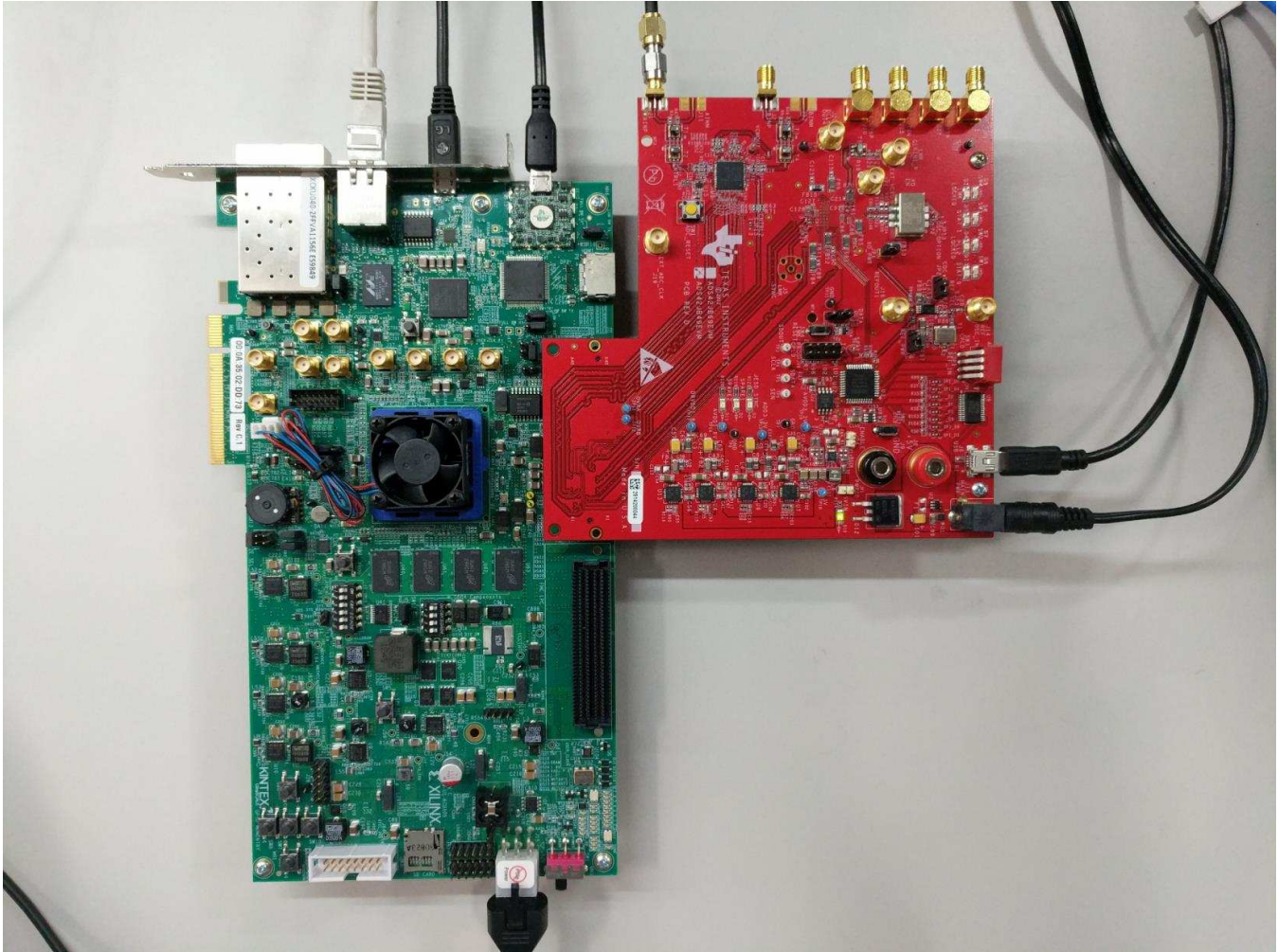

Copyright © 2017, Texas Instruments Incorporated

Figure 23. ADS42JB49EVM Setup With KCU105

Set up the hardware as follows:

1. Connect the power cable to the ADS42JB49EVM and open the ADS42JBXX GUI. The GUI is found under "Software" on www.ti.com featuring the [ADS42JB69EVM](#).
2. Go to the *ADS42JBXX* tab and click on **Device Reset** in the top left corner.
3. Go to the *LMK0428* tab and click on **RESET** in the top left corner.
4. Go to the *Low Level View* tab and click on **Load Config**. Load the configuration file: "ADS42JB69_EVM_LMF421_250M.cfg".

5. Open HSDC Pro, select the *ADC* tab, and then select "ADS42JB49_LMF_421" using the device drop-down menu.
6. Verify the number of samples do not exceed 32,768.
7. Enter "250M" in the *ADC Output Data Rate* window. The GUI will display the new lane rate (2.5G) and JESD reference clock required by the capture platform FPGA (250M).
8. Click on **OK**. Connect an analog input signal to the SMA connect (J1)
9. Click the **Capture** button. [Figure 24](#) shows a captured result sending a 80-MHz single tone through Vin at -1 dBFS.

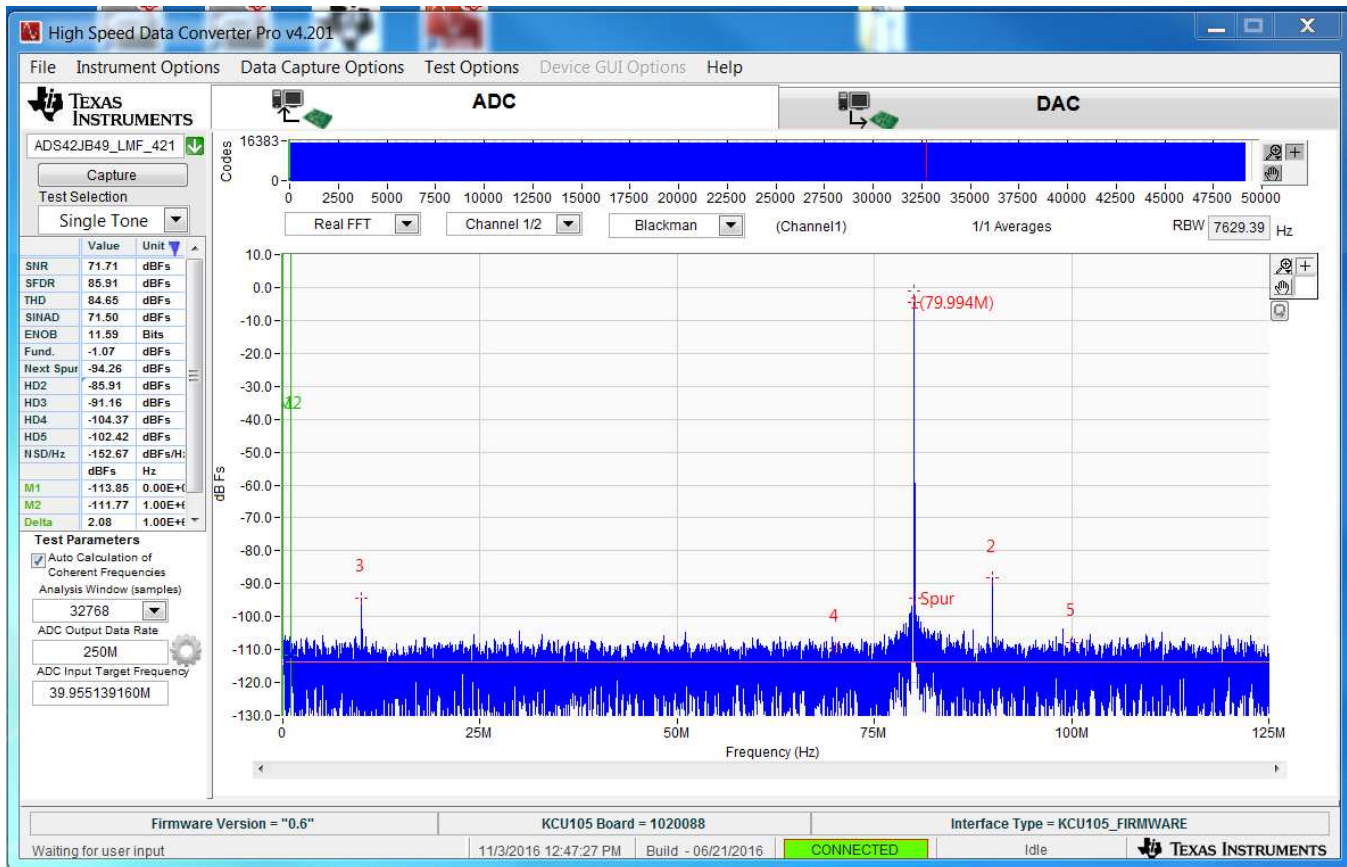

Copyright © 2017, Texas Instruments Incorporated

Figure 24. HSDC Pro ADS42JB49EVM Captured Result

7.6 DAC38RF82EVM With KCU105 Board Setup Example

The following section provides an example of testing the DAC38RF82EVM using a KCU105 development platform. With the updated firmware, users can use the DAC38RFX GUI as if it was connected to a TI TSW14J56. Make sure the instructions in [Section 6](#) are completed before testing the EVM. [Figure 25](#) shows a setup between the DAC38J84EVM and KCU105.

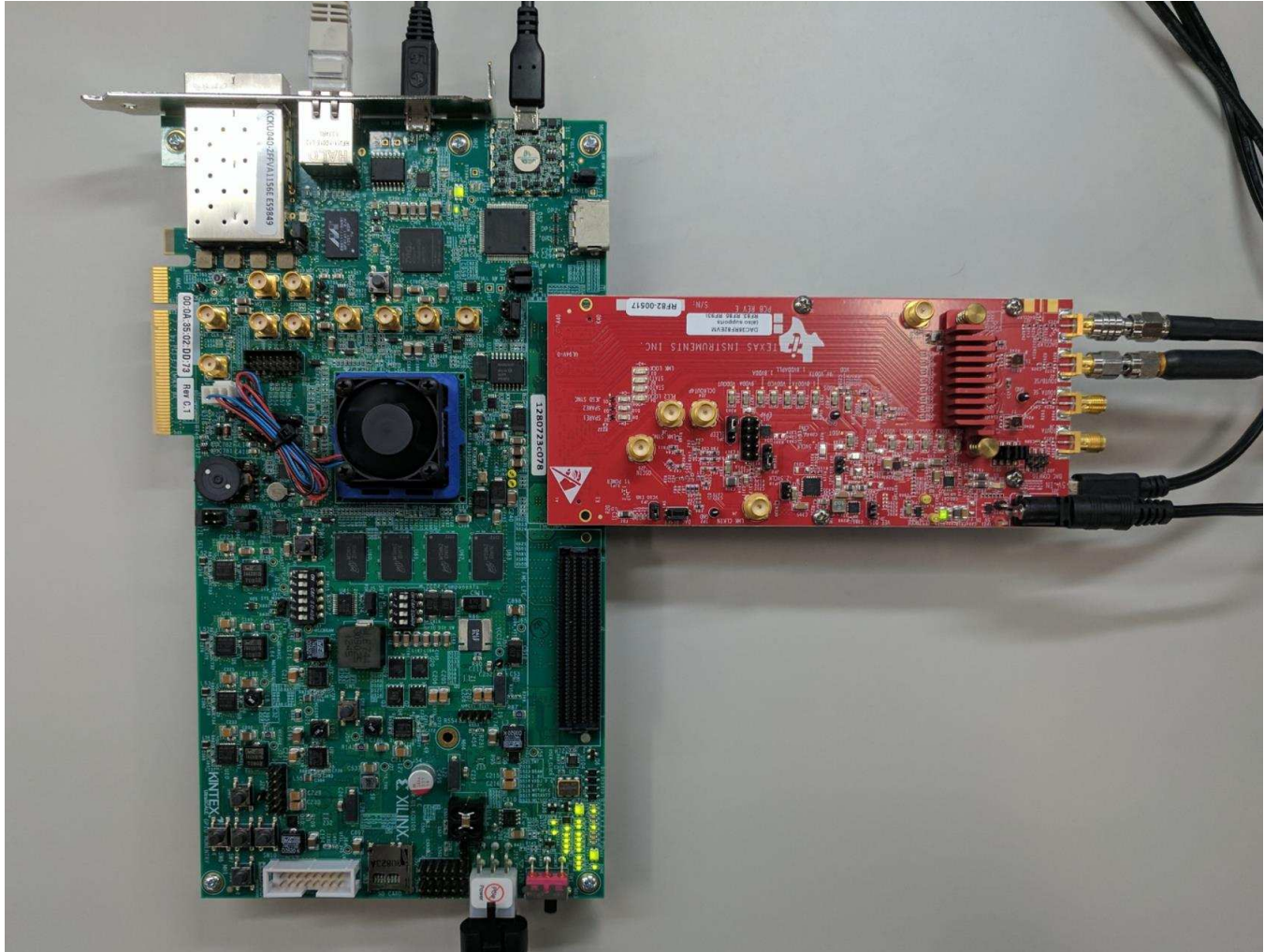

Copyright © 2017, Texas Instruments Incorporated

Figure 25. DAC38RF82EVM Setup With KCU105

7.6.1 External Clock Mode DAC38RF82EVM

This section shows how to set up an DAC38RF82EVM using an external clock. This example will configure the JESD204B DAC in an 841 mode.

Set up the hardware as follows:

1. Connect a 6 GHz, 14-dBm output from a signal generator to DACCLK (J1) of the DAC38RF82EVM.
2. Verify that jumper labeled JP10 is SHUNT 1-2 to enable external clock mode.
3. Connect a power cable to the DAC38RF82EVM and open the DAC38RFXX GUI. The GUI is found under "Software" on www.ti.com featuring the [DAC38RF82EVM](#).
4. On the *Quick Start* tab, toggle *DAC RESETB Pin* and press the **Load Default** button.
5. Configure the GUI as shown in [Figure 26](#):
 - (a) *DAC Clock Frequency (MHz)* – "6000"
 - (b) *# of DACs* – "Dual DAC"
 - (c) *# of IQ pairs per DAC* – "1 IQ pair"
 - (d) *# of serdes lanes per DAC* – "4 Lanes"
 - (e) *Desired Interpolation* – "16x"

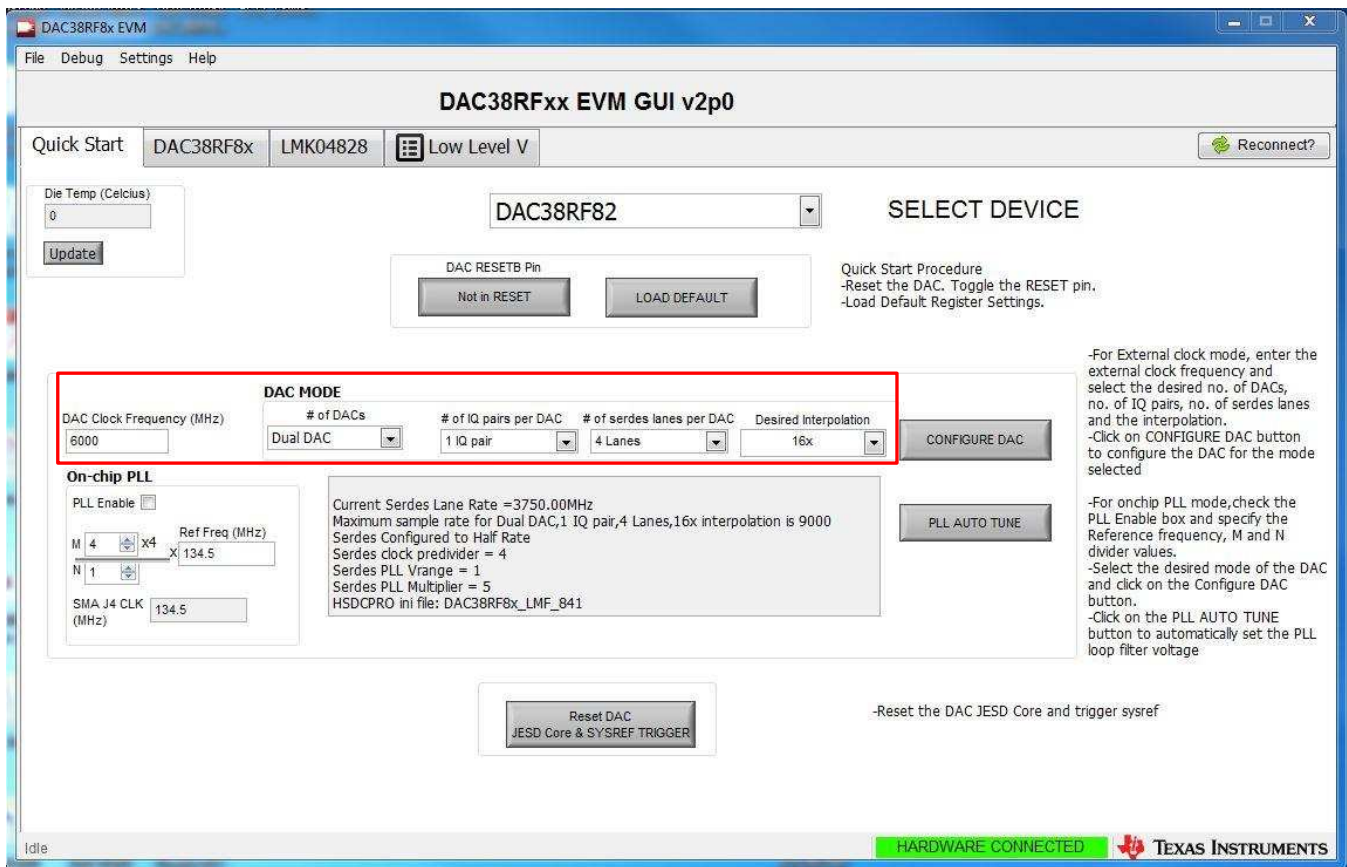
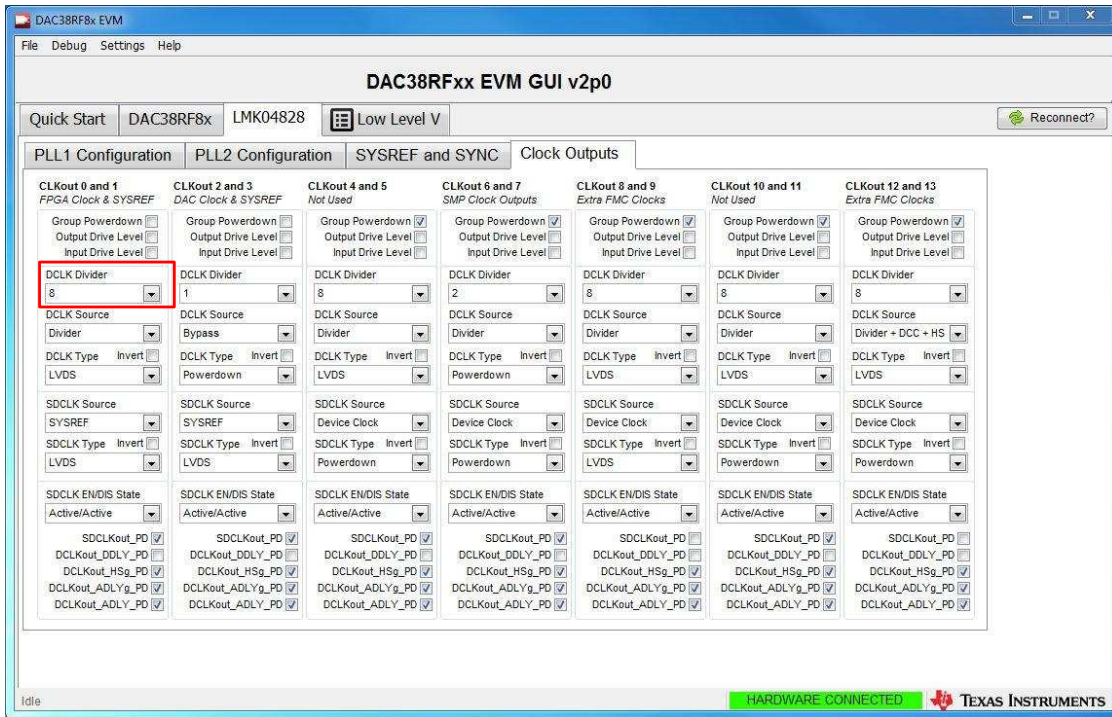

Figure 26. DAC38RFXX EVM GUI in External Clock Mode

6. Press the **CONFIGURE DAC** button, then the **PLL AUTO TUNE** button, then the **Reset DAC JESD Core & SYSREF TRIGGER** button.
7. Navigate to the *LMK04828* tab. Change the *DCLK Divider* on *CLKout 0 and 1* to "8" as shown in [Figure 27](#). This will provide the right reference clock to send to the KCU105.



Copyright © 2017, Texas Instruments Incorporated

Figure 27. DAC38RF82EVM GUI DCLK Divider

8. Open HSDC Pro, press the *DAC* tab, and select "DAX38RF8X_LMF_841" from the drop-down menu.
9. Enter "375M" as the *Data Rate (SPS)* and change the *DAC Option* to "2's Complement". Make sure the number of samples is set to at least 8192, but do not exceed 32,768. Figure 28 shows a configured GUI for a 150-MHz tone.

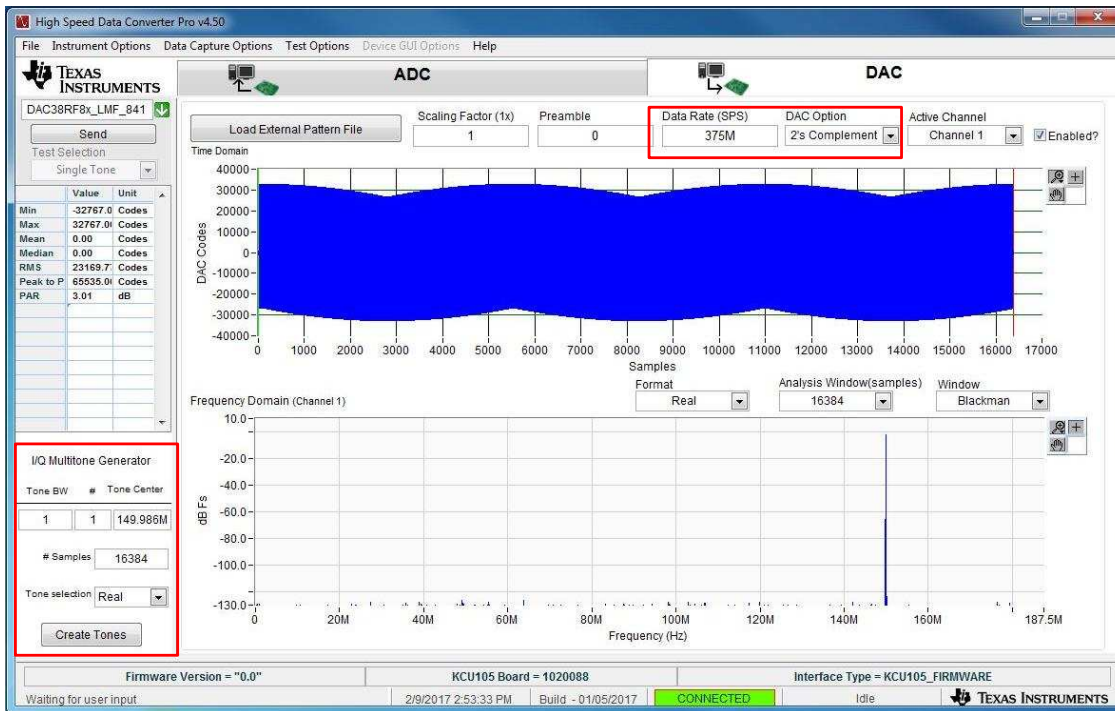

Copyright © 2017, Texas Instruments Incorporated

Figure 28. Generating a 150-MHz Tone on HSDC Pro

10. Click the **Create Tones** button and press the **Send** button.
11. The new lane rate (3.750 GHz) and FPGA Clock (375 MHz) settings should be shown.
12. Go back to the DAC38RFXX GUI and press the **Reset DAC JESD Core & SYSREF TRIGGER** button.
13. Connect channel one of the DAC38RF82EVM (J6) to a spectrum analyzer and verify the signal. [Figure 29](#) shows the analog output generated by the DAC38RF82EVM

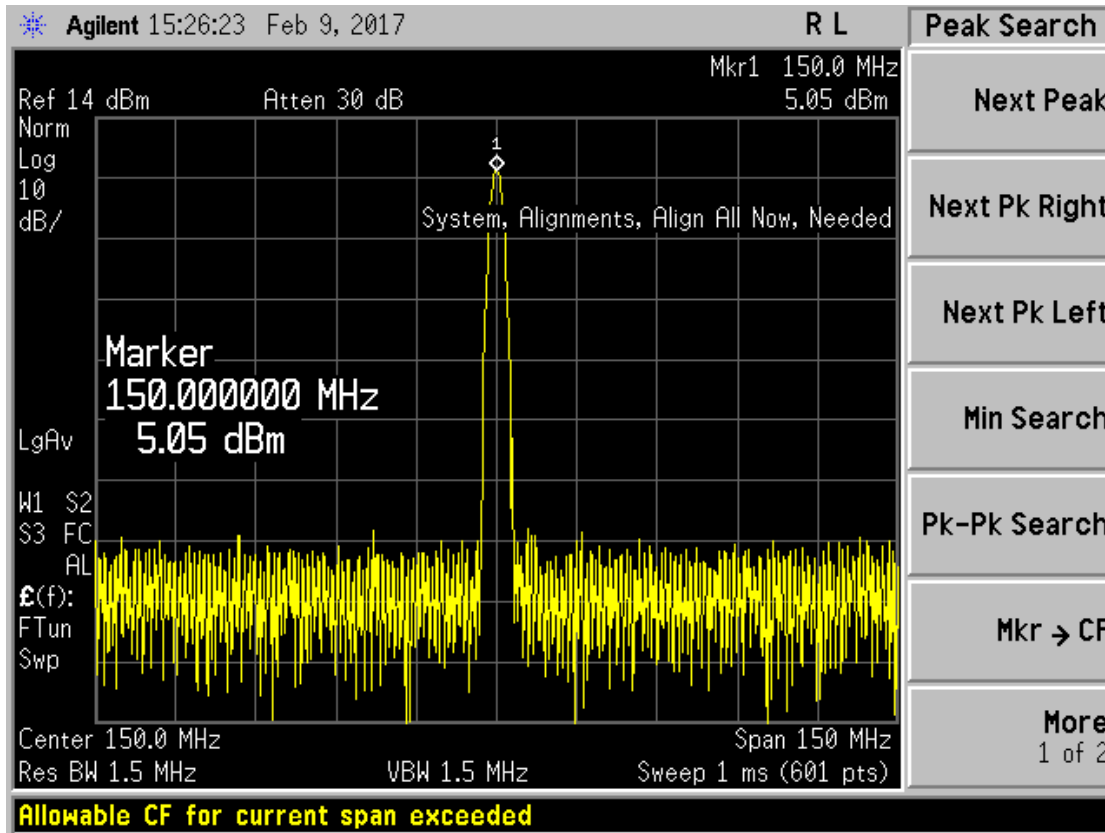

Copyright © 2017, Texas Instruments Incorporated

Figure 29. Analog Output From DAC38RF82EVM

7.6.2 Phased-Locked Loop (PLL) Mode DAC38RF82EVM

This section shows how to setup an DAC38RF82EVM using the internal PLL to generate the clocking. This example will configure the JESD204B DAC in an 841 mode.

Set up the hardware as follows:

1. Connect a 245.76 MHz, 12-dBm output from a signal generator to EVM LMK CLKIN (J4) of the DAC38RF82EVM.
2. Verify that the jumper labeled JP10 is OPEN.
3. Connect a power cable to the DAC38RF82EVM and open the DAC38RFXX GUI. The GUI is found under "Software" on www.ti.com featuring the [DAC38RF82EVM](#).
4. On the *Quick Start* tab, toggle the *DAC RESETB Pin* and press the **Load Default** button
5. Configure the GUI as shown in [Figure 30](#):
 - (a) *PLL Enable* – "Check"
 - (b) *M* – "9", *N* – "1"
 - (c) *Ref Freq (MHz)* – "245.76"
 - (d) *# of DACs* – "Dual DAC"
 - (e) *# of IQ pairs per DAC* – "1 IQ pair"
 - (f) *# of serdes lanes per DAC* – "4 Lanes"
 - (g) *Desired Interpolation* – "18x"

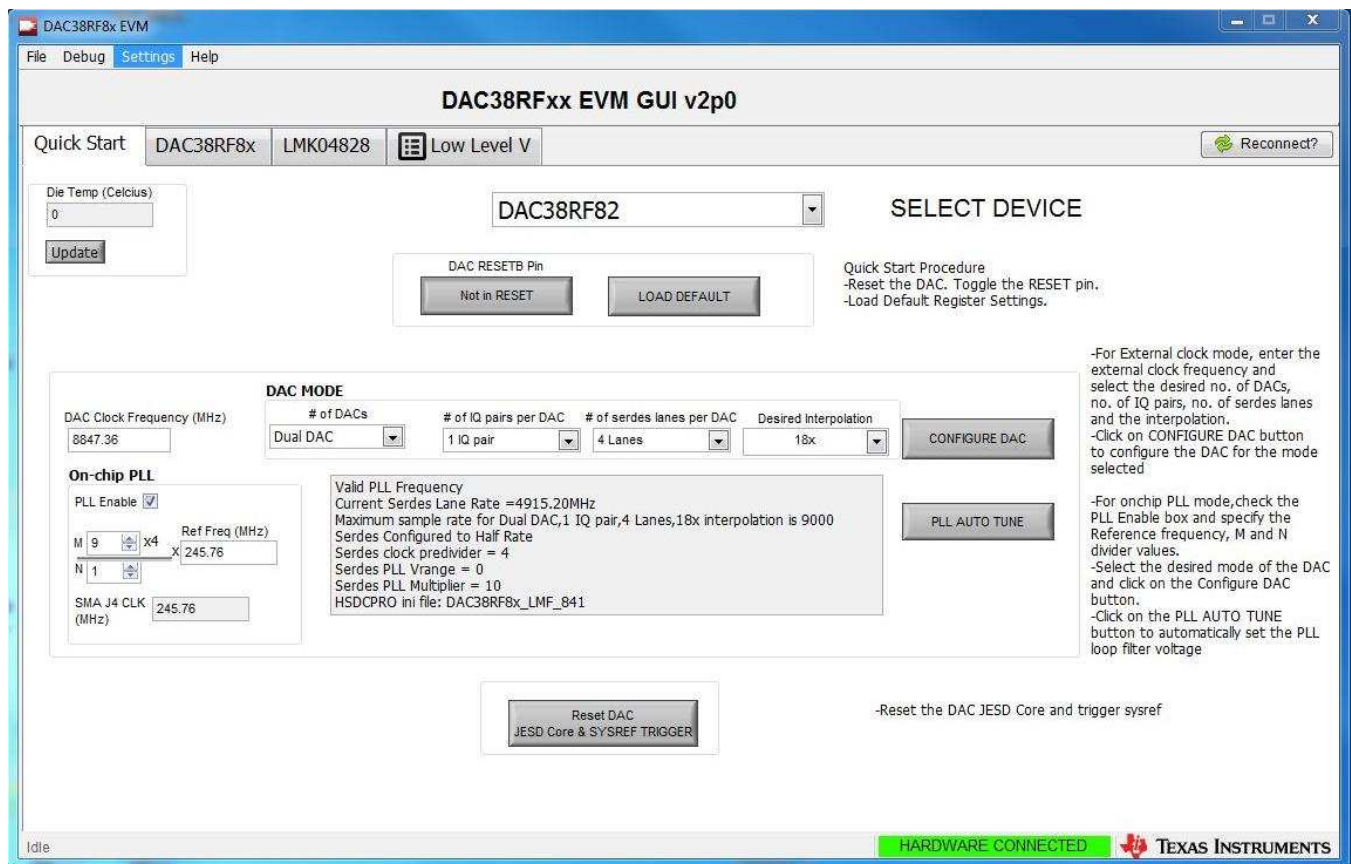

Copyright © 2017, Texas Instruments Incorporated

Figure 30. DAC38RFXX EVM GUI in PLL Mode

6. Press the **CONFIGURE DAC** button, followed by the **PLL AUTO TUNE** button, then the **Reset DAC JESD Core & SYSREF TRIGGER** button.

- Navigate to the *DAC38RF8x* tab. Under *Digital(DAC A)*, enable the *Mixer* and *NCO* as shown in [Figure 31](#). Set the *Mixer Gain* to "6dB", and the *NCO Frequency (MHz)* to "1960".
- Click the **UPDATE NCO** button. Go back to the *Quick Start* tab and press **Reset DAC JESD Core & SYSREF TRIGGER** button. This can also be done on the *Digital(DAC B)* tab, which will provide an *NCO Frequency* on channel B.

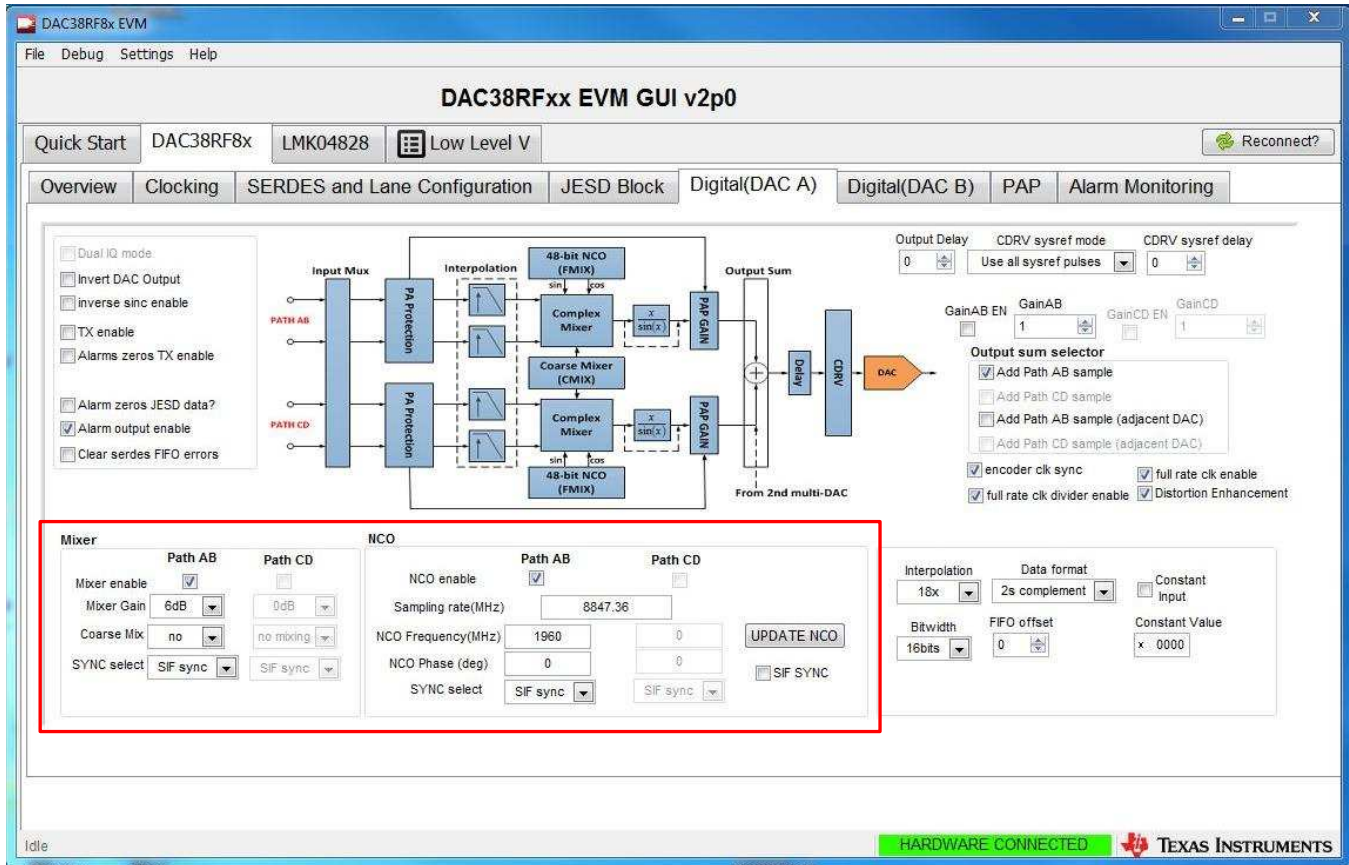

Copyright © 2017, Texas Instruments Incorporated

Figure 31. DAC38RF82EVM GUI NCO Frequency Settings

9. In HSDC Pro, press on the *DAC* tab, and select "DAX38RF8X_LMF_841" from the drop-down menu.
10. Enter "491.52" as the *Data Rate (SPS)* and change *DAC Option* to "2's Complement". Make sure the number of samples is set to at least 8192, but no more than 32,768.
11. Set the following in the *I/Q Multitone Generator*:
 - (a) *Tone BW* – "1"
 - (b) *# of Tones* – "1"
 - (c) *Tone Center* – "0" (This will change to the closest value possible to DC.)
 - (d) *Tone selection* – "Complex"

Figure 32 is a screenshot of a proper configuration on HSDC Pro.

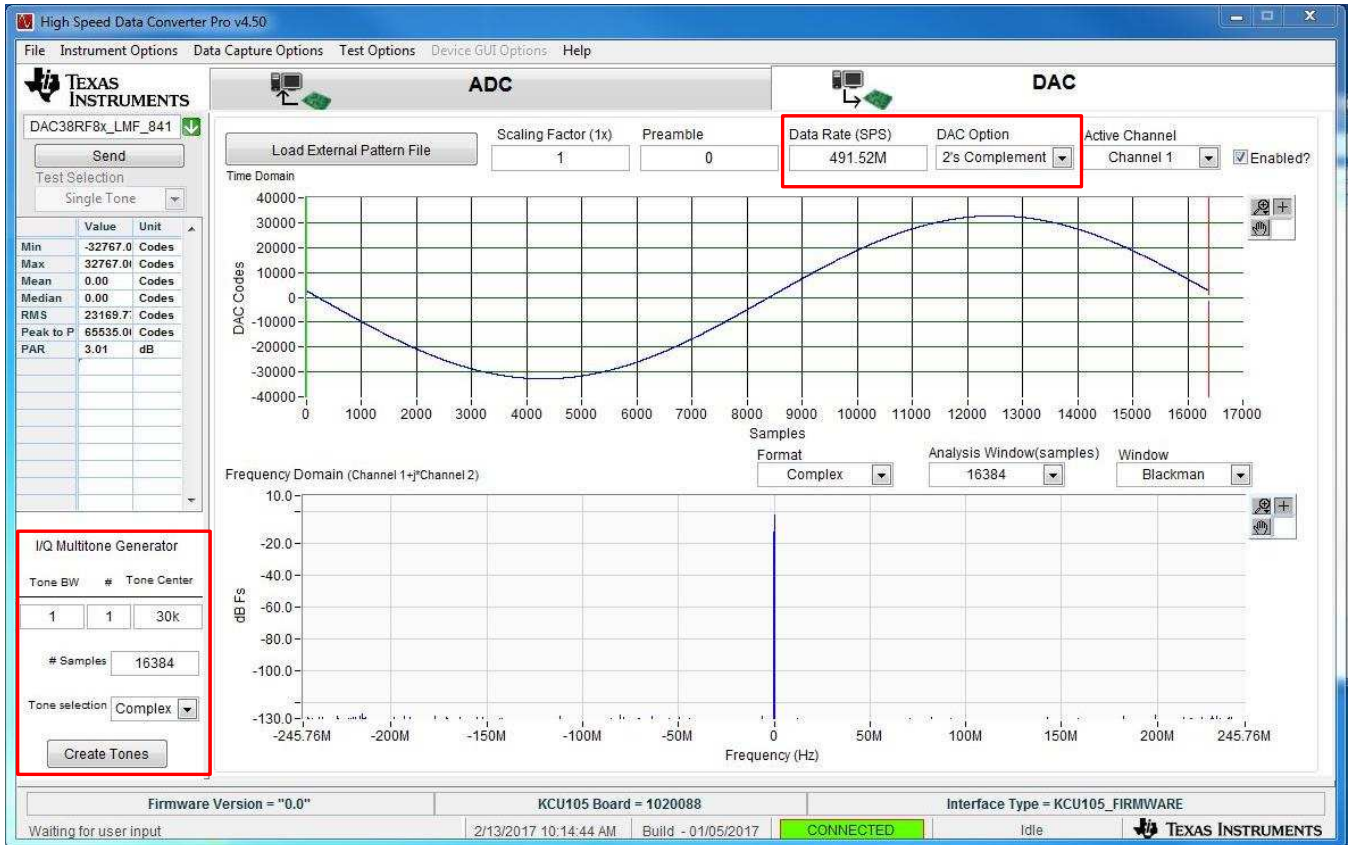

Copyright © 2017, Texas Instruments Incorporated

Figure 32. HSDC Pro Configuration for PLL Mode

12. Click the **Create Tones** button and press **Send**.
13. The new lane rate (4.915 GHz) and FPGA Clock (122.88 MHz) settings should be shown.

14. Go back to the DAC38RFXX GUI and press the **Reset DAC JESD Core & SYSREF TRIGGER** button.
15. Connect channel one of the DAC38RF82EVM (J6) to a spectrum analyzer and verify the signal. **Figure 33** shows the analog output generated by the DAC38RF82EVM.

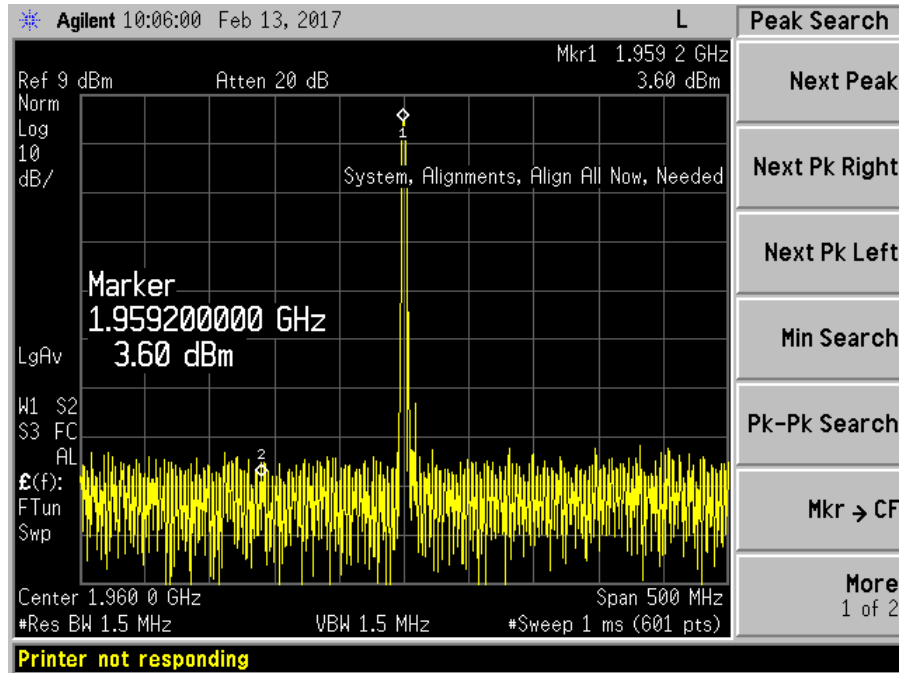

Copyright © 2017, Texas Instruments Incorporated

Figure 33. Analog Output From DAC38RF82EVM

8 Eyescan Analysis

One of the features of the KCU105 is the ability to receive data and measure the horizontal and vertical eye opening. This Eyescan feature is used as a diagnosis tool to debug the digital signals in each enabled lane. The latest version of HSDC Pro supports this feature and generates an eye diagram consisting of a bit error rate (BER) heat map.

The following section provides a quick start-up example that highlights the software features of the Eyescan analysis.

1. Verify that the ADC EVM provides a good FFT capture on HSDC Pro.
2. In HSDC Pro, under the *Instrument Options* tab, click on **SERDES Test Options**.
3. A new window should appear with the following features:
 - (a) *Lane* - Selects one of the lanes to analyze (the lane number is respective to the KCU105)
 - (b) *Horz Step* - Resolution of the horizontal scan (For optimal resolution, choose 4 or lower)
 - (c) *Vert Step* - Resolution of the vertical scan (For optimal resolution, choose 4 or lower)
 - (d) *Max Prescale* - The amount of time spent at each vertical and horizontal sample (A higher value will result in a finer BER)
 - (e) *LPM, DFE* - Specifies whether the transceiver is in LPM or DFE mode
 - (f) *Standard EyeQ* - Overlays one of the JESD204 receive eye-mask templates onto the Eye diagram
4. After configuring the parameters, click the **START** button. The scan may take a few seconds to a few minutes, depending on the parameters chosen.

Figure 34 shows an eye diagram of a 8224 mode ADC32RF45EVM sampling at 2 GHz with a lane rate of 10 GHz.

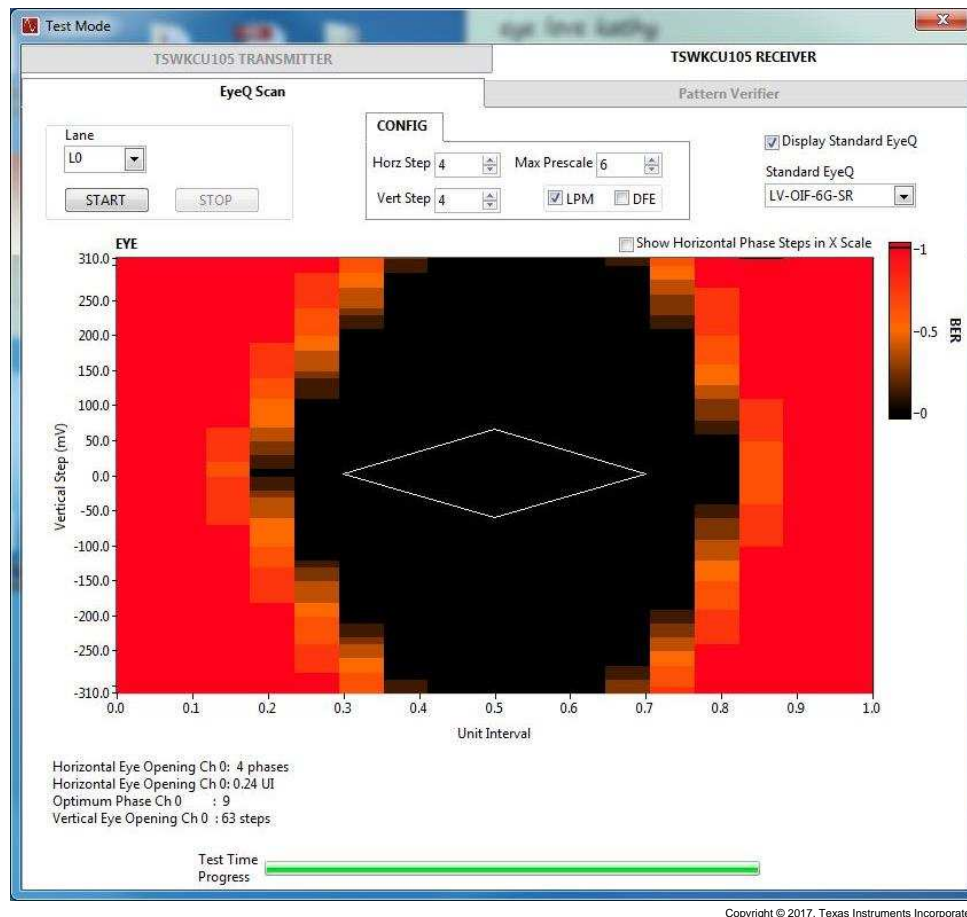

Figure 34. Eye Diagram Example Plot

STANDARD TERMS FOR EVALUATION MODULES

1. *Delivery:* TI delivers TI evaluation boards, kits, or modules, including any accompanying demonstration software, components, and/or documentation which may be provided together or separately (collectively, an "EVM" or "EVMs") to the User ("User") in accordance with the terms set forth herein. User's acceptance of the EVM is expressly subject to the following terms.
 - 1.1 EVMs are intended solely for product or software developers for use in a research and development setting to facilitate feasibility evaluation, experimentation, or scientific analysis of TI semiconductor products. EVMs have no direct function and are not finished products. EVMs shall not be directly or indirectly assembled as a part or subassembly in any finished product. For clarification, any software or software tools provided with the EVM ("Software") shall not be subject to the terms and conditions set forth herein but rather shall be subject to the applicable terms that accompany such Software
 - 1.2 EVMs are not intended for consumer or household use. EVMs may not be sold, sublicensed, leased, rented, loaned, assigned, or otherwise distributed for commercial purposes by Users, in whole or in part, or used in any finished product or production system.
2. *Limited Warranty and Related Remedies/Disclaimers:*
 - 2.1 These terms do not apply to Software. The warranty, if any, for Software is covered in the applicable Software License Agreement.
 - 2.2 TI warrants that the TI EVM will conform to TI's published specifications for ninety (90) days after the date TI delivers such EVM to User. Notwithstanding the foregoing, TI shall not be liable for a nonconforming EVM if (a) the nonconformity was caused by neglect, misuse or mistreatment by an entity other than TI, including improper installation or testing, or for any EVMs that have been altered or modified in any way by an entity other than TI, (b) the nonconformity resulted from User's design, specifications or instructions for such EVMs or improper system design, or (c) User has not paid on time. Testing and other quality control techniques are used to the extent TI deems necessary. TI does not test all parameters of each EVM. User's claims against TI under this Section 2 are void if User fails to notify TI of any apparent defects in the EVMs within ten (10) business days after delivery, or of any hidden defects with ten (10) business days after the defect has been detected.
 - 2.3 TI's sole liability shall be at its option to repair or replace EVMs that fail to conform to the warranty set forth above, or credit User's account for such EVM. TI's liability under this warranty shall be limited to EVMs that are returned during the warranty period to the address designated by TI and that are determined by TI not to conform to such warranty. If TI elects to repair or replace such EVM, TI shall have a reasonable time to repair such EVM or provide replacements. Repaired EVMs shall be warranted for the remainder of the original warranty period. Replaced EVMs shall be warranted for a new full ninety (90) day warranty period.
3. *Regulatory Notices:*
 - 3.1 *United States*
 - 3.1.1 *Notice applicable to EVMs not FCC-Approved:*

FCC NOTICE: This kit is designed to allow product developers to evaluate electronic components, circuitry, or software associated with the kit to determine whether to incorporate such items in a finished product and software developers to write software applications for use with the end product. This kit is not a finished product and when assembled may not be resold or otherwise marketed unless all required FCC equipment authorizations are first obtained. Operation is subject to the condition that this product not cause harmful interference to licensed radio stations and that this product accept harmful interference. Unless the assembled kit is designed to operate under part 15, part 18 or part 95 of this chapter, the operator of the kit must operate under the authority of an FCC license holder or must secure an experimental authorization under part 5 of this chapter.
 - 3.1.2 *For EVMs annotated as FCC – FEDERAL COMMUNICATIONS COMMISSION Part 15 Compliant:*

CAUTION

This device complies with part 15 of the FCC Rules. Operation is subject to the following two conditions: (1) This device may not cause harmful interference, and (2) this device must accept any interference received, including interference that may cause undesired operation.

Changes or modifications not expressly approved by the party responsible for compliance could void the user's authority to operate the equipment.

FCC Interference Statement for Class A EVM devices

NOTE: This equipment has been tested and found to comply with the limits for a Class A digital device, pursuant to part 15 of the FCC Rules. These limits are designed to provide reasonable protection against harmful interference when the equipment is operated in a commercial environment. This equipment generates, uses, and can radiate radio frequency energy and, if not installed and used in accordance with the instruction manual, may cause harmful interference to radio communications. Operation of this equipment in a residential area is likely to cause harmful interference in which case the user will be required to correct the interference at his own expense.

FCC Interference Statement for Class B EVM devices

NOTE: This equipment has been tested and found to comply with the limits for a Class B digital device, pursuant to part 15 of the FCC Rules. These limits are designed to provide reasonable protection against harmful interference in a residential installation. This equipment generates, uses and can radiate radio frequency energy and, if not installed and used in accordance with the instructions, may cause harmful interference to radio communications. However, there is no guarantee that interference will not occur in a particular installation. If this equipment does cause harmful interference to radio or television reception, which can be determined by turning the equipment off and on, the user is encouraged to try to correct the interference by one or more of the following measures:

- Reorient or relocate the receiving antenna.
- Increase the separation between the equipment and receiver.
- Connect the equipment into an outlet on a circuit different from that to which the receiver is connected.
- Consult the dealer or an experienced radio/TV technician for help.

3.2 Canada

3.2.1 For EVMs issued with an Industry Canada Certificate of Conformance to RSS-210 or RSS-247

Concerning EVMs Including Radio Transmitters:

This device complies with Industry Canada license-exempt RSSs. Operation is subject to the following two conditions:

(1) this device may not cause interference, and (2) this device must accept any interference, including interference that may cause undesired operation of the device.

Concernant les EVMs avec appareils radio:

Le présent appareil est conforme aux CNR d'Industrie Canada applicables aux appareils radio exempts de licence. L'exploitation est autorisée aux deux conditions suivantes: (1) l'appareil ne doit pas produire de brouillage, et (2) l'utilisateur de l'appareil doit accepter tout brouillage radioélectrique subi, même si le brouillage est susceptible d'en compromettre le fonctionnement.

Concerning EVMs Including Detachable Antennas:

Under Industry Canada regulations, this radio transmitter may only operate using an antenna of a type and maximum (or lesser) gain approved for the transmitter by Industry Canada. To reduce potential radio interference to other users, the antenna type and its gain should be so chosen that the equivalent isotropically radiated power (e.i.r.p.) is not more than that necessary for successful communication. This radio transmitter has been approved by Industry Canada to operate with the antenna types listed in the user guide with the maximum permissible gain and required antenna impedance for each antenna type indicated. Antenna types not included in this list, having a gain greater than the maximum gain indicated for that type, are strictly prohibited for use with this device.

Concernant les EVMs avec antennes détachables

Conformément à la réglementation d'Industrie Canada, le présent émetteur radio peut fonctionner avec une antenne d'un type et d'un gain maximal (ou inférieur) approuvé pour l'émetteur par Industrie Canada. Dans le but de réduire les risques de brouillage radioélectrique à l'intention des autres utilisateurs, il faut choisir le type d'antenne et son gain de sorte que la puissance isotrope rayonnée équivalente (p.i.r.e.) ne dépasse pas l'intensité nécessaire à l'établissement d'une communication satisfaisante. Le présent émetteur radio a été approuvé par Industrie Canada pour fonctionner avec les types d'antenne énumérés dans le manuel d'usage et ayant un gain admissible maximal et l'impédance requise pour chaque type d'antenne. Les types d'antenne non inclus dans cette liste, ou dont le gain est supérieur au gain maximal indiqué, sont strictement interdits pour l'exploitation de l'émetteur.

3.3 Japan

3.3.1 *Notice for EVMs delivered in Japan:* Please see http://www.tij.co.jp/lstds/ti_ja/general/eStore/notice_01.page 日本国内に輸入される評価用キット、ボードについては、次のところをご覧ください。
http://www.tij.co.jp/lstds/ti_ja/general/eStore/notice_01.page

3.3.2 *Notice for Users of EVMs Considered "Radio Frequency Products" in Japan:* EVMs entering Japan may not be certified by TI as conforming to Technical Regulations of Radio Law of Japan.

If User uses EVMs in Japan, not certified to Technical Regulations of Radio Law of Japan, User is required to follow the instructions set forth by Radio Law of Japan, which includes, but is not limited to, the instructions below with respect to EVMs (which for the avoidance of doubt are stated strictly for convenience and should be verified by User):

1. Use EVMs in a shielded room or any other test facility as defined in the notification #173 issued by Ministry of Internal Affairs and Communications on March 28, 2006, based on Sub-section 1.1 of Article 6 of the Ministry's Rule for Enforcement of Radio Law of Japan,
2. Use EVMs only after User obtains the license of Test Radio Station as provided in Radio Law of Japan with respect to EVMs, or
3. Use of EVMs only after User obtains the Technical Regulations Conformity Certification as provided in Radio Law of Japan with respect to EVMs. Also, do not transfer EVMs, unless User gives the same notice above to the transferee. Please note that if User does not follow the instructions above, User will be subject to penalties of Radio Law of Japan.

【無線電波を送信する製品の開発キットをお使いになる際の注意事項】 開発キットの中には技術基準適合証明を受けていないものがあります。技術適合証明を受けていないものご使用に際しては、電波法遵守のため、以下のいずれかの措置を取っていただく必要がありますのでご注意ください。

1. 電波法施行規則第6条第1項第1号に基づく平成18年3月28日総務省告示第173号で定められた電波暗室等の試験設備でご使用いただく。
2. 実験局の免許を取得後ご使用いただく。
3. 技術基準適合証明を取得後ご使用いただく。

なお、本製品は、上記の「ご使用にあたっての注意」を譲渡先、移転先に通知しない限り、譲渡、移転できないものとします。

上記を遵守頂けない場合は、電波法の罰則が適用される可能性があることをご留意ください。日本テキサス・インスツルメンツ株式会社
東京都新宿区西新宿 6 丁目 2 4 番 1 号
西新宿三井ビル

3.3.3 *Notice for EVMs for Power Line Communication:* Please see http://www.tij.co.jp/lstds/ti_ja/general/eStore/notice_02.page
電力線搬送波通信についての開発キットをお使いになる際の注意事項については、次のところをご覧ください。 http://www.tij.co.jp/lstds/ti_ja/general/eStore/notice_02.page

3.4 *European Union*

3.4.1 *For EVMs subject to EU Directive 2014/30/EU (Electromagnetic Compatibility Directive):*

This is a class A product intended for use in environments other than domestic environments that are connected to a low-voltage power-supply network that supplies buildings used for domestic purposes. In a domestic environment this product may cause radio interference in which case the user may be required to take adequate measures.

4 *EVM Use Restrictions and Warnings:*

4.1 EVMS ARE NOT FOR USE IN FUNCTIONAL SAFETY AND/OR SAFETY CRITICAL EVALUATIONS, INCLUDING BUT NOT LIMITED TO EVALUATIONS OF LIFE SUPPORT APPLICATIONS.

4.2 User must read and apply the user guide and other available documentation provided by TI regarding the EVM prior to handling or using the EVM, including without limitation any warning or restriction notices. The notices contain important safety information related to, for example, temperatures and voltages.

4.3 *Safety-Related Warnings and Restrictions:*

4.3.1 User shall operate the EVM within TI's recommended specifications and environmental considerations stated in the user guide, other available documentation provided by TI, and any other applicable requirements and employ reasonable and customary safeguards. Exceeding the specified performance ratings and specifications (including but not limited to input and output voltage, current, power, and environmental ranges) for the EVM may cause personal injury or death, or property damage. If there are questions concerning performance ratings and specifications, User should contact a TI field representative prior to connecting interface electronics including input power and intended loads. Any loads applied outside of the specified output range may also result in unintended and/or inaccurate operation and/or possible permanent damage to the EVM and/or interface electronics. Please consult the EVM user guide prior to connecting any load to the EVM output. If there is uncertainty as to the load specification, please contact a TI field representative. During normal operation, even with the inputs and outputs kept within the specified allowable ranges, some circuit components may have elevated case temperatures. These components include but are not limited to linear regulators, switching transistors, pass transistors, current sense resistors, and heat sinks, which can be identified using the information in the associated documentation. When working with the EVM, please be aware that the EVM may become very warm.

4.3.2 EVMs are intended solely for use by technically qualified, professional electronics experts who are familiar with the dangers and application risks associated with handling electrical mechanical components, systems, and subsystems. User assumes all responsibility and liability for proper and safe handling and use of the EVM by User or its employees, affiliates, contractors or designees. User assumes all responsibility and liability to ensure that any interfaces (electronic and/or mechanical) between the EVM and any human body are designed with suitable isolation and means to safely limit accessible leakage currents to minimize the risk of electrical shock hazard. User assumes all responsibility and liability for any improper or unsafe handling or use of the EVM by User or its employees, affiliates, contractors or designees.

4.4 User assumes all responsibility and liability to determine whether the EVM is subject to any applicable international, federal, state, or local laws and regulations related to User's handling and use of the EVM and, if applicable, User assumes all responsibility and liability for compliance in all respects with such laws and regulations. User assumes all responsibility and liability for proper disposal and recycling of the EVM consistent with all applicable international, federal, state, and local requirements.

5. *Accuracy of Information:* To the extent TI provides information on the availability and function of EVMs, TI attempts to be as accurate as possible. However, TI does not warrant the accuracy of EVM descriptions, EVM availability or other information on its websites as accurate, complete, reliable, current, or error-free.

6. *Disclaimers:*

6.1 EXCEPT AS SET FORTH ABOVE, EVMS AND ANY MATERIALS PROVIDED WITH THE EVM (INCLUDING, BUT NOT LIMITED TO, REFERENCE DESIGNS AND THE DESIGN OF THE EVM ITSELF) ARE PROVIDED "AS IS" AND "WITH ALL FAULTS." TI DISCLAIMS ALL OTHER WARRANTIES, EXPRESS OR IMPLIED, REGARDING SUCH ITEMS, INCLUDING BUT NOT LIMITED TO ANY EPIDEMIC FAILURE WARRANTY OR IMPLIED WARRANTIES OF MERCHANTABILITY OR FITNESS FOR A PARTICULAR PURPOSE OR NON-INFRINGEMENT OF ANY THIRD PARTY PATENTS, COPYRIGHTS, TRADE SECRETS OR OTHER INTELLECTUAL PROPERTY RIGHTS.

6.2 EXCEPT FOR THE LIMITED RIGHT TO USE THE EVM SET FORTH HEREIN, NOTHING IN THESE TERMS SHALL BE CONSTRUED AS GRANTING OR CONFERRING ANY RIGHTS BY LICENSE, PATENT, OR ANY OTHER INDUSTRIAL OR INTELLECTUAL PROPERTY RIGHT OF TI, ITS SUPPLIERS/LICENSORS OR ANY OTHER THIRD PARTY, TO USE THE EVM IN ANY FINISHED END-USER OR READY-TO-USE FINAL PRODUCT, OR FOR ANY INVENTION, DISCOVERY OR IMPROVEMENT, REGARDLESS OF WHEN MADE, CONCEIVED OR ACQUIRED.

7. *USER'S INDEMNITY OBLIGATIONS AND REPRESENTATIONS.* USER WILL DEFEND, INDEMNIFY AND HOLD TI, ITS LICENSORS AND THEIR REPRESENTATIVES HARMLESS FROM AND AGAINST ANY AND ALL CLAIMS, DAMAGES, LOSSES, EXPENSES, COSTS AND LIABILITIES (COLLECTIVELY, "CLAIMS") ARISING OUT OF OR IN CONNECTION WITH ANY HANDLING OR USE OF THE EVM THAT IS NOT IN ACCORDANCE WITH THESE TERMS. THIS OBLIGATION SHALL APPLY WHETHER CLAIMS ARISE UNDER STATUTE, REGULATION, OR THE LAW OF TORT, CONTRACT OR ANY OTHER LEGAL THEORY, AND EVEN IF THE EVM FAILS TO PERFORM AS DESCRIBED OR EXPECTED.

8. *Limitations on Damages and Liability:*

8.1 *General Limitations.* IN NO EVENT SHALL TI BE LIABLE FOR ANY SPECIAL, COLLATERAL, INDIRECT, PUNITIVE, INCIDENTAL, CONSEQUENTIAL, OR EXEMPLARY DAMAGES IN CONNECTION WITH OR ARISING OUT OF THESE TERMS OR THE USE OF THE EVMS, REGARDLESS OF WHETHER TI HAS BEEN ADVISED OF THE POSSIBILITY OF SUCH DAMAGES. EXCLUDED DAMAGES INCLUDE, BUT ARE NOT LIMITED TO, COST OF REMOVAL OR REINSTALLATION, ANCILLARY COSTS TO THE PROCUREMENT OF SUBSTITUTE GOODS OR SERVICES, RETESTING, OUTSIDE COMPUTER TIME, LABOR COSTS, LOSS OF GOODWILL, LOSS OF PROFITS, LOSS OF SAVINGS, LOSS OF USE, LOSS OF DATA, OR BUSINESS INTERRUPTION. NO CLAIM, SUIT OR ACTION SHALL BE BROUGHT AGAINST TI MORE THAN TWELVE (12) MONTHS AFTER THE EVENT THAT GAVE RISE TO THE CAUSE OF ACTION HAS OCCURRED.

8.2 *Specific Limitations.* IN NO EVENT SHALL TI'S AGGREGATE LIABILITY FROM ANY USE OF AN EVM PROVIDED HEREUNDER, INCLUDING FROM ANY WARRANTY, INDEMNITY OR OTHER OBLIGATION ARISING OUT OF OR IN CONNECTION WITH THESE TERMS, EXCEED THE TOTAL AMOUNT PAID TO TI BY USER FOR THE PARTICULAR EVM(S) AT ISSUE DURING THE PRIOR TWELVE (12) MONTHS WITH RESPECT TO WHICH LOSSES OR DAMAGES ARE CLAIMED. THE EXISTENCE OF MORE THAN ONE CLAIM SHALL NOT ENLARGE OR EXTEND THIS LIMIT.

9. *Return Policy.* Except as otherwise provided, TI does not offer any refunds, returns, or exchanges. Furthermore, no return of EVM(s) will be accepted if the package has been opened and no return of the EVM(s) will be accepted if they are damaged or otherwise not in a resalable condition. If User feels it has been incorrectly charged for the EVM(s) it ordered or that delivery violates the applicable order, User should contact TI. All refunds will be made in full within thirty (30) working days from the return of the components(s), excluding any postage or packaging costs.

10. *Governing Law:* These terms and conditions shall be governed by and interpreted in accordance with the laws of the State of Texas, without reference to conflict-of-laws principles. User agrees that non-exclusive jurisdiction for any dispute arising out of or relating to these terms and conditions lies within courts located in the State of Texas and consents to venue in Dallas County, Texas. Notwithstanding the foregoing, any judgment may be enforced in any United States or foreign court, and TI may seek injunctive relief in any United States or foreign court.

IMPORTANT NOTICE FOR TI DESIGN INFORMATION AND RESOURCES

Texas Instruments Incorporated ("TI") technical, application or other design advice, services or information, including, but not limited to, reference designs and materials relating to evaluation modules, (collectively, "TI Resources") are intended to assist designers who are developing applications that incorporate TI products; by downloading, accessing or using any particular TI Resource in any way, you (individually or, if you are acting on behalf of a company, your company) agree to use it solely for this purpose and subject to the terms of this Notice.

TI's provision of TI Resources does not expand or otherwise alter TI's applicable published warranties or warranty disclaimers for TI products, and no additional obligations or liabilities arise from TI providing such TI Resources. TI reserves the right to make corrections, enhancements, improvements and other changes to its TI Resources.

You understand and agree that you remain responsible for using your independent analysis, evaluation and judgment in designing your applications and that you have full and exclusive responsibility to assure the safety of your applications and compliance of your applications (and of all TI products used in or for your applications) with all applicable regulations, laws and other applicable requirements. You represent that, with respect to your applications, you have all the necessary expertise to create and implement safeguards that (1) anticipate dangerous consequences of failures, (2) monitor failures and their consequences, and (3) lessen the likelihood of failures that might cause harm and take appropriate actions. You agree that prior to using or distributing any applications that include TI products, you will thoroughly test such applications and the functionality of such TI products as used in such applications. TI has not conducted any testing other than that specifically described in the published documentation for a particular TI Resource.

You are authorized to use, copy and modify any individual TI Resource only in connection with the development of applications that include the TI product(s) identified in such TI Resource. NO OTHER LICENSE, EXPRESS OR IMPLIED, BY ESTOPPEL OR OTHERWISE TO ANY OTHER TI INTELLECTUAL PROPERTY RIGHT, AND NO LICENSE TO ANY TECHNOLOGY OR INTELLECTUAL PROPERTY RIGHT OF TI OR ANY THIRD PARTY IS GRANTED HEREIN, including but not limited to any patent right, copyright, mask work right, or other intellectual property right relating to any combination, machine, or process in which TI products or services are used. Information regarding or referencing third-party products or services does not constitute a license to use such products or services, or a warranty or endorsement thereof. Use of TI Resources may require a license from a third party under the patents or other intellectual property of the third party, or a license from TI under the patents or other intellectual property of TI.

TI RESOURCES ARE PROVIDED "AS IS" AND WITH ALL FAULTS. TI DISCLAIMS ALL OTHER WARRANTIES OR REPRESENTATIONS, EXPRESS OR IMPLIED, REGARDING TI RESOURCES OR USE THEREOF, INCLUDING BUT NOT LIMITED TO ACCURACY OR COMPLETENESS, TITLE, ANY EPIDEMIC FAILURE WARRANTY AND ANY IMPLIED WARRANTIES OF MERCHANTABILITY, FITNESS FOR A PARTICULAR PURPOSE, AND NON-INFRINGEMENT OF ANY THIRD PARTY INTELLECTUAL PROPERTY RIGHTS.

TI SHALL NOT BE LIABLE FOR AND SHALL NOT DEFEND OR INDEMNIFY YOU AGAINST ANY CLAIM, INCLUDING BUT NOT LIMITED TO ANY INFRINGEMENT CLAIM THAT RELATES TO OR IS BASED ON ANY COMBINATION OF PRODUCTS EVEN IF DESCRIBED IN TI RESOURCES OR OTHERWISE. IN NO EVENT SHALL TI BE LIABLE FOR ANY ACTUAL, DIRECT, SPECIAL, COLLATERAL, INDIRECT, PUNITIVE, INCIDENTAL, CONSEQUENTIAL OR EXEMPLARY DAMAGES IN CONNECTION WITH OR ARISING OUT OF TI RESOURCES OR USE THEREOF, AND REGARDLESS OF WHETHER TI HAS BEEN ADVISED OF THE POSSIBILITY OF SUCH DAMAGES.

You agree to fully indemnify TI and its representatives against any damages, costs, losses, and/or liabilities arising out of your non-compliance with the terms and provisions of this Notice.

This Notice applies to TI Resources. Additional terms apply to the use and purchase of certain types of materials, TI products and services. These include; without limitation, TI's standard terms for semiconductor products (<http://www.ti.com/sc/docs/stdterms.htm>), [evaluation modules](#), and [samples](http://www.ti.com/sc/docs/sampterm.htm) (<http://www.ti.com/sc/docs/sampterm.htm>).

Mailing Address: Texas Instruments, Post Office Box 655303, Dallas, Texas 75265
Copyright © 2017, Texas Instruments Incorporated