



ABSTRACT

This report covers the radiation characterization results of the SN54SC8T541-SEP, radiation tolerant octal buffers and line drivers with 3-state outputs and logic level shifter. The study was done to determine Total Ionizing Dose (TID) effects under high dose rate (HDR) up to 50krad(Si) as a one time characterization. The results show that all samples passed within the specified limits up to 30krad(Si) (with 72 hour room temperature anneal). Radiation Lot Acceptance Testing (RLAT) is performed using 5 units at a dose level of 30krad(Si) for future wafer lots per MIL-STD-883 TM 1019. All future wafer lots are tested under the same conditions. The device is manufactured in pure CMOS process. HDR TID response is the worst case. TID HDR characterization was performed per TM 1019.

The SN54SC8T541-SEP is packaged in a space enhanced plastic package for low outgassing characteristics and is Single Event Latch-Up (SEL) immune up to 50MeV-cm²/mg, which makes the device an option for low Earth orbit space applications. Single Event Transient (SET) data is also provided in the Single Event Effects Radiation Report.

The SN54SC8T541-SEP Total Ionizing Dose (TID) Report covers the TID performance of all devices listed below. The SN54SC8T541-SEP device covers all functional blocks and active die area of the other devices, which is why the device was selected for single-event effect testing for this group of devices.

- **SN54SC8T541-SEP**
- SN54SC8T240-SEP
- SN54SC8T244-SEP
- SN54SC8T9541-SEP

Table of Contents

1 Device Information	2
1.1 Device Details.....	2
2 Total Dose Test Setup	3
2.1 Test Overview.....	3
2.2 Test Description and Facilities.....	3
2.3 Test Setup Details.....	3
2.4 Test Configuration and Condition.....	4
3 TID Characterization Test Results	5
3.1 TID Characterization Summary Results.....	5
3.2 Specification Compliance Matrix.....	6
4 Reference Documents	7
5 Appendix: HDR TID Report Data	7

List of Figures

Figure 2-1. SN54SC8T541-SEP Bias Diagram.....	3
-----------------------------------------------	---

List of Tables

Table 1-1. Device and Exposure Details.....	2
Table 2-1. HDR Device Information.....	4
Table 3-1. Electrical Parameters Table.....	6

Trademarks

All trademarks are the property of their respective owners.

1 Device Information

The SN54SC8T541-SEP contains eight buffers with 3-state outputs. The active low output enable pins ($\overline{OE1}$ and $\overline{OE2}$) control all eight channels, and are configured so that both must be low for the outputs to be active. When the outputs are enabled, the outputs are actively driven low or high. When the outputs are disabled, the outputs are set into the high-impedance state. The output level is referenced to the supply voltage (V_{CC}) and supports 1.8V, 2.5V, 3.3V, and 5V CMOS levels.

The input is designed with a lower threshold circuit to support up translation for lower voltage CMOS inputs (for example, 1.2V input to 1.8V output or 1.8V input to 3.3V output). In addition, the 5V tolerant input pins enable down translation (for example, 3.3V to 2.5V output).

1.1 Device Details

[Table 1-1](#) lists the device information used for TID HDR characterization and qualification.

Table 1-1. Device and Exposure Details

TID HDR Details: Up To 50krad(Si)	
TI Device Number	SN54SC8T541-SEP
VID Number	V62/25632
Package	20-pin PW (TSSOP)
Technology	LBC9
Die Lot Number	3272254RFB
A/T Lot Number and Date Code	4165152ML4 / 42AYQFK
Quantity Tested	21 irradiated devices + 4 control
Lot Accept or Reject	Devices passed 30krad(Si)
HDR Radiation Facility	Texas Instruments CLAB in Dallas, Texas
HDR Dose Level	10krad(Si), 20krad(Si), 30krad(Si), 50krad(Si)
HDR Dose Rate	174.97rad(Si)/s ionizing radiation
Effective Dose Rate 30krad(Si) with 72 hour Anneal	115.74mrad(Si)/s ionizing radiation
HDR Radiation Source	Gammacell 220 Excel (GC-220E) Co-60
Irradiation Temperature	Ambient, room temperature

2 Total Dose Test Setup

2.1 Test Overview

The SN54SC8T541-SEP samples were irradiated at a high dose rate of 174.97rad(Si)/s up to 50krad(Si) (115.74mrad(Si)/s effective does rate for 30krad(Si) with 72 hour anneal) and then put through full electrical parametric testing on the production Automated Test Equipment (ATE). The samples were functional and passed all electrical parametric tests with readings within data sheet electrical specification limits.

2.2 Test Description and Facilities

The SN54SC8T541-SEP HDR exposure was performed on biased devices in a Co-60 gamma cell at TI facility in Dallas, Texas. The un-attenuated dose rate of this cell is 174.97rads(Si)/s (115.74mrad(Si)/s effective does rate of 30krad(Si) with 72 hour anneal). After exposure, the devices were packed in dry ice (per MIL-STD-883 Method 1019.9 section 3.10) and full post radiation electrical evaluation using Texas Instruments ATE was conducted. ATE test limits are set per data sheet electrical limits based on qualification and characterization data. Post radiation measurements were taken within 30 minutes of removing the devices from the dry ice container. The devices were allowed to reach room temperature prior to electrical post radiation measurements.

2.3 Test Setup Details

The devices were tested in biased conditions as described in the following sections.

2.3.1 Bias Diagram

Figure 2-1 shows the bias conditions for each pin during irradiation.

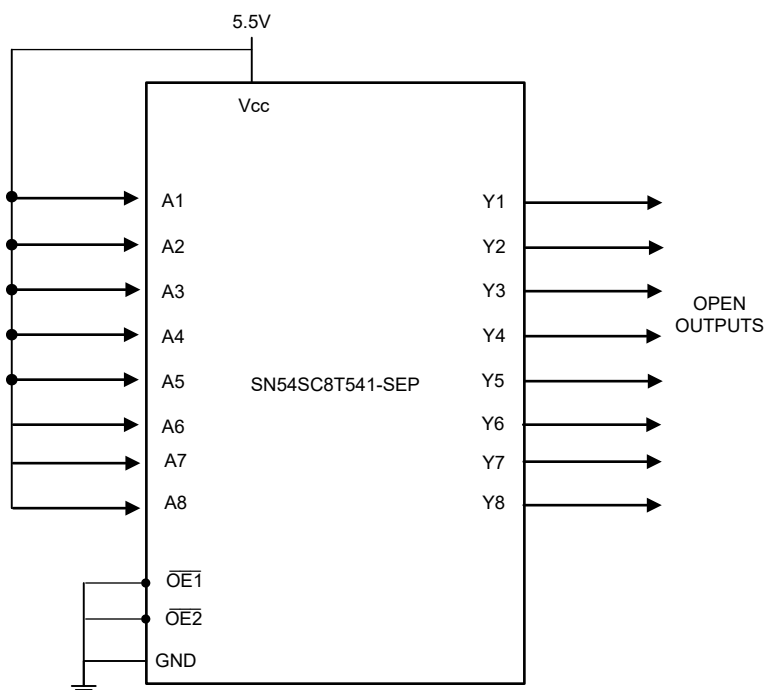

Figure 2-1. SN54SC8T541-SEP Bias Diagram

2.4 Test Configuration and Condition

A step stress (10k, 20k, 30k and 50k) test method was used to determine the TID hardness level. That is, after a predetermined TID level was reached, an electrical test was performed on a given sample of parts to verify that the units are within specified data sheet electrical test limits. The HDR RLAT units were irradiated to 30krad(Si), parametrically tested on ATE, and then were annealed at 25°C for 72 hours. The units that were irradiated to 30krad(Si) and were annealed for 72 hours are denoted as 31krad(Si) in [Section 5](#). ATE parametric testing was completed before and after the anneal.

[Table 2-1](#) lists the serialized samples used for TID characterization.

Table 2-1. HDR Device Information

Control Group	HDR Dose Rate = 174.97rad(Si)/s Effective Dose Rate (30krad + Anneal 72 hours) = 115.74mrad(Si)/s				
	Total Samples: 21 Biased				
Total Samples: 4	Exposure Levels				
0krad (Si)	10krad (Si)	20krad(Si)	30krad(Si)		50krad (Si)
Biased	Biased	Biased	Biased	Biased + 72 hour anneal	Biased
1 - 4	5 - 9	10 - 14	15 - 20	15a - 20a	21 - 25

3 TID Characterization Test Results

3.1 TID Characterization Summary Results

The parametric data for the SN54SC8T541-SEP passes up to 30krad(Si) (with 72 hour room temperature anneal) HDR TID irradiation. The drifts of the electrical parameters through HDR were within the data sheet limits.

Overall, the SN54SC8T541-SEP showed a strong degree of hardness to HDR TID irradiation up to 30krad(Si). The measurements taken post-irradiation for each sample set showed a marginal shift for most parameters at each dose level. The parameters that did show a greater degree of change between pre- and post-irradiation were still within the electrical performance characteristics specified in the data sheet electrical parameters. For the data sheet electrical parameters and associated tests, see [SN54SC8T541-SEP Radiation-Tolerant, Octal Buffers and Line Drivers With 3-State Outputs and Logic Level Shifter](#).

See [Section 5](#) for HDR report up to 50 krad(Si).

3.2 Specification Compliance Matrix

Table 3-1. Electrical Parameters Table

Parameter	Test Conditions	V _{CC}	T _A = -55°C to +125°C			Unit	Test Name
			MIN	TYP	MAX		
V _{T+} 1	Positive-going input threshold voltage	1.2V to 1.3V	0.31	0.655	1.1	V	VTP_1P2V
		1.65V to 2V	0.39	0.915	1.32		VTP_1P65V
		2.25V to 2.75V	0.51	1.09	1.51		VTP_2P25V
		3V to 3.6V	0.65	1.2	1.7		VTP_3V
		4.5V to 5.5V	0.87	1.51	2.16		VTP_4P5V, VTP_5P5V
V _{T-} 1	Negative-going input threshold voltage	1.2V to 1.3V	0.11	0.349	0.60	V	VTN_1P2V
		1.65V to 2V	0.18	0.455	0.63		VTN_1P65V
		2.25V to 2.75V	0.25	0.545	0.74		VTN_2P25V
		3V to 3.6V	0.33	0.635	0.85		VTN_3V
		4.5V to 5.5V	0.45	0.755	1.14		VTN_4P5V, VTN_5P5V
ΔV _T 1	Hysteresis (V _{T+} - V _{T-})	1.2V to 1.3V	0.2	0.29	0.77	V	DELTAVT_1P2V
		1.65V to 2V	0.21	0.43	0.88		DELTAVT_1P65V
		2.25V to 2.75V	0.25	0.54	0.91		DELTAVT_2P25V
		3V to 3.6V	0.31	0.63	0.91		DELTAVT_3V
		4.5V to 5.5V	0.43	0.75	1.05		DELTAVT_4P5V, DELTAVT_5P5V
V _{IH}	High-level input voltage	1.2V to 1.3V	0.78			V	VIH_1P2V
		1.65V to 2V	1.1				VIH_1P65V
		2.25V to 2.75V	1.28				VIH_2P25V
		3V to 3.6V	1.45				VIH_3V
		4.5V to 5.5V	2				VIH_4P5V, VIH_5P5V
V _{IL}	Low-Level input voltage	1.2V to 1.3V			0.18	V	VIL_1P2V
		1.65V to 2V			0.5		VIL_1P65V
		2.25V to 2.75V			0.65		VIL_2P25V
		3V to 3.6V			0.75		VIL_3V
		4.5V to 5.5V			0.85		VIL_4P5V, VIL_5P5V
V _{OH} 2	I _{OH} = -50μA	1.2V to 5.5V	V _{CC} -0.2			V	VOH_N50UA_1P2V, VOH_N50UA_5P5V
	I _{OH} = -1mA	1.2V	0.8				VOH_N1MA_1P2V
	I _{OH} = -2mA	1.65V to 2V	1.21				VOH_N2MA_1P65V
	I _{OH} = -3mA	2.25V to 2.75V	1.93				VOH_N3MA_2P25V
	I _{OH} = -5.5mA	3V to 3.6V	2.49				VOH_N5P5MA_3V
	I _{OH} = -8mA	4.5V to 5.5V	3.95				VOH_N8MA_4P5V
	I _{OH} = -24mA	4.5V to 5.5V	3.15				VOH_N24MA_5P5V
V _{OL}	I _{OL} = 50μA	1.2V to 5.5V			0.1	V	VOL_50UA_1P2V, VOL_50UA_5P5V
	I _{OL} = 1mA	1.2V			0.2		VOL_1MA_1P2V
	I _{OL} = 2mA	1.65V to 2V			0.25		VOL_2MA_1P65V
	I _{OL} = 3mA	2.25V to 2.75V			0.2		VOL_3MA_2P25V
	I _{OL} = 5.5mA	3V to 3.6V			0.25		VOL_5P5MA_3V
	I _{OL} = 8mA	4.5V to 5.5V			0.35		VOL_8MA_4P5V
	I _{OL} = 24mA	4.5V to 5.5V			0.75		VOL_24MA_5P5V
I _{CC}	V _I = V _{CC} or GND, I _O = 0	1.2V to 5.5V		2	220	μA	ICC_5P5V
ΔI _{CC}	One input at 0.3V or 3.4V, other inputs at V _{CC} or GND	5.5V			1.5	mA	DELTAICC_5P5V
	One input at 0.3V or 1.1V, other inputs at V _{CC} or GND	1.8V			68	μA	DELTAICC_1P8V
I _{OZ} 3	V _O = V _{CC} or GND	5.5V			±26	μA	IOZ_5P5V
I _I	V _I = 0V to V _{CC}	V _I = 0V to V _{CC}			±1	μA	II_5P5V

- Schmitt-trigger input devices only.
- Push-pull output devices only.
- 3-State output devices only.

4 Reference Documents

Texas Instruments total ionizing dose radiation (total dose) test procedure follows the standards put forth in MIL-STD-883 TM 1019. The document can be found at the DLA website.

5 Appendix: HDR TID Report Data

This appendix provides the SN54SC8T541-SEP TID HDR report. The report shows the variation for each parameter up to 50krad(Si).

TID Report

SN54SC8T541-SEP

		DELTAICC_1P8V				
Units		µA				
Max Limit		68				
Min Limit		-1				
krad	Serial #	PreTestHDR	PostTestHDR	Delta	Delta %	% of Limit Range
0	1	2.779	2.911	0.13	4.75%	0.19%
0	2	2.811	3.161	0.35	12.45%	0.51%
0	3	2.498	2.817	0.32	12.77%	0.46%
0	4	2.935	2.911	-0.02	-0.82%	0.03%
10	5	3.154	2.629	-0.53	-16.65%	0.76%
10	6	3.029	3.005	-0.02	-0.79%	0.03%
10	7	3.341	3.192	-0.15	-4.46%	0.22%
10	8	2.935	2.723	-0.21	-7.22%	0.31%
10	9	2.654	2.879	0.23	8.48%	0.33%
20	10	2.686	2.817	0.13	4.88%	0.19%
20	11	2.842	2.723	-0.12	-4.19%	0.17%
20	12	2.998	2.911	-0.09	-2.90%	0.13%
20	13	2.654	2.692	0.04	1.43%	0.06%
20	14	3.092	2.598	-0.49	-15.98%	0.72%
30	15	3.248	3.411	0.16	5.02%	0.24%
30	16	3.216	3.067	-0.15	-4.63%	0.22%
30	17	3.216	2.785	-0.43	-13.40%	0.62%
30	18	2.623	2.942	0.32	12.16%	0.46%
30	19	3.185	2.879	-0.31	-9.61%	0.44%
30	20	2.748	3.036	0.29	10.48%	0.42%
31	15a	3.248	2.472	-0.78	-23.89%	1.12%
31	16a	3.216	2.817	-0.40	-12.41%	0.58%
31	17a	3.216	2.472	-0.74	-23.13%	1.08%
31	18a	2.623	2.879	0.26	9.76%	0.37%
31	19a	3.185	2.660	-0.53	-16.48%	0.76%
31	20a	2.748	2.535	-0.21	-7.75%	0.31%
50	21	3.123	4.507	1.38	44.32%	2.01%
50	22	2.904	4.006	1.10	37.95%	1.60%
50	23	3.060	3.850	0.79	25.82%	1.14%
50	24	2.811	4.131	1.32	46.96%	1.91%
50	25	3.060	4.475	1.42	46.24%	2.05%
Max		3.341	4.507	1.17	46.96%	2.01%
Average		2.959	3.014	0.05	2.43%	0.58%
Min		2.498	2.472	-0.03	-23.89%	0.03%
Std Dev		0.239	0.497	0.26	18.03%	0.53%

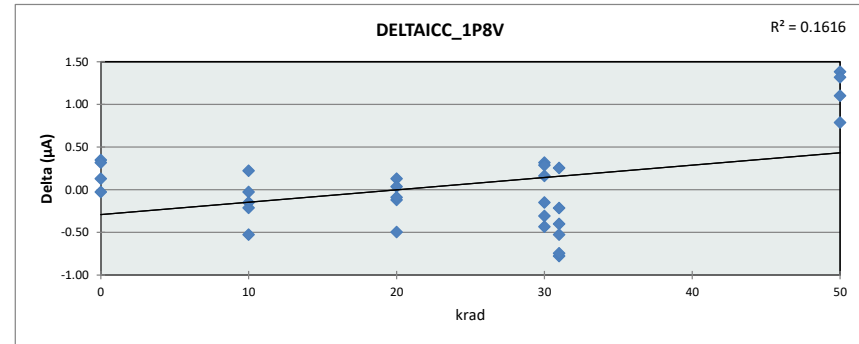

		DELTAICC_1P8V					
Units		µA					
Max Limit		68					
Min Limit		-1					
krad		0	10	20	30	31	50
LL		-1.000	-1.000	-1.000	-1.000	-1.000	-1.000
Min		2.817	2.629	2.598	2.785	2.472	3.850
Average		2.950	2.886	2.748	3.020	2.639	4.194
Max		3.161	3.192	2.911	3.411	2.879	4.507
UL		68.000	68.000	68.000	68.000	68.000	68.000

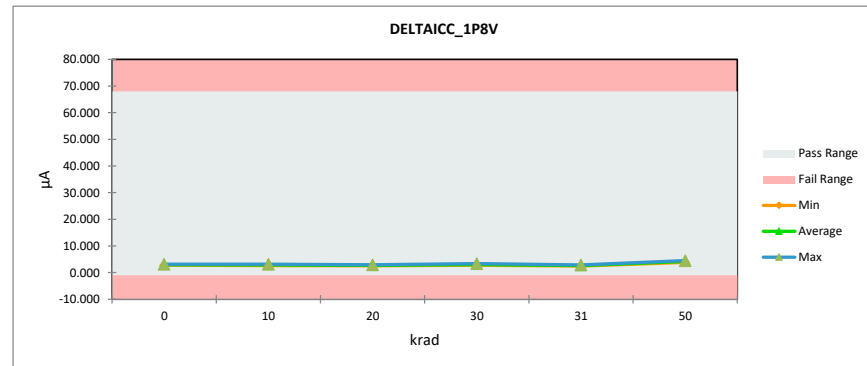

TID Report

SN54SC8T541-SEP

DELTAICC_5P5V						
Units	µA					
Max Limit	1500					
Min Limit	-1					
krad	Serial #	PreTestHDR	PostTestHDR	Delta	Delta %	% of Limit Range
0	1	91.280	90.820	-0.46	-0.50%	0.03%
0	2	91.750	91.950	0.20	0.22%	0.01%
0	3	91.190	91.920	0.73	0.80%	0.05%
0	4	91.470	91.640	0.17	0.19%	0.01%
10	5	90.720	89.600	-1.12	-1.23%	0.07%
10	6	90.970	90.760	-0.21	-0.23%	0.01%
10	7	91.120	90.260	-0.86	-0.94%	0.06%
10	8	90.780	89.790	-0.99	-1.09%	0.07%
10	9	91.000	90.260	-0.74	-0.81%	0.05%
20	10	90.970	89.890	-1.08	-1.19%	0.07%
20	11	90.970	89.980	-0.99	-1.09%	0.07%
20	12	90.720	89.380	-1.34	-1.48%	0.09%
20	13	90.780	88.950	-1.83	-2.02%	0.12%
20	14	90.690	89.420	-1.27	-1.40%	0.08%
30	15	90.340	90.420	0.08	0.09%	0.01%
30	16	91.870	89.980	-1.89	-2.06%	0.13%
30	17	90.530	89.950	-0.58	-0.64%	0.04%
30	18	90.900	90.700	-0.20	-0.22%	0.01%
30	19	90.940	89.790	-1.15	-1.26%	0.08%
30	20	90.310	90.420	0.11	0.12%	0.01%
31	15a	90.340	89.730	-0.61	-0.68%	0.04%
31	16a	91.870	89.980	-1.89	-2.06%	0.13%
31	17a	90.530	88.950	-1.58	-1.75%	0.11%
31	18a	90.900	89.480	-1.42	-1.56%	0.09%
31	19a	90.940	89.350	-1.59	-1.75%	0.11%
31	20a	90.310	89.290	-1.02	-1.13%	0.07%
50	21	91.250	92.390	1.14	1.25%	0.08%
50	22	91.090	92.300	1.21	1.33%	0.08%
50	23	90.690	92.080	1.39	1.53%	0.09%
50	24	90.690	91.580	0.89	0.98%	0.06%
50	25	91.090	91.700	0.61	0.67%	0.04%
Max		91.870	92.390	0.52	1.53%	0.13%
Average		90.930	90.367	-0.56	-0.62%	0.06%
Min		90.310	88.950	-1.36	-2.06%	0.01%
Std Dev		0.423	1.028	0.61	1.05%	0.04%

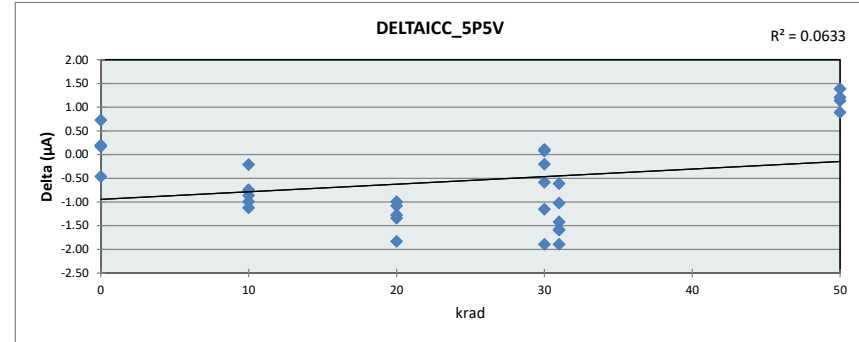

DELTAICC_5P5V						
Units	µA					
Max Limit	1500					
Min Limit	-1					
krad	0	10	20	30	31	50
LL	-1.000	-1.000	-1.000	-1.000	-1.000	-1.000
Min	90.820	89.600	88.950	89.790	88.950	91.580
Average	91.583	90.134	89.524	90.210	89.463	92.010
Max	91.950	90.760	89.980	90.700	89.980	92.390
UL	1500.000	1500.000	1500.000	1500.000	1500.000	1500.000

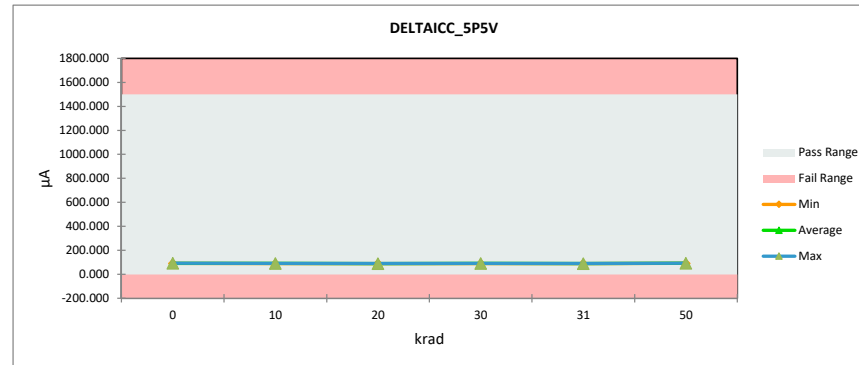

TID Report SN54SC8T541-SEP

		ICC				
Units		μA				
Max Limit		220				
Min Limit		-0.1				
krad	Serial #	PreTestHDR	PostTestHDR	Delta	Delta %	% of Limit Range
0	1	0.052	0.037	-0.02	-28.99%	0.01%
0	2	0.057	0.026	-0.03	-54.11%	0.01%
0	3	0.047	0.159	0.11	238.29%	0.05%
0	4	0.065	0.163	0.10	151.51%	0.04%
10	5	0.070	0.077	0.01	10.25%	0.00%
10	6	0.065	0.194	0.13	199.26%	0.06%
10	7	0.065	0.105	0.04	61.64%	0.02%
10	8	0.049	0.112	0.06	128.85%	0.03%
10	9	0.064	0.053	-0.01	-16.91%	0.00%
20	10	0.055	28.330	28.28	51493.52%	12.85%
20	11	0.055	30.540	30.48	55206.05%	13.85%
20	12	0.053	31.800	31.75	59517.55%	14.42%
20	13	0.051	30.910	30.86	59977.75%	14.02%
20	14	0.056	26.740	26.68	47244.19%	12.12%
30	15	0.059	432.600	432.54	729287.96%	196.52%
30	16	0.066	473.300	473.23	721503.90%	215.01%
30	17	0.070	455.200	455.13	650278.63%	206.78%
30	18	0.065	486.700	486.64	749130.30%	221.10%
30	19	0.053	372.900	372.85	703219.50%	169.40%
30	20	0.064	426.200	426.14	665629.46%	193.61%
31	15a	0.059	27.920	27.86	46974.69%	12.66%
31	16a	0.066	33.800	33.73	51432.25%	15.33%
31	17a	0.070	32.150	32.08	45835.13%	14.58%
31	18a	0.065	33.300	33.24	51162.32%	15.10%
31	19a	0.053	28.550	28.50	53747.60%	12.95%
31	20a	0.064	32.210	32.15	50212.40%	14.61%
50	21	0.058	3161.000	3160.94	5416281.08%	1436.14%
50	22	0.057	3318.000	3317.94	5778374.40%	1507.47%
50	23	0.057	3340.000	3339.94	5848262.81%	1517.47%
50	24	0.053	3400.000	3399.95	6412574.46%	1544.73%
50	25	0.064	3355.000	3354.94	5266775.98%	1524.28%
	Max	0.070	3400.000	3399.93	6412574.46%	1544.73%
	Average	0.059	540.103	540.04	941601.19%	245.36%
	Min	0.047	0.026	-0.02	-54.11%	0.00%
	Std Dev	0.006	1116.515	1116.51	1986634.09%	507.28%

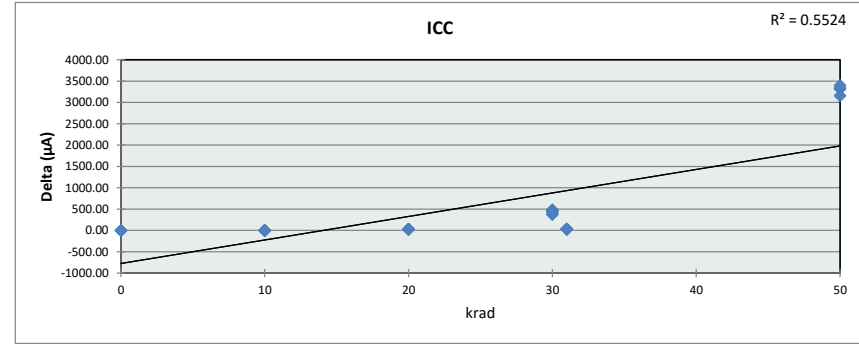

		ICC					
Units		μA					
Max Limit		220					
Min Limit		-0.1					
krad		0	10	20	30	31	50
LL		-0.100	-0.100	-0.100	-0.100	-0.100	-0.100
Min		0.026	0.053	26.740	372.900	27.920	3161.000
Average		0.096	0.108	29.664	441.150	31.322	3314.800
Max		0.163	0.194	31.800	486.700	33.800	3400.000
UL		220.000	220.000	220.000	220.000	220.000	220.000

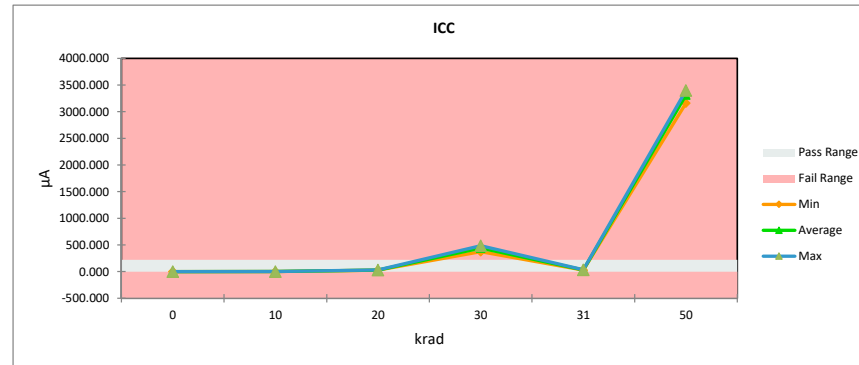

TID Report

SN54SC8T541-SEP

		II_5P5V				
Units		μA				
Max Limit		1				
Min Limit		-1				
krad	Serial #	PreTestHDR	PostTestHDR	Delta	Delta %	% of Limit Range
0	1	0.007	0.007	0.00	5.71%	0.02%
0	2	0.007	0.021	0.01	182.19%	0.68%
0	3	0.005	0.014	0.01	193.64%	0.46%
0	4	0.008	0.029	0.02	258.87%	1.04%
10	5	0.006	0.022	0.02	254.90%	0.79%
10	6	0.005	0.063	0.06	1215.59%	2.90%
10	7	0.005	0.015	0.01	177.70%	0.46%
10	8	0.006	0.005	0.00	-5.72%	0.02%
10	9	0.007	0.007	0.00	-7.42%	0.03%
20	10	0.004	0.015	0.01	322.82%	0.59%
20	11	0.006	0.009	0.00	53.78%	0.16%
20	12	0.007	0.008	0.00	18.56%	0.06%
20	13	0.005	0.006	0.00	34.72%	0.08%
20	14	0.005	0.007	0.00	54.44%	0.13%
30	15	0.005	0.004	0.00	-6.42%	0.01%
30	16	0.005	0.005	0.00	8.41%	0.02%
30	17	0.005	0.019	0.01	258.42%	0.70%
30	18	0.006	0.006	0.00	4.61%	0.01%
30	19	0.010	0.009	0.00	-14.17%	0.07%
30	20	0.008	0.005	0.00	-31.53%	0.12%
31	15a	0.005	0.008	0.00	75.27%	0.17%
31	16a	0.005	0.007	0.00	41.29%	0.10%
31	17a	0.005	0.009	0.00	59.72%	0.16%
31	18a	0.006	0.007	0.00	26.07%	0.08%
31	19a	0.010	0.007	0.00	-35.23%	0.18%
31	20a	0.008	0.006	0.00	-16.19%	0.06%
50	21	0.006	0.006	0.00	-1.79%	0.01%
50	22	0.004	0.003	0.00	-11.05%	0.02%
50	23	0.004	0.011	0.01	146.85%	0.31%
50	24	0.006	0.027	0.02	324.00%	1.03%
50	25	0.007	0.009	0.00	27.74%	0.10%
	Max	0.010	0.063	0.05	1215.59%	2.90%
	Average	0.006	0.012	0.01	119.60%	0.35%
	Min	0.004	0.003	0.00	-35.23%	0.01%
	Std Dev	0.002	0.012	0.01	235.07%	0.57%

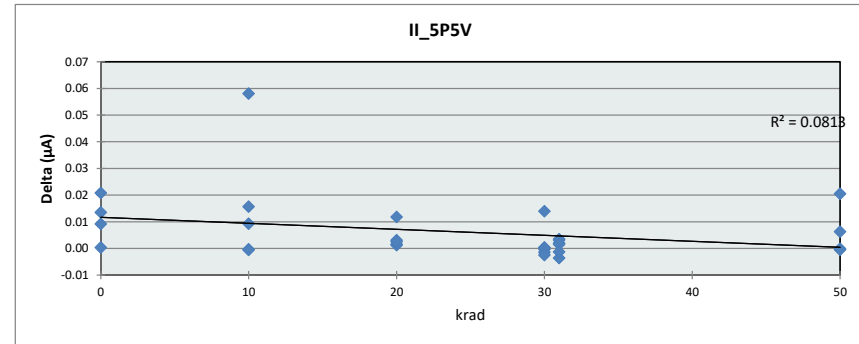

		II_5P5V					
Units		μA					
Max Limit		1					
Min Limit		-1					
krad		0	10	20	30	31	50
LL		-1.000	-1.000	-1.000	-1.000	-1.000	-1.000
Min		0.007	0.005	0.006	0.004	0.006	0.003
Average		0.018	0.022	0.009	0.008	0.007	0.011
Max		0.029	0.063	0.015	0.019	0.009	0.027
UL		1.000	1.000	1.000	1.000	1.000	1.000

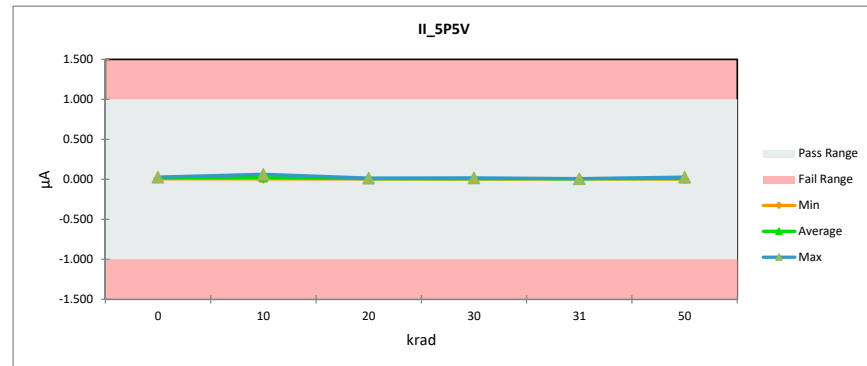

TID Report

SN54SC8T541-SEP

		IOZ_5P5V				
Units		µA				
Max Limit		26				
Min Limit		-26				
krad	Serial #	PreTestHDR	PostTestHDR	Delta	Delta %	% of Limit Range
0	1	0.014	0.011	0.00	-17.41%	0.00%
0	2	0.013	0.009	0.00	-35.34%	0.01%
0	3	0.012	0.166	0.15	1278.22%	0.30%
0	4	0.046	0.035	-0.01	-24.42%	0.02%
10	5	0.024	0.009	-0.01	-60.91%	0.03%
10	6	0.025	0.025	0.00	-2.19%	0.00%
10	7	0.018	0.012	-0.01	-34.00%	0.01%
10	8	0.018	0.014	0.00	-24.66%	0.01%
10	9	0.031	0.009	-0.02	-70.79%	0.04%
20	10	0.019	0.008	-0.01	-55.36%	0.02%
20	11	0.017	0.008	-0.01	-53.55%	0.02%
20	12	0.018	0.010	-0.01	-42.15%	0.01%
20	13	0.018	0.008	-0.01	-52.52%	0.02%
20	14	0.017	0.012	0.00	-28.51%	0.01%
30	15	0.019	0.016	0.00	-12.80%	0.00%
30	16	0.018	0.008	-0.01	-57.31%	0.02%
30	17	0.019	0.010	-0.01	-47.18%	0.02%
30	18	0.018	0.016	0.00	-11.09%	0.00%
30	19	0.018	0.005	-0.01	-73.88%	0.03%
30	20	0.017	0.015	0.00	-10.23%	0.00%
31	15a	0.019	0.008	-0.01	-55.79%	0.02%
31	16a	0.018	0.008	-0.01	-57.15%	0.02%
31	17a	0.019	0.008	-0.01	-59.42%	0.02%
31	18a	0.018	0.009	-0.01	-49.86%	0.02%
31	19a	0.018	0.008	-0.01	-57.94%	0.02%
31	20a	0.017	0.009	-0.01	-44.54%	0.01%
50	21	0.018	0.017	0.00	-3.30%	0.00%
50	22	0.017	0.003	-0.01	-81.72%	0.03%
50	23	0.018	0.007	-0.01	-62.66%	0.02%
50	24	0.018	0.008	-0.01	-54.20%	0.02%
50	25	0.017	0.011	-0.01	-38.24%	0.01%
Max		0.046	0.166	0.12	1278.22%	0.30%
Average		0.019	0.016	0.00	1.24%	0.03%
Min		0.012	0.003	-0.01	-81.72%	0.00%
Std Dev		0.006	0.029	0.02	242.14%	0.05%

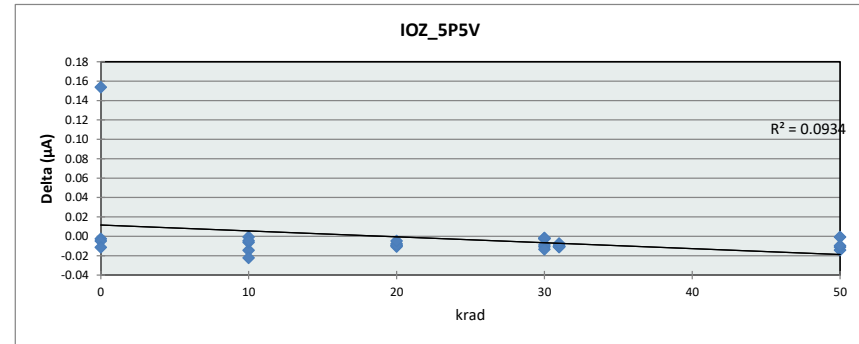

		IOZ_5P5V					
Units		µA					
Max Limit		26					
Min Limit		-26					
krad	0	10	20	30	31	50	
LL	-26.000	-26.000	-26.000	-26.000	-26.000	-26.000	
Min	0.009	0.009	0.008	0.005	0.008	0.003	
Average	0.055	0.014	0.009	0.012	0.008	0.009	
Max	0.166	0.025	0.012	0.016	0.009	0.017	
UL	26.000	26.000	26.000	26.000	26.000	26.000	

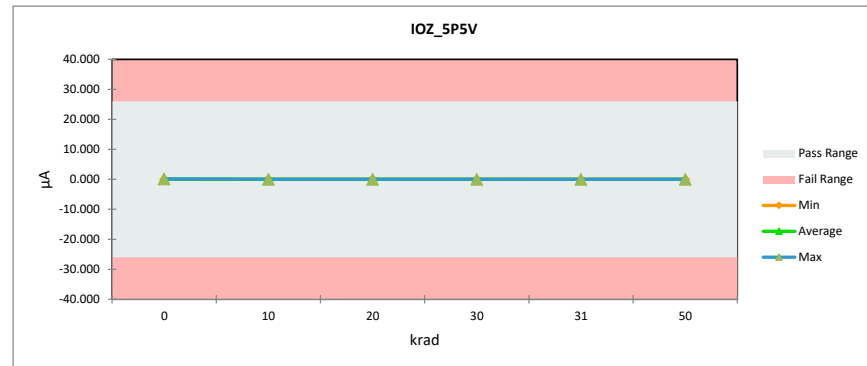

TID Report

SN54SC8T541-SEP

		VIH_1P2V				
Units		V				
Max Limit		0.78				
Min Limit		0.18				
krad	Serial #	PreTestHDR	PostTestHDR	Delta	Delta %	% of Limit Range
0	1	0.545	0.545	0.00	-0.11%	0.10%
0	2	0.546	0.546	0.00	0.00%	0.00%
0	3	0.541	0.542	0.00	0.11%	0.10%
0	4	0.546	0.547	0.00	0.22%	0.20%
10	5	0.540	0.534	-0.01	-1.12%	1.01%
10	6	0.542	0.536	-0.01	-1.12%	1.01%
10	7	0.540	0.534	-0.01	-1.12%	1.01%
10	8	0.541	0.535	-0.01	-1.12%	1.01%
10	9	0.539	0.533	-0.01	-1.12%	1.01%
20	10	0.543	0.471	-0.07	-13.19%	11.93%
20	11	0.543	0.478	-0.06	-11.96%	10.81%
20	12	0.541	0.476	-0.06	-12.00%	10.81%
20	13	0.543	0.469	-0.07	-13.63%	12.33%
20	14	0.541	0.486	-0.06	-10.19%	9.20%
30	15	0.543	0.329	-0.21	-39.40%	35.68%
30	16	0.543	0.244	-0.30	-54.98%	49.73%
30	17	0.541	0.235	-0.31	-56.62%	51.04%
30	18	0.543	0.259	-0.28	-52.24%	47.30%
30	19	0.541	0.346	-0.20	-36.10%	32.54%
30	20	0.542	0.255	-0.29	-52.91%	47.81%
31	15a	0.543	0.486	-0.06	-10.49%	9.50%
31	16a	0.543	0.472	-0.07	-12.96%	11.72%
31	17a	0.541	0.484	-0.06	-10.54%	9.50%
31	18a	0.543	0.474	-0.07	-12.84%	11.62%
31	19a	0.541	0.483	-0.06	-10.65%	9.60%
31	20a	0.542	0.476	-0.07	-12.19%	11.02%
50	21	0.541	0.101	-0.44	-81.40%	73.38%
50	22	0.541	0.101	-0.44	-81.40%	73.38%
50	23	0.542	0.101	-0.44	-81.44%	73.58%
50	24	0.540	0.101	-0.44	-81.36%	73.18%
50	25	0.538	0.101	-0.44	-81.32%	72.97%
Max		0.546	0.547	0.00	0.22%	73.58%
Average		0.542	0.406	-0.14	-25.13%	22.70%
Min		0.539	0.101	-0.44	-81.44%	0.00%
Std Dev		0.002	0.155	0.15	28.61%	25.79%

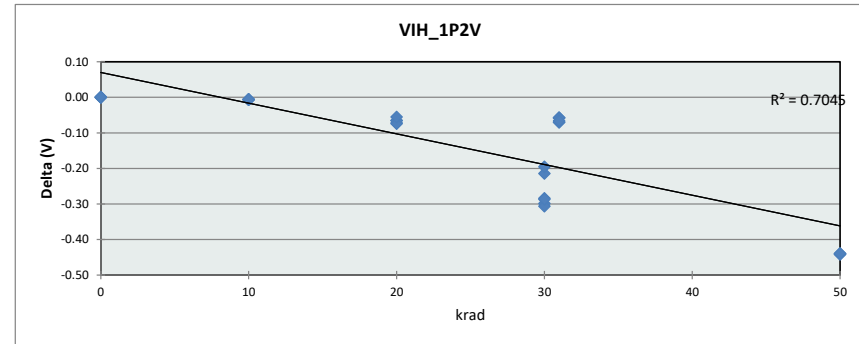

		VIH_1P2V					
Units		V					
Max Limit		0.78					
Min Limit		0.18					
krad	0	10	20	30	31	50	
LL	0.180	0.180	0.180	0.180	0.180	0.180	
Min	0.542	0.533	0.469	0.235	0.472	0.101	
Average	0.545	0.534	0.476	0.278	0.479	0.101	
Max	0.547	0.536	0.486	0.346	0.486	0.101	
UL	0.780	0.780	0.780	0.780	0.780	0.780	

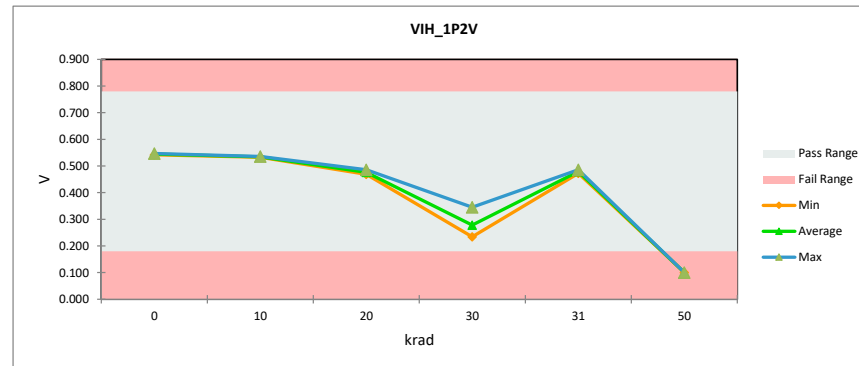

TID Report

SN54SC8T541-SEP

		VIH_1P65V					
Units		V					
Max Limit		1.1					
Min Limit		0.5					
krad	Serial #	PreTestHDR	PostTestHDR	Delta	Delta %	% of Limit Range	
0	1	0.702	0.703	0.00	0.13%	0.15%	
0	2	0.707	0.705	0.00	-0.25%	0.29%	
0	3	0.706	0.706	0.00	0.00%	0.00%	
0	4	0.707	0.707	0.00	0.00%	0.00%	
10	5	0.702	0.686	-0.02	-2.38%	2.78%	
10	6	0.704	0.689	-0.01	-2.12%	2.49%	
10	7	0.704	0.688	-0.02	-2.25%	2.64%	
10	8	0.704	0.686	-0.02	-2.62%	3.08%	
10	9	0.703	0.687	-0.02	-2.38%	2.78%	
20	10	0.706	0.624	-0.08	-11.59%	13.63%	
20	11	0.704	0.626	-0.08	-11.11%	13.04%	
20	12	0.705	0.628	-0.08	-10.98%	12.90%	
20	13	0.707	0.623	-0.08	-11.82%	13.92%	
20	14	0.705	0.628	-0.08	-10.85%	12.75%	
30	15	0.705	0.594	-0.11	-15.72%	18.47%	
30	16	0.705	0.591	-0.11	-16.22%	19.05%	
30	17	0.704	0.592	-0.11	-15.86%	18.61%	
30	18	0.707	0.589	-0.12	-16.67%	19.64%	
30	19	0.703	0.606	-0.10	-13.88%	16.27%	
30	20	0.705	0.601	-0.10	-14.72%	17.29%	
31	15a	0.705	0.627	-0.08	-11.10%	13.04%	
31	16a	0.705	0.621	-0.08	-11.97%	14.07%	
31	17a	0.704	0.626	-0.08	-11.11%	13.04%	
31	18a	0.707	0.627	-0.08	-11.32%	13.34%	
31	19a	0.703	0.633	-0.07	-10.00%	11.72%	
31	20a	0.705	0.624	-0.08	-11.48%	13.48%	
50	21	0.706	0.230	-0.48	-67.40%	79.29%	
50	22	0.704	0.232	-0.47	-67.06%	78.70%	
50	23	0.704	0.232	-0.47	-67.06%	78.70%	
50	24	0.704	0.227	-0.48	-67.81%	79.58%	
50	25	0.701	0.214	-0.49	-69.45%	81.19%	
Max		0.707	0.707	0.00	0.13%	79.58%	
Average		0.705	0.588	-0.12	-16.59%	19.49%	
Min		0.702	0.227	-0.48	-67.81%	0.00%	
Std Dev		0.001	0.148	0.15	20.96%	24.61%	

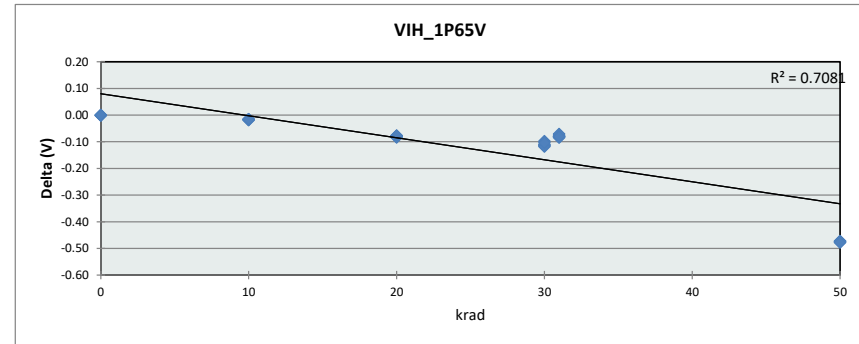

		VIH_1P65V					
Units		V					
Max Limit		1.1					
Min Limit		0.5					
krad		0	10	20	30	31	50
LL		0.500	0.500	0.500	0.500	0.500	0.500
Min		0.703	0.686	0.623	0.589	0.621	0.214
Average		0.705	0.687	0.626	0.595	0.626	0.227
Max		0.707	0.689	0.628	0.606	0.633	0.232
UL		1.100	1.100	1.100	1.100	1.100	1.100

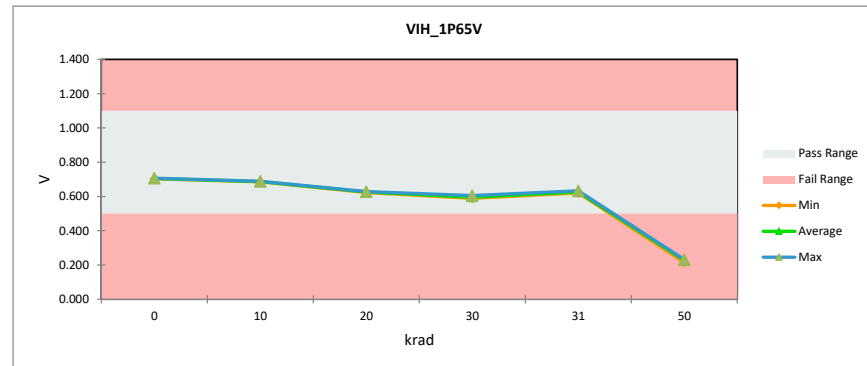

TID Report

SN54SC8T541-SEP

		VIH_2P25V				
Units		V				
Max Limit		1.28				
Min Limit		0.65				
krad	Serial #	PreTestHDR	PostTestHDR	Delta	Delta %	% of Limit Range
0	1	0.868	0.867	0.00	-0.14%	0.20%
0	2	0.871	0.871	0.00	0.00%	0.00%
0	3	0.871	0.873	0.00	0.29%	0.39%
0	4	0.871	0.871	0.00	0.00%	0.00%
10	5	0.868	0.852	-0.02	-1.86%	2.57%
10	6	0.868	0.856	-0.01	-1.43%	1.97%
10	7	0.871	0.857	-0.01	-1.57%	2.17%
10	8	0.870	0.855	-0.01	-1.72%	2.37%
10	9	0.871	0.856	-0.01	-1.71%	2.37%
20	10	0.872	0.819	-0.05	-6.13%	8.49%
20	11	0.870	0.816	-0.05	-6.15%	8.49%
20	12	0.871	0.820	-0.05	-5.85%	8.09%
20	13	0.871	0.814	-0.06	-6.57%	9.08%
20	14	0.870	0.820	-0.05	-5.72%	7.89%
30	15	0.870	0.807	-0.06	-7.15%	9.87%
30	16	0.871	0.797	-0.07	-8.42%	11.64%
30	17	0.870	0.794	-0.08	-8.72%	12.04%
30	18	0.871	0.783	-0.09	-10.14%	14.01%
30	19	0.872	0.795	-0.08	-8.84%	12.23%
30	20	0.867	0.786	-0.08	-9.32%	12.83%
31	15a	0.870	0.816	-0.05	-6.15%	8.49%
31	16a	0.871	0.814	-0.06	-6.57%	9.08%
31	17a	0.870	0.817	-0.05	-6.00%	8.29%
31	18a	0.871	0.817	-0.05	-6.14%	8.49%
31	19a	0.872	0.822	-0.05	-5.70%	7.89%
31	20a	0.867	0.816	-0.05	-5.88%	8.09%
50	21	0.872	0.667	-0.21	-23.52%	32.56%
50	22	0.870	0.654	-0.22	-24.73%	34.14%
50	23	0.868	0.668	-0.20	-23.05%	31.77%
50	24	0.870	0.657	-0.21	-24.45%	33.74%
50	25	0.871	0.653	-0.22	-24.98%	34.53%
Max		0.872	0.873	0.00	0.29%	34.14%
Average		0.870	0.805	-0.06	-7.45%	10.31%
Min		0.867	0.654	-0.21	-24.73%	0.00%
Std Dev		0.001	0.063	0.06	7.24%	9.96%

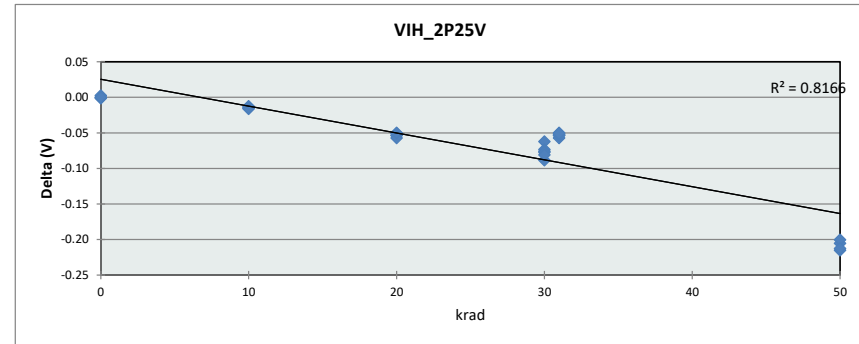

		VIH_2P25V					
Units		V					
Max Limit		1.28					
Min Limit		0.65					
krad		0	10	20	30	31	50
LL		0.650	0.650	0.650	0.650	0.650	0.650
Min		0.867	0.852	0.814	0.783	0.814	0.653
Average		0.870	0.855	0.818	0.794	0.817	0.660
Max		0.873	0.857	0.820	0.807	0.822	0.668
UL		1.280	1.280	1.280	1.280	1.280	1.280

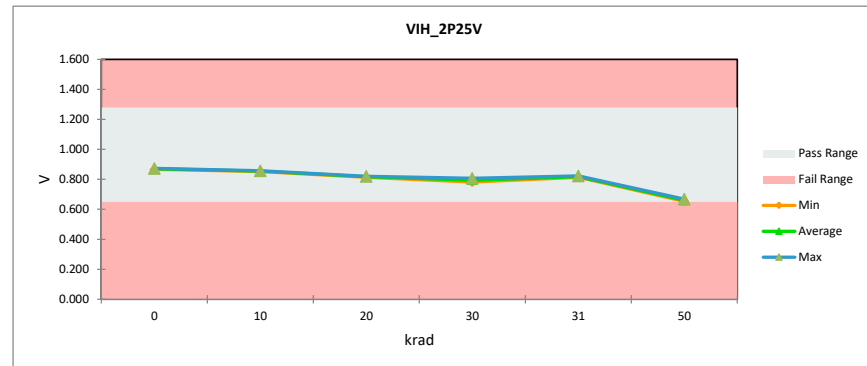

TID Report SN54SC8T541-SEP

		VIH_3V				
Units		V				
Max Limit		1.45				
Min Limit		0.75				
krad	Serial #	PreTestHDR	PostTestHDR	Delta	Delta %	% of Limit Range
0	1	1.063	1.061	0.00	-0.16%	0.24%
0	2	1.064	1.064	0.00	0.00%	0.00%
0	3	1.061	1.063	0.00	0.16%	0.24%
0	4	1.066	1.063	0.00	-0.32%	0.49%
10	5	1.054	1.049	-0.01	-0.48%	0.73%
10	6	1.059	1.054	-0.01	-0.48%	0.73%
10	7	1.059	1.056	0.00	-0.32%	0.49%
10	8	1.064	1.053	-0.01	-1.12%	1.70%
10	9	1.061	1.056	-0.01	-0.48%	0.73%
20	10	1.063	1.051	-0.01	-1.12%	1.70%
20	11	1.066	1.049	-0.02	-1.59%	2.43%
20	12	1.063	1.049	-0.01	-1.28%	1.94%
20	13	1.063	1.047	-0.02	-1.44%	2.18%
20	14	1.061	1.049	-0.01	-1.12%	1.70%
30	15	1.064	1.010	-0.05	-5.10%	7.76%
30	16	1.059	1.010	-0.05	-4.65%	7.03%
30	17	1.059	1.015	-0.04	-4.17%	6.31%
30	18	1.063	1.010	-0.05	-4.95%	7.52%
30	19	1.063	1.017	-0.05	-4.31%	6.55%
30	20	1.058	1.010	-0.05	-4.50%	6.79%
31	15a	1.064	1.046	-0.02	-1.75%	2.67%
31	16a	1.059	1.044	-0.02	-1.44%	2.18%
31	17a	1.059	1.047	-0.01	-1.12%	1.70%
31	18a	1.063	1.047	-0.02	-1.44%	2.18%
31	19a	1.063	1.047	-0.02	-1.44%	2.18%
31	20a	1.058	1.046	-0.01	-1.12%	1.70%
50	21	1.058	0.930	-0.13	-12.04%	18.19%
50	22	1.061	0.922	-0.14	-13.12%	19.89%
50	23	1.061	0.932	-0.13	-12.16%	18.44%
50	24	1.059	0.922	-0.14	-12.98%	19.65%
50	25	1.058	0.918	-0.14	-13.16%	19.89%
Max		1.066	1.064	0.00	0.16%	19.89%
Average		1.061	1.027	-0.03	-3.20%	4.87%
Min		1.054	0.922	-0.13	-13.12%	0.00%
Std Dev		0.003	0.044	0.04	4.06%	6.13%

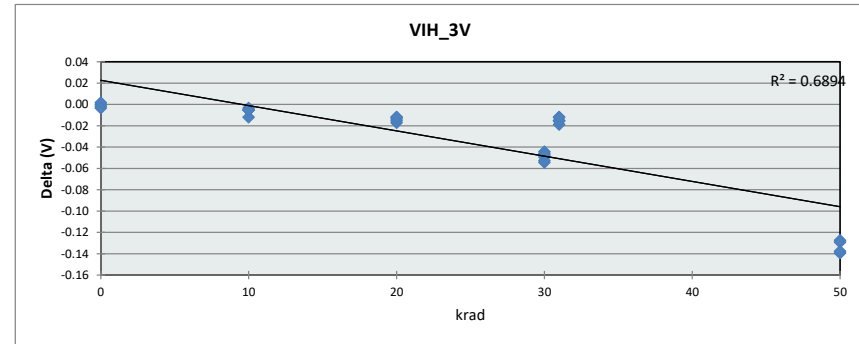

		VIH_3V					
Units		V					
Max Limit		1.45					
Min Limit		0.75					
krad	0	10	20	30	31	50	
LL	0.750	0.750	0.750	0.750	0.750	0.750	
Min	1.061	1.049	1.047	1.010	1.044	0.918	
Average	1.063	1.054	1.049	1.012	1.046	0.925	
Max	1.064	1.056	1.051	1.017	1.047	0.932	
UL	1.450	1.450	1.450	1.450	1.450	1.450	

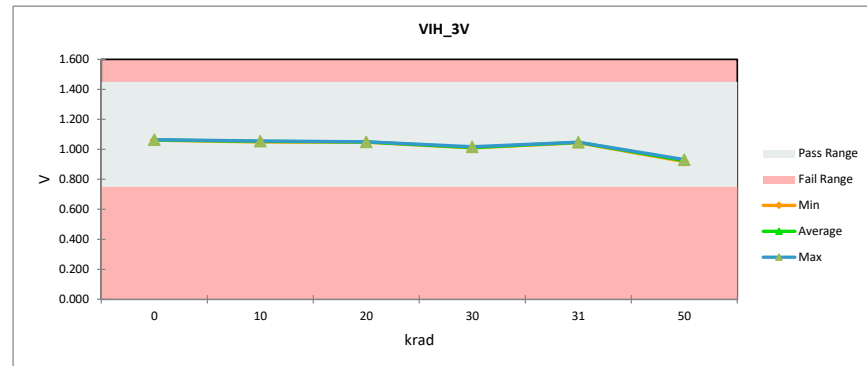

TID Report SN54SC8T541-SEP

		VIH_4P5V					
Units		V					
Max Limit		2					
Min Limit		0.85					
krad	Serial #	PreTestHDR	PostTestHDR	Delta	Delta %	% of Limit Range	
0	1	1.375	1.370	-0.01	-0.38%	0.45%	
0	2	1.380	1.380	0.00	0.00%	0.00%	
0	3	1.380	1.370	-0.01	-0.76%	0.91%	
0	4	1.380	1.383	0.00	0.19%	0.23%	
10	5	1.386	1.357	-0.03	-2.07%	2.49%	
10	6	1.393	1.357	-0.04	-2.62%	3.17%	
10	7	1.396	1.365	-0.03	-2.24%	2.72%	
10	8	1.388	1.362	-0.03	-1.88%	2.27%	
10	9	1.378	1.362	-0.02	-1.14%	1.36%	
20	10	1.391	1.370	-0.02	-1.50%	1.81%	
20	11	1.393	1.365	-0.03	-2.06%	2.49%	
20	12	1.393	1.367	-0.03	-1.87%	2.27%	
20	13	1.391	1.367	-0.02	-1.69%	2.04%	
20	14	1.378	1.365	-0.01	-0.95%	1.13%	
30	15	1.399	1.373	-0.03	-1.86%	2.27%	
30	16	1.391	1.357	-0.03	-2.44%	2.95%	
30	17	1.378	1.362	-0.02	-1.14%	1.36%	
30	18	1.391	1.359	-0.03	-2.25%	2.72%	
30	19	1.393	1.357	-0.04	-2.62%	3.17%	
30	20	1.375	1.354	-0.02	-1.52%	1.81%	
31	15a	1.399	1.357	-0.04	-2.98%	3.63%	
31	16a	1.391	1.359	-0.03	-2.25%	2.72%	
31	17a	1.378	1.357	-0.02	-1.51%	1.81%	
31	18a	1.391	1.357	-0.03	-2.44%	2.95%	
31	19a	1.393	1.357	-0.04	-2.62%	3.17%	
31	20a	1.375	1.354	-0.02	-1.52%	1.81%	
50	21	1.391	1.339	-0.05	-3.75%	4.54%	
50	22	1.391	1.336	-0.05	-3.94%	4.76%	
50	23	1.378	1.333	-0.04	-3.22%	3.85%	
50	24	1.393	1.336	-0.06	-4.12%	4.99%	
50	25	1.375	1.336	-0.04	-2.84%	3.40%	
Max		1.399	1.383	-0.02	0.19%	4.99%	
Average		1.387	1.360	-0.03	-1.97%	2.40%	
Min		1.375	1.333	-0.04	-4.12%	0.00%	
Std Dev		0.008	0.012	0.00	1.05%	1.25%	

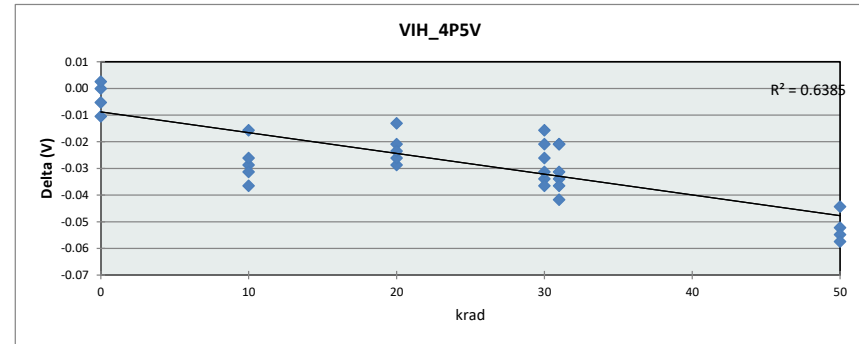

		VIH_4P5V					
Units		V					
Max Limit		2					
Min Limit		0.85					
krad		0	10	20	30	31	50
LL		0.850	0.850	0.850	0.850	0.850	0.850
Min		1.370	1.357	1.365	1.354	1.354	1.333
Average		1.376	1.361	1.367	1.360	1.357	1.336
Max		1.383	1.365	1.370	1.373	1.359	1.339
UL		2.000	2.000	2.000	2.000	2.000	2.000

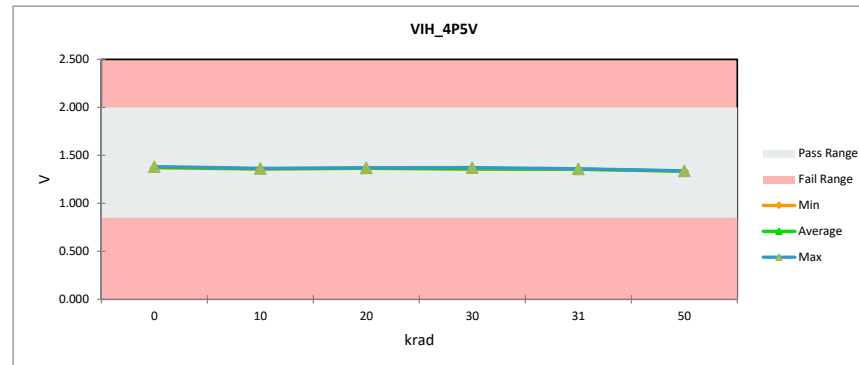

TID Report

SN54SC8T541-SEP

		VIH_5P5V					
Units		V					
Max Limit		2					
Min Limit		0.85					
krad	Serial #	PreTestHDR	PostTestHDR	Delta	Delta %	% of Limit Range	
0	1	1.595	1.562	-0.03	-2.02%	2.79%	
0	2	1.595	1.562	-0.03	-2.02%	2.79%	
0	3	1.566	1.559	-0.01	-0.41%	0.56%	
0	4	1.569	1.575	0.01	0.41%	0.56%	
10	5	1.562	1.546	-0.02	-1.03%	1.40%	
10	6	1.569	1.562	-0.01	-0.41%	0.56%	
10	7	1.559	1.559	0.00	0.00%	0.00%	
10	8	1.559	1.556	0.00	-0.21%	0.28%	
10	9	1.591	1.556	-0.04	-2.22%	3.07%	
20	10	1.588	1.553	-0.04	-2.23%	3.07%	
20	11	1.569	1.559	-0.01	-0.61%	0.84%	
20	12	1.591	1.556	-0.04	-2.22%	3.07%	
20	13	1.588	1.559	-0.03	-1.82%	2.52%	
20	14	1.569	1.550	-0.02	-1.23%	1.68%	
30	15	1.572	1.550	-0.02	-1.43%	1.96%	
30	16	1.595	1.540	-0.05	-3.43%	4.75%	
30	17	1.566	1.540	-0.03	-1.64%	2.24%	
30	18	1.562	1.540	-0.02	-1.44%	1.96%	
30	19	1.569	1.546	-0.02	-1.43%	1.96%	
30	20	1.591	1.543	-0.05	-3.03%	4.19%	
31	15a	1.572	1.562	-0.01	-0.61%	0.84%	
31	16a	1.595	1.556	-0.04	-2.42%	3.35%	
31	17a	1.566	1.553	-0.01	-0.82%	1.12%	
31	18a	1.562	1.553	-0.01	-0.62%	0.84%	
31	19a	1.569	1.559	-0.01	-0.61%	0.84%	
31	20a	1.591	1.550	-0.04	-2.63%	3.63%	
50	21	1.582	1.521	-0.06	-3.86%	5.31%	
50	22	1.569	1.521	-0.05	-3.07%	4.19%	
50	23	1.562	1.514	-0.05	-3.09%	4.19%	
50	24	1.562	1.517	-0.04	-2.88%	3.91%	
50	25	1.566	1.517	-0.05	-3.08%	4.19%	
Max		1.595	1.575	-0.02	0.41%	5.31%	
Average		1.575	1.549	-0.03	-1.63%	2.28%	
Min		1.559	1.514	-0.04	-3.86%	0.00%	
Std Dev		0.013	0.015	0.00	1.12%	1.48%	

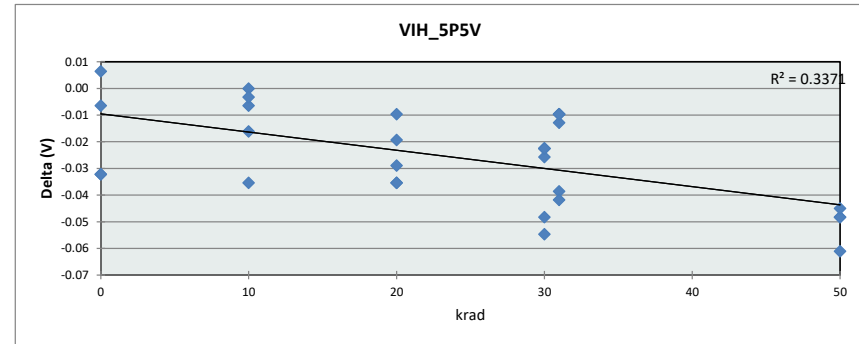

		VIH_5P5V					
Units		V					
Max Limit		2					
Min Limit		0.85					
krad		0	10	20	30	31	50
LL		0.850	0.850	0.850	0.850	0.850	0.850
Min		1.559	1.546	1.550	1.540	1.550	1.514
Average		1.565	1.556	1.555	1.543	1.555	1.518
Max		1.575	1.562	1.559	1.550	1.562	1.521
UL		2.000	2.000	2.000	2.000	2.000	2.000

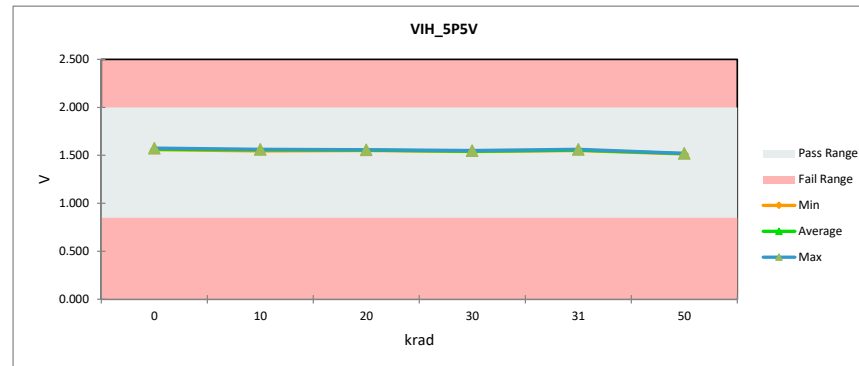

TID Report

SN54SC8T541-SEP

		VIL_1P2V					
Units		V					
Max Limit		0.78					
Min Limit		0.18					
krad	Serial #	PreTestHDR	PostTestHDR	Delta	Delta %	% of Limit Range	
0	1	0.512	0.532	0.02	3.91%	3.34%	
0	2	0.510	0.525	0.01	2.88%	2.45%	
0	3	0.512	0.521	0.01	1.69%	1.45%	
0	4	0.516	0.518	0.00	0.39%	0.33%	
10	5	0.514	0.492	-0.02	-4.16%	3.56%	
10	6	0.512	0.496	-0.02	-3.00%	2.56%	
10	7	0.513	0.502	-0.01	-2.08%	1.78%	
10	8	0.512	0.492	-0.02	-3.78%	3.22%	
10	9	0.512	0.492	-0.02	-3.91%	3.34%	
20	10	0.513	0.362	-0.15	-29.39%	25.13%	
20	11	0.515	0.374	-0.14	-27.46%	23.57%	
20	12	0.514	0.369	-0.15	-28.28%	24.24%	
20	13	0.510	0.363	-0.15	-28.89%	24.57%	
20	14	0.514	0.370	-0.14	-28.06%	24.02%	
30	15	0.512	0.223	-0.29	-56.46%	48.14%	
30	16	0.516	0.209	-0.31	-59.52%	51.15%	
30	17	0.509	0.184	-0.32	-63.84%	54.15%	
30	18	0.514	0.167	-0.35	-67.41%	57.71%	
30	19	0.513	0.235	-0.28	-54.10%	46.25%	
30	20	0.512	0.205	-0.31	-59.85%	51.03%	
31	15a	0.512	0.372	-0.14	-27.25%	23.24%	
31	16a	0.516	0.372	-0.14	-27.95%	24.02%	
31	17a	0.509	0.364	-0.15	-28.58%	24.24%	
31	18a	0.514	0.370	-0.14	-27.93%	23.90%	
31	19a	0.513	0.378	-0.14	-26.40%	22.57%	
31	20a	0.512	0.370	-0.14	-27.77%	23.68%	
50	21	0.514	0.099	-0.41	-80.68%	69.16%	
50	22	0.515	0.101	-0.41	-80.32%	68.93%	
50	23	0.514	0.101	-0.41	-80.40%	68.82%	
50	24	0.510	0.099	-0.41	-80.53%	68.49%	
50	25	0.514	0.099	-0.41	-80.66%	69.05%	
Max		0.516	0.532	0.02	3.91%	69.16%	
Average		0.513	0.342	-0.17	-33.30%	28.97%	
Min		0.509	0.099	-0.41	-80.68%	0.33%	
Std Dev		0.002	0.145	0.14	28.29%	23.56%	

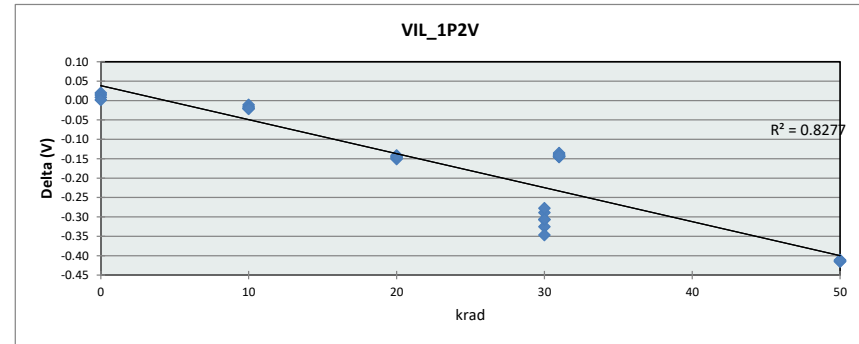

		VIL_1P2V					
Units		V					
Max Limit		0.78					
Min Limit		0.18					
krad		0	10	20	30	31	50
LL		0.180	0.180	0.180	0.180	0.180	0.180
Min		0.518	0.492	0.362	0.167	0.364	0.099
Average		0.524	0.495	0.367	0.204	0.371	0.100
Max		0.532	0.502	0.374	0.235	0.378	0.101
UL		0.780	0.780	0.780	0.780	0.780	0.780

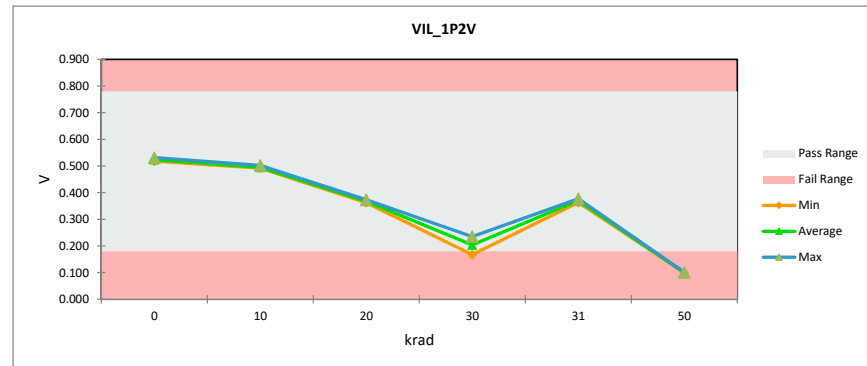

TID Report

SN54SC8T541-SEP

		VIL_1P65V				
Units		V				
Max Limit		1.1				
Min Limit		0.5				
krad	Serial #	PreTestHDR	PostTestHDR	Delta	Delta %	% of Limit Range
0	1	0.649	0.685	0.04	5.51%	5.97%
0	2	0.645	0.687	0.04	6.60%	7.09%
0	3	0.644	0.689	0.05	7.06%	7.58%
0	4	0.656	0.690	0.03	5.16%	5.64%
10	5	0.651	0.668	0.02	2.52%	2.74%
10	6	0.650	0.671	0.02	3.12%	3.39%
10	7	0.652	0.670	0.02	2.67%	2.90%
10	8	0.650	0.667	0.02	2.53%	2.74%
10	9	0.647	0.669	0.02	3.44%	3.71%
20	10	0.643	0.614	-0.03	-4.52%	4.84%
20	11	0.652	0.616	-0.04	-5.63%	6.13%
20	12	0.652	0.618	-0.03	-5.34%	5.80%
20	13	0.650	0.613	-0.04	-5.80%	6.29%
20	14	0.653	0.618	-0.04	-5.48%	5.97%
30	15	0.647	0.516	-0.13	-20.32%	21.93%
30	16	0.645	0.505	-0.14	-21.61%	23.22%
30	17	0.648	0.504	-0.14	-22.23%	24.02%
30	18	0.655	0.491	-0.16	-25.10%	27.41%
30	19	0.652	0.515	-0.14	-21.06%	22.89%
30	20	0.650	0.507	-0.14	-22.01%	23.86%
31	15a	0.647	0.616	-0.03	-4.93%	5.32%
31	16a	0.645	0.611	-0.03	-5.25%	5.64%
31	17a	0.648	0.614	-0.03	-5.37%	5.80%
31	18a	0.655	0.616	-0.04	-6.05%	6.61%
31	19a	0.652	0.620	-0.03	-4.89%	5.32%
31	20a	0.650	0.614	-0.04	-5.65%	6.13%
50	21	0.651	0.226	-0.43	-65.34%	70.94%
50	22	0.650	0.205	-0.44	-68.41%	74.16%
50	23	0.652	0.226	-0.43	-65.39%	71.10%
50	24	0.650	0.214	-0.44	-67.08%	72.71%
50	25	0.652	0.208	-0.44	-68.06%	74.00%
Max		0.656	0.690	0.03	7.06%	74.16%
Average		0.650	0.559	-0.09	-13.96%	17.93%
Min		0.643	0.205	-0.44	-68.41%	2.74%
Std Dev		0.003	0.149	0.15	22.98%	22.95%

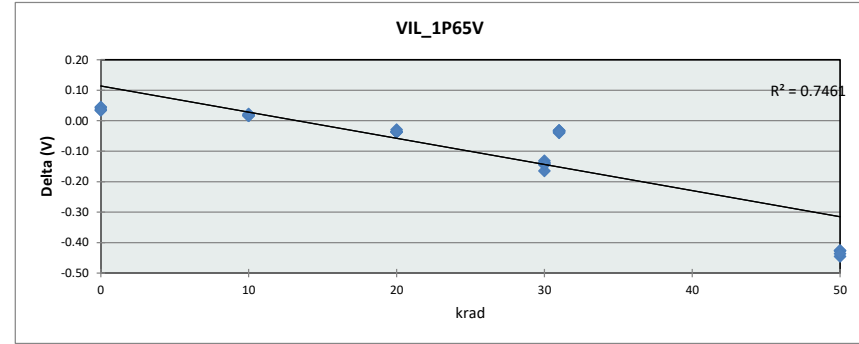

		VIL_1P65V					
Units		V					
Max Limit		1.1					
Min Limit		0.5					
krad		0	10	20	30	31	50
LL		0.500	0.500	0.500	0.500	0.500	0.500
Min		0.685	0.667	0.613	0.491	0.611	0.205
Average		0.688	0.669	0.615	0.506	0.615	0.216
Max		0.690	0.671	0.618	0.516	0.620	0.226
UL		1.100	1.100	1.100	1.100	1.100	1.100

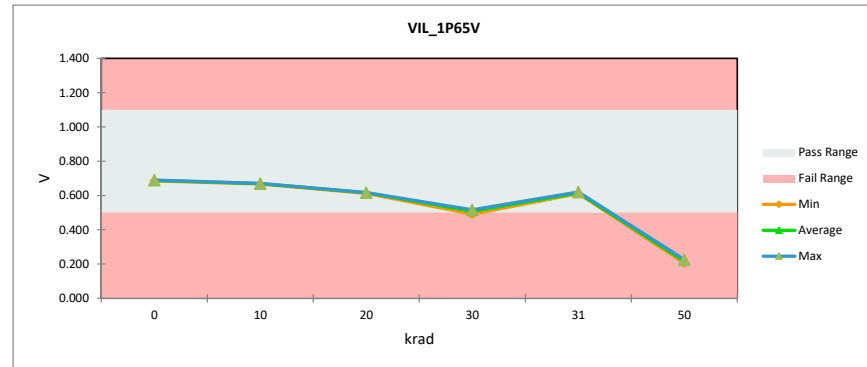

TID Report

SN54SC8T541-SEP

		VIL_2P25V				
Units		V				
Max Limit		1.28				
Min Limit		0.65				
krad	Serial #	PreTestHDR	PostTestHDR	Delta	Delta %	% of Limit Range
0	1	0.849	0.848	0.00	-0.16%	0.22%
0	2	0.851	0.848	0.00	-0.32%	0.43%
0	3	0.852	0.847	-0.01	-0.64%	0.87%
0	4	0.852	0.854	0.00	0.16%	0.22%
10	5	0.849	0.832	-0.02	-2.09%	2.82%
10	6	0.851	0.832	-0.02	-2.25%	3.04%
10	7	0.854	0.834	-0.02	-2.24%	3.04%
10	8	0.851	0.834	-0.02	-1.93%	2.60%
10	9	0.838	0.837	0.00	-0.16%	0.22%
20	10	0.854	0.802	-0.05	-6.09%	8.25%
20	11	0.851	0.803	-0.05	-5.63%	7.60%
20	12	0.854	0.802	-0.05	-6.09%	8.25%
20	13	0.854	0.802	-0.05	-6.09%	8.25%
20	14	0.854	0.806	-0.05	-5.61%	7.60%
30	15	0.854	0.759	-0.09	-11.06%	14.98%
30	16	0.852	0.748	-0.10	-12.20%	16.50%
30	17	0.854	0.745	-0.11	-12.66%	17.15%
30	18	0.854	0.732	-0.12	-14.26%	19.32%
30	19	0.854	0.751	-0.10	-12.02%	16.28%
30	20	0.851	0.735	-0.12	-13.66%	18.45%
31	15a	0.854	0.803	-0.05	-5.93%	8.03%
31	16a	0.852	0.802	-0.05	-5.94%	8.03%
31	17a	0.854	0.800	-0.05	-6.25%	8.47%
31	18a	0.854	0.803	-0.05	-5.93%	8.03%
31	19a	0.854	0.804	-0.05	-5.77%	7.81%
31	20a	0.851	0.802	-0.05	-5.79%	7.81%
50	21	0.854	0.599	-0.25	-29.80%	40.38%
50	22	0.852	0.583	-0.27	-31.62%	42.76%
50	23	0.852	0.599	-0.25	-29.69%	40.16%
50	24	0.851	0.587	-0.26	-31.02%	41.90%
50	25	0.852	0.585	-0.27	-31.29%	42.33%
Max		0.854	0.854	0.00	0.16%	42.76%
Average		0.852	0.774	-0.08	-9.09%	12.32%
Min		0.838	0.583	-0.26	-31.62%	0.22%
Std Dev		0.003	0.080	0.08	9.51%	12.85%

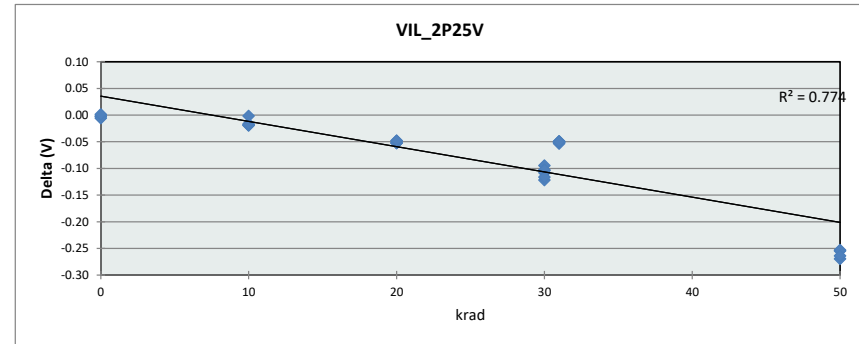

		VIL_2P25V					
Units		V					
Max Limit		1.28					
Min Limit		0.65					
krad		0	10	20	30	31	50
LL		0.650	0.650	0.650	0.650	0.650	0.650
Min		0.847	0.832	0.802	0.732	0.800	0.583
Average		0.849	0.834	0.803	0.745	0.802	0.591
Max		0.854	0.837	0.806	0.759	0.804	0.599
UL		1.280	1.280	1.280	1.280	1.280	1.280

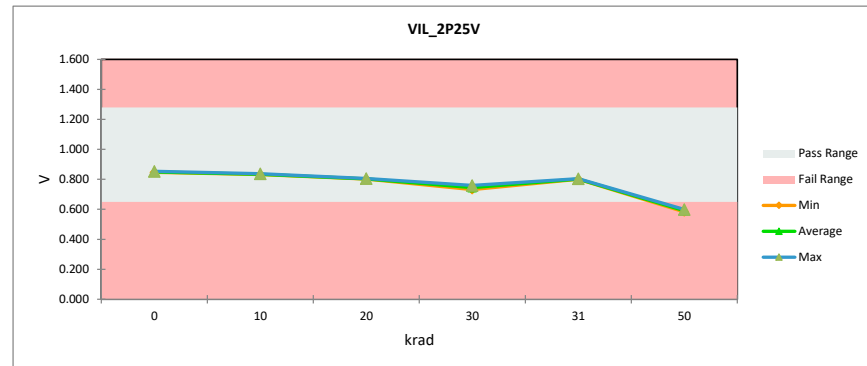

TID Report

SN54SC8T541-SEP

		VIL_3V				
Units		V				
Max Limit		1.45				
Min Limit		0.75				
krad	Serial #	PreTestHDR	PostTestHDR	Delta	Delta %	% of Limit Range
0	1	1.041	1.047	0.01	0.54%	0.80%
0	2	1.049	1.049	0.00	0.00%	0.00%
0	3	1.051	1.047	0.00	-0.36%	0.53%
0	4	1.049	1.051	0.00	0.18%	0.27%
10	5	1.041	1.034	-0.01	-0.72%	1.07%
10	6	1.045	1.034	-0.01	-1.07%	1.60%
10	7	1.047	1.036	-0.01	-1.07%	1.60%
10	8	1.045	1.028	-0.02	-1.61%	2.40%
10	9	1.047	1.038	-0.01	-0.89%	1.33%
20	10	1.045	1.008	-0.04	-3.57%	5.34%
20	11	1.045	1.006	-0.04	-3.75%	5.60%
20	12	1.047	1.012	-0.04	-3.39%	5.07%
20	13	1.047	1.008	-0.04	-3.75%	5.60%
20	14	1.041	1.012	-0.03	-2.87%	4.27%
30	15	1.049	0.969	-0.08	-7.66%	11.47%
30	16	1.047	0.967	-0.08	-7.67%	11.47%
30	17	1.047	0.970	-0.08	-7.31%	10.94%
30	18	1.045	0.965	-0.08	-7.68%	11.47%
30	19	1.051	0.972	-0.08	-7.47%	11.21%
30	20	1.047	0.969	-0.08	-7.49%	11.21%
31	15a	1.049	1.012	-0.04	-3.56%	5.34%
31	16a	1.047	1.008	-0.04	-3.75%	5.60%
31	17a	1.047	1.008	-0.04	-3.75%	5.60%
31	18a	1.045	1.012	-0.03	-3.22%	4.80%
31	19a	1.051	1.012	-0.04	-3.73%	5.60%
31	20a	1.047	1.008	-0.04	-3.75%	5.60%
50	21	1.047	0.885	-0.16	-15.52%	23.22%
50	22	1.049	0.873	-0.18	-16.74%	25.08%
50	23	1.047	0.885	-0.16	-15.52%	23.22%
50	24	1.047	0.873	-0.17	-16.59%	24.82%
50	25	1.045	0.871	-0.17	-16.62%	24.82%
Max		1.051	1.051	0.00	0.54%	25.08%
Average		1.047	0.993	-0.05	-5.12%	7.74%
Min		1.041	0.873	-0.17	-16.74%	0.00%
Std Dev		0.002	0.052	0.05	5.04%	7.47%

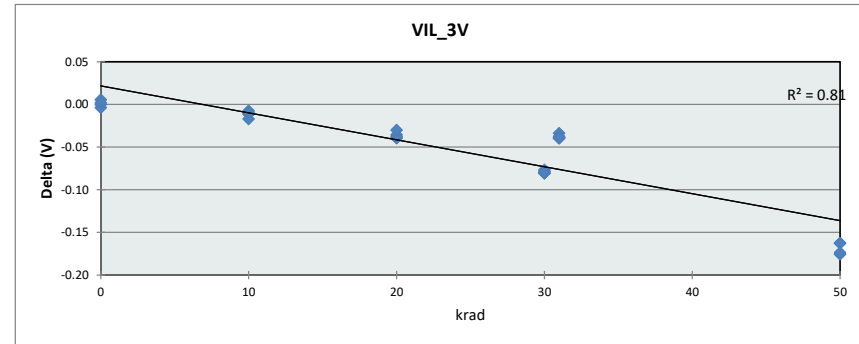

		VIL_3V				
Units		V				
Max Limit		1.45				
Min Limit		0.75				
krad	0	10	20	30	31	50
LL	0.750	0.750	0.750	0.750	0.750	0.750
Min	1.047	1.028	1.006	0.965	1.008	0.871
Average	1.048	1.034	1.009	0.969	1.010	0.877
Max	1.051	1.038	1.012	0.972	1.012	0.885
UL	1.450	1.450	1.450	1.450	1.450	1.450

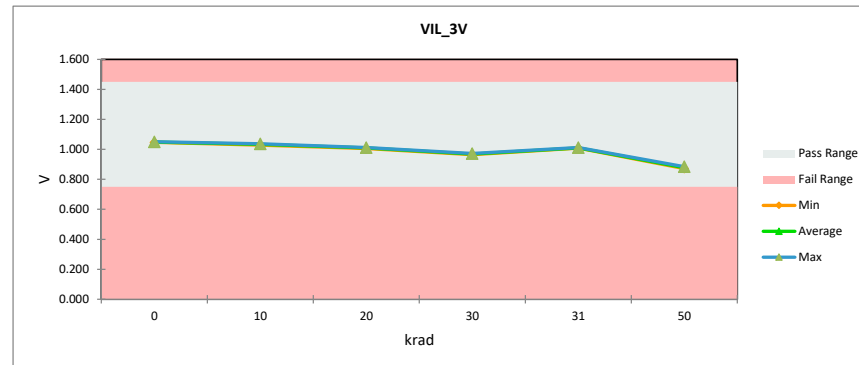

TID Report SN54SC8T541-SEP

		VIL_4P5V				
Units		V				
Max Limit		2				
Min Limit		0.85				
krad	Serial #	PreTestHDR	PostTestHDR	Delta	Delta %	% of Limit Range
0	1	1.351	1.351	0.00	0.00%	0.00%
0	2	1.351	1.351	0.00	0.00%	0.00%
0	3	1.354	1.345	-0.01	-0.64%	0.75%
0	4	1.351	1.354	0.00	0.21%	0.25%
10	5	1.348	1.339	-0.01	-0.64%	0.75%
10	6	1.351	1.342	-0.01	-0.64%	0.75%
10	7	1.354	1.342	-0.01	-0.85%	1.00%
10	8	1.351	1.339	-0.01	-0.85%	1.00%
10	9	1.354	1.342	-0.01	-0.85%	1.00%
20	10	1.354	1.325	-0.03	-2.12%	2.49%
20	11	1.354	1.328	-0.03	-1.91%	2.24%
20	12	1.356	1.325	-0.03	-2.33%	2.74%
20	13	1.351	1.325	-0.03	-1.91%	2.24%
20	14	1.351	1.325	-0.03	-1.91%	2.24%
30	15	1.351	1.290	-0.06	-4.46%	5.24%
30	16	1.354	1.288	-0.07	-4.87%	5.74%
30	17	1.354	1.293	-0.06	-4.45%	5.24%
30	18	1.354	1.288	-0.07	-4.87%	5.74%
30	19	1.354	1.299	-0.05	-4.03%	4.74%
30	20	1.351	1.288	-0.06	-4.67%	5.49%
31	15a	1.351	1.322	-0.03	-2.12%	2.49%
31	16a	1.354	1.325	-0.03	-2.12%	2.49%
31	17a	1.354	1.322	-0.03	-2.33%	2.74%
31	18a	1.354	1.325	-0.03	-2.12%	2.49%
31	19a	1.354	1.328	-0.03	-1.91%	2.24%
31	20a	1.351	1.322	-0.03	-2.12%	2.49%
50	21	1.354	1.227	-0.13	-9.32%	10.98%
50	22	1.351	1.224	-0.13	-9.34%	10.98%
50	23	1.351	1.230	-0.12	-8.92%	10.48%
50	24	1.351	1.227	-0.12	-9.13%	10.73%
50	25	1.351	1.224	-0.13	-9.34%	10.98%
Max		1.356	1.354	0.00	0.21%	10.98%
Average		1.352	1.311	-0.04	-3.04%	3.59%
Min		1.348	1.224	-0.12	-9.34%	0.00%
Std Dev		0.002	0.039	0.04	2.86%	3.34%

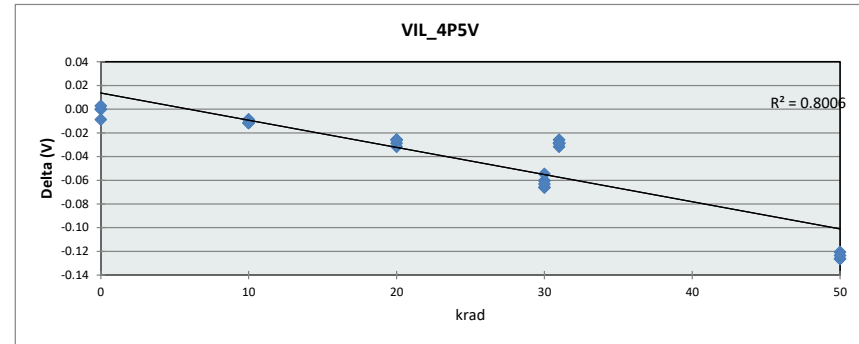

		VIL_4P5V					
Units		V					
Max Limit		2					
Min Limit		0.85					
krad		0	10	20	30	31	50
LL		0.850	0.850	0.850	0.850	0.850	0.850
Min		1.345	1.339	1.325	1.288	1.322	1.224
Average		1.350	1.341	1.325	1.291	1.324	1.227
Max		1.354	1.342	1.328	1.299	1.328	1.230
UL		2.000	2.000	2.000	2.000	2.000	2.000

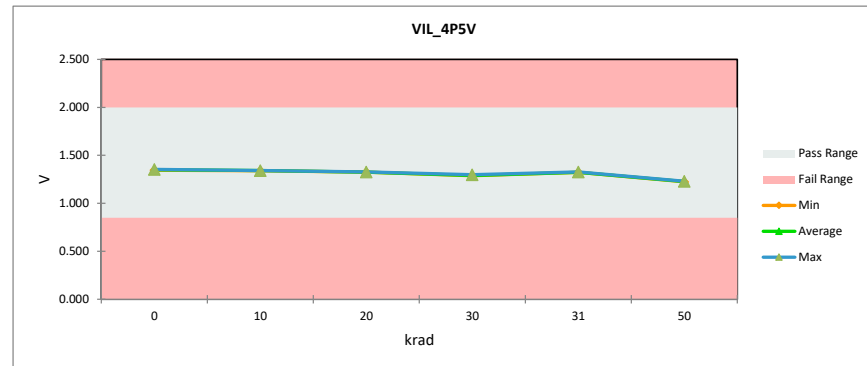

TID Report

SN54SC8T541-SEP

		VIL_5P5V				
Units		V				
Max Limit		2				
Min Limit		0.85				
krad	Serial #	PreTestHDR	PostTestHDR	Delta	Delta %	% of Limit Range
0	1	1.535	1.535	0.00	0.00%	0.00%
0	2	1.539	1.543	0.00	0.23%	0.31%
0	3	1.539	1.546	0.01	0.46%	0.61%
0	4	1.535	1.539	0.00	0.23%	0.31%
10	5	1.528	1.532	0.00	0.23%	0.31%
10	6	1.535	1.528	-0.01	-0.46%	0.61%
10	7	1.535	1.532	0.00	-0.23%	0.31%
10	8	1.539	1.528	-0.01	-0.69%	0.92%
10	9	1.539	1.532	-0.01	-0.46%	0.61%
20	10	1.539	1.514	-0.02	-1.61%	2.15%
20	11	1.539	1.514	-0.02	-1.61%	2.15%
20	12	1.539	1.514	-0.02	-1.61%	2.15%
20	13	1.539	1.511	-0.03	-1.84%	2.46%
20	14	1.532	1.514	-0.02	-1.15%	1.54%
30	15	1.535	1.475	-0.06	-3.91%	5.23%
30	16	1.535	1.468	-0.07	-4.38%	5.84%
30	17	1.539	1.482	-0.06	-3.68%	4.92%
30	18	1.539	1.472	-0.07	-4.36%	5.84%
30	19	1.532	1.486	-0.05	-3.00%	4.00%
30	20	1.532	1.475	-0.06	-3.69%	4.92%
31	15a	1.535	1.511	-0.02	-1.61%	2.15%
31	16a	1.535	1.507	-0.03	-1.84%	2.46%
31	17a	1.539	1.514	-0.02	-1.61%	2.15%
31	18a	1.539	1.511	-0.03	-1.84%	2.46%
31	19a	1.532	1.514	-0.02	-1.15%	1.54%
31	20a	1.532	1.511	-0.02	-1.38%	1.84%
50	21	1.535	1.422	-0.11	-7.37%	9.84%
50	22	1.532	1.412	-0.12	-7.85%	10.45%
50	23	1.539	1.419	-0.12	-7.81%	10.45%
50	24	1.532	1.412	-0.12	-7.85%	10.45%
50	25	1.539	1.419	-0.12	-7.81%	10.45%
Max		1.539	1.546	0.01	0.46%	10.45%
Average		1.536	1.499	-0.04	-2.39%	3.30%
Min		1.528	1.412	-0.12	-7.85%	0.00%
Std Dev		0.003	0.039	0.04	2.53%	3.27%

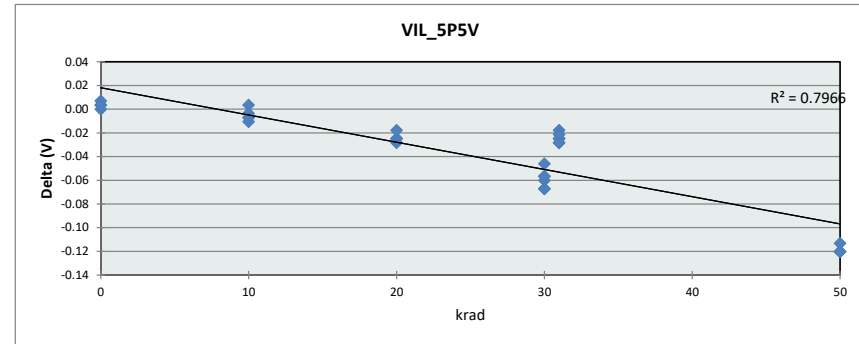

		VIL_5P5V					
Units		V					
Max Limit		2					
Min Limit		0.85					
krad		0	10	20	30	31	50
LL		0.850	0.850	0.850	0.850	0.850	0.850
Min		1.535	1.528	1.511	1.468	1.507	1.412
Average		1.541	1.531	1.514	1.477	1.511	1.417
Max		1.546	1.532	1.514	1.486	1.514	1.422
UL		2.000	2.000	2.000	2.000	2.000	2.000

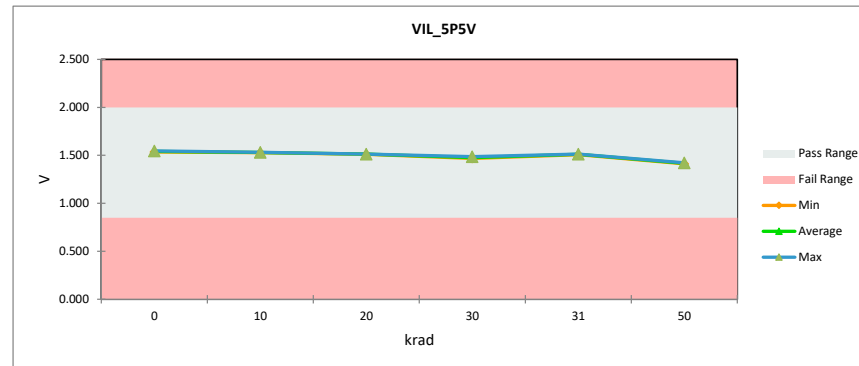

TID Report

SN54SC8T541-SEP

		VOH_N1MA_1P2V				
Units		V				
Max Limit		1.3				
Min Limit		0.8				
krad	Serial #	PreTestHDR	PostTestHDR	Delta	Delta %	% of Limit Range
0	1	1.137	1.137	0.00	-0.02%	0.04%
0	2	1.137	1.137	0.00	0.03%	0.07%
0	3	1.137	1.137	0.00	0.03%	0.08%
0	4	1.136	1.137	0.00	0.02%	0.05%
10	5	1.136	1.136	0.00	-0.01%	0.03%
10	6	1.136	1.136	0.00	0.00%	0.01%
10	7	1.136	1.136	0.00	0.00%	0.00%
10	8	1.136	1.136	0.00	-0.01%	0.02%
10	9	1.136	1.136	0.00	0.00%	0.01%
20	10	1.136	1.136	0.00	-0.02%	0.06%
20	11	1.136	1.136	0.00	-0.03%	0.07%
20	12	1.136	1.136	0.00	-0.03%	0.07%
20	13	1.136	1.136	0.00	-0.02%	0.05%
20	14	1.136	1.136	0.00	-0.04%	0.09%
30	15	1.136	1.136	0.00	-0.04%	0.09%
30	16	1.136	1.136	0.00	-0.05%	0.12%
30	17	1.136	1.136	0.00	-0.05%	0.12%
30	18	1.136	1.136	0.00	-0.05%	0.12%
30	19	1.136	1.136	0.00	-0.05%	0.12%
30	20	1.136	1.136	0.00	-0.06%	0.14%
31	15a	1.136	1.136	0.00	-0.04%	0.08%
31	16a	1.136	1.136	0.00	-0.05%	0.12%
31	17a	1.136	1.136	0.00	-0.07%	0.16%
31	18a	1.136	1.136	0.00	-0.04%	0.10%
31	19a	1.136	1.136	0.00	-0.06%	0.13%
31	20a	1.136	1.135	0.00	-0.08%	0.18%
50	21	1.136	1.135	0.00	-0.09%	0.21%
50	22	1.136	1.135	0.00	-0.08%	0.19%
50	23	1.136	1.135	0.00	-0.09%	0.21%
50	24	1.136	1.135	0.00	-0.09%	0.20%
50	25	1.136	1.135	0.00	-0.10%	0.22%
Max		1.137	1.137	0.00	0.03%	0.21%
Average		1.136	1.136	0.00	-0.04%	0.10%
Min		1.136	1.135	0.00	-0.09%	0.20%
Std Dev		0.000	0.001	0.00	0.03%	0.06%

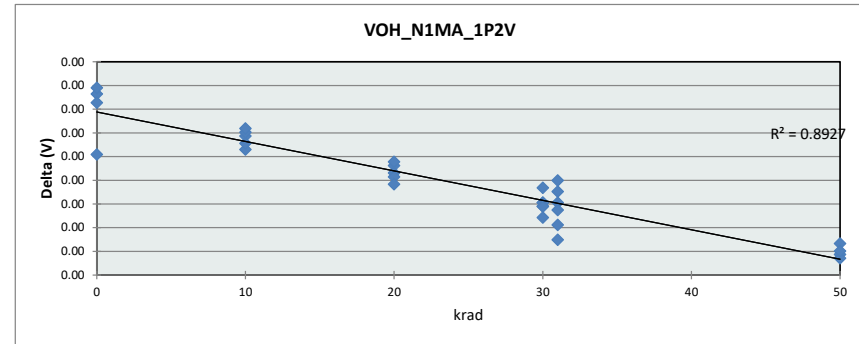

		VOH_N1MA_1P2V					
Units		V					
Max Limit		1.3					
Min Limit		0.8					
krad	0	10	20	30	31	50	
LL	0.800	0.800	0.800	0.800	0.800	0.800	
Min	1.137	1.136	1.136	1.136	1.135	1.135	
Average	1.137	1.136	1.136	1.136	1.136	1.135	
Max	1.137	1.136	1.136	1.136	1.136	1.135	
UL	1.300	1.300	1.300	1.300	1.300	1.300	

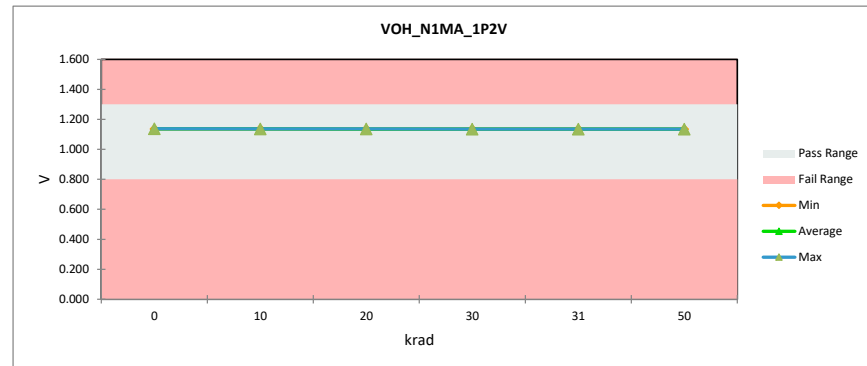

TID Report SN54SC8T541-SEP

		VOH_N2MA_1P65V					
Units		V					
Max Limit		1.75					
Min Limit		1.21					
krad	Serial #	PreTestHDR	PostTestHDR	Delta	Delta %	% of Limit Range	
0	1	1.567	1.568	0.00	0.01%	0.04%	
0	2	1.568	1.568	0.00	0.02%	0.07%	
0	3	1.567	1.568	0.00	0.03%	0.08%	
0	4	1.567	1.568	0.00	0.03%	0.09%	
10	5	1.567	1.567	0.00	-0.02%	0.05%	
10	6	1.567	1.567	0.00	0.02%	0.05%	
10	7	1.567	1.567	0.00	-0.01%	0.02%	
10	8	1.567	1.567	0.00	0.00%	0.00%	
10	9	1.567	1.567	0.00	-0.01%	0.03%	
20	10	1.567	1.567	0.00	0.00%	0.01%	
20	11	1.567	1.567	0.00	0.01%	0.03%	
20	12	1.567	1.567	0.00	0.00%	0.01%	
20	13	1.567	1.566	0.00	-0.01%	0.04%	
20	14	1.567	1.567	0.00	-0.01%	0.01%	
30	15	1.566	1.566	0.00	0.00%	0.00%	
30	16	1.567	1.566	0.00	-0.03%	0.10%	
30	17	1.567	1.566	0.00	-0.02%	0.04%	
30	18	1.567	1.567	0.00	-0.01%	0.02%	
30	19	1.567	1.567	0.00	-0.01%	0.03%	
30	20	1.567	1.566	0.00	-0.02%	0.06%	
31	15a	1.566	1.566	0.00	0.00%	0.00%	
31	16a	1.567	1.566	0.00	-0.04%	0.11%	
31	17a	1.567	1.566	0.00	-0.01%	0.03%	
31	18a	1.567	1.567	0.00	0.00%	0.01%	
31	19a	1.567	1.566	0.00	-0.03%	0.09%	
31	20a	1.567	1.566	0.00	-0.03%	0.10%	
50	21	1.567	1.566	0.00	-0.02%	0.05%	
50	22	1.567	1.566	0.00	-0.01%	0.04%	
50	23	1.567	1.566	0.00	-0.04%	0.11%	
50	24	1.567	1.566	0.00	-0.04%	0.12%	
50	25	1.567	1.566	0.00	-0.04%	0.11%	
Max		1.568	1.568	0.00	0.03%	0.12%	
Average		1.567	1.567	0.00	-0.01%	0.05%	
Min		1.566	1.566	0.00	-0.04%	0.00%	
Std Dev		0.000	0.000	0.00	0.02%	0.04%	

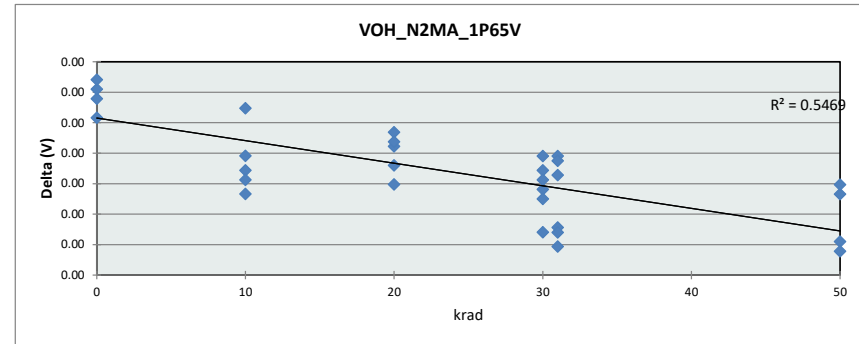

		VOH_N2MA_1P65V					
Units		V					
Max Limit		1.75					
Min Limit		1.21					
krad		0	10	20	30	31	50
LL		1.210	1.210	1.210	1.210	1.210	1.210
Min		1.568	1.567	1.566	1.566	1.566	1.566
Average		1.568	1.567	1.567	1.566	1.566	1.566
Max		1.568	1.567	1.567	1.567	1.567	1.566
UL		1.750	1.750	1.750	1.750	1.750	1.750

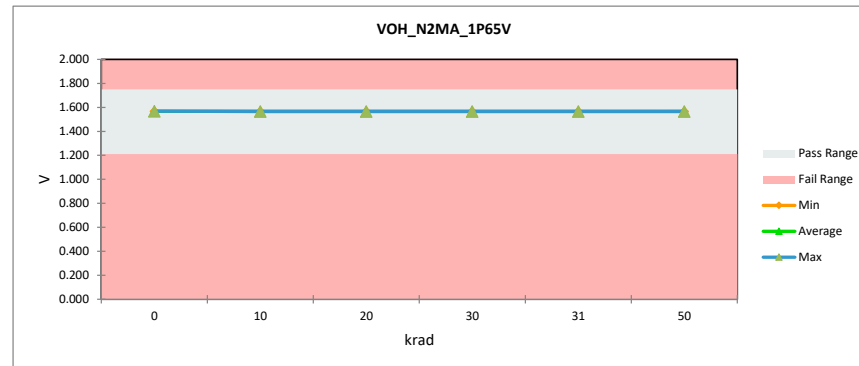

TID Report SN54SC8T541-SEP

		VOH_N3MA_2P25V					
Units		V					
Max Limit		2.35					
Min Limit		1.93					
krad	Serial #	PreTestHDR	PostTestHDR	Delta	Delta %	% of Limit Range	
0	1	2.154	2.154	0.00	0.00%	0.02%	
0	2	2.154	2.155	0.00	0.03%	0.14%	
0	3	2.154	2.154	0.00	0.02%	0.12%	
0	4	2.154	2.154	0.00	0.03%	0.15%	
10	5	2.154	2.154	0.00	0.01%	0.03%	
10	6	2.153	2.154	0.00	0.01%	0.06%	
10	7	2.153	2.154	0.00	0.01%	0.07%	
10	8	2.154	2.154	0.00	0.01%	0.03%	
10	9	2.153	2.153	0.00	0.00%	0.02%	
20	10	2.153	2.153	0.00	0.01%	0.07%	
20	11	2.153	2.153	0.00	0.01%	0.04%	
20	12	2.153	2.154	0.00	0.01%	0.05%	
20	13	2.153	2.153	0.00	0.01%	0.03%	
20	14	2.153	2.153	0.00	0.01%	0.03%	
30	15	2.153	2.153	0.00	0.01%	0.04%	
30	16	2.153	2.153	0.00	0.00%	0.02%	
30	17	2.153	2.153	0.00	0.00%	0.01%	
30	18	2.153	2.153	0.00	0.01%	0.04%	
30	19	2.153	2.153	0.00	0.00%	0.02%	
30	20	2.153	2.153	0.00	0.00%	0.01%	
31	15a	2.153	2.153	0.00	0.00%	0.02%	
31	16a	2.153	2.153	0.00	-0.01%	0.05%	
31	17a	2.153	2.153	0.00	0.00%	0.01%	
31	18a	2.153	2.153	0.00	0.00%	0.02%	
31	19a	2.153	2.153	0.00	-0.01%	0.04%	
31	20a	2.153	2.153	0.00	-0.02%	0.08%	
50	21	2.153	2.153	0.00	0.01%	0.03%	
50	22	2.153	2.153	0.00	0.01%	0.07%	
50	23	2.153	2.153	0.00	0.00%	0.01%	
50	24	2.153	2.153	0.00	-0.02%	0.12%	
50	25	2.153	2.153	0.00	0.00%	0.02%	
Max		2.154	2.155	0.00	0.03%	0.15%	
Average		2.153	2.153	0.00	0.00%	0.05%	
Min		2.153	2.153	0.00	-0.02%	0.01%	
Std Dev		0.000	0.000	0.00	0.01%	0.04%	

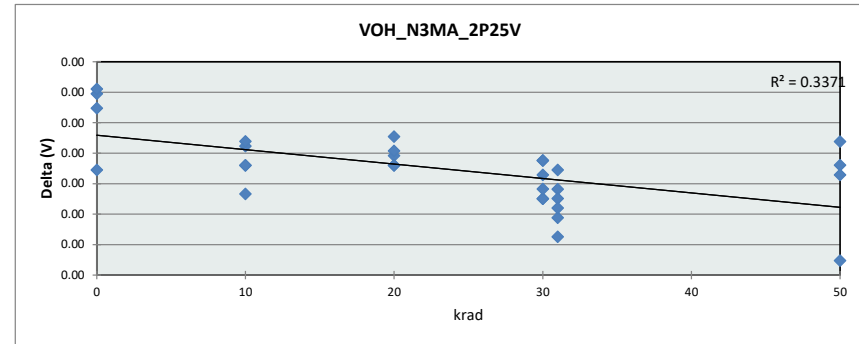

		VOH_N3MA_2P25V					
Units		V					
Max Limit		2.35					
Min Limit		1.93					
krad		0	10	20	30	31	50
LL		1.930	1.930	1.930	1.930	1.930	1.930
Min		2.154	2.153	2.153	2.153	2.153	2.153
Average		2.154	2.154	2.153	2.153	2.153	2.153
Max		2.155	2.154	2.154	2.153	2.153	2.153
UL		2.350	2.350	2.350	2.350	2.350	2.350

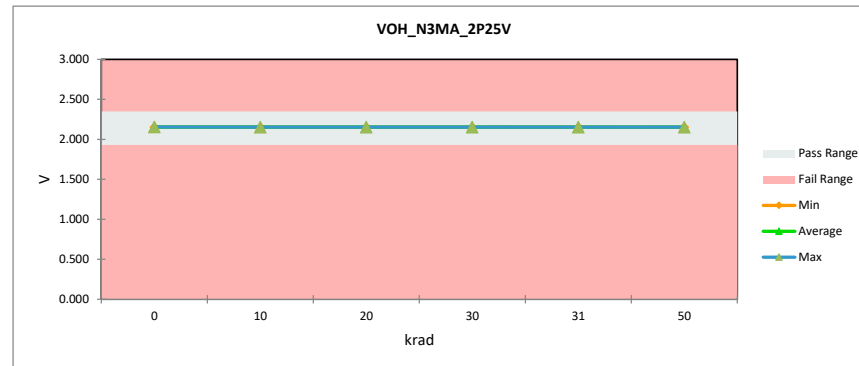

TID Report SN54SC8T541-SEP

		VOH_N5P5MA_3V				
Units		V				
Max Limit		3.1				
Min Limit		2.49				
krad	Serial #	PreTestHDR	PostTestHDR	Delta	Delta %	% of Limit Range
0	1	2.850	2.850	0.00	-0.01%	0.06%
0	2	2.851	2.851	0.00	0.00%	0.02%
0	3	2.850	2.850	0.00	0.00%	0.01%
0	4	2.850	2.850	0.00	0.01%	0.06%
10	5	2.850	2.849	0.00	-0.01%	0.05%
10	6	2.850	2.850	0.00	0.00%	0.00%
10	7	2.850	2.849	0.00	-0.01%	0.06%
10	8	2.850	2.849	0.00	-0.01%	0.06%
10	9	2.849	2.849	0.00	-0.02%	0.09%
20	10	2.849	2.849	0.00	-0.01%	0.05%
20	11	2.849	2.849	0.00	-0.02%	0.07%
20	12	2.849	2.849	0.00	-0.01%	0.04%
20	13	2.849	2.849	0.00	-0.02%	0.07%
20	14	2.849	2.849	0.00	-0.01%	0.06%
30	15	2.849	2.849	0.00	-0.01%	0.03%
30	16	2.849	2.849	0.00	-0.02%	0.10%
30	17	2.849	2.849	0.00	-0.02%	0.10%
30	18	2.849	2.849	0.00	-0.01%	0.07%
30	19	2.850	2.849	0.00	-0.02%	0.10%
30	20	2.849	2.849	0.00	-0.01%	0.06%
31	15a	2.849	2.849	0.00	-0.01%	0.05%
31	16a	2.849	2.849	0.00	-0.02%	0.11%
31	17a	2.849	2.849	0.00	-0.03%	0.12%
31	18a	2.849	2.849	0.00	-0.02%	0.10%
31	19a	2.850	2.849	0.00	-0.02%	0.11%
31	20a	2.849	2.848	0.00	-0.04%	0.18%
50	21	2.850	2.849	0.00	-0.02%	0.07%
50	22	2.849	2.849	0.00	-0.02%	0.08%
50	23	2.849	2.849	0.00	-0.02%	0.11%
50	24	2.849	2.848	0.00	-0.03%	0.15%
50	25	2.849	2.849	0.00	-0.02%	0.10%
Max		2.851	2.851	0.00	0.01%	0.18%
Average		2.849	2.849	0.00	-0.01%	0.07%
Min		2.849	2.848	0.00	-0.04%	0.00%
Std Dev		0.000	0.001	0.00	0.01%	0.04%

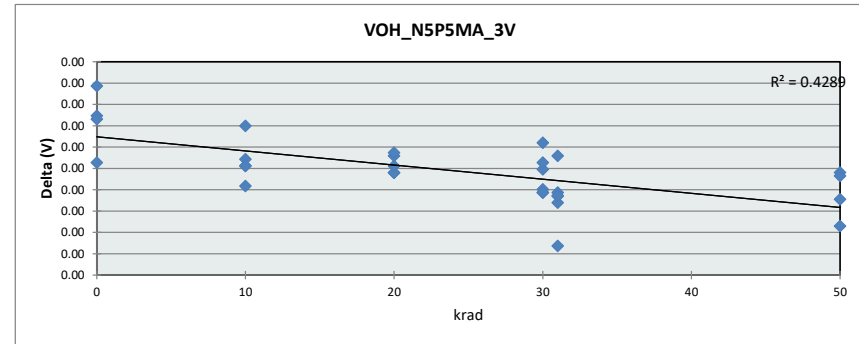

		VOH_N5P5MA_3V				
Units		V				
Max Limit		3.1				
Min Limit		2.49				
krad	0	10	20	30	31	50
LL	2.490	2.490	2.490	2.490	2.490	2.490
Min	2.850	2.849	2.849	2.849	2.848	2.848
Average	2.850	2.849	2.849	2.849	2.849	2.849
Max	2.851	2.850	2.849	2.849	2.849	2.849
UL	3.100	3.100	3.100	3.100	3.100	3.100

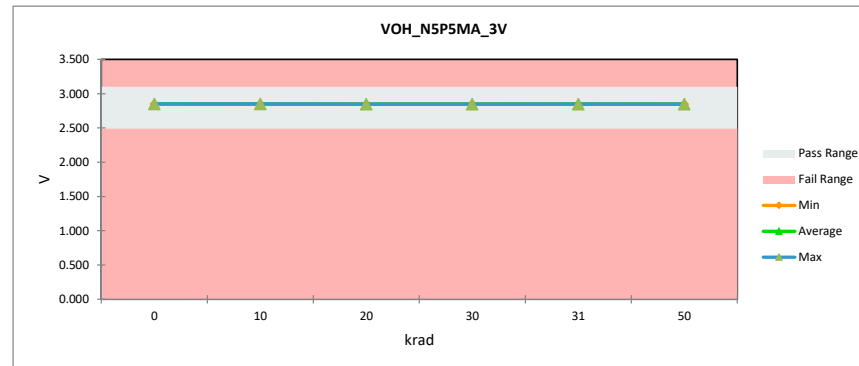

TID Report

SN54SC8T541-SEP

		VOH_N8MA_4P5V				
Units		V				
Max Limit		4.6				
Min Limit		3.95				
krad	Serial #	PreTestHDR	PostTestHDR	Delta	Delta %	% of Limit Range
0	1	4.315	4.315	0.00	-0.01%	0.04%
0	2	4.315	4.316	0.00	0.02%	0.10%
0	3	4.315	4.315	0.00	0.01%	0.04%
0	4	4.315	4.315	0.00	0.01%	0.09%
10	5	4.315	4.314	0.00	-0.01%	0.06%
10	6	4.315	4.315	0.00	0.00%	0.03%
10	7	4.315	4.315	0.00	0.00%	0.01%
10	8	4.314	4.314	0.00	-0.01%	0.04%
10	9	4.314	4.314	0.00	-0.01%	0.06%
20	10	4.314	4.314	0.00	0.00%	0.01%
20	11	4.314	4.314	0.00	0.00%	0.02%
20	12	4.314	4.314	0.00	-0.01%	0.04%
20	13	4.314	4.314	0.00	0.00%	0.01%
20	14	4.314	4.314	0.00	-0.01%	0.04%
30	15	4.314	4.314	0.00	0.00%	0.01%
30	16	4.315	4.314	0.00	-0.01%	0.07%
30	17	4.314	4.314	0.00	-0.01%	0.04%
30	18	4.314	4.314	0.00	0.00%	0.03%
30	19	4.315	4.314	0.00	-0.01%	0.06%
30	20	4.314	4.314	0.00	-0.01%	0.05%
31	15a	4.314	4.314	0.00	-0.01%	0.04%
31	16a	4.315	4.314	0.00	-0.02%	0.12%
31	17a	4.314	4.314	0.00	-0.02%	0.10%
31	18a	4.314	4.314	0.00	-0.01%	0.05%
31	19a	4.315	4.314	0.00	-0.02%	0.11%
31	20a	4.314	4.313	0.00	-0.03%	0.19%
50	21	4.315	4.314	0.00	0.00%	0.03%
50	22	4.314	4.314	0.00	0.00%	0.02%
50	23	4.314	4.314	0.00	-0.01%	0.07%
50	24	4.314	4.313	0.00	-0.02%	0.12%
50	25	4.314	4.314	0.00	-0.01%	0.05%
Max		4.315	4.316	0.00	0.02%	0.19%
Average		4.314	4.314	0.00	-0.01%	0.06%
Min		4.314	4.313	0.00	-0.03%	0.01%
Std Dev		0.000	0.001	0.00	0.01%	0.04%

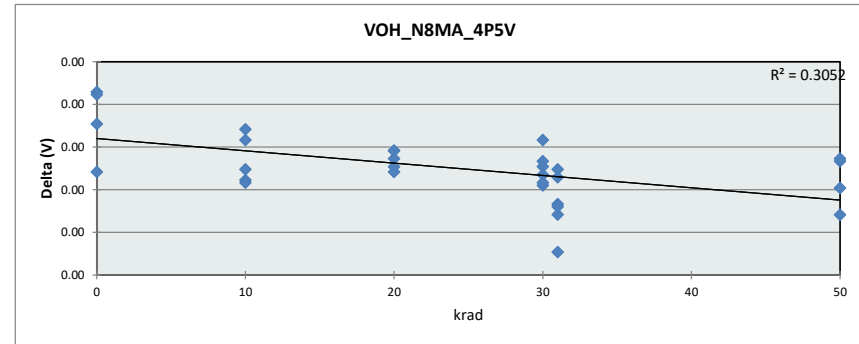

		VOH_N8MA_4P5V				
Units		V				
Max Limit		4.6				
Min Limit		3.95				
krad	0	10	20	30	31	50
LL	3.950	3.950	3.950	3.950	3.950	3.950
Min	4.315	4.314	4.314	4.314	4.313	4.313
Average	4.315	4.314	4.314	4.314	4.314	4.314
Max	4.316	4.315	4.314	4.314	4.314	4.314
UL	4.600	4.600	4.600	4.600	4.600	4.600

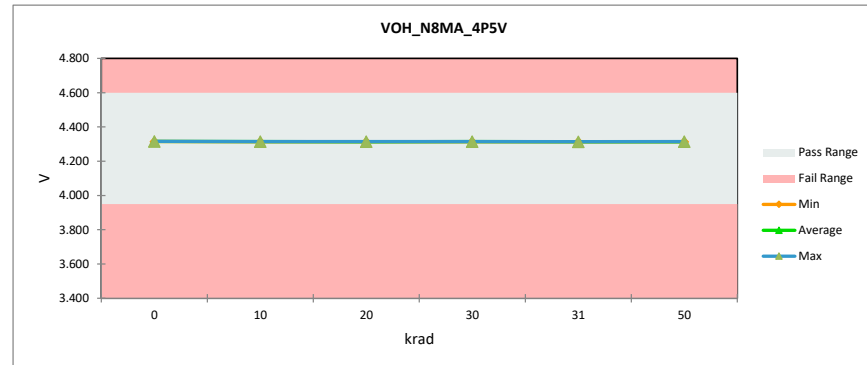

TID Report

SN54SC8T541-SEP

		VOH_N24MA_5P5V					
		V					
		5.6					
		3.15					
krad	Serial #	PreTestHDR	PostTestHDR	Delta	Delta %	% of Limit Range	
0	1	4.969	4.967	0.00	-0.02%	0.04%	
0	2	4.969	4.970	0.00	0.01%	0.02%	
0	3	4.968	4.968	0.00	0.00%	0.00%	
0	4	4.967	4.968	0.00	0.02%	0.05%	
10	5	4.967	4.966	0.00	-0.03%	0.06%	
10	6	4.967	4.966	0.00	-0.01%	0.02%	
10	7	4.967	4.966	0.00	-0.02%	0.03%	
10	8	4.967	4.965	0.00	-0.04%	0.07%	
10	9	4.966	4.964	0.00	-0.05%	0.10%	
20	10	4.965	4.964	0.00	-0.01%	0.03%	
20	11	4.966	4.964	0.00	-0.03%	0.05%	
20	12	4.966	4.964	0.00	-0.03%	0.06%	
20	13	4.965	4.964	0.00	-0.02%	0.05%	
20	14	4.965	4.963	0.00	-0.03%	0.06%	
30	15	4.964	4.964	0.00	-0.01%	0.01%	
30	16	4.966	4.964	0.00	-0.04%	0.09%	
30	17	4.966	4.965	0.00	-0.03%	0.06%	
30	18	4.966	4.965	0.00	-0.03%	0.06%	
30	19	4.967	4.965	0.00	-0.03%	0.07%	
30	20	4.966	4.965	0.00	-0.03%	0.06%	
31	15a	4.964	4.963	0.00	-0.02%	0.05%	
31	16a	4.966	4.964	0.00	-0.05%	0.09%	
31	17a	4.966	4.964	0.00	-0.05%	0.09%	
31	18a	4.966	4.964	0.00	-0.04%	0.07%	
31	19a	4.967	4.964	0.00	-0.05%	0.11%	
31	20a	4.966	4.962	0.00	-0.09%	0.18%	
50	21	4.967	4.966	0.00	-0.02%	0.04%	
50	22	4.966	4.965	0.00	-0.02%	0.04%	
50	23	4.966	4.965	0.00	-0.02%	0.05%	
50	24	4.966	4.962	0.00	-0.07%	0.15%	
50	25	4.966	4.964	0.00	-0.04%	0.09%	
Max		4.969	4.970	0.00	0.02%	0.18%	
Average		4.966	4.965	0.00	-0.03%	0.06%	
Min		4.964	4.962	0.00	-0.09%	0.00%	
Std Dev		0.001	0.002	0.00	0.02%	0.04%	

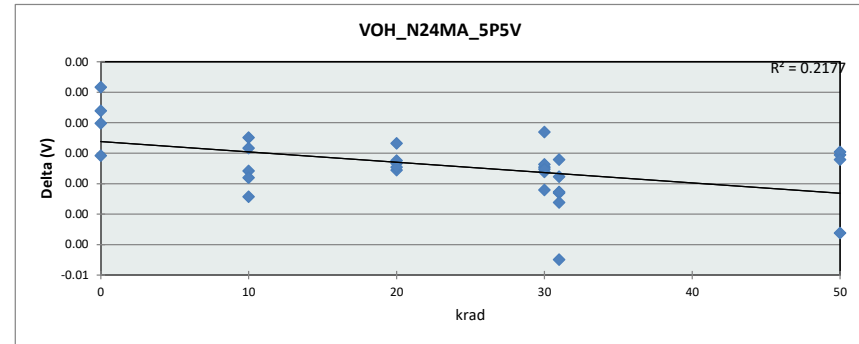

		VOH_N24MA_5P5V					
		V					
		5.6					
		3.15					
krad		0	10	20	30	31	50
LL		3.150	3.150	3.150	3.150	3.150	3.150
Min		4.967	4.964	4.963	4.964	4.962	4.962
Average		4.968	4.965	4.964	4.965	4.964	4.964
Max		4.970	4.966	4.964	4.965	4.964	4.966
UL		5.600	5.600	5.600	5.600	5.600	5.600

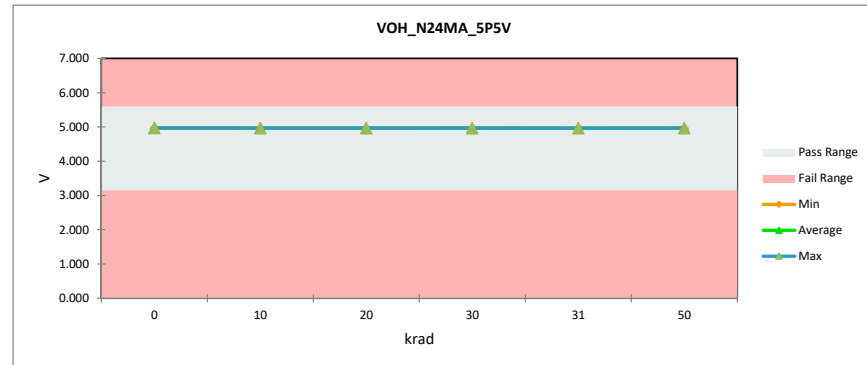

TID Report

SN54SC8T541-SEP

		VOH_N50UA_1P2V					
Units		V					
Max Limit		1.3					
Min Limit		1					
krad	Serial #	PreTestHDR	PostTestHDR	Delta	Delta %	% of Limit Range	
0	1	1.196	1.197	0.00	0.04%	0.14%	
0	2	1.196	1.197	0.00	0.03%	0.13%	
0	3	1.196	1.197	0.00	0.02%	0.09%	
0	4	1.197	1.197	0.00	0.02%	0.09%	
10	5	1.196	1.197	0.00	0.02%	0.07%	
10	6	1.196	1.197	0.00	0.02%	0.10%	
10	7	1.196	1.197	0.00	0.02%	0.08%	
10	8	1.196	1.197	0.00	0.02%	0.10%	
10	9	1.197	1.197	0.00	0.01%	0.03%	
20	10	1.197	1.197	0.00	0.02%	0.07%	
20	11	1.196	1.197	0.00	0.03%	0.10%	
20	12	1.196	1.197	0.00	0.01%	0.04%	
20	13	1.196	1.197	0.00	0.03%	0.12%	
20	14	1.196	1.197	0.00	0.02%	0.10%	
30	15	1.196	1.197	0.00	0.01%	0.06%	
30	16	1.197	1.197	0.00	0.02%	0.08%	
30	17	1.197	1.197	0.00	0.01%	0.04%	
30	18	1.196	1.197	0.00	0.03%	0.13%	
30	19	1.196	1.197	0.00	0.02%	0.08%	
30	20	1.196	1.197	0.00	0.01%	0.05%	
31	15a	1.196	1.196	0.00	0.00%	0.00%	
31	16a	1.197	1.197	0.00	0.01%	0.04%	
31	17a	1.197	1.197	0.00	0.01%	0.04%	
31	18a	1.196	1.197	0.00	0.02%	0.08%	
31	19a	1.196	1.197	0.00	0.01%	0.04%	
31	20a	1.196	1.197	0.00	0.02%	0.08%	
50	21	1.196	1.197	0.00	0.03%	0.10%	
50	22	1.196	1.197	0.00	0.01%	0.05%	
50	23	1.196	1.197	0.00	0.02%	0.06%	
50	24	1.196	1.197	0.00	0.02%	0.07%	
50	25	1.196	1.197	0.00	0.01%	0.05%	
Max		1.197	1.197	0.00	0.04%	0.14%	
Average		1.196	1.197	0.00	0.02%	0.08%	
Min		1.196	1.196	0.00	0.00%	0.00%	
Std Dev		0.000	0.000	0.00	0.01%	0.03%	

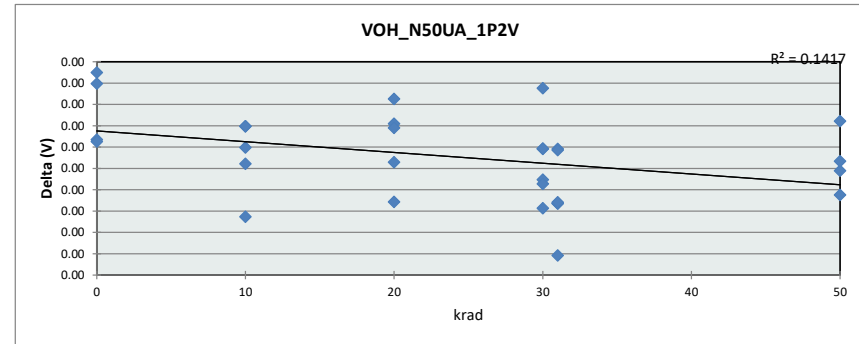

		VOH_N50UA_1P2V					
Units		V					
Max Limit		1.3					
Min Limit		1					
krad		0	10	20	30	31	50
LL		1.000	1.000	1.000	1.000	1.000	1.000
Min		1.197	1.197	1.197	1.197	1.196	1.197
Average		1.197	1.197	1.197	1.197	1.197	1.197
Max		1.197	1.197	1.197	1.197	1.197	1.197
UL		1.300	1.300	1.300	1.300	1.300	1.300

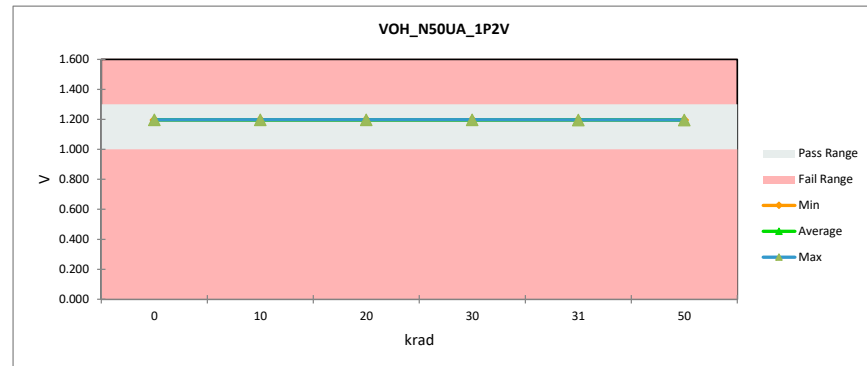

TID Report SN54SC8T541-SEP

		VOH_N50UA_5P5V					
Units		V					
Max Limit		5.6					
Min Limit		5.3					
krad	Serial #	PreTestHDR	PostTestHDR	Delta	Delta %	% of Limit Range	
0	1	5.498	5.499	0.00	0.01%	0.18%	
0	2	5.498	5.499	0.00	0.01%	0.15%	
0	3	5.498	5.499	0.00	0.01%	0.17%	
0	4	5.498	5.499	0.00	0.01%	0.17%	
10	5	5.498	5.499	0.00	0.01%	0.20%	
10	6	5.498	5.499	0.00	0.01%	0.16%	
10	7	5.498	5.499	0.00	0.01%	0.14%	
10	8	5.498	5.499	0.00	0.01%	0.17%	
10	9	5.498	5.499	0.00	0.01%	0.21%	
20	10	5.498	5.499	0.00	0.01%	0.15%	
20	11	5.498	5.499	0.00	0.01%	0.23%	
20	12	5.498	5.499	0.00	0.01%	0.24%	
20	13	5.498	5.499	0.00	0.01%	0.14%	
20	14	5.498	5.499	0.00	0.01%	0.18%	
30	15	5.498	5.499	0.00	0.01%	0.21%	
30	16	5.498	5.498	0.00	0.01%	0.13%	
30	17	5.498	5.498	0.00	0.01%	0.12%	
30	18	5.498	5.498	0.00	0.01%	0.11%	
30	19	5.498	5.499	0.00	0.01%	0.13%	
30	20	5.498	5.499	0.00	0.01%	0.17%	
31	15a	5.498	5.499	0.00	0.01%	0.17%	
31	16a	5.498	5.499	0.00	0.01%	0.18%	
31	17a	5.498	5.499	0.00	0.01%	0.17%	
31	18a	5.498	5.499	0.00	0.01%	0.14%	
31	19a	5.498	5.499	0.00	0.01%	0.14%	
31	20a	5.498	5.498	0.00	0.01%	0.14%	
50	21	5.498	5.498	0.00	0.01%	0.13%	
50	22	5.498	5.499	0.00	0.01%	0.24%	
50	23	5.498	5.498	0.00	0.01%	0.15%	
50	24	5.498	5.499	0.00	0.01%	0.19%	
50	25	5.498	5.498	0.00	0.01%	0.14%	
Max		5.498	5.499	0.00	0.01%	0.24%	
Average		5.498	5.499	0.00	0.01%	0.17%	
Min		5.498	5.498	0.00	0.01%	0.11%	
Std Dev		0.000	0.000	0.00	0.00%	0.03%	

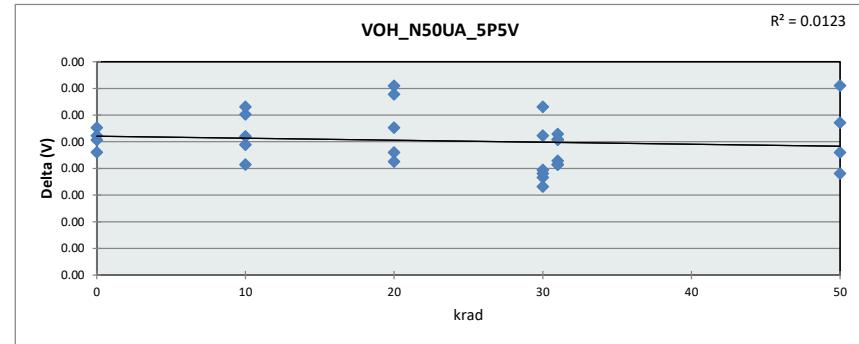

		VOH_N50UA_5P5V					
Units		V					
Max Limit		5.6					
Min Limit		5.3					
krad		0	10	20	30	31	50
LL		5.300	5.300	5.300	5.300	5.300	5.300
Min		5.499	5.499	5.499	5.498	5.498	5.498
Average		5.499	5.499	5.499	5.499	5.499	5.499
Max		5.499	5.499	5.499	5.499	5.499	5.499
UL		5.600	5.600	5.600	5.600	5.600	5.600

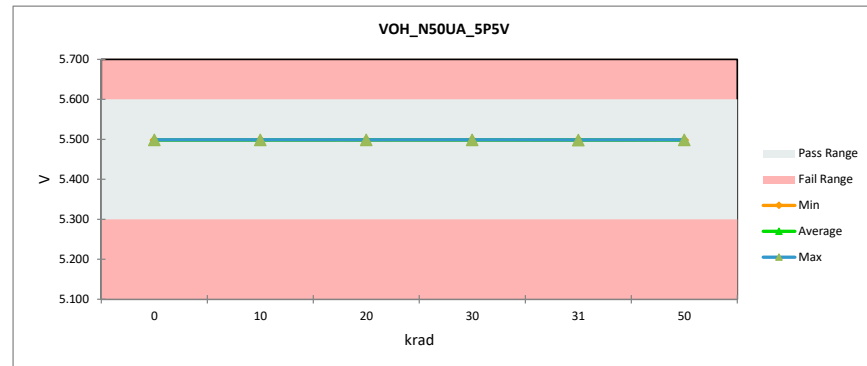

TID Report

SN54SC8T541-SEP

		VOL_1MA_1P2V				
Units		V				
Max Limit		0.2				
Min Limit		-0.001				
krad	Serial #	PreTestHDR	PostTestHDR	Delta	Delta %	% of Limit Range
0	1	0.047	0.048	0.00	0.67%	0.16%
0	2	0.047	0.048	0.00	0.67%	0.16%
0	3	0.047	0.048	0.00	0.87%	0.20%
0	4	0.048	0.048	0.00	0.61%	0.14%
10	5	0.048	0.048	0.00	-0.12%	0.03%
10	6	0.048	0.048	0.00	-0.19%	0.04%
10	7	0.048	0.048	0.00	0.06%	0.01%
10	8	0.048	0.048	0.00	0.08%	0.02%
10	9	0.048	0.048	0.00	0.34%	0.08%
20	10	0.048	0.048	0.00	-0.12%	0.03%
20	11	0.048	0.048	0.00	-0.18%	0.04%
20	12	0.048	0.048	0.00	-0.05%	0.01%
20	13	0.048	0.048	0.00	-0.24%	0.06%
20	14	0.048	0.048	0.00	-0.18%	0.04%
30	15	0.048	0.049	0.00	2.27%	0.54%
30	16	0.048	0.049	0.00	3.49%	0.83%
30	17	0.048	0.048	0.00	1.40%	0.33%
30	18	0.048	0.050	0.00	3.88%	0.92%
30	19	0.048	0.049	0.00	2.10%	0.50%
30	20	0.048	0.048	0.00	1.06%	0.25%
31	15a	0.048	0.048	0.00	-0.60%	0.14%
31	16a	0.048	0.048	0.00	0.07%	0.02%
31	17a	0.048	0.048	0.00	-0.21%	0.05%
31	18a	0.048	0.048	0.00	-0.06%	0.01%
31	19a	0.048	0.048	0.00	-0.45%	0.11%
31	20a	0.048	0.047	0.00	-0.58%	0.14%
50	21	0.048	1.255	1.21	2526.27%	600.81%
50	22	0.048	1.255	1.21	2538.34%	600.92%
50	23	0.047	1.255	1.21	2545.35%	601.00%
50	24	0.047	1.256	1.21	2545.79%	601.10%
50	25	0.048	1.256	1.21	2532.77%	600.96%
	Max	0.048	1.256	1.21	2545.79%	601.10%
	Average	0.048	0.209	0.16	339.01%	80.29%
	Min	0.047	0.047	0.00	-0.60%	0.01%
	Std Dev	0.000	0.417	0.42	877.64%	207.71%

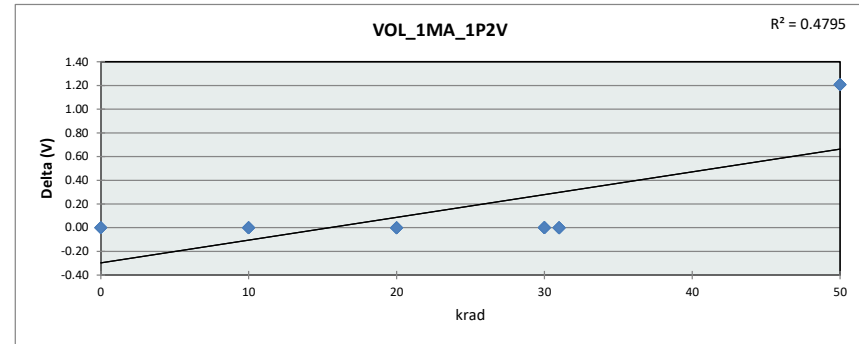

		VOL_1MA_1P2V					
Units		V					
Max Limit		0.2					
Min Limit		-0.001					
krad		0	10	20	30	31	50
LL		-0.001	-0.001	-0.001	-0.001	-0.001	-0.001
Min		0.048	0.048	0.048	0.048	0.047	1.255
Average		0.048	0.048	0.048	0.049	0.048	1.256
Max		0.048	0.048	0.048	0.050	0.048	1.256
UL		0.200	0.200	0.200	0.200	0.200	0.200

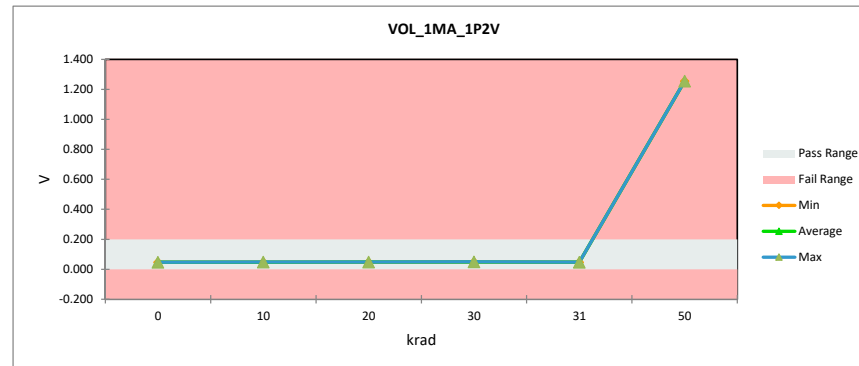

TID Report

SN54SC8T541-SEP

		VOL_2MA_1P65V				
Units		V				
Max Limit		0.25				
Min Limit		-0.001				
krad	Serial #	PreTestHDR	PostTestHDR	Delta	Delta %	% of Limit Range
0	1	0.060	0.060	0.00	0.50%	0.12%
0	2	0.060	0.060	0.00	0.13%	0.03%
0	3	0.059	0.060	0.00	0.45%	0.11%
0	4	0.060	0.060	0.00	0.45%	0.11%
10	5	0.060	0.060	0.00	0.44%	0.11%
10	6	0.060	0.060	0.00	0.18%	0.04%
10	7	0.060	0.060	0.00	0.03%	0.01%
10	8	0.060	0.060	0.00	0.39%	0.09%
10	9	0.060	0.060	0.00	0.65%	0.16%
20	10	0.060	0.060	0.00	0.18%	0.04%
20	11	0.060	0.060	0.00	0.18%	0.04%
20	12	0.060	0.060	0.00	0.13%	0.03%
20	13	0.060	0.061	0.00	0.76%	0.18%
20	14	0.060	0.060	0.00	0.29%	0.07%
30	15	0.060	0.061	0.00	1.12%	0.27%
30	16	0.060	0.061	0.00	1.49%	0.36%
30	17	0.060	0.061	0.00	0.94%	0.23%
30	18	0.060	0.061	0.00	1.59%	0.38%
30	19	0.060	0.061	0.00	1.48%	0.36%
30	20	0.060	0.061	0.00	0.71%	0.17%
31	15a	0.060	0.061	0.00	0.50%	0.12%
31	16a	0.060	0.060	0.00	0.55%	0.13%
31	17a	0.060	0.060	0.00	0.34%	0.08%
31	18a	0.060	0.061	0.00	0.39%	0.09%
31	19a	0.060	0.061	0.00	0.55%	0.13%
31	20a	0.060	0.060	0.00	0.39%	0.09%
50	21	0.060	0.925	0.86	1437.44%	344.42%
50	22	0.060	0.940	0.88	1466.19%	350.41%
50	23	0.060	0.940	0.88	1470.99%	350.81%
50	24	0.060	0.952	0.89	1493.18%	355.36%
50	25	0.060	0.946	0.89	1472.44%	352.81%
Max		0.060	0.952	0.89	1493.18%	355.36%
Average		0.060	0.178	0.12	196.09%	46.82%
Min		0.059	0.060	0.00	0.03%	0.01%
Std Dev		0.000	0.304	0.30	507.05%	121.06%

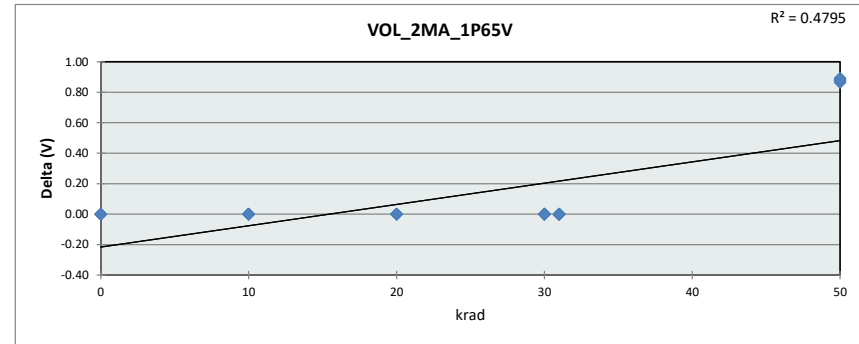

		VOL_2MA_1P65V				
Units		V				
Max Limit		0.25				
Min Limit		-0.001				
krad	0	10	20	30	31	50
LL	-0.001	-0.001	-0.001	-0.001	-0.001	-0.001
Min	0.060	0.060	0.060	0.061	0.060	0.925
Average	0.060	0.060	0.060	0.061	0.060	0.940
Max	0.060	0.060	0.061	0.061	0.061	0.952
UL	0.250	0.250	0.250	0.250	0.250	0.250

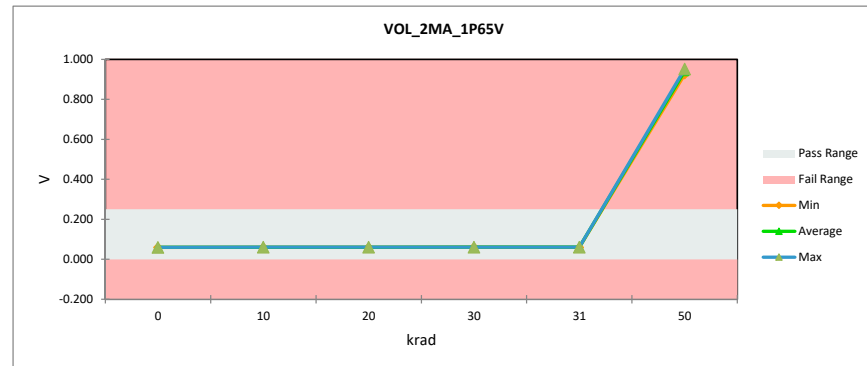

TID Report SN54SC8T541-SEP

		VOL_3MA_2P25V				
Units		V				
Max Limit		0.2				
Min Limit		-0.001				
krad	Serial #	PreTestHDR	PostTestHDR	Delta	Delta %	% of Limit Range
0	1	0.069	0.069	0.00	0.45%	0.15%
0	2	0.069	0.069	0.00	0.13%	0.04%
0	3	0.069	0.069	0.00	0.49%	0.17%
0	4	0.069	0.070	0.00	0.54%	0.18%
10	5	0.070	0.070	0.00	0.71%	0.25%
10	6	0.070	0.070	0.00	0.31%	0.11%
10	7	0.070	0.070	0.00	0.31%	0.11%
10	8	0.070	0.070	0.00	0.71%	0.25%
10	9	0.070	0.070	0.00	0.49%	0.17%
20	10	0.070	0.070	0.00	0.35%	0.12%
20	11	0.070	0.070	0.00	0.44%	0.15%
20	12	0.070	0.070	0.00	0.44%	0.15%
20	13	0.070	0.070	0.00	0.98%	0.34%
20	14	0.070	0.070	0.00	0.53%	0.18%
30	15	0.070	0.070	0.00	0.63%	0.22%
30	16	0.070	0.070	0.00	0.85%	0.29%
30	17	0.070	0.070	0.00	0.67%	0.23%
30	18	0.070	0.071	0.00	0.93%	0.33%
30	19	0.070	0.071	0.00	0.89%	0.31%
30	20	0.070	0.070	0.00	0.71%	0.25%
31	15a	0.070	0.070	0.00	0.35%	0.12%
31	16a	0.070	0.070	0.00	0.85%	0.29%
31	17a	0.070	0.070	0.00	0.58%	0.20%
31	18a	0.070	0.070	0.00	0.31%	0.11%
31	19a	0.070	0.070	0.00	0.31%	0.11%
31	20a	0.070	0.070	0.00	0.53%	0.18%
50	21	0.070	0.074	0.00	6.44%	2.24%
50	22	0.070	0.075	0.01	7.49%	2.60%
50	23	0.069	0.074	0.00	7.02%	2.43%
50	24	0.069	0.076	0.01	9.15%	3.16%
50	25	0.070	0.075	0.01	7.29%	2.53%
Max		0.070	0.076	0.01	9.15%	3.16%
Average		0.070	0.071	0.00	1.49%	0.51%
Min		0.069	0.069	0.00	0.13%	0.04%
Std Dev		0.000	0.002	0.00	2.45%	0.85%

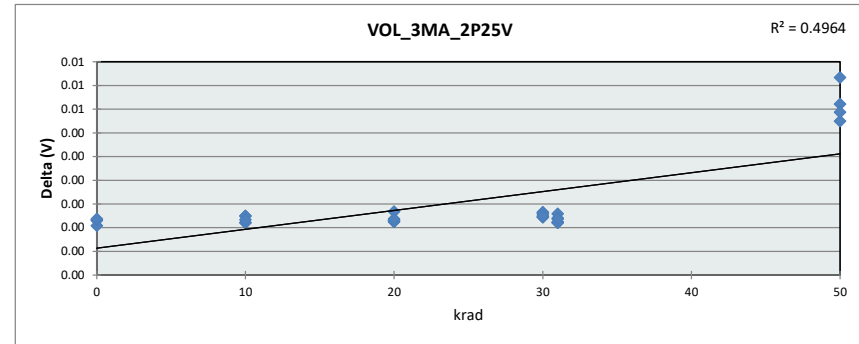

		VOL_3MA_2P25V				
Units		V				
Max Limit		0.2				
Min Limit		-0.001				
krad	LL	Min	Average	Max	UL	
0	-0.001	0.069	0.070	0.070	0.200	
10	-0.001	0.070	0.070	0.070	0.200	
20	-0.001	0.070	0.070	0.070	0.200	
30	-0.001	0.070	0.070	0.071	0.200	
31	-0.001	0.070	0.070	0.070	0.200	
50	-0.001	0.074	0.075	0.076	0.200	

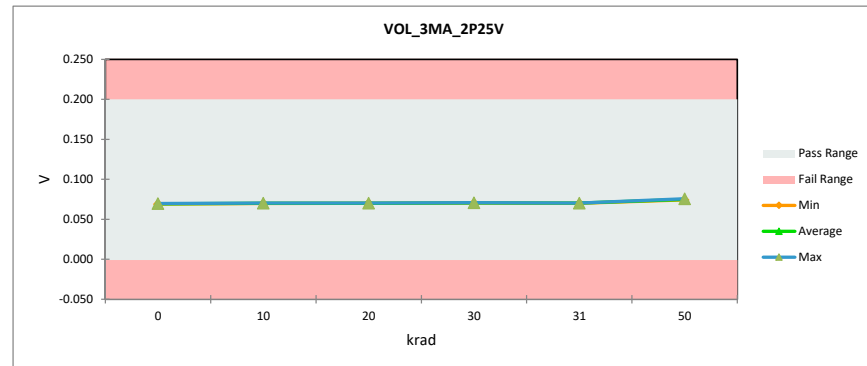

TID Report

SN54SC8T541-SEP

		VOL_5P5MA_3V					
		V					
		0.25					
		-0.001					
krad	Serial #	PreTestHDR	PostTestHDR	Delta	Delta %	% of Limit Range	
0	1	0.109	0.109	0.00	0.29%	0.13%	
0	2	0.108	0.109	0.00	0.35%	0.15%	
0	3	0.108	0.108	0.00	0.35%	0.15%	
0	4	0.109	0.109	0.00	0.15%	0.07%	
10	5	0.110	0.110	0.00	0.35%	0.15%	
10	6	0.109	0.110	0.00	0.44%	0.19%	
10	7	0.110	0.110	0.00	0.16%	0.07%	
10	8	0.109	0.110	0.00	0.35%	0.15%	
10	9	0.109	0.110	0.00	0.26%	0.12%	
20	10	0.110	0.110	0.00	0.15%	0.07%	
20	11	0.110	0.110	0.00	0.24%	0.10%	
20	12	0.110	0.110	0.00	0.18%	0.08%	
20	13	0.110	0.110	0.00	0.41%	0.18%	
20	14	0.109	0.110	0.00	0.44%	0.19%	
30	15	0.110	0.111	0.00	0.52%	0.23%	
30	16	0.110	0.110	0.00	0.61%	0.27%	
30	17	0.110	0.110	0.00	0.38%	0.17%	
30	18	0.110	0.110	0.00	0.41%	0.18%	
30	19	0.110	0.111	0.00	0.44%	0.19%	
30	20	0.110	0.110	0.00	0.52%	0.23%	
31	15a	0.110	0.110	0.00	0.43%	0.19%	
31	16a	0.110	0.110	0.00	0.38%	0.17%	
31	17a	0.110	0.110	0.00	0.55%	0.24%	
31	18a	0.110	0.110	0.00	0.29%	0.13%	
31	19a	0.110	0.111	0.00	0.45%	0.20%	
31	20a	0.110	0.110	0.00	0.49%	0.22%	
50	21	0.110	0.113	0.00	3.26%	1.42%	
50	22	0.110	0.114	0.00	3.63%	1.59%	
50	23	0.109	0.113	0.00	3.67%	1.60%	
50	24	0.109	0.115	0.01	5.47%	2.38%	
50	25	0.110	0.114	0.00	3.94%	1.72%	
	Max	0.110	0.115	0.01	5.47%	2.38%	
	Average	0.110	0.110	0.00	0.85%	0.37%	
	Min	0.108	0.108	0.00	0.15%	0.07%	
	Std Dev	0.000	0.001	0.00	1.30%	0.57%	

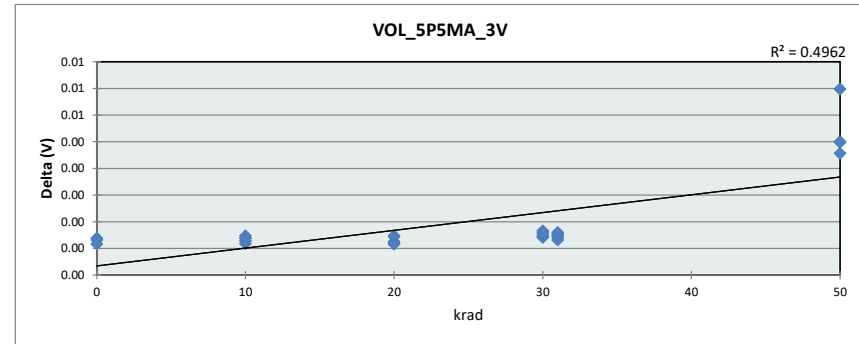

		VOL_5P5MA_3V					
		V					
		0.25					
		-0.001					
krad		0	10	20	30	31	50
LL		-0.001	-0.001	-0.001	-0.001	-0.001	-0.001
Min		0.108	0.110	0.110	0.110	0.110	0.113
Average		0.109	0.110	0.110	0.110	0.110	0.114
Max		0.109	0.110	0.110	0.111	0.111	0.115
UL		0.250	0.250	0.250	0.250	0.250	0.250

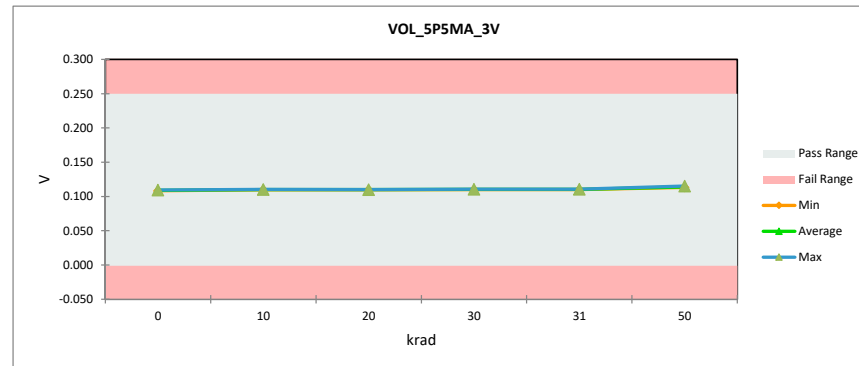

TID Report

SN54SC8T541-SEP

		VOL_8MA_4P5V					
Units		V					
Max Limit		0.35					
Min Limit		-0.001					
krad	Serial #	PreTestHDR	PostTestHDR	Delta	Delta %	% of Limit Range	
0	1	0.138	0.138	0.00	0.12%	0.05%	
0	2	0.137	0.138	0.00	0.28%	0.11%	
0	3	0.137	0.137	0.00	0.26%	0.10%	
0	4	0.139	0.139	0.00	0.01%	0.00%	
10	5	0.139	0.139	0.00	0.27%	0.11%	
10	6	0.139	0.139	0.00	0.28%	0.11%	
10	7	0.139	0.139	0.00	0.14%	0.06%	
10	8	0.138	0.139	0.00	0.32%	0.13%	
10	9	0.139	0.139	0.00	0.07%	0.03%	
20	10	0.139	0.139	0.00	0.10%	0.04%	
20	11	0.139	0.139	0.00	0.16%	0.07%	
20	12	0.139	0.139	0.00	0.25%	0.10%	
20	13	0.139	0.139	0.00	0.31%	0.12%	
20	14	0.138	0.139	0.00	0.32%	0.13%	
30	15	0.139	0.140	0.00	0.27%	0.11%	
30	16	0.139	0.139	0.00	0.41%	0.16%	
30	17	0.139	0.139	0.00	0.23%	0.09%	
30	18	0.139	0.139	0.00	0.19%	0.07%	
30	19	0.139	0.140	0.00	0.76%	0.30%	
30	20	0.139	0.140	0.00	0.30%	0.12%	
31	15a	0.139	0.140	0.00	0.37%	0.15%	
31	16a	0.139	0.139	0.00	0.46%	0.18%	
31	17a	0.139	0.139	0.00	0.34%	0.14%	
31	18a	0.139	0.140	0.00	0.46%	0.18%	
31	19a	0.139	0.140	0.00	0.47%	0.19%	
31	20a	0.139	0.140	0.00	0.49%	0.20%	
50	21	0.139	0.141	0.00	1.42%	0.56%	
50	22	0.139	0.141	0.00	1.64%	0.65%	
50	23	0.139	0.141	0.00	1.79%	0.71%	
50	24	0.138	0.143	0.00	3.26%	1.29%	
50	25	0.139	0.142	0.00	2.09%	0.83%	
Max		0.139	0.143	0.00	3.26%	1.29%	
Average		0.139	0.139	0.00	0.53%	0.21%	
Min		0.137	0.137	0.00	0.01%	0.00%	
Std Dev		0.001	0.001	0.00	0.67%	0.27%	

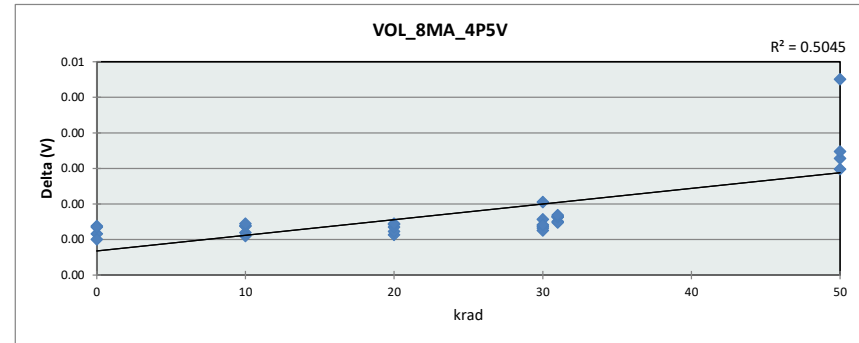

		VOL_8MA_4P5V					
Units		V					
Max Limit		0.35					
Min Limit		-0.001					
krad	0	10	20	30	31	50	
LL	-0.001	-0.001	-0.001	-0.001	-0.001	-0.001	-0.001
Min	0.137	0.139	0.139	0.139	0.139	0.141	0.141
Average	0.138	0.139	0.139	0.140	0.140	0.142	0.142
Max	0.139	0.139	0.139	0.140	0.140	0.143	0.143
UL	0.350	0.350	0.350	0.350	0.350	0.350	0.350

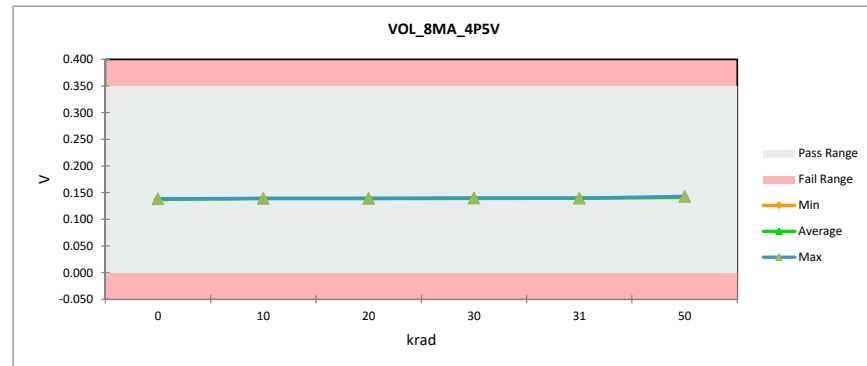

TID Report

SN54SC8T541-SEP

		VOL_24MA_5P5V				
Units		V				
Max Limit		0.75				
Min Limit		-0.001				
krad	Serial #	PreTestHDR	PostTestHDR	Delta	Delta %	% of Limit Range
0	1	0.398	0.398	0.00	-0.02%	0.01%
0	2	0.397	0.397	0.00	-0.01%	0.00%
0	3	0.396	0.396	0.00	0.08%	0.04%
0	4	0.401	0.401	0.00	-0.08%	0.04%
10	5	0.402	0.402	0.00	0.02%	0.01%
10	6	0.402	0.402	0.00	0.06%	0.03%
10	7	0.402	0.402	0.00	-0.07%	0.04%
10	8	0.401	0.402	0.00	0.15%	0.08%
10	9	0.402	0.402	0.00	0.13%	0.07%
20	10	0.402	0.402	0.00	0.00%	0.00%
20	11	0.402	0.403	0.00	0.16%	0.09%
20	12	0.402	0.402	0.00	0.08%	0.04%
20	13	0.402	0.403	0.00	0.21%	0.11%
20	14	0.400	0.401	0.00	0.16%	0.09%
30	15	0.402	0.403	0.00	0.21%	0.11%
30	16	0.401	0.402	0.00	0.15%	0.08%
30	17	0.402	0.402	0.00	0.12%	0.06%
30	18	0.403	0.403	0.00	0.00%	0.00%
30	19	0.403	0.404	0.00	0.36%	0.19%
30	20	0.402	0.403	0.00	0.08%	0.04%
31	15a	0.402	0.403	0.00	0.29%	0.15%
31	16a	0.401	0.403	0.00	0.39%	0.21%
31	17a	0.402	0.403	0.00	0.26%	0.14%
31	18a	0.403	0.403	0.00	0.22%	0.12%
31	19a	0.403	0.403	0.00	0.23%	0.12%
31	20a	0.402	0.403	0.00	0.30%	0.16%
50	21	0.402	0.405	0.00	0.79%	0.42%
50	22	0.402	0.405	0.00	0.78%	0.42%
50	23	0.401	0.405	0.00	0.85%	0.46%
50	24	0.401	0.409	0.01	2.10%	1.12%
50	25	0.402	0.407	0.00	1.12%	0.60%
Max		0.403	0.409	0.01	2.10%	1.12%
Average		0.401	0.402	0.00	0.27%	0.15%
Min		0.396	0.396	0.00	-0.08%	0.00%
Std Dev		0.002	0.002	0.00	0.42%	0.22%

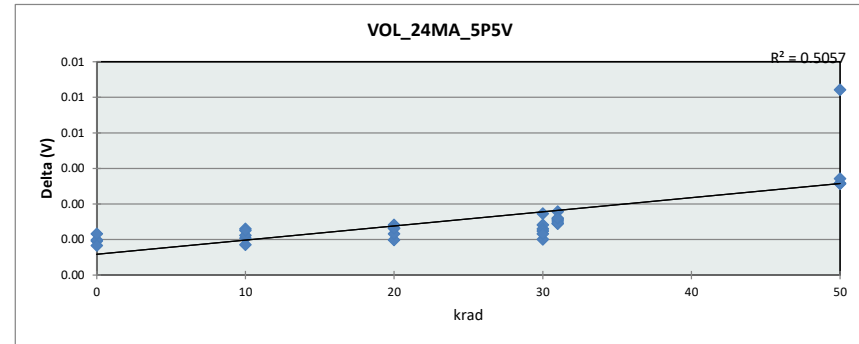

		VOL_24MA_5P5V				
Units		V				
Max Limit		0.75				
Min Limit		-0.001				
krad	0	10	20	30	31	50
LL	-0.001	-0.001	-0.001	-0.001	-0.001	-0.001
Min	0.396	0.402	0.401	0.402	0.403	0.405
Average	0.398	0.402	0.402	0.403	0.403	0.406
Max	0.401	0.402	0.403	0.404	0.403	0.409
UL	0.750	0.750	0.750	0.750	0.750	0.750

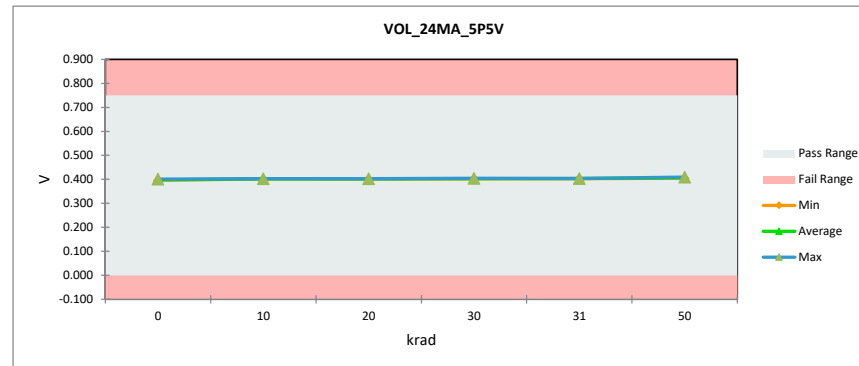

TID Report

SN54SC8T541-SEP

		VOL_50UA_1P2V					
Units		V					
Max Limit		0.1					
Min Limit		-0.001					
krad	Serial #	PreTestHDR	PostTestHDR	Delta	Delta %	% of Limit Range	
0	1	0.002	0.002	0.00	14.97%	0.31%	
0	2	0.002	0.002	0.00	5.91%	0.13%	
0	3	0.002	0.002	0.00	0.01%	0.00%	
0	4	0.002	0.002	0.00	2.31%	0.05%	
10	5	0.002	0.002	0.00	10.66%	0.22%	
10	6	0.002	0.002	0.00	8.96%	0.19%	
10	7	0.002	0.002	0.00	2.78%	0.06%	
10	8	0.002	0.002	0.00	4.26%	0.09%	
10	9	0.002	0.002	0.00	4.89%	0.10%	
20	10	0.002	0.002	0.00	11.96%	0.25%	
20	11	0.002	0.002	0.00	5.70%	0.12%	
20	12	0.002	0.002	0.00	6.67%	0.15%	
20	13	0.002	0.002	0.00	16.04%	0.33%	
20	14	0.002	0.002	0.00	8.51%	0.18%	
30	15	0.002	0.002	0.00	3.19%	0.07%	
30	16	0.002	0.002	0.00	7.43%	0.16%	
30	17	0.002	0.002	0.00	5.13%	0.11%	
30	18	0.002	0.002	0.00	7.39%	0.17%	
30	19	0.002	0.002	0.00	3.19%	0.07%	
30	20	0.002	0.002	0.00	5.19%	0.11%	
31	15a	0.002	0.002	0.00	2.61%	0.06%	
31	16a	0.002	0.002	0.00	10.16%	0.22%	
31	17a	0.002	0.002	0.00	0.13%	0.00%	
31	18a	0.002	0.002	0.00	4.09%	0.09%	
31	19a	0.002	0.002	0.00	-3.38%	0.08%	
31	20a	0.002	0.002	0.00	-1.40%	0.03%	
50	21	0.002	1.203	1.20	52262.67%	1188.78%	
50	22	0.002	1.203	1.20	53723.61%	1188.80%	
50	23	0.002	1.203	1.20	52265.03%	1188.84%	
50	24	0.002	1.203	1.20	58647.69%	1189.01%	
50	25	0.002	1.203	1.20	56909.50%	1188.95%	
Max		0.002	1.203	1.20	58647.69%	1189.01%	
Average		0.002	0.162	0.16	7234.88%	158.63%	
Min		0.002	0.002	0.00	-3.38%	0.00%	
Std Dev		0.000	0.415	0.42	18771.31%	411.00%	

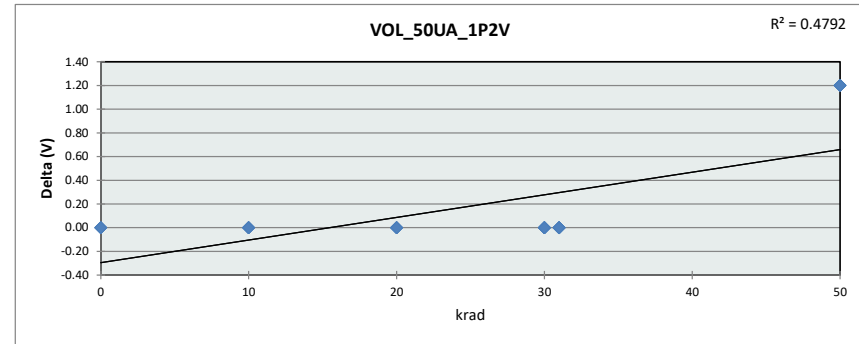

		VOL_50UA_1P2V					
Units		V					
Max Limit		0.1					
Min Limit		-0.001					
krad	LL	Min	Average	Max	UL		
0	-0.001	0.002	0.002	0.002	0.100		
10	-0.001	0.002	0.002	0.002	0.100		
20	-0.001	0.002	0.002	0.002	0.100		
30	-0.001	0.002	0.002	0.002	0.100		
31	-0.001	0.002	0.002	0.002	0.100		
50	-0.001	1.203	1.203	1.203	1.203		

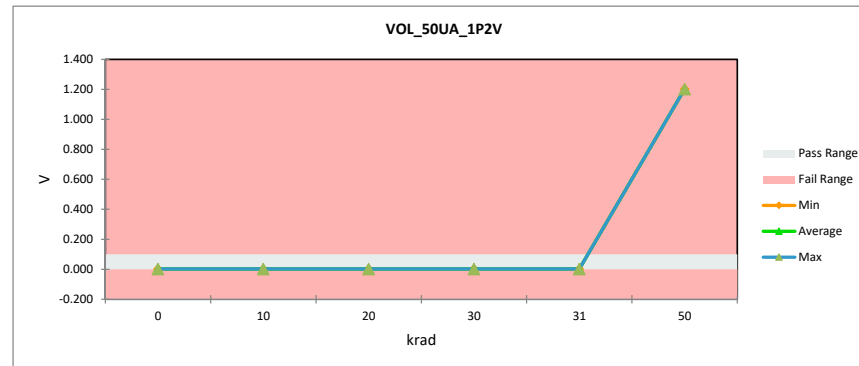

TID Report

SN54SC8T541-SEP

		VOL_50UA_5P5V				
Units		V				
Max Limit		0.1				
Min Limit		-0.001				
krad	Serial #	PreTestHDR	PostTestHDR	Delta	Delta %	% of Limit Range
0	1	0.001	0.001	0.00	35.02%	0.29%
0	2	0.001	0.001	0.00	15.64%	0.13%
0	3	0.001	0.001	0.00	29.61%	0.23%
0	4	0.001	0.001	0.00	8.26%	0.07%
10	5	0.001	0.001	0.00	0.59%	0.01%
10	6	0.001	0.001	0.00	16.31%	0.13%
10	7	0.001	0.001	0.00	5.29%	0.05%
10	8	0.001	0.001	0.00	11.37%	0.10%
10	9	0.001	0.001	0.00	1.69%	0.01%
20	10	0.001	0.001	0.00	22.65%	0.19%
20	11	0.001	0.001	0.00	27.75%	0.23%
20	12	0.001	0.001	0.00	19.86%	0.16%
20	13	0.001	0.001	0.00	20.18%	0.17%
20	14	0.001	0.001	0.00	24.64%	0.20%
30	15	0.001	0.001	0.00	12.07%	0.10%
30	16	0.001	0.001	0.00	37.48%	0.29%
30	17	0.001	0.001	0.00	19.19%	0.16%
30	18	0.001	0.001	0.00	23.07%	0.19%
30	19	0.001	0.001	0.00	27.13%	0.22%
30	20	0.001	0.001	0.00	21.99%	0.19%
31	15a	0.001	0.001	0.00	27.41%	0.23%
31	16a	0.001	0.001	0.00	21.93%	0.17%
31	17a	0.001	0.001	0.00	26.72%	0.23%
31	18a	0.001	0.001	0.00	13.00%	0.11%
31	19a	0.001	0.001	0.00	23.63%	0.19%
31	20a	0.001	0.001	0.00	18.49%	0.16%
50	21	0.001	0.002	0.00	117.91%	0.90%
50	22	0.001	0.002	0.00	100.73%	0.85%
50	23	0.001	0.002	0.00	134.83%	1.00%
50	24	0.001	0.002	0.00	183.02%	1.50%
50	25	0.001	0.002	0.00	157.68%	1.19%
Max		0.001	0.002	0.00	183.02%	1.50%
Average		0.001	0.001	0.00	34.92%	0.28%
Min		0.001	0.001	0.00	0.59%	0.01%
Std Dev		0.000	0.000	0.00	42.09%	0.33%

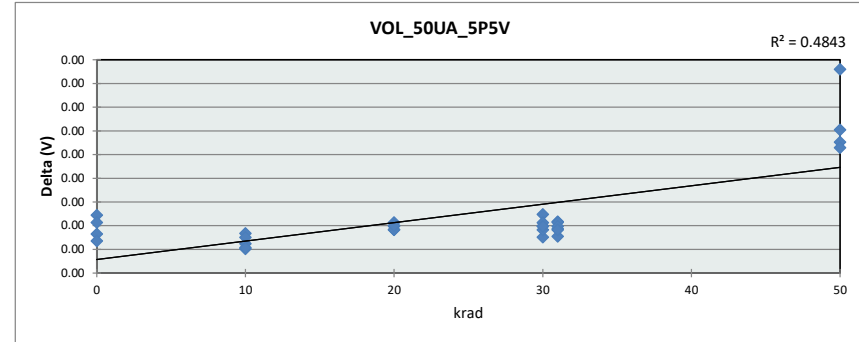

		VOL_50UA_5P5V				
Units		V				
Max Limit		0.1				
Min Limit		-0.001				
krad	LL	Min	Average	Max	UL	
0	-0.001	0.001	0.001	0.001	0.100	
10	-0.001	0.001	0.001	0.001	0.100	
20	-0.001	0.001	0.001	0.001	0.100	
30	-0.001	0.001	0.001	0.001	0.100	
31	-0.001	0.001	0.001	0.001	0.100	
50	-0.001	0.002	0.002	0.002	0.100	

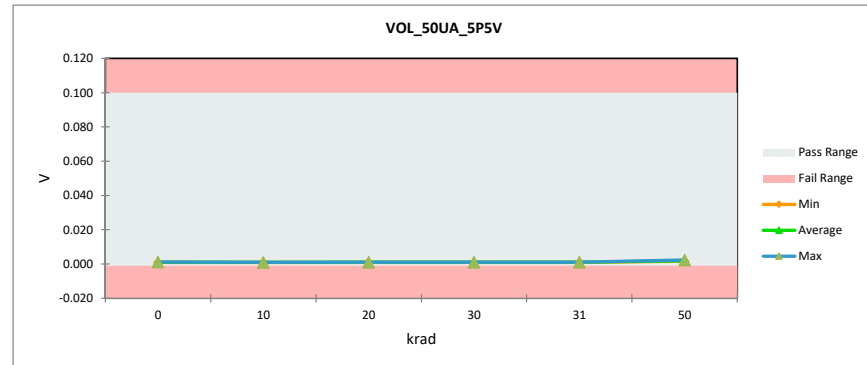

IMPORTANT NOTICE AND DISCLAIMER

TI PROVIDES TECHNICAL AND RELIABILITY DATA (INCLUDING DATA SHEETS), DESIGN RESOURCES (INCLUDING REFERENCE DESIGNS), APPLICATION OR OTHER DESIGN ADVICE, WEB TOOLS, SAFETY INFORMATION, AND OTHER RESOURCES "AS IS" AND WITH ALL FAULTS, AND DISCLAIMS ALL WARRANTIES, EXPRESS AND IMPLIED, INCLUDING WITHOUT LIMITATION ANY IMPLIED WARRANTIES OF MERCHANTABILITY, FITNESS FOR A PARTICULAR PURPOSE OR NON-INFRINGEMENT OF THIRD PARTY INTELLECTUAL PROPERTY RIGHTS.

These resources are intended for skilled developers designing with TI products. You are solely responsible for (1) selecting the appropriate TI products for your application, (2) designing, validating and testing your application, and (3) ensuring your application meets applicable standards, and any other safety, security, regulatory or other requirements.

These resources are subject to change without notice. TI grants you permission to use these resources only for development of an application that uses the TI products described in the resource. Other reproduction and display of these resources is prohibited. No license is granted to any other TI intellectual property right or to any third party intellectual property right. TI disclaims responsibility for, and you will fully indemnify TI and its representatives against, any claims, damages, costs, losses, and liabilities arising out of your use of these resources.

TI's products are provided subject to [TI's Terms of Sale](#) or other applicable terms available either on [ti.com](https://www.ti.com) or provided in conjunction with such TI products. TI's provision of these resources does not expand or otherwise alter TI's applicable warranties or warranty disclaimers for TI products.

TI objects to and rejects any additional or different terms you may have proposed.

Mailing Address: Texas Instruments, Post Office Box 655303, Dallas, Texas 75265

Copyright © 2025, Texas Instruments Incorporated