

# ADS5400EVM

## User's Guide



Literature Number: SLAU293  
October 2009

---

---

---

<b>1</b>	<b>Overview</b> .....	<b>6</b>
1.1	Purpose .....	6
1.2	EVM Quick-Start Procedure .....	6
1.3	Power Requirements .....	6
1.4	ADS5400EVM Operational Procedure .....	6
<b>2</b>	<b>Circuit Description</b> .....	<b>8</b>
2.1	Schematic Diagram .....	8
2.2	Circuit Function .....	8
<b>3</b>	<b>Evaluation</b> .....	<b>12</b>
3.1	TSW1200 Capture Board .....	12
3.2	Quick-Test Results .....	12
<b>4</b>	<b>SPI Interface</b> .....	<b>13</b>
4.1	TI ADC SPI Interface .....	13
4.2	Controlling the SPI Interface Using TI TSW1200 Software 2.0 .....	18
<b>5</b>	<b>Physical Description</b> .....	<b>19</b>
5.1	PCB Schematics .....	19
5.2	PCB Layout .....	24
5.3	Bill of Materials .....	30

---

## List of Figures

1	ADS5400 Jumpers .....	8
2	ADS5400EVM Distribution .....	9
3	TSW1200 GUI Introduction .....	12
4	Quick-Setup Test Result .....	13
5	SPI Install Screens .....	15
6	Found New Hardware .....	16
7	Hardware Device Manager .....	16
8	SPI Program Format .....	17
9	SPI Program Usage .....	17
10	TI TSW1200 SPI Interface .....	18
11	EVM Schematics, Sheet 1 .....	20
12	EVM Schematics, Sheet 2 .....	21
13	EVM Schematics, Sheet 3 .....	22
14	EVM Schematics, Sheet 4 .....	23
15	EVM Schematics, Sheet 5 .....	23
16	Component Side .....	25
17	Ground Plane 1 .....	26
18	Power Plane 1 .....	27
19	Power Plane 2 .....	28
20	Ground Plane 2 .....	29
21	Bottom Side .....	29

## List of Tables

1	Jumper List .....	7
2	EVM Power Supply Jumper Description .....	8
3	EVM Power Supply Options .....	9
4	Analog Input Jumper description .....	10
5	EVM Analog Input Options .....	10

# **ADS5400EVM**

---

---

---

## **1 Overview**

This ADS5400 evaluation module (EVM) user's guide gives an overview of the EVM and provides a general description of the features and functions to be considered while using this module.

### **1.1 Purpose**

The ADS5400EVM provides a platform for evaluating the analog-to-digital converter (ADC) under various signal, reference, and supply conditions. Use this document along with the EVM schematic diagram supplied.

### **1.2 EVM Quick-Start Procedure**

#### **Power Supply**

Power connections to the EVM are supplied by banana jack sockets.

#### **Clock**

The EVM provides an external SMA connector for input of the ADC clock. The single-ended input is converted into a differential signal at the input of the device.

#### **Analog Inputs**

The analog input to the ADC is provided by a external SMA connector. The user supplies a single-ended input or differential input (SMA connector which is not populated in the EVM). If the single-ended configuration is used, the signal is converted into the differential signal before the ADC.

### **1.3 Power Requirements**

The EVM can be powered directly from 5 V for the ADC analog supply, or EVM jumper settings can be modified to use the onboard power solution from Texas Instruments (TI). The input power supply voltage range for the EVM can be 6 V to 36 V only if the onboard TI power solution is used.

#### **CAUTION**

Voltage Limits: Exceeding the maximum input voltages can damage EVM components. Undervoltage may cause improper operation of some or all of the EVM components.

### **1.4 ADS5400EVM Operational Procedure**

The ADS5400EVM provides a flexible means of evaluating the ADS5400 in various modes of operation. A quick-setup procedure follows.

1. Verify all jumper settings according to the schematic jumper list in [Table 1](#).

**Table 1. Jumper List**

Jumper	Function	Default Jumper Setting
<b>ADC Circuit</b>		
JP4	EN	2-3
JP5	PWD	2-3
JP6	REFSEL	2-3
<b>Power Supply</b>		
JP12	3.3VA_IN	1-2
JP13	3.3VD_IN	1-2
JP14	5V_IN	1-2
JP15	TPS79501 INPUT SELECT	1-2
JP16	5V_AUX	2-3
JP17	TPS5420 INPUT SELECT	NO SHUNT

2. Connect the 5-V supply between J5 and J6 (GND). If you are using the TSW1200 for capture, it can also be used to source 5 V for the EVM. On the TSW1200, configure JP8 to short 1-2 and J22 to short 1-2 and jumper over 5 V from the banana jacks on the TSW1200 to J5 on the ADC EVM. Do not connect a voltage source greater than 5.5 V.
3. Switch on power supplies.
4. Using a function generator with 50-Ω output impedance, generate a 0-V offset, 1.5-V<sub>pp</sub> sine-wave clock into J12. The frequency of the clock must be within the specification for the device speed grade.
5. Use a frequency generator with a 50-Ω output impedance to provide a 0-V offset, -1-dBFS-amplitude sine-wave signal into J1. This provides a transformer-coupled differential input signal to the ADC.
6. Connect the TSW1200 or suitable logic analyzer to J4 to capture the resulting digital data. If you connect a TSW1200 to capture data, follow the additional alphabetically labeled steps. For more information, see [Section 3](#).
  - (a) After installing the TSW1200 software and connecting the TSW1200 to the USB port, open the TSW1200 software.
  - (b) Depending on the ADC under evaluation, select ADS5400 from the “TI ADC Selection” pulldown menu.
  - (c) Change the “ADC Sample Rate” and “ADC Input Frequency” to match those of the signal generator.
  - (d) After selecting a Single Tone FFT test, press the “Capture Data” button.

## 2 Circuit Description

### 2.1 Schematic Diagram

The schematic diagram for this EVM is attached at the end of this document. See the schematic before changing any jumpers.

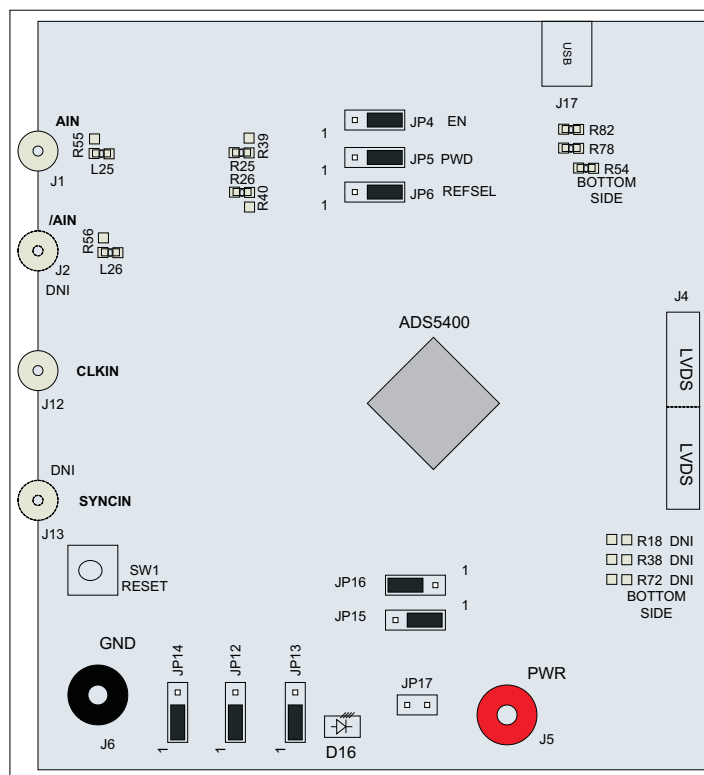

Figure 1. ADS5400 Jumpers

### 2.2 Circuit Function

The following sections describe the function of individual circuits. See the relevant data sheet for device operating characteristics.

#### 2.2.1 Power

Power is supplied to the EVM through a TI power solution. Although various power options are available on this EVM, care must be taken while applying power on J5 as different options have different voltage ranges specified. [Table 2](#) displays the general jumper setting information; [Table 3](#) displays the various power option settings. Prior to making any jumper settings, see the [Figure 14](#) schematic.

Table 2. EVM Power Supply Jumper Description

EVM Banana Jack	Description	Jumper setting
J5	Input	5-V to 36-V power supply; default - apply just 5 V
JP12	3.3VA_IN	1-2 → Connect 3.3-V AVdd to TPS79633 output; 2-3 → Ground
JP13	3.3VD_IN	1-2 → Connect 3.3-V DVdd to TPS79633 output; 2-3 → Ground
JP14	5V_IN	1-2 → Connect 5-V AVdd to 5V_Aux; 2-3 → Ground
JP15	TPS79501 INPUT SELECT	1-2 → Connects 5.3 V to input of TPS79501; 2-3 → TPS79501 input connected to J5

**Table 2. EVM Power Supply Jumper Description (continued)**

EVM Banana Jack	Description	Jumper setting
JP16	5V_AUX	1-2 → TPS79501 op as 5v_Aux rails; 2-3 → 5V_aux rail connected to J5
JP17	TS5420 INPUT SELECT	Shunt → J5 connected to TPS5420D

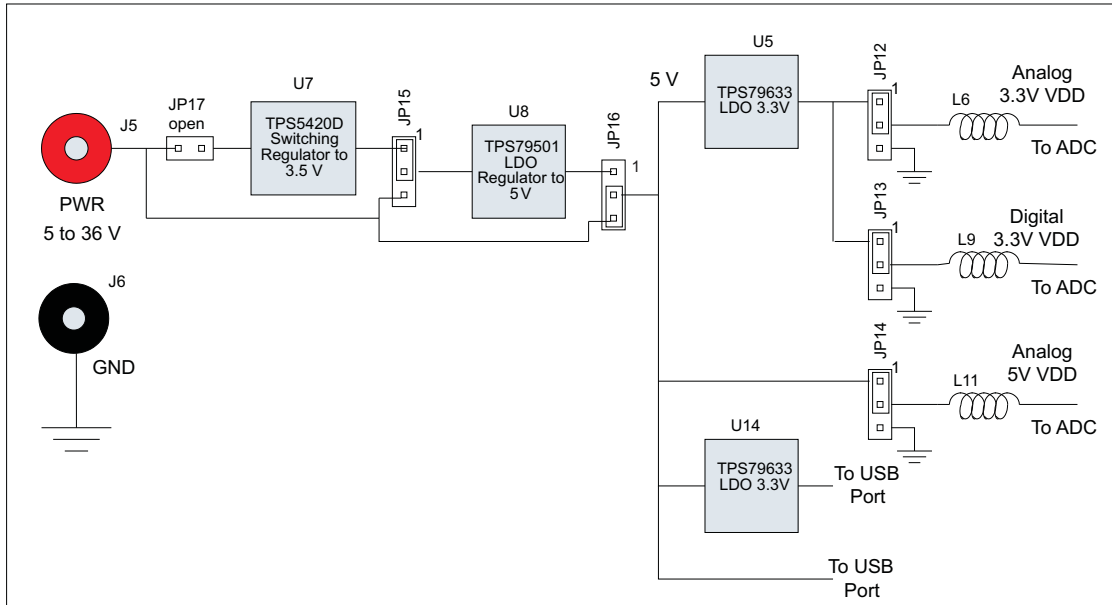
**Figure 2. ADS5400EVM Distribution**
**Table 3. EVM Power Supply Options**

EVM Option	Evaluation Goal	Jumper Changes Required	Voltage on J5	Comments
1	Evaluate ADC performance using a cascaded switching power supply (TPS5420D) and LDO solution (TPS79501DCQ)	JP12 → 1-2; JP13 → 1-2; JP14 → 1-2; JP15 → 1-2; JP16 → 1-2; JP17 → 1-2;	6 V to 36 V	Isolates input voltage from the requirement for a clean analog supply input
2 (Default)	Evaluate ADC performance using a LDO-based solution.	JP12 → 1-2; JP13 → 1-2; JP14 → 1-2; JP15 → 1-2; JP16 → 2-3; JP17 → No shunt;	5 V to 5.5 V	Requires clean input supply as this connects to ADS5400 5-V analog supply input
3	Evaluate ADC performance using an isolated ADC AVDD and DVDD for current consumption measurements	JP12 → connect 3.3V to pin 2 of Jumper; JP13 → connect 3.3V to pin 2 of Jumper; JP14 → connect 5 V to pin 2 of Jumper and ground to J6; JP15 → No shunt ; JP16 → No shunt ; JP17 → No shunt;	Do not apply power on J5.	Separates power inputs for analog and digital for individual current consumption measurements

### 2.2.1.1 Power Supply Option 1

Option 1 supplies the power to the ADC using cascaded topology of the TPS5420D and the TPS79501DCQ. The TPS5420 is a step-down converter which works with the input voltage in the range of 6 V to 36 V. The switching supply increases efficiency for higher input voltages but does create noise on the voltage supplies. To reduce the noise, an ultralow-noise, high-PSSR LDO TPS79501DCQ is used to clean the power supply. The TPS5420D is designed for output of 5.3 V, which acts as input for TPS79501. The TPS79501 is designed to output a 5-V output, which is the AVDD for the ADC. This voltage rail is



input to the LDO TPS79633, which outputs 3.3 V, used for DVDD for the ADC. This solution adds two features to the EVM: one is to increase the range of the power supply on jumper J5 from 6 V to 36 V, allowing the user to choose any power supply source in the specified range without causing significant power dissipation. The other feature is that the output voltage rail has a much lower ripple, ensuring the better performance of the part even when the power source is fluctuating.

### 2.2.1.2 Power Supply Option 2, Default

Option 2 supplies power to the ADC using the LDO TPS79633DCQ. The LDO limits the power supply on J5 to be in the range 5 V to 5.5 V only. This option again has the output voltage much cleaner as the LDOs chosen have high PSSR and low noise. Care must be taken while powering up the EVM using this option, as higher voltage or reverse polarity may damage the EVM.

### 2.2.1.3 Power Supply Option 3

Option 3 is used to evaluate ADC performance using an isolated AVDD and DVDD power supply for current consumption measurements. This option must be used with caution as reversing the power supply or connecting to the wrong connector can result in damage to the EVM.

## 2.2.2 Clock Input

The clock can be supplied to the ADC from J12 directly from an external source. For the direct supply of the clock to the ADC, a single-ended square or sinusoidal clock input must be applied to J12. The clock frequency must be within the maximum frequency specified for the ADC. The clock input is converted to a differential signal by a Mini-Circuits™ ADT4-1WT, which has an impedance ratio of 4, implying that voltage applied on J12 is stepped up by a factor of 2. ADC performance in this case depends on the clock source quality. The single-ended option is also the default configuration on the EVM, when it is shipped from the factory. The test result using this option is shown in [Figure 4](#).

## 2.2.3 Analog Inputs

The EVM is configured to use a transformer-coupled input from a single-ended source. The SMA connector J1 provides the inputs. The SMA connector J2 provides an option for a differential input, which is not populated. To set up for one of these options, the EVM must be configured as per the options listed in [Table 5](#). See the [Figure 11](#) schematic prior to making any jumper changes .

**Table 4. Analog Input Jumper description**

EVM Banana Jack	Description	Jumper setting
J1	Analog input Single ended.	
J2	Analog input, can be used with J1 for differential input	Not populated

**Table 5. EVM Analog Input Options**

EVM Option	Evaluation Goal	Jumper Changes Required	Voltage on J7 and J9	Analog signal to ADC	Comments
1	Evaluate ADC performance using direct single-ended input to ADC.	L25, L26, R25, and R26 installed with 0 $\Omega$	Do not connect	From J1	Default
2	Differential input	L26, R39, R40, and R55 installed with 0 $\Omega$	Do not connect	From J1, J2	

### 2.2.3.1 Analog Input Option 1

Option 1 supplies the transformer coupled input from J1 to ADC. This configuration is the default on the EVM. The test result using this option is shown in [Figure 4](#).

The transformer footprint used on the ADS5400EVM is flexible to accommodate either transformers or baluns from several suppliers. If baluns are installed, then the signal must be AC coupled to the ADS5400 so that the common-mode biasing circuits in the ADS5400 input may bias the signal to the desired common-mode level. AC coupling capacitors C128 and C129 on the EVM serve this purpose. By default, a dual balun (Minicircuits ETC1-1-13) is installed on the ADS5400EVM. Depending on the input frequency to be evaluated, it may be desirable to select a different transformer or balun component more suited to a particular frequency range.

### 2.2.3.2 Analog Input Option 2

Option 2 allows the use of a differential input applied to two SMA connectors, and the differential input signal then bypasses the transformer coupling. By default, the SMA connector for the negative side of the differential input is not assembled on the EVM and must be added before this option is used. By default, component L25 is assembled with a 0-ohm jumper resistor to steer the positive side of the differential input to the transformer input. This 0-Ω resistor must be moved from component location L25 to component location R55 to steer the signal around the transformer coupling. Then the 0-Ω resistors R25 and R26 must be removed and installed instead in locations R39 and R40. This completes the differential path from J1 and J2 to the analog inputs of the ADS5400.

### 2.2.4 Digital Outputs

The LVDS digital outputs can be accessed through the J4 output connector. A parallel 100-Ω termination resistor must be placed at the receiver to properly terminate each LVDS data pair. These resistors are required if the user wants to analyze the signals on an oscilloscope or a logic analyzer. The ADC performance also can be quickly evaluated using the TSW1200 boards as explained in next section.

### 2.2.5 Sync Input

The ADS5400 analog-to-digital converter device features a Reset input pin that may also be referred to as a Sync input pin, depending on the mode of operation of the device. When the LVDS output clock for the ADS5400 is operating in DDR mode, it may be desirable to reset the output clocking circuitry to put the phase of the DDR clock in a known position, particularly if multiple ADS5400 devices are to be synchronized. Also, a pulse on the Reset/Sync input pin results in a SYNCOUT output pulse if SYNC mode is enabled.

Because the ADS5400EVM has a single ADS5400 device installed on it, it is unnecessary to use the Reset/Sync input for normal evaluation, and the TSW1200 does not require the Reset/Sync pin to be used. Nevertheless, the ADS5400EVM provides mechanisms for using the Reset/Sync input.

The default configuration of the ADS5400EVM provides for switch SW1 to assert a reset pulse to the Reset/Sync input pin. An LVDS buffer device converts the pulse from the switch to a differential input to the ADS5400. Because the switch SW1 is not synchronized to the sample clock at all, setup and hold timings between the resulting reset input and the sample clock cannot be ensured. Switch SW1 is simply a way to assert the signal to see what effect the Reset/Sync input may have on the device. Pressing switch SW1 may have about a 50% probability of inverting the phase of the LVDS DDR output clock.

The Reset/Sync input may be used as a periodic SYNC input that causes a SYNCOUT output signal useful for synchronizing the sample data across multiple data converters or to some external event. The SYNC input in this case must meet setup and hold timing relationships relative to the input sample clock. To facilitate this mode, the ADS5400 EVM has an SMA input J13 (normally not installed) that is converted to differential by transformer coupling to the Reset/Sync input pins in a path that is matched both in schematic and layout with the sample clock input path. Thus, if clock and sync signals are generated and synchronized externally, then the ADS5400EVM preserves their timing relationship up to the input pins of the ADS5400. To enable the transformer-coupled SYNC input from J13, resistors R30 and R33 are to be removed and AC coupling capacitors C66 and C71 are to be installed.

### 3 Evaluation

#### 3.1 TSW1200 Capture Board

The TSW1200 board can be used to analyze the performance of the EVM. The TSW1200EVM assists designers in prototyping and evaluating the performance of high-speed ADCs that feature parallel or serialized LVDS outputs. The TSW1200 has the LVDS 100-Ω termination resistor on the input interface for ADC outputs.

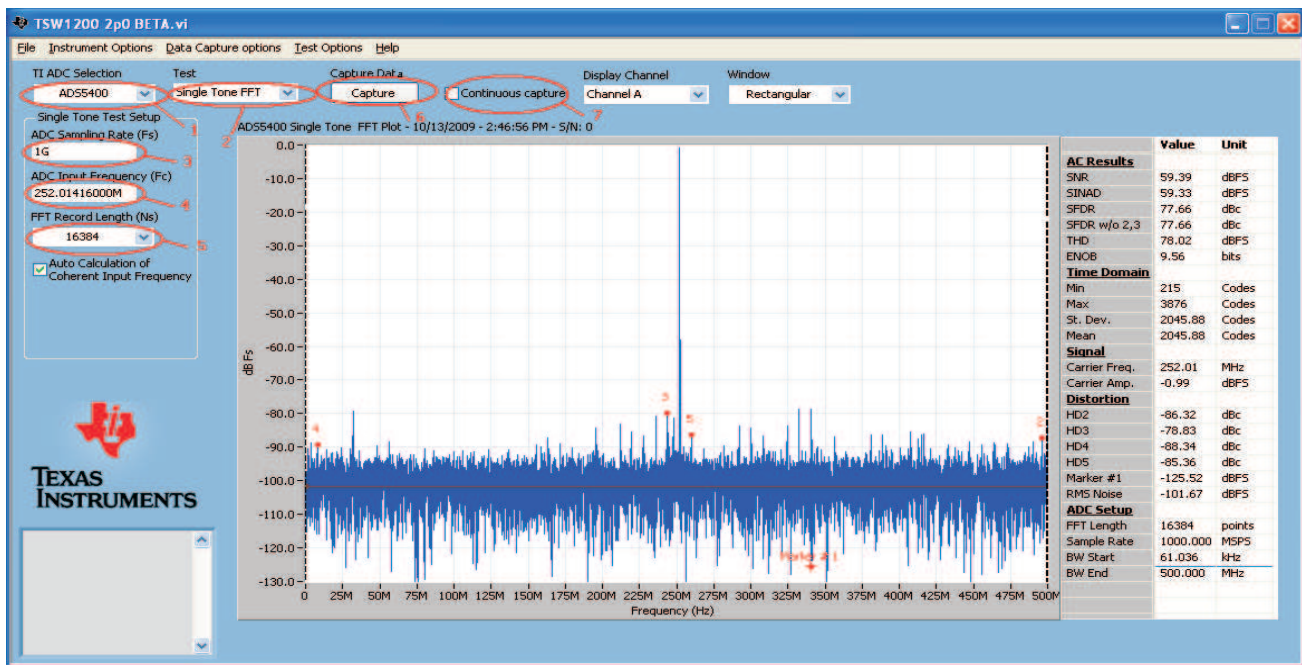

Figure 3. TSW1200 GUI Introduction

Start the TSW1200 software as follows.

1. Select the ADC type to be used before capturing.
2. For test, select Single Tone FFT plot.
3. For the ADC Sampling Rate, type in the value.
4. Type in the ADC Input Frequency. Auto calculation of the input frequency depends on the FFT record length. As soon as the number is entered, the software calculates the coherent input frequency corresponding to that FFT length. This frequency signal must be supplied through the signal generator.
5. Select the FFT Record Length.
6. Select Capture to obtain the plot
7. The Continuous Capture option is used if the user wants to continuously capture the FFT.

Be sure to adjust the input level signal to attain the dBFs of approximately -1.

#### 3.2 Quick-Test Results

The user can make the jumper setting as mentioned in Table 1. In this configuration, the EVM uses an external clock source from J12 and a direct input signal J1 to the ADC. This setup uses Power Option 2 (Table 3) and Analog Input Option 1 (Table 5), which is the default on the EVM. Figure 4 shows the ADC performance capture using TSW1200 with the input signal of a 252-MHz frequency and clock frequency of 1000 MHz with the ADS5400.

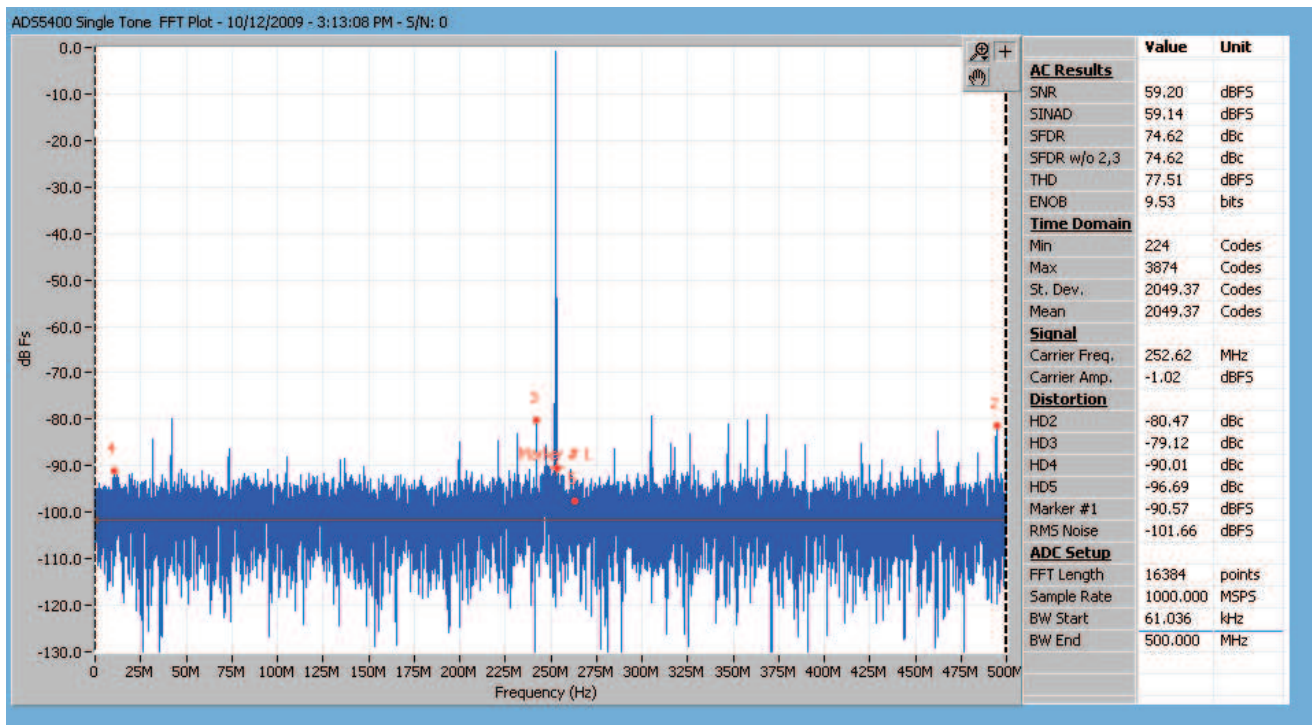

**Figure 4. Quick-Setup Test Result.**

## 4 SPI Interface

This section describes the SPI control interface, installation of the GUI for SPI, and its usage. This EVM can use SPI in two ways. One is through the TI ADC SPI Control Interface and another is using TI TSW1200EVM Software 2.0. This section describes both methods in detail.

### 4.1 TI ADC SPI Interface

This section describes the software features of the EVM kit. The TI ADC SPI control software provides full control of the SPI interface, allowing users to write to any of the ADC registers found in the data sheet. For most ADS5400 performance evaluations, users do not need to use the TI SPI control software. They only need to use the ADC SPI control software when the desired feature is inaccessible through the ADC parallel interface mode.

#### 4.1.1 Installing the TI ADC SPI Interface

ADC SPI control software can be installed on a personal computer by running the setup.exe file located on the CD. This file installs the graphical user interface (GUI) along with the USB drivers needed to communicate with the USB port that resides on the EVM. The software installation provides for installation in a default directory, which the user may change to some other directory path if desired, as shown in [Figure 5](#). After the software is installed, insert the USB cable in the EVM to complete the installation. The Found New Hardware wizard starts and when prompted, users must allow the Windows™ operating system to search for device drivers by checking "Yes, this time only" as seen in [Figure 6](#). The Found New Hardware wizard automatically finds TI ADC SPI Interface drivers. When prompted that the TI ADC SPI Interface has not passed Windows Logo Testing, select "continue anyway" as shown in [Figure 5](#) and [Figure 6](#). After completion, the TI ADC SPI Interface shows up in the Hardware Device Manager. [Figure 7](#) shows the SPI interface in the Hardware Device Manager which indicates that it is ready for use.

**NOTE:** Before plugging in the USB cable for the first time, install the TI ADC SPI software. The software installs the drivers necessary for USB communication.

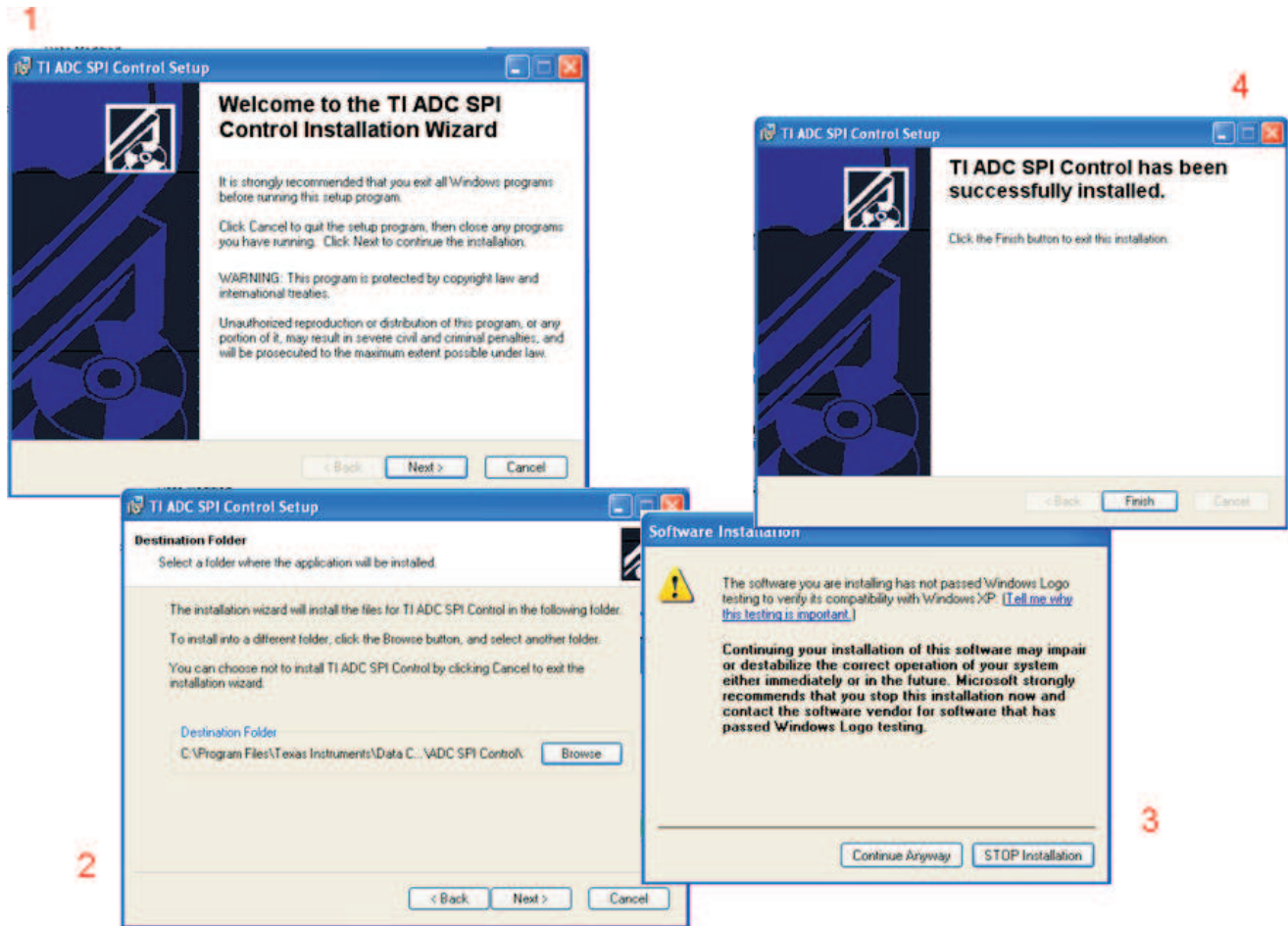

Figure 5. SPI Install Screens

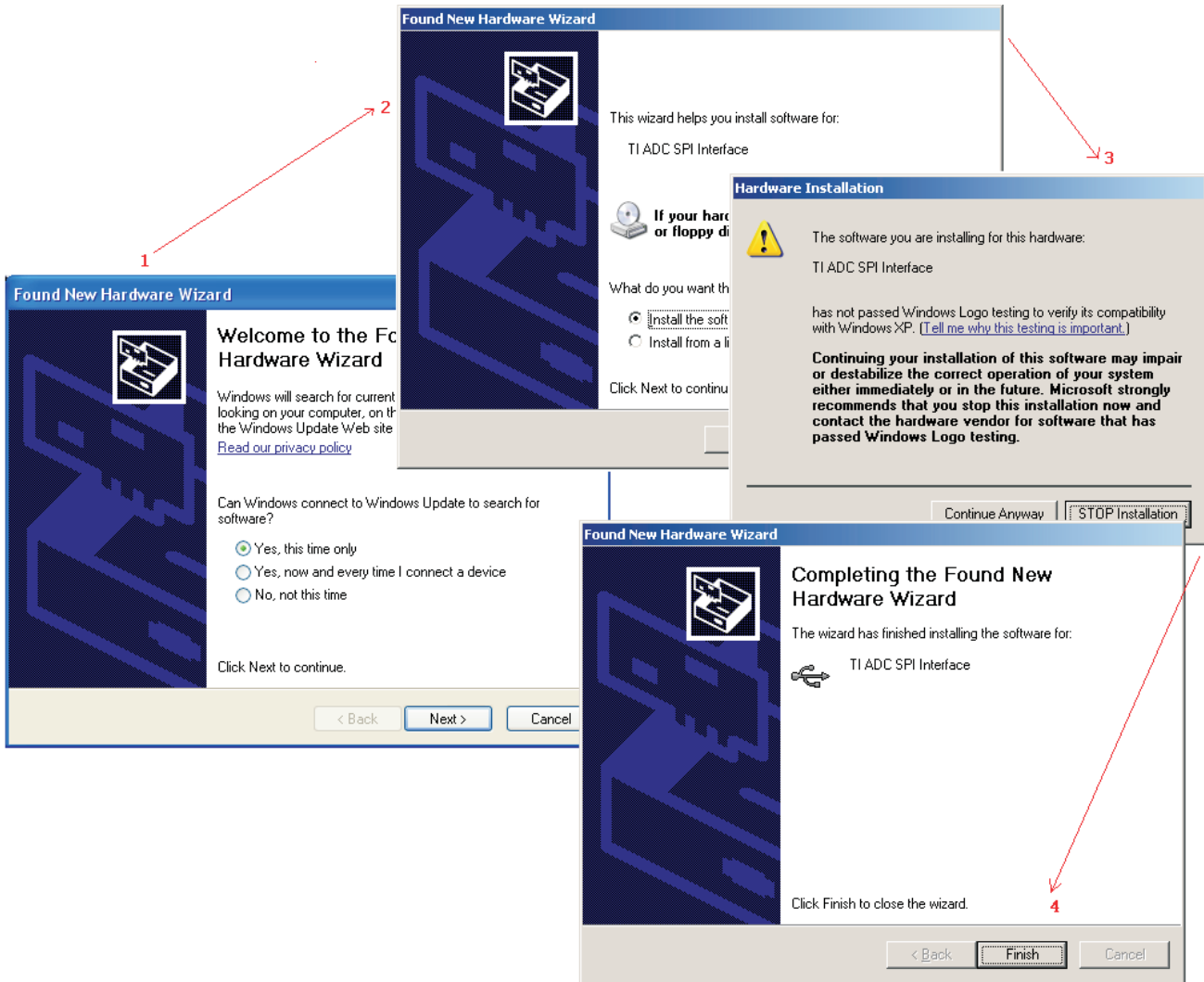
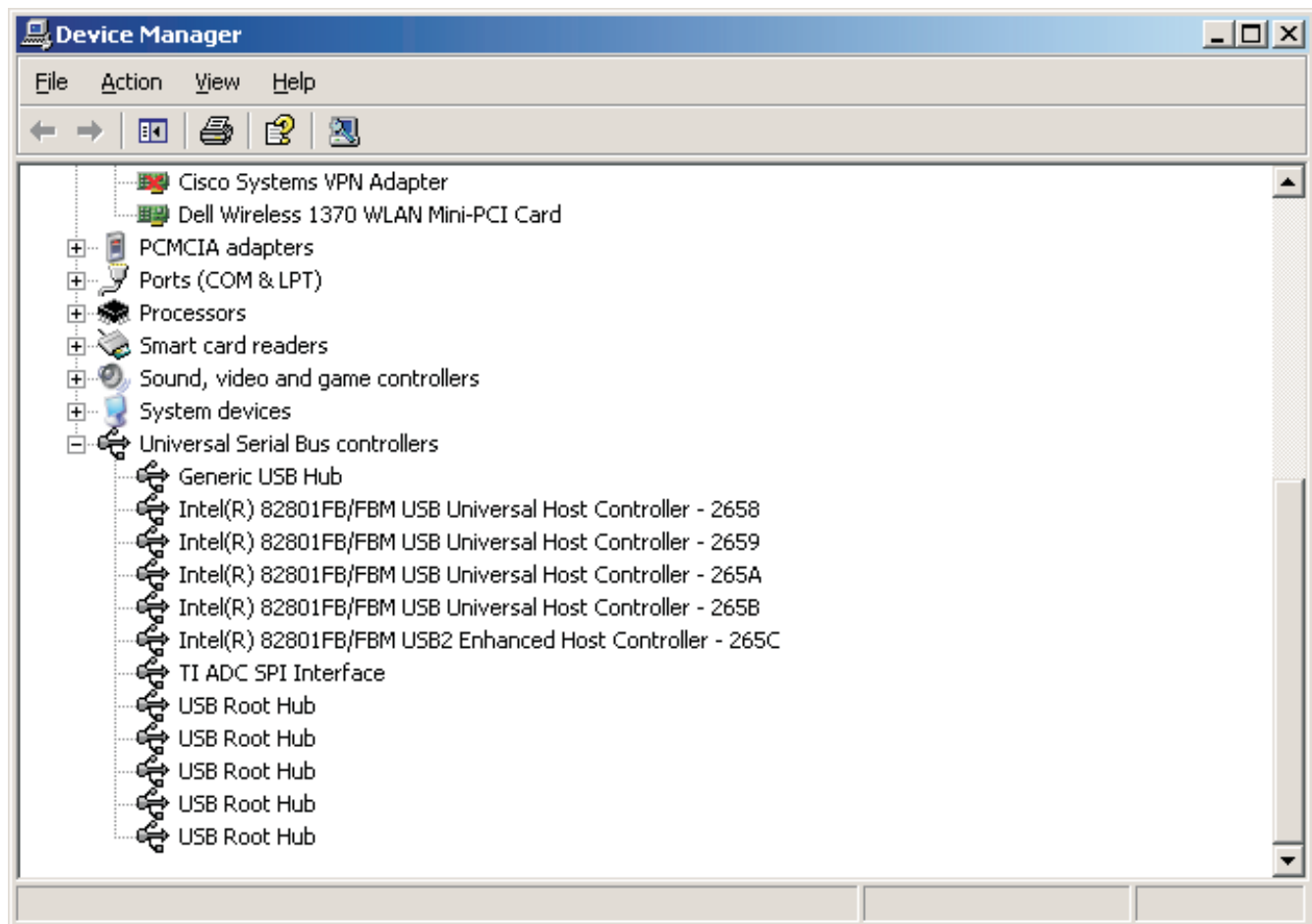

Figure 6. Found New Hardware



**Figure 7. Hardware Device Manager**

#### 4.1.2 Using the TI ADC SPI Interface

By default, the ADS5400EVM is configured to allow the register space in the ADS5400 to be accessed by way of the TI ADC SPI User Interface. The TI ADC SPI User Interface has tabs across the top of the User Interface window to choose the family of ADC EVM. At this time, the ADS5400 SPI format does not yet have a tab and is chosen instead by selecting the Register Interface tab and then leaving the format selection on Select ADC. Later revisions of the TI ADC SPI User Interface may add a device tab labeled as ADS5400.

The TI ADC SPI User Interface allows write access to the register space of the ADS5400. First, the address of the register to be written is entered in the Address Byte field. Then the data value to be written is entered in the Data Byte field. The write operation can then be completed by either pressing the Send Data button or by hitting Enter on the keyboard. Both the address and data are by default entered in hexadecimal notation, but the User Interface allows for the use of decimal, octal, or binary data formats as well by using the mouse to change the data format from x to d, o, or b.

The address field of the register space in the ADS5400 is 5 bits long. Three additional bits in the SPI definition for the ADS5400 are not currently supported by the SPI User Interface, and these three additional bits (for read/write direction and for number of bytes to be written) must be set to 0 for use with the SPI software. For example, a write to address 0b00101 binary is written to 0b00000101 in binary or 0x05 in hexadecimal using the SPI User Interface. Later revisions to the SPI software may enable the use of read-back from the SPI register space, but that is unsupported at this time.

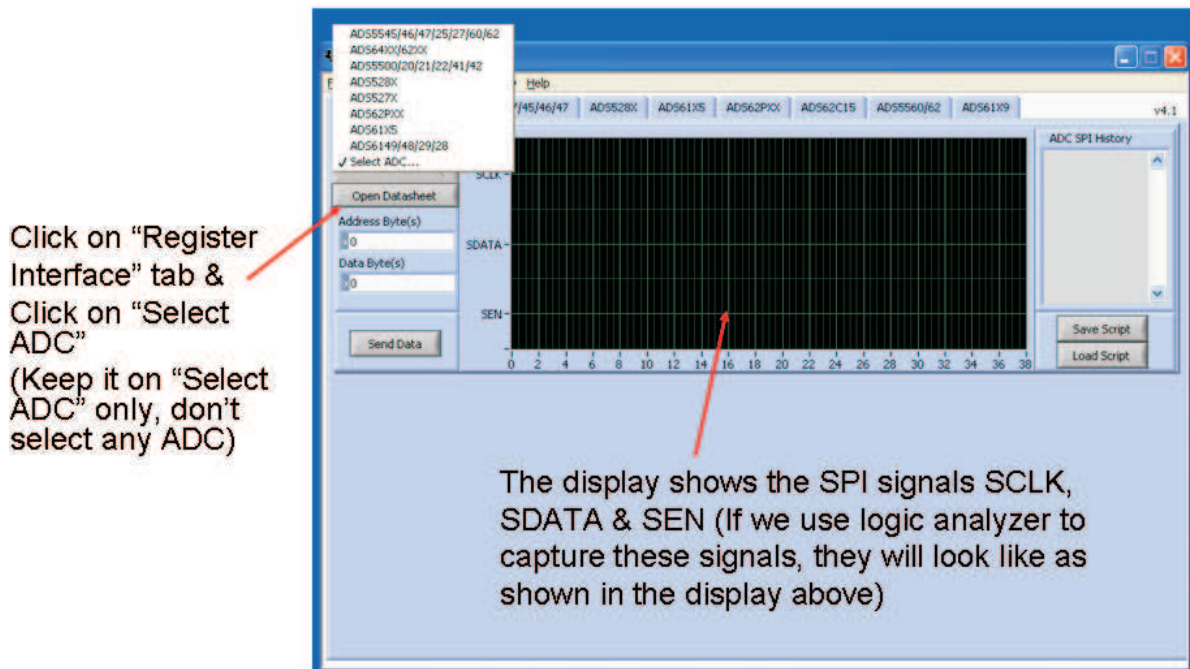

Figure 8. SPI Program Format

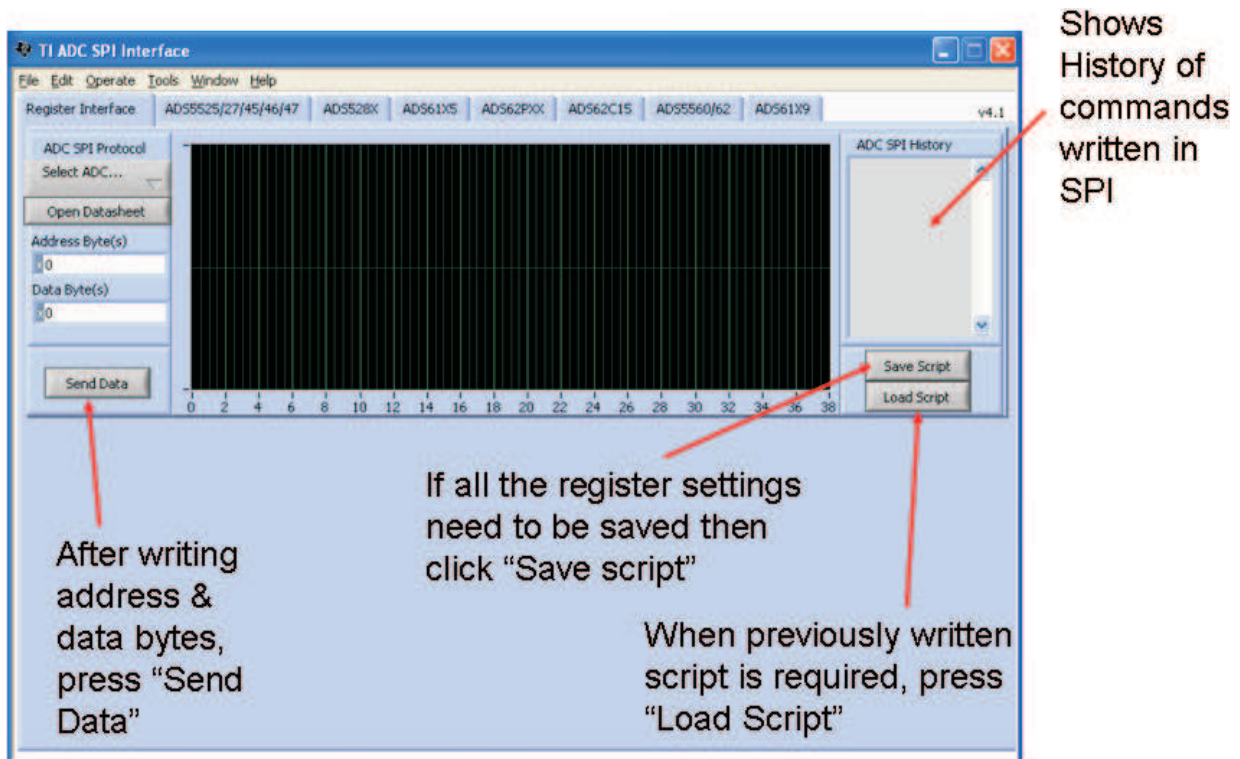

Figure 9. SPI Program Usage



## 4.2 Controlling the SPI Interface Using TI TSW1200 Software 2.0

The ADS5400EVM provides an option for the TSW1200 to drive the SPI interface to perform register writes to the ADS5400 register space. To enable this option, the 0-Ω resistors installed in locations R54, R78, and R82 must be removed and installed in locations R18, R38, and R72 instead. This connects the SPI signals SCLK, SEN, and SDATA to the TSW1200 connector J4 instead of to the USB port on the EVM.

The TSW1200 User Interface revision 2.0 or newer includes a SPI control pane as shown in Figure 10. Much like the TI ADC SPI User Interface, the SPI pane of the TSW1200 User Interface allows register accesses to be specified in terms of address byte and data byte. The Send Data button causes the registers accesses listed in the SPI Command Queue to be written to the ADS5400. Unlike the TI ADC SPI Interface, the TSW1200 User Interface allows several register accesses to be entered into the Command Queue, and then pressing the Send Data button causes the whole queue to be written at once.

The benefit of using the Command Queue to queue up register accesses is that once a commonly used string of register accesses are listed in the command queue, the queue may be saved under a command name, and loading this command name later fills the queue with the string of register accesses and then the send data button writes the queue to the ADC. This simple mechanism of creating a script of register writes may be more convenient for frequently used sequences of register writes. Also, if a register access is typed incorrectly, then by writing to the queue before sending the data to the device allows for the chance to clear the queue and start over on typing in the register accesses.

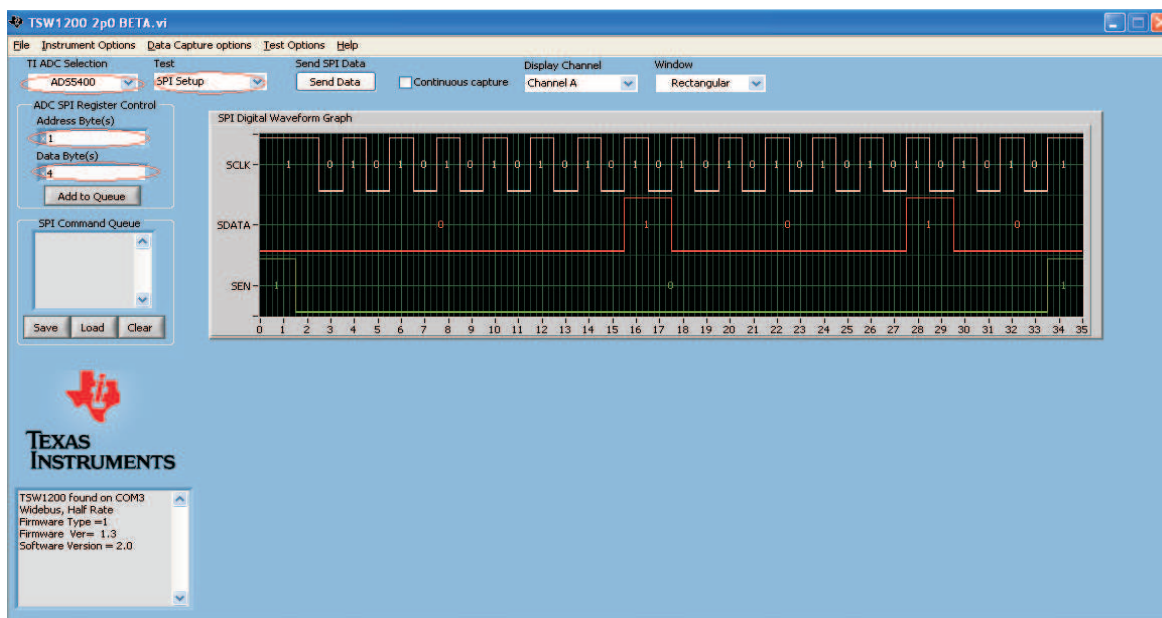

Figure 10. TI TSW1200 SPI Interface

## 5 Physical Description

This section describes the physical characteristics and printed-circuit board (PCB) layout of the EVM.

### 5.1 PCB Schematics

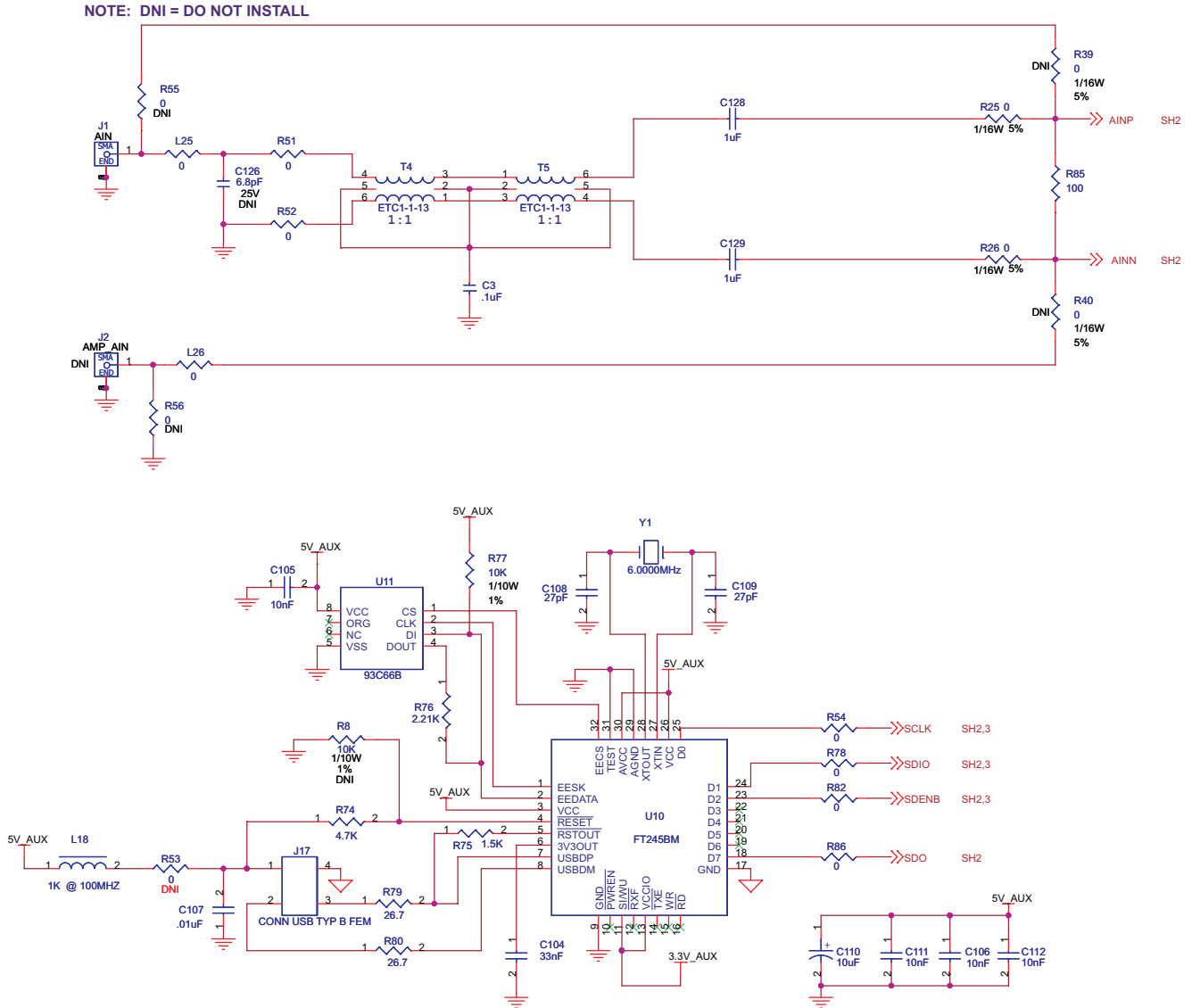

Figure 11. EVM Schematics, Sheet 1

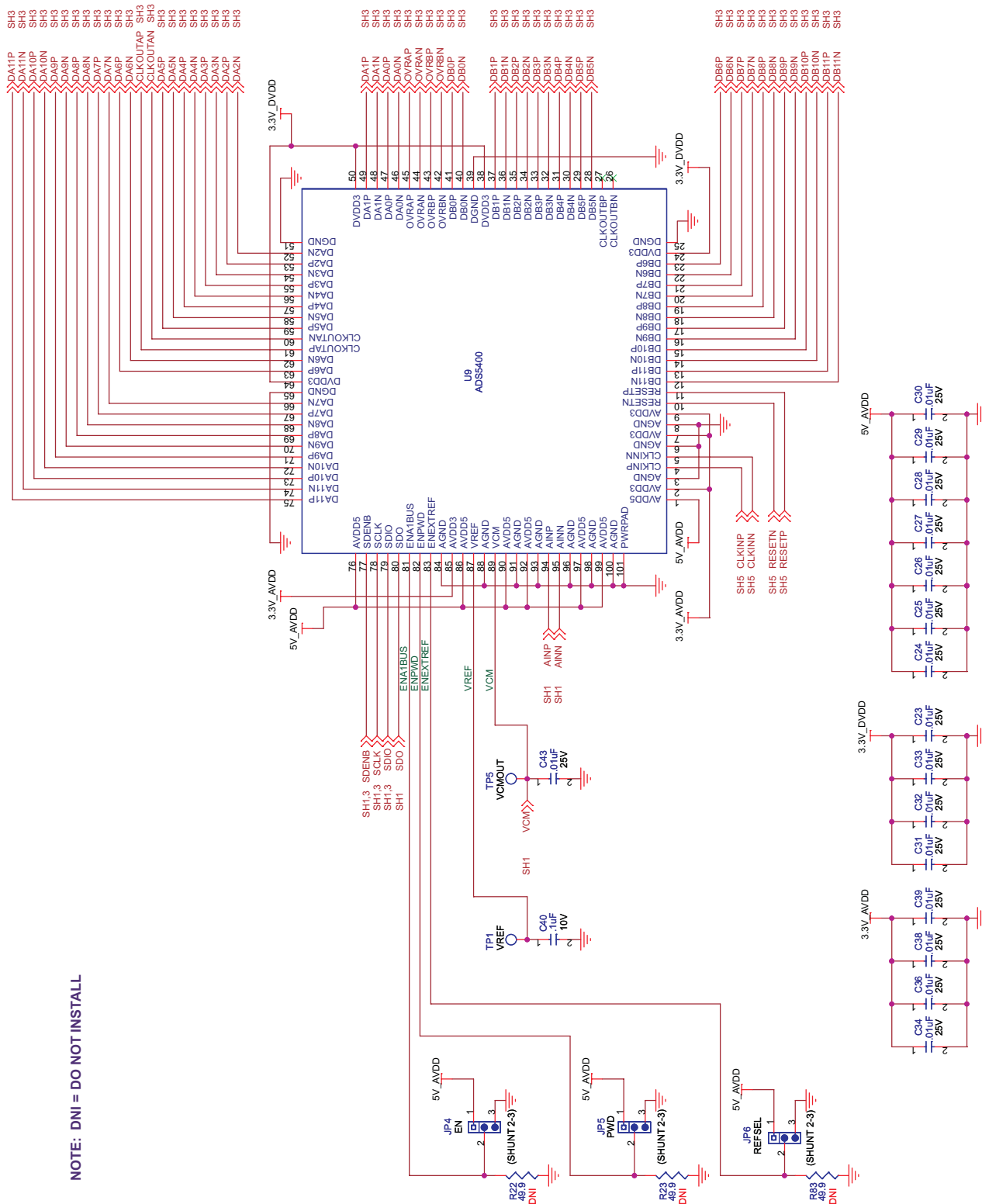
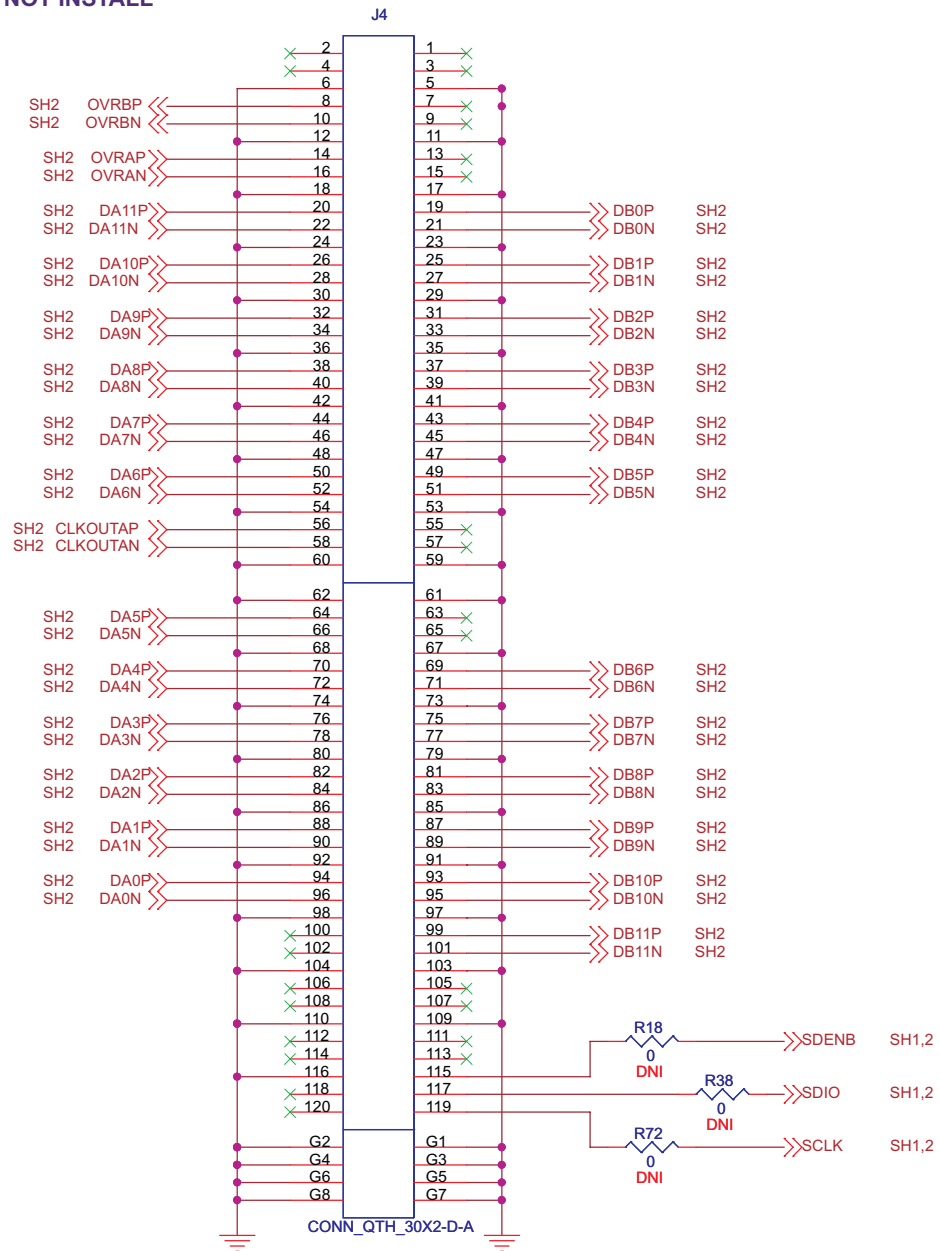

Figure 12. EVM Schematics, Sheet 2

**NOTE: DNI = DO NOT INSTALL**



**Figure 13. EVM Schematics, Sheet 3**

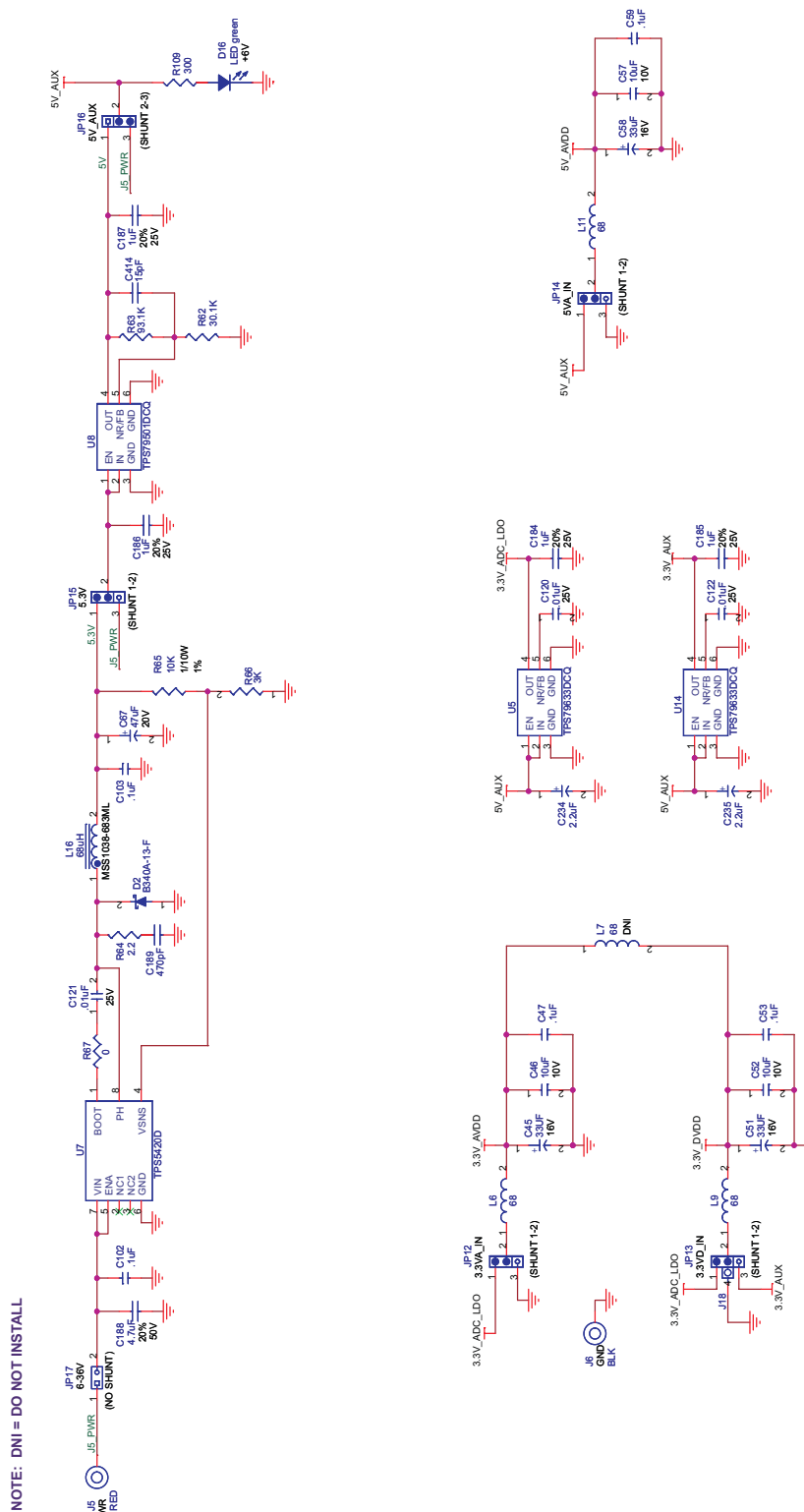

Figure 14. EVM Schematics, Sheet 4

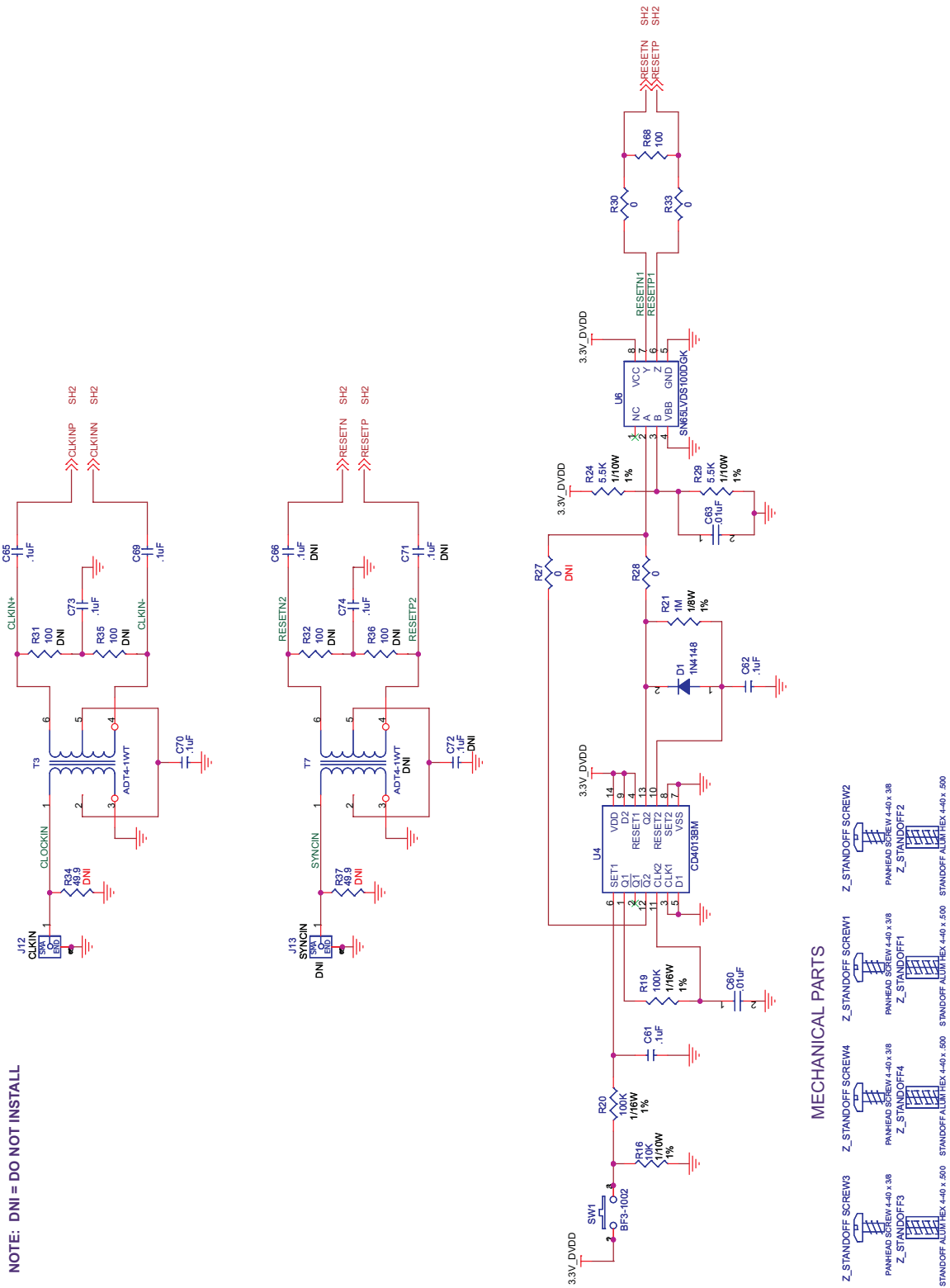
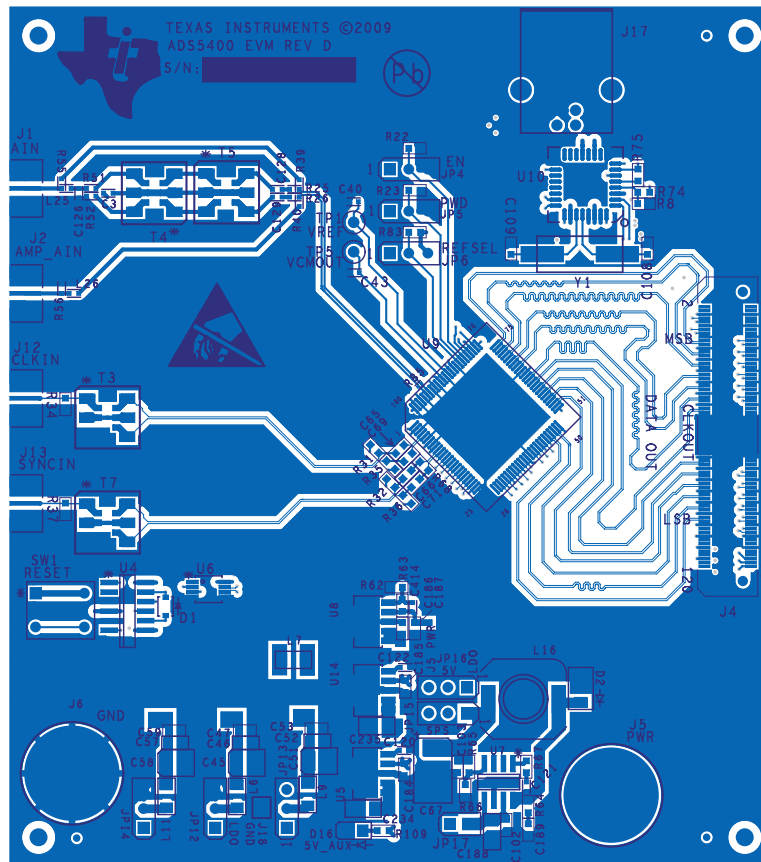

Figure 15. EVM Schematics, Sheet 5

## 5.2 PCB Layout

The EVM is constructed on a six-layer, 0.062-inch-thick printed-circuit board (PCB) using FR-4 material. The individual layers are shown in [Figure 16](#) through [Figure 21](#). The layout features a common ground plane; however, similar performance can be obtained with careful layout using a split ground plane.



**Figure 16. Component Side**

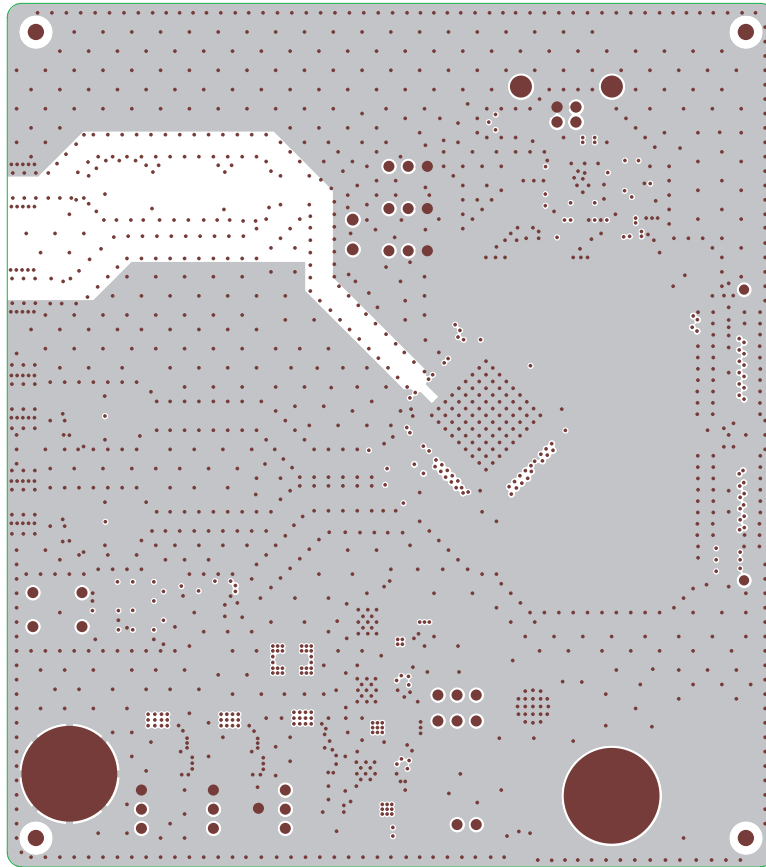

**Figure 17. Ground Plane 1**



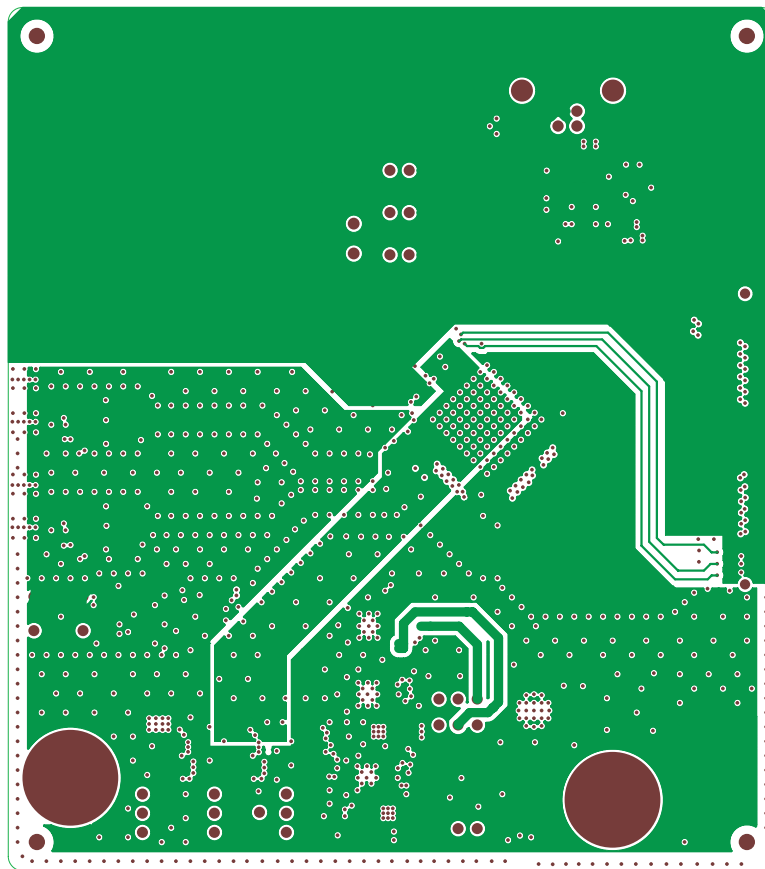
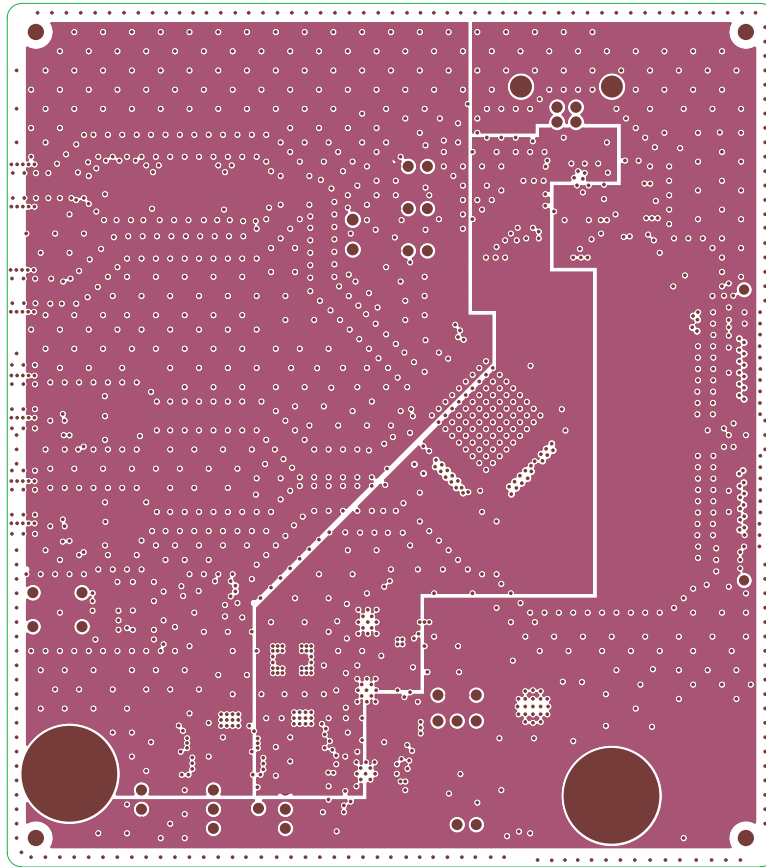
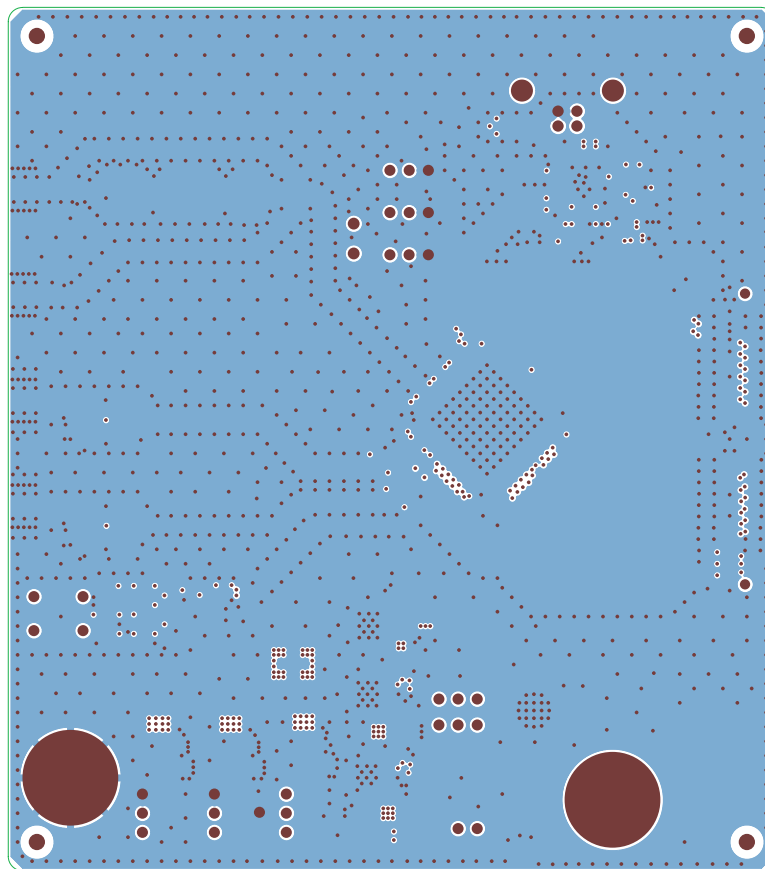

Figure 18. Power Plane 1



**Figure 19. Power Plane 2**



**Figure 20. Ground Plane 2**

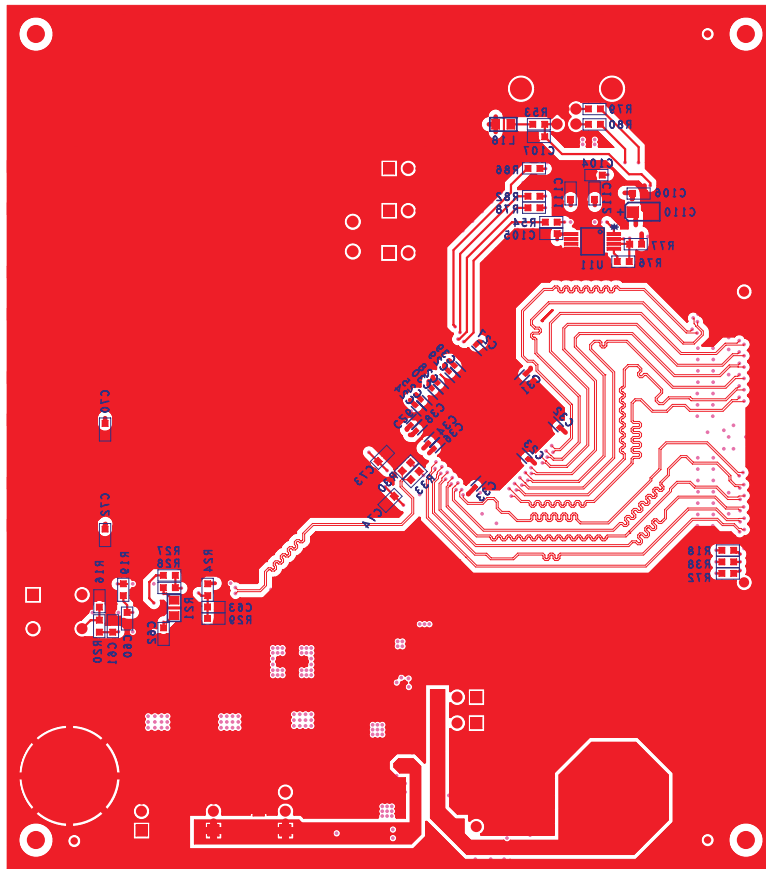

Figure 21. Bottom Side

**5.3 Bill of Materials**

Qty.	Ref	Note	Part	Foot Print	Part No.	MFR.	Tol	Volt	Rating
1	C3		0.1uF	402	GRM155R71C104KA88D	Murata	10%	16V	
19	C23-C34, C36,C38,C39,C43,C120,C121, C122		0.01uF	402	ECJ-0EB1E103K	Panasonic	10%	25V	
1	C40		0.1uF	402	ECJ-0EB1A104K	Panasonic	10%	10V	
3	C45,C51,C58		33uF	TANT_B	ECS-T1AX336R	Panasonic	10%	16V	
3	C46,C52,C57		10uF	805	ECJ-2FB1A106K	Panasonic	10%	10V	
12	C47,C53,C59,C61,C62,C65,C 69,C70,C73,C74,C102,C103		0.1uF	603	ECJ-1VB1C104K	Panasonic	10%	16V	
3	C60,C63,C107		0.01uF	603	C0603C103K1RACTU	Kemet	10%	100V	
3	C66,C71,C72	DNI	0.1uF	603	ECJ-1VB1C104K_DNI	Panasonic	10%	16V	
1	C67		47uF	TANT_E	TPSE476M020R0150	AVX	10%	20V	
1	C104		33nF	603	06035C333KAT2A	AVX	10%	50V	
4	C105,C106,C111,C112		10nF	603	GCM188R71H103KA3	Murata	10%	50V	
2	C108,C109		27pF	603	GRM1885C2A270JA01D	Murata	5%	100V	
1	C110		10uF	TANT_A	T491A106M010AT	Kemet	20%	10V	
1	C126	DNI	6.8pF	402	GJM1555C1H6R8CB01D_DNI	Murata	.25pF	25V	
2	C128,C129		1uF	402	ECJ-0EB1A105M	Panasonic	20%	10V	
4	C184-C187		1uF	603	ECJ-1V41E105M	Panasonic	20%	25V	
1	C188		4.7uF	1206	GRM31CF51H475ZA01L	Murata	20%	50V	
1	C189		470pF	603	GRM188R71H471MA01D	Murata	20%	50V	
2	C234,C235		2.2uF	1206	ECJ-HVB1A225K	Panasonic			
1	C414		15pF	402	ECJ-0EC1H150J	Panasonic	5%	50V	
1	D1		1N4148	DIODE_SM_SOD_323	1N4148WX-TP	Micro Commercial Co.			
1	D2		B340A-13-F	DIODE_SM_DO_214AC	B340A-13-F	Diodes Inc			
1	D16		LED green	LED_0805	LNJ306G5UUX	Panasonic			
4	JP4,JP5,JP6,JP16	(SHUNT 2-3)	HEADER_1x3_100_430L	HDR_THVT_1x3_100_M	HMTSW-103-07-G-S-.240	SAMTEC			
4	JP12-JP15	(SHUNT 1-2)	HEADER_1x3_100_430L	HDR_THVT_1x3_100_M	HMTSW-103-07-G-S-.240	SAMTEC			
1	JP17	(NO SHUNT)	HEADER_1x2_100_430L	HDR_THVT_1x2_100_M	HMTSW-102-07-G-S-.240	SAMTEC			
2	J1,J12		SMA_END_JACK_RND	SMA_SMEL_250x215	142-0711-821	Johnson Components			
2	J2,J13	DNI	SMA_END_JACK_RND	SMA_SMEL_250x215	142-0711-821_DNI	Johnson Components			
1	J4		CONN_QTH_30X2-D-A	CONN_QTH_30X2-D-A	QTH-060-02-F-D-A	SAMTEC			
1	J5		RED	JACK_THVT_BANANA_500DIA	ST-351A	Allied Electronics			
1	J6		BLK	JACK_THVT_BANANA_500DIA	ST-351B	Allied Electronics			
1	J17		CONN_USB_TYP_B_FEM	CONN_USB_TYPB_FEM	897-43-004-90-000	Milmax			
1	J18		HMTSW-101-07-G-S-.240	HDR_THVT_1x1_SPECIAL	HMTSW-101-07-G-S-.240	SAMTEC			
3	L6,L9,L11		68	1206	EXC-ML32A680U	Panasonic			
1	L7	DNI	68	1206	EXC-ML32A680U_DNI	Panasonic			
1	L16		68uH	IND_SM_MSS1038	MSS1038-683ML	Coilcraft			
1	L18		1K @ 100MHZ	805	BLM21AG102SN1D	Murata			
6	R25,L25,R26,L26,R51,R52		0	402	RC0402JR-070RL	Yageo	5%		1/16W

Qty.	Ref	Note	Part	Foot Print	Part No.	MFR.	Tol	Volt	Rating
1	R8	DNI	10K	603	ERJ-3EKF1002V_DNI	Panasonic	1%		1/10W
3	R16,R65,R77		10K	603	ERJ-3EKF1002V	Panasonic	1%		1/10W
5	R18,R27,R38,R53,R72	DNI	0	603	ERJ-3GEY0R00V_DNI	Panasonic	5%		1/10W
2	R19,R20		100K	603	ERA-3AEB104V	Panasonic	1%		1/16W
1	R21		1M	805	ERJ-6ENF1004V	Panasonic	1%		1/8W
5	R22,R23,R34,R37,R83	DNI	49.9	603	ERJ-3EKF49R9V_DNI	Panasonic	1%		1/10W
2	R24,R29		5.5K	603	ERJ-3EKF2552V	Panasonic	1%		1/10W
8	R28,R30,R33,R54,R67,R78,R82,R86		0	603	ERJ-3GEY0R00V	Panasonic	5%		1/10W
4	R31,R32,R35,R36	DNI	100	603	ERJ-3EKF1000V_DNI	Panasonic	1%		1/10W
4	R39,R40,R55,R56	DNI	0	402	RC0402JR-070RL	Yageo	5%		1/16W
1	R62		30.1K	603	ERJ-3EKF3012V	Panasonic	1%	1/10W	
1	R63		93.1K	603	ERJ-3EKF9312V	Panasonic	1%	1/10W	
1	R64		2.2	603	ERJ-3RQF2R2V	Panasonic	1%	1/10W	
1	R66		3K	603	RC0603FR-073KL	Yageo	1%		1/10W
1	R68		100	603	ERJ-3EKF1000V	Panasonic	1%		1/10W
1	R74		4.7K	603	ERJ-3EKF4701V	Panasonic	1%		1/10W
1	R75		1.5K	603	ERJ-3EKF1501V	Panasonic	5%		1/10W
1	R76		2.21K	603	ERJ-3EKF2211V	Panasonic	1%		1/10W
2	R79,R80		26.7	603	ERJ-3EKF26R7V	Panasonic	1%		1/10W
1	R85		100	201	RC0201FR-07100RL	Yageo	1%		1/20W
1	R109		300	603	ERJ-3EKF3000V	Panasonic			
1	SW1		BF3-1002	SW_THVT_SPST_4_B3F	BF3-1002	Omron			
2	TP1,TP5		TP_THVT_060_RND-WHT	TP_THVT_060_RND	5002	Keystone			
1	T3		ADT4-1WT	TFMR_6_RF_DUAL_FOOTPRINT	JTX-4-10T	Minicircuits			
2	T4,T5		ETC1-1-13	TFMR_6_RF_DUAL_FOOTPRINT	ETC1-1-13	Tyco/Macom			
1	T7	DNI	ADT4-1WT	TFMR_6_RF_DUAL_FOOTPRINT	JTX-4-10T_DNI	Minicircuits			
1	U4		CD4013BM	SOIC_14_344x157_50	CD4013BM	Texas Instruments			
2	U5,U14		TPS79633DCQ	SOT_223_6_TG	TPS79633DCQ	Texas Instruments			
1	U6		SN65LVDS100DGK	HTSSOP_8_122x122_26	SN65LVDS100DGK	Texas Instruments			
1	U7		TPS5420D	SOIC_8_197x157_50	TPS5420D	Texas Instruments			
1	U8		TPS79501DCQ	SOT_223_6_TG	TPS79501DCQ	Texas Instruments			
1	U9		ADS5400	QFP_100_555x555_0p50mm_pwrpad	ADS5400	Texas Instruments			
1	U10		FT245BM	PQFP32	FT245BM	Future Technology			
1	U11		93C66B	TSSOP_8_177x122_26	93C66B-I/ST	Microchip			
1	Y1		6.0000MHz	smd_csm-7_xtal	ECS-60-32-5PDN-TR	ECS			
8	Z_SH-H2,Z_SH-H3,Z_SH-H4,Z_SH-H5,Z_SH-H6,Z_SH-H8,Z_SH-H9,Z_SH-H10	SHUNT FOR HEADER	SHUNT-HEADER		MJ-5.97-G or equivalent	Keltron			

*Physical Description*
[www.ti.com](http://www.ti.com)

Qty.	Ref	Note	Part	Foot Print	Part No.	MFR.	Tol	Volt	Rating
4	Z_STANDOFF SCREW1,Z_STANDOFF SCREW2,Z_STANDOFF SCREW3,Z_STANDOFF SCREW4	SCREW FOR STANDOFF	PANHEAD SCREW 4-40 x 3/8		PMS 440 0038 PH	Building Fasteners			
4	Z_STANDOFF1,Z_STANDOF F2,Z_STANDOFF3,Z_STAND OFF4	STANDOFF	STANDOFF ALUM HEX 4-40 x .500		2203	Keystone			

## EVALUATION BOARD/KIT IMPORTANT NOTICE

Texas Instruments (TI) provides the enclosed product(s) under the following conditions:

This evaluation board/kit is intended for use for **ENGINEERING DEVELOPMENT, DEMONSTRATION, OR EVALUATION PURPOSES ONLY** and is not considered by TI to be a finished end-product fit for general consumer use. Persons handling the product(s) must have electronics training and observe good engineering practice standards. As such, the goods being provided are not intended to be complete in terms of required design-, marketing-, and/or manufacturing-related protective considerations, including product safety and environmental measures typically found in end products that incorporate such semiconductor components or circuit boards. This evaluation board/kit does not fall within the scope of the European Union directives regarding electromagnetic compatibility, restricted substances (RoHS), recycling (WEEE), FCC, CE or UL, and therefore may not meet the technical requirements of these directives or other related directives.

Should this evaluation board/kit not meet the specifications indicated in the User's Guide, the board/kit may be returned within 30 days from the date of delivery for a full refund. **THE FOREGOING WARRANTY IS THE EXCLUSIVE WARRANTY MADE BY SELLER TO BUYER AND IS IN LIEU OF ALL OTHER WARRANTIES, EXPRESSED, IMPLIED, OR STATUTORY, INCLUDING ANY WARRANTY OF MERCHANTABILITY OR FITNESS FOR ANY PARTICULAR PURPOSE.**

The user assumes all responsibility and liability for proper and safe handling of the goods. Further, the user indemnifies TI from all claims arising from the handling or use of the goods. Due to the open construction of the product, it is the user's responsibility to take any and all appropriate precautions with regard to electrostatic discharge.

**EXCEPT TO THE EXTENT OF THE INDEMNITY SET FORTH ABOVE, NEITHER PARTY SHALL BE LIABLE TO THE OTHER FOR ANY INDIRECT, SPECIAL, INCIDENTAL, OR CONSEQUENTIAL DAMAGES.**

TI currently deals with a variety of customers for products, and therefore our arrangement with the user **is not exclusive.**

TI assumes **no liability for applications assistance, customer product design, software performance, or infringement of patents or services described herein.**

Please read the User's Guide and, specifically, the Warnings and Restrictions notice in the User's Guide prior to handling the product. This notice contains important safety information about temperatures and voltages. For additional information on TI's environmental and/or safety programs, please contact the TI application engineer or visit [www.ti.com/esh](http://www.ti.com/esh).

No license is granted under any patent right or other intellectual property right of TI covering or relating to any machine, process, or combination in which such TI products or services might be or are used.

### FCC Warning

This evaluation board/kit is intended for use for **ENGINEERING DEVELOPMENT, DEMONSTRATION, OR EVALUATION PURPOSES ONLY** and is not considered by TI to be a finished end-product fit for general consumer use. It generates, uses, and can radiate radio frequency energy and has not been tested for compliance with the limits of computing devices pursuant to part 15 of FCC rules, which are designed to provide reasonable protection against radio frequency interference. Operation of this equipment in other environments may cause interference with radio communications, in which case the user at his own expense will be required to take whatever measures may be required to correct this interference.

### EVM WARNINGS AND RESTRICTIONS

It is important to operate this EVM within the input voltage range of -0.3 V to 5.3 V and the output voltage range of -0.3 V to 3.3 V.

Exceeding the specified input range may cause unexpected operation and/or irreversible damage to the EVM. If there are questions concerning the input range, please contact a TI field representative prior to connecting the input power.

Applying loads outside of the specified output range may result in unintended operation and/or possible permanent damage to the EVM. Please consult the EVM User's Guide prior to connecting any load to the EVM output. If there is uncertainty as to the load specification, please contact a TI field representative.

During normal operation, some circuit components may have case temperatures greater than 50°C. The EVM is designed to operate properly with certain components above 25°C as long as the input and output ranges are maintained. These components include but are not limited to linear regulators, switching transistors, pass transistors, and current sense resistors. These types of devices can be identified using the EVM schematic located in the EVM User's Guide. When placing measurement probes near these devices during operation, please be aware that these devices may be very warm to the touch.

Mailing Address: Texas Instruments, Post Office Box 655303, Dallas, Texas 75265  
Copyright © 2009, Texas Instruments Incorporated



## IMPORTANT NOTICE

Texas Instruments Incorporated and its subsidiaries (TI) reserve the right to make corrections, modifications, enhancements, improvements, and other changes to its products and services at any time and to discontinue any product or service without notice. Customers should obtain the latest relevant information before placing orders and should verify that such information is current and complete. All products are sold subject to TI's terms and conditions of sale supplied at the time of order acknowledgment.

TI warrants performance of its hardware products to the specifications applicable at the time of sale in accordance with TI's standard warranty. Testing and other quality control techniques are used to the extent TI deems necessary to support this warranty. Except where mandated by government requirements, testing of all parameters of each product is not necessarily performed.

TI assumes no liability for applications assistance or customer product design. Customers are responsible for their products and applications using TI components. To minimize the risks associated with customer products and applications, customers should provide adequate design and operating safeguards.

TI does not warrant or represent that any license, either express or implied, is granted under any TI patent right, copyright, mask work right, or other TI intellectual property right relating to any combination, machine, or process in which TI products or services are used. Information published by TI regarding third-party products or services does not constitute a license from TI to use such products or services or a warranty or endorsement thereof. Use of such information may require a license from a third party under the patents or other intellectual property of the third party, or a license from TI under the patents or other intellectual property of TI.

Reproduction of TI information in TI data books or data sheets is permissible only if reproduction is without alteration and is accompanied by all associated warranties, conditions, limitations, and notices. Reproduction of this information with alteration is an unfair and deceptive business practice. TI is not responsible or liable for such altered documentation. Information of third parties may be subject to additional restrictions.

Resale of TI products or services with statements different from or beyond the parameters stated by TI for that product or service voids all express and any implied warranties for the associated TI product or service and is an unfair and deceptive business practice. TI is not responsible or liable for any such statements.

TI products are not authorized for use in safety-critical applications (such as life support) where a failure of the TI product would reasonably be expected to cause severe personal injury or death, unless officers of the parties have executed an agreement specifically governing such use. Buyers represent that they have all necessary expertise in the safety and regulatory ramifications of their applications, and acknowledge and agree that they are solely responsible for all legal, regulatory and safety-related requirements concerning their products and any use of TI products in such safety-critical applications, notwithstanding any applications-related information or support that may be provided by TI. Further, Buyers must fully indemnify TI and its representatives against any damages arising out of the use of TI products in such safety-critical applications.

TI products are neither designed nor intended for use in military/aerospace applications or environments unless the TI products are specifically designated by TI as military-grade or "enhanced plastic." Only products designated by TI as military-grade meet military specifications. Buyers acknowledge and agree that any such use of TI products which TI has not designated as military-grade is solely at the Buyer's risk, and that they are solely responsible for compliance with all legal and regulatory requirements in connection with such use.

TI products are neither designed nor intended for use in automotive applications or environments unless the specific TI products are designated by TI as compliant with ISO/TS 16949 requirements. Buyers acknowledge and agree that, if they use any non-designated products in automotive applications, TI will not be responsible for any failure to meet such requirements.

Following are URLs where you can obtain information on other Texas Instruments products and application solutions:

### Products

Amplifiers	<a href="http://amplifier.ti.com">amplifier.ti.com</a>
Data Converters	<a href="http://dataconverter.ti.com">dataconverter.ti.com</a>
DLP® Products	<a href="http://www.dlp.com">www.dlp.com</a>
DSP	<a href="http://dsp.ti.com">dsp.ti.com</a>
Clocks and Timers	<a href="http://www.ti.com/clocks">www.ti.com/clocks</a>
Interface	<a href="http://interface.ti.com">interface.ti.com</a>
Logic	<a href="http://logic.ti.com">logic.ti.com</a>
Power Mgmt	<a href="http://power.ti.com">power.ti.com</a>
Microcontrollers	<a href="http://microcontroller.ti.com">microcontroller.ti.com</a>
RFID	<a href="http://www.ti-rfid.com">www.ti-rfid.com</a>
RF/IF and ZigBee® Solutions	<a href="http://www.ti.com/lprf">www.ti.com/lprf</a>

### Applications

Audio	<a href="http://www.ti.com/audio">www.ti.com/audio</a>
Automotive	<a href="http://www.ti.com/automotive">www.ti.com/automotive</a>
Broadband	<a href="http://www.ti.com/broadband">www.ti.com/broadband</a>
Digital Control	<a href="http://www.ti.com/digitalcontrol">www.ti.com/digitalcontrol</a>
Medical	<a href="http://www.ti.com/medical">www.ti.com/medical</a>
Military	<a href="http://www.ti.com/military">www.ti.com/military</a>
Optical Networking	<a href="http://www.ti.com/opticalnetwork">www.ti.com/opticalnetwork</a>
Security	<a href="http://www.ti.com/security">www.ti.com/security</a>
Telephony	<a href="http://www.ti.com/telephony">www.ti.com/telephony</a>
Video & Imaging	<a href="http://www.ti.com/video">www.ti.com/video</a>
Wireless	<a href="http://www.ti.com/wireless">www.ti.com/wireless</a>

Mailing Address: Texas Instruments, Post Office Box 655303, Dallas, Texas 75265  
Copyright © 2009, Texas Instruments Incorporated