

TPS6521815 Power Management Integrated Circuit (PMIC) for Industrial Applications

ABSTRACT

This application report reviews the TPS6521815 device power management integrated circuit (PMIC) for industrial applications. It describes the advantages of using the TPS6521815 device and the unique characteristics of the integrated buck-boost converter, including the expected frequency spurs with different input voltages and the potential impacts to systems for different applications. Some special features of the PMIC are also discussed (for example, the battery back-up property and tampering detection).

Contents

1	Applications Using TPS6521815 PMIC	2
2	Applications With ARM Processors	2
3	Applications With FPGAs	2
4	Introduction to TPS6521815 PMIC	2
5	The Buck-Boost Converter	3
6	Switching Waveforms of the Buck-Boost	4
7	Potential Impacts to System Performance	6
8	Security Features	7
9	Conclusion	7
10	References	7

⁽¹⁾ ARM, Cortex are registered trademarks of ARM Limited.

⁽²⁾ Sitara is a trademark of Sitara, LLC.

1 Applications Using TPS6521815 PMIC

The TPS6521815 device is a single-chip power-management IC, that supports the AM335x and AM437x line of the Sitara™ processors in both portable (Li-Ion battery) and nonportable (5-V adapter) applications. The TPS6521815 device also supports other ARM® system on chips (SoCs) and field programmable gate array (FPGA) systems.

2 Applications With ARM Processors

Ethernet for Control Automation Technology (EtherCAT) [1] is an emerging real-time industrial Ethernet standard for industrial automation applications, such as input/output (I/O) devices, sensors, and programmable logic controllers (PLCs). Texas Instruments has integrated EtherCAT into several Sitara processors, including the AM335x ARM® Cortex®-A8 and the AM437x ARM Cortex-A9 devices[2].

3 Applications With FPGAs

In today's industrial systems, there is a need to create high performing, reliable, and flexible systems [3]. FPGAs can integrate many features such as motor control, DSP functions, Ethernet, communication standards and more. The devices are fully programmable and allow designers to build specific hardware architectures around the requirements that are needed to meet the end application [3]. The TPS6521815 device has the power and the flexibility to power low and mid-end FPGAs for many different types of industrial applications.

4 Introduction to TPS6521815 PMIC

The TPS6521815 device provides three step-down converters, three load switches, three general-purpose I/Os, two battery-backup supplies, one buck-boost converter, and one LDO. Each of the three hysteretic step-down converters can supply up to 1.8 A of current. These step-down converters operate in a low-power mode at light load and can be forced into PWM operation for noise-sensitive applications. The buck-boost converter (DCDC4) on the TPS6521815 device is designed to operate with a constant output voltage of 3.3 V and supply up to 1 A of loading current.

In this application report, the buck-boost converter is used to demonstrate the potential impacts of power supply noise to EtherCAT system performance, for example, the eye-diagram at the output of a transmitter for 100-Mbps Ethernet applications. Be aware of these properties to avoid the detrimental effects.

5 The Buck-Boost Converter

The TPS6521815 PMIC device can be used for applications with Li-ion battery or a 5-V adapter. The buck-boost converter operates in buck mode when the input voltage is greater than 3.3 V and enters into boost mode when the input voltage drops below 3.3 V.

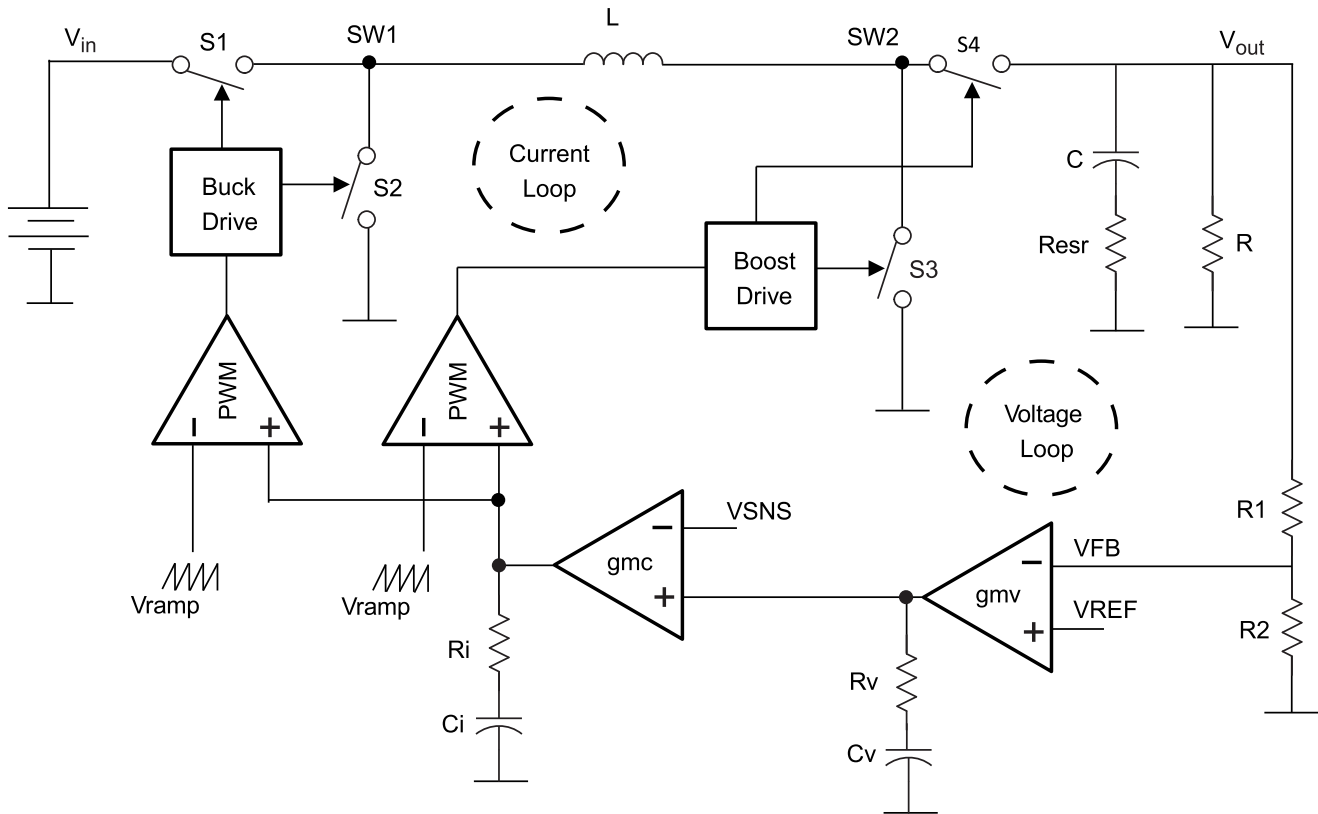

Figure 1. Typical Buck-Boost Topology

The buck-boost devices are designed to operate in buck and in boost modes, but avoid the classical buck-boost operation where all four switches are active during one clock cycle. Very high efficiency can be achieved when running the DCDC converter either in buck mode or in boost mode. As shown in Figure 1, the buck-boost converter uses an average current-mode topology. There is an inner current loop and an outer voltage loop that has significantly lower bandwidth than the current loop bandwidth to avoid instability. The switches have been realized in LBC7 technology with LDMOS transistors, which have very low on-resistance.

6 Switching Waveforms of the Buck-Boost

To fully understand the potential impact of power supply noise, this section focuses on the waveforms at the two switching nodes of the single inductor when the input voltage varies. As shown in [Figure 2](#), when $V_{IN} = 5\text{ V}$ and $V_{IN} > V_{OUT}$, the converter is in buck mode; switch S4 is always on and switch S3 is always off. On the other hand, switch S1 and switch S2 are switching to regulate the input voltage down to $V_{OUT} = 3.3\text{ V}$. The switching frequency is 2 MHz and the inductor used is 1 μH . The peak-to-peak inductor current is around 0.5 A and the RMS value is approximately 1 A of loading current. [Figure 3](#) shows the frequency spectrum of the switching waveform at the SW1 node. Even though the output ripple could be minimized by a large output capacitor, a frequency spur component at the switching frequency still exists in the output voltage.

V_{IN} continues to drop; then when V_{IN} is approximately equal to V_{OUT} , the converter goes into buck-boost mode. [Figure 4](#) shows that the controller operates in buck mode by toggling the S1 and S2 switches for one clock cycle and in boost mode by toggling the S3 and S4 switches for the next clock cycle. [Figure 4](#) shows that the SW1 and SW2 switching nodes toggle only in alternate clock cycles, not in every clock cycle. In other words, the switching frequency of the SW1 and SW2 nodes becomes $\frac{1}{2}$ of the regular switching frequency. As shown in [Figure 3](#), the frequency spectrum of the SW nodes contains a 1-MHz component now and is 0.5 times the regular 2-MHz switching frequency. The inductor current waveform remains at a plateau value when there is no switching action in either SW1 or SW2 node because the voltage delta across the inductor becomes zero and V_{IN} is approximately equal to V_{OUT} .

As $V_{IN} < V_{OUT}$, the converter goes into boost mode. As shown in [Figure 4](#), the S3 and S4 switches are switching for boost action; S1 is always on and S2 is always off. The inductor current now represents the input current that must be larger than the output loading current because V_{IN} is less than V_{OUT} . The frequency spectrum of the SW2 node becomes 2 MHz and its harmonics are as shown in [Figure 5](#). Because the SW2 node is connected directly to the output, the output ripple becomes more significant.

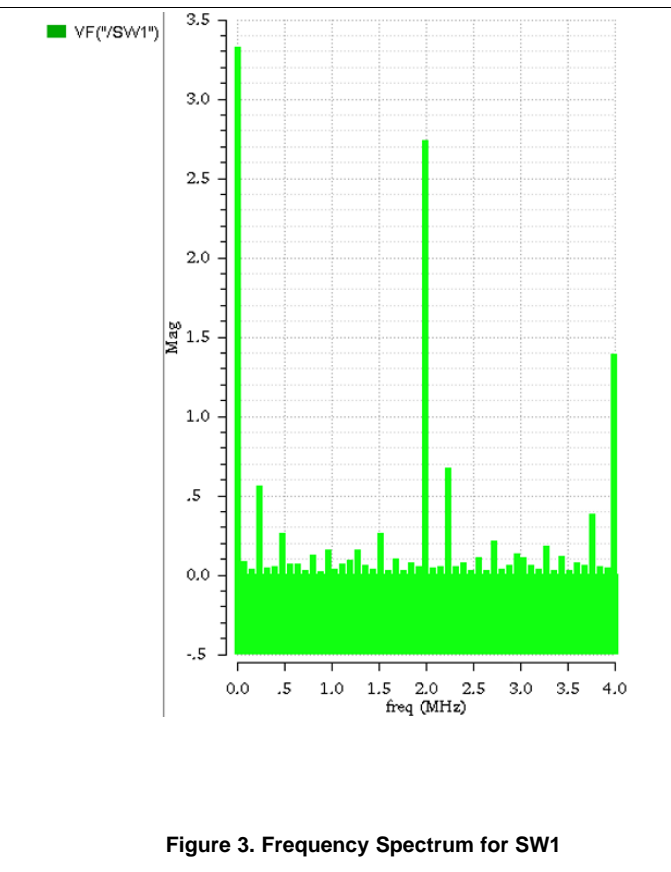
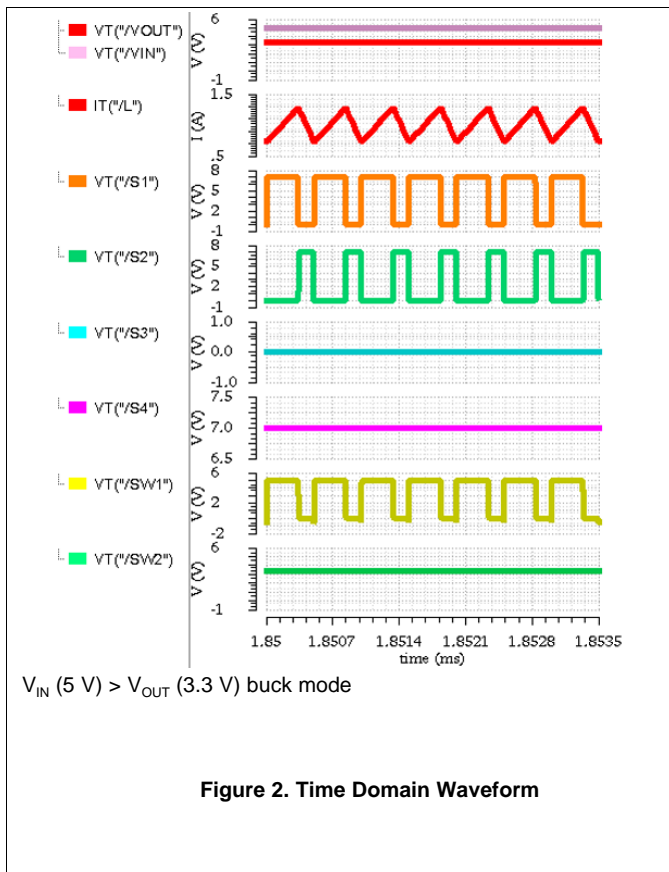

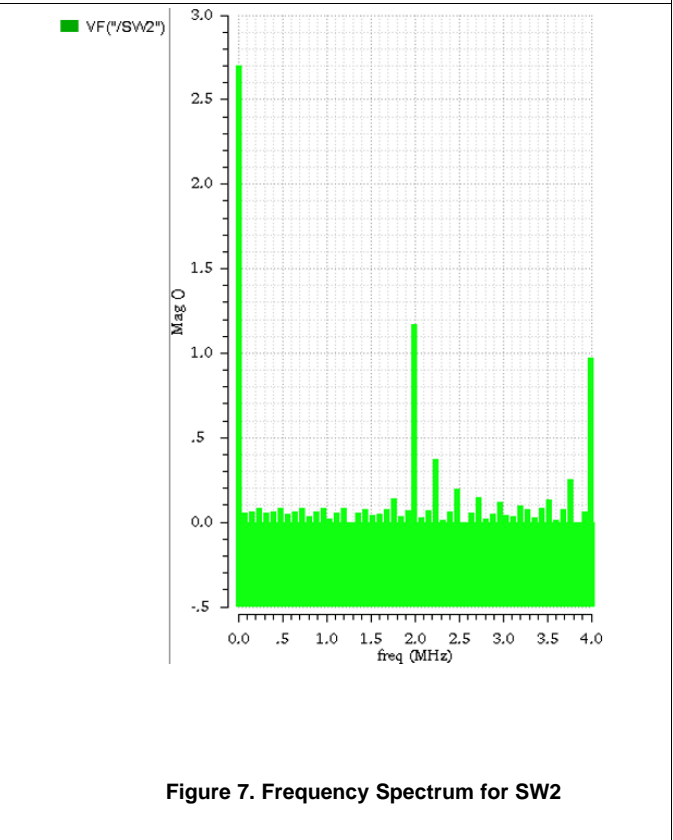
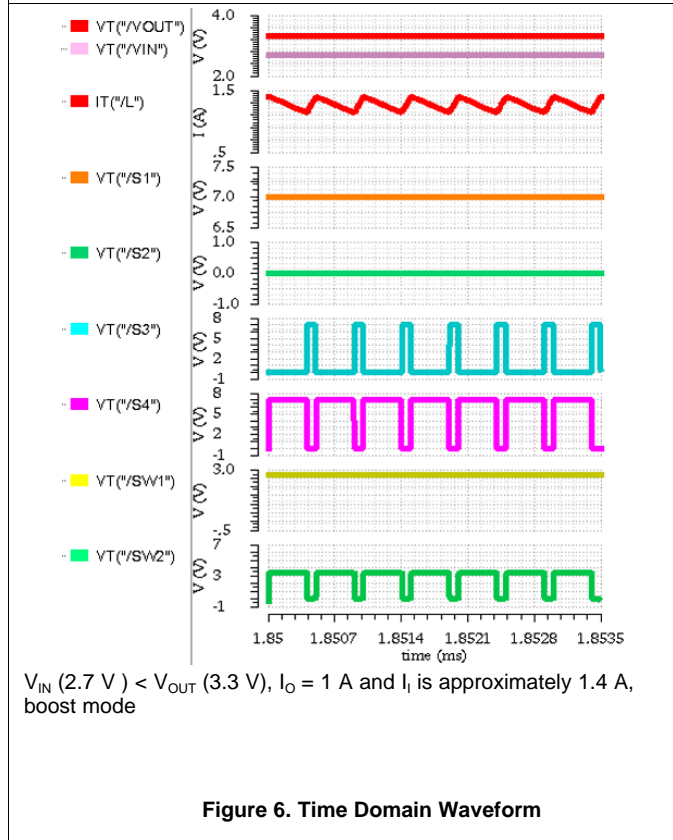
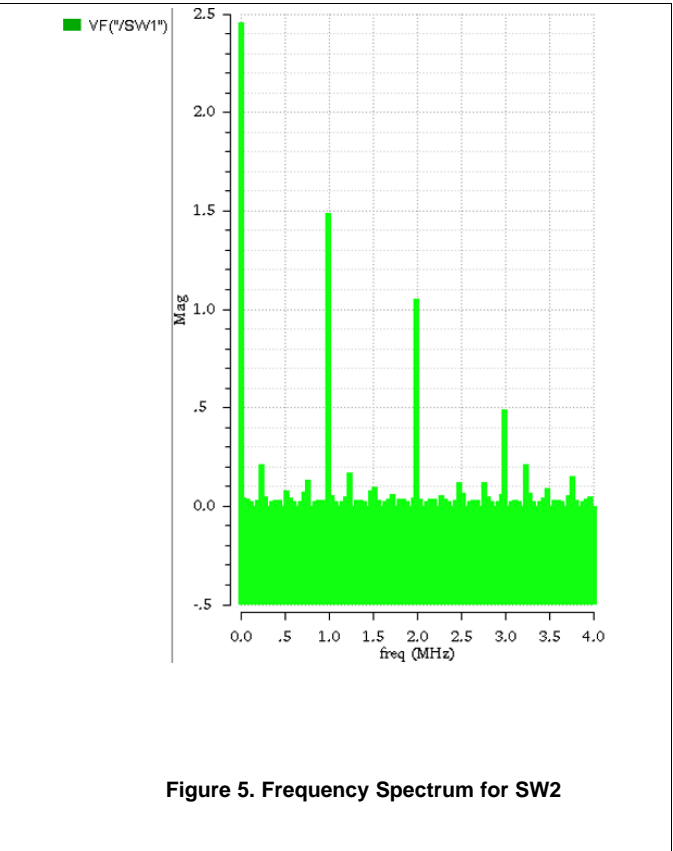
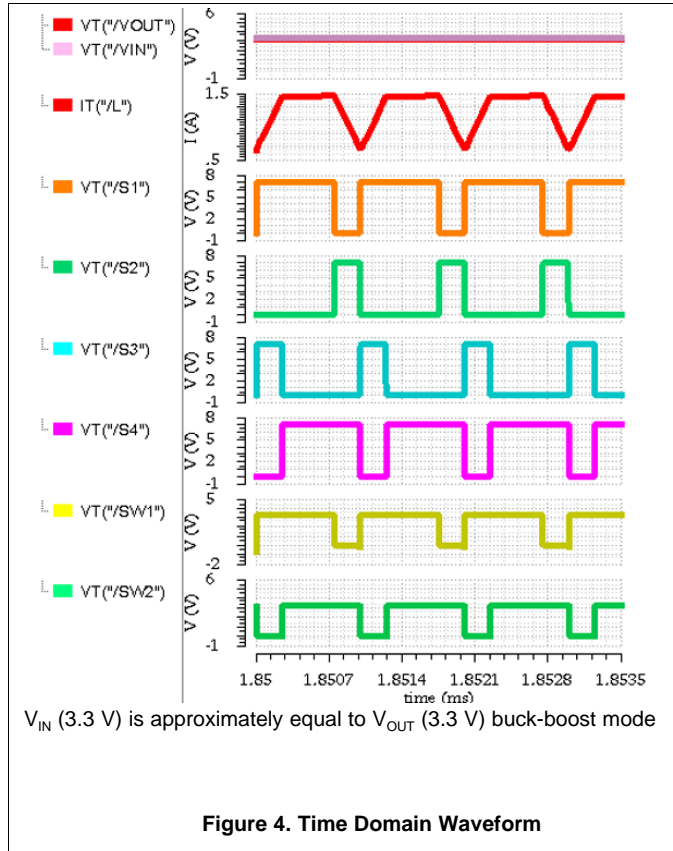

7 Potential Impacts to System Performance

The buck-boost output is usually used to power analog circuits and I/Os of the AM335x, AM437x, and other ARM SoC and FPGA devices. Special attention is required to ensure the frequency spur level is low enough to not degrade the jitter requirements of the 100-Mbps Ethernet wire-line applications. As shown in Figure 8, the eye diagram is clean without deterministic jitter. On the other hand, if the power supply noise is significant, deterministic jitter shows up in the eye diagram of the transmitter output. Fortunately on the receiver side, if the bandwidth is high enough, it rejects the noise with frequency contents less than its bandwidth and recovers data with low bit-error rates. Thus, all the trade-offs must be considered for the overall transceiver-jitter budget, including the contribution of power supply noise. For wireless application, a band-pass filter is used to remove unwanted spurs in the receiver, which must have a higher Q to remove the spurs at 0.5 times the switching frequency.

Some of the advantages for using the TPS6521815 PMIC over many discrete devices are the following:

- Smaller package size and efficient PCB board routing
- Centralized reference voltage and bias currents for minimum quiescent current
- Controllable noise and jitter performance

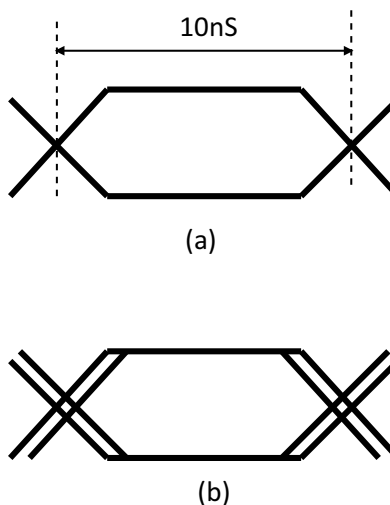

The expected eye-diagram at transmitter output for 100-Mbps Ethernet: eye-diagrams a) without b) with significant deterministic jitter.

Figure 8. Expected Eye Diagrams

8 Security Features

For industrial applications that require a heightened security protection against tampering or other risks, the TPS6521815 device has a new feature called Freshness Seal (FSEAL). This feature acts like a seal on the operation of two always-on backup DCDCs. If the FSEAL is enabled, the devices backup DCDCs cannot be turned off or tampered with through any software command or hardware enable signal. When the FSEAL is enabled, it remains enabled for as long as the device has either a backup battery or main supply available.

The FSEAL feature is great for certain applications that require tamper protection or heightened security against malfunctions like ePOS, ATMs, or critical-to-function equipment. The two DCDCs can supply the application processor of the system. With these always-on supplies, the processor can run tamper-protection software continuously on the system. The system has a reduced risk of tampering from an outside source because the DCDCs are always on and cannot be turned off as long as either the main supply or backup battery is available.

The DCDC implementation for these two supplies is excellent for long battery life products because the DCDC efficiency can be 2.4 times that of an LDO implementation with a load current of 50 μ A.

9 Conclusion

The TPS6521815 PMIC is an excellent solution for industrial applications using ARM SoCs and FPGAs. There are advantages and unique characteristics of the PMIC, including the switching waveforms of the buck-boost converter. With proper understanding of the characteristics, users are able to fully utilize the PMIC without system performance impacts. Several key features of the TPS6521815 device include battery back-up property, tampering protection, voltage supervision, and more. The TPS6521815 device offers ease of use and flexibility to use across multiple applications and platforms.

10 References

- [1] *EtherCAT[®] on Sitara[™] Processors* ([SPRY187](#))
- [2] *Powering the AM335x/AM437x With TPS65218D0* ([SLVUAA9](#))
- [3] *FPGAs in Industrial Control Applications* Industrial Informatics, Monmasson, E.; Idkhajine, L.; Cirstea, M.N.; Bahri, I.; Tisan, A.; Naouar, M.W.

Revision History

NOTE: Page numbers for previous revisions may differ from page numbers in the current version.

Changes from Original (June 2015) to A Revision	Page
• Changed Device Name From: <i>TPS65218</i> To: <i>TPS6521815</i>	2

IMPORTANT NOTICE AND DISCLAIMER

TI PROVIDES TECHNICAL AND RELIABILITY DATA (INCLUDING DATASHEETS), DESIGN RESOURCES (INCLUDING REFERENCE DESIGNS), APPLICATION OR OTHER DESIGN ADVICE, WEB TOOLS, SAFETY INFORMATION, AND OTHER RESOURCES "AS IS" AND WITH ALL FAULTS, AND DISCLAIMS ALL WARRANTIES, EXPRESS AND IMPLIED, INCLUDING WITHOUT LIMITATION ANY IMPLIED WARRANTIES OF MERCHANTABILITY, FITNESS FOR A PARTICULAR PURPOSE OR NON-INFRINGEMENT OF THIRD PARTY INTELLECTUAL PROPERTY RIGHTS.

These resources are intended for skilled developers designing with TI products. You are solely responsible for (1) selecting the appropriate TI products for your application, (2) designing, validating and testing your application, and (3) ensuring your application meets applicable standards, and any other safety, security, or other requirements. These resources are subject to change without notice. TI grants you permission to use these resources only for development of an application that uses the TI products described in the resource. Other reproduction and display of these resources is prohibited. No license is granted to any other TI intellectual property right or to any third party intellectual property right. TI disclaims responsibility for, and you will fully indemnify TI and its representatives against, any claims, damages, costs, losses, and liabilities arising out of your use of these resources.

TI's products are provided subject to TI's Terms of Sale (www.ti.com/legal/termsofsale.html) or other applicable terms available either on ti.com or provided in conjunction with such TI products. TI's provision of these resources does not expand or otherwise alter TI's applicable warranties or warranty disclaimers for TI products.

Mailing Address: Texas Instruments, Post Office Box 655303, Dallas, Texas 75265
Copyright © 2020, Texas Instruments Incorporated