

1 Trademarks

bq2461x/bq2463x EVM (HPA422) Multi-Cell Synchronous Switch-Mode Charger

Contents

2	Introduction	3
	2.1 EVM Features	3
	2.2 General Description	3
	2.3 I/O Description	3
	2.4 1.4 Controls and Key Parameters Setting	4
	2.5 Recommended Operating Conditions	4
3	Test Summary	5
	3.1 Definitions	5
	3.2 Equipment	5
	3.3 Equipment Setup	6
	3.4 Procedure	7
4	PCB Layout Guideline	9
5	Bill of Materials, Board Layout and Schematics	11
	5.1 Bill of Materials	11
6	Board Layout	14
7	Schematics	22

List of Figures

1	Original Test Setup for HPA422 (bq2461x/bq2463x EVM)	6
2	Top Layer	14
3	2 nd Layer	15
4	3 rd Layer	16
5	Bottom Layer	17
6	Top Assembly	18
7	Bottom Assembly	19
8	Top Silkscreen	20
9	Bottom Silkscreen	21
10	bq2461x/bq2463x EVM Schematic	22

List of Tables

1	I/O Description	3
2	Controls and Key Parameters Setting	4
3	Recommended Operating Conditions	4
4	Bill of Materials	11

2 Introduction

2.1 EVM Features

- Evaluation Module For bq2461x/bq2463x
- High Efficiency Synchronous Buck Charger
- User-programmable up to 26V Battery Voltage
- AC Adapter Operating Range 5 V–28 V
- LED Indication for Control and Status Signals.
- Test Points for Key Signals Available for Testing Purpose. Easy Probe Hook-up.
- Jumpers Available. Easy to Change Connections.

2.2 General Description

The bq2461x is highly integrated Li-ion or Li-polymer switch-mode battery charge controllers. The bq2463x is highly integrated switch-mode battery charge controllers designed specifically to charge Lithium Phosphate battery chemistries.

They offer a constant-frequency synchronous PWM controller with high accuracy charge current and voltage regulation, adapter current regulation, termination, charge preconditioning, and charge status monitoring,

The bq2461x/bq2463x charges the battery in three phases: preconditioning, constant current, and constant voltage. Charge is terminated when the current reaches a minimum user-selectable level. A programmable charge timer provides a safety backup for charge termination. The bq2461x/bq2463x automatically restarts the charge cycle if the battery voltage falls below an internal threshold, and enters a low-quiescent current sleep mode when the input voltage falls below the battery voltage.

The dynamic power management (DPM) function modifies the charge current depending on system load conditions, avoiding ac adapter overload.

High accuracy current sense amplifiers enable accurate measurement of the ac adapter current, allowing monitoring of overall system power.

For details, see bq24610 and bq24617 ([SLUS892](#)), bq24616 ([SLUSA49](#)) and bq2463x ([SLUS894](#)) data sheets. Project collateral discussed in this document can be downloaded from the following URL: <http://www.ti.com/lit/zip/SLUU396>.

2.3 I/O Description

Table 1. I/O Description

Jack	Description
J1–DCIN	AC adapter, positive output
J1–GND	AC adapter, negative output
J2–VEXT	External power supply, positive output
J2–GND	External power supply, negative output
J2–TTC	Timer capacitor pin
J3–ACSET	Input current program pin
J3–ISET1	Charge Current Program Pin
J3–ISET2	Pre-charge/Termination program pin
J3–GND	Ground
J–PG	Power Good (active low)
J4–CHGEN	Charge enable
J4–VREF	IC reference voltage VREF
J4–TS	Temperature Qualification Voltage Input
J5–VSY	Connected to system

Table 1. I/O Description (continued)

Jack	Description
J5-VBAT	Connected to battery pack
J5-GND	Ground
JP1-LOW	Ground
JP1-TTC	Timer capacitor pin
JP1-HI	Pull-up voltage source
JP2-HI	Pull-up voltage source
JP2-LEDPWR	LED Pull-up power line
JP3-VREF	IC reference voltage VREF
JP3-VPULLUP	Pull-up voltage source
JP3-EXT	External voltage supply from J2
JP4-VCC	Pull-up voltage source of ACDRV and BATDRV LED logic circuit
JP4-VCOM	Q7 and Q11 common source
JP5-HI	Pull-up voltage source
JP5-CHGEN	Charge enable

2.4 1.4 Controls and Key Parameters Setting

Table 2. Controls and Key Parameters Setting

Jack	Description	Factory Setting
JP1	TTC setting 1-2 : Connect TTC to GROUND (Disable termination and the safety timer) 2-3 : Connect TTC to VPULLUP (Allow termination, but disable the safety time) 2 floating: Allow termination, CTTC sets the safety timer	Jumper on 2-3 (TTC and VPULLUP)
JP2	The pull-up power source supplies the LEDs when on. LED has no power source when off.	Jumper On
JP3	VPULLUP setting 1-2 : Connect VPULLUP to VREF 2-3 : Connect VPULLUP to VEXT	Jumper On 1-2 (VPULLUP and VREF)
JP4	The pull-up voltage source of ACDRV and BATDRV LED logic circuit.	Jumper on
JP5	CHGEN setting Jumper on: CHGEN to VPULLUP Jumper off: CHGEN is set to low by pull down resistor.	Jumper Off

2.5 Recommended Operating Conditions

Table 3. Recommended Operating Conditions

Symbol	Description	Min	Typ	Max	Unit
Supply voltage, V_{IN}	Input voltage from ac adapter input	5	24	24(617) 28 (610/616/63x)	V
Battery voltage, V_{BAT}	Voltage applied at VBAT terminal of J5	2.1 (61x) 1.8 (63x)	21 (61x) 18 (63x)		V
Supply current, I_{AC}	Maximum input current from ac adapter input	0		4.5	A
Charge current, I_{chg}	Battery charge current	2	3	8	A
Operating junction temperature range, T_J		0		125	°C

The bq2461x/bq2463x EVM board requires a regulated supply approximately 0.5 V minimum above the regulated voltage of the battery pack to a maximum input voltage of 28 VDC.

R25 and R28 can be changed to regulate output.

$$V_{\text{BAT}} = 2.1\text{V} \times [1 + R25/R28]; \text{ for bq2461x};$$

$$V_{\text{BAT}} = 1.8\text{V} \times [1 + R25/R28]; \text{ for bq2463x};$$

Adjust the input voltage as required. Output set to operate at 21V (bq2461x) or 18V (bq2463x) from the factory.

3 Test Summary

3.1 Definitions

This procedure details how to configure the HPA422 evaluation board. On the test procedure the following naming conventions are followed. See the HPA422 schematic for details.

VXXX:	External voltage supply name (VADP, VBT, VSBT)
LOADW:	External load name (LOADR, LOADI)
V(TPyyy):	Voltage at internal test point TPyyy. For example, V(TP12) means the voltage at TP12
V(Jxx):	Voltage at jack terminal Jxx.
V(TP(XXX)):	Voltage at test point "XXX". For example, V(ACDET) means the voltage at the test point which is marked as "ACDET".
V(XXX, YYY):	Voltage across point XXX and YYY.
I(JXX(YYY)):	Current going out from the YYY terminal of jack XX.
Jxx(BBB):	Terminal or pin BBB of jack xx
Jxx ON:	Internal jumper Jxx terminals are shorted
Jxx OFF:	Internal jumper Jxx terminals are open
Jxx (-YY-) ON:	Internal jumper Jxx adjacent terminals marked as "YY" are shorted
Measure:→ A,B	Check specified parameters A, B. If measured values are not within specified limits the unit under test has failed.
Observe → A,B	Observe if A, B occur. If they do not occur, the unit under test has failed.

Assembly drawings have location for jumpers, test points and individual components.

3.2 Equipment

3.2.1 Power Supplies

Power Supply #1 (PS#1): a power supply capable of supplying 30-V at 5-A is required.

Power Supply #2 (PS#2): a power supply capable of supplying 5-V at 1-A is required.

Power Supply #3 (PS#3): a power supply capable of supplying 5-V at 1-A is required.

3.2.2 LOAD #1

A 30V (or above), 5A (or above) electronic load that can operate at constant current mode

3.2.3 LOAD #2

A Kepco bipolar operational power supply/amplifier, 0 ±30V (or above), 0 ±6A (or above).

3.2.4 Oscilloscope

Tektronix TDS3054 scope or equivalent, 10X voltage probe.

3.2.5 METERS

Seven Fluke 75 multimeters, (equivalent or better)
 Or: Four equivalent voltage meters and three equivalent current meters.
 The current meters must be capable of measuring 5A+ current

3.3 Equipment Setup

1. Set the power supply #1 for $0V \pm 100mVDC$, $5.0 \pm 0.1A$ current limit and then turn off supply.
2. Connect the output of power supply #1 in series with a current meter (multimeter) to J1 (VIN, GND).
3. Connect a voltage meter across J1 (VIN, GND).
4. Set the power supply #2 for $0V \pm 100mVDC$, $1.0 \pm 0.1A$ current limit and then turn off supply.
5. Connect the output of the power supply #2 to J4 and J5 (TS, GND).
6. Connect Load #1 in series with a current meter to J5 (SYS, GND). Turn off Load #1
7. Connect Load #2 in series with a current meter to J5 (BAT, GND). Turn off Load #2.
8. Connect a voltage meter across J5 (BAT, GND).
9. Connect an oscilloscope's probe across J5 (BAT, GND)
10. Connect a voltage meter across J5 (SYS, GND).
11. JP1 (TTC and HI): ON, JP2: ON, JP3 (VPULLUP and VREF): ON, JP4: ON, JP5: OFF.

After the above steps, the test setup for HPA422 is shown in [Figure 1](#).

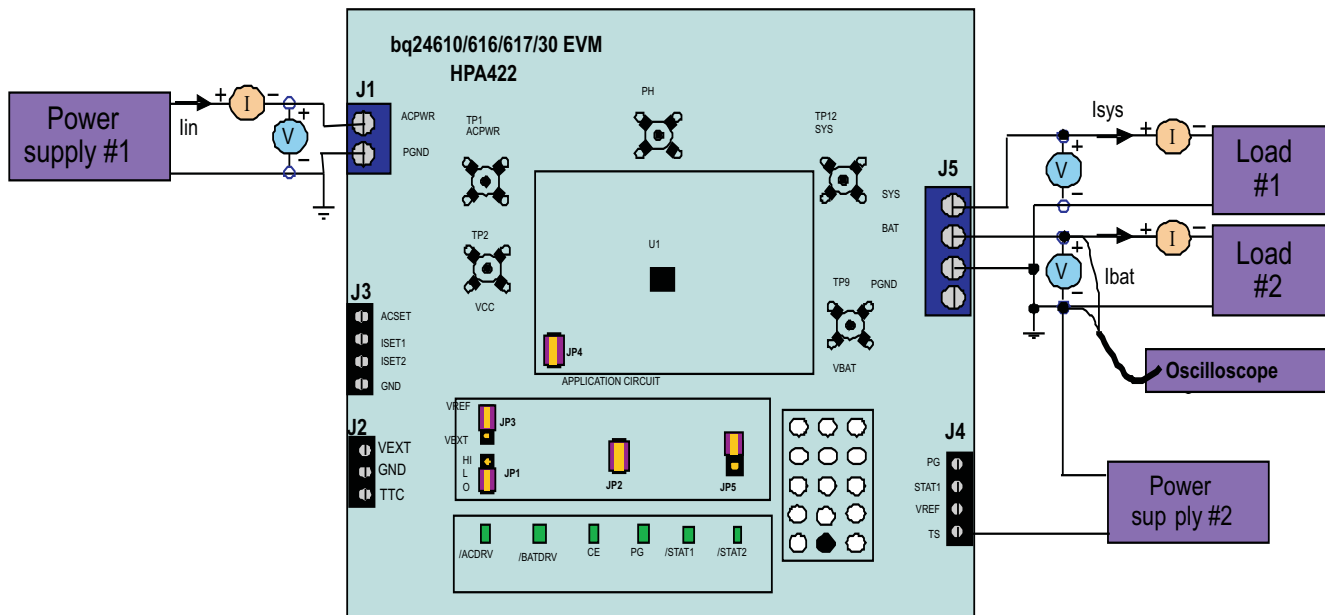

Figure 1. Original Test Setup for HPA422 (bq2461x/bq2463x EVM)

3.4 Procedure

3.4.1 AC Adapter Detection Threshold

1. Make sure EQUIPMENT SETUP steps are followed. Turn on PS#2.
2. Turn on PS#1
Measure → V(J5(SYS)) = $0 \pm 500\text{mV}$
Measure → V(TP(VREF)) = $0\text{V} \pm 1000\text{mV}$
Measure → V(TP(REGN)) = $0\text{V} \pm 500\text{mV}$
3. Increase the output voltage on PS#1 until D5 ($\overline{\text{PG}}$) on but do not exceed 5V. Set the power supply #2 to $1.8\text{V} \pm 100\text{mVDC}$
Measure → V(J1(VIN)) = $4.5\text{V} \pm 0.5\text{V}$
Measure → V(J5(SYS)) = $4.5\text{V} \pm 0.5\text{V}$
Measure → V(TP(VREF)) = $3.3\text{V} \pm 200\text{mV}$
Measure → V(TP(REGN)) = $0\text{V} \pm 500\text{mV}$
Measure → D4 (/ACDRV) on, D5 ($\overline{\text{PG}}$) on

3.4.2 Charger Regulation Voltage

1. Increase the voltage of PS#1 until V(J1(VIN)) = $24\text{V} \pm 0.1\text{V}$.
Measure → V(J5(BAT, GND)) = $0\text{V} \pm 1\text{V}$
2. Put JP5 on (Enable the charging).
 Observe → D3 (CE) on.
Measure → Peak V(J5(BAT)) = $21.0\text{V} \pm 1\text{V}$ (bq2461x)
 Peak V(J5(BAT)) = $18.0\text{V} \pm 1\text{V}$ (bq2463x)
Measure → V(TP(REGN)) = $6\text{V} \pm 500\text{mV}$

3.4.3 Charge Current and AC Current Regulation (DPM)

1. Take off JP5 (Disable the charging).
2. Connect the Load #2 in series with a current meter (multimeter) to J5 (BAT, GND). Make sure a voltage meter is connected across J5 (BAT, GND). Turn on the Load #2. Set the output voltage to 12V (bq2461x) or 2V (bq2463x).
3. Connect the output of the Load #1 in series with a current meter (multimeter) to J5 (SYS, GND). Make sure a voltage meter is connected across J5 (SYS, GND). Turn on the power of the Load #1. Set the load current to $3.0\text{A} \pm 50\text{mA}$ but disable the load #1. The setup is now like [Figure 1](#) for HPA422. Make sure $I_{\text{bat}} = 0\text{A} \pm 10\text{mA}$ and $I_{\text{sys}} = 0\text{A} \pm 10\text{mA}$.
4. Put JP5 on (Enable the charging).
 Observe → D3 (CE) on
Measure → $I_{\text{bat}} = 300\text{mA} \pm 200\text{mA}$ (bq2461x)
 $I_{\text{bat}} = 125\text{mA} \pm 60\text{mA}$ (bq2463x)
 Observe → D7 ($\overline{\text{STAT1}}$) on; D8 ($\overline{\text{STAT2}}$) off.
5. Set the Load #2 output voltage to 16.5V.
Measure → $I_{\text{bat}} = 3000\text{mA} \pm 300\text{mA}$
 Observe → D7 ($\overline{\text{STAT1}}$) on; D8 ($\overline{\text{STAT2}}$) off.
6. Enable the output of the Load #1
Measure → $I_{\text{sys}} = 3000\text{mA} \pm 200\text{mA}$, $I_{\text{bat}} = 1400\text{mA} \pm 500\text{mA}$, $I_{\text{in}} = 4000\text{mA} \pm 500\text{mA}$
7. Turn off the Load #1.
Measure → $I_{\text{sys}} = 0 \pm 100\text{mA}$, $I_{\text{bat}} = 3000\text{mA} \pm 300\text{mA}$.
8. Increase the Load #2 output voltage from 16.5V to 22V (61x) or 19V (63x).
Measure → $I_{\text{sys}} = 0 \pm 100\text{mA}$, $I_{\text{bat}} = 0\text{mA} \pm 100\text{mA}$.

- Observe → D7 ($\overline{\text{STAT1}}$) off; D8 ($\overline{\text{STAT2}}$) on.
9. Decrease the Load #2 output voltage back to 16.5V.
Observe → D7 ($\overline{\text{STAT1}}$) on; D8 ($\overline{\text{STAT2}}$) off.

3.4.4 Charger Cut-Off by Thermistor

1. Slowly increase the output voltage of PS2 until $I_{bat} = 0 \pm 10\text{mA}$.
 Measure $\rightarrow V(J4(TS)) = 2.44\text{V} \pm 200\text{mV}$
 Observe $\rightarrow D7 (\overline{STAT1})$ off; $D8 (\overline{STAT2})$ off.
2. Slowly decrease the output voltage of PS2 to $1.4\text{V} \pm 0.1\text{V}$.
 Measure $\rightarrow V(J4(TS)) = 1.4\text{V} \pm 100\text{mV}$
 Measure $\rightarrow I_{bat} = 3000\text{mA} \pm 300\text{mA}$ (bq24610/617)
 $I_{bat} = 0\text{mA} \pm 100\text{mA}$ (bq24616)
 $I_{bat} = 375\text{mA} \pm 150\text{mA}$ (bq2463x)
 Observe $\rightarrow D7 (\overline{STAT1})$ on; $D8 (\overline{STAT2})$ off (bq24610/617/630)
 Observe $\rightarrow D7 (\overline{STAT1})$ off; $D8 (\overline{STAT2})$ off (bq24616)
3. Slowly decrease the output voltage of PS2.
 Charge will resume. Continue to decrease the output voltage of PS2 slowly until $I_{bat} = 0 \pm 10\text{mA}$.
 Measure $\rightarrow V(J4(TS)) = 1.14\text{V} \pm 200\text{mV}$
 Observe $\rightarrow D7 (\overline{STAT1})$ off; $D8 (\overline{STAT2})$ off.
4. Slowly increase the output voltage of PS2 to $1.8\text{V} \pm 100\text{mV}$.
 Measure $\rightarrow I_{bat} = 3000\text{mA} \pm 200\text{mA}$
 Observe $\rightarrow D7 (\overline{STAT1})$ on; $D8 (\overline{STAT2})$ off.

3.4.5 Power Path Selection

1. Take off JP5 (Disable the charging)
 Observe $\rightarrow D3 (CE)$ off; $D7 (\overline{STAT1})$ off.
2. Set JP3 Jumper On 2-3 (VPULLUP and VEXT). Connect the output of the power supply #3 to J2(VEXT, GND). Set the power supply #3 for $3.3\text{V} \pm 200\text{mVDC}$, $1.0 \pm 0.1\text{A}$ current limit.
3. Set the Load #2 output voltage to $16.5\text{V} \pm 500\text{mV}$.
4. Measure $\rightarrow V(J5(SYS)) = 24\text{V} \pm 1\text{V}$ (adapter connected to system)
 Observe $\rightarrow D4 (\overline{ACDRV})$ on, $D6 (\overline{BATDRV})$ off, $D5 (\overline{PG})$ on, $D7 (\overline{STAT1})$ off, $D8 (\overline{STAT2})$ off.
5. Turn off PS#1.
6. Measure $\rightarrow V(J5(SYS)) = 16.5\text{V} \pm 0.5\text{V}$ (battery connected to system)
7. Observe $\rightarrow D4 (\overline{ACDRV})$ off, $D6 (\overline{BATDRV})$ on, $D5 (\overline{PG})$ off, $D7 (\overline{STAT1})$ off, $D8 (\overline{STAT2})$ off.
8. Turn off power supply #2 and #3. Set JP3 on 1-2 (VPULLUP and VREF).

4 PCB Layout Guideline

1. It is critical that the exposed power pad on the backside of the bq2461x/bq2463x package be soldered to the PCB ground. Make sure there are sufficient thermal vias right underneath the IC, connecting to the ground plane on the other layers.
2. The control stage and the power stage should be routed separately. At each layer, the signal ground and the power ground are connected only at the power pad.
3. AC current sense resistor must be connected to ACP and ACN with a Kelvin contact. The area of this loop must be minimized. The decoupling capacitors for these pins should be placed as close to the IC as possible.
4. Charge current sense resistor must be connected to SRP, SRN with a Kelvin contact. The area of this loop must be minimized. The decoupling capacitors for these pins should be placed as close to the IC as possible.
5. Decoupling capacitors for DCIN, VREF, VCC, REGN should make the interconnections to the IC as short as possible.
6. Decoupling capacitors for BAT must be placed close to the corresponding IC pins and make the interconnections to the IC as short as possible.

7. Decoupling capacitor(s) for the charger input must be placed close to top buck FET's drain and bottom buck FET's source.

5 Bill of Materials, Board Layout and Schematics

5.1 Bill of Materials

Table 4. Bill of Materials

bq24610-001	bq24617-002	Bq24630-003	bq24616-004	Value	RefDes	Description	Size	Part Number	Mfr
1	0	0	0	bq24610RGE	U1	Charger Controller IC	QFN-24 (RGE)	bq24610RGE	TI
0	1	0	0	bq24617RGE	U1	Charger Controller IC	QFN-24 (RGE)	bq24617RGE	TI
0	0	1	0	bq24630RGE	U1	Charger Controller IC	QFN-24 (RGE)	bq24630RGE	TI
0	0	0	1	bq24616RGE	U1	Charger Controller IC	QFN-24 (RGE)	bq24616RGE	TI
1	1	1	1	0.1uF	C3	Capacitor, Ceramic, 16V, X7R, 5%,	603	STD	STD
6	6	6	6	0.1uF	C7,C8,C13,C18,C19,C33	Capacitor, Ceramic, 16V, X7R, 10%	603	STD	STD
6	6	6	6	0.1uF	C4,C5,C16,C17,C24,C26	Capacitor, Ceramic, 50V, X7R, 10%	603	STD	STD
1	1	1	1	22p	C22	Capacitor, Ceramic, 50V, X7R, 10%	603	STD	STD
0	0	0	0		C9,C21,C30,C31	Capacitor, Ceramic, 50V, X7R, 10%	603	STD	STD
3	3	3	3	1.0uF	C1,C6,C15	Capacitor, Ceramic, 16V, X7R, 20%	805	STD	STD
0	0	0	0		C34	Capacitor, Ceramic, 50V, X7R, 10%	805	STD	STD
2	2	2	2	1.0uF/50V	C12,C14	Capacitor, Ceramic, 50V, X5R, 20%	1206	STD	STD
1	1	1	1	2.2uF/50V	C2	Capacitor, Ceramic, 50V, X7R, 20%	1206	STD	STD
0	0	0	0		C32	Capacitor, Ceramic, 50V, X7R, 20%	1206	STD	STD
6	6	6	6	10uF/50V	C10,C11,C20,C23,C28,C29	Capacitor, Ceramic, 50V, Y5V, -20/+80%	1812	STD	STD
0	0	0	0		C25,C27	Capacitor, Ceramic, 50V, X5R, 20%	1812	STD	STD
0	0	0	0		D11	Diode, Zener, 7.5V, 350-mW	SOT-23	BZX84C7V5	Diodes
0	0	0	0		D10	Diode, Schottky, 200-mA, 30-V	SOT23	BAT54	Vishay-Liteon
0	0	0	0		D9	Diode, Zener, 7.5V, 350-mW	SOT-23	BZX84C7V5	Diodes
6	6	6	6	Green	D3,D4,D5,D6,D7,D8	Diode, LED, Green, 2.1V, 20mA, 6mcd	603	LTST-C190GKT	Lite On
0	0	0	0		D2	Diode, Schottky, 1A, 40V	DO-214AA	MBRS140	Fairchild
1	1	1	1	ZLLS350	D1	Diode, Schottky, 1.16A, 40-V	SOD-523	ZLLS350	Zetex
1	1	0	1	6.8uH	L1	Inductor, SMT, 9A, 19.8milliohm	0.520 sq inch	IHLP5050CEE R6R8M01	Vishay
0	0	1	0	8.2uH	L1	Inductor, SMT, 9.5A, 18.3milliohm	0.520 sq inch	IHLP5050CEE R8R2M01	Vishay
3	3	3	3	PEC02SAAN	JP2,JP4,JP5	Header, 2 pin, 100mil spacing,	0.100 inch x 2	PEC02SAAN	Sullins

Table 4. Bill of Materials (continued)

bq24610-001	bq24617-002	Bq24630-003	bq24616-004	Value	RefDes	Description	Size	Part Number	Mfr
2	2	2	2	PEC03SAAN	JP1,JP3	Header, 3 pin, 100mil spacing,	0.100 inch x 3	PEC03SAAN	Sullins
4	4	4	4	0	R10,R19,R26, R13	Resistor, Chip, 1/16W, 1%	402	Std	Std
1	1	1	1	10	R22	Resistor, Chip, 1/4W, 1%	1206	Std	Std
1	1	0	0	9.31k	R4	Resistor, Chip, 1/16W, 1%	402	Std	Std
0	0	1	1	2.2k	R4	Resistor, Chip, 1/16W, 1%	402	Std	Std
3	3	3	3	1k	R21,R24,R27	Resistor, Chip, 1/16W, 1%	402	Std	Std
1	1	1	1	100	R8	Resistor, Chip, 1/16W, 1%	402	Std	Std
1	1	0	0	430k	R5	Resistor, Chip, 1/16W, 1%	402	Std	Std
0	0	1	1	6.8k	R5	Resistor, Chip, 1/16W, 1%	402	Std	Std
1	1	1	1	0	R17	Resistor, Chip, 1/16W, 1%	603	Std	Std
6	6	6	6	2.21k	R31,R34,R35, R36,R39,R40	Resistor, Chip, 1/16W, 1%	603	Std	Std
1	1	1	1	10	R14	Resistor, Chip, 1/16W, 1%	603	Std	Std
2	2	2	2	10k	R29,R30	Resistor, Chip, 1/16W, 1%	603	Std	Std
6	6	6	6	100k	R3, R20,R32,R33, R37,R38	Resistor, Chip, 1/16W, 1%	603	Std	Std
1	1	1	1	10k	R16	Resistor, Chip, 1/10W, 1%	805	Std	Std
1	1	1	1	100k	R15	Resistor, Chip, 1/10W, 1%	805	Std	Std
1	1	1	1	22.1k	R12	Resistor, Chip, 1/10W, 1%	805	Std	Std
1	1	1	1	32.4k	R7	Resistor, Chip, 1/10W, 1%	805	Std	Std
4	4	4	4	100k	R6,R11,R23,R 28	Resistor, Chip, 1/10W, 1%	805	Std	Std
1	1	1	1	909k	R25	Resistor, Chip, 1/10W, 1%	805	Std	Std
2	2	2	2	3.9	R1,R2	Resistor, Chip, 1/8W, 5%	1206	Std	Std
2	2	2	2	0.01	R9,R18	Resistor, Chip, 1/2W, 1%	2010	WSL2010R01 00FEA	Vishay
1	1	1	1	ED1515	J2	Terminal Block, 3 pin, 6A, 3.5mm	0.41 x 0.25 inch	ED555/3DS	OST
2	2	2	2	ED1516	J3,J4	Terminal Block, 4 pin, 6A, 3.5mm	0.55 x 0.25 inch	ED555/4DS	OST
1	1	1	1	ED120/2DS	J1	Terminal Block, 2 pin, 15A, 5.1mm	0.40 x 0.35 inch	ED120/2DS	OST
1	1	1	1	ED120/4DS	J5	Terminal Block, 4 pin, 15A, 5.1mm	0.80 x 0.35 inch	ED120/4DS	OST

Table 4. Bill of Materials (continued)

bq24610-001	bq24617-002	Bq24630-003	bq24616-004	Value	RefDes	Description	Size	Part Number	Mfr
1	1	1	1	5001	GND	Test Point, Black, Thru Hole Color Keyed	0.100 x 0.100 inch	5001	Keystone
14	14	14	14	5002	/ACDRV,/BAT DRV,/PG, ACSET,CHGE N,ISET1,ISET 2, REGN, STAT1,STAT2 ,TS,TTC, VCC,VREF	Test Point, White, Thru Hole Color Keyed	0.100 x 0.100 inch	5002	Keystone
5	5	5	5	131-4244-00	TP1,TP2,TP8, TP9,TP12	Adaptor, 3.5-mm probe clip (or 131-5031-00)	0.200 inch	131-4244-00	Tektronix
3	3	3	3	2N7002DICT	Q6,Q8,Q9	MOSFET, N-ch, 60V, 115mA, 1.2Ohms	SOT23	2N7002DICT	Vishay-Liteon
3	3	3	3	SI4401BDY-T1-GE FDS4141	Q1,Q2,Q5 (Note 5)	MOSFET, PChan, -40V, -18A, 9.2millohm	S0-8	SI4401BDY FDS4141	Vishay-Siliconxi Fairchild
2	2	2	2	FDS8447	Q3,Q4	MOSFET, NChan, 40V, 50A, 4.5 millohm	S0-8	FDS8447	Vishay-Siliconix
2	2	2	2	TP0610K	Q7,Q10	Mosfet, P-Ch, 60V, Rds 6 ohms, Id 185 mA	SOT-23	TP0610K	Vishay-Siliconix
1	1	1	1		PCB	4 layer 2oz. PCB		HPA422	
5	5	5	5	929950-00		Shorting jumpers, 2-pin, 100mil spacing		929950-00	3M/ESD
4	4	4	4			STANDOFF M/F HEX 6-32 NYL .500"		4816	Keystone
4	4	4	4			6-32 NYL Hex nuts		NY HN 632	Building Fasteners

6 Board Layout

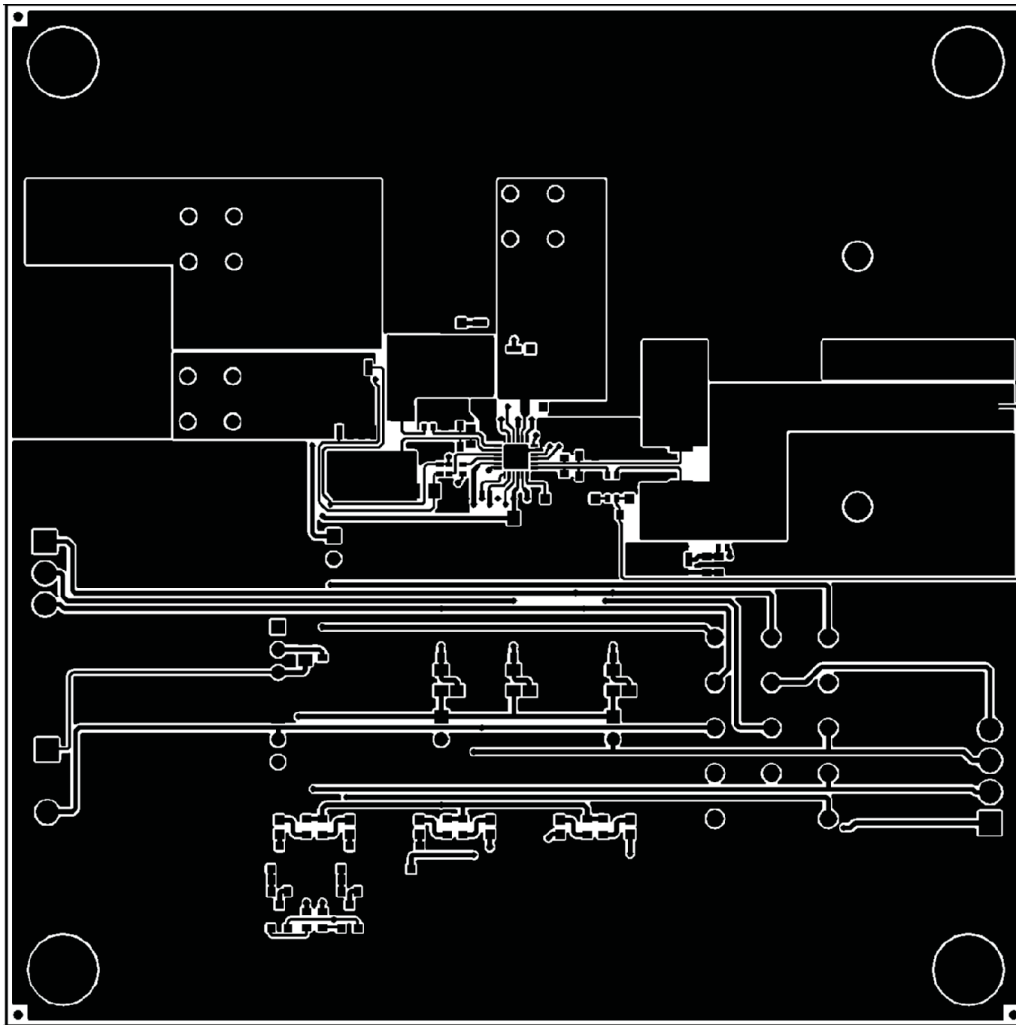

Figure 2. Top Layer

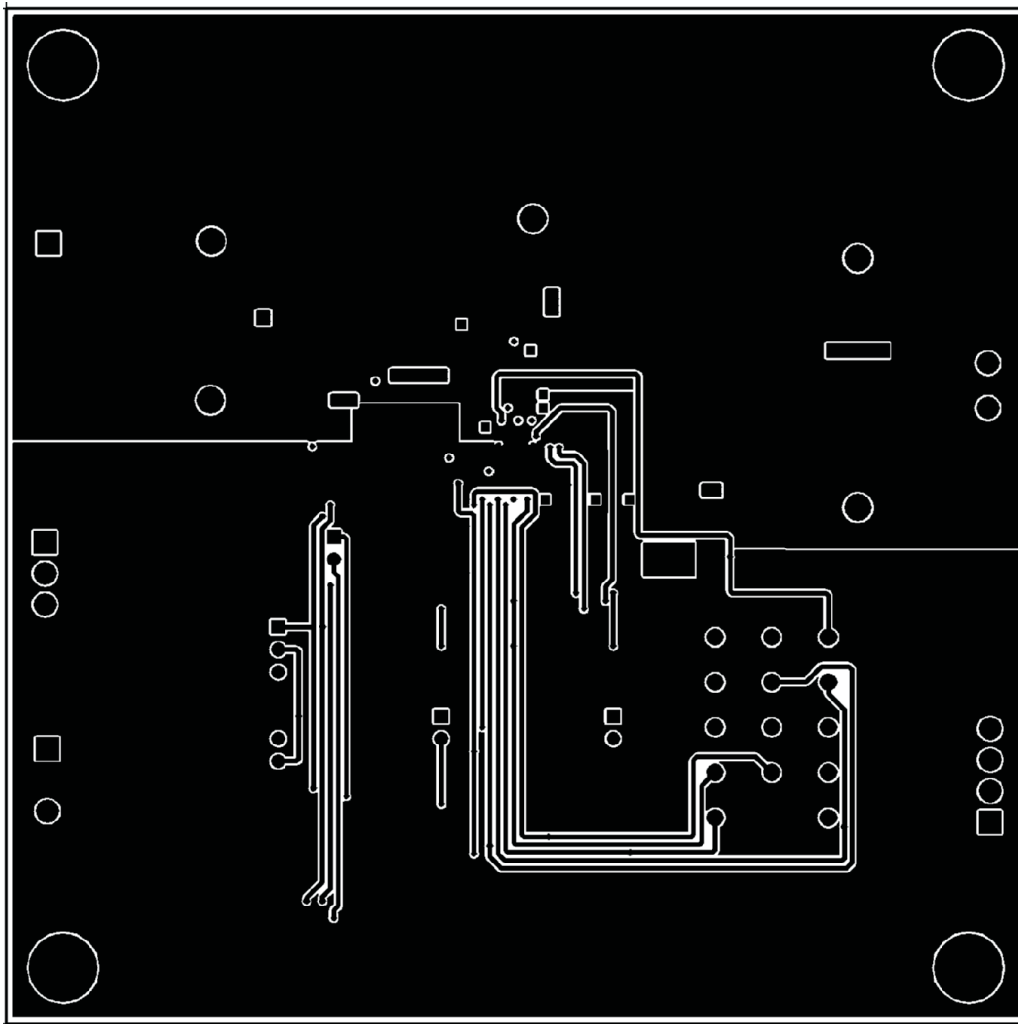

Figure 3. 2nd Layer

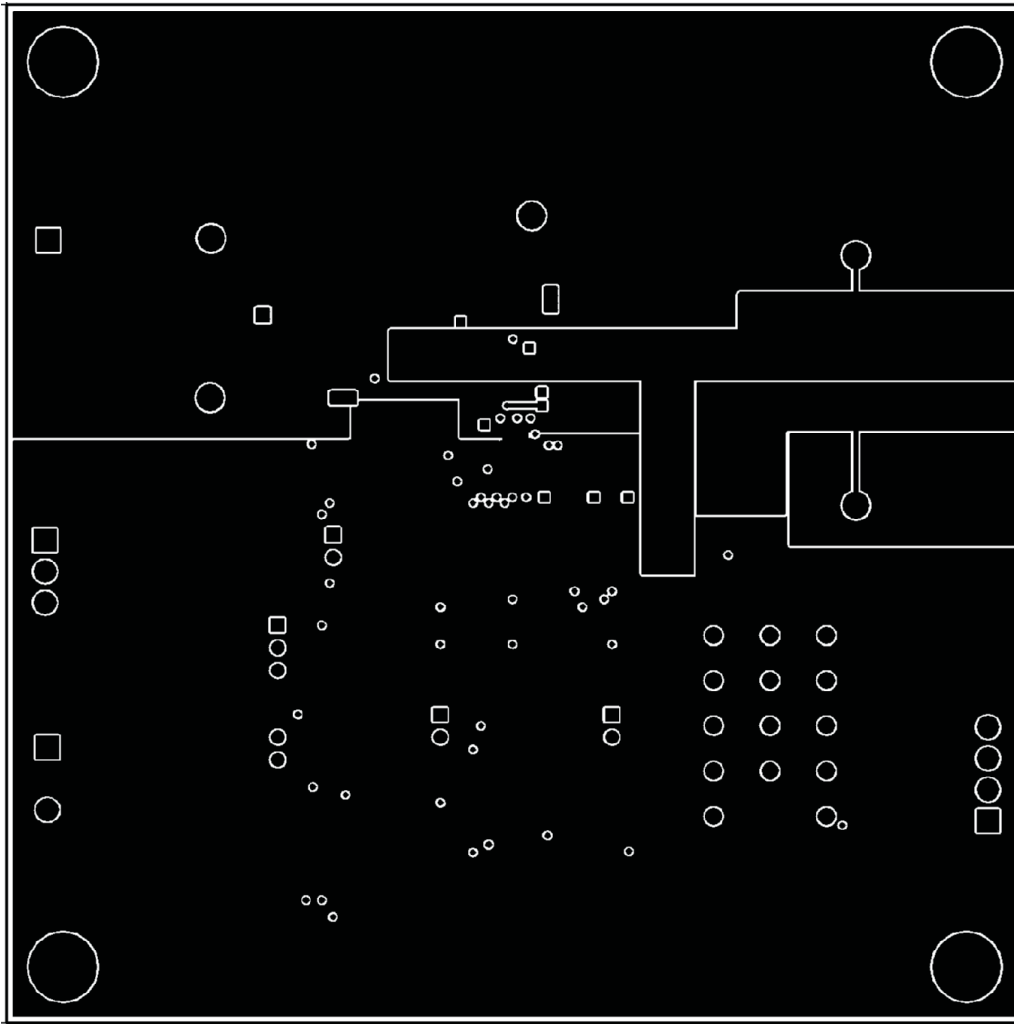

Figure 4. 3rd Layer

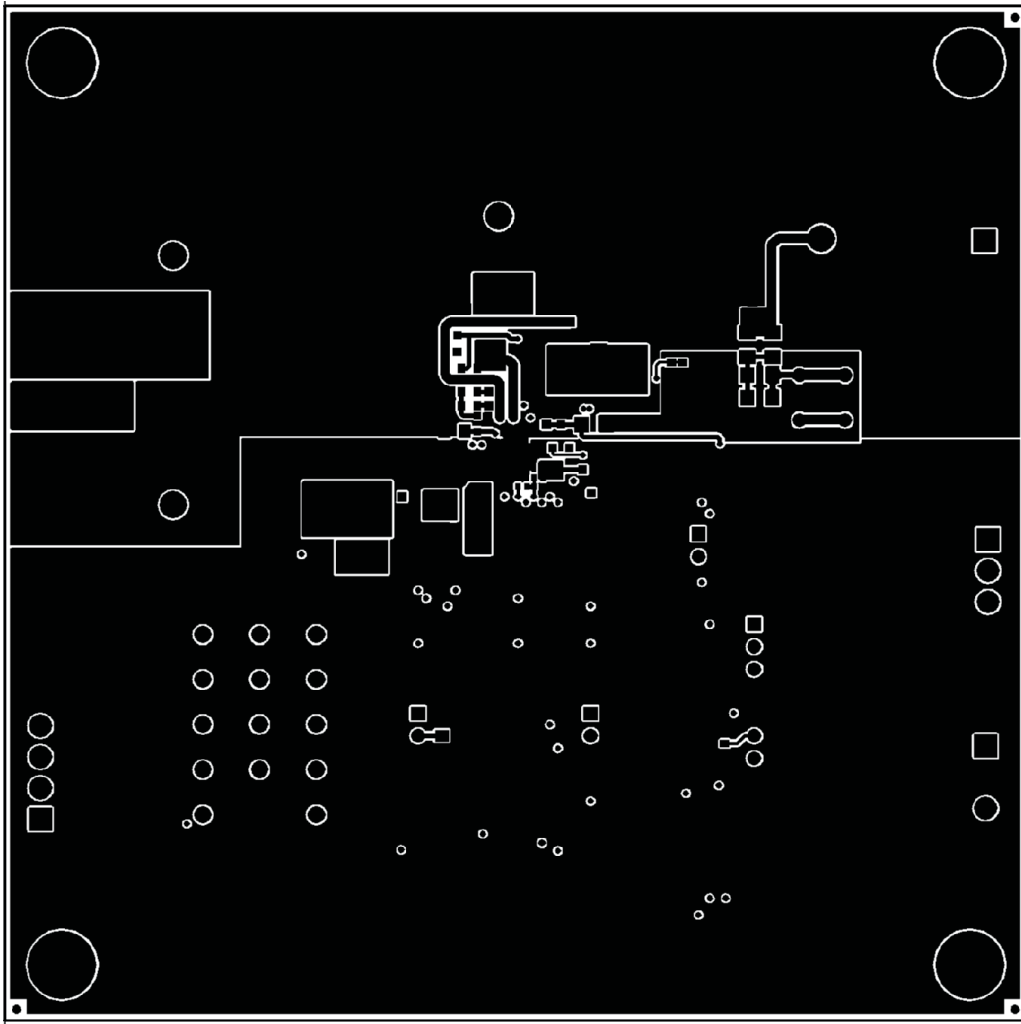

Figure 5. Bottom Layer

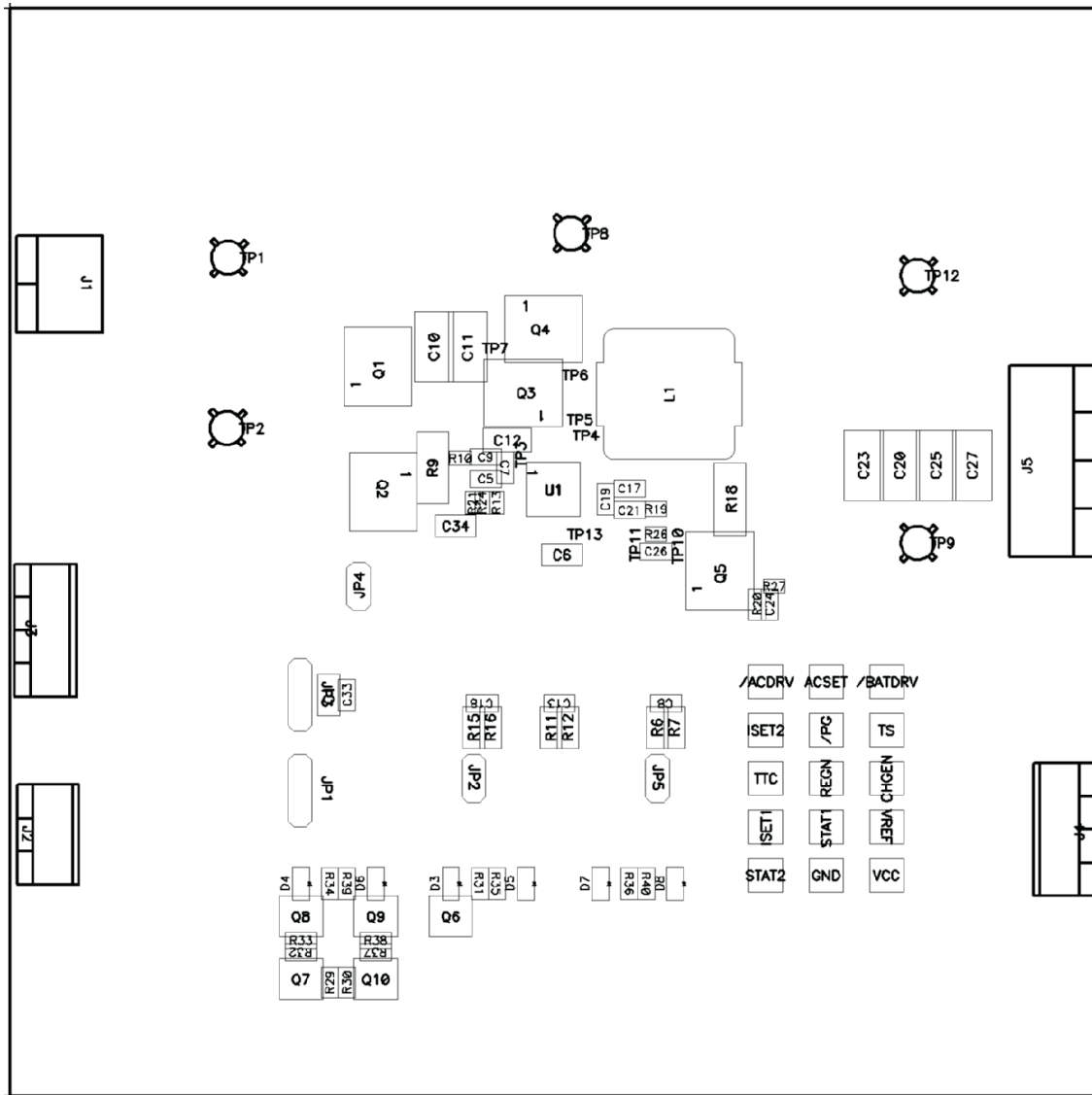

Figure 6. Top Assembly

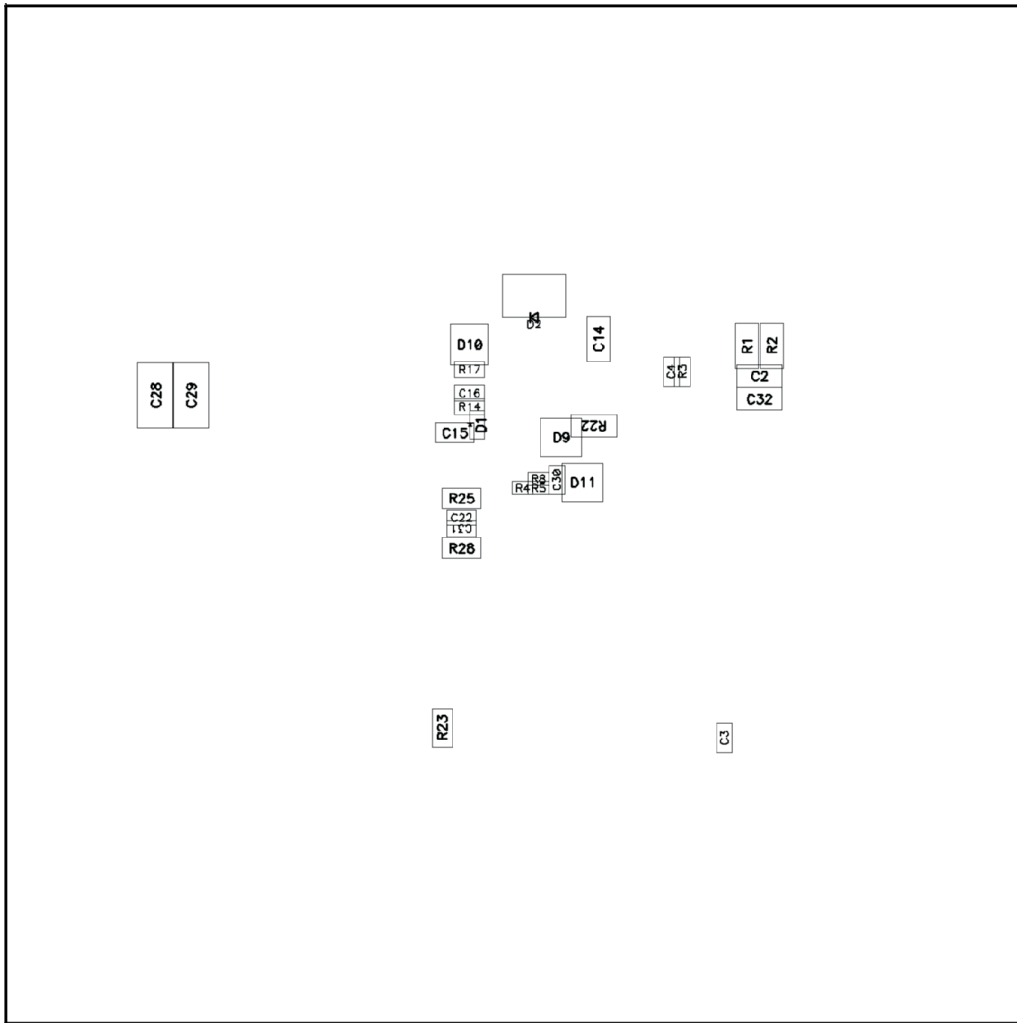

Figure 7. Bottom Assembly

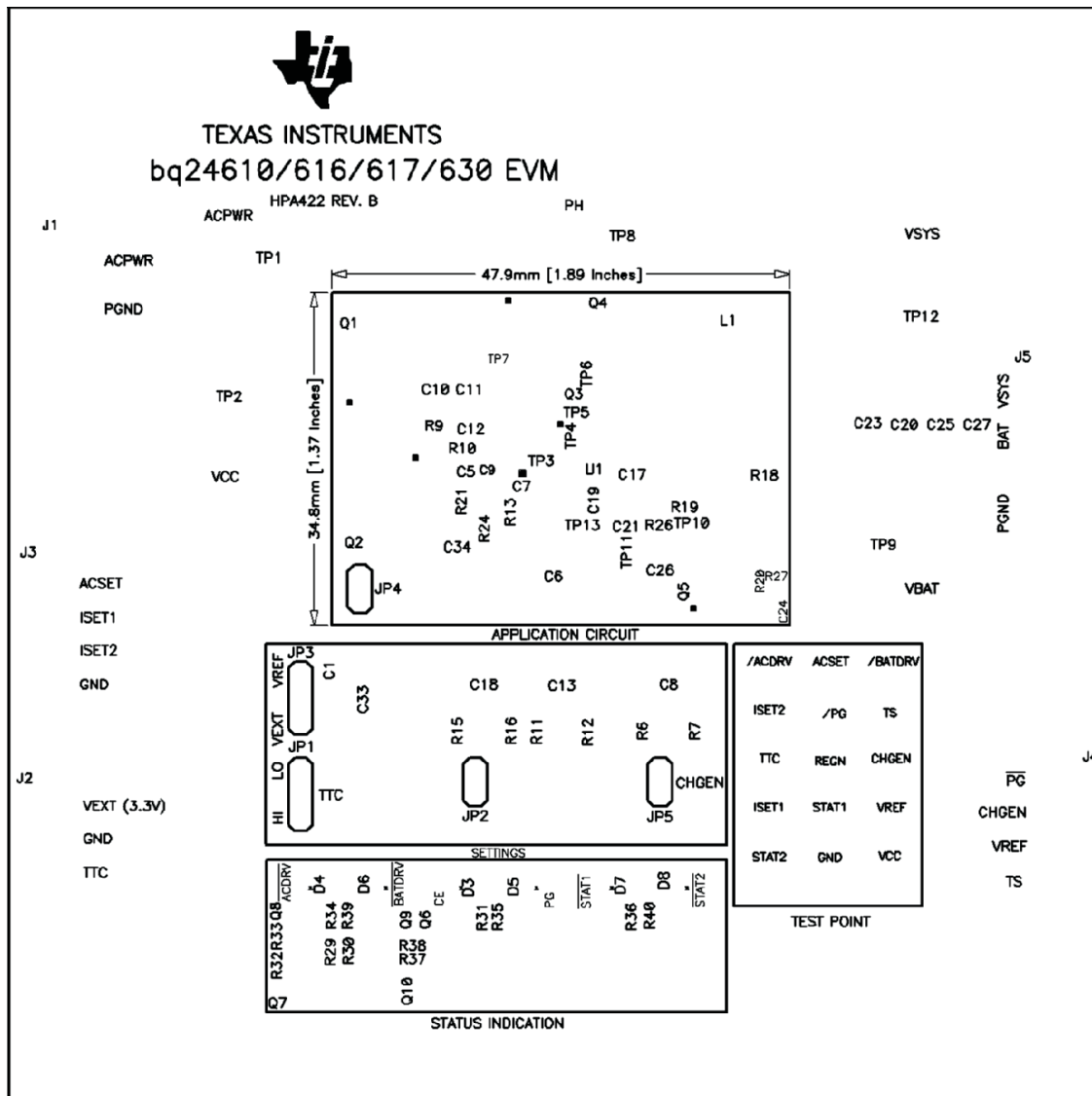

Figure 8. Top Silkscreen

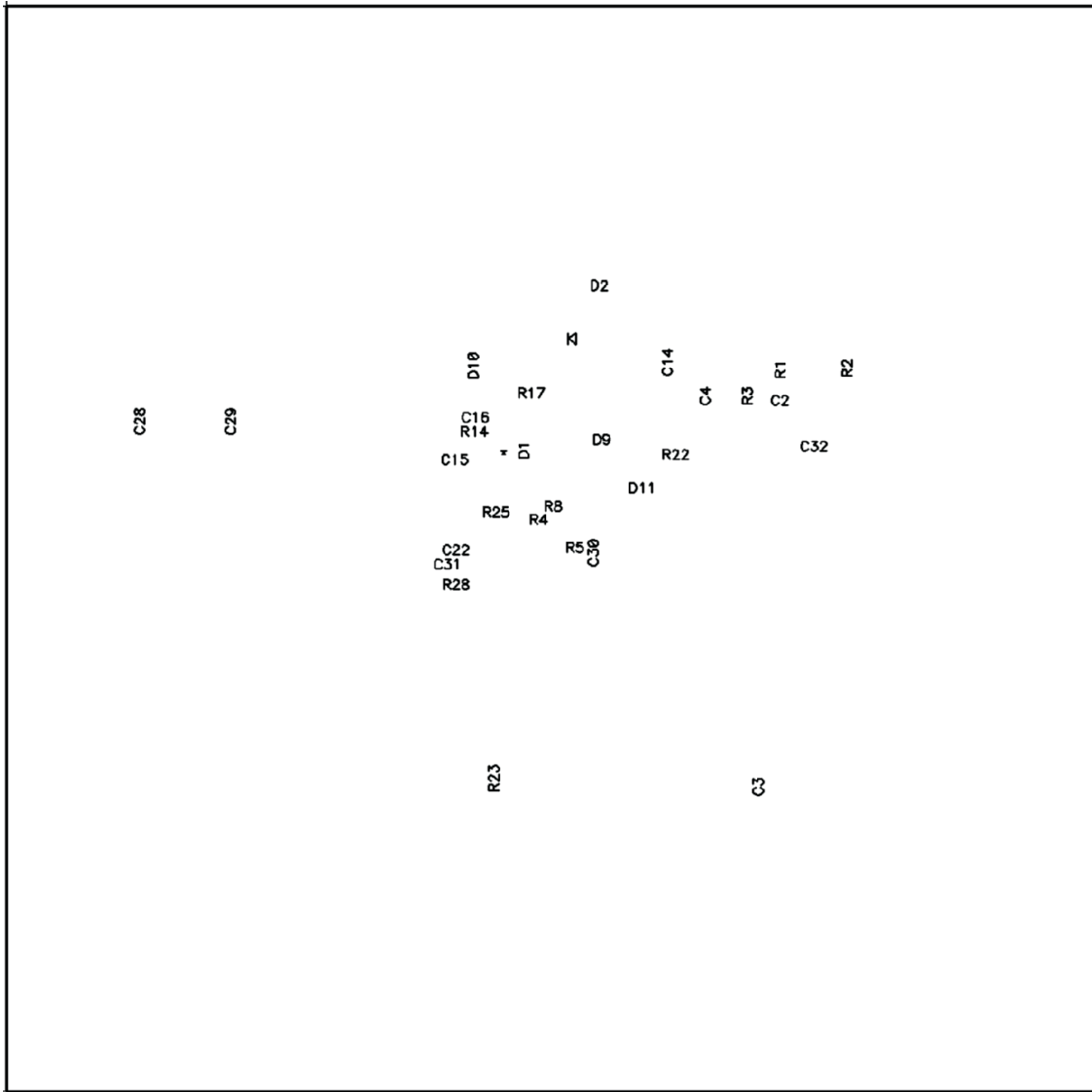

Figure 9. Bottom Silkscreen

7 Schematics

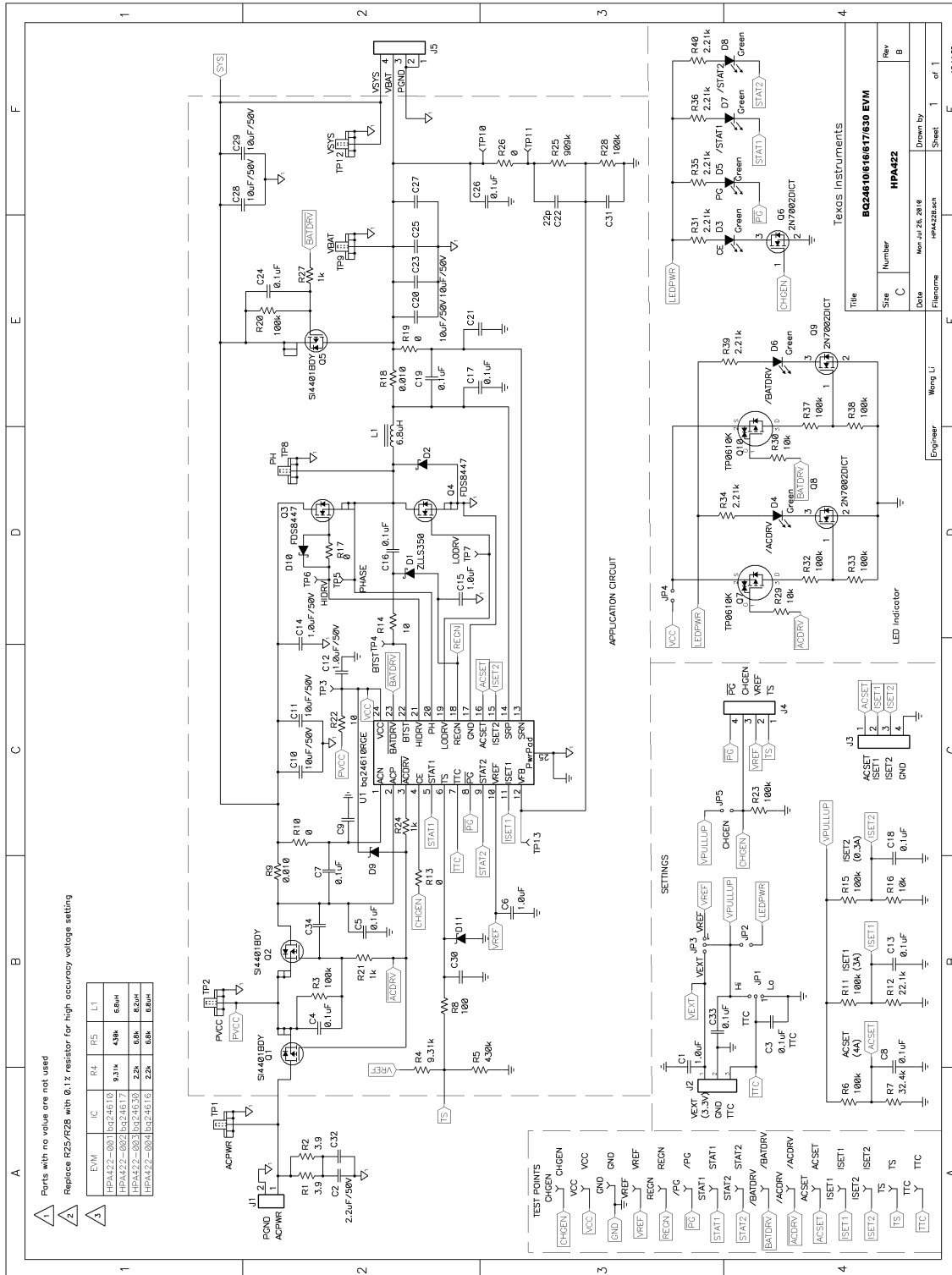

Figure 10. bq2461x/bq2463x EVM Schematic

Evaluation Board/Kit Important Notice

Texas Instruments (TI) provides the enclosed product(s) under the following conditions:

This evaluation board/kit is intended for use for **ENGINEERING DEVELOPMENT, DEMONSTRATION, OR EVALUATION PURPOSES ONLY** and is not considered by TI to be a finished end-product fit for general consumer use. Persons handling the product(s) must have electronics training and observe good engineering practice standards. As such, the goods being provided are not intended to be complete in terms of required design-, marketing-, and/or manufacturing-related protective considerations, including product safety and environmental measures typically found in end products that incorporate such semiconductor components or circuit boards. This evaluation board/kit does not fall within the scope of the European Union directives regarding electromagnetic compatibility, restricted substances (RoHS), recycling (WEEE), FCC, CE or UL, and therefore may not meet the technical requirements of these directives or other related directives.

Should this evaluation board/kit not meet the specifications indicated in the User's Guide, the board/kit may be returned within 30 days from the date of delivery for a full refund. **THE FOREGOING WARRANTY IS THE EXCLUSIVE WARRANTY MADE BY SELLER TO BUYER AND IS IN LIEU OF ALL OTHER WARRANTIES, EXPRESSED, IMPLIED, OR STATUTORY, INCLUDING ANY WARRANTY OF MERCHANTABILITY OR FITNESS FOR ANY PARTICULAR PURPOSE.**

The user assumes all responsibility and liability for proper and safe handling of the goods. Further, the user indemnifies TI from all claims arising from the handling or use of the goods. Due to the open construction of the product, it is the user's responsibility to take any and all appropriate precautions with regard to electrostatic discharge.

EXCEPT TO THE EXTENT OF THE INDEMNITY SET FORTH ABOVE, NEITHER PARTY SHALL BE LIABLE TO THE OTHER FOR ANY INDIRECT, SPECIAL, INCIDENTAL, OR CONSEQUENTIAL DAMAGES.

TI currently deals with a variety of customers for products, and therefore our arrangement with the user **is not exclusive.**

TI assumes **no liability for applications assistance, customer product design, software performance, or infringement of patents or services described herein.**

Please read the User's Guide and, specifically, the Warnings and Restrictions notice in the User's Guide prior to handling the product. This notice contains important safety information about temperatures and voltages. For additional information on TI's environmental and/or safety programs, please contact the TI application engineer or visit www.ti.com/esh.

No license is granted under any patent right or other intellectual property right of TI covering or relating to any machine, process, or combination in which such TI products or services might be or are used.

FCC Warning

This evaluation board/kit is intended for use for **ENGINEERING DEVELOPMENT, DEMONSTRATION, OR EVALUATION PURPOSES ONLY** and is not considered by TI to be a finished end-product fit for general consumer use. It generates, uses, and can radiate radio frequency energy and has not been tested for compliance with the limits of computing devices pursuant to part 15 of FCC rules, which are designed to provide reasonable protection against radio frequency interference. Operation of this equipment in other environments may cause interference with radio communications, in which case the user at his own expense will be required to take whatever measures may be required to correct this interference.

EVM Warnings and Restrictions

It is important to operate this EVM within the input voltage range of 5 V to 28 V and the output voltage range of 0 V to 26 V .

Exceeding the specified input range may cause unexpected operation and/or irreversible damage to the EVM. If there are questions concerning the input range, please contact a TI field representative prior to connecting the input power.

Applying loads outside of the specified output range may result in unintended operation and/or possible permanent damage to the EVM. Please consult the EVM User's Guide prior to connecting any load to the EVM output. If there is uncertainty as to the load specification, please contact a TI field representative.

During normal operation, some circuit components may have case temperatures greater than 60° C. The EVM is designed to operate properly with certain components above 125° C as long as the input and output ranges are maintained. These components include but are not limited to linear regulators, switching transistors, pass transistors, and current sense resistors. These types of devices can be identified using the EVM schematic located in the EVM User's Guide. When placing measurement probes near these devices during operation, please be aware that these devices may be very warm to the touch.

Mailing Address: Texas Instruments, Post Office Box 655303, Dallas, Texas 75265
Copyright © 2019, Texas Instruments Incorporated

IMPORTANT NOTICE AND DISCLAIMER

TI PROVIDES TECHNICAL AND RELIABILITY DATA (INCLUDING DATASHEETS), DESIGN RESOURCES (INCLUDING REFERENCE DESIGNS), APPLICATION OR OTHER DESIGN ADVICE, WEB TOOLS, SAFETY INFORMATION, AND OTHER RESOURCES "AS IS" AND WITH ALL FAULTS, AND DISCLAIMS ALL WARRANTIES, EXPRESS AND IMPLIED, INCLUDING WITHOUT LIMITATION ANY IMPLIED WARRANTIES OF MERCHANTABILITY, FITNESS FOR A PARTICULAR PURPOSE OR NON-INFRINGEMENT OF THIRD PARTY INTELLECTUAL PROPERTY RIGHTS.

These resources are intended for skilled developers designing with TI products. You are solely responsible for (1) selecting the appropriate TI products for your application, (2) designing, validating and testing your application, and (3) ensuring your application meets applicable standards, and any other safety, security, or other requirements. These resources are subject to change without notice. TI grants you permission to use these resources only for development of an application that uses the TI products described in the resource. Other reproduction and display of these resources is prohibited. No license is granted to any other TI intellectual property right or to any third party intellectual property right. TI disclaims responsibility for, and you will fully indemnify TI and its representatives against, any claims, damages, costs, losses, and liabilities arising out of your use of these resources.

TI's products are provided subject to TI's Terms of Sale (www.ti.com/legal/termsofsale.html) or other applicable terms available either on ti.com or provided in conjunction with such TI products. TI's provision of these resources does not expand or otherwise alter TI's applicable warranties or warranty disclaimers for TI products.

Mailing Address: Texas Instruments, Post Office Box 655303, Dallas, Texas 75265
Copyright © 2019, Texas Instruments Incorporated