

bq78PL116EVM Evaluation Module

The bq78PL116EVM Evaluation Module can assist users in evaluating the bq78PL116 PowerLAN™ Master Gateway Controller. Included in this document are discussions of the board and its operation, the schematic, bill of materials, and the printed-circuit board art.

Contents

1	Overview	3
	1.1 Features	3
	1.2 Kit Contents	3
	1.3 Equipment Requirements	3
2	Circuit Details and Configuration	6
	2.1 Connections	6
	2.2 Solder Bridges – 3S, 5S, 7S, 9S, 11S, 13S, and 15S	10
	2.3 bq76PL102	10
	2.4 bq78PL116	11
	2.5 PowerPump™ Circuitry	11
	2.6 Sense Resistors	12
	2.7 Precharge Resistor	13
	2.8 Pack Disconnect MOSFETs	13
	2.9 SOCI LEDs and Pushbutton	13
	2.10 PACK Terminals Protection Circuitry	14
3	Quick-Start Demonstration	14
	3.1 bqWizard™ Software and USB-TO-GPIO Adapter	14
	3.2 bq78PL116 Pack Configuration	15
	3.3 Battery Pack	17
	3.4 Connect to bqWizard™ Software	18
	3.5 Turning Off Power to the EVM	18
	3.6 Pack Configuration File (.tmap)	19
	3.7 Parameter Set Programming (.ppcsv)	21
	3.8 Enabling the Gas Gauge	24
	3.9 Calibration	24
	3.10 What to do next?	25
4	Full-Featured Demonstration	25
	4.1 Enabling Gas Gauge	26
	4.2 Selecting PowerPump™ Algorithm and Other Variables	30
	4.3 Test and Evaluation	30
5	Schematic and Bill of Materials	33
	5.1 Schematic	33
	5.2 Bill of Materials	33
6	bq78PL118EVM Printed-Circuit Board	34
	6.1 PCB Layers	34
7	Related Documentation	42
	7.1 Related Documentation From Texas Instruments	42
	7.2 Documentation From Other Sources	42

List of Figures

PowerPump, bqWizard, PowerLAN are trademarks of Texas Instruments.
 Microsoft, Windows are trademarks of Microsoft Corporation.

1	Cell Simulator Circuit	4
2	Pack Configuration Start Screen.	15
3	Battery Configuration Screen	16
4	Temperature Sensor Setup Screen	16
5	Finish Screen	17
6	Safe Disconnect Message	19
7	Wired Bit Status Display	19
8	Load .tmap File	20
9	Cells Display	20
10	Tabs Button	21
11	Parameter Set Tabbed Pages	21
12	Algorithm Enable Register.....	22
13	Force FET Bits	23
14	System Control Register.....	24
15	Calibration Screen.....	25
16	Chemistry ID Loader	26
17	AuxChemFile Utility Screen	27
18	Top View.....	34
19	Drill Drawing.....	35
20	Top Silkscreen	36
21	Top Solder Mask	37
22	Top Copper, Layer 1	38
23	Inner Copper, Layer 2.....	39
24	Inner Copper, Layer 3.....	40
25	Bottom Copper, Layer 4	41
26	Bottom Solder Mask.....	42

List of Tables

1	Cell Voltage Connections 1 to 4	7
2	Cell Voltage Connections 5 to 8	7
3	Cell Voltage Connections 9 to 12.....	7
4	Cell Voltage Connections 13 to 16	7
5	SMBus Connection	8
6	Cells Voltage Connections 13 to 16	8
7	Header for Remote Placement of T1 and T2 (J1)	8
8	Header for Remote Placement of T3 and T4 (J2)	8
9	VLDO Test Points and Ground References	9
10	PowerLAN™ Test Points and Ground References	9
11	Solder Bridge Usage Table	10
12	EVM Default Firmware Configuration	11
13	EVM Default PowerPump™ Firmware Configuration.....	12
14	EVM Recommended Power Connection Sequence	18
15	Parameter Set Values Written by Aux File.....	27
16	Gas Gauge Parameters Written by Aux File.....	27
17	Charge Control Parameters	28
18	Cell Chemistry	29
19	PowerPump™ Algorithm Bits Definition	30

1 Overview

This section describes the features of the bq78PL116EVM Evaluation Module (EVM) and the equipment that is typically required to demonstrate and use it.

1.1 Features

A summary of the features of the bq78PL116EVM follows.

- One bq78PL116 and six bq76PL102 devices with associated support circuitry
- Support for 3-to-16 series connected cell packs
 - Parallel cell count depends on battery current through sense resistor
- Solder bridges on printed-circuit board (PCB) for configuration of odd cell counts
- For a typical 3.6-V cell – supports 10.8-V to 57.6-V packs, 72 V maximum
- 11.2-A discharge and 10-A charge continuous current rating
- 0.010-Ω (equivalent) shunt resistor, 3 W, 10-mV/A signal to bq78PL116
- Supports up to four external (mounted on PCB) and one internal temperature sensor
- Header to optionally connect remote temperature sensors
- PowerPump™ cell balancing circuitry for all cells. 4.7-μH inductor achieves 70-mA to 90-mA average balancing.
- Pack Disconnect MOSFETs – Charge, Discharge, and Precharge
- Transient voltage protection of PACK± terminals
- Pluggable terminal block connections for cells
- SMBus connection compatible with USB-TO-GPIO Adapter
- EFCI connection for remote disable of Charge and Discharge MOSFETs.
- Test points for monitoring of cell voltages and other important circuit nets
- High-current, stud-type connections for battery power and pack power
- SOC display using five green LEDs and pushbutton switch
- Red LED for fuse-blow output indication (SPROT)
- EVM Design Files in Mentor Graphics PADs 2009 format available on request
- Gerber files available on request

1.2 Kit Contents

The bq78PL116EVM includes the HPA659 printed-circuit board.

1.3 Equipment Requirements

The bq78PL116EVM includes the PCB containing one bq78PL116 and six bq76PL102 integrated circuits. The following equipment and software are typically needed for operation. Some items depend on the usage case.

1.3.1 bqWizard™ Application Software

The bqWizard™ software is the Microsoft™ Windows™ application that controls and interfaces with the bq78PL116 controller. This software installed on a compatible personal computer (PC) is required. The installation file can be found on the Texas Instruments Web site at <http://focus.ti.com/docs/toolsw/folders/print/bqwizard.html>.

CAUTION

The current version is 3.0.16. Earlier versions of the bqWizard™ software are incompatible with the bq78PL116.

See the bqWizard User's Guide ([SLUU336](#)) for important system requirements, for instance a 32-bit Windows operating system.

1.3.2 USB-TO-GPIO Adapter

The USB-TO-GPIO Adapter is actually an EVM available from Texas Instruments. This EVM provides the SMBus connection between the bq78PL116 and the PC.

CAUTION

The USB-TO-GPIO Adapter original firmware is 1.0.10. Firmware version 2.0.19 or later must be installed using the USB-TO-GPIO Firmware Updater software available on the TI Web site at <http://focus.ti.com/docs/toolsw/folders/print/usb2gpio-loader-sw.html>.

1.3.3 Cell Simulator in Place of Cell Pack

A resistor divider powered by a power supply can be used in place of actual cells. Each resistor placed across the cell input must be in the range of 10 Ω and of a suitable wattage (5 W) that does not result in overheating. See Figure 1 for the details of this simple circuit.

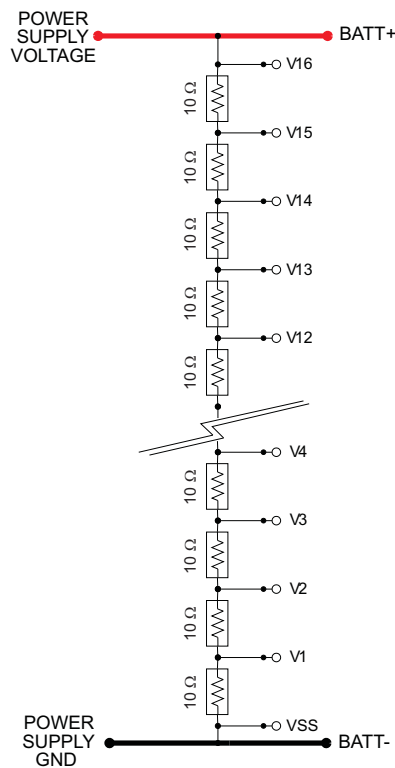

Figure 1. Cell Simulator Circuit

The power supply required to drive the cell simulator must have a voltage rating of 4.5 V/cell and current drive capability of 4.5 V/10 Ω, or 450 mA. If a load also is to be connected, the power supply must provide an additional current equal to the load's requirements. In general, it is not recommended to enable PowerPump™ Active Cell Balancing when using a cell simulator because the PowerPump™ current can cause cell voltages to swing outside the operating range of the bq78PL116 and bq76PL102. This is because the resistors have impedances 100 times the expected impedance of a Lithium ion cell.

CAUTION

Use extreme caution when operating with a cell simulator to ensure that the cell input voltages to the devices do not exceed 2.5 V to 4.5 V. When using PowerPump™ technology with a cell simulator, only operate the power supply at 3.7 V/cell. Operation away from this single point can cause circuit damage. This is based on a PowerPump circuit with a 4.7-μH inductor. A cell simulator with PowerPump™ technology enabled is not recommended if designs use smaller value inductors and hence larger PowerPump™ currents.

1.3.4 Using Cells to Power EVM

Lithium ion, rechargeable-type cells can be used with this EVM. Typical cell voltage rating is 3.6 V nominal. The typical pack consists of 3-to-16 series connected cells and 1-to-4 parallel cells. Parallel configuration depends on the sense resistor, configuration file of the bq78PL114 (.tmap file), discharge/charge currents, and the power dissipation capability of the power section of the EVM.

1.3.5 Power Supplies

One or two power supplies may be needed for operation. The power supplies provide either battery power or charger power.

The battery power is described in the Cell Simulator section. This power supply provides the power to the cell simulating resistors and also any load that is attached to the PACK± terminals. It is unnecessary if using a real battery pack.

The second power supply is connected to the PACK± terminals and provides charger power.

CAUTION

Use caution when mating batteries with the charger power supply. Some power supplies cannot tolerate current being fed into their output terminals. A battery connected to a power supply can easily cause this to happen. A properly sized blocking diode connected to the positive output voltage of the power supply provides adequate protection against backfeed into the power supply electronics.

1.3.6 Electronic Load

An electronic load is often necessary to sink current or power from the battery and through the EVM. A constant current load provides a good means of evaluating the performance of the bq78PL116 gas gauge. Equipment rating depends on the application. Typical criteria for electronic load selection is a voltage rating of up to 4.5 V/cell and up to 10-A discharge capability with 1-mA resolution.

1.3.7 Digital Multimeter

One or two digital multimeters (DMM) capable of voltage, current, and temperature measurement equal to or greater than the accuracy ratings of the bq78PL116 and bq76PL102 are required for adequate evaluation.

1.3.8 Oscilloscope

An oscilloscope may be needed if evaluation of waveforms or timing measurements are needed. Typical waveforms that a user may be interested in are the SMBus signals (100 kHz), PowerLAN™ bus (150 kHz) or PowerPump™ signals (200 kHz). Capture of the activation times of the DSG, CHG, and PRE signals on the bq78PL116 may be of interest. These signals can occur down to the 100-μs time base.

2 Circuit Details and Configuration

This section highlights the important features of the EVM circuit, gives some operating instructions, and also provides a description of the connector pin assignments. Read this section before using the EVM for the first time.

2.1 Connections

Pin 1 on all multipin headers is indicated by a square solder pad.

2.1.1 Cells (J9 – J12)

The cell-sensing wires of the battery pack provide power to the bq78PL116 and bq76PL102 and connect to the PowerPump™ circuitry. If the cell count is N, the number of cell wires is N+1.

Device power is sourced from the even cells in even-series cell-count applications. For odd-series cell-count packs, the same is true except that the top device is sourced from the top odd cell.

The cell connectors consist of four pluggable terminal blocks.

Table 1. Cell Voltage Connections 1 to 4

Header Name	Terminal	Label	Purpose
J9	5	0	Connection of VSS to pack.
	4	1	Cell 1 positive terminal.
	3	2	Cell 2 positive terminal.
	2	3	Cell 3 positive terminal.
	1	4	Cell 4 positive terminal.

Table 2. Cell Voltage Connections 5 to 8

Header Name	Terminal	Label	Purpose
J10	4	5	Cell 5 positive terminal.
	3	6	Cell 6 positive terminal.
	2	7	Cell 7 positive terminal.
	1	8	Cell 8 positive terminal.

Table 3. Cell Voltage Connections 9 to 12

Header Name	Terminal	Label	Purpose
J11	4	9	Cell 9 positive terminal.
	3	10	Cell 10 positive terminal.
	2	11	Cell 11 positive terminal.
	1	12	Cell 12 positive terminal.

Table 4. Cell Voltage Connections 13 to 16

Header Name	Terminal	Label	Purpose
J12	4	13	Cell 13 positive terminal.
	3	14	Cell 14 positive terminal.
	2	15	Cell 15 positive terminal.
	1	16	Cell 16 positive terminal.

2.1.2 Battery – J5, J3

Connect the positive, current-carrying connection of the battery to the BATT+ terminal (J5).

Connect the negative, current-carrying connection of the battery to the BATT– terminal (J3).

The BATT± connections are single, heavy-duty screw terminals that feature a 10-32 x 3/8"L screw. This connector is rated to 30 A, maximum. Actual current is limited to a lower value by other circuit board components.

2.1.3 Pack – J6, J4

Connect the positive, current-carrying connection of the load or charger to the PACK+ terminal (J6).

Connect the negative, current-carrying connection of the load or charger to the PACK– terminal (J4).

The PACK± connections are single, heavy-duty screw terminals that feature a 10-32 x 3/8"L screw. This connector is rated to 30 A, maximum. Actual current is limited to a lower value by other circuit board components.

2.1.4 SMBus – J8

The SMBus connector (J8) is for connection to the USB-TO-GPIO adapter. The pin assignment is as follows:

Table 5. SMBus Connection

Header Name	Terminal	Label	Purpose
J8	1	1	None
	2	—	None
	3	—	None
	4	—	None
	5	—	None
	6	—	Ground
	7	—	None
	8	—	None
	9	—	SMBus Clock
	10	—	SMBus Data

2.1.5 EFCI – J7

The EFCI header provides access to the EFCID and EFCIC pins of the bq78PL116. They can be used to remotely turn off the DSG and CHG outputs. The pin assignment of the connector is as follows:

Table 6. Cells Voltage Connections 13 to 16

Header Name	Terminal	Label	Purpose
J7	1	—	EFCID
	2	—	Ground
	3	—	Ground
	4	—	EFCIC

2.1.6 Remote Temperature Sensors – J1, J2

The bq78PL116 can monitor up to four dual, series-connected diodes to measure cell temperature. The sensors are then assigned to the cells by the pack configuration file (.tmap). The default configuration is four sensors on the board at T1, T2, T3, and T4. Users have the option to make their own sensor PCB (consisting of diode and capacitor) and mount them remotely. The design and Gerber files for a remote temperature sensor assembly is available from Texas Instruments on request.

The T1–T4 sensors need to be removed when remote sensors are being used. The pin assignment for the two headers are as follows:

Table 7. Header for Remote Placement of T1 and T2 (J1)

Header Name	Terminal	Label	Purpose
J1	1	VSS	Ground for XT1 (Cathode)
	2	XT1	XT1 Sensor Connection (Anode)
	3	VSS	Ground for XT2 (Cathode)
	4	XT2	XT2 Sensor Connection (Anode)

Table 8. Header for Remote Placement of T3 and T4 (J2)

Header Name	Terminal	Label	Purpose
J2	1	V2	Ground for XT3 (Cathode)
	2	XT3	XT3 Sensor Connection (Anode)
	3	V2	Ground for XT4 (Cathode)

Table 8. Header for Remote Placement of T3 and T4 (J2) (continued)

Header Name	Terminal	Label	Purpose
	4	XT4	XT4 Sensor Connection (Anode)

The mating connector for headers J1 and J2 can come from many sources. The type is four-position, female, 0.100-inch spacing plug for 26 AWG wires. One example is an insulation displacement-type from Tyco Electronics # 3-640442-4.

2.1.7 Ground

Two grounds are on the board: VSS and GND. They are separated by the current sense resistor. VSS is the ground for the bq78PL116, and GND is the ground for devices referenced to PACK-. The PACK- connector is the same as GND.

A test loop is located near the PACK- connected marked GND1 that is used to connect to PACK ground.

Use GND1 as the ground for any test equipment connected to the EVM. If grounds of test equipment are connected to VSS, it is possible for ground leakage to occur and skew the reading of the sense resistor.

Use the VSS test point only with ground isolated test equipment, like a portable, battery-operated DMM.

2.1.8 Test Points

Numerous test loops are located on the EVM.

- A test point labeled GND1 is the system GND. Use this point when connecting grounded test equipment, like oscilloscopes. Color code is black.
- V1 to V16 is used to monitor cell voltage readings of the bq78PL116 and bq76PL102. These are color-coded red.
- SW1 to SW15 is used to monitor the inductor switching in the PowerPump™ circuit. These points give a good indication of PowerPump™ activity and performance. These are color-coded white.
- The SPROT, DSG, CHG, and PRE of the bq78PL116 all have test points color-coded black. These can be used (ref to GND1) to look at safety rule timing.
- VLDO1 to VLDO8 connect to the VLDO outputs of the bq78PL116 and bq76PL102s. These test points, referenced to their device ground, measure 2.5 V. Checking these points is typically done if hardware troubleshooting is needed. Use a isolated voltmeter, like a battery-operated DMM.

Table 9. VLDO Test Points and Ground References

Test Point Name	Ground Reference Test Point	LDO of Device
VLDO1	VSS	U7
VLDO2	V2	U7
VLDO3	V4	U1
VLDO4	V6	U2
VLDO5	V8	U3
VLDO6	V10	U4
VLDO7	V12	U5
VLDO8	V14	U6

- SDO0, 2, 4, 5, 6, 7, 8, and PLAN test points, color-coded white, are available to see the PowerLAN™ network signals. Typically, these signals are monitored for troubleshooting a malfunctioning circuit. The PowerLAN™ protocol is proprietary. These signals are monitored to check for the existence of digital communications and the dc voltage levels, not necessarily decoding them. The test points and their grounds are assigned as follows:

Table 10. PowerLAN™ Test Points and Ground References

Test Point Name	Ground Reference Test Point	LDO of Device
SDO1	VSS	U7
SDO2	V2	U7

Table 10. PowerLAN™ Test Points and Ground References (continued)

Test Point Name	Ground Reference Test Point	LDO of Device
PLAN	V2	U1
SDO4	V4	U2
SDO5	V6	U3
SDO6	V8	U4
SDO7	V10	U5
SDO8	V12	U6

- The CLK and DAT test points correspond to the SMBus clock and data signals, respectively. These are ground referenced to PACK– or GND1 test point.
- The Z and P+ test points are located on either side of the precharge resistors R76 and R75. P+ is connected to PACK+. These test points can be used to monitor the current flow through the precharge circuit by measuring the voltage drop across the precharge resistor.

2.2 Solder Bridges – 3S, 5S, 7S, 9S, 11S, 13S, and 15S

Solder bridges are located along the left, long side of the PCB to short out unused device inputs. Use the following table to determine which solder bridge must be shorted, based on the series cell count.

Table 11. Solder Bridge Usage Table

Cell Count	Solder bridge to short
3	3S
4	None
5	5S
6	None
7	7S
8	None
9	9S
10	None
11	11S
12	None
13	13S
14	None
15	15S
16	None

For a solderless equivalent, the same point can be jumped using a wire on one of the J9 – J12 headers. See the schematic for details.

2.3 bq76PL102

The six bq76PL102 circuits on the EVM expand the bq78PL116's capability from four cells to as high as 16 cells. Each bq76PL102 monitors the voltage of one or two cells in the battery depending on whether the pack is even or odd. It communicates this information to the bq78PL116 on the capacitor-coupled, one-wire PowerLAN™ bus. The bq76PL102 also drives the PowerPump™ circuitry for cells 5 through 16 based on commands from the bq78PL116.

The bq76PL102s are connected in order as cell count increases: U1, U2, U3, U4, U5, and then U6. The V1 pin connects to the positive of the lower cell in the pair and V2 to the upper cell. The V2 of the highest bq76PL102 is not used for odd-numbered packs. This input must be shorted to the V1 pin of the same device. Solder bridges on the board can easily accomplish this. See the previous section. If neither input (V1 or V2) is connected, then both can be left open circuit. For instance, in a 7S application, pin V2 of device U2 is shorted to pin V1, and the V1 and V2 pins of U3, U4, U5, and U6 are left as no connect.

No temperature sensors are connected to the bq76PL102s. This is a function of the bq78PL116 design. The temperature sensing for cells and the PCB comes from the bq78PL116. Unused inputs XT1 and XT2 of the bq76PL102 are left as open circuit.

2.4 bq78PL116

The bq78PL116 PowerLAN™ Master Gateway Controller creates a PowerLAN™ network on the EVM based on the number of cells expected. The operation of the bq78PL116 depends on the configuration by the user. The default configuration from the factory is for three cells. If another configuration is required, see the *bqWizard User's Guide* ([SLUU336](#)) and the application report *What is a .tmap File?* ([SLUA542](#)) for details on creating a pack configuration file.

The EVM is configured as follows:

Table 12. EVM Default Firmware Configuration

Feature	Terminal	Value
Battery Configuration	Series Cell Count	3
	Parallel Cell Count	1
Current Measurement	Sense 1	10000 micro Ohms HW Gain = 9 SBData IPScale = 0000 SBData VScale = 0000
	Sense 2	3000 micro Ohms HW Gain = 13 SBData IPScale = 0000 SBData VScale = 0000
	Sense 3	1000 micro Ohms HW Gain = 9 SBData IPScale = 0001 SBData VScale = 0000
LEDs & SOC	>80% = LED1 – LED5 >60% = LED1 – LED4 >40% = LED1 – LED3 >20% = LED1 – LED2 <=20% = LED1	
Temperature	PCB = Internal Cell 1 = XT1 Cell 2 = XT2 Cell 3 = XT3	

The factory setting for Pack Disconnect operation has them all turned off. This is done for safety reasons. The user will need to edit the Algorithm Enable Register so that the top bit, called Inhibit Safety Rules, is cleared (= 0). Another option is to leave that bit set and then set the Force CFET, DFET, and PFET bits as needed. Setting these bits to a 1 (while Inhibit Safety Rules = 1) turns that FET on despite the status of any safety rule. The force xFET bits only work while the bqWizard™ application is connected.

CAUTION

Disabling the safety rules and permanently turning on the MOSFET control pins (DSG, CHG, and PRE) can be dangerous with lithium ion cells connected to the EVM. Exercise caution when disabling the safety rules.

2.5 PowerPump™ Circuitry

The PowerPump circuitry for each bq76PL102 and the bq78PL116 uses a unique charge-shuttling circuit to transfer charge from stronger cells to weaker cells to maintain the best possible performance for the battery pack. See the application report *PowerPump™ Balancing* ([SLUA524](#)) for more details.

Each PowerPump™ Cell Balancing circuitry uses a 4.7-μH inductor. This produces approximately 70 mA to 90 mA of average current transfer.

The default factory setting for the PowerPump™ Circuitry is as follows:

Table 13. EVM Default PowerPump™ Firmware Configuration

Register	Bit(s)	Value	
System Control	Pump Disable	1	Off
Algorithm Enable	Pump Algorithm Bit 0	0	OCV Balancing Algorithm
	Pump Algorithm Bit 1	1	
	Pump Mode	1	
	Inhibit Pump During Charge	0	Off
	Inhibit Pump During Discharge	0	Off
	Turbo 0	0	Turbo Mode = Off
	Turbo 1	0	
	Turbo 2	0	
	Turbo 3	0	
Minimum Cell Diff for Balancing	N/A	10	mV
Cell Imbalance Fail Voltage	N/A	500	mV

Consult the *bq78PL116 Technical Reference Manual* ([SLUU481](#)) for details on configuring the PowerPump™ algorithm as well as other firmware parameters.

2.6 Sense Resistors

The EVM includes three 0.030-Ω, 1-W resistors in parallel for an equivalent resistance of 0.010 Ω. This value is the default for the bq78PL116 firmware. The voltage drop across the resistance is used by the bq78PL116 to measure current.

This resistor permits a measurement range of -11200 mA to +10000 mA. Negative is discharge current, and positive is charge current. The equation to calculate the discharge current range is:

$$\text{Range}_{\text{DSG}} (\text{A}) = (1.26 \text{ V/Gain} \times 80\%) / \text{Resistor Value}$$

The equation to calculate the charge current range is:

$$\text{Range}_{\text{CHG}} (\text{A}) = \text{minimum} [(1.26 \text{ V/Gain} \times 80\%) / \text{Resistor}, 0.100 \text{ V/Resistor}]$$

See *bq78PL116 Technical Reference Manual* and the application report [SLUA542](#) for details on how to change the current measurement range.

The copper area connected to the resistors is made as large as practical to dissipate heat. In addition, the BATT– and PACK– connections provide additional thermal heat sinking.

The temperature rise of the default resistors is approximately 35°C at the maximum current (–11.2 A). This means that the 1.25 W dissipated in the resistance causes a 35°C rise or approximately 28°C/W. It is possible to change the equivalent resistance by replacing the default resistors and thereby change the current range of the EVM. The range is primarily limited to the thermal sinking capability of the PCB.

2.7 Precharge Resistor

The precharge resistors, R75 and R76, controlled by transistors Q7 and Q27 provide a current-limited charge path to cells that are deeply depleted. The precharge path is active when the DSG and CHG outputs shut down the charge and discharge MOSFETs (Q26||Q15, Q13||Q25). This can happen by CUV or PUV safety rule activation, for example, or if the cells go below the EUV threshold of the bq78PL116, typically 2.5 V. In either case, the precharge current safely charges up the pack to a reasonable level and then full charge resumes.

The precharge path is vital to the operation of the bq78PL116 if the cells ever go low enough to cause the bq78PL116 to enter EUV mode. In this mode, the bq78PL116 needs greater than 2.9 V/cell to resume normal operation. Without the precharge current, the bq78PL116 may never wake up from the EUV shutdown state.

The precharge resistance (R_{PRE}) can be determined by the following equation:

$$R_{PRE} = (V_{CHG} - V_{gsth} - V_F - V_{BATT})/I_{PRE}$$

Where:

V_{CHG} = Pack Charging voltage

V_{gsth} = Gate-Source threshold voltage of precharge MOSFET (Q7||Q27)

V_F = Forward voltage drop of body diode of the discharge MOSFET

V_{BATT} = Minimum battery voltage

I_{PRE} = Desired precharge current

All of these values are determined by the user, based on the application. In this circuit, the following values were assumed to get to the 1500- Ω precharge resistance.

$$V_{CHG} = 16 \times 4.2 \text{ V} = 67.2 \text{ V}$$

$$V_{gsth} = 2.4 \text{ V}$$

$$V_F = 0.8 \text{ V}$$

$$V_{BATT} = 16 \times 2.0 \text{ V} = 32 \text{ V}$$

$$I_{PRE} = 2200\text{mA}/100 = 22 \text{ mA}$$

The R_{PRE} is then calculated to be 1454 Ω . Two 3000- Ω resistors in parallel were chosen.

2.8 Pack Disconnect MOSFETs

The three pack disconnect MOSFETs are: Discharge (Q25||Q13), Charge (Q26||Q25), and Precharge (Q7||Q27). These switches are controlled by the bq78PL116's DSG, CHG, and PRE pins, respectively. The MOSFET operation is in phase with the control pins of the bq78PL116. This means that when the control pin is ON, the MOSFET is also ON. The control pins are 2.5-V logic.

The MOSFETs were selected so that they can block the maximum voltage expected to be seen by the EVM and also provide a low series resistance. This is 16 cells \times 4.5 V, or 72 V. Charge and Discharge MOSFETs have a V_{DS} breakdown of 100 V and R_{DSON} of approximately 0.020 Ω . The Precharge MOSFET is also rated at 100 VDS but, its R_{DSON} does not have to be that low.

The high input capacitance of the Discharge and Charge MOSFETs can lead to a slow turn off time if proper drive circuitry is not used. In this EVM, the drive circuit employs a JFET that has a low output resistance compared to the 1-M Ω resistor across the MOSFET gate when the MOSFET control signal is turned OFF. This low resistance quickly pulls the charge off of the gate of the MOSFET. Fast shutoff time is desirable in battery management because of the high energy in the cells. Turnoff times of less than one millisecond can be expected for these 10-m Ω switches (two 0.020 Ω in parallel).

2.9 SOCI LEDs and Pushbutton

The state-of-charge indication (SOCi) provided is through five LEDs. It is activated by the pushbutton labeled SOCI. Each of the five LED segments represents 20% increments in charge. The SOC indication does not read properly until the gas gauge is initialized by loading both the CHEM ID file (.chem) and the Auxiliary Chemistry File (.aux). See the application report *Chemistry Selection for bq78PL114* ([SLUA505](#)) for details.

2.10 PACK Terminals Protection Circuitry

Several protection components are located across the PACK± terminals. These are a transient voltage suppressor (D1), a series connected pair of capacitors (C41 and C42) and a free-wheeling diode (D2). Also included for ESD protection are the series connected pair of capacitors (C10 and C22) across the Charge and Discharge MOSFETs.

Given this is an evaluation module, wire lengths are likely to be longer than in an actual system design and contribute higher inductance during MOSFET switching. The switching action of the Pack Disconnect Switches causes voltage spikes that are a function of the current passing through the battery. The parallel connected devices (D1, D2, C41, and C42) serve to limit the possible voltage spike. All of these devices, D1 especially, are sized for 16-cell operation. Lower cell count systems may need a different transient voltage protection device (D1).

See the *System Design Guidelines for the bq78PL114* application report ([SLUA537](#)) for some additional circuit guidelines.

3 Quick-Start Demonstration

It is anticipated that users of this EVM may fall into two general categories:

- Those who wish to use the cell simulator (resistors and power supply) to explore the basic functionality of the bq78PL116 measurement and control system. This can be referred to as the Quick-Start approach.
- Those who wish to use a battery pack and treat the EVM as a possible interim design solution until a custom PCB can be fabricated. This can be referred to as the Full-Featured approach.

In either case, start with the Quick-Start approach and only then continue to the Full-Featured section if real cells are going to be used.

The Quick-Start demonstration is presented as a step-by-step guide for a simple, albeit limited, introduction to the bq78PL116 and bq76PL102. Explanations of features or the reasons why steps are done are purposefully not explained for brevity. The other documents referenced in [Section 7](#) provide the necessary insight; reading them affords users an excellent understanding of the product.

3.1 bqWizard™ Software and USB-TO-GPIO Adapter

Before opening the bq78PL116EVM and applying power, the bqWizard™ software and the USB-TO-GPIO adapter must be installed and set up.

The USB-TO-GPIO adapter is actually an EVM that is sold separately from the bq78PL116EVM. First, purchase this EVM. The firmware in it must be changed to work with the bq78PL116 because this EVM was developed for generic applications. Go to the TI Web site at <http://focus.ti.com/docs/toolsw/folders/print/usb2gpio-loader-sw.html> to download the firmware loader.

With the USB-TO-GPIO adapter connected to the PC, follow the instructions included with the firmware loader software and change the firmware version to 2.0.19. All necessary files are included with the USB-TO-GPIO Firmware Updater.

CAUTION

If the firmware download fails, do not disconnect the USB-TO-GPIO adapter. Try to load the firmware again until it is successful. Removing power after a failed download can permanently damage the USB-TO-GPIO adapter.

The bqWizard™ software is free to download from the TI Web site. The current version is 3.0.16 and can be found at <http://focus.ti.com/docs/toolsw/folders/print/bqwizard.html>.

Follow the installation instructions in the install package. When completed, open up the **demo version** of the bqWizard™ software by doing the following:

1. In the Windows Start menu, locate **Run...**
2. In the field provided, type **bqWizard /demo**. Be sure to include a space between **bqWizard** and **/**.

This opens the bqWizard™ software in a demonstration mode. The demonstration mode allows the user to passively explore the software, and of particular use, it allows the creation of configuration files (.tmap). Functionality is obviously limited because no bq78PL116 is connected in demonstration mode.

3.2 bq78PL116 Pack Configuration

The key configuration parameter for this Quick Start demonstration is the Series Cell Count. The bq78PL116EVM successfully starts up if three or more cell voltages are applied. If more than three are present, they are ignored. If less than three are present, an error occurs.

Open the bqWizard™ software in demonstration mode (Start Menu ...Run... bqWizard /demo described in previous section), and do the following:

1. Under the Utilities menu, Select Add Ons.
2. Select Pack Configuration Utility.
3. Select Configuration Plugin: Tmap Configuration so that the following screen appears.

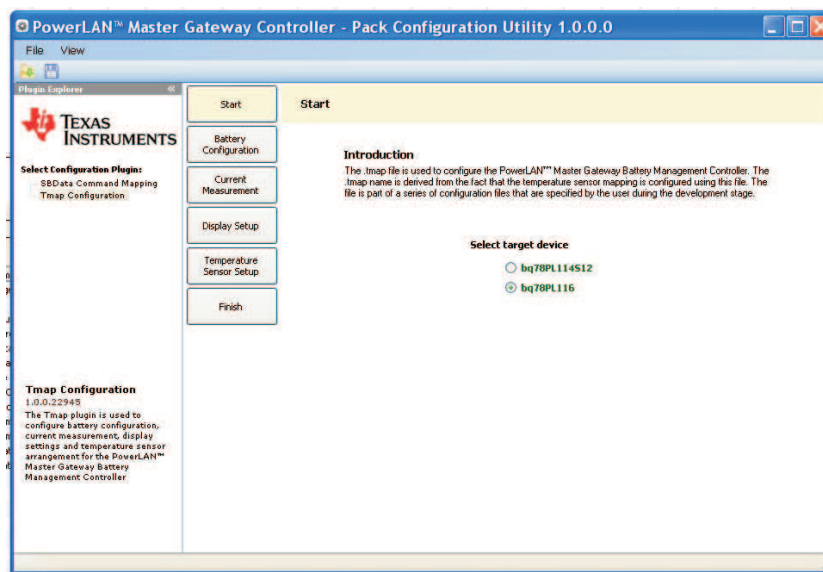

Figure 2. Pack Configuration Start Screen.

4. Click the bq78PL116 radio button.
5. Click the Battery Configuration button.
6. Choose the number of series cells that match the cell simulator that is to be used. In this example, 8S is used.

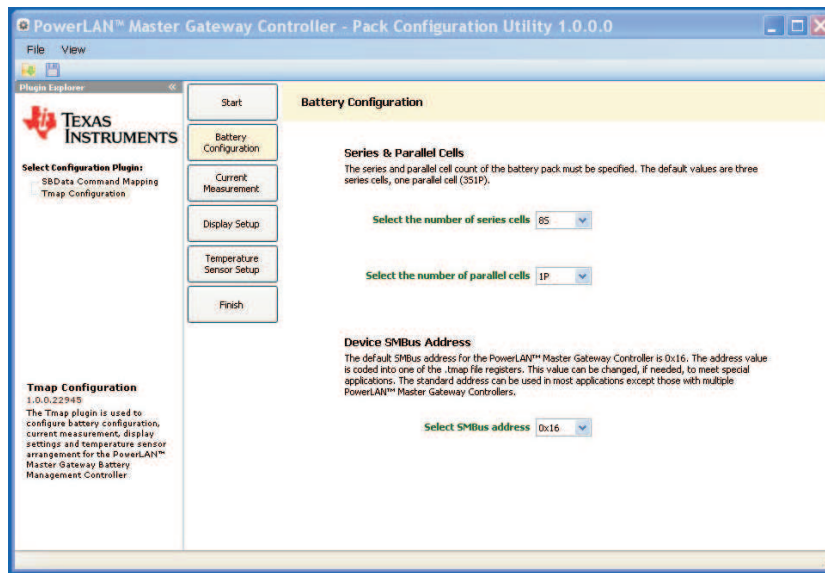

Figure 3. Battery Configuration Screen

7. Click the Temperature Sensor Setup button. Assign the available temperature sensors as appropriate. In this case, the four sensors on the board are evenly distributed across the cells.

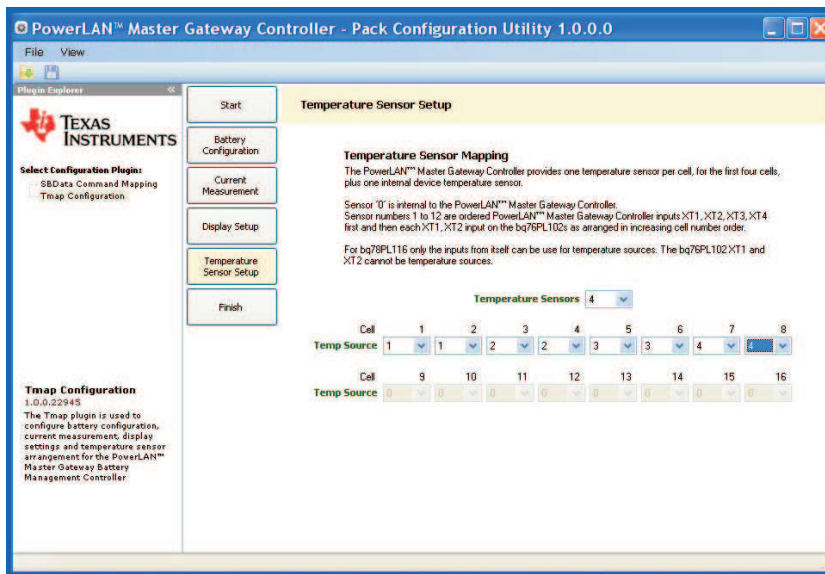

Figure 4. Temperature Sensor Setup Screen

8. Select the Finish button. Add any notes that you wish to appear in the file. Save the file.

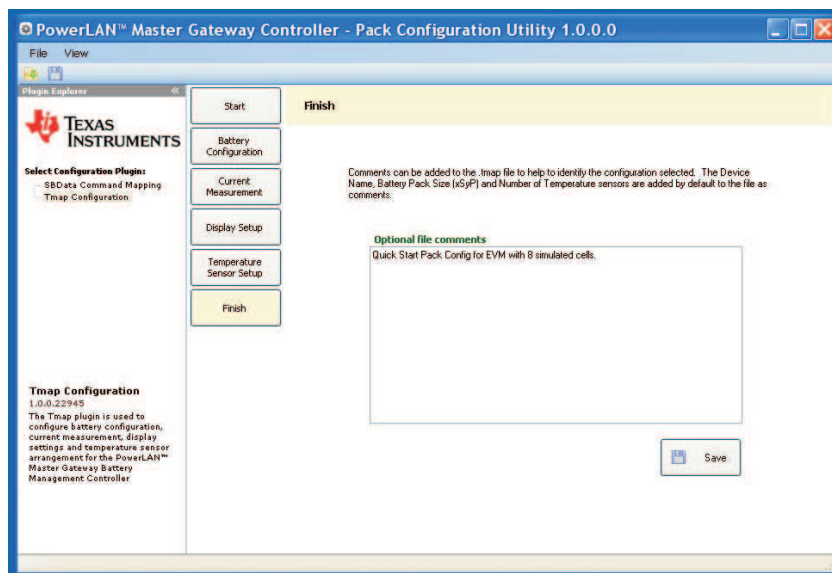

Figure 5. Finish Screen

9. Exit the utility.
10. Close the bqWizard™ demonstration.

This pack configuration file (.tmap) is used to configure the bq78PL116 for operation with the cell simulator.

3.3 Battery Pack

This demonstration assumes that a cell simulator is being used. It is possible to continue the demonstration at this point with real cells also.

3.3.1 Cell Simulation

Construct a cell simulator made of a series connection of 10- Ω resistors powered by a power supply set to **3.7 V/cell and 500 mA** current limit. Refer to [Section 1](#) in which the cell simulator was introduced.

Do not connect anything to the PACK± terminals at this point.

Connect the cell simulator to J9, J10, J11, and J12 as determined by the number of cells and following the sequence order in the next section. For odd-cell configurations, short out the solder bridge corresponding to your cell count. For a 7S pack, short out the 7S solder bridge.

3.3.2 Power Sequencing

The bq78PL116 and bq76PL102 have a recommended power-up sequencing that is described in the following table.

Table 14. EVM Recommended Power Connection Sequence

Battery Size	Connection Sequence																		
	bq78PL116					bq76PL102 - 1		bq76PL102 - 2		bq76PL102 - 3		bq76PL102 - 4		bq76PL102 - 5		bq76PL102 - 6		BATTERY	
	VSS	V1	V2	V3	V4	V1	V2	V1	V2	V1	V2	V1	V2	V1	V2	V1	V2	BATT-	BATT+
3S	1	4	3	5	5													2	6
4S	1	4	3	6	5													2	7
5S	1	4	3	6	5	7	7											2	8
6S	1	4	3	6	5	8	7											2	9
7S	1	4	3	6	5	8	7	9	9									2	10
8S	1	4	3	6	5	8	7	10	9									2	11
9S	1	4	3	6	5	8	7	10	9	11	11							2	12
10S	1	4	3	6	5	8	7	10	9	12	11							2	13
11S	1	4	3	6	5	8	7	10	9	12	11	13	13					2	14
12S	1	4	3	6	5	8	7	10	9	12	11	14	13					2	15
13S	1	4	3	6	5	8	7	10	9	12	11	14	13	15	15			2	16
14S	1	4	3	6	5	8	7	10	9	12	11	14	13	16	15			2	17
15S	1	4	3	6	5	8	7	10	9	12	11	14	13	16	15	17	17	2	18
16S	1	4	3	6	5	8	7	10	9	12	11	14	13	16	15	18	17	2	19

CAUTION

Random sequencing using real cells can be done. However, some unacceptable device fallout can occur in a production environment where large quantities are involved. Production procedures must match the cell sequencing described in this document.

With a cell simulator, sequencing is typically random because the power supply connected to the cell simulator is usually cycled on and off. This is acceptable in a laboratory environment where only one or two EVMs are being used. If any problems occur, try cycling the power.

3.4 Connect to bqWizard™ Software

With the bq78PL116EVM powered, and the USB-TO-GPIO adapter (updated to version 2.0.19 firmware) connected to the PC with the bqWizard 3.0.16 installed, connect the USB-TO-GPIO ribbon cable to J8 of the EVM. This connection is keyed to prevent misconnection.

Wait approximately 10 seconds after the start-up of the bq78PL116, and then open the bqWizard™ software.

The message "3 Cells Found. Starting bqWizard." appears prior to the main bqWizard™ screen appearing.

3.5 Turning Off Power to the EVM

CAUTION

The bq78PL116 needs to shut down in a planned way. Doing so prevents any possible damage that can result from abrupt power removal.

Toggle the wired bit, and then use the Safe Disconnect command in the bqWizard™ software prior to removing power from the EVM.

The bqWizard™ software has a command called Safe Disconnect that must be used every time that the power is removed from the EVM. The command can be executed by pressing shift+F2. When this command is executed, the bqWizard™ software shuts down and displays the following message:

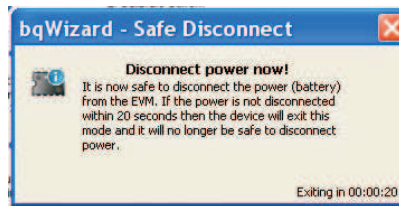

Figure 6. Safe Disconnect Message

The combination of the Wired bit and the Safe Disconnect command stop the bq78PL116 from executing the PowerPump™ algorithm and from doing writes to flash memory. Gracefully stopping these two processes is very important.

The procedure to shut down the bq78PL116EVM is as follows:

1. Toggle the wired bit by pressing the F7 key. This makes the WIRED status turn from green to grey.
2. Press shift+F2 to do a Safe Disconnect command.
3. Remove power from the EVM within 20 seconds. If the power is not removed within 20 seconds, the bq78PL116 goes back to operating as if the Safe Disconnect command was not executed. If more than 20 seconds elapses, open the bqWizard™ software and re-execute the Safe Disconnect command.

3.5.1 Clearing the Fuse

The FUSE may activate during operation. This puts the bq78PL116 in a permanent fail state and turns on the SPROT pin. This can happen if the temperature sensors are not calibrated, for instance.

To clear the FUSE, simply press the F5 key.

3.6 Pack Configuration File (.tmap)

The pack configuration file allows the user to let the firmware know different key application parameters. Use the .tmap file created in the previous section. The procedure to load it is as follows:

1. The device must have its Wired bit set. This can be done by pressing the F7 key (see Figure 7). If the word “Wired” is green, then the bit is set.

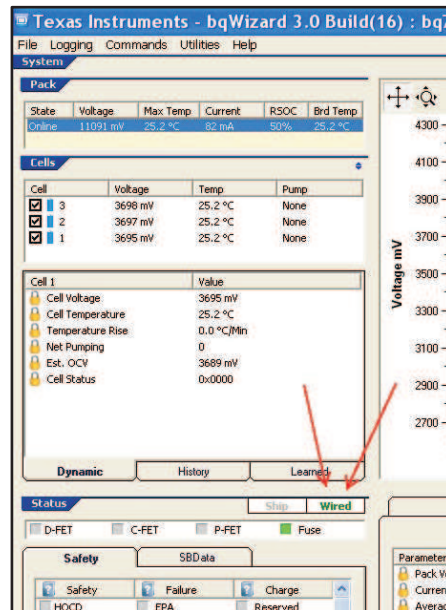

Figure 7. Wired Bit Status Display

2. Under the File menu, Select Pack Configuration File, and then Load Configuration From File...

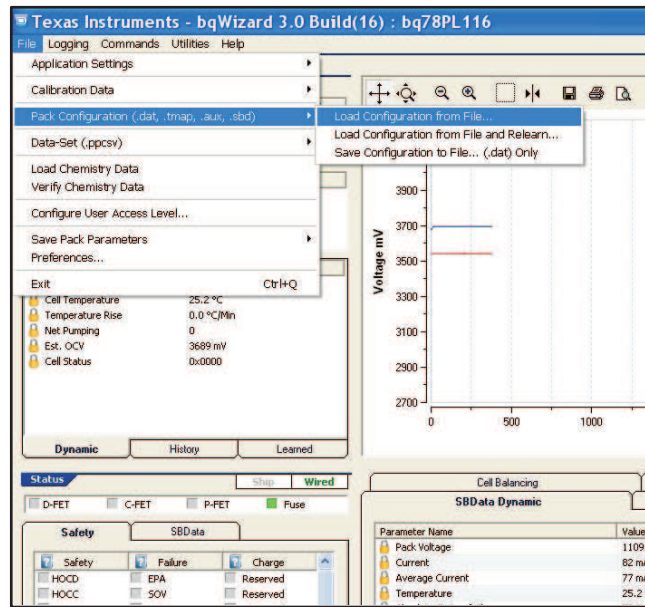

Figure 8. Load .tmap File

3. Select and open the file that was made in [Section 3.2](#).
4. The cell count matching the cell simulator appears.
5. A relearn/initialize command must be executed by pressing the F4 key.
6. After some processing by the bqWizard™ software, all cells are now visible and reading within data-sheet accuracy limits. If not, try pressing F4 to repeat the relearn/initialize command.
7. The cell temperature sensors were calibrated during EVM testing at TI. They should also be read accurately.

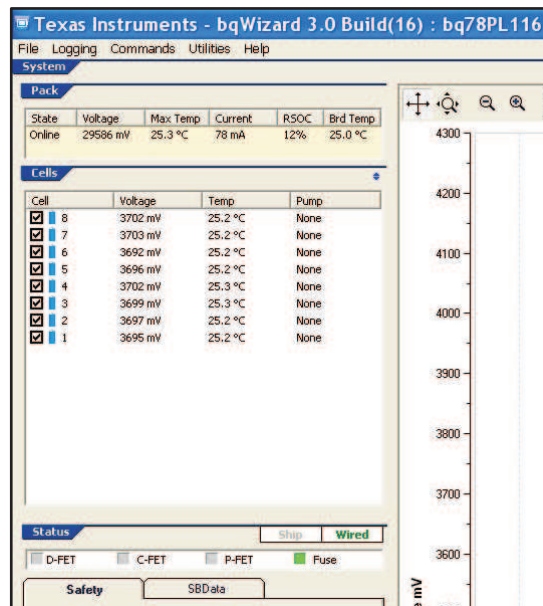

Figure 9. Cells Display

8. It is easy to see all the cells if the Tabs button is toggled. It opens up the Cells display so that all 16 cells can be seen.

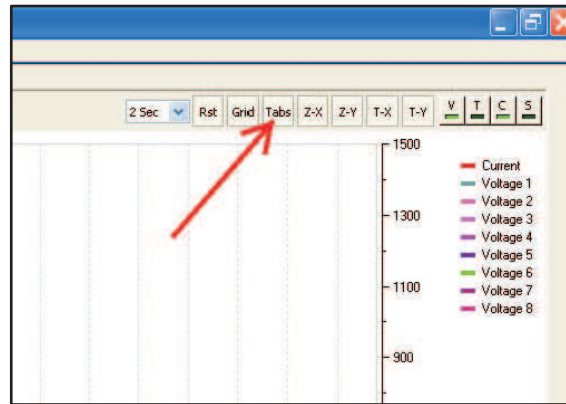

Figure 10. Tabs Button

3.7 Parameter Set Programming (.ppcsv)

The details of the Parameter set are described in the *bq78PL116 Technical Reference Manual (SLUU481)*. A thorough review of this document is highly recommended. The parameter set refers to the First Level and Second Level Safety Features, Charge Control and Miscellaneous Parameters. Three registers in particular need to be well understood prior to proceeding: Hardware Configuration, Algorithm Enable, and System Control.

The 10 tabbed pages in the home screen of the bqWizard™ show the parameter set.

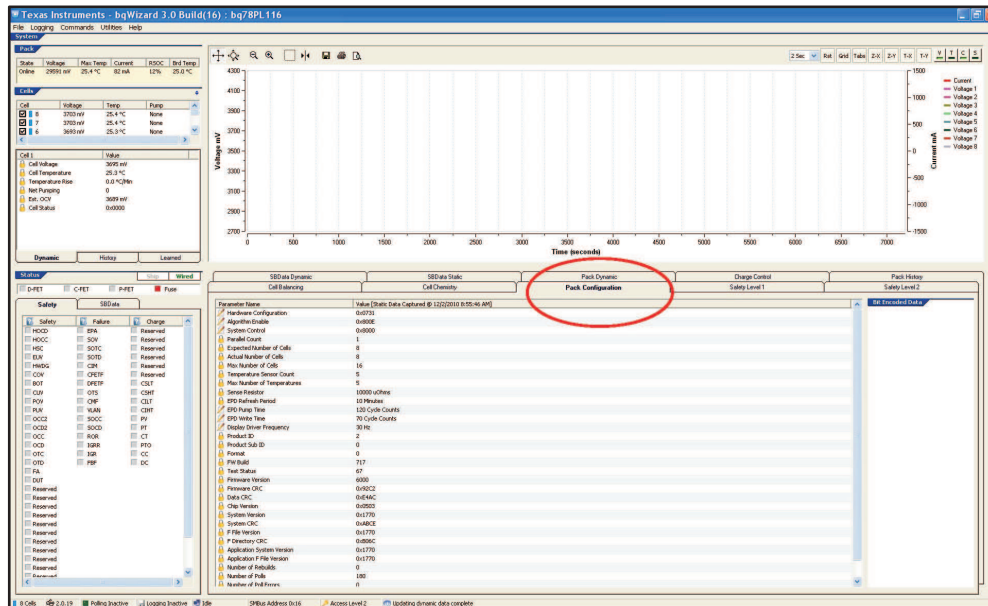

Figure 11. Parameter Set Tabbed Pages

The parameter set can be edited almost entirely from the home screen of the bqWizard™ software by double-clicking on each parameter row and entering a new value for the parameter. Any parameter that has an icon next to it that looks like a pencil and paper can be manually edited. Any value that has a lock icon next to it falls into one of several different categories:

1. Dynamic Variable that is read only and updated by bq78PL116
2. Static Variable that is read only
3. Writable only through loading a Pack Configuration file (.tmap)
4. Writable only through loading an Auxiliary Chemistry file (.aux)

5. Writable only through loading a Parameter Set file (.ppcsv)

For the Quick-Start evaluation and especially with simulated cells, the easy way to bypass all safety and charge rules is to disable them. This is described in the following text.

CAUTION

Bypassing the safety rules of the bq78PL116 can be dangerous. Practice extreme caution when doing so.

3.7.1 Enabling Pack Disconnect MOSFETs

The bq78PL116 is programmed at the factory to have the safety rules disabled and the Pack Disconnect MOSFET control pins turned off. This means that no battery current can flow. The Algorithm Enable register is the means by which the Safety Rules can be completely disabled.

Select the Pack Configuration tab. The Algorithm Enable register in the bq78PL116 has four bits that control the Safety Rules and MOSFETs. Double-click on the Algorithm Enable Register row. See [Figure 12](#).

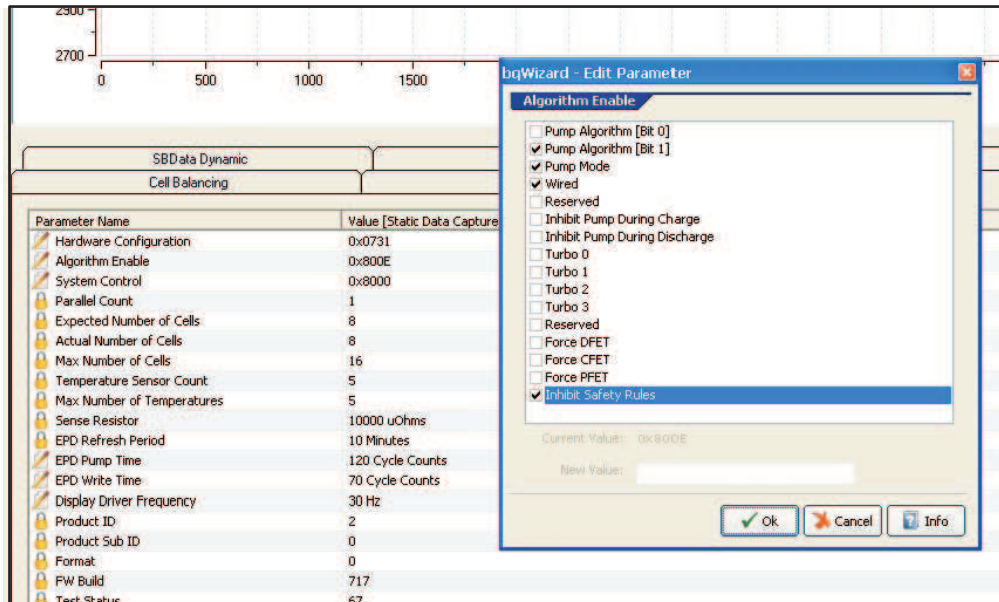

Figure 12. Algorithm Enable Register

The Inhibit Safety Rules bit prevents all safety rules from happening if this bit is set to 1 (or checked). The three bits above this one, Force PFET, Force CFET, and Force DFET, control the PRE, CHG, and DSG outputs (respectively) when the Inhibit Safety Rules bit is checked. Normal device operation occurs when the Inhibit Safety Rules bit is cleared; the Force xFET bits are then ignored in this case. Lastly, control of the Force xFET bits only work when connected to the bqWizard™ software. If these bits are checked (= 1), Inhibit Safety Rules is checked and the bqWizard™ software is disconnected, the DSG, CHG, and PRE pins turn ON and stay ON.

To turn on any MOSFET, check the corresponding Force xFET bit. Turn all on in this case.

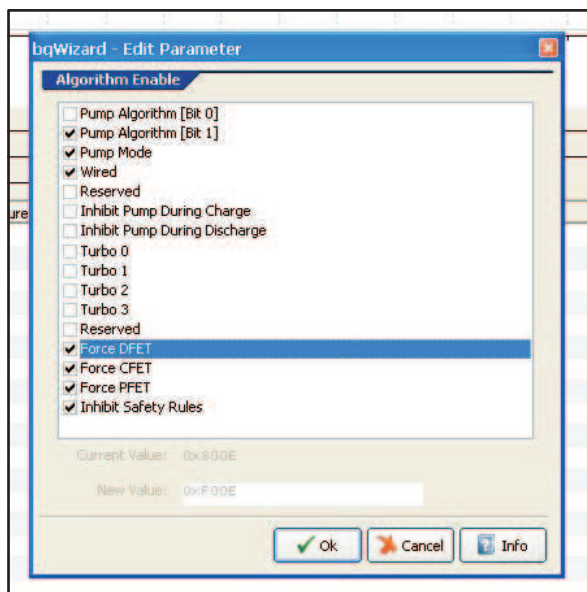

Figure 13. Force FET Bits

Do not close this window yet. Proceed to the next section.

3.7.2 Enabling PowerPump™ Cell Balancing

With the Algorithm Enable Dialog box still open, look at the first three bits of the register. These control the operation of the PowerPump™ algorithm.

CAUTION

PowerPump™ cell balancing can be used with a cell simulator. However, the cell voltage must not exceed the data-sheet ratings of 2.5 V to 4.5 V/cell. The PowerPump™ circuits when activated send 70 mA to 90 mA into the resistor string of the cell simulator, which disturbs the uniform division of the total voltage. It is important to have only the power supply voltage at 3.5 V/cell while the PowerPump™ algorithm is active.

The default PowerPump™ algorithm uses calculated Open Circuit Voltage (OCV) to control the algorithm. Because the gas gauge is not active during a demonstration with a cell simulator, change the PowerPump™ algorithm to the Terminal Voltage Based algorithm. This means that all three bits must be set to 1 (checked).

Close the Algorithm Enable Dialog Box. Write Pending Changes to RAM by pressing Ctrl + w. This configures the PowerPump™ algorithm but, it does not turn it on. That is done using a bit in the System Control register.

For initial evaluation, it may be appropriate to keep the PowerPump algorithm turned off. It is one less variable to worry about when operating the EVM for the first time. If the PowerPump™ algorithm is active with a cell simulator, the power supply voltage **must be fixed at 3.5V/cell** to prevent circuit damage.

Double-click on the System Control register. Setting the Pump Disable bit to a 1 (checked) disables the PowerPump™ algorithm. Set this bit to zero if the PowerPump™ algorithm needs to be active. Close the window, and press Ctrl + w to save changes to the RAM.

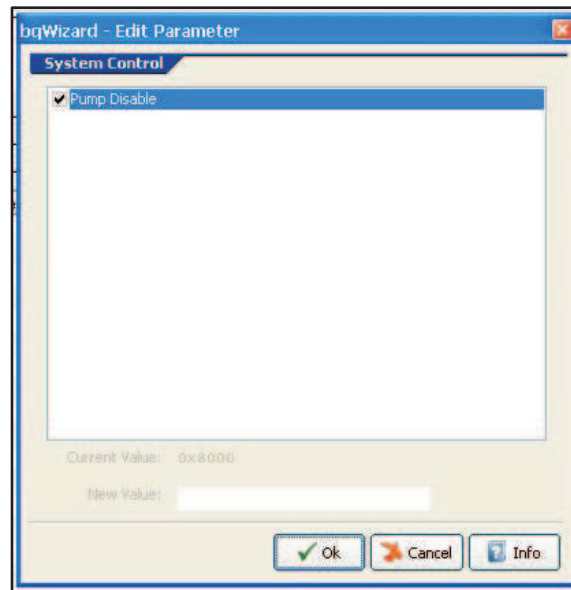

Figure 14. System Control Register

CAUTION

PowerPump™ cell balancing can be used with a cell simulator. However, the cell voltage must not exceed the data-sheet ratings of 2.5 V to 4.5 V/cell. When activated, the PowerPump™ circuits send 70 mA to 90 mA into the resistor string of the cell simulator and disturb the uniform division of the total voltage. It is important to have only the power supply voltage at 3.5 V/cell while the PowerPump™ algorithm is active. This way the swings in cell voltage stay in the recommended cell voltage range.

3.8 Enabling the Gas Gauge

The Quick-Start method is meant for basic understanding of the bq78PL116 feature set and interface with the bqWizard™ software.

The following are some important points:

- If using a cell simulator with the EVM, the gas gauge cannot be properly evaluated.
- With the Inhibit Safety Rules bit checked, the gas gauge does not work properly.
- The gas gauge operation depends on real cells going through charge and discharge cycles to have any meaningful performance.

The explanation of how to enable the gas gauge is presented in the Full-Featured Demonstration section of this document.

3.9 Calibration

The EVM is shipped with the onboard temperature sensors and the current measurement precalibrated. This is done as a convenience for the EVM user. The voltage measurement systems of the bq76PL102 and bq78PL116 are calibrated at the TI factory.

If the user decides to remotely locate temperature sensors or change the current-sense resistor, then temperature calibration and current calibration is required.

3.9.1 Calibration Utility

The temperature measurement and current measurement systems come precalibrated. If for some reason a calibration must be performed, select Calibration... from under the Utilities menu. This opens the calibration screen.

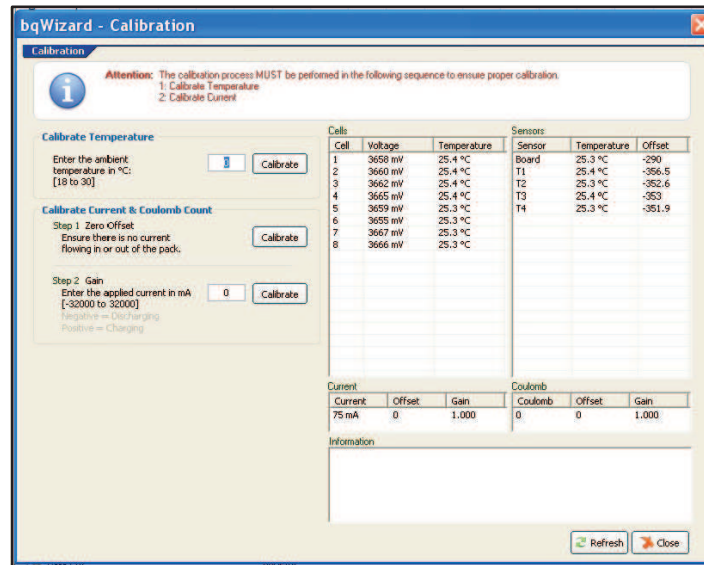

Figure 15. Calibration Screen

Follow the on-screen instructions to calibrate temperature and then current.

When calibrating current with a cell simulator and power supply, ensure that the power supply has enough current to drive both the cell simulator and the load connected to the PACK± terminals of the EVM.

3.10 What to do next?

Simple demonstrations of the EVM using a cell simulator can include:

- Perform a general checkout of the measurement system to verify that it is accurately measuring voltage, current, and temperature.
- Enabling the Safety Rules and causing alarms like COV and CUV to occur by varying the power supply voltage to the cell simulator.
- Connect a load to the PACK± terminals and run constant-current discharge to see current measurement performance.
- See the *bqWizard™ User's Guide* ([SLUU336](#)) for explanation of how data from the bq78PL116 can be logged to a file for analysis. Set up a log definition file (.dlog) to record a host of parameters.
- Use an oscilloscope and the SWx test points referenced to GND1 to explore how the PowerPump™ circuit operates.

The demonstration capability with a cell simulator is beneficial to first-time users. For a demonstration of the advanced features of the gas gauge, connect a cell pack to the EVM, and proceed to the next section.

4 Full-Featured Demonstration

Now that the Quick-Start demonstration from the previous section is completed, the more advanced features of the bq78PL116 and bq76PL102 can be explored. This section is for users who have familiarized themselves with the basic functionality of the bq78PL116, bq76PL102, and the bqWizard™ software.

In this section, the demonstration requires real cells. The process to fully enable the bq78PL116 is explained. This includes enabling the gas gauge, the gas gauge-dependent PowerPump™ algorithms and specifying the Parameter Data Set.

Much of the explanation is done by referring to the lengthy detail contained in other pre-existing documents.

4.1 Enabling Gas Gauge

Enabling the gas gauge involves three steps:

1. Matching your cell type to a Chemistry ID (.chem)
2. Conducting an Auxiliary Chemistry Off-Line Learning cycle and making an Auxiliary Chemistry File (.aux)
3. Programming the Parameter Set, in particular the Charge/Discharge Control parameters, to match cell type and pack configuration

4.1.1 Cell Chemistry (CHEM ID)

A number of cell chemistry files are provided in the bqWizard™ installation. These can be viewed using the Load Chemistry Data command in the bqWizard™ software and selecting the chemistry type and/or cell part number from the list.

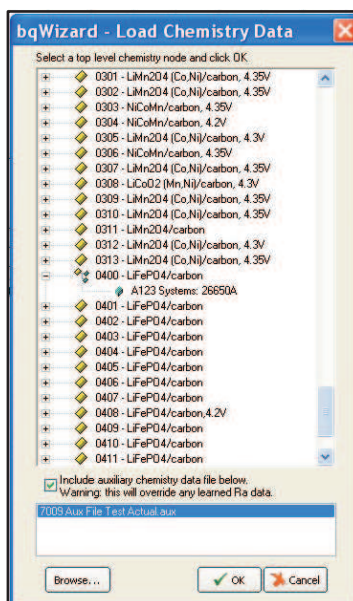

Figure 16. Chemistry ID Loader

Alternatively, the Chem.ini file in the Chemistry subdirectory of the bqWizard™ installation may be opened as read only with a text editor and the part number searched to identify the chemistry number. If the desired cell chemistry is not included in the bqWizard™ installation, a recently created chemistry file may be available, or a new one may be needed. The appropriate chemistry file is needed in order to complete the data collection run for .aux file generation. Chemistry selection for a cell type is described in the *Support of Multiple Li-Ion Chemistries With Impedance Track™ Gas Gauges* application report ([SLUA372](#)).

NOTE: Application report [SLUA372](#) describes loading firmware and learning procedures specific to the bq20zxx gauges which are not applicable to the PowerLAN™ master gateway controller. Ignore these sections for this device. As new chemistry files are created, these may become available in releases of bqWizard™ software, chemistry updates, or individual files.

4.1.2 Auxiliary Chemistry File Creation (.aux file)

Read the application report *Chemistry Selection for bq78PL114* ([SLUA505](#)) prior to proceeding.

The Auxiliary chemistry file creation involves conducting a learning cycle as described in the application report SLUA505. The data from the test is recorded in a comma-separated file (.csv) using the logging capability of the bqWizard™ software. This data then is loaded in the AuxChemFile Utility of the bqWizard™ software to create an .aux file. Finally, the user loads the .aux file with the bqWizard™ software and initializes the gas gauge. The aux file loads the following parameter set values:

Table 15. Parameter Set Values Written by Aux File

Tab	Parameter Name
Cell Chemistry	Tau10
	Normalized Dynamic Impedance Low Temp
	Normalized Dynamic Impedance High Temp
	Normalized Dynamic Impedance Gain
	Normalized Dynamic Impedance SOC

The Auxiliary Chemistry file also writes the following values for each series cell:

Table 16. Gas Gauge Parameters Written by Aux File

Parameter
Initial Normalized Dynamic Impedance
Normalized Dynamic Impedance
Q_{MAX}
Q_{REM}
R_A gridpoints value 0 to 15

The AuxChemFile Utility screen is shown in [Figure 17](#).

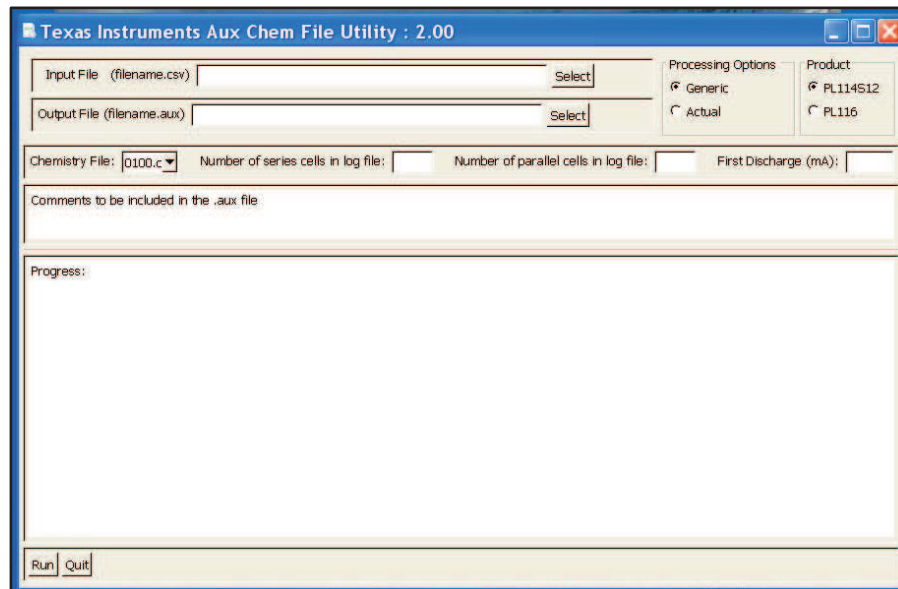

Figure 17. AuxChemFile Utility Screen

An explanation of the use of this utility is as follows:

- **Input File:** This is the log file that was created during the learning cycle described in application report [SLUA505](#).
- **Output File:** This is the user-assigned name of the file that the AuxChemFile Utility creates. Enter the full file name including the .aux extension.
- **Chemistry File:** Select the CHEM ID for the cell under test.
- **Number of Series Cells in Log File:** This is the series cell count of the pack that was tested.

- Number of Parallel Cells in Log File: This is the parallel cell count of the pack that was tested.
- First Discharge: This is the value in mA (use only positive number) of the first constant current discharge from the log file.
- Processing Options: Two methods of analysis are available to the user. The actual method produces the file using the characterization of the individual cells. The generic method removes the worst and best performing cell characterizations and then averages the remaining characterizations to get a generic cell model. Then, this generic cell model is applied to all cells.
- Product: Select bq78PL116.
- Comments to be included with File: Enter any notes to be inserted in the .aux file.

After the file is created, load it by doing the following:

1. Under the File menu, click Select Pack Configuration File, and then Load Configuration From File And Relearn...
2. Select the .aux that was created, and click Open.

At this point, the gas gauge is nearly configured for operation. The remaining step is to configure the parameter set. The two parameter set Tabs that have the greatest influence on the gas gauge operation are the Cell Chemistry Tab and the Charge Control Tab.

4.1.3 Programming the Parameter Set

In the Quick-Start demonstration section, the parameter set was bypassed by disabling safety rules and forcing the MOSFETs to stay on. In the Auxiliary Chemistry File Section, the parameter set was arranged to suit the needs of the learning cycle test. For proper evaluation of the gas gauge, the parameter set must be appropriately programmed for the end-application.

Thoroughly review the *bq78PL116 Technical Reference Manual* ([SLUU481](#)), and set all parameters in the bqWizad™ software. Keep in mind that parameter values must take into account the setting of IPScale or VScale. IPScale affects parameters with units of mA, mAHrs, or 10mWHrs. Vscale effects parameters that have mV (pack voltages only) and 10mWHrs.

Certainly at this point, the Inhibit Safety Rules in the Algorithm Enable register must be cleared to allow normal operation.

The parameter set can be saved for later retrieval by doing the following:

1. Under the File menu, select Data Set
2. Select Save Data Set
3. The data set is saved in a comma-separated-value format with a .ppcsv extension.

Each Charge Control and Cell Chemistry parameter must be reviewed to ensure that it properly reflects the needs of the application and the cell type.

Table 17. Charge Control Parameters

Parameter	Units	Default Value
Precharge Temperature	Kelvin	273
Precharge Voltage	mV	2900
Precharge Recovery	mV	3000
Precharge Current	mA	240
Charge Inhibit Temperature Low	Kelvin	273
Charge Inhibit Temperature High	Kelvin	318
Charge Inhibit Recovery Temperature Low	Kelvin	278
Charge Inhibit Recovery Temperature High	Kelvin	313
Charge Suspend Temperature Low	Kelvin	278
Charge Suspend Recovery Temperature Low	Kelvin	283
Charge Suspend Temperature High	Kelvin	333
Charge Suspend Recovery Temperature High	Kelvin	328
Charge Completion Pack Voltage Qualifier	mV	12300

Table 17. Charge Control Parameters (continued)

Parameter	Units	Default Value
Charge Completion Taper Current Qualifier	mA	120
Charge Completion Time	Seconds RDTE	4
Charge Completion FET Activation Time	Seconds RDTE	0
Discharge Completion Pack Voltage Qualifier	mV	9300
Discharge Completion Time	Seconds RDTE	4
Discharge Completion FET Activation Time	Seconds RDTE	0
Discharge Under Temperature	Kelvin	263
Discharge Under Temperature Recovery	Kelvin	273
Discharge Under Temperature Time	Seconds RDTE	2
FC Set SOC Threshold	%	-1
FC Clear SOC Threshold	%	-1
FD Set SOC Threshold	%	-1
FD Clear SOC Threshold	%	-1
FD Set Voltage	mV	9300
FD Clear Voltage	mV	9600
FD Set Voltage Time	Seconds	0
Transition to Idle Current	mA	50
Transition to Idle Time	Seconds	30
Transition to Discharge Current	mA	-75
Transition to Charge Current	mA	75
Design Capacity mAh	mAh	2400
Design Capacity 10mWh	mWh / 10	2592
TDA Set SOC Threshold	%	-1
TDA Set Voltage Threshold	mV	9600
TDA Set Voltage Time	Seconds	2
TDA Clear SOC Threshold	%	-1
TDA Clear Voltage	mV	11100
TCA Set SOC Threshold	%	-1
TCA Clear SOC Threshold	%	-1
OCA Set Voltage	mV	12900
OCA Activation Time	Seconds RDTE	2

Table 18. Cell Chemistry

Parameter	Units	Default Value
Chemistry ID		400
FCC Learn Qualifier ⁽¹⁾	%	30
Cycle Fade ⁽¹⁾	%	0.05
Min OCV Slope ⁽¹⁾	mV per % RSOC	2
OCV Idle Qualifier	Minutes	60
Stale FCC Timeout	Minutes	2880
Default Charging Voltage	mV	12600
Default Charging Current	mA	1680
Capacity Algorithm		0x0003
User Rate	mA	480

⁽¹⁾ It is not recommend that these values be changed from the default.

4.2 Selecting PowerPump™ Algorithm and Other Variables

The PowerPump™ algorithm was using the terminal voltage during the Quick-Start demonstration section. That algorithm does not rely on the gas gauge. Now that the cells are connected and the gas gauge has been set up, the other two algorithms can be considered.

To gain more understanding of the PowerPump™ circuitry and operation, consult the application report *PowerPump™ Balancing* (SLUA524).

The PowerPump™ circuitry needs to be turned on for almost all applications. This is because device power comes from individual cells. For example, the bulk of the power consumed by the bq78PL116 comes from cell 2. This causes a natural cell imbalance over a long time. Ensure that the System Control register is set to 0x00.

The PowerPump™ bits in the Algorithm Enable register operate as follows.

Table 19. PowerPump™ Algorithm Bits Definition

Pump Algorithm Bit 0	Pump Algorithm Bit 1	Pump Mode	Function
NORMAL OPERATION MODE			
0	0	1	Reserved, not Used
1	0	1	State-of-Charge Based Algorithm
0	1	1	Open-Circuit-Voltage Based Algorithm (default)
1	1	1	Terminal-Voltage Based Algorithm
PRODUCTION TEST MODE ONLY!			
0	0	0	Reserved, not Used
1	0	0	All Cells Pump North
0	1	0	All Cells Pump South

State-of-charge (SOC)-based algorithm uses the distance a cell is away from 100% SOC as the PowerPump™ decision mechanism. SOC attempts to have all cells at 100% SOC at the end of charge. It is predictive and minimizes balancing during charge cycle. A lower capacity cell reaches 100% faster. It then diverts the extra current to the cells that have a larger nominal capacity and are at a lower SOC. This is good for cells with a flat voltage curve.

Open-Circuit-Voltage (OCV)-based algorithm uses cell OCV as the PowerPump™ decision mechanism. OCV algorithm compensates for differences in cell impedances within the pack. This is the default algorithm.

When viewing PowerPump™ progress in the bqWizard™ software, keep in mind that the plot display is terminal voltage. To see OCV and SOC progress, view the Dynamic and Learned Tabs in the Cells Section of the bqWizard™ display, or log the values for later viewing.

4.3 Test and Evaluation

This section describes some ways to demonstrate the capability of the bq78PL116EVM.

4.3.1 Evaluate the Gas Gauge

The best way to demonstrate the gas gauging features is to conduct cycles consisting of a charge period, rest period, discharge period, and second rest period. A description of a typical scenario follows.

The charge period is initialized by a constant voltage clamp at the value of the Default Charging Voltage Parameter and constant-current clamp at the value the Default Charging Current Parameter. In time, the charge current tapers, and eventually the Charge Completion Control Rule terminates the charge period.

The open-circuit rest period lasts for a period longer than the value of the OCV Idle Qualifier time. This allows gas gauge parameters to update.

The discharge period is a constant-current type at less than the C-rate of the battery, perhaps C/2 or C/5. This period is typically terminated when a CUV or PUV rule is activated.

The next rest period is identical to the first.

The bqWizard™ logging capability can be leveraged to evaluate SBData parameters like RelativeStateofCharge(), FullChargeCapacity(), and RemainingCapacity() during this time.

4.3.2 Enter and Exit Ship Mode

Ship mode is an ultralow-power state where all functionality is periodically suspended except for an internal timer. The MOSFETs are always open in Ship mode. This mode is not entered in normal operation. It is intended that the device be put into this mode after factory configuration and test and prior to shipment.

Ship mode has entrance and exit criteria and mode behavior that is periodic, based on the internal timer mentioned above. Entrance Criteria:

The device can enter Ship mode when all of the following criteria are satisfied.

1. Ship mode bit is set.
2. SMBus lines (Clock, Data) remain low and stay low for 2 to 4 seconds.
3. A First- or Second-Level Safety Condition is not present or pending.
4. A permanent failure condition is not present; SPROT output is low.
5. Cell balancing is not required.
6. Pushbutton is not being pressed or serviced.
7. When configured for LED display, no pattern is being displayed.

Exit Criteria: The device can exit Ship mode in two ways: permanent and temporary.

Permanent Exit criteria: The permanent exit is intended to be a single event. This occurs when a shipped pack is first used in the application. The device can be made to permanently exit Ship mode when the SMBus lines (Clock, Data) are pulled high for 2 to 4 seconds. The only way to re-enter Ship mode is then to set the Ship bit and satisfy the Entrance Criteria.

Temporary Exit from Ship mode: The PowerLAN™ Master Gateway controller performs the following tasks on a periodic basis while in Ship mode. This is considered a temporary exit from Ship mode or its modal behavior.

1. Tests for SMBus activity at 2-second intervals. This is the check for a permanent exit criteria previously mentioned (SMBus pins detected as high).
2. Tests for SOCI pushbutton press at 2-second intervals. If a pushbutton is detected, the SOCI display is serviced, and the device is put into Active mode until the SOCI display timer is elapsed.
3. Active mode is entered for a minimum of 10 to 12 seconds at a 6-minute interval. During this time:
 - (a) First- and Second-Level Safety rules are evaluated. An active safety rule keeps the device in Active mode until the safety rule violation is cleared.
 - (b) PowerPump™ Cell Balancing is performed if necessary. A cell imbalance keeps the device in Active mode until the cells return to balance as determined by the Minimum Cell Differential for Balancing parameter value.

The Ship mode demonstration procedure is as follows:

1. The bulk of power for the bq78PL116 comes from the V2 connection. With the battery completely disconnected from the EVM, consider placing an ammeter in the V2 connection of the bq78PL116. The V2 connection is on header J9 at the pin labeled 2. Reconnect battery following the prescribed connection sequence after the ammeter is installed.
2. The EVM must be powered and connected to the bqWizard™ software. All of the Ship Mode Entrance Criteria previously mentioned must be satisfied.
3. Under the Commands menu in the bqWizard™ screen, Toggle the Ship bit. The word Ship in the Status section changes from grey to green.
4. Close the bqWizard™ software.
5. Remove the USB-TO-GPIO connector from header J8 of the EVM.
6. If an ammeter was connected in series with the V2 voltage, the current level drops to the Ship mode level described in the bq78PL116 data sheet.
7. Stay in Ship mode as long as is desired.
8. To exit Ship mode, re-connect the USB-TO-GPIO adapter to header J8 of the EVM.

9. If an ammeter was connected in series with the V2 voltage, the current level increases back to the Active mode level described in the bq78PL116 data sheet.
10. Open the bqWizard™ screen to see normal operation and that the Ship bit is no longer checked as evidenced by the word Ship in the Status section being colored grey.

5 Schematic and Bill of Materials

5.1 Schematic

The bq78PL116EVM schematic appears at the end of this manual.

5.2 Bill of Materials

RefDes	Value	Description	Size	Manufacturer	Part Number
PCB	ENIG	Printed Circuit Board, 4 Layers, 1oz/0.5oz (Out/In) Top Silkscreen, Top/Bottom Mask, FR-4 (or equal)	Rectangular 6.0" x 8.6" x 0.062" 0.200" Corners		HPA659A
11S 13S 15S 3S 5S 7S 9S		PCB Feature: Solder Bridge		None	None
C1-2 C7 C12 C17 C19 C21 C25 C32 C36 C40 C43-44 C52 C65 C67 C70-71 C77-78 C83-85 C90-91 C94 C96-97 C103-104	3300 pF	Capacitor SMT Ceramic X7R ±10% 50V	603	Standard	Standard
C3 C33-34 C51 C53-64	0.01uF	Capacitor SMT Ceramic X7R ±10% 25V	603	Standard	Standard
C4 C6 C11 C18 C23-24 C28 C31 C47-50 C68-69 C72 C74-76 C87-89 C100-102	10uF	Capacitor SMT Ceramic X5R ±10% 6.3V	603	Standard	Standard
C5 C16 C20 C30 C37-39 C45 C66 C79-80 C82 C92-93 C95 C98	22uF	Capacitor SMT Ceramic 10V Y5V ±20%	805	Standard	Standard
C8-9 C13-15 C26 C29 C46 C73 C81 C86 C99	1000pF	Capacitor SMT Ceramic X7R ±10% 50V	603	Standard	Standard
C10 C22 C41-42	0.1uF	Capacitor SMT Ceramic 100V X7R 10%	805	Standard	Standard
C35	1.0uF	Capacitor SMT Ceramic X7R ±10% 16V	603	Standard	Standard
CHG DSG GND1 PRE SPROT Z	Black	Test Clip Point Color Coded	0.062" Dia.	Keystone	5011
CLK DAT PLAN SDO0 SDO2 SDO4-8 SW1-15 VLDO1-8	White	Test Clip Point Color Coded	0.062" Dia.	Keystone	5012
D1		Transient Voltage Suppressor 1500W	SMC	LITTELFUSE	SMCJ70CA
D2	10A	Diode 10A 200V	SMC	Micro Comm. Corp	S10D-TP
D3-32	500mA	Schottky Rectifier Diode 20V	SOD-123	Fairchild	MBR0520L
FUSE LED1-5	Green/25mA	Green Diffused LED 1.6mm x 0.8mm SMT	603	Lumex	SML-LX0603GW-TR
J1-2 J7		Header, MTA, 0.100", Straight, Vertical, Friction Lock, Tin	0.255"x0.400"x0.395"	AMP	640454-4
J3-6	30 Amps	Screw Terminal Brass/Tin and 10-32 Screw	0.470"x0.470"x0.453"	Keystone	8196
J8	0.1" Pitch	Header Straight Dual Row Gold Shrouded Keyed	0.338"x0.708"x0.390"	AMP	5103309-1
J9	8Amp	Terminal Block Header, 5 pos., Vert., 3.81mm UL94-V0		Phoenix Contact	1803455
J9	8Amp	Plug for Terminal Block Header, 5 Position, 3.81mm UL94-V0		Phoenix Contact	1803604
J10-12	8Amp	Terminal Block Header, 4 pos., Vert., 3.81mm UL94-V0		Phoenix Contact	1803442
J10-12	8Amp	Plug for Terminal Block Header, 4 pos., Vert., 3.81mm UL94-V0		Phoenix Contact	1827143
L1-15	4.7µH	Inductor SMD Shielded Isat=2.0A	4.9mm x 4.9mm x 2.0mm	Taiyo Yuden	NRS5020T4R7MMGJ
P+ V1-16	Red	Test Clip Point Color Coded	0.62" Dia.	Keystone	5010
Q1-4 Q7 Q27	Vgs=20V	MOSFET N-Channel 2.4Vgs max rated	SOT-23	Zetex	ZVN3310FTA
Q5-6	Idss=0.2 to 1.0mA	JFET Amplifier N-Channel General Purpose	SOT-23	Fairchild	MMBFJ201
Q8-12 Q14 Q16-24	±8Vgs	MOSFET N/P Complementary Pair Vgsth = 1.5Vmax	6-TSOP	Alpha & Omega	AO6604
Q13 Q15 Q25-26	0.019 Ω RDSon	MOSFET P-Channel SMT -100Vds	TO-263 D2PAK	Vishay	SUM90P10-19L
R1 R11 R23 R28 R38 R49-50 R58 R74 R77-78	1.0M	Resistor SMT 1/10W ±5%	603	Standard	Standard
R2 R5 R8-10 R16-17 R19 R21 R24-25 R27 R29 R35-36 R39 R41 R43-44 R46-47 R51-52 R54-55 R60 R62-63 R66 R69 R71 R73	20K	Resistor SMT 1/10W ±5%	603	Standard	Standard

RefDes	Value	Description	Size	Manufacturer	Part Number
R3 R6-7 R12-15 R18 R20 R22 R26 R30-34 R37 R42 R45 R48 R53 R61 R65 R72	100	Resistor SMT 1/10W ±5%	603	Standard	Standard
R4 R59	10K	Resistor SMT 1/10W ±5%	603	Standard	Standard
R40 R56	100K	Resistor SMT 1/10W ±5%	603	Standard	Standard
R57 R67-68	4.7K	Resistor SMT 1/10W ±5%	603	Standard	Standard
R64 R70 R79	200K	Resistor SMT 1/10W ±5%	603	Standard	Standard
R75-76	3K	Resistor SMT 1W ±1% ±100ppm	2512	Standard	Standard
RSENSE RSENSE1-2	0.03	Resistor SMT Thick Film 1W ±1% ±75ppm/°C	2512	Standard	Standard
SOCI	50mA	Tactile Momentary Pushbutton Thru-Hole		Panasonic	EVQ-PE504K
T1-4		Dual Diode Series Connection	SOT-23	Fairchild	MMBD4148SE
U1-6	QFN-16	PowerLAN Dual Cell Monitor	QFN16	Texas Instruments	bq76PL102RGTT
U7	3-16 Cells	PowerLAN Master Gateway Battery Management Controller	QFN-48	Texas Instruments	bq78PL116RGZR
VSS	Yellow	Test Clip Point Color Coded	0.062" Dia.	Keystone	5014
X1-9	0.156" dia.	Mounting Hole for #6 Screw (PCB Feature)			
Z1-2	300mW	Common Anode Zener Diode Pair	SOT-23	Diode Inc	AZ23C5V6-7-F
Z3-5	500mW	Zener Diode 500mW 12V	SOD-123	Diodes, Inc	BZT52C12-13-F

6 bq78PL118EVM Printed-Circuit Board

This section includes the plots of the printed-circuit board (PCB) layers.

6.1 PCB Layers

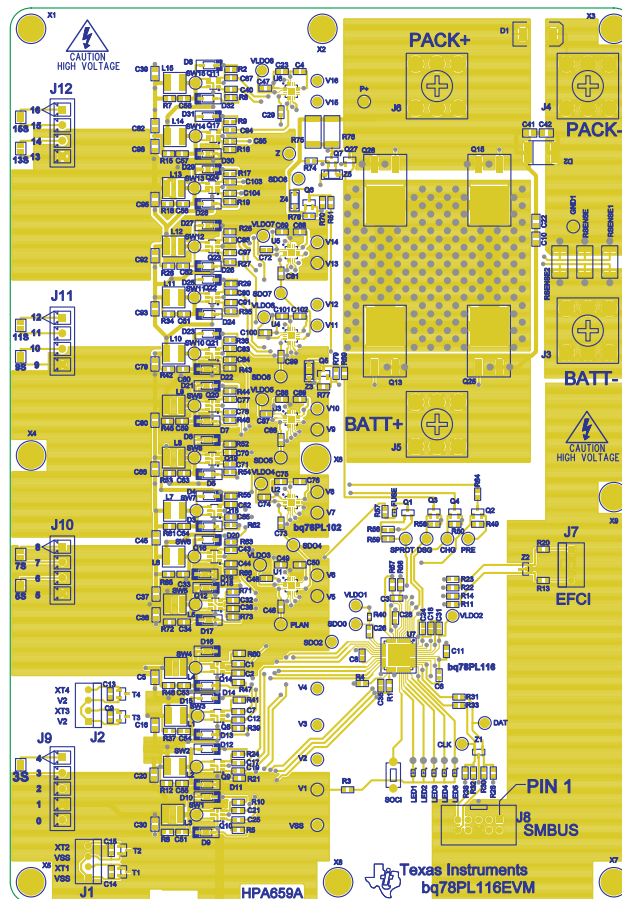

Figure 18. Top View

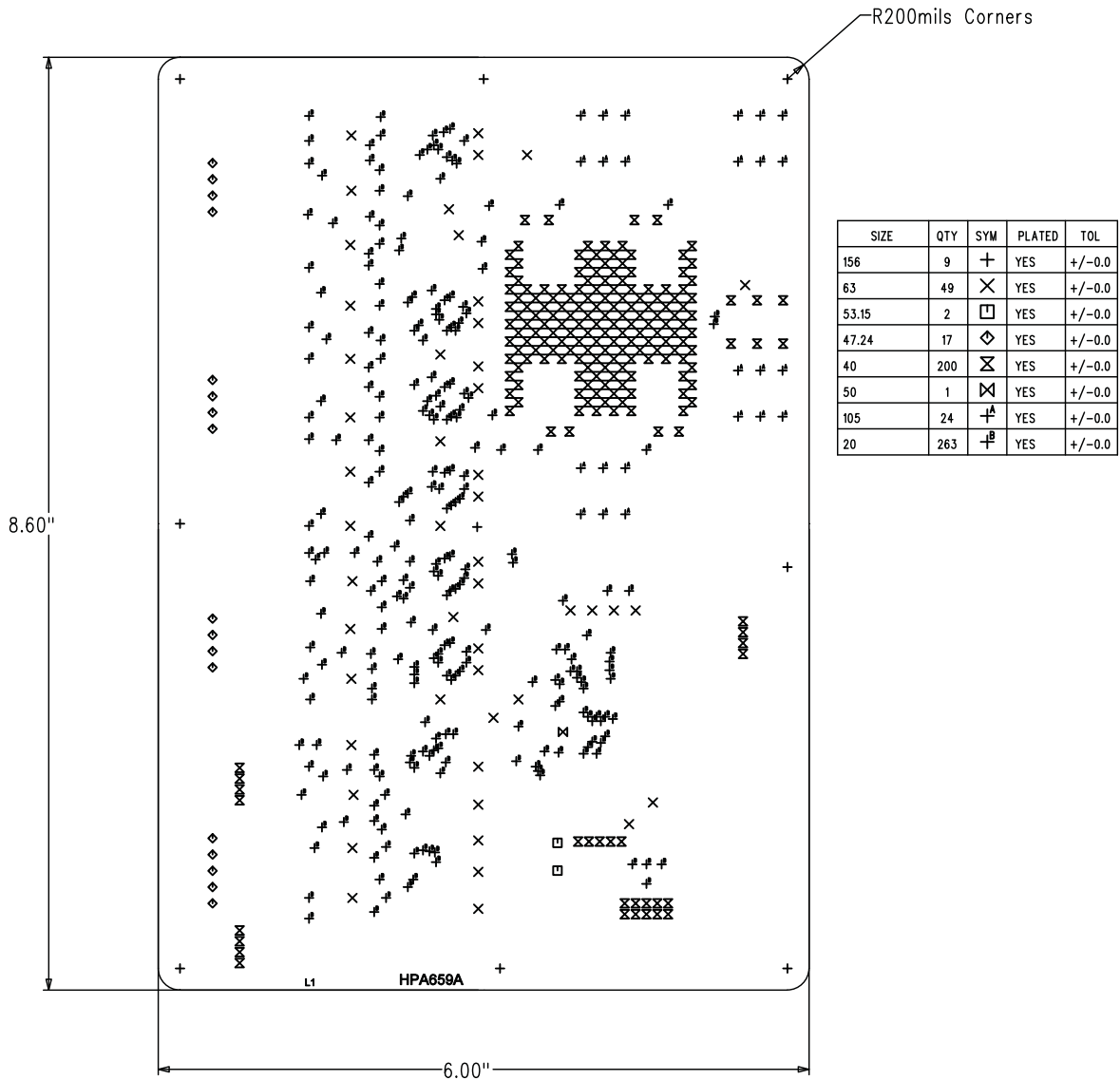

Figure 19. Drill Drawing

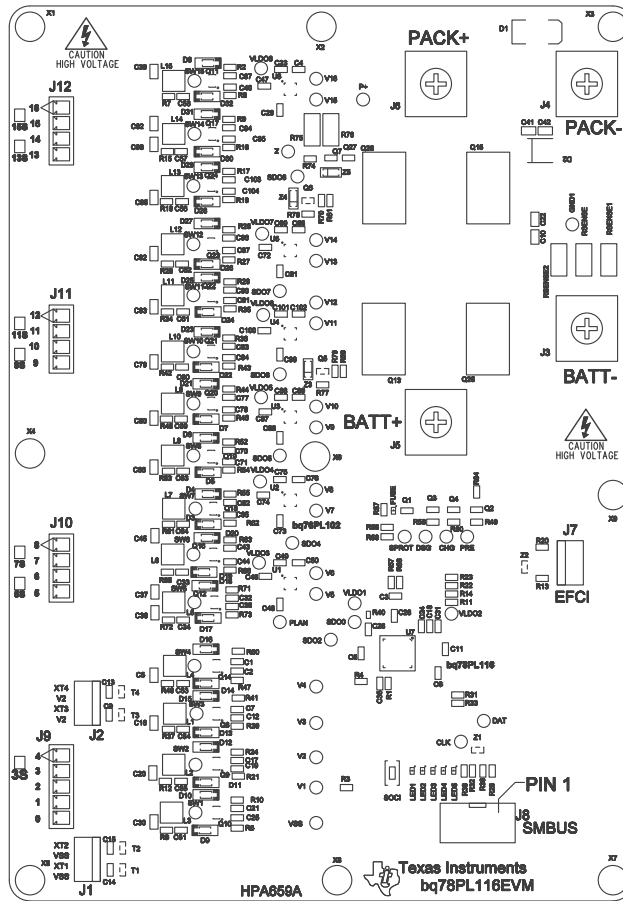

Figure 20. Top Silkscreen

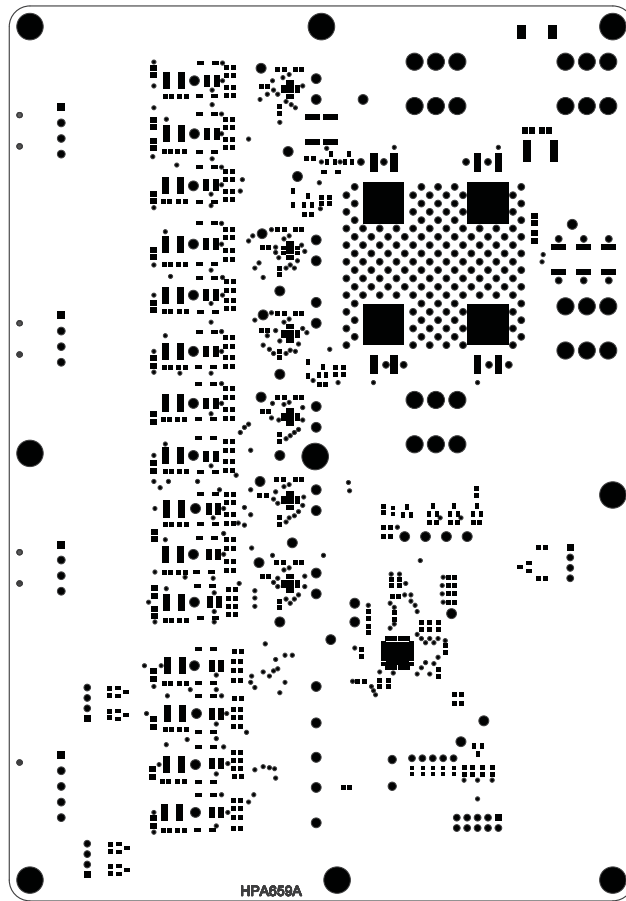

Figure 21. Top Solder Mask

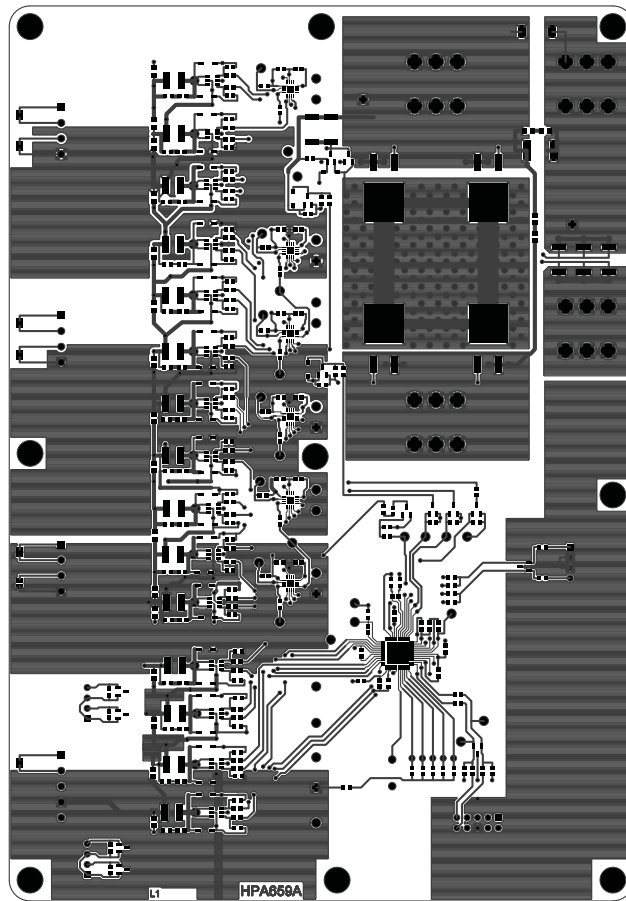

Figure 22. Top Copper, Layer 1

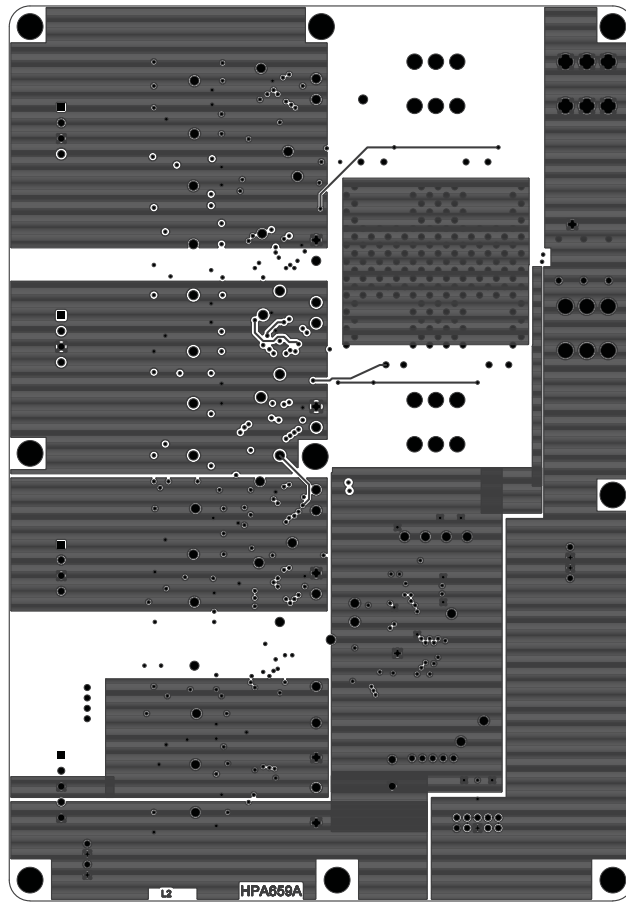

Figure 23. Inner Copper, Layer 2

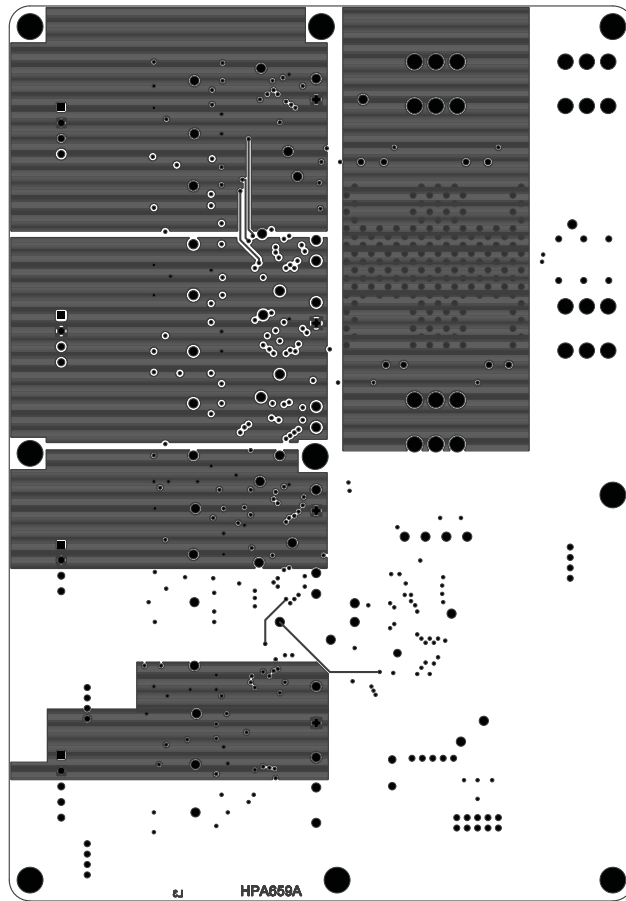

Figure 24. Inner Copper, Layer 3

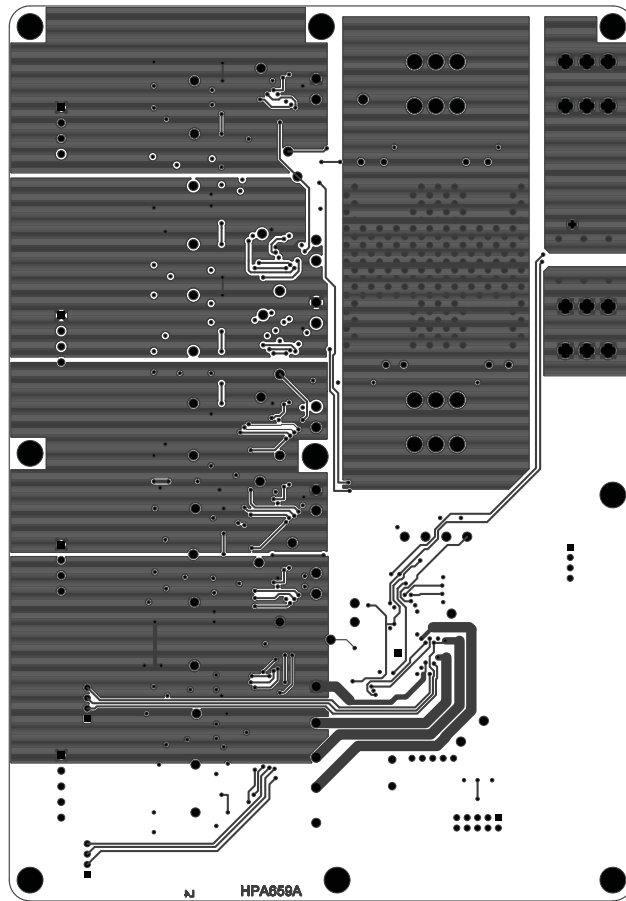

Figure 25. Bottom Copper, Layer 4



Figure 26. Bottom Solder Mask

7 Related Documentation

7.1 Related Documentation From Texas Instruments

Related documentation from Texas Instruments includes the following:

- *PowerLAN™ Master Gateway Battery Management Controller With PowerPump™ Cell Balancing Technology* data sheet ([SLUSAB8](#))
- *Technical Reference Manual for the bq78PL116* ([SLUU481](#))
- *PowerLAN™ Dual-Cell Li-Ion Monitor with PowerPump™ Cell Balancing* data sheet ([SLUS887](#))
- *bqWizard™ User's Guide* ([SLUU336](#))
- *PowerPump™ Balancing* application report ([SLUA524](#))
- *Chemistry Selection for bq78PL114* application report ([SLUA505](#))
- *What is a .tmap File?* application report ([SLUA542](#))

7.2 Documentation From Other Sources

Related documentation from other sources includes:

- System Management (SMBus) Specification, version 2.0
 - <http://smbus.org/specs/>
- Smart Battery Data Specification, version 1.1
 - <http://smartbattery.org/specs/sbdat110.pdf>

REVISION RECORD		
LTR	ECO NO:	APPROVED DATE:

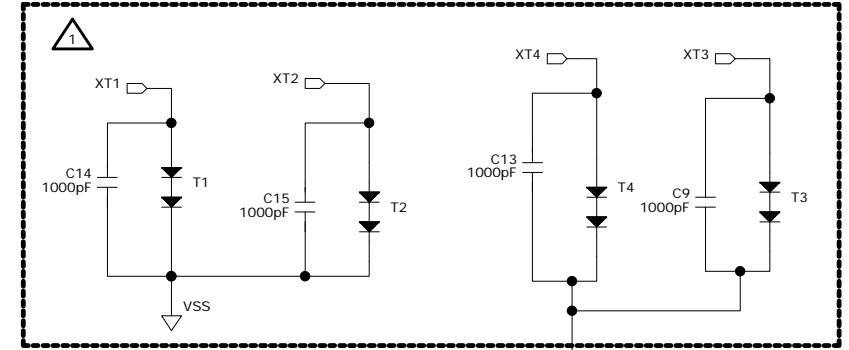
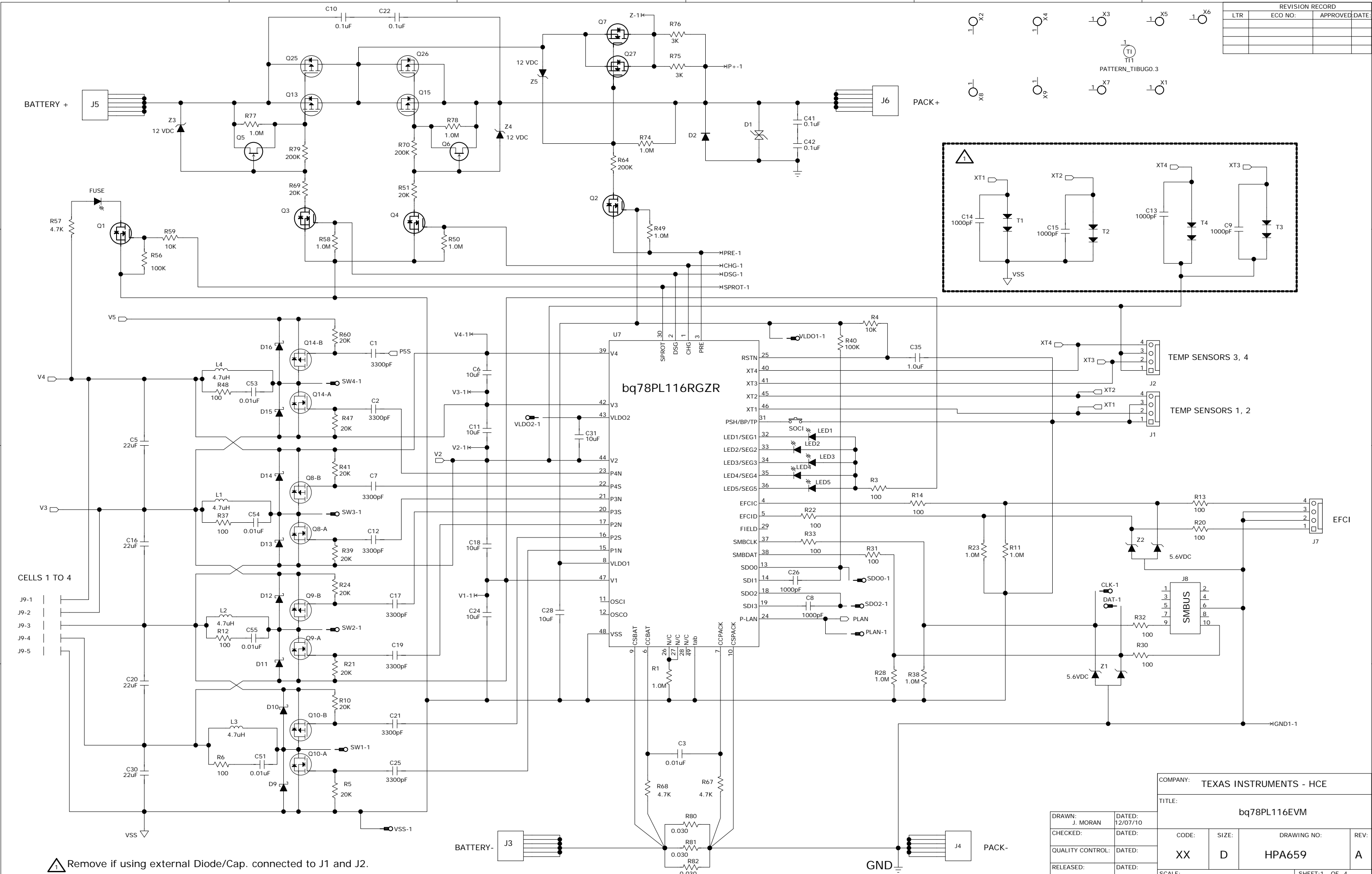

Remove if using external Diode/Cap. connected to J1 and J2.

DRAWN: J. MORAN	DATED: 12/07/10
CHECKED:	DATED:
QUALITY CONTROL:	DATED:
RELEASED:	DATED:

COMPANY: TEXAS INSTRUMENTS - HCE			
TITLE: bq78PL116EVM			
CODE: XX	SIZE: D	DRAWING NO: HPA659	REV: A
SCALE:		SHEET:1 OF 4	

REVISION RECORD			
LTR	ECO NO.	APPROVED	DATE

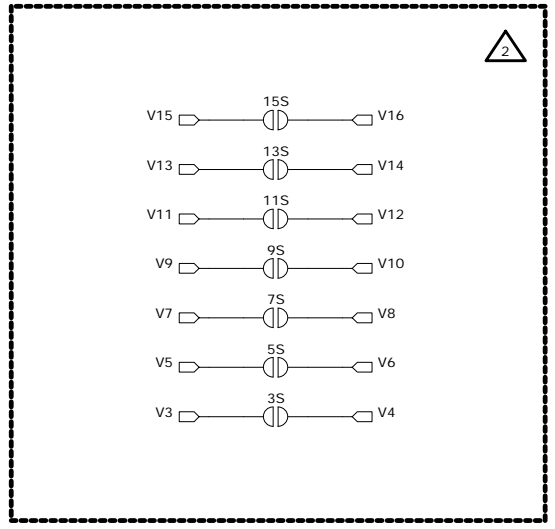
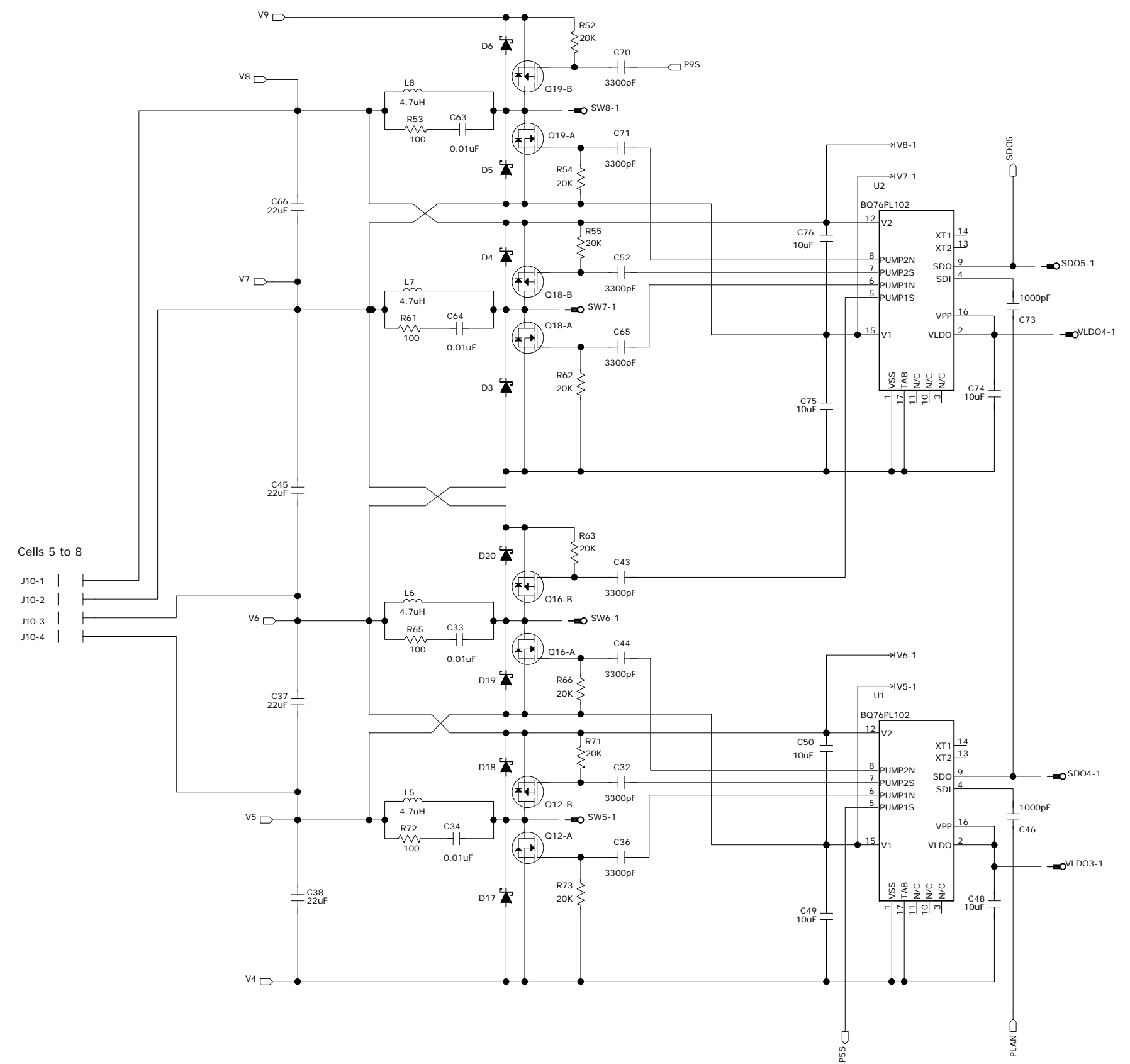

⚠ For odd series cell count the next higher voltage input must be shorted to the top (odd) cell. For example, for a 7S pack short solder bridge 7S (only).

COMPANY: TEXAS INSTRUMENTS - HCE			
TITLE: bq78PL116EVM			
DRAWN: J. MORAN	DATED: 12/07/10	CODE: XX	SIZE: D
CHECKED:	DATED:	DRAWING NO: HPA659	REV: A
QUALITY CONTROL:	DATED:	SCALE:	SHEET: 2 OF 4
RELEASED:	DATED:		

REVISION RECORD			
LTR	ECO NO.	APPROVED	DATE

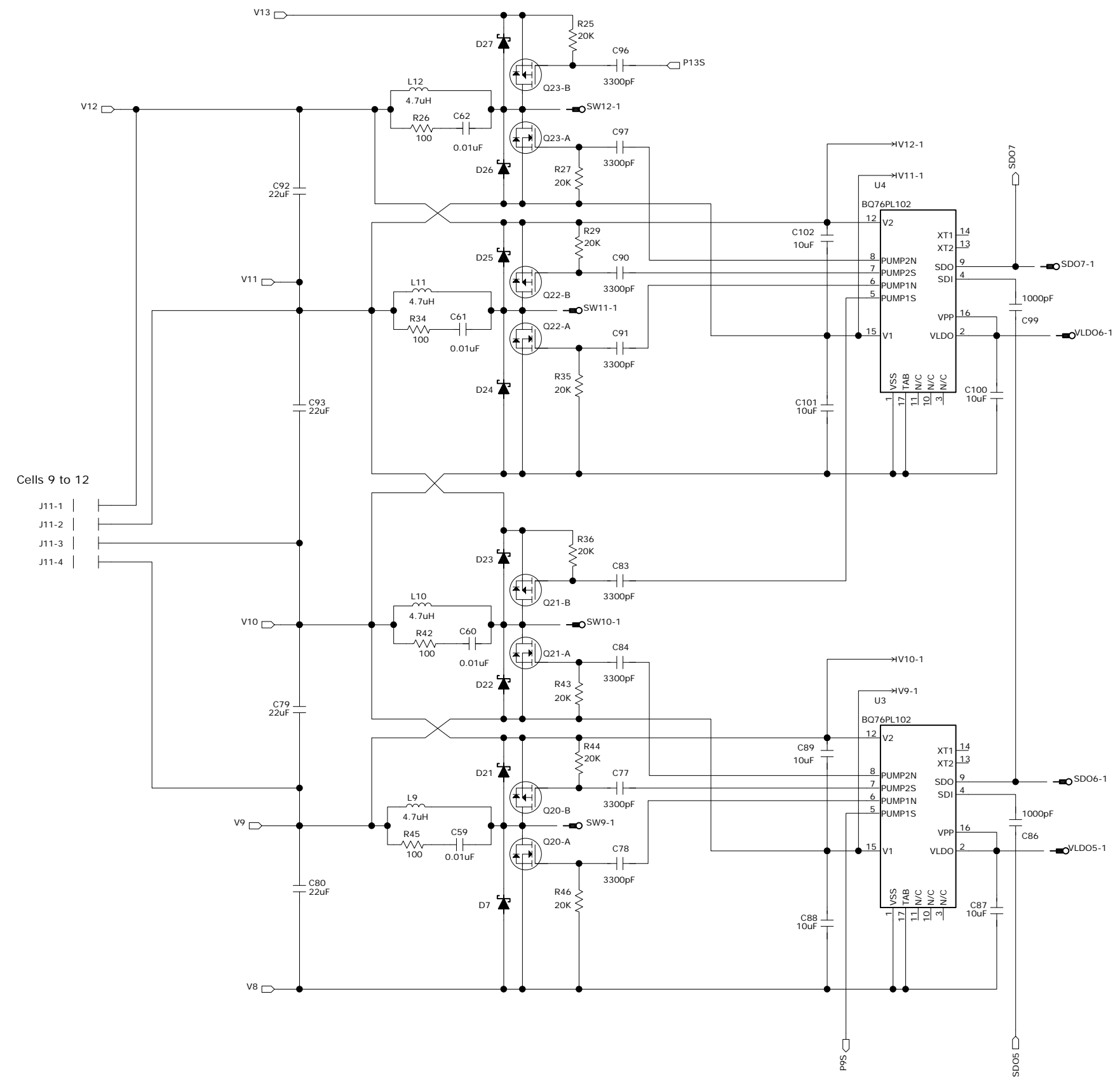

Cells 9 to 12

J11-1 |
 J11-2 |
 J11-3 |
 J11-4 |

COMPANY: TEXAS INSTRUMENTS - HCE			
TITLE: bq78PL116EVM			
DRAWN: J. MORAN	DATED: 12/07/10	CODE: XX	SIZE: D
CHECKED:	DATED:	DRAWING NO: HPA659	REV: A
QUALITY CONTROL:	DATED:	SCALE:	
RELEASED:	DATED:	SHEET: 3 OF 4	

REVISION RECORD			
LTR	ECO NO.	APPROVED	DATE

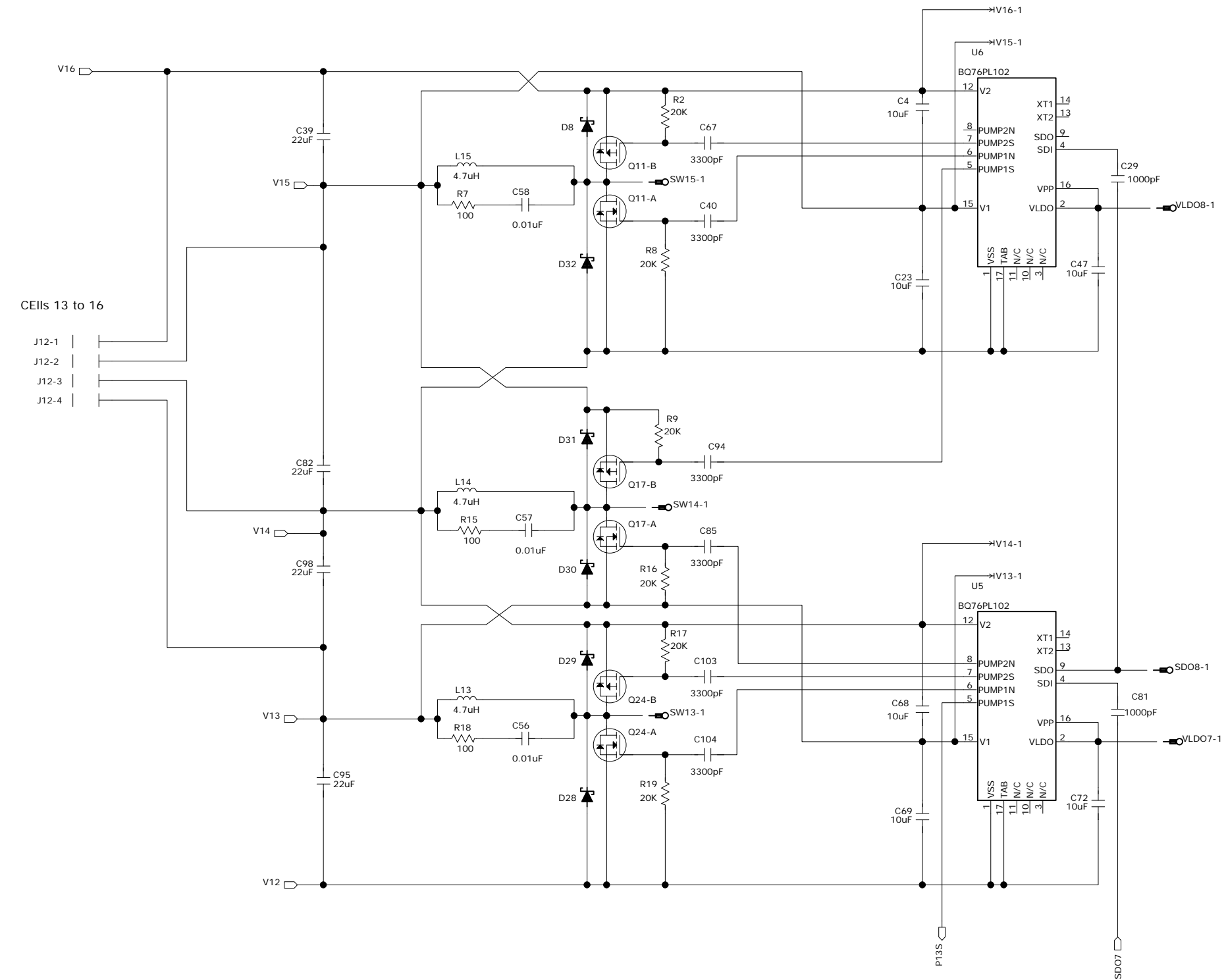

Cells 13 to 16

J12-1
J12-2
J12-3
J12-4

COMPANY: TEXAS INSTRUMENTS - HCE			
TITLE: bq78PL116EVM CELL BALANCING CIRCUITRY			
DRAWN: J. MORAN	DATED: 12/07/10	CODE: XX	SIZE: D
CHECKED:	DATED:	DRAWING NO: HPA659	REV: A
QUALITY CONTROL:	DATED:	SCALE:	SHEET: 4 OF 4
RELEASED:	DATED:		

Evaluation Board/Kit Important Notice

Texas Instruments (TI) provides the enclosed product(s) under the following conditions:

This evaluation board/kit is intended for use for **ENGINEERING DEVELOPMENT, DEMONSTRATION, OR EVALUATION PURPOSES ONLY** and is not considered by TI to be a finished end-product fit for general consumer use. Persons handling the product(s) must have electronics training and observe good engineering practice standards. As such, the goods being provided are not intended to be complete in terms of required design-, marketing-, and/or manufacturing-related protective considerations, including product safety and environmental measures typically found in end products that incorporate such semiconductor components or circuit boards. This evaluation board/kit does not fall within the scope of the European Union directives regarding electromagnetic compatibility, restricted substances (RoHS), recycling (WEEE), FCC, CE or UL, and therefore may not meet the technical requirements of these directives or other related directives.

Should this evaluation board/kit not meet the specifications indicated in the User's Guide, the board/kit may be returned within 30 days from the date of delivery for a full refund. **THE FOREGOING WARRANTY IS THE EXCLUSIVE WARRANTY MADE BY SELLER TO BUYER AND IS IN LIEU OF ALL OTHER WARRANTIES, EXPRESSED, IMPLIED, OR STATUTORY, INCLUDING ANY WARRANTY OF MERCHANTABILITY OR FITNESS FOR ANY PARTICULAR PURPOSE.**

The user assumes all responsibility and liability for proper and safe handling of the goods. Further, the user indemnifies TI from all claims arising from the handling or use of the goods. Due to the open construction of the product, it is the user's responsibility to take any and all appropriate precautions with regard to electrostatic discharge.

EXCEPT TO THE EXTENT OF THE INDEMNITY SET FORTH ABOVE, NEITHER PARTY SHALL BE LIABLE TO THE OTHER FOR ANY INDIRECT, SPECIAL, INCIDENTAL, OR CONSEQUENTIAL DAMAGES.

TI currently deals with a variety of customers for products, and therefore our arrangement with the user **is not exclusive.**

TI assumes **no liability for applications assistance, customer product design, software performance, or infringement of patents or services described herein.**

Please read the User's Guide and, specifically, the Warnings and Restrictions notice in the User's Guide prior to handling the product. This notice contains important safety information about temperatures and voltages. For additional information on TI's environmental and/or safety programs, please contact the TI application engineer or visit www.ti.com/esh.

No license is granted under any patent right or other intellectual property right of TI covering or relating to any machine, process, or combination in which such TI products or services might be or are used.

FCC Warning

This evaluation board/kit is intended for use for **ENGINEERING DEVELOPMENT, DEMONSTRATION, OR EVALUATION PURPOSES ONLY** and is not considered by TI to be a finished end-product fit for general consumer use. It generates, uses, and can radiate radio frequency energy and has not been tested for compliance with the limits of computing devices pursuant to part 15 of FCC rules, which are designed to provide reasonable protection against radio frequency interference. Operation of this equipment in other environments may cause interference with radio communications, in which case the user at his own expense will be required to take whatever measures may be required to correct this interference.

EVM Warnings and Restrictions

It is important to operate this EVM within the input voltage range of 8.4 V to 72 V and the output voltage range of 8.4 V to 72 V .

Exceeding the specified input range may cause unexpected operation and/or irreversible damage to the EVM. If there are questions concerning the input range, please contact a TI field representative prior to connecting the input power.

Applying loads outside of the specified output range may result in unintended operation and/or possible permanent damage to the EVM. Please consult the EVM User's Guide prior to connecting any load to the EVM output. If there is uncertainty as to the load specification, please contact a TI field representative.

During normal operation, some circuit components may have case temperatures greater than 65° C. The EVM is designed to operate properly with certain components above 65° C as long as the input and output ranges are maintained. These components include but are not limited to linear regulators, switching transistors, pass transistors, and current sense resistors. These types of devices can be identified using the EVM schematic located in the EVM User's Guide. When placing measurement probes near these devices during operation, please be aware that these devices may be very warm to the touch.

Mailing Address: Texas Instruments, Post Office Box 655303, Dallas, Texas 75265
Copyright © 2011, Texas Instruments Incorporated

IMPORTANT NOTICE

Texas Instruments Incorporated and its subsidiaries (TI) reserve the right to make corrections, modifications, enhancements, improvements, and other changes to its products and services at any time and to discontinue any product or service without notice. Customers should obtain the latest relevant information before placing orders and should verify that such information is current and complete. All products are sold subject to TI's terms and conditions of sale supplied at the time of order acknowledgment.

TI warrants performance of its hardware products to the specifications applicable at the time of sale in accordance with TI's standard warranty. Testing and other quality control techniques are used to the extent TI deems necessary to support this warranty. Except where mandated by government requirements, testing of all parameters of each product is not necessarily performed.

TI assumes no liability for applications assistance or customer product design. Customers are responsible for their products and applications using TI components. To minimize the risks associated with customer products and applications, customers should provide adequate design and operating safeguards.

TI does not warrant or represent that any license, either express or implied, is granted under any TI patent right, copyright, mask work right, or other TI intellectual property right relating to any combination, machine, or process in which TI products or services are used. Information published by TI regarding third-party products or services does not constitute a license from TI to use such products or services or a warranty or endorsement thereof. Use of such information may require a license from a third party under the patents or other intellectual property of the third party, or a license from TI under the patents or other intellectual property of TI.

Reproduction of TI information in TI data books or data sheets is permissible only if reproduction is without alteration and is accompanied by all associated warranties, conditions, limitations, and notices. Reproduction of this information with alteration is an unfair and deceptive business practice. TI is not responsible or liable for such altered documentation. Information of third parties may be subject to additional restrictions.

Resale of TI products or services with statements different from or beyond the parameters stated by TI for that product or service voids all express and any implied warranties for the associated TI product or service and is an unfair and deceptive business practice. TI is not responsible or liable for any such statements.

TI products are not authorized for use in safety-critical applications (such as life support) where a failure of the TI product would reasonably be expected to cause severe personal injury or death, unless officers of the parties have executed an agreement specifically governing such use. Buyers represent that they have all necessary expertise in the safety and regulatory ramifications of their applications, and acknowledge and agree that they are solely responsible for all legal, regulatory and safety-related requirements concerning their products and any use of TI products in such safety-critical applications, notwithstanding any applications-related information or support that may be provided by TI. Further, Buyers must fully indemnify TI and its representatives against any damages arising out of the use of TI products in such safety-critical applications.

TI products are neither designed nor intended for use in military/aerospace applications or environments unless the TI products are specifically designated by TI as military-grade or "enhanced plastic." Only products designated by TI as military-grade meet military specifications. Buyers acknowledge and agree that any such use of TI products which TI has not designated as military-grade is solely at the Buyer's risk, and that they are solely responsible for compliance with all legal and regulatory requirements in connection with such use.

TI products are neither designed nor intended for use in automotive applications or environments unless the specific TI products are designated by TI as compliant with ISO/TS 16949 requirements. Buyers acknowledge and agree that, if they use any non-designated products in automotive applications, TI will not be responsible for any failure to meet such requirements.

Following are URLs where you can obtain information on other Texas Instruments products and application solutions:

Products

Audio	www.ti.com/audio
Amplifiers	amplifier.ti.com
Data Converters	dataconverter.ti.com
DLP® Products	www.dlp.com
DSP	dsp.ti.com
Clocks and Timers	www.ti.com/clocks
Interface	interface.ti.com
Logic	logic.ti.com
Power Mgmt	power.ti.com
Microcontrollers	microcontroller.ti.com
RFID	www.ti-rfid.com
RF/IF and ZigBee® Solutions	www.ti.com/lprf

Applications

Communications and Telecom	www.ti.com/communications
Computers and Peripherals	www.ti.com/computers
Consumer Electronics	www.ti.com/consumer-apps
Energy and Lighting	www.ti.com/energy
Industrial	www.ti.com/industrial
Medical	www.ti.com/medical
Security	www.ti.com/security
Space, Avionics and Defense	www.ti.com/space-avionics-defense
Transportation and Automotive	www.ti.com/automotive
Video and Imaging	www.ti.com/video
Wireless	www.ti.com/wireless-apps

TI E2E Community Home Page

e2e.ti.com

Mailing Address: Texas Instruments, Post Office Box 655303, Dallas, Texas 75265
Copyright © 2011, Texas Instruments Incorporated