

# Using the UCC28740EVM-525 10 W Constant-Voltage, Constant-Current Charger Adaptor Module

## User's Guide



Literature Number: SLUUAL8  
July, 2013

Using the UCC28740EVM-525 10 W Constant-Voltage, Constant-Current Charger Adapter Module

*PSS- High Performance Isolated*

## Contents

<b>1</b>	<b>Introduction</b> .....	<b>4</b>
<b>2</b>	<b>Description</b> .....	<b>4</b>
	2.1 Typical Applications .....	4
	2.2 Features .....	5
<b>3</b>	<b>Electrical Performance Specifications</b> .....	<b>6</b>
<b>4</b>	<b>Schematic</b> .....	<b>7</b>
<b>5</b>	<b>Test Setup</b> .....	<b>8</b>
	5.1 Test Equipment .....	8
	5.2 Recommended Test Setup .....	9
	5.3 List of Test Points .....	10
	5.4 Applying Power to the EVM .....	11
	5.5 No-Load Power Consumption .....	11
	5.6 Line/Load Regulation and Efficiency Measurement Procedure .....	11
	5.7 Output Voltage Ripple .....	12
	5.8 Equipment Shutdown .....	12
<b>6</b>	<b>Performance Data and Typical Characteristic Curves</b> .....	<b>13</b>
	6.1 Efficiency .....	13
	6.2 Load Regulation .....	14
	6.3 Line Regulation .....	15
	6.4 No-Load Power Consumption .....	15
	6.5 Output Voltage vs Output Current .....	16
	6.6 Control Law .....	17
	6.7 Bode Plot .....	18
	6.8 Transient Response .....	19
	6.9 Output Ripple .....	20
	6.10 Turn On Waveform .....	21
	6.11 Switching Waveform .....	22
	6.12 EMI Dithering Waveform .....	23
<b>7</b>	<b>EVM Assembly Drawing and PCB layout</b> .....	<b>23</b>
<b>8</b>	<b>Bill of Materials</b> .....	<b>28</b>

## Figures

<b>Figure 1.</b>	<b>UCC28740EVM-525 Schematic</b> .....	<b>7</b>
<b>Figure 2.</b>	<b>UCC28740EVM-525 Recommended Test Set Up For No-Load Operation</b> .....	<b>9</b>
<b>Figure 3.</b>	<b>UCC28740EVM-525 Recommended Test Set Up With Load</b> .....	<b>10</b>
<b>Figure 4.</b>	<b>UCC28740EVM-525 Average Efficiency</b> .....	<b>13</b>
<b>Figure 5.</b>	<b>UCC28740EVM-525 Load Regulation</b> .....	<b>14</b>
<b>Figure 6.</b>	<b>UCC28740EVM-525 Line Regulation</b> .....	<b>15</b>
<b>Figure 7.</b>	<b>UCC28740EVM-525 No-Load Power Consumption</b> .....	<b>15</b>
<b>Figure 8.</b>	<b>UCC28740EVM-525 Output Voltage as a Function of Load Current</b> .....	<b>16</b>
<b>Figure 9.</b>	<b>UCC28740EVM-525 Control Law Showing Switching Frequency as a Function of Load Current</b> .....	<b>17</b>
<b>Figure 10.</b>	<b>UCC28740EVM-525 Loop Response Gain and Phase</b> .....	<b>18</b>

<b>Figure 11.</b>	<b>UCC28740EVM-525 Load Transient .....</b>	<b>19</b>
<b>Figure 12.</b>	<b>Output Ripple .....</b>	<b>20</b>
<b>Figure 13.</b>	<b>Output voltage Turn On Waveform .....</b>	<b>21</b>
<b>Figure 14.</b>	<b>Switching Waveform.....</b>	<b>22</b>
<b>Figure 15.</b>	<b>EMI Dithering Waveform .....</b>	<b>23</b>
<b>Figure 16.</b>	<b>UCC28740EVM-525 Top Layer Assembly Drawing (Top view) .....</b>	<b>24</b>
<b>Figure 17.</b>	<b>UCC28740EVM-525 Bottom Layer Assembly Drawing (Bottom view) .....</b>	<b>25</b>
<b>Figure 18.</b>	<b>UCC28740EVM-525 Top Copper (Top View).....</b>	<b>26</b>
<b>Figure 19.</b>	<b>UCC28740EVM-525 Bottom Copper (Bottom View).....</b>	<b>27</b>

**Tables**

<b>Table 1.</b>	<b>UCC28740EVM-525 EVM-001 Electrical Performance Specifications .....</b>	<b>6</b>
<b>Table 2.</b>	<b>Test Point Functional Description.....</b>	<b>10</b>
<b>Table 3.</b>	<b>The EVM components list according to the schematic shown in Figure 1 .....</b>	<b>28</b>

## 1 Introduction

The UCC28740EVM-525 evaluation module is a 10 Watt off-line discontinuous mode (DCM) flyback converter that provides constant-voltage (CV) and constant-current (CC) output regulation by using an optical coupler for tight voltage regulation and improved the transient response to large load steps and primary side control for accurate constant current regulation. The target application for this converter design is USB adapters for consumer electronics. The UCC28740 uses frequency modulation, peak primary current modulation, valley switching and valley skipping in its control algorithm in order to maximize efficiency over the entire operating range.

## 2 Description

This evaluation module uses the *UCC28740 Constant-Voltage, Constant-Current Flyback Controller Using Opto-Coupled Feed-Back* in a 10 W converter to provide 2 A of constant charge current. The input accepts a voltage range of 85 VAC to 265 VAC. The output is designed for 5 V when in constant voltage mode and will deliver 2.1 A of constant charge down to an output voltage of less than 2 V. Depending upon the operating conditions, the control law algorithm will modulate the switching frequency or the peak primary current to satisfy the power transfer requirements. As the load is increased from zero, the converter will transition through a frequency modulation mode where the peak primary current is held constant at one-quarter of its full-load peak value as the switching frequency increases from a minimum value to maintain energy transfer up to 32 kHz. When the load is increased to the level at which the switching frequency reaches 32 kHz, the controller will keep the switching frequency fixed and modulate the peak primary current, increasing it from one-quarter its peak value up to its maximum full load peak current value; this area of operation is referred to as the amplitude modulation range. Further increase in load demand will transition the controller into another frequency modulation mode where the peak primary current is constant at its maximum designed value and the switching frequency is increased as needed, up to the controller's maximum 100 kHz switching frequency. Opto-coupled feed-back maintains a tightly regulated output with fast dynamic response to load transients. The controller will further enhance its efficient operation with valley switching. The UCC28740 also uses dithering of the gate drive helps to ease EMI compliance.

This user's guide provides the schematic, component list, assembly drawing, art work, and test set up necessary to evaluate the UCC28740 in a typical off-line converter application.

### 2.1 Typical Applications

The UCC28740 is suited for use in isolated off-line systems requiring high efficiency and fault protection features including:

- USB-Compliant Adapters and Chargers for Consumer Electronics such as smart phones, tablet computers, and cameras
- Stand-by Supply for TV and Desktop
- White Goods

## 2.2 Features

The UCC28740EVM-525 features include:

- AC Input Range 85 V<sub>AC</sub> to 265 V<sub>AC</sub>
- DC Output of 5 V, 2.1 A
- No-Load Power Consumption less than 20 mW
- Opto-Coupled Feedback for Constant Voltage Regulation and Fast Dynamic Response
- Primary Side Control for Tight Constant Current Performance
- ± 3% Output Voltage Regulation
- ± 5% Output Current Regulation
- Average Efficiency > 80%
- Output Over Current and Short Circuit Protection
- Output Over Voltage Protection
- Input Brown-Out Protection
- Auto Re-Start on Fault
- Quasi-Resonant Valley Switching
- Frequency Dither
- Internal 700V Start-Up Switch to Start up the Supply Directly From the Bulk Rail

### **Caution**

High voltage levels are present on the evaluation module whenever it is energized. Proper precautions must be taken when working with the EVM. The large bulk capacitors, C3 and C4, and the output capacitors, C8 and C10, must be completely discharged before the EVM can be handled. Serious injury can occur if proper safety precautions are not followed.

### 3 Electrical Performance Specifications

**Table 1. UCC28740EVM-525 EVM-001 Electrical Performance Specifications**

PARAMETER	TEST CONDITIONS	MIN	NOM	MAX	UNITS
<b>Input Characteristics</b>					
Voltage range, $V_{IN}$		85	115/230	265	$V_{RMS}$
Maximum input current	$V_{IN} = V_{INmin}, I_{OUT} = I_{OUTmax}$		0.265		$A_{RMS}$
Line frequency		47	60/50	63	Hz
No-load power consumption	$V_{INmin} \leq V_{IN} \leq V_{INmax}, I_{OUT} = 0A$			20	mW
<b>Output Characteristics</b>					
Output voltage, $V_{OUT}$	$V_{INmin} \leq V_{IN} \leq V_{INmax}, 0A \leq I_{OUT} \leq I_{OUTmax}$	4.85	5	5.15	V
Output load current, CV mode, $I_{OUTmax}$	$V_{INmin} \leq V_{IN} \leq V_{INmax}$	1.995	2.1	2.205	A
Output voltage regulation	Line Regulation: $V_{INmin} \leq V_{IN} \leq V_{INmax}, I_{OUT} = I_{OUTmax}$		0.1		%
	Load Regulation: $0A \leq I_{OUT} \leq I_{OUTmax}$		0.1		%
Output voltage ripple	$V_{INmin} \leq V_{IN} \leq V_{INmax}, 0A \leq I_{OUT} \leq I_{OUTmax}$			150	mVpp
Output over current, $I_{OCC}$	$V_{INmin} \leq V_{IN} \leq V_{INmax}$			2.5	A
Minimum output voltage, CC mode	$V_{INmin} \leq V_{IN} \leq V_{INmax}, I_{OUT} = I_{OCC}$		1.78	2	V
Brown-out protection	$I_{OUT} = I_{OUTmax}$		68		$V_{RMS}$
Transient response undershoot	$I_{OUT} = I_{OUTmax}$ to 0A load transient	4.3			V
Transient response time	$I_{OUT} = I_{OUTmax}$ to 0A load transient			20	ms
<b>Systems Characteristics</b>					
Switching frequency, $f_{SW}$		1.2		71	kHz
Average efficiency	25%, 50%, 75%, 100% load average at nominal input voltages		81		%
Operating temperature			25		°C



## 5 Test Setup

Figure 2 shows the equipment set up when measuring the input power consumption during no-load operation. Note the addition of the 10  $\Omega$  shunt resistor in Figure 2. During the no-load test, the power analyzer should be set for long averaging mode in order to include several cycles of operation and an appropriate current scale factor for using the external shunt must be used. Figure 3 shows the recommended test equipment set up to evaluate the UCC28740EVM-525 with a load.

### **Warning**

High voltages that may cause injury exist on this evaluation module (EVM). Please ensure all safety procedures are followed when working on this EVM. Never leave a powered EVM unattended.

### 5.1 Test Equipment

**AC Voltage Source:** The input source shall be an isolated variable AC source capable of supplying between 85  $V_{AC}$  and 265  $V_{AC}$  at no less than 20 W and connected as shown in Figures 2 and 3. For accurate efficiency calculations, a power meter should be inserted between the neutral line of the AC source and the Neutral terminal of the EVM. For highest accuracy, connect the voltage terminals of the power meter directly across the Line and Neutral terminals of the EVM.

**Output Load:** A programmable electronic load capable of sinking 0 A to 3 A shall be used. For constant current mode testing of the EVM, the electronic load should be set to constant resistance mode.

**Power Meter:** A power analyzer shall be capable of measuring low input current, typically less than 10mA, and a long averaging mode, if low power standby mode input power measurements are to be taken. An example of such an analyzer is the Voltech PM100 Single Phase Power Analyzer. An external 10  $\Omega$  shunt, with a current scale factor of 10 A/V, was used at a high sample rate over an extended period of time in order to display the averaged results (refer to Figure 2).

**Multimeters:** For highest accuracy,  $V_{OUT}$  can be monitored by connecting a DC voltmeter, DMM  $V_1$ , directly across the +VOUT and -VOUT terminals as shown in Figure 2 and Figure 3. A DC current meter, DMM  $A_1$ , should be placed in series with the electronic load for accurate output current measurements.

**Oscilloscope:** A digital or analog oscilloscope with 500 MHz scope probes is recommended.

**Fan:** Forced air cooling is not required.

**Recommended Wire Gauge:** a minimum of AWG 18 wire is recommended. The wire connections between the AC source and the EVM, and the wire connections between the EVM and the load should be less than two feet long.



## 5.2 Recommended Test Setup

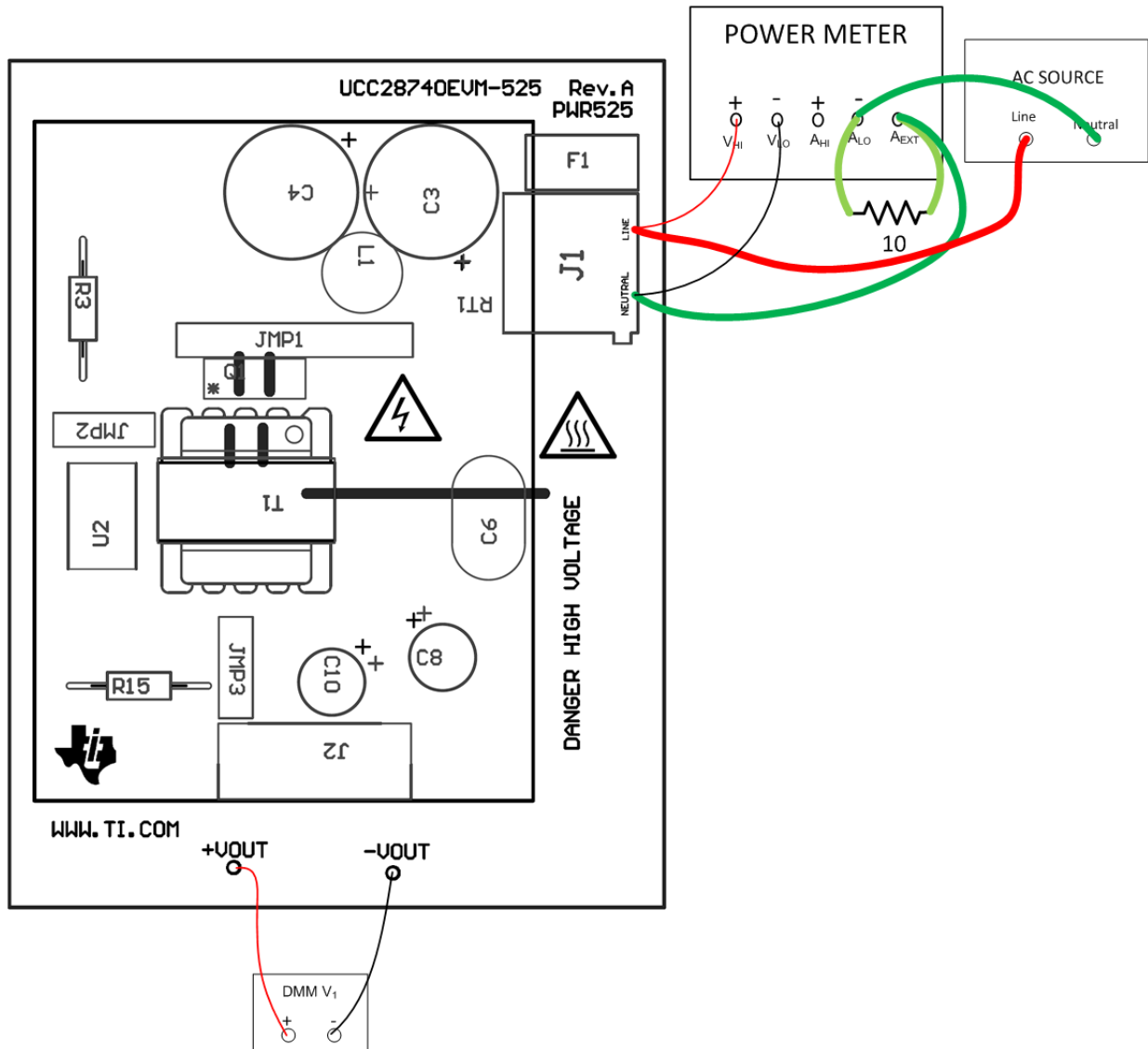

Figure 2. UCC28740EVM-525 Recommended Test Set Up For No-Load Operation

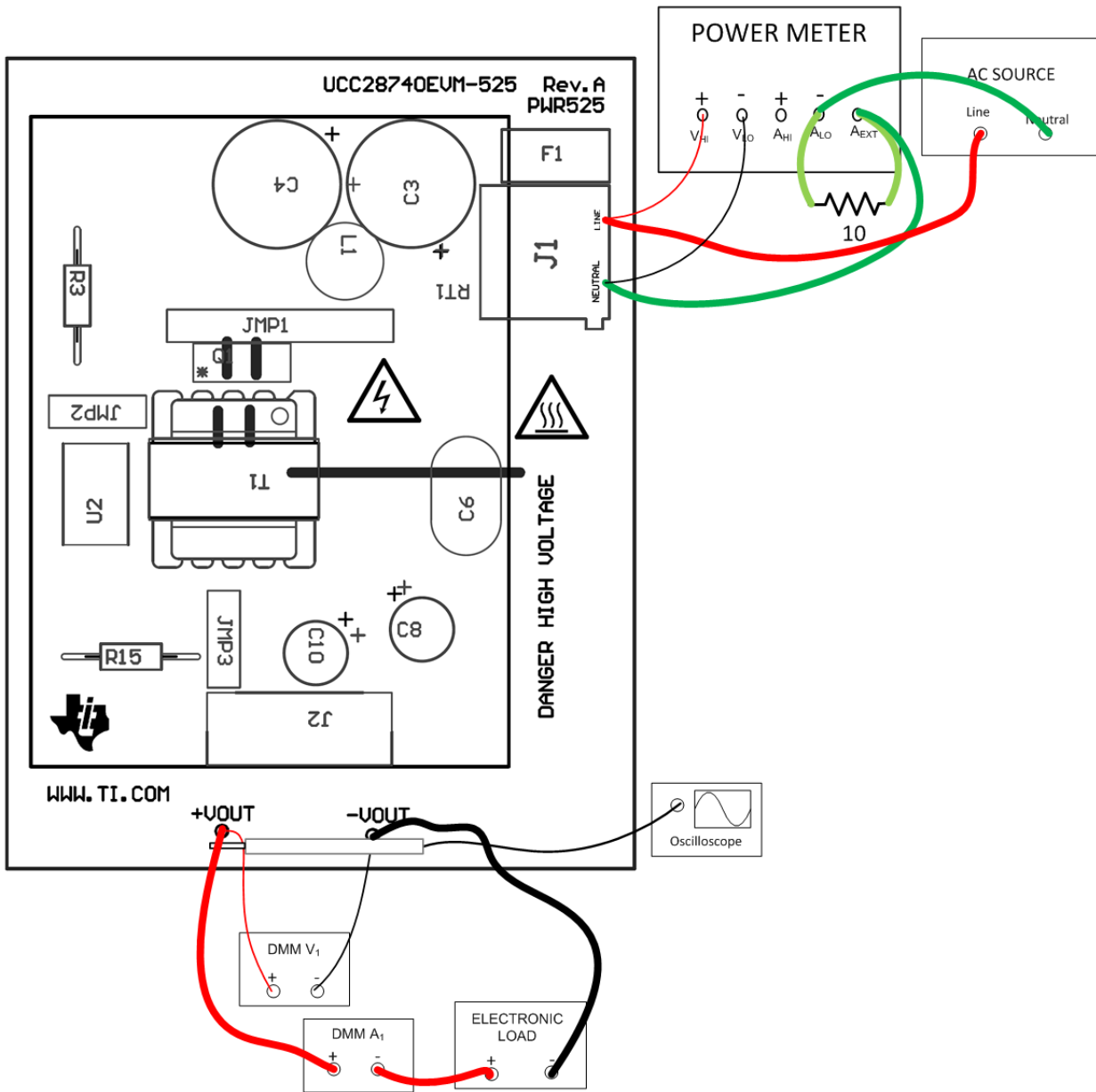

Figure 3. UCC28740EVM-525 Recommended Test Set Up With Load

### 5.3 List of Test Points

Table 2. Test Point Functional Description

TEST POINT	NAME	DESCRIPTION
TP1	PGND	Primary side power ground
TP2	+LOOP	Loop injection point, EVM output
TP3	-LOOP	Loop injection point

TEST POINT	NAME	DESCRIPTION
TP4	SGND	Secondary side ground
TP5	+VOUT	Positive output terminal of the EVM to the load
TP6	-VOUT	Return connection of the EVM output to the load

## 5.4 Applying Power to the EVM

1. Set up the EVM as shown in Figure 2 if testing at no-load, or Figure 3 if testing with a load.
2. If testing with a load, set the electronic load to constant resistance mode.
3. Set the AC source voltage between  $85 V_{AC}$  and  $265 V_{AC}$ .
4. Monitor the output voltage on DMM  $V_1$ .
5. Monitor the output current on DMM  $A_1$ .

## 5.5 No-Load Power Consumption

1. Use the test set up shown in Figure 2.
  - a. Set the power analyzer to external shunt mode.
  - b. Set the appropriate current scale factor for using an external shunt on the power analyzer. A  $10 \Omega$  shunt scales to  $10,000 \text{ mV/A}$  for the PM100 Voltech.
  - c. Set the power analyzer for long averaging time to include several cycles of operation. The PM100 Voltech used for this test data was set to a long averaging time of 30 for accurate power consumption measurement.
2. Apply power to the EVM per section 5.4.
3. Monitor the input power on the power analyzer while varying thinput voltage.
4. Make sure the EVM is off and the bulk capacitors and output capacitors are completely discharged before handling the EVM.

## 5.6 Line/Load Regulation and Efficiency Measurement Procedure

1. For load regulation, use the test set up shown in Figure 3.
  - a. Be sure to remove the exteranal  $10 \Omega$  shunt from the power analyzer and set the analyzer to normal mode (not long averaging).
  - b. Set the AC source to a constant voltage between  $85 V_{AC}$  and  $265 V_{AC}$ .
  - c. Vary the load so that the output current varies from 0 A up to 2.1 A, as measured on DMM  $A_1$ .
  - d. Observe that the output voltage on DMM  $V_1$  remains within 3% of the 5 V constant voltage regulation value.

- e. Observe that if the constant resistance level of the electronic load is decreased lower than the full load value, the EVM will maintain constant current regulation within 5% of the programmed value until the output voltage drops below 2 V. The EVM will automatically restart once the constant resistance load is increased.
2. For line regulation, use the test set up shown in Figure 3
    - a. Set the constant resistance load to sink the full load current, approximately 2.38  $\Omega$ .
    - b. Vary the AC source from 85 V<sub>AC</sub> to 265 V<sub>AC</sub>
    - c. Observe that the output voltage on DMM V<sub>1</sub> stays within 3% of the 5 V constant voltage regulation value.

### 5.7 Output Voltage Ripple

1. Expose the ground barrel of the scope probe and place the tip of the probe on TP5, +VOUT, and rest the exposed ground barrel of the probe on TP6, -VOUT, for output voltage ripple measurements.

### 5.8 Equipment Shutdown

1. To quickly discharge the output capacitors, make sure there is a load greater than 0 A on the EVM.
2. Turn off the AC source.

## 6 Performance Data and Typical Characteristic Curves

Figure 4 through 11 present typical performance curves for UCC28740EVM-525.

### 6.1 Efficiency

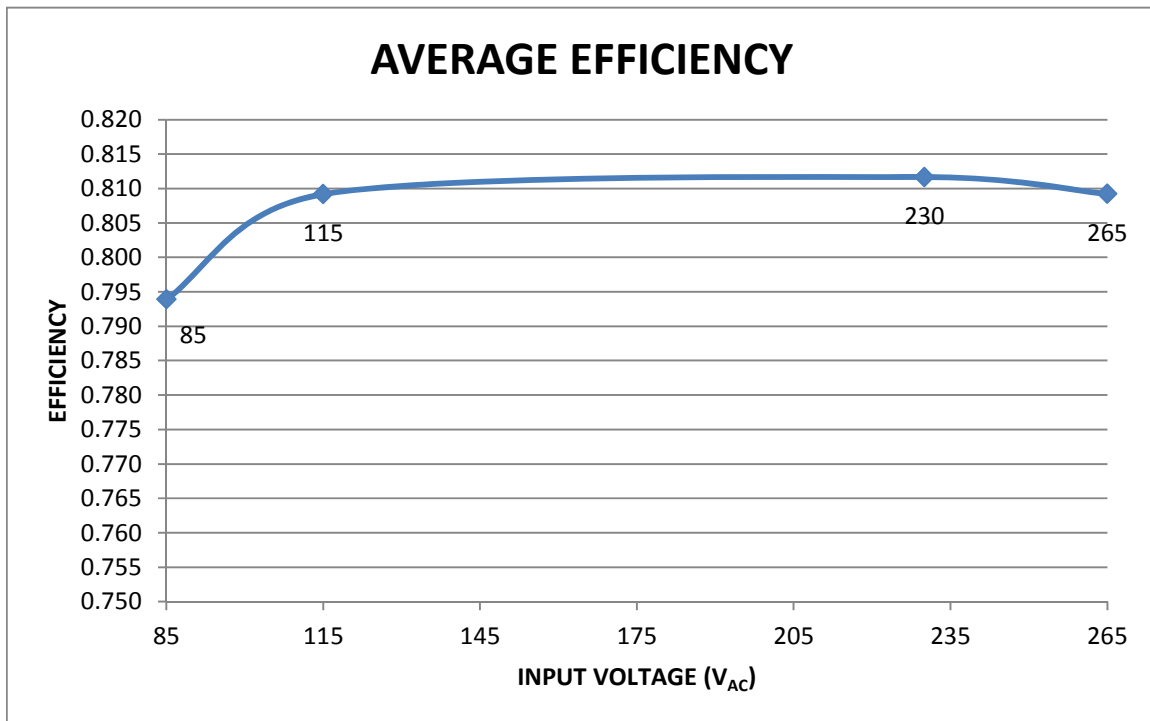

**Figure 4. UCC28740EVM-525 Average Efficiency**

The average efficiency at 115 VAC, 60 Hz nominal input and 230 VAC, 50 Hz nominal input exceeds the 0.80 design goal. Further increases in efficiency could be achieved with a transformer made with a custom core and designed to operate at lower switching frequency over the entire operating range.

**6.2 Load Regulation**

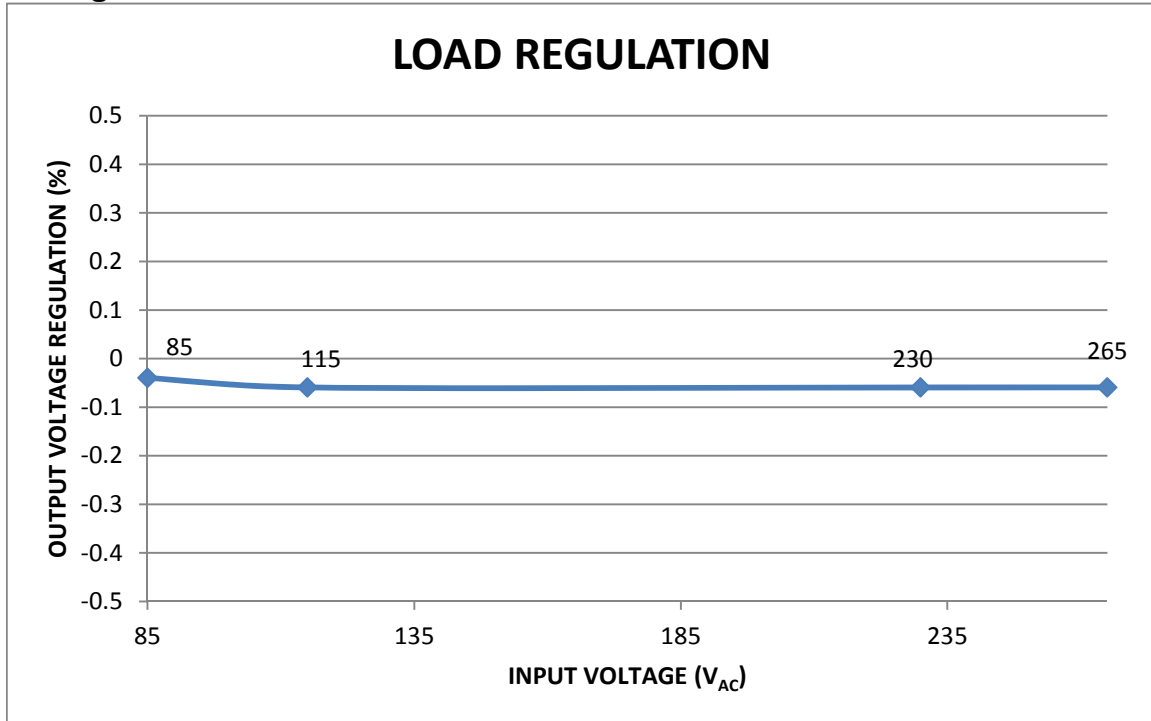

**Figure 5. UCC28740EVM-525 Load Regulation**

Figure 5 shows the actual measured load regulation exceeded the 3% design goal.

### 6.3 Line Regulation

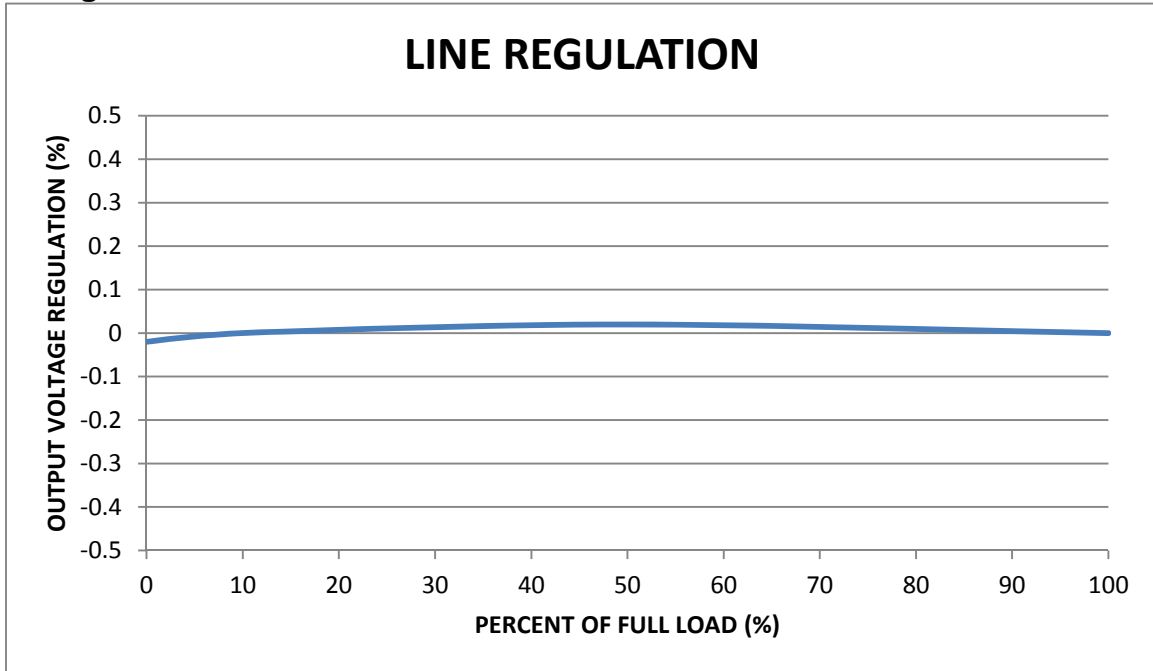

Figure 6. UCC28740EVM-525 Line Regulation

Figure 6 shows the actual measured line regulation exceeded the 3% design goal.

### 6.4 No-Load Power Consumption

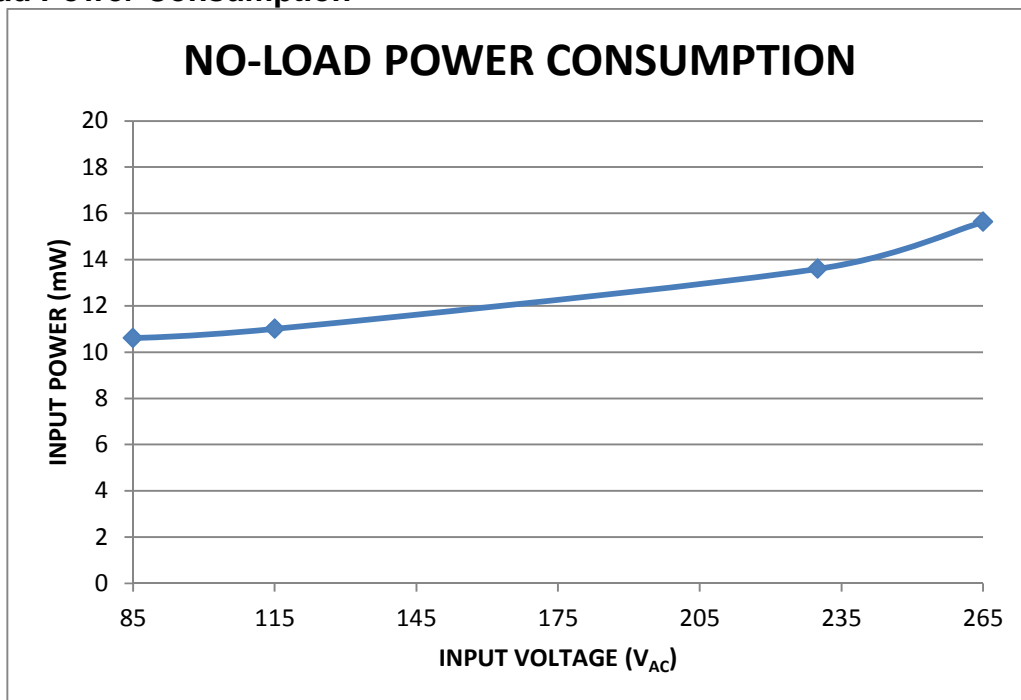
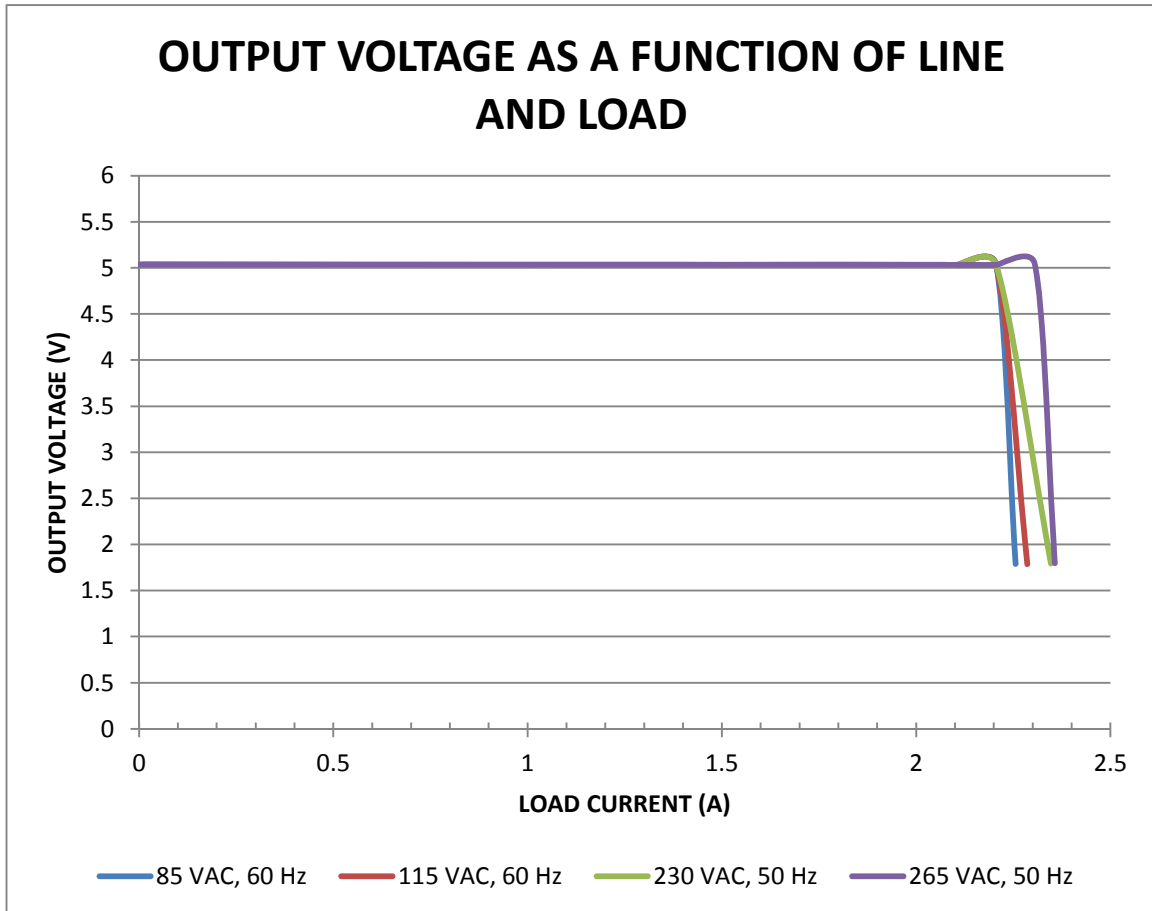

Figure 7. UCC28740EVM-525 No-Load Power Consumption

No load power consumption measured less than 20 mW over the entire line input range.

### 6.5 Output Voltage vs Output Current



**Figure 8. UCC28740EVM-525 Output Voltage as a Function of Load Current**

In Figure 8, the converter is in constant-voltage operating mode from 0 A load up to approximately 2.2 A. Once reaching this output over-current threshold, the converter transitions into constant-current mode where the load current remains constant until the output voltage falls below 2 V, at which point the converter shuts down. If the load demand is decreased to the constant current operating region, the converter will automatically re-start.



6.6 Control Law

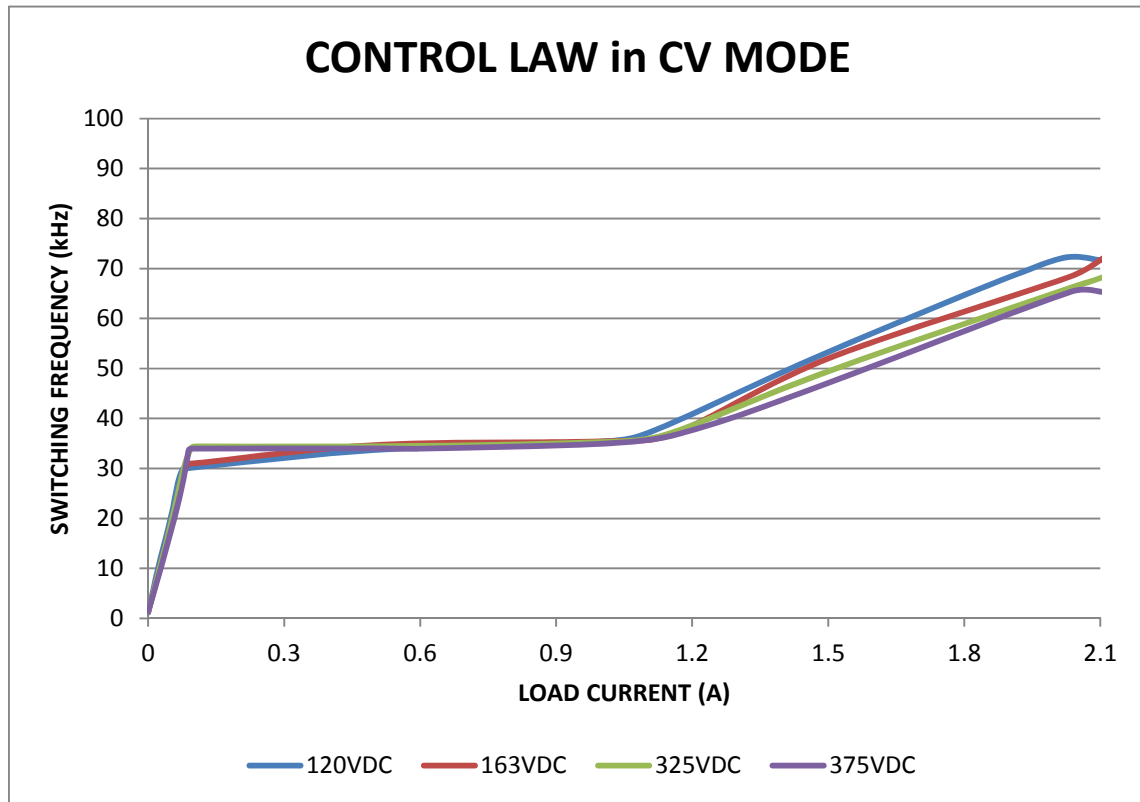
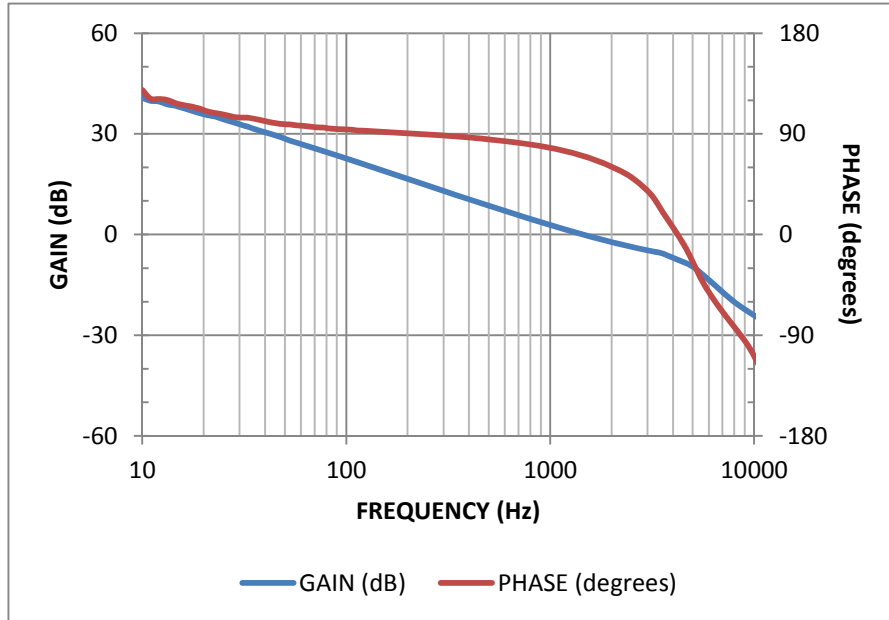

Figure 9. UCC28740EVM-525 Control Law Showing Switching Frequency as a Function of Load Current

As the load increases, the UCC28740 will transition from a frequency modulation mode at light load, where the peak primary current is fixed at  $\frac{1}{4}$  of its maximum programmed value, into a 32 kHz fixed frequency, peak current amplitude modulation mode. Further increase in load will force a transition into another frequency modulation mode where the peak primary side current is fixed at its peak programmed value and the frequency will increase from 32 kHz up to the maximum frequency required for energy transfer. The maximum designed switching frequency for this module is 71 kHz. For ease in measuring the switching frequency, the data was taken with a DC input voltage. This reduced the frequency dithering to only the controller's EMI dithering scheme and limited the valley skipping that would have been a result of the line frequency modulating the AC input.

**6.7 Bode Plot**



**Figure 10. UCC28740EVM-525 Loop Response Gain and Phase**

The gain, phase plot was measured with an AP Instruments Inc. Model 200 analog network analyzer. The loop result was obtained by inserting a 200mV AC signal across TP2 and TP3. The crossover frequency, with a 115 V<sub>AC</sub>, 60 Hz input and load current of 2 A, measured 1.38 kHz with a phase margin of 71 degrees.

6.8 Transient Response

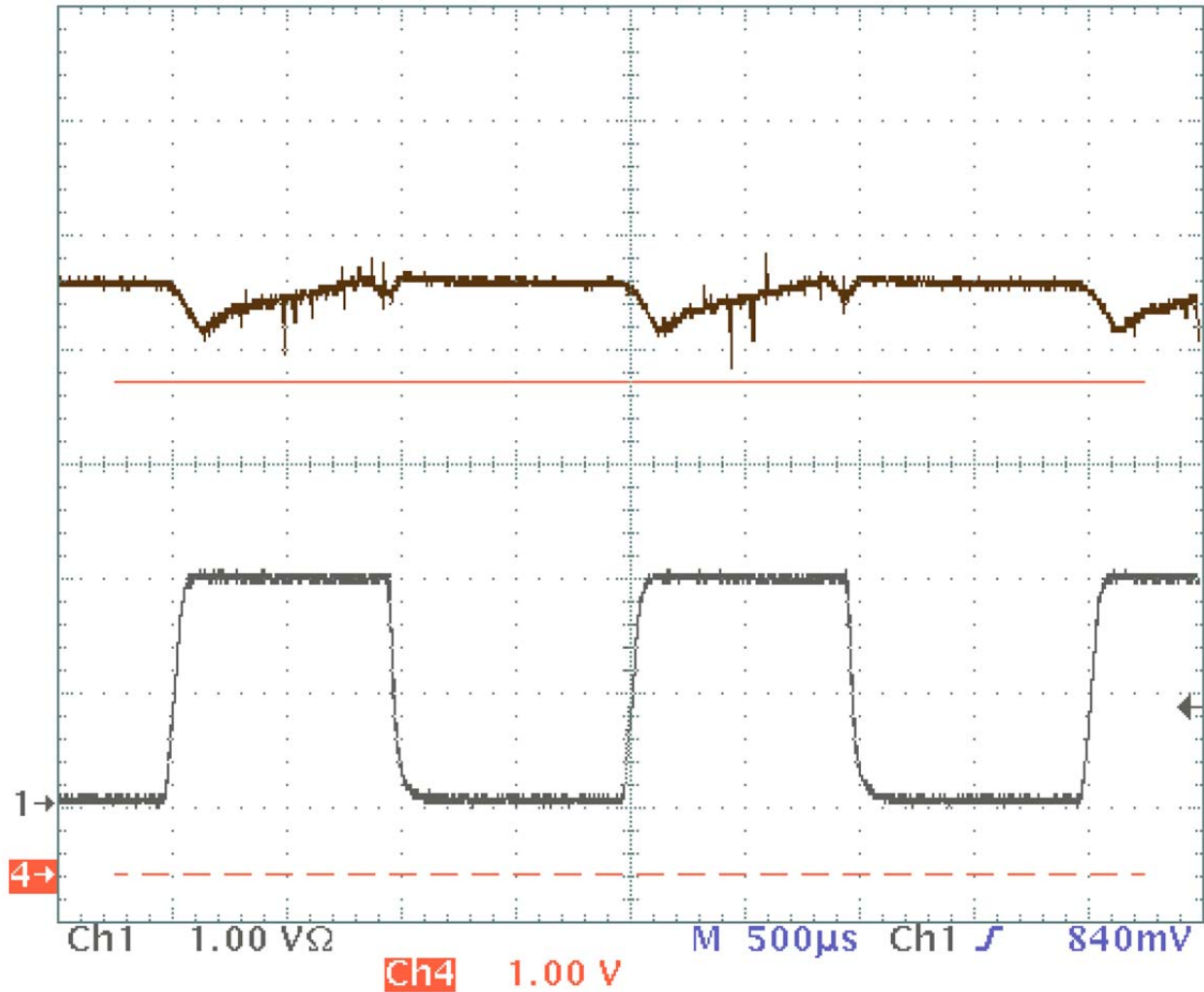
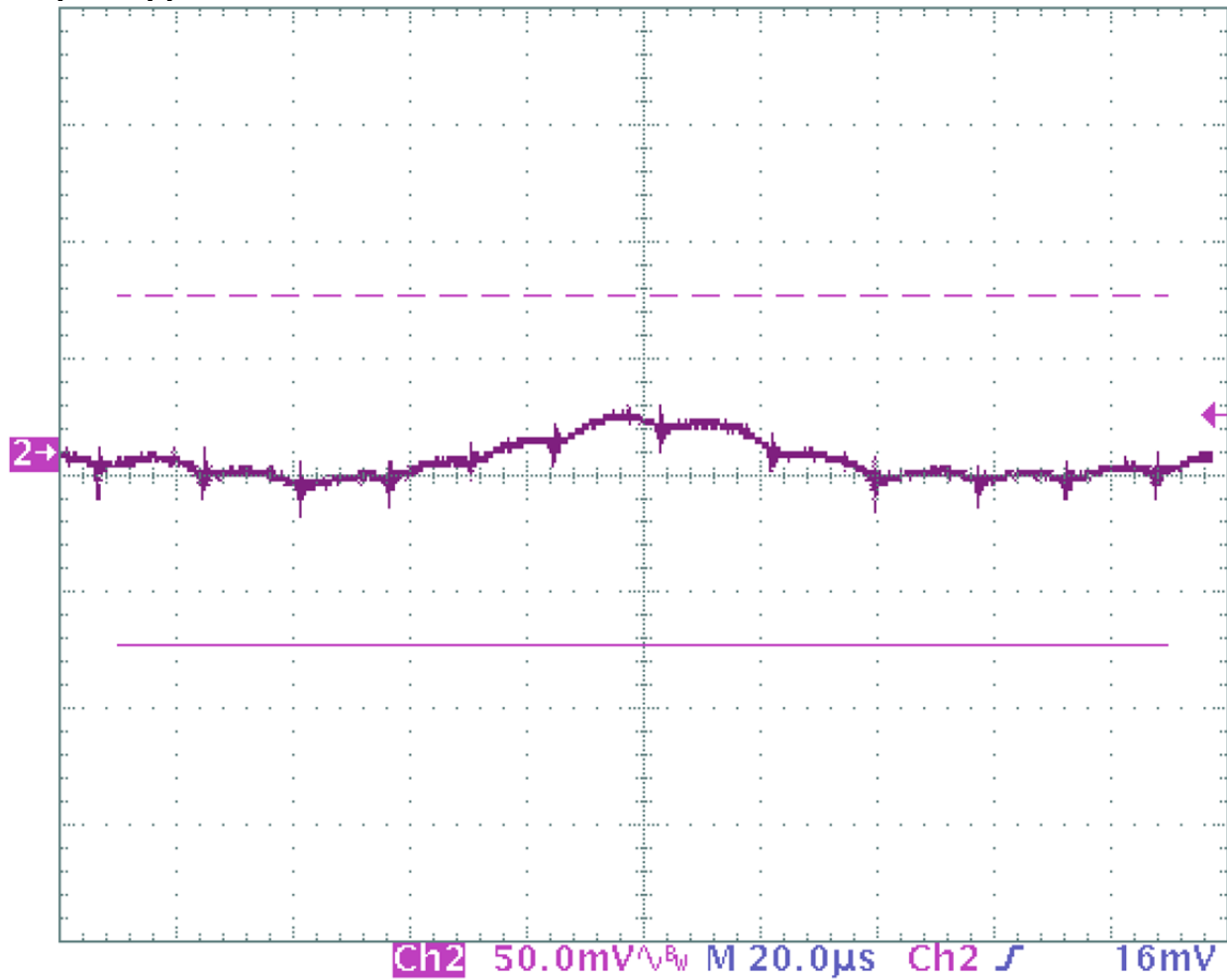

Figure 11. UCC28740EVM-525 Load Transient

The transient response shown in Figure 11 was taken with a 115 VAC, 60 Hz input voltage and a load transition from 0 A to full load. Channel 1 is the load current on a scale of 1 A per division, channel 4 is the output voltage on a scale of 1 V per division. The cursor shows the minimum acceptable voltage limit, 4.30 V, under transient conditions. Also note that the output waveform was taken with the probe on TP5 with the ground referenced to TP4 but not using the tip and barrel technique accounting for the high frequency noise seen on the waveform.

## 6.9 Output Ripple



**Figure 12. Output Ripple**

Figure 12 shows the output voltage ripple, measured using tip and barrel across TP5 and TP6 on the EVM. The measurement was taken at full load with an input voltage of 85 VAC, 60 Hz and the waveform is AC coupled. The cursor shows the maximum peak to peak limit permitted for the design.

**6.10 Turn On Waveform**

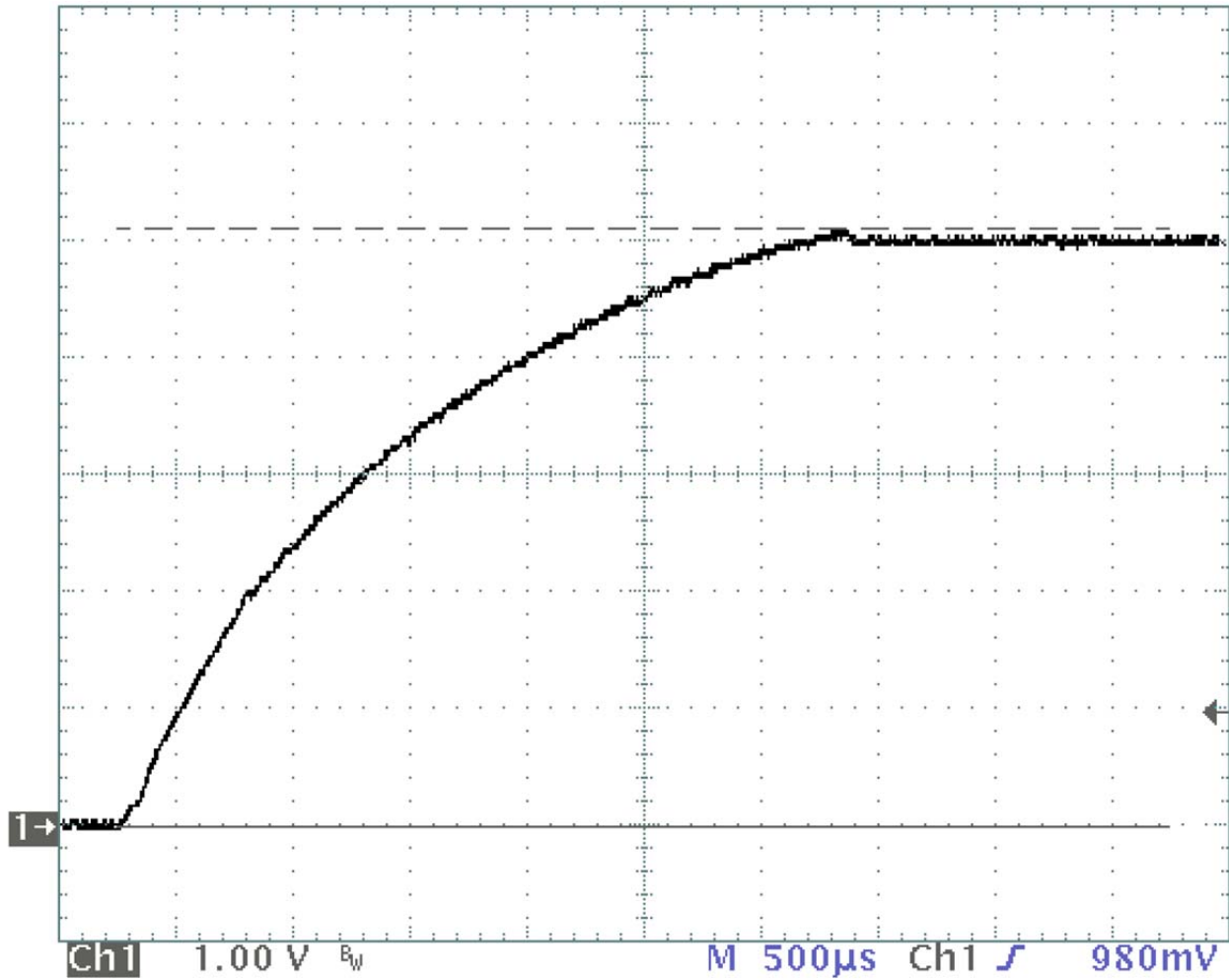

**Figure 13. Output voltage Turn On Waveform**

Figure 13 shows the output voltage at turn on under full load conditions with an input voltage of 115 V<sub>AC</sub>, 60 Hz. The maximum voltage at the output was measured to be 5.12 V<sub>DC</sub>.

### 6.11 Switching Waveform

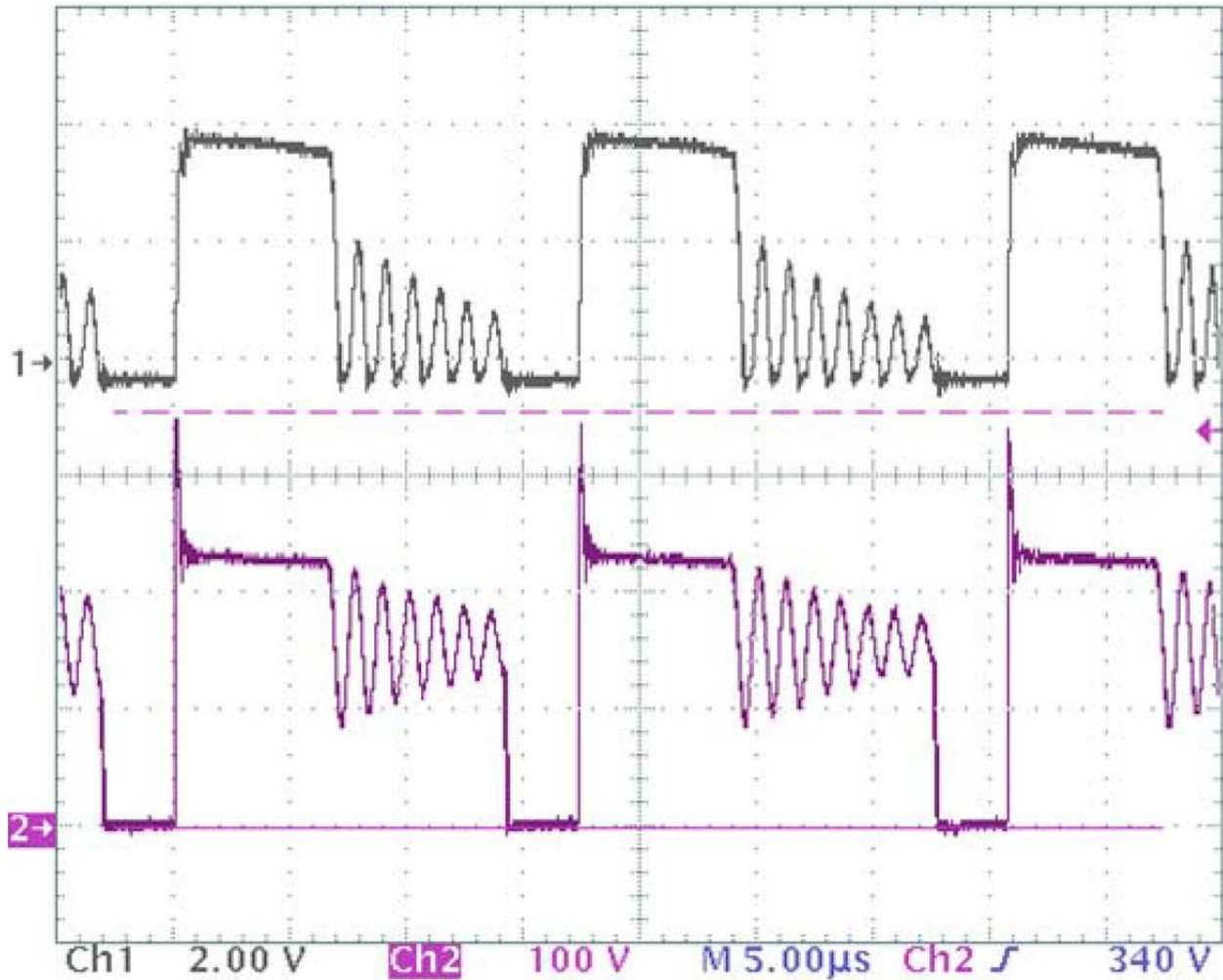

**Figure 14. Switching Waveform**

The typical switching waveform can be seen in Figure 14. Channel 1 shows the VS pin at 2 V per division and channel 2 shows the MOSFET drain to source voltage at 100 V per division. The scan was taken at 1.8 A load, 115 V<sub>AC</sub>, 60 Hz input voltage. At this operating point, the switching frequency is dithering between 58.8 kHz and 52.6 kHz due to valley skipping.

## 6.12 EMI Dithering Waveform

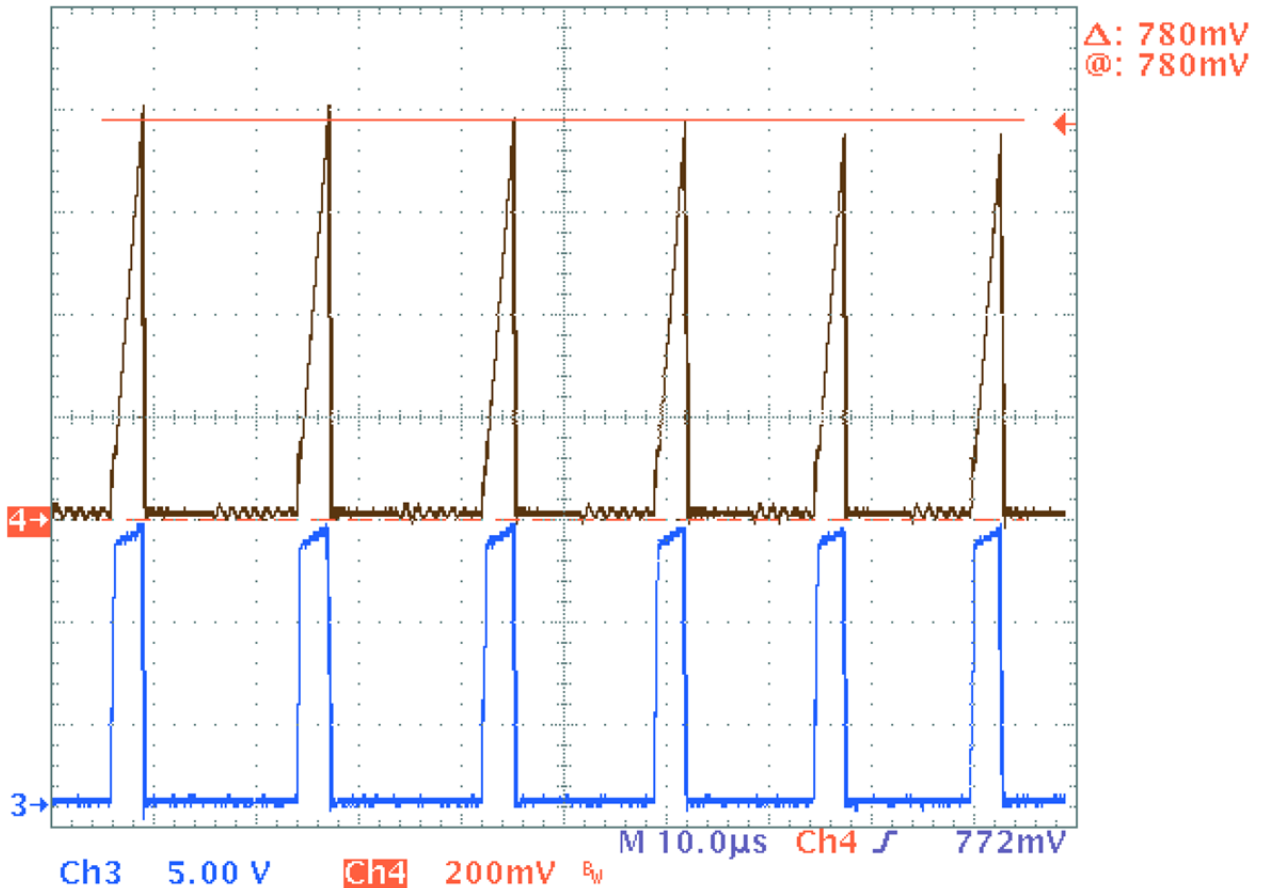

**Figure 15. EMI Dithering Waveform**

The UCC28740 controller employs a unique control mechanism to help with EMI compliance. As shown in Figure 15, the DRV pin, shown as channel 3, drives the gate of the MOSFET with a sequence of pulses in which there will be two longer pulses, two medium pulses, and two shorter pulses at any operating point starting with the amplitude modulation mode. The EMI dithering is not enabled at light load. Figure 15 shows the result of these varying pulse widths on the CS signal, shown on channel 4. The longer pulses result in a peak current threshold of 808 mV, the medium length pulses are shown measured at 780 mV, and the shorter pulses measure a threshold voltage of 752 mV. This dithering adds to the frequency jitter caused by valley skipping and results in a spread spectrum for better EMI compliance.

## 7 EVM Assembly Drawing and PCB layout

The following figures (Figure 16 through Figure 19) show the design of the UCC28740EVM-525 printed circuit board. The final dimensions of the single copper layer circuit measure 50.93 mm by 37.36 mm and the height is dominated by the USB connector at 18.4 mm.

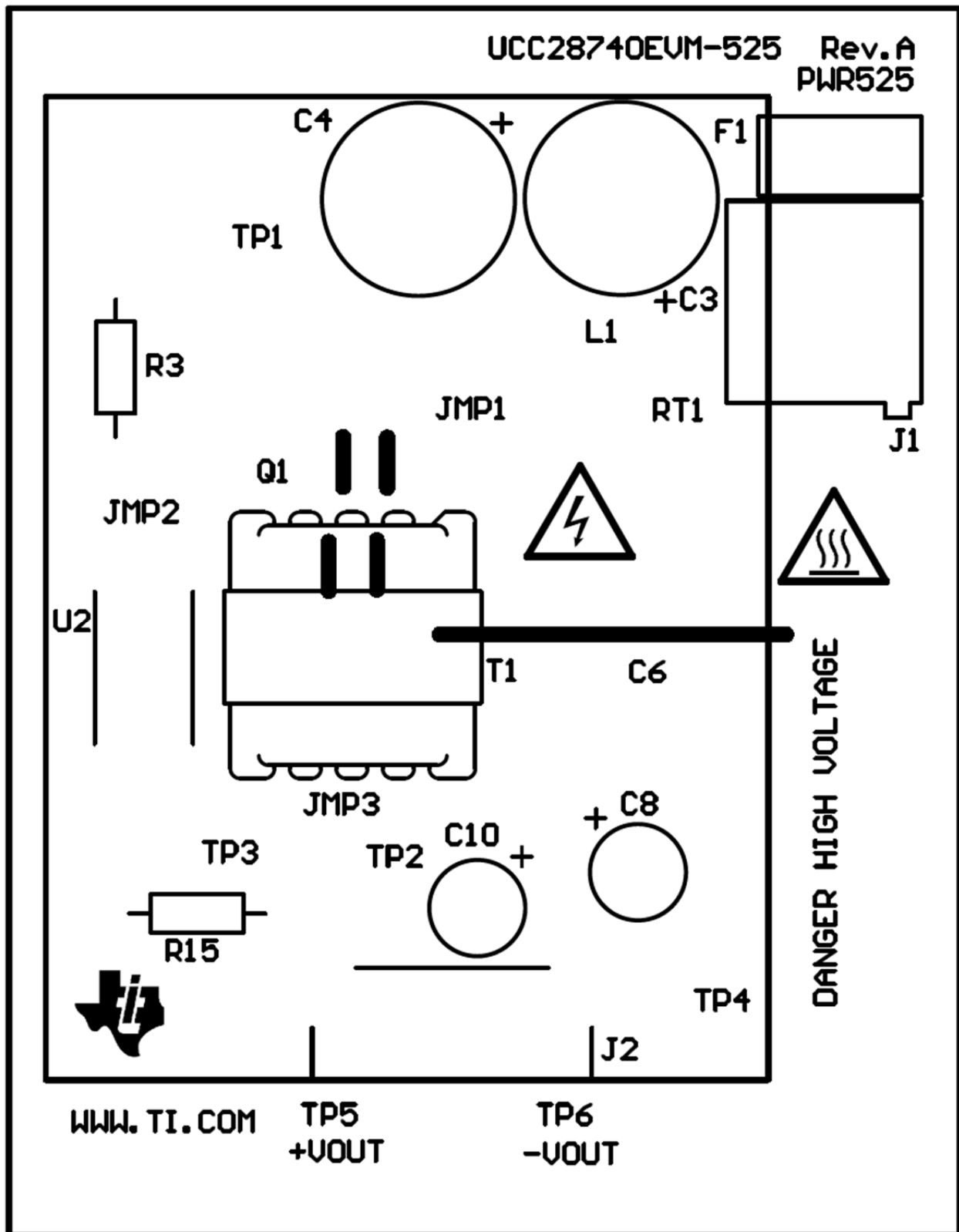

Figure 16. UCC28740EVM-525 Top Layer Assembly Drawing (Top view)



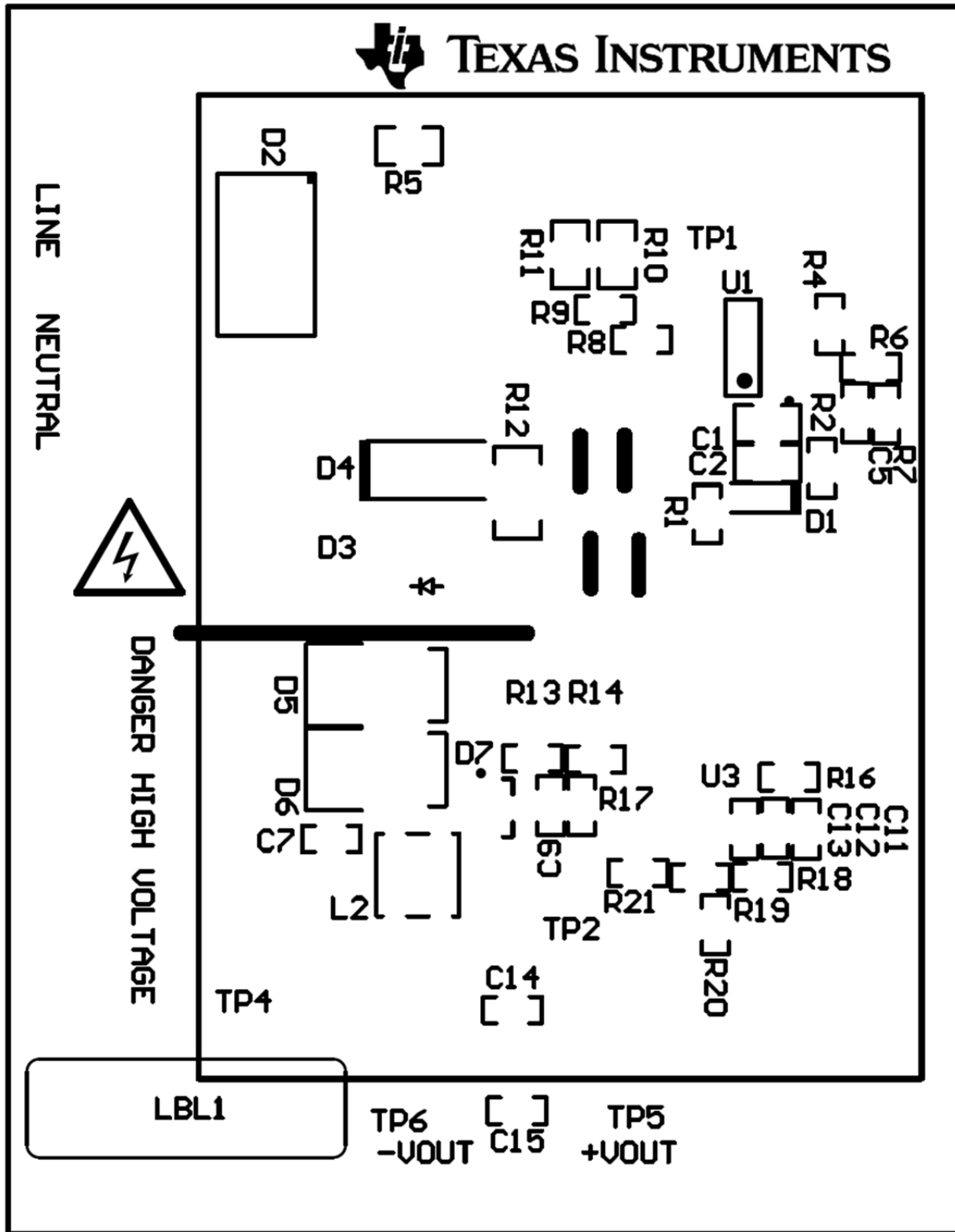

Figure 17. UCC28740EVM-525 Bottom Layer Assembly Drawing (Bottom view)

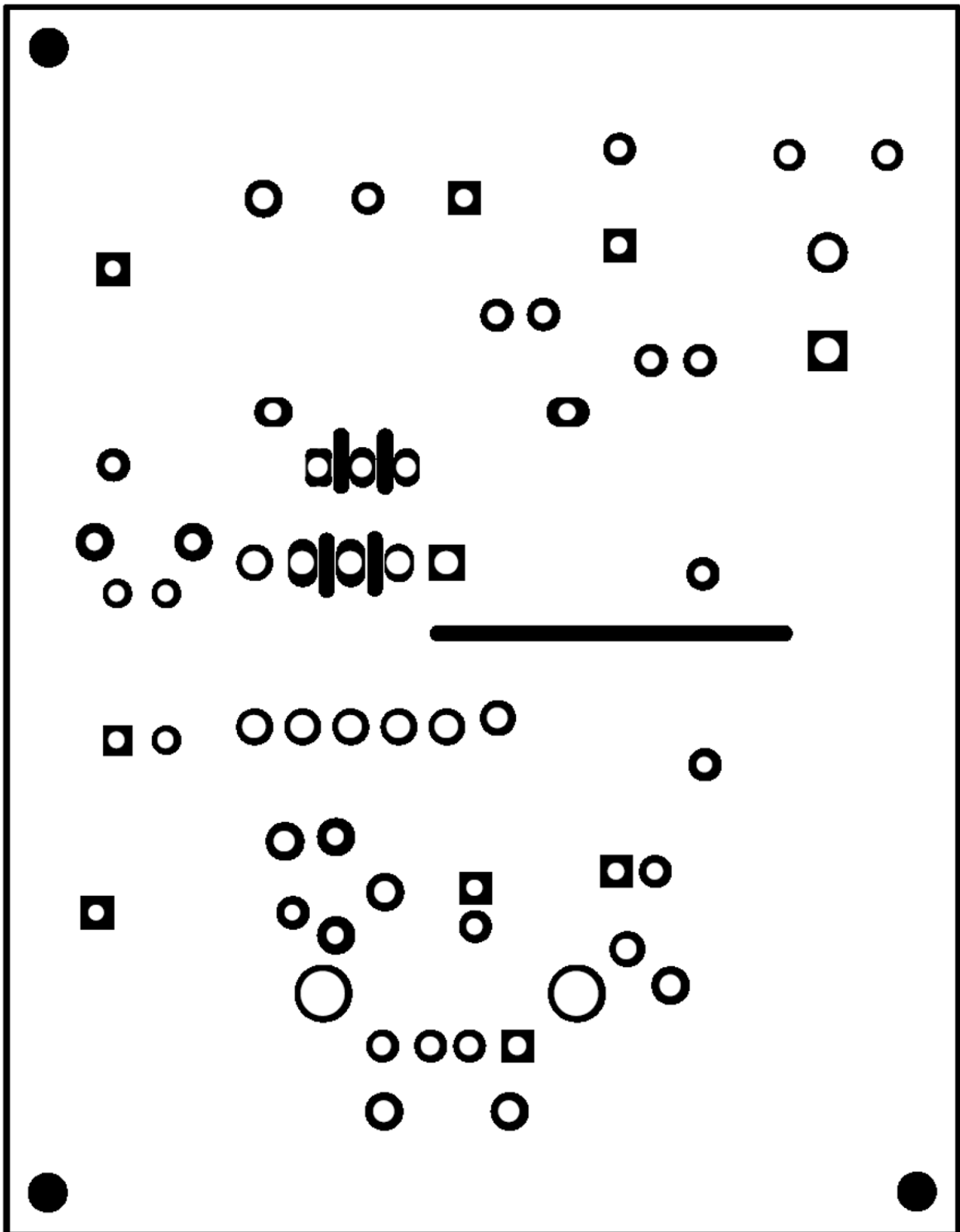

Figure 18. UCC28740EVM-525 Top Copper (Top View)

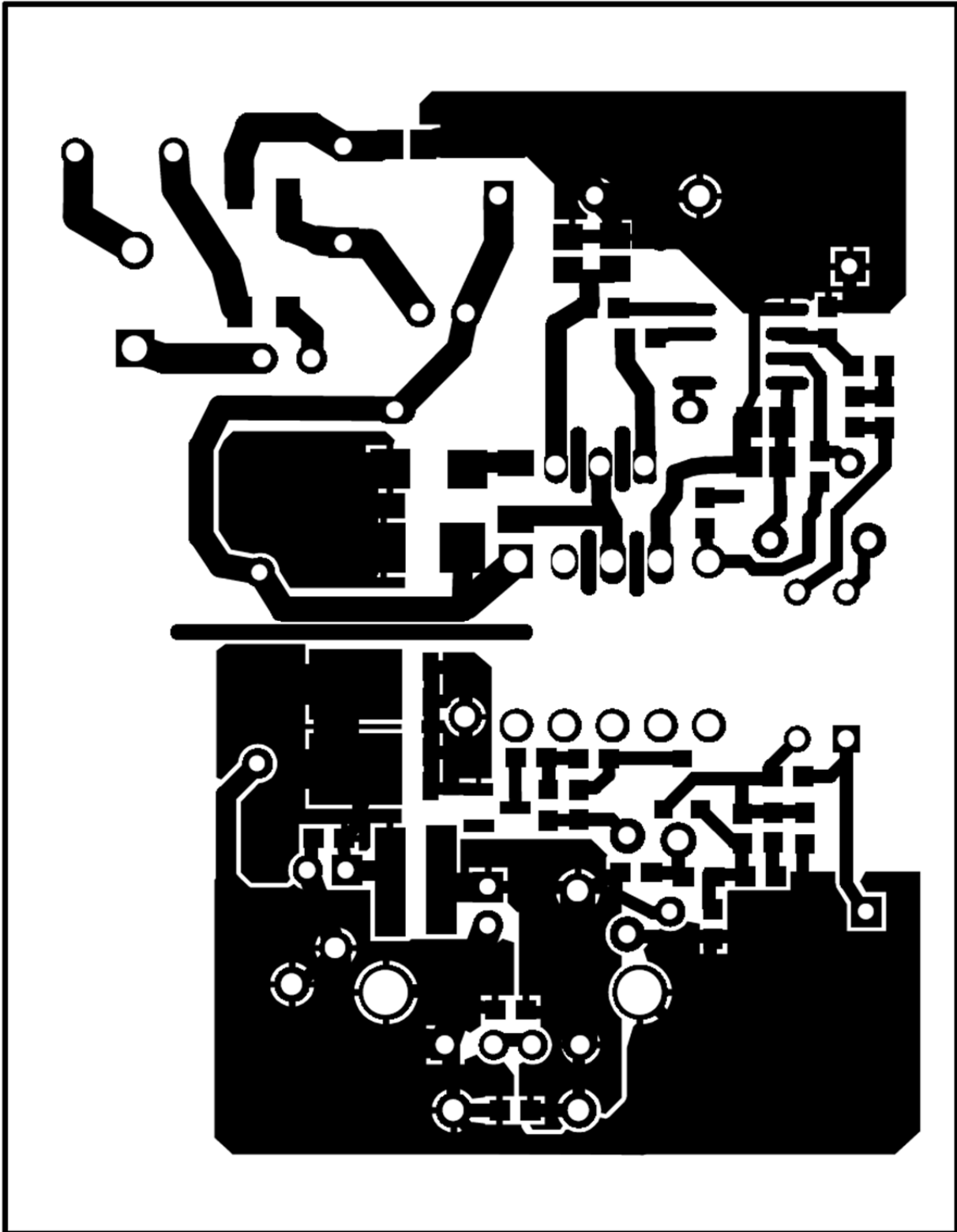

Figure 19. UCC28740EVM-525 Bottom Copper (Bottom View)

## 8 Bill of Materials

**Table 3. The EVM components list according to the schematic shown in Figure 1**

QTY	REFDES	DESCRIPTION	MFR	PART NUMBER
2	C1, C2	CAP, CERM, 2.2 $\mu$ F, 50 V, X7R, $\pm$ 10%, 0805	Taiyo Yuden	UMK212BB7225KG-T
2	C3, C4	CAP, ALUM, 6.8 $\mu$ F, 400 V, $\pm$ 20%, 110 mA, Radial	United Chemi-Con	EKXG401ELL6R8MJ16S
1	C5	CAP, CERM, 0.047 $\mu$ F, 25 V, X7R, $\pm$ 5%, 0603	AVX	06033C473JAT2A
1	C6	CAP, CERM, 100 pF, 250 V, X1Y2, $\pm$ 10%, Radial, Disc	TDK Corporation	CD70-B2GA101KYNS
4	C7, C11, C14, C15	CAP, CERM, 1 $\mu$ F, 16 V, $\pm$ 10%, X7R, 0603	TDK	C1608X7R1C105K
2	C8, C10	CAP, ALUM, 270 $\mu$ F, 6.3 V, $\pm$ 20%, 11 m $\Omega$ ESR, Radial	Nichicon	RNE0J271MDS1
0	C9	CAP, CERM, 1 $\mu$ F, 16 V, $\pm$ 10%, X7R, 0603	TDK	C1608X7R1C105K
0	C12	CAP, CERM, 4700 pF, 100 V, $\pm$ 5%, X7R, 0603	AVX	06031C472JAT2A
1	C13	CAP, CERM, 2700 pF, 100 V, $\pm$ 5%, X7R, 0603	AVX	06031C272JAT2A
1	D1	Diode, Switching, 200 V, 250 mA, SOD-323	Infineon Technologies	BAS 21-03W E6327
1	D2	Diode, Switching-Bridge, 600 V, 0.8 A, MiniDIP	Diodes Inc.	HD06-T
1	D3	Diode, Transient Voltage Suppressor, 600 W, 120 V, SMB	Diodes Inc	SMBJ120A-13-F
1	D4	Diode, Ultra Fast, 1000 V, 1 A, SMA	Vishay Semiconductor Diodes Division	US1M-E3/61T
2	D5, D6	Diode, Super Barrier Rectifier, 45 V, 10 A, PowerDI5	Diodes Inc.	SBR10U45SP5-13
0	D7	Diode, Ultrafast, 75 V, 0.3 A, SOT-23	Diodes Inc.	BAS16-7-F
1	F1	Fuse, 2 A, 250 V, TH, 8.35 x 7.7 x 4 mm	Bel Fuse Inc	RST 2
1	J1	Conn, Term Block, 2POS, 5.08 mm, TH	Phoenix Contact	1715721
1	J2	Connector, Receptacle, USB Type A, Vertical, TH	CnC Tech	1002-021-01000
1	JMP1	Jumper, 0.600 inch length, PVC Insulation, AWG 22	3M	923345-06-C
2	JMP2, JMP3	Jumper, 0.200 inch length, PVC Insulation, AWG 22	3M	923345-02-C
1	L1	Inductor, RF Choke, 220 $\mu$ H, $\pm$ 10%, 6 mm Dia.	Würth Electronics Inc	7447462221
1	L2	Inductor, Shielded, Composite, 1 $\mu$ H, 8.7 A, 13.25 m $\Omega$ , SMD, 4 mm x 2.1 mm x 4 mm	Coilcraft	XAL4020-102MEB
1	Q1	MOSFET, N-CH, 600 V, 5 A, 0.9 $\Omega$ , TO251-3	STMicroelectronics	STU7NM60N
1	R1	RES, 24.3 $\Omega$ , $\pm$ 1%, 0.1 W, 0603	Yageo America	RC0603FR-0724R3L
1	R2	RES, 105 k $\Omega$ , $\pm$ 1%, 0.1 W, 0603	Vishay-Dale	CRCW0603105KFKEA
1	R3	RES, 27.4 k $\Omega$ , $\pm$ 1%, 0.25 W, TH	Vishay-Dale	CMF5027K400FHFB
1	R4	RES, 22.0 k $\Omega$ , $\pm$ 1%, 0.1 W, 0603	Yageo America	RC0603FR-0722KL
1	R5	RES, 0 $\Omega$ , $\pm$ 5%, 0.125 W, 0805	Vishay-Dale	CRCW08050000Z0EA
3	R6, R8, R17	RES, 0 $\Omega$ , $\pm$ 5%, 0.1 W, 0603	Vishay-Dale	CRCW06030000Z0EA

QTY	REFDES	DESCRIPTION	MFR	PART NUMBER
1	R7	RES, 196 k $\Omega$ , $\pm$ 1%, 0.1 W, 0603	Yageo America	RC0603FR-07196KL
1	R9	RES, 1.27 k $\Omega$ , $\pm$ 1%, 0.1 W, 0603	Vishay-Dale	CRCW06031K27FKEA
2	R10, R11	RES, 1.87 $\Omega$ , $\pm$ 1%, 0.125 W, 0805	Vishay-Dale	CRCW08051R87FKEA
1	R12	RES, 49.9 $\Omega$ , $\pm$ 1%, 0.25 W, 1206	Vishay-Dale	CRCW120649R9FKEA
0	R13	RES, 820 $\Omega$ , $\pm$ 1%, 0.1 W, 0603	Yageo America	RC0603FR-07820RL
0	R14	RES, 2.00 k $\Omega$ , $\pm$ 1%, 0.1 W, 0603	Vishay-Dale	CRCW06032K00FKEA
1	R15	RES, 1.50 k $\Omega$ , $\pm$ 1%, 0.25 W, TH	Vishay-Dale	CMF501K5000FHEB
1	R16	RES, 1.00 k $\Omega$ , $\pm$ 1%, 0.1 W, 0603	Yageo America	RC0603FR-071KL
0	R18	RES, 140 k $\Omega$ , $\pm$ 1%, 0.1 W, 0603	Vishay-Dale	CRCW0603140KFKEA
2	R19, R20	RES, 42.2 k $\Omega$ , $\pm$ 1%, 0.1 W, 0603	Vishay-Dale	CRCW060342K2FKEA
1	R21	RES, 49.9 $\Omega$ , $\pm$ 1%, 0.1 W, 0603	Yageo America	RC0603FR-0749R9L
1	RT1	Thermistor NTC, 10 $\Omega$ , $\pm$ 20%, Leaded	Ametherm	SL03 10001
1	T1	Transformer, 560 $\mu$ H, TH, 580 mil x 600 mil x 580 mil	Würth Elektronik eiSos	7508111111 Rev 001
6	TP1, TP2, TP3, TP4, TP5, TP6	Pin, Thru Hole, Tin Plate, for 0.062 PCB's	Vector	K24C/M
1	U1	Constant-Voltage, Constant-Current Flyback Controller Using Opto-Coupler Feedback, D0007A	Texas Instruments	UCC28740D
1	U2	Opto-Isolator, 1 Channel, TH, DIP-4	Lite-On	LTV-817A
1	U3	IC, Precision Adjustable Shunt Regulator, $\pm$ 1%, SOT23-3	Texas Instruments	TL431AIDBZ

## EVALUATION BOARD/KIT/MODULE (EVM) WARNINGS, RESTRICTIONS AND DISCLAIMER

**For Feasibility Evaluation Only, in Laboratory/Development Environments.** The EVM is not a complete product. It is intended solely for use for preliminary feasibility evaluation in laboratory / development environments by technically qualified electronics experts who are familiar with the dangers and application risks associated with handling electrical / mechanical components, systems and subsystems. It should not be used as all or part of a production unit.

**Your Sole Responsibility and Risk.** You acknowledge, represent and agree that:

1. You have unique knowledge concerning Federal, State and local regulatory requirements (including but not limited to Food and Drug Administration regulations, if applicable) which relate to your products and which relate to your use (and/or that of your employees, affiliates, contractors or designees) of the EVM for evaluation, testing and other purposes.
2. You have full and exclusive responsibility to assure the safety and compliance of your products with all such laws and other applicable regulatory requirements, and also to assure the safety of any activities to be conducted by you and/or your employees, affiliates, contractors or designees, using the EVM. Further, you are responsible to assure that any interfaces (electronic and/or mechanical) between the EVM and any human body are designed with suitable isolation and means to safely limit accessible leakage currents to minimize the risk of electrical shock hazard.
3. Since the EVM is not a completed product, it may not meet all applicable regulatory and safety compliance standards (such as UL, CSA, VDE, CE, RoHS and WEEE) which may normally be associated with similar items. You assume full responsibility to determine and/or assure compliance with any such standards and related certifications as may be applicable. You will employ reasonable safeguards to ensure that your use of the EVM will not result in any property damage, injury or death, even if the EVM should fail to perform as described or expected.

**Certain Instructions.** Exceeding the specified EVM ratings (including but not limited to 85 VAC to 265 VAC input and 5 V output voltage, 2.5 A current, 10.5 W power, and 25 C environmental ranges) may cause property damage, personal injury or death. If there are questions concerning these ratings please contact a TI field representative prior to connecting interface electronics including input power and intended loads. Any loads applied outside of the specified output range may result in unintended and/or inaccurate operation and/or possible permanent damage to the EVM and/or interface electronics. Please consult the EVM User's Guide prior to connecting any load to the EVM output. If there is uncertainty as to the load specification, please contact a TI field representative. During normal operation, some circuit components may have case temperatures greater than 60°C as long as the input and output ranges are maintained at nominal ambient operating temperature. These components include but are not limited to linear regulators, switching transistors, pass transistors, and current sense resistors which can be identified using the EVM schematic located in the EVM User's Guide. When placing measurement probes near these devices during normal operation, please be aware that these devices may be very warm to the touch.

**Agreement to Defend, Indemnify and Hold Harmless.** You agree to defend, indemnify and hold TI, its licensors and their representatives harmless from and against any and all claims, damages, losses, expenses, costs and liabilities (collectively, "Claims") arising out of or in connection with any use of the EVM that is not in accordance with the terms of this agreement. This obligation shall apply whether Claims arise under the law of tort or contract or any other legal theory, and even if the EVM fails to perform as described or expected.

**Safety-Critical or Life-Critical Applications.** If you intend to evaluate TI components for possible use in safety-critical applications (such as life support) where a failure of the TI product would reasonably be expected to cause severe personal injury or death, such as devices which are classified as FDA Class III or similar classification, then you must specifically notify TI of such intent and enter into a separate Assurance and Indemnity Agreement.

## IMPORTANT NOTICE

Texas Instruments Incorporated and its subsidiaries (TI) reserve the right to make corrections, modifications, enhancements, improvements, and other changes to its products and services at any time and to discontinue any product or service without notice. Customers should obtain the latest relevant information before placing orders and should verify that such information is current and complete. All products are sold subject to TI's terms and conditions of sale supplied at the time of order acknowledgment.

TI warrants performance of its hardware products to the specifications applicable at the time of sale in accordance with TI's standard warranty. Testing and other quality control techniques are used to the extent TI deems necessary to support this warranty. Except where mandated by government requirements, testing of all parameters of each product is not necessarily performed.

TI assumes no liability for applications assistance or customer product design. Customers are responsible for their products and applications using TI components. To minimize the risks associated with customer products and applications, customers should provide adequate design and operating safeguards.

TI does not warrant or represent that any license, either express or implied, is granted under any TI patent right, copyright, mask work right, or other TI intellectual property right relating to any combination, machine, or process in which TI products or services are used. Information published by TI regarding third-party products or services does not constitute a license from TI to use such products or services or a warranty or endorsement thereof. Use of such information may require a license from a third party under the patents or other intellectual property of the third party, or a license from TI under the patents or other intellectual property of TI.

Reproduction of TI information in TI data books or data sheets is permissible only if reproduction is without alteration and is accompanied by all associated warranties, conditions, limitations, and notices. Reproduction of this information with alteration is an unfair and deceptive business practice. TI is not responsible or liable for such altered documentation. Information of third parties may be subject to additional restrictions.

Resale of TI products or services with statements different from or beyond the parameters stated by TI for that product or service voids all express and any implied warranties for the associated TI product or service and is an unfair and deceptive business practice. TI is not responsible or liable for any such statements.

TI products are not authorized for use in safety-critical applications (such as life support) where a failure of the TI product would reasonably be expected to cause severe personal injury or death, unless officers of the parties have executed an agreement specifically governing such use. Buyers represent that they have all necessary expertise in the safety and regulatory ramifications of their applications, and acknowledge and agree that they are solely responsible for all legal, regulatory and safety-related requirements concerning their products and any use of TI products in such safety-critical applications, notwithstanding any applications-related information or support that may be provided by TI. Further, Buyers must fully indemnify TI and its representatives against any damages arising out of the use of TI products in such safety-critical applications.

TI products are neither designed nor intended for use in military/aerospace applications or environments unless the TI products are specifically designated by TI as military-grade or "enhanced plastic." Only products designated by TI as military-grade meet military specifications. Buyers acknowledge and agree that any such use of TI products which TI has not designated as military-grade is solely at the Buyer's risk, and that they are solely responsible for compliance with all legal and regulatory requirements in connection with such use.

TI products are neither designed nor intended for use in automotive applications or environments unless the specific TI products are designated by TI as compliant with ISO/TS 16949 requirements. Buyers acknowledge and agree that, if they use any non-designated products in automotive applications, TI will not be responsible for any failure to meet such requirements.

Following are URLs where you can obtain information on other Texas Instruments products and application solutions:

### Products

Amplifiers	<a href="http://amplifier.ti.com">amplifier.ti.com</a>
Data Converters	<a href="http://dataconverter.ti.com">dataconverter.ti.com</a>
DSP	<a href="http://dsp.ti.com">dsp.ti.com</a>
Clocks and Timers	<a href="http://www.ti.com/clocks">www.ti.com/clocks</a>
Interface	<a href="http://interface.ti.com">interface.ti.com</a>
Logic	<a href="http://logic.ti.com">logic.ti.com</a>
Power Mgmt	<a href="http://power.ti.com">power.ti.com</a>
Microcontrollers	<a href="http://microcontroller.ti.com">microcontroller.ti.com</a>
RFID	<a href="http://www.ti-rfid.com">www.ti-rfid.com</a>
RF/IF and ZigBee® Solutions	<a href="http://www.ti.com/lprf">www.ti.com/lprf</a>

### Applications

Audio	<a href="http://www.ti.com/audio">www.ti.com/audio</a>
Automotive	<a href="http://www.ti.com/automotive">www.ti.com/automotive</a>
Broadband	<a href="http://www.ti.com/broadband">www.ti.com/broadband</a>
Digital Control	<a href="http://www.ti.com/digitalcontrol">www.ti.com/digitalcontrol</a>
Medical	<a href="http://www.ti.com/medical">www.ti.com/medical</a>
Military	<a href="http://www.ti.com/military">www.ti.com/military</a>
Optical Networking	<a href="http://www.ti.com/opticalnetwork">www.ti.com/opticalnetwork</a>
Security	<a href="http://www.ti.com/security">www.ti.com/security</a>
Telephony	<a href="http://www.ti.com/telephony">www.ti.com/telephony</a>
Video & Imaging	<a href="http://www.ti.com/video">www.ti.com/video</a>
Wireless	<a href="http://www.ti.com/wireless">www.ti.com/wireless</a>

Mailing Address: Texas Instruments, Post Office Box 655303, Dallas, Texas 75265  
Copyright © 2008, Texas Instruments Incorporated