

TPS259824OEVN: Evaluation Module for TPS259824O eFuse

This user's guide describes the evaluation module (EVM) for the TPS259824O eFuse. The TPS259824O device is 2.7 V to 24 V, 15 A eFuse with integrated 2.7 mOhm FET, programmable under voltage, over current, inrush current protection and configurable number of Auto-retries and Retry Delay features.

Contents

1	Introduction	2
2	Description	2
3	Schematic.....	3
4	General Configurations	4
5	Test Setup and Procedures	5
6	EVAL Board Assembly Drawings and Layout Guidelines.....	11
7	Bill Of Materials (BoM).....	13

List of Figures

1	TPS259824OEVN eFuse Evaluation Board Schematic.....	3
2	TPS259824OEVN Setup with Test Equipment.....	6
3	TPS259824O Output Rise Profile (VIN = 12 V, CdVdT = 10 nF, COUT = 2 mF, No-load).....	7
4	Over Current Response of TPS259824O for 15 A Current Limit Setting	8
5	Output Hot-short response of TPS259824O device	9
6	Test Waveform of Wakeup Into Output Short for TPS259824O Device	10
7	Over Voltage Protection Response of TPS259824O Device.....	11
8	TPS259824OEVN Board (a) Top Assembly (b) Bottom Assembly	11
9	TPS259824OEVN Board (a) Top Layer (b) Bottom Layer	12
10	TPS259824OEVN Board (a) Inner Signal Layer (b) Inner Routing Layer	12

List of Tables

1	TPS259824OEVN eFuse Evaluation Board Options and Setting.....	2
2	Input and Output Connector Functionality.....	4
3	Test Points Description	4
4	Jumper and LED Descriptions	4
5	Auto-retries and Retry Delay Settings	5
6	Default Jumper Setting for TPS259824OEVN eFuse Evaluation Board.....	6
7	TPS259824OEVN Bill Of Materials.....	13

Trademarks

All trademarks are the property of their respective owners.

1 Introduction

The *TPS259824OEVM eFuse Evaluation Board* allows reference circuit evaluation of TI's TPS259824O eFuse. The TPS259824O device is 2.7 V to 24 V, 15 A eFuse with integrated 2.7 mOhm FET, programmable under voltage, over current, inrush current protection and configurable number of Auto-retries and Retry Delay features.

1.1 EVM Features

General TPS259824OEVM eFuse evaluation board features include:

- 2.7-V to 24-V (typ) operation
- 3 A to 15 A programmable current limit using onboard jumpers
- Programmable output voltage slew rate control
- Configurable number of auto-retries and retry-delay features
- Programmable current limit timer
- TVS diode for input transient protection
- On-board Schottky diode at output prevents negative spike during overcurrent faults
- LED status indication for Power Good output

1.2 EVM Applications

This EVM can be use on the following applications:

- Hot-Swap, Hot-Plug
- Server standby rails
- Optical Modules
- PCIe, SSDs and HDDs
- Routers and Switches
- Industrial PC
- Digital TV

2 Description

The TPS259824OEVM eFuse Evaluation Board enables evaluation of TPS259824O eFuse from TPS25982xx family. The input power is applied between connectors J1 and J3 while J2 and J5 provides the output connection to the load; refer to the schematic in [Figure 1](#), and EVM test setup in [Figure 2](#). D1/C1 provides input protection for the TPS259824O eFuse while D2/C2 provides output protection.

S1 allows U1 to be RESET or disabled. A power good (PG) indicator is provided by D3. Scaled device current can be monitored at TP15 with a scale factor of 0.13 V/A.

Table 1. TPS259824OEVM eFuse Evaluation Board Options and Setting

Part Number	EVM Function	Vin Range	Vin UVLO	OV Cut-off	Current Limit		Fault Response
					Low Setting	Hi Setting	
TPS259824OEVM eFuse Evaluation Board	2.7 V to 24 V, 15 A eFuse	2.7 V to 24 V	2.46 V	16.7 V	3 A	15 A	Configurable number of auto-retries and retry-delay

3 Schematic

Figure 1 illustrates the EVM schematic.

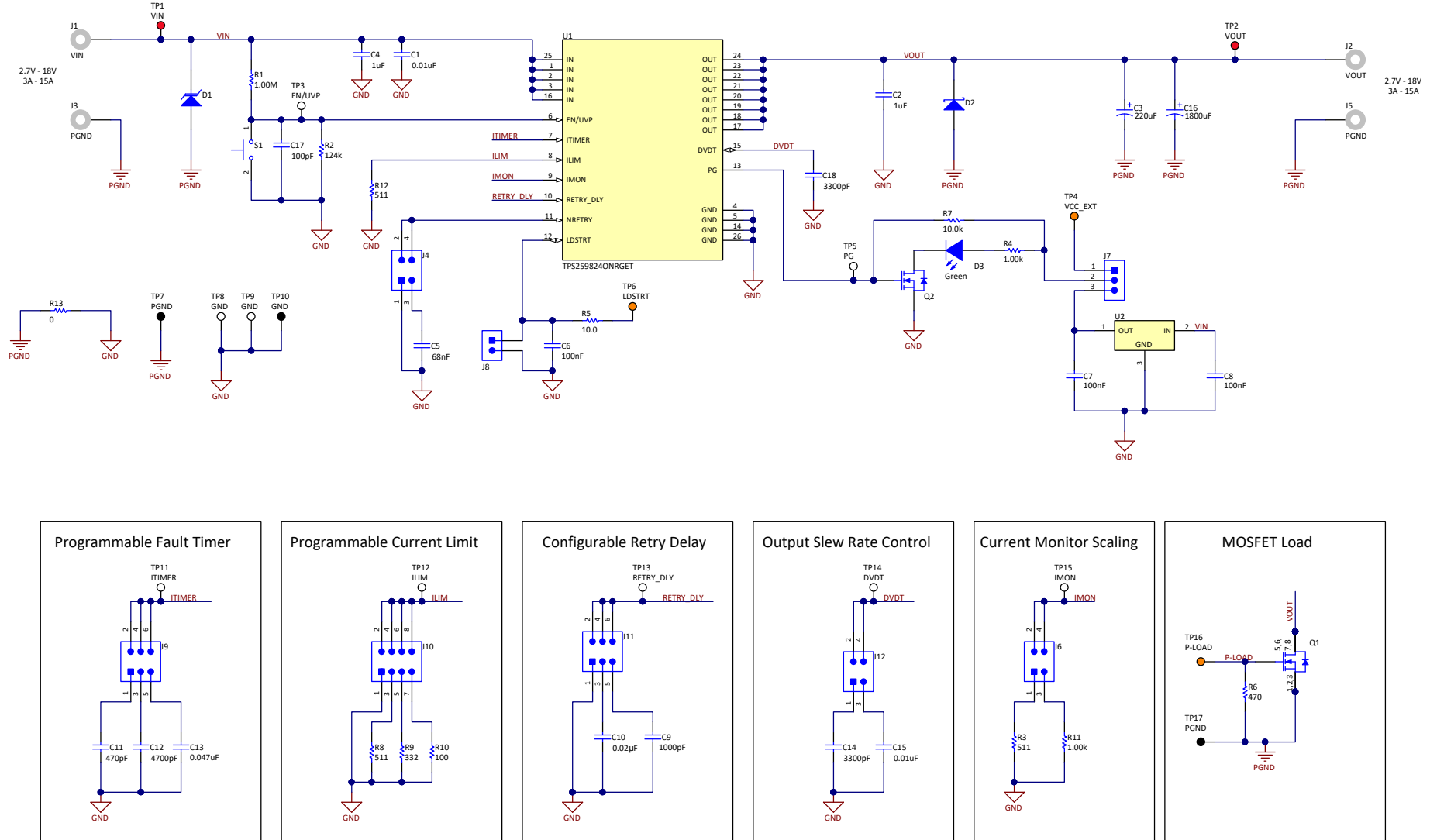

Figure 1. TPS259824OEVM eFuse Evaluation Board Schematic

4 General Configurations

4.1 Physical Access

Table 2 lists the TPS259824OEVm eFuse Evaluation Board input and output connector functionality. Table 3 and Table 4 describe the test point availability and the jumper functionality. Table 5 describes the auto-retries and retry-delay settings.

Table 2. Input and Output Connector Functionality

Connector	Label	Description
J1	VIN	Power input connector to the positive rail of the input power supply
J3	PGND	Ground connection for the power supply
J2	VOUT	Power output connector to the positive side of the load
J5	PGND	Ground connection for the load

Table 3. Test Points Description

Test Points	Label	Description
TP1	VIN	Input power supply to the EVM
TP2	VOUT	Output from the EVM
TP3	EN/UVP	Active high enable and undervoltage input
TP4	VCC_EXT	External power supply input for Power Good pullup
TP5	PG	Power Good test point
TP6	LDSTRT	Load handshake signal input point
TP7	PGND	System ground
TP8	GND	GND(IC GND)
TP9	GND	GND(IC GND)
TP10	GND	GND(IC GND)
TP11	ITIMER	Fault timer voltage
TP12	ILIM	Sets current limit threshold
TP13	RETRY_DLY	Sets retry delay time
TP14	DVDT	Output voltage ramp control
TP15	IMON	Load current monitor

Table 4. Jumper and LED Descriptions

Jumper	Label	Description
J4	NRETRY	NRETRY setting number of auto-retries. Please refer Table 5 for details 1-2 Position shorts to ground 3-4 Position sets 68 nF
J6	IMON	Current scale setting 1-2 Position sets 0.13 V/A 3-4 Position sets 0.25 V/A
J7	PG Pull-Up	PG Pull-Up voltage setting 1-2 Position sets external source "VCC_EXT" 3-4 Position sets 3.3 V
J8	LDSTRT	LDSTRT setting Install J8 to disable the LDSTRT function OPEN J8 to feed LDSTRT signal externally
J9	ITIMER	ITIMER setting (sets delay before entering into current limit) OPEN sets '0'sec delay 1-2 Position sets 200 μ s delay 3-4 Position sets 2 ms delay 5-6 Position sets 20 ms delay

Table 4. Jumper and LED Descriptions (continued)

Jumper	Label	Description
J10	ILIM	Current Limit Setting OPEN disables the device 1-2 Position sets Rilim to short and disables the device 3-4 Position sets 3 A 5-6 Position sets 5 A 7-8 Position sets 15 A
J11	RETRY_DLY	Retry delay setting OPEN sets 200 μ s 1-2 Position sets "NO auto-retry" (latches OFF the device) 3-4 Position sets 1 s retry delay 5-6 Position sets 50 ms retry delay
J12	DVDT	Output voltage slew rate setting 1-2 Position sets 1.5 V/ms 3-4 Position sets 0.5 V/ms
D3 (GREEN – LED)	D3	Power good indicator. LED turns on when the internal FET fully turns ON

Table 5. Auto-retries and Retry Delay Settings

RETRY_DLY (J11 Position)	Retry Delay	NRETRY (J4 Position)	Number of Auto-Retries
OPEN	200 μ s	OPEN	4
		1-2	Infinite
		2-3	16
1-2 Position	Latches OFF	X	0
3-4 Position	1 s	OPEN	4
		1-2	Infinite
		2-3	16
5-6 Position	50 ms	OPEN	4
		1-2	Infinite
		2-3	64

4.2 Test Equipment and Set up

4.2.1 POWER SUPPLIES

One adjustable power supply 0 V to 30 V output, 0 A to 30 A output current limit.

4.2.2 METERS

One DMM minimum needed.

4.2.3 OSCILLOSCOPE

A DPO2024 or equivalent, three 10x voltage probes, and a DC current probe.

4.2.4 LOADS

One resistive load or equivalent which can tolerate up to 30 A DC load @ 24 V and capable of the output short.

5 Test Setup and Procedures

In this user guide, the test procedure is described for TPS259824O device. Following similar test steps, TPS259822x/3x/4x variants from TPS25982xx family can also be evaluated.

Make sure the evaluation board has default jumper settings as shown in [Table 6](#).

Table 6. Default Jumper Setting for TPS259824OEVm eFuse Evaluation Board

J4	J6	J7	J8	J9	J10	J11	J12
Open	1-2	2-3	Install	3-4	5-6	Open	1-2

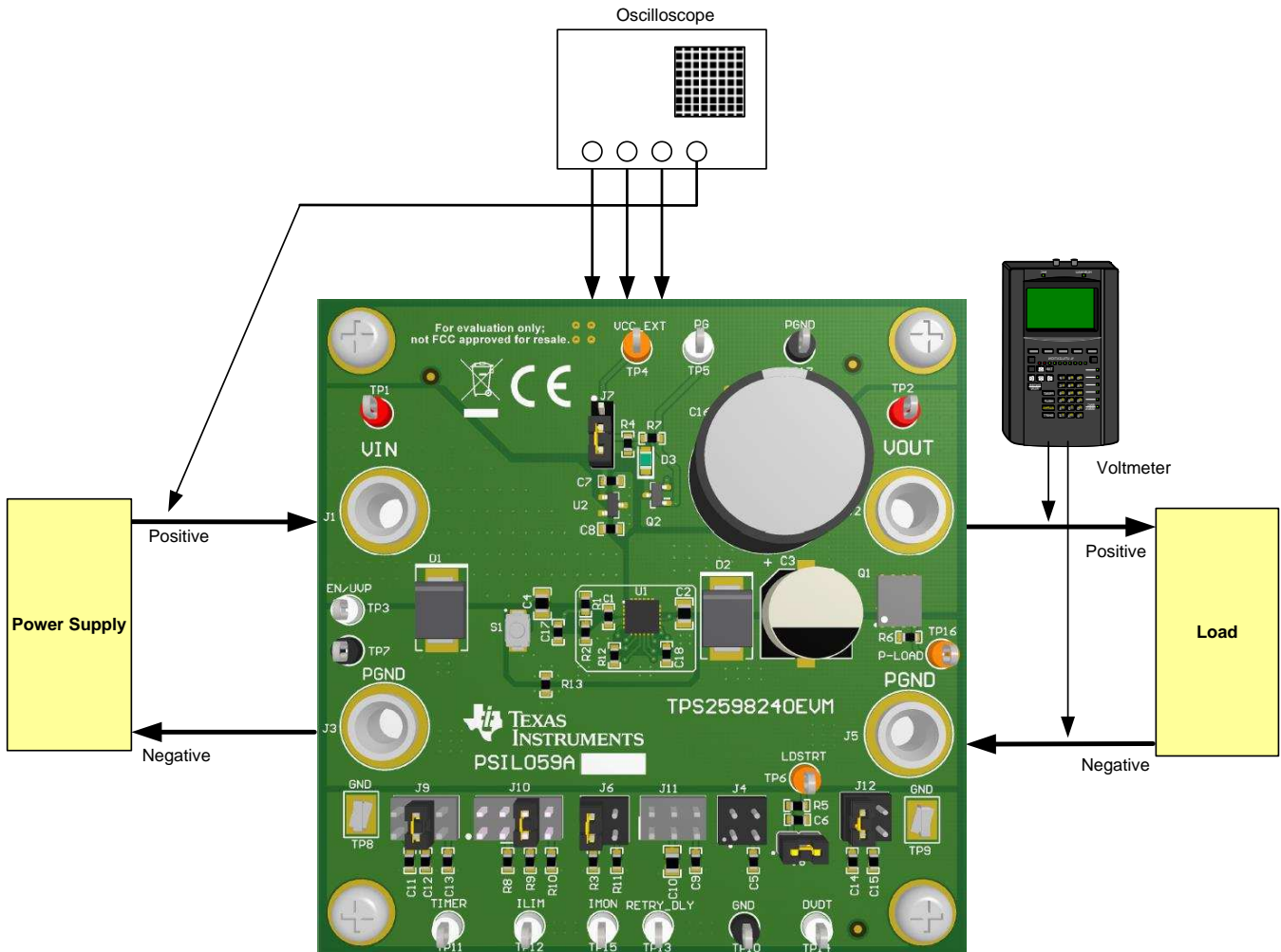

Figure 2. TPS259824OEVm Setup with Test Equipment

Follow the below instructions before starting any test and repeat again before moving to next test.

- Set the power supply output (VIN) to zero volts.
- Turn ON the power supply and set the power supply output (VIN) to 12 V, current limit = 20 A.
- Turn OFF the power supply.
- Set the jumper setting on EVM to default position as shown in [Table 6](#).

5.1 Hot-Plug Test

Use the following instructions to measure the inrush current during Hot-Plug event.

1. For checking inrush current control capability, insert additional capacitance of 1800 uF at C16 terminals. Total output capacitance = 1800 uF + 220 uF ~2 mF.
2. Set Jumper J12 in 3-4 position to set Cdvdt at 10 nF for o/p slew rate of 0.5 V/ms.

3. Set the input supply voltage VIN to 12 V and current limit of 5 A. Enable the power supply.
4. Hot-plug the supply between input connectors J1 and J3.
5. Observe the waveform at VOUT (TP2) with an oscilloscope to measure the slew rate and rise time of the eFuse with a given input voltage of 12 V.

Figure 3 shows an example of inrush current captured on the TPS259824OEVM eFuse Evaluation Board.

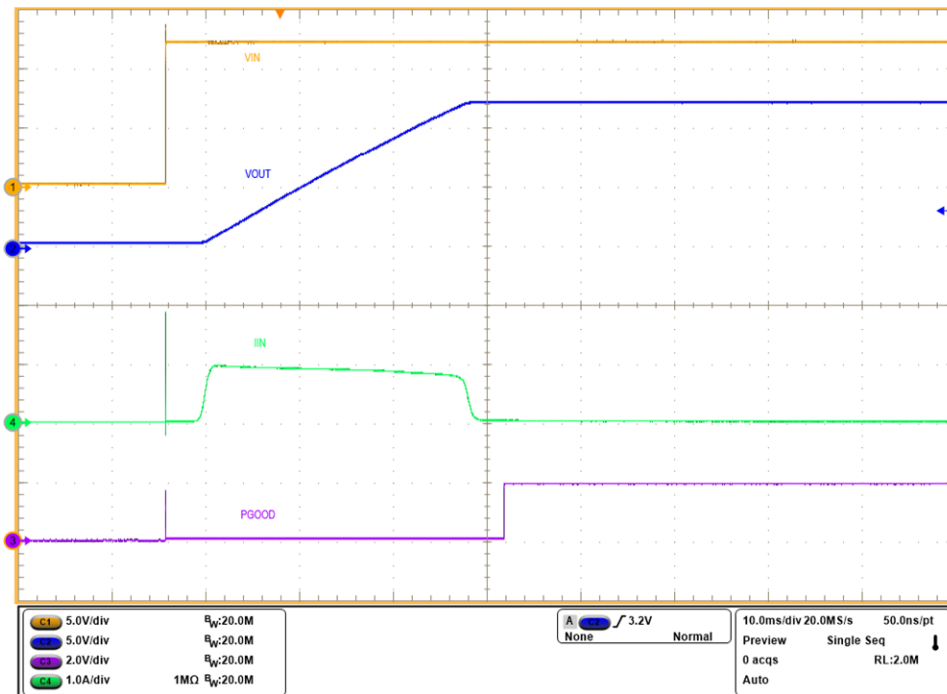

Figure 3. TPS259824O Output Rise Profile (VIN = 12 V, CdVdT = 10 nF, COUT = 2 mF, No-load)

5.2 Current Limit Test

Use the following instructions to perform current limit test.

1. Place jumper J9 in 3-4 Position to set 2 ms for ITIMER.
2. Set the input supply voltage VIN to 12 V and current limit of 25 A and enable the power supply.
3. Place jumper J10 in 7-8 Position to set 15 A current limit.
4. Set the electronic load to 12 A and connect between VOUT and GND. Enable the electronic load.
5. Now apply overload of 7 A (using resistive load of 1.66 Ohm) between VOUT and GND.
6. The device allows the overload current for the programmed ITIMER period for example, 2 ms and then switches OFF.
7. Place jumper J10 at other settings to test at various current limits.

Figure 4 shows an example of current limit at 15 A on the TPS259824OEVM eFuse Evaluation Board.

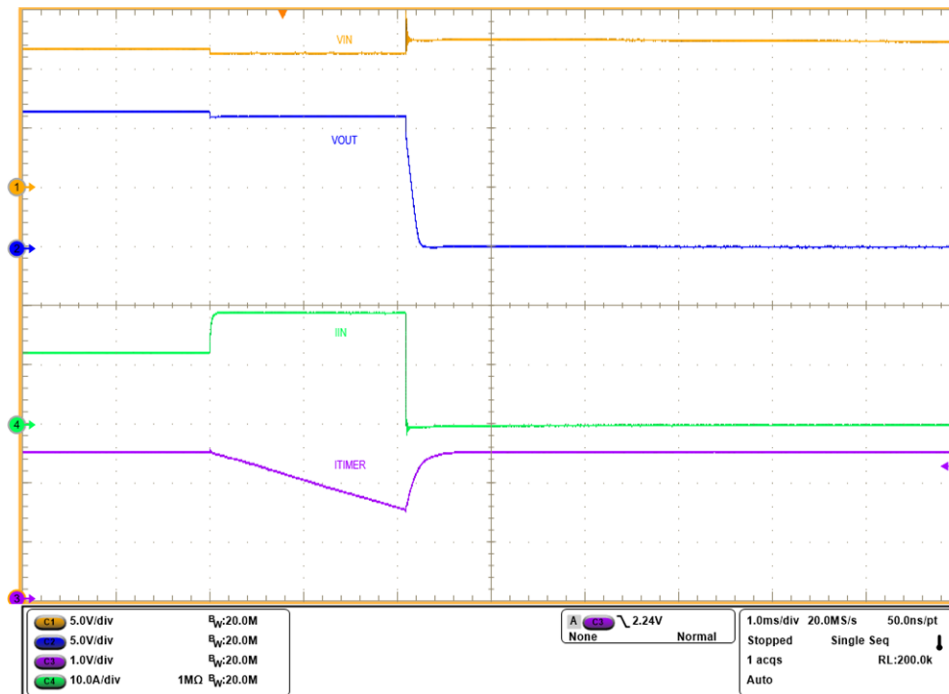

Figure 4. Over Current Response of TPS2598240 for 15 A Current Limit Setting

5.3 Output Hot-Short Test

Use the following instructions to perform output Hot-Short test.

1. Set the input supply voltage V_{IN} to 12 V and current limit of 15 A. Turn ON the power supply.
2. Short the output of the device for example, V_{OUT} to GND with a shorter cable.
3. Observe the waveforms using an oscilloscope.

Figure 5 shows test waveform of output hot-short on the TPS2598240EVM eFuse Evaluation Board.

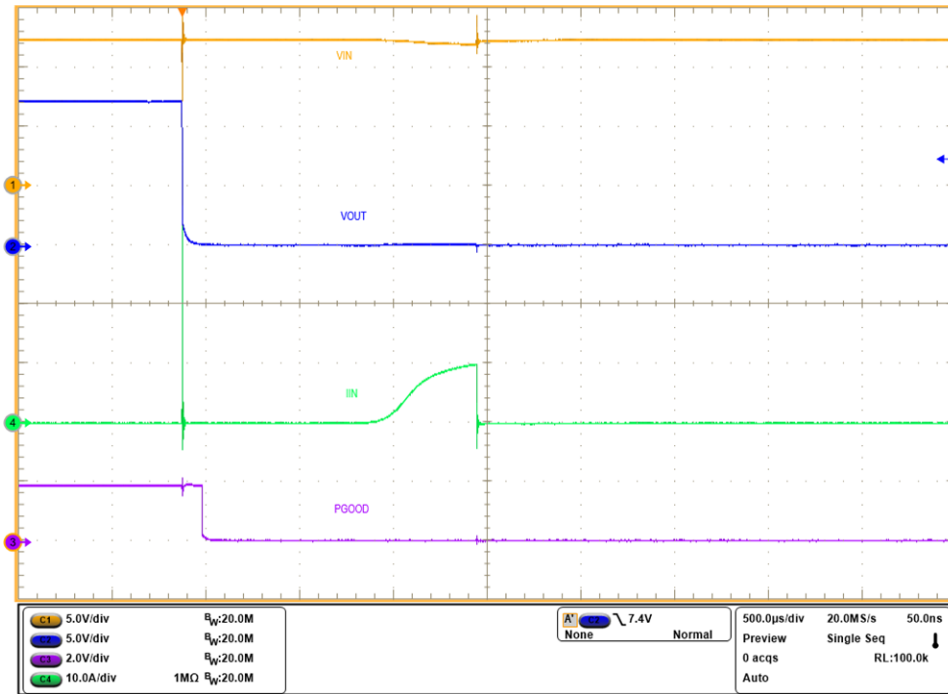

Figure 5. Output Hot-short response of TPS2598240 device

5.4 Wakeup into Short Test

Use the following instructions to perform wakeup into short test.

1. Set the input supply voltage VIN to 12 V and current limit of 10 A. Turn OFF the power supply.
2. Short the output of the device for example, VOUT to GND with a shorter cable.
3. Turn ON the power supply.

Figure 6 shows test waveform of wakeup into output short on the TPS2598240EVM eFuse Evaluation Board.

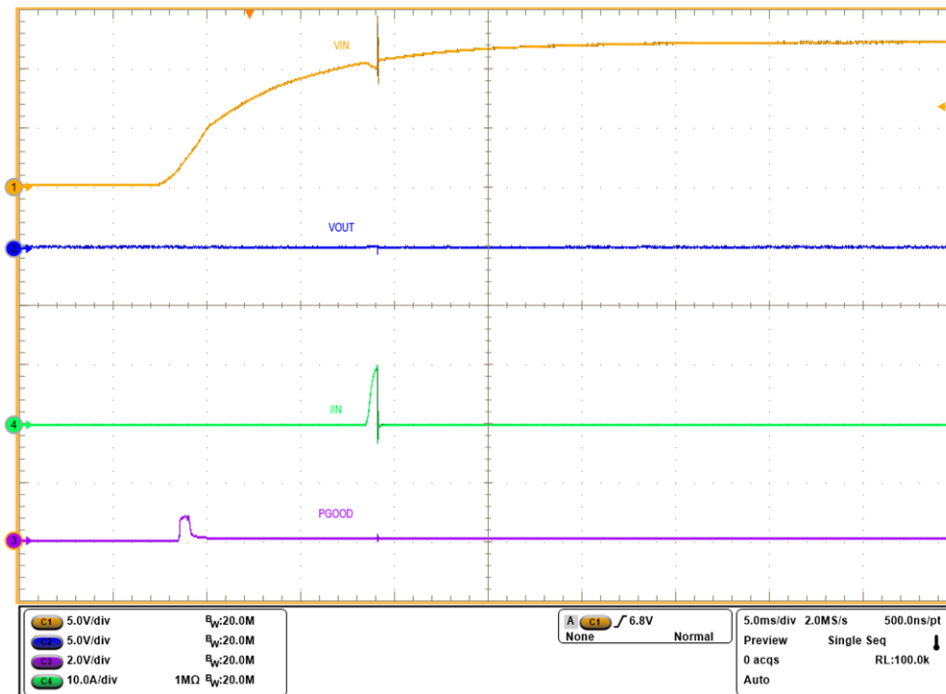

Figure 6. Test Waveform of Wakeup Into Output Short for TPS2598240 Device

5.5 Overvoltage Cut-off Test

Use the following instructions to perform overvoltage protection test.

1. Remove input TVS diodes.
2. Set the input supply voltage V_{IN} to 12 V and current limit of 5 A. Apply the supply between input connectors J1 and J3 and enable the power supply.
3. Set the load resistance to 24 Ω and connect between V_{OUT} and GND.
4. Increase the input supply V_{IN} from 12 V to 18 V and observe the waveforms using an oscilloscope.

Figure 7 shows over voltage response of TPS2598240 on TPS2598240EVM eFuse Evaluation Board.

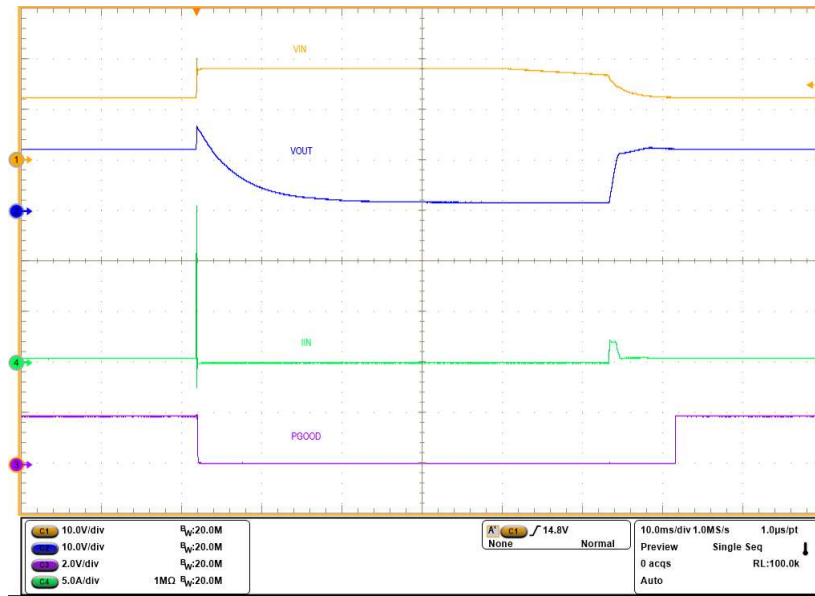

Figure 7. Over Voltage Protection Response of TPS2598240 Device

6 EVAL Board Assembly Drawings and Layout Guidelines

6.1 PCB Drawings

Figure 8 shows component placement of the EVAL Board and Figure 9, Figure 10 shows PCB layout images.

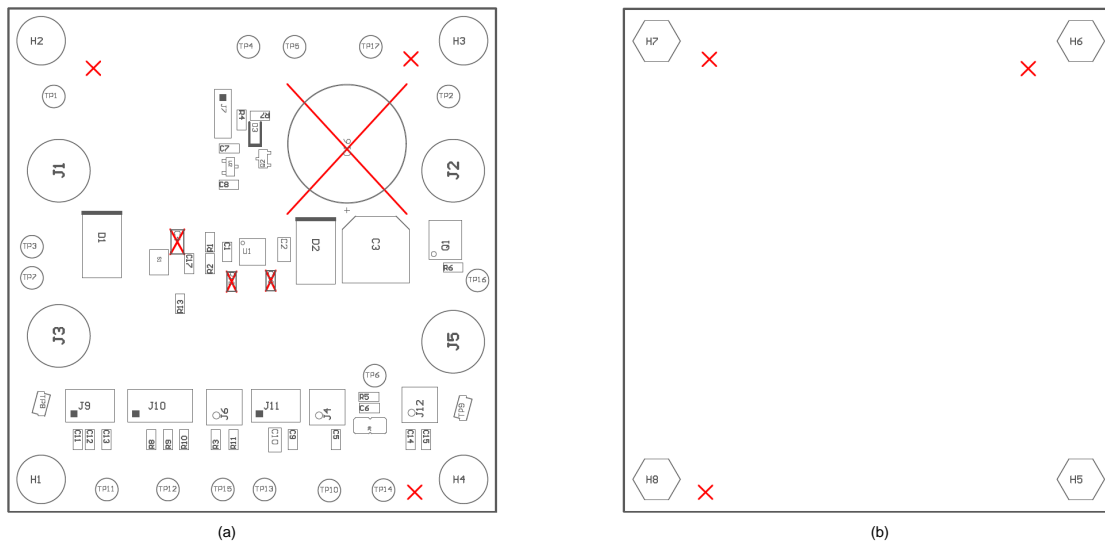

Figure 8. TPS2598240EVM Board (a) Top Assembly (b) Bottom Assembly

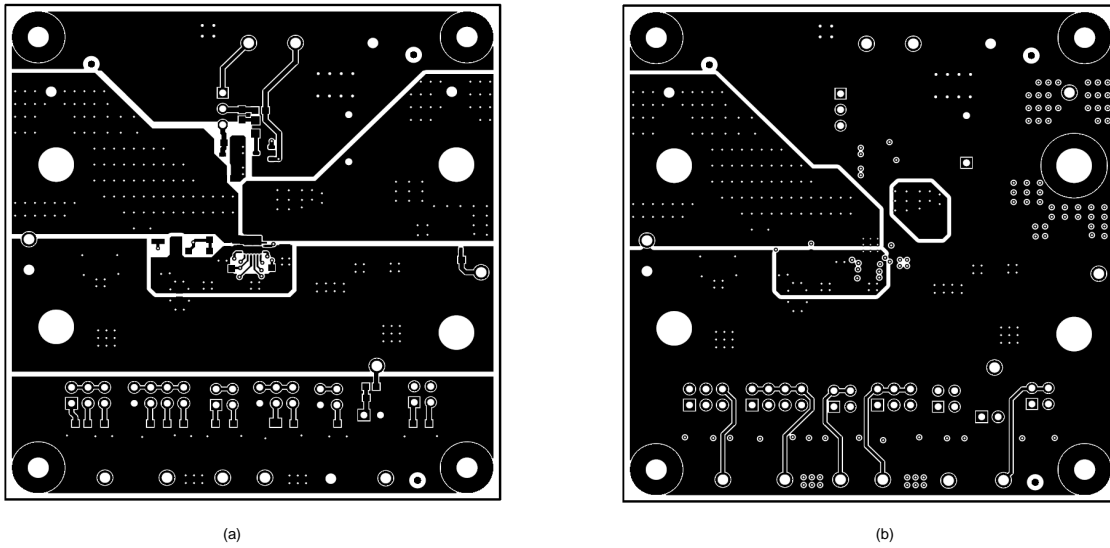

Figure 9. TPS259824OEVm Board (a) Top Layer (b) Bottom Layer

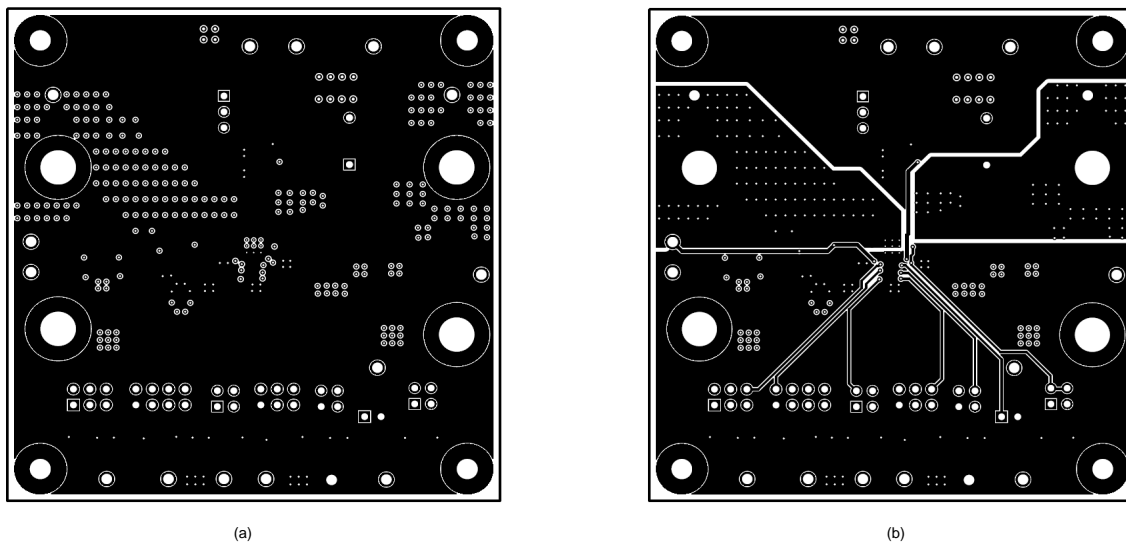

Figure 10. TPS259824OEVm Board (a) Inner Signal Layer (b) Inner Routing Layer

7 Bill Of Materials (BoM)

Table 7 lists the EVM BOM.

Table 7. TPS259824OEV Bill Of Materials

Designator	Quantity	Value	Description	PackageReference	PartNumber	Manufacturer	Alternate PartNumber	Alternate Manufacturer
!PCB1	1		Printed Circuit Board		PSIL059	Any		
C1	1	0.01 uF	CAP, CERM, 0.01 uF, 50 V, +/- 5%, X7R, 0603	0603	C0603C103J5RACTU	Kemet		
C2	1	1 uF	CAP, CERM, 1 uF, 35 V, +/- 10%, X7R, 0805	0805	GMK212B7105KG-T	Taiyo Yuden		
C3	1	220 uF	CAP, AL, 220 uF, 35 V, +/- 20%, 0.15 ohm, SMD	SMT Radial G	EEE-FC1V221P	Panasonic		
C5	1	0.068 uF	CAP, CERM, 0.068 uF, 25 V, +/- 10%, X7R, 0603	0603	885012206070	Wurth Elektronik		
C6, C7, C8	3	0.1 uF	CAP, CERM, 0.1 uF, 50 V, +/- 10%, X7R, 0603	0603	06035C104KAT2A	AVX		
C9	1	1000 pF	CAP, CERM, 1000 pF, 25 V, +/- 10%, C0G/NP0, 0603	0603	C0603C102K3GACTU	Kemet		
C10	1	0.02 uF	CAP, CERM, 0.02 uF, 50 V, +/- 5%, C0G/NP0, 0805	0805	GRM21B5C1H203JA0 1L	MuRata		
C11	1	470 pF	CAP, CERM, 470 pF, 50 V, +/- 5%, C0G/NP0, 0603	0603	06035A471JAT2A	AVX		
C12	1	4700 pF	CAP, CERM, 4700 pF, 50 V, +/- 5%, X7R, 0603	0603	C0603C472J5RACTU	Kemet		
C13	1	0.047 uF	CAP, CERM, 0.047 uF, 100 V, +/- 10%, X7S, 0603	0603	C1608X7S2A473K080 AB	TDK		
C14	1	3300 pF	CAP, CERM, 3300 pF, 50 V, +/- 10%, X7R, 0603	0603	C0603X332K5RACTU	Kemet		
C15	1	0.01 uF	CAP, CERM, 0.01 uF, 50 V, +/- 5%, C0G/NP0, 0603	0603	GRM1885C1H103JA0 1D	MuRata		
C17	1	100 pF	CAP, CERM, 100 pF, 50 V, +/- 5%, C0G/NP0, 0603	0603	885012006057	Wurth Elektronik		
D1	1	12 V	Diode, TVS, Uni, 12 V, 19.9 Vc, 1500 W, 79 A, SMC	SMC	SMCJ12A-TR	STMicroelectronics		
D2	1	30 V	Diode, Schottky, 30 V, 5 A, SMC	SMC	B530C-13-F	Diodes Inc.		
D3	1	Green	LED, Green, SMD	LED_0805	LTST-C170KGKT	Lite-On		
H1, H2, H3, H4	4		Machine Screw, Round, #4-40 x 1/4, Nylon, Philips panhead	Screw	NY PMS 440 0025 PH	B&F Fastener Supply		
H5, H6, H7, H8	4			Standoff	1902C	Keystone		

Table 7. TPS259824OEV Bill Of Materials (continued)

Designator	Quantity	Value	Description	PackageReference	PartNumber	Manufacturer	Alternate PartNumber	Alternate Manufacturer
J1, J2, J3, J5	4		Standard Banana Jack, Uninsulated, 8.9 mm	Keystone575-8	575-8	Keystone		
J4, J6, J12	3		Header, 100 mil, 2 x 2, Tin, TH	Header, 2 x 2, 2.54 mm, TH	PEC02DAAN	Sullins Connector Solutions		
J7	1		Header, 100 mil, 3 x 1, Tin, TH	Header, 3 PIN, 100 mil, Tin	PEC03SAAN	Sullins Connector Solutions		
J8	1		Header, 100 mil, 2 x 1, Gold, TH	Sullins 100 mil, 1 x 2, 230 mil above insulator	PBC02SAAN	Sullins Connector Solutions		
J9, J11	2		Header, 100 mil, 3 x 2, Tin, TH	3 x 2 Header	PEC03DAAN	Sullins Connector Solutions		
J10	1		Header, 100 mil, 4 x 2, Tin, TH	Header, 4 x 2, 100 mil, Tin	PEC04DAAN	Sullins Connector Solutions		
Q1	1	30 V	MOSFET, N-CH, 30 V, 100 A, DNK0008A (VSON-CLIP-8)	DNK0008A	CSD17573Q5B	Texas Instruments		
Q2	1	60 V	MOSFET, N-CH, 60 V, 115 A, SOT-23	SOT-23	2N7002	Fairchild Semiconductor		
R1	1	1.00 Meg	RES, 1.00 M, 1%, 0.1 W, 0603	0603	RC0603FR-071ML	Yageo America		
R2	1	124 k	RES, 124 k, 1%, 0.1 W, AEC-Q200 Grade 0, 0603	0603	CRCW0603124KFKEA	Vishay-Dale		
R3	1	511	RES, 511, 1%, 0.1 W, 0603	0603	RC0603FR-07511RL	Yageo America		
R4, R11	2	1.00 k	RES, 1.00 k, 1%, 0.1 W, 0603	0603	RC0603FR-071KL	Yageo America		
R5	1	10.0	RES, 10.0, 1%, 0.1 W, 0603	0603	RC0603FR-0710RL	Yageo America		
R6	1	470	RES, 470, 1%, 0.1 W, 0603	0603	RC0603FR-07470RL	Yageo America		
R7	1	10.0 k	RES, 10.0 k, 0.1%, 0.1 W, 0603	0603	RG1608P-103-B-T5	Susumu Co Ltd		
R8	1	511	RES, 511, 0.1%, 0.1 W, 0603	0603	RT0603BRD07511RL	Yageo America		
R9	1	332	RES, 332, 1%, 0.1 W, 0603	0603	RC0603FR-07332RL	Yageo		
R10	1	100	RES, 100, 1%, 0.1 W, AEC-Q200 Grade 0, 0603	0603	ERJ-3EKF1000V	Panasonic		
R13	1	0	RES, 0, 5%, 0.1 W, AEC-Q200 Grade 0, 0603	0603	CRCW06030000Z0EA	Vishay-Dale		
S1	1		Switch, SPST-NO, 0.05 A, 12 VDC, SMT	3.9 x 2.9 mm	SKRKAEE020	Alps		

Table 7. TPS259824OEV Bill Of Materials (continued)

Designator	Quantity	Value	Description	PackageReference	PartNumber	Manufacturer	Alternate PartNumber	Alternate Manufacturer
SH-J1, SH-J2, SH-J3, SH-J4, SH-J5, SH-J6	6	1 x 2	Shunt, 100 mil, Gold plated, Black	Shunt	SNT-100-BK-G	Samtec	969102-0000-DA	3M
TP1, TP2	2		Test Point, Multipurpose, Red, TH	Red Multipurpose Testpoint	5010	Keystone		
TP3, TP5, TP11, TP12, TP13, TP14, TP15	7		Test Point, Multipurpose, White, TH	White Multipurpose Testpoint	5012	Keystone		
TP4, TP6, TP16	3		Test Point, Multipurpose, Orange, TH	Orange Multipurpose Testpoint	5013	Keystone		
TP7, TP10, TP17	3		Test Point, Multipurpose, Black, TH	Black Multipurpose Testpoint	5011	Keystone		
TP8, TP9	2		Test Point, Compact, SMT	Testpoint_Keystone_Compact	5016	Keystone		
U1	1		2.7- 24 V, 15 A, 3 mohm RON Integrated Hot-swap protection with programmable Retries, RGE0024M (VQFN-24)	RGE0024M	TPS259824ONRGET	Texas Instruments	TPS259824ONRGER	Texas Instruments
U2	1		100 mA, Quasi Low-Dropout Linear Voltage Regulator, 3-pin SOT-23, Pb-Free	DBZ0003A	LM3480IM3-3.3/NOPB	Texas Instruments		
C4	0	1 uF	CAP, CERM, 1 uF, 35 V, +/- 10%, X7R, 0805	0805	GMK212B7105KG-T	Taiyo Yuden		
C16	0	1800 uF	CAP, AL, 1800 uF, 35 V, +/- 20%, 0.028 ohm, TH	D18 x L20 mm	UPW1V182MHD6	Nichicon		
C18	0	3300 pF	CAP, CERM, 3300 pF, 50 V, +/- 10%, X7R, 0603	0603	C0603X332K5RACTU	Kemet		
FID1, FID2, FID3, FID4, FID5, FID6	0		Fiducial mark. There is nothing to buy or mount.	N/A	N/A	N/A		
R12	0	511	RES, 511, 0.1%, 0.1 W, 0603	0603	RT0603BRD07511RL	Yageo America		

IMPORTANT NOTICE AND DISCLAIMER

TI PROVIDES TECHNICAL AND RELIABILITY DATA (INCLUDING DATASHEETS), DESIGN RESOURCES (INCLUDING REFERENCE DESIGNS), APPLICATION OR OTHER DESIGN ADVICE, WEB TOOLS, SAFETY INFORMATION, AND OTHER RESOURCES "AS IS" AND WITH ALL FAULTS, AND DISCLAIMS ALL WARRANTIES, EXPRESS AND IMPLIED, INCLUDING WITHOUT LIMITATION ANY IMPLIED WARRANTIES OF MERCHANTABILITY, FITNESS FOR A PARTICULAR PURPOSE OR NON-INFRINGEMENT OF THIRD PARTY INTELLECTUAL PROPERTY RIGHTS.

These resources are intended for skilled developers designing with TI products. You are solely responsible for (1) selecting the appropriate TI products for your application, (2) designing, validating and testing your application, and (3) ensuring your application meets applicable standards, and any other safety, security, or other requirements. These resources are subject to change without notice. TI grants you permission to use these resources only for development of an application that uses the TI products described in the resource. Other reproduction and display of these resources is prohibited. No license is granted to any other TI intellectual property right or to any third party intellectual property right. TI disclaims responsibility for, and you will fully indemnify TI and its representatives against, any claims, damages, costs, losses, and liabilities arising out of your use of these resources.

TI's products are provided subject to TI's Terms of Sale (www.ti.com/legal/termsofsale.html) or other applicable terms available either on ti.com or provided in conjunction with such TI products. TI's provision of these resources does not expand or otherwise alter TI's applicable warranties or warranty disclaimers for TI products.

Mailing Address: Texas Instruments, Post Office Box 655303, Dallas, Texas 75265
Copyright © 2019, Texas Instruments Incorporated