



ABSTRACT

This user's guide describes the characteristics, operation, and use of the BQ25173EVM evaluation module (EVM). This EVM is designed to help the user evaluate and test the various operating modes of the BQ25173. This user's guide includes setup instructions for the hardware, a schematic diagram, a bill of materials (BOM), and PCB layout drawings for the evaluation module.

Throughout this user's guide, the abbreviations *EVM*, *BQ25173EVM*, *BMS033-002*, and the term *evaluation module* are synonymous with the BMS033 (002) evaluation module, unless otherwise noted.

Table of Contents

1 Introduction	2
1.1 Printed Circuit Board Assembly.....	2
1.2 I/O Descriptions.....	2
2 Test Summary	3
2.1 Equipment.....	3
2.2 Cautions.....	3
2.3 Test Instructions.....	3
3 Board Layout, Schematic, and Bill of Materials	5
3.1 Board Layout.....	5
3.2 Schematic.....	8
3.3 Bill of Materials.....	9
4 Revision History	13

Trademarks

All trademarks are the property of their respective owners.



WARNING

Hot surface! Contact may cause burns. Do not touch!

Some components may reach high temperatures >55°C when the board is powered on. The user must not touch the board at any point during operation or immediately after operating, as high temperatures may be present.

1 Introduction

The Texas Instruments BQ25173 is a linear charger IC for 1- to 4-cell supercapacitor. Charging voltage can be adjusted using external resistor divider between OUT and FB. Charging current can be set from 10 mA to 800 mA with external resistor on ISET.

1.1 Printed Circuit Board Assembly

The BQ25173EVM PCB contains the BQ25173 IC, LDO TPS7B8133 and support circuits. This board contains several jumpers and connectors. R16 allows a wide range of adjustment of V_{REG} , the supercapacitor regulation voltage. R22 can be used to change ISET value, fast charge current.

1.2 I/O Descriptions

Table 1-1 lists the input and output connections available on this EVM and their respective descriptions.

Table 1-1. EVM I/O Connections

I/O Connector	Description
J1 – VIN / GND	Input voltage from external power supply. Max operating input voltage is 18V, OVP trip point. Abs max input voltage is 40V while in OVP.
J2 – OUT (BAT+) / GND (BAT-) / GND / \overline{CE}	Battery connection, charge enable pin.
JP2 – OUT / REG / IN	Source voltage for housekeeping regulator, U2. Provides pull-up voltage for digital I/O. LDO input (REG) rated up to 40V.
JP3 – \overline{PG} (Power Good) LED	Default setting is ON.
JP4 – Fixed / ISET / ADJ	Sets Fast Charge Current. Fixed=400mA ADJ= R22 range 15mA to 1A. Current setting > 860mA will trigger ISET_SHORT fault on startup. I_{OUT_OCP} trip point at 1A.
JP5 - STAT LED	Default setting is ON.
JP8 - \overline{CE}	Charge enable. Default setting is ON.

2 Test Summary

This section describes the jumpers and connectors on the EVM as well as how to properly connect, setup, and use the BQ25173EVM. Note that the default jumper setting of headers and switches are marked with two dots to indicate the shorting jumper position.

2.1 Equipment

This section includes a list of supplies required to perform tests on this EVM.

1. Battery simulator such as Keithley 2400 or equivalent. Or a 1- to 4-cell supercapacitor. Maximum recommend OUT regulation voltage is 10.5V. Abs max rating on OUT is 13V.
2. Input power supply that can supply up to 40V and 1A. Note that charging can occur between 3V to 18V input. Device is in OVP between 18V to 40V.
3. Voltage meter and current meter.

2.2 Cautions

Care must be taken to not charge the supercapacitor higher than the voltage rating specified by the manufacturer. For setting the max charging voltage refer to the [BQ25173 800-mA Linear Charger for 1- to 4-Cell Supercapacitor](#) data sheet "Supercapacitor Regulation Voltage" section.

Device will enter thermal regulation at too high an input to output voltage drop and current. Thermal regulation begins reducing current at 125 °C, at 150 °C device will shut off. For thermal calculation refer to the [BQ25173 800-mA Linear Charger for 1- to 4-Cell Supercapacitor](#) data sheet "Thermal Package" section.

Device can get hot during high input-to-output voltage drop and high current conditions. Use caution when handling the board.

2.3 Test Instructions

In order for this EVM to operate properly, the following components must be connected and properly configured.

1. Set input power supply to 5V and battery simulator to 2.7V with compliance to support 400mA. Turn off supply and battery simulator.
2. Connect input voltages to J1 and battery simulator to J2 on the EVM.
3. Configure all EVM jumpers to factory setting, refer to table below.
4. Turn on battery simulator and then adjust trimpot R16 until voltage on FB pin reads 0.8V. This sets the OUT regulation voltage to 2.7V. You can also use a power supply for this step if no battery simulator is available.
5. Lower battery simulator voltage to 2.5V.
6. Turn on input power supply
 - a. 5V Input supply current limit should be greater than 400mA
 - b. OUT voltage should be 2.5V and charge current 400mA
 - c. PG LED D1 will be ON
 - d. STAT LED D2 will be OFF
7. Raise input power supply to 20V
 - a. Charging will stop and STAT pin will flash at 1Hz.
 - b. PG LED D1 will be OFF
 - c. Lower below ~18V to clear fault
8. Simulate charge complete by increasing battery simulator voltage to 2.8V
 - a. Current will taper to 0mA.
 - b. STAT LED D2 will switch to ON.

Table 2-1. Jumper Factory Setting

I/O Connector	Factory Setting
JP2	IN
JP3	Installed
JP4	Fixed

Table 2-1. Jumper Factory Setting (continued)

I/O Connector	Factory Setting
JP5	Installed
JP8	ON

Note: IN, ON, Fixed are positions of a 3 pin header. If it is a 2 pin header then it is installed or not installed.

3 Board Layout, Schematic, and Bill of Materials

3.1 Board Layout

The board layout is shown in [Figure 3-1](#) to [Figure 3-6](#).

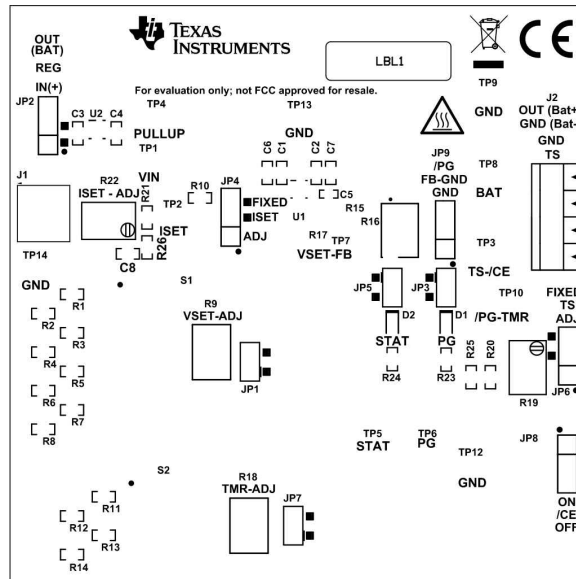

Figure 3-1. Top Overlay

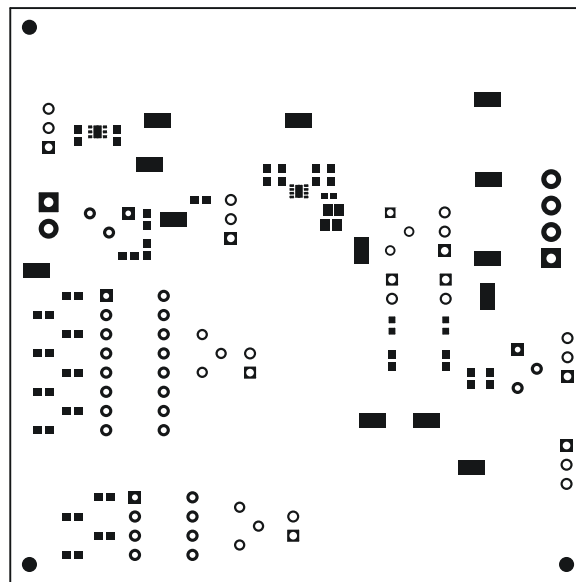

Figure 3-2. Top Solder

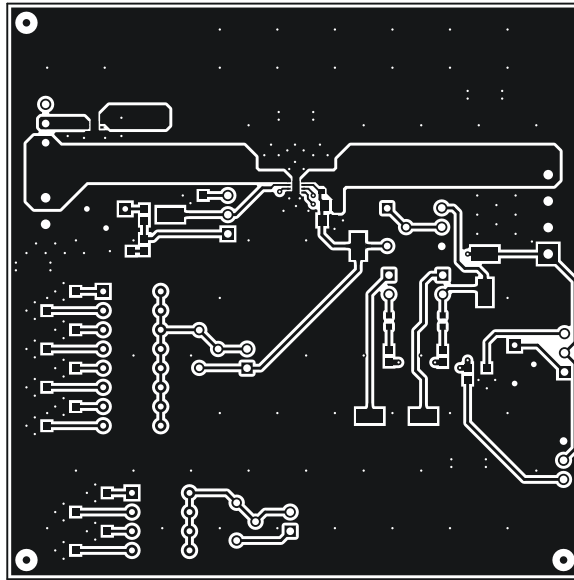

Figure 3-3. Top Layer

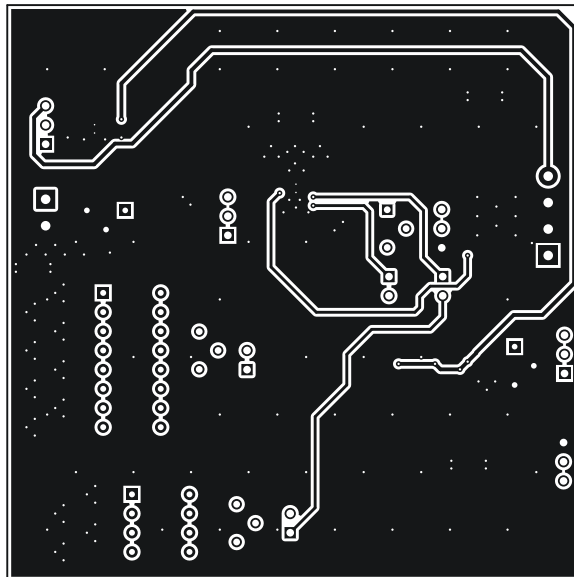

Figure 3-4. Bottom Layer

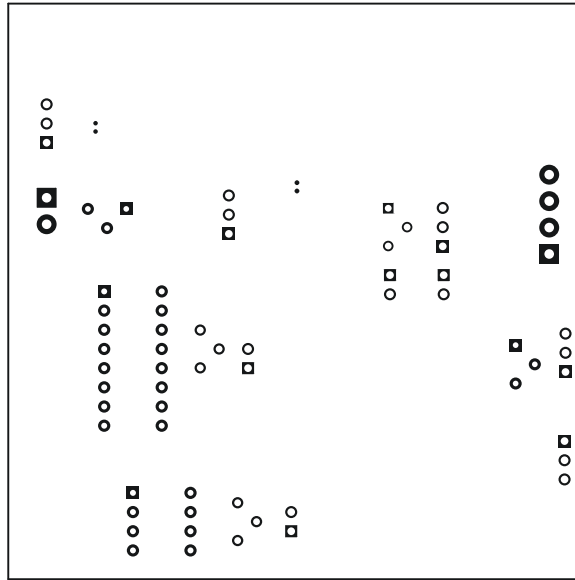

Figure 3-5. Bottom Solder

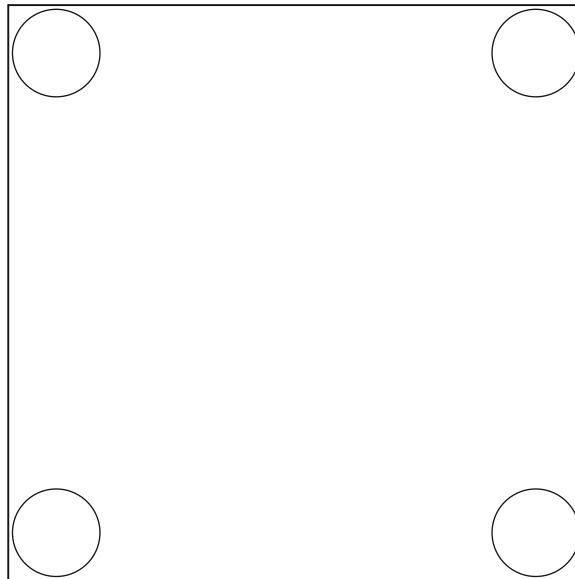

Figure 3-6. Bottom Overlay

3.2 Schematic

The BQ25173EVM schematic is shown in Figure 3-7.

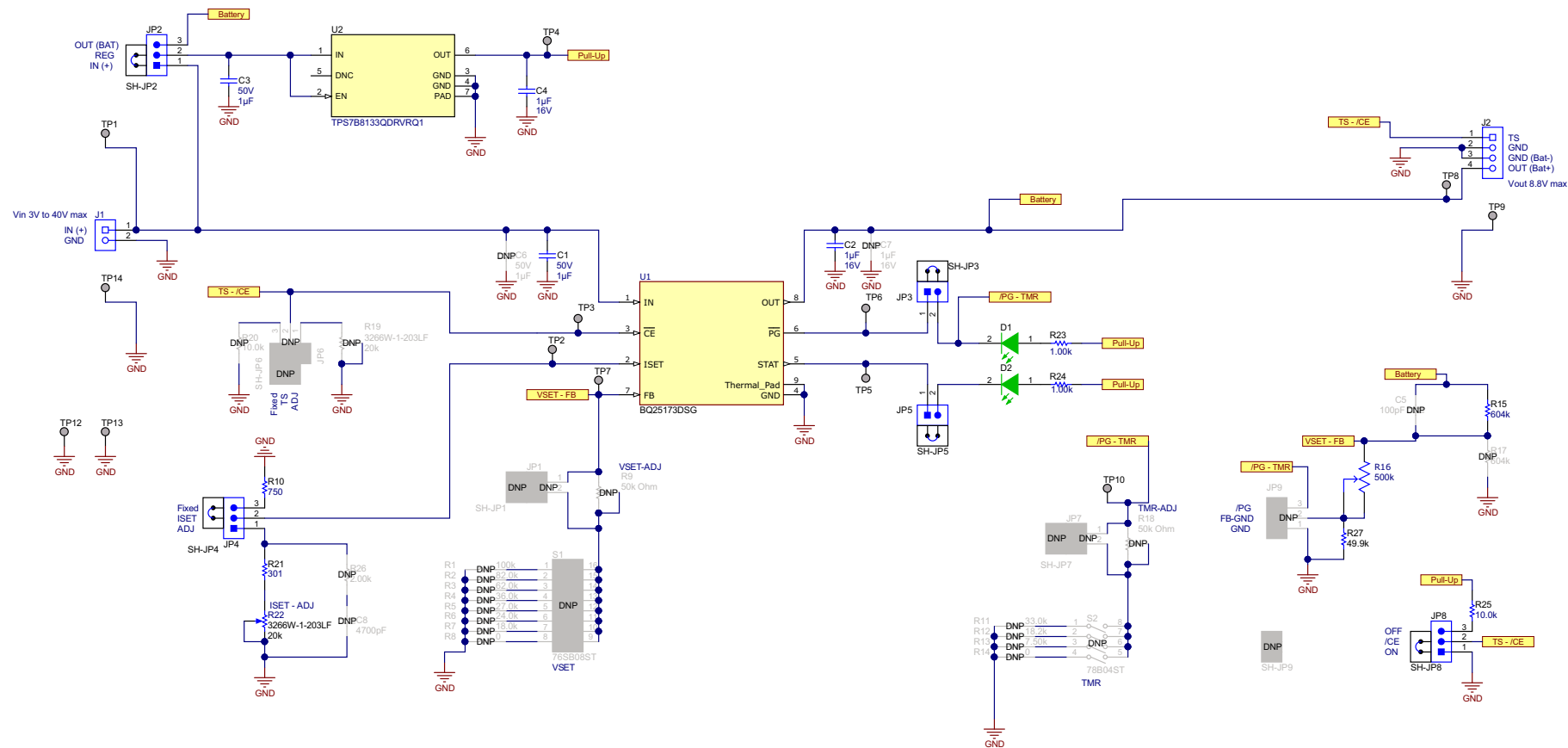

Figure 3-7. BQ25173EVM Schematic

3.3 Bill of Materials

The bill of materials is shown in the following table.

Table 3-1. Bill of Materials

Designator	Quantity	Value	Description	PackageReference	PartNumber	Manufacturer	Alternate PartNumber	Alternate Manufacturer
!PCB?	1		Printed Circuit Board		BMS033	Any		
C1, C3	2	1uF	CAP, CERM, 1 μ F, 50 V, +/- 20%, X5R, AEC-Q200 Grade 3, 0603	0603	GRT188R61H 105ME13D	MuRata		
C2, C4	2	1uF	CAP, CERM, 1 μ F, 16 V, +/- 10%, X7R, AEC-Q200 Grade 1, 0603	0603	GCM188R71 C105KA64D	MuRata		
D1, D2	2	Green	LED, Green, SMD	Body1.6x0.8 mm	LTST-C193TGKT-5 A	Lite-On		
H1, H2, H3, H4	4		Bumpon, Hemisphere, 0.44 X 0.20, Clear	Transparent Bumpon	SJ-5303 (CLEAR)	3M		
J1	1		Terminal Block, 3.5mm Pitch, 2x1, TH	7.0x8.2x6.5mm	ED555/2DS	On-Shore Technology		
J2	1		Terminal Block, 3.5mm Pitch, 4x1, TH	14x8.2x6.5mm	ED555/4DS	On-Shore Technology		
JP2, JP4, JP8	3		Header, 100mil, 3x1, Tin, TH	Header, 3 PIN, 100mil, Tin	PEC03SAAN	Sullins Connector Solutions		
JP3, JP5	2		Header, 100mil, 2x1, Tin, TH	Header, 2 PIN, 100mil, Tin	PEC02SAAN	Sullins Connector Solutions		
LBL1	1		Thermal Transfer Printable Labels, 0.650" W x 0.200" H - 10,000 per roll	PCB Label 0.650 x 0.200 inch	THT-14-423-10	Brady		
R10	1	750	RES, 750, 1%, 0.1 W, 0603	0603	RC0603FR-07750RL	Yageo		
R15	1	604k	RES, 604 k, 0.1%, 0.125 W, 0805	0805	RT0805BRD07604KL	Yageo America		

Table 3-1. Bill of Materials (continued)

Designator	Quantity	Value	Description	PackageReference	PartNumber	Manufacturer	Alternate PartNumber	Alternate Manufacturer
R16	1		500 kOhms 0.25W, 1/4W PC Pins Through Hole Trimmer Potentiometer Cermet 12 Turn Top Adjustment	PTH_3	PV37W504C0 1B00	Bourns		
R21	1	301	RES, 301, 1%, 0.1 W, AEC-Q200 Grade 0, 0603	0603	CRCW06033 01RFKEA	Vishay-Dale		
R22	1	20k	Trimmer, 20k ohm, 0.25W, TH	4.5x8x6.7mm	3266W-1-203 LF	Bourns		
R23, R24	2	1.00k	RES, 1.00 k, 1%, 0.1 W, 0603	0603	RC0603FR-0 71KL	Yageo		
R25	1	10.0k	RES, 10.0 k, 1%, 0.1 W, AEC-Q200 Grade 0, 0603	0603	CRCW06031 0K0FKEA	Vishay-Dale		
R27	1	49.9k	RES, 49.9 k, 1%, 0.25 W, Axial	Axial	CMF5049K90 0FHFB	Vishay-Dale		
SH-JP2, SH- JP3, SH-JP4, SH-JP5, SH- JP8	5	1x2	Shunt, 100mil, Gold plated, Black	Shunt	SNT-100-BK- G	Samtec	969102-0000- DA	3M
TP1, TP2, TP3, TP4, TP5, TP6, TP7, TP8, TP9, TP10, TP12, TP13, TP14	13		Test Lead clips and hooks, SMT	Test Point, Body 3.25x1.65mm	S1751-46	Harwin		
U1	1		800-mA Linear Charger for 1- to 4-Cell Super Capacitor	WSON8	BQ25173DS G	Texas Instruments		

Table 3-1. Bill of Materials (continued)

Designator	Quantity	Value	Description	PackageReference	PartNumber	Manufacturer	Alternate PartNumber	Alternate Manufacturer
U2	1		Automotive 150-mA high-voltage ultra-low-IQ low-dropout (LDO) linear regulator, DRV0006A (WSON-6)	DRV0006A	TPS7B8133Q DRVQR1	Texas Instruments		Texas Instruments
C5	0	100pF	CAP, CERM, 100 pF, 50 V, +/- 1%, C0G/NP0, 0402	0402	04025A101FA T2A	AVX		
C6	0	1uF	CAP, CERM, 1 µF, 50 V, +/- 20%, X5R, AEC-Q200 Grade 3, 0603	0603	GRT188R61H 105ME13D	MuRata		
C7	0	1uF	CAP, CERM, 1 µF, 16 V, +/- 10%, X7R, AEC-Q200 Grade 1, 0603	0603	GCM188R71 C105KA64D	MuRata		
C8	0	4700pF	CAP, CERM, 4700 pF, 50 V, +/- 10%, X5R, 0603	0603	GRM188R61 H472KA01D	MuRata		
FID1, FID2, FID3	0		Fiducial mark. There is nothing to buy or mount.	N/A	N/A	N/A		
JP1, JP7	0		Header, 100mil, 2x1, Tin, TH	Header, 2 PIN, 100mil, Tin	PEC02SAAN	Sullins Connector Solutions		
JP6, JP9	0		Header, 100mil, 3x1, Tin, TH	Header, 3 PIN, 100mil, Tin	PEC03SAAN	Sullins Connector Solutions		
R1	0	100k	RES, 100 k, 1%, 0.1 W, 0603	0603	RC0603FR-0 7100KL	Yageo		
R2	0	82.0k	RES, 82.0 k, 1%, 0.1 W, 0603	0603	RC0603FR-0 782KL	Yageo		
R3	0	62.0k	RES, 62.0 k, 1%, 0.1 W, 0603	0603	RC0603FR-0 762KL	Yageo		

Table 3-1. Bill of Materials (continued)

Designator	Quantity	Value	Description	PackageReference	PartNumber	Manufacturer	Alternate PartNumber	Alternate Manufacturer
R4	0	36.0k	RES, 36.0 k, 1%, 0.1 W, 0603	0603	RC0603FR-0 736KL	Yageo		
R5	0	27.0k	RES, 27.0 k, 1%, 0.1 W, 0603	0603	RC0603FR-0 727KL	Yageo		
R6	0	24.0k	RES, 24.0 k, 1%, 0.1 W, 0603	0603	RC0603FR-0 724KL	Yageo		
R7	0	18.0k	RES, 18.0 k, 1%, 0.1 W, 0603	0603	RC0603FR-0 718KL	Yageo		
R8, R14	0	0	RES, 0, 5%, 0.1 W, 0603	0603	RC0603JR-07 0RL	Yageo		
R9, R18	0	50k Ohm	Trimmer Potentiometer , Lead Sealed Type Multiturn PV37 Series, TH	6.71x4.5mm	PV37W503C0 1B00	Bourns		
R11	0	33.0k	RES, 33.0 k, 1%, 0.1 W, 0603	0603	RC0603FR-0 733KL	Yageo		
R12	0	18.2k	RES, 18.2 k, 1%, 0.1 W, 0603	0603	RC0603FR-0 718K2L	Yageo		
R13	0	7.50k	RES, 7.50 k, 1%, 0.1 W, 0603	0603	RC0603FR-0 77K5L	Yageo		
R17	0	604k	RES, 604 k, 0.1%, 0.125 W, 0805	0805	RT0805BRD0 7604KL	Yageo America		
R19	0	20k	Trimmer, 20k ohm, 0.25W, TH	4.5x8x6.7mm	3266W-1-203 LF	Bourns		
R20	0	10.0k	RES, 10.0 k, 1%, 0.1 W, AEC-Q200 Grade 0, 0603	0603	CRCW06031 0K0FKEA	Vishay-Dale		
R26	0	2.00k	RES, 2.00 k, 1%, 0.1 W, AEC-Q200 Grade 0, 0603	0603	CRCW06032 K00FKEA	Vishay-Dale		
S1	0		Switch, SPST 8Pos, Rocker, TH	9.65X8X22.4 mm	76SB08ST	Grayhill		

Table 3-1. Bill of Materials (continued)

Designator	Quantity	Value	Description	PackageReference	PartNumber	Manufacturer	Alternate PartNumber	Alternate Manufacturer
S2	0		DIP Switch, SPST 4Pos, Slide, TH	DIP Switch, 4 Pos	78B04ST	Grayhill		
SH-JP1, SH-JP6, SH-JP7, SH-JP9	0	1x2	Shunt, 100mil, Gold plated, Black	Shunt	SNT-100-BK-G	Samtec	969102-0000-DA	3M

Unless otherwise noted in the Alternate PartNumber and/or Alternate Manufacturer columns, all parts may be substituted with equivalents.

4 Revision History

DATE	REVISION	NOTES
November 2021	*	Initial Release

IMPORTANT NOTICE AND DISCLAIMER

TI PROVIDES TECHNICAL AND RELIABILITY DATA (INCLUDING DATA SHEETS), DESIGN RESOURCES (INCLUDING REFERENCE DESIGNS), APPLICATION OR OTHER DESIGN ADVICE, WEB TOOLS, SAFETY INFORMATION, AND OTHER RESOURCES "AS IS" AND WITH ALL FAULTS, AND DISCLAIMS ALL WARRANTIES, EXPRESS AND IMPLIED, INCLUDING WITHOUT LIMITATION ANY IMPLIED WARRANTIES OF MERCHANTABILITY, FITNESS FOR A PARTICULAR PURPOSE OR NON-INFRINGEMENT OF THIRD PARTY INTELLECTUAL PROPERTY RIGHTS.

These resources are intended for skilled developers designing with TI products. You are solely responsible for (1) selecting the appropriate TI products for your application, (2) designing, validating and testing your application, and (3) ensuring your application meets applicable standards, and any other safety, security, regulatory or other requirements.

These resources are subject to change without notice. TI grants you permission to use these resources only for development of an application that uses the TI products described in the resource. Other reproduction and display of these resources is prohibited. No license is granted to any other TI intellectual property right or to any third party intellectual property right. TI disclaims responsibility for, and you will fully indemnify TI and its representatives against, any claims, damages, costs, losses, and liabilities arising out of your use of these resources.

TI's products are provided subject to [TI's Terms of Sale](#) or other applicable terms available either on ti.com or provided in conjunction with such TI products. TI's provision of these resources does not expand or otherwise alter TI's applicable warranties or warranty disclaimers for TI products.

TI objects to and rejects any additional or different terms you may have proposed.

Mailing Address: Texas Instruments, Post Office Box 655303, Dallas, Texas 75265
Copyright © 2022, Texas Instruments Incorporated