



ABSTRACT

This report discusses the results of the total ionizing dose (TID) testing for the Texas Instruments TPS7H6003-SP radiation hardness-assured 1.3-A, 2.5-A, half bridge gate driver. The study was done to determine TID effects at 100 krad(Si) High Dose Rate (HDR). The results show that all samples pass within device specified test limits.

Table of Contents

1 Device Information	2
1.1 Product Description.....	2
1.2 Device Details.....	2
2 Total Dose Test Setup	3
2.1 Test Overview.....	3
2.2 Test Description and Facilities.....	3
2.3 Test Setup Details.....	3
2.4 Test Configuration and Condition.....	5
3 TID Characterization Test Results	6
3.1 TID Characterization Results Summary.....	6
3.2 Data Sheet Electrical Parameters.....	6
4 Applicable and Reference Documents	10
4.1 Applicable Documents.....	10
4.2 Reference Documents.....	10
A Appendix: HDR TID Report	11

Trademarks

All trademarks are the property of their respective owners.

1 Device Information

1.1 Product Description

The TPS7H6003-SP is a 200-V radiation-hardness-assured, high voltage gate driver for GaN FETs for space applications. The TPS7H6003-SP is designed for high frequency, high efficiency applications. The driver features adjustable dead time capability, small 30-ns propagation delay and 5.5-ns high-side and low-side matching. This part also includes internal high-side and low-side LDOs which specifies a drive voltage of 5 V regardless of supply voltage. The TPS7H6003-SP is packaged in a ceramic 48-HBX (CFP) package.

1.2 Device Details

Testing was performed per MIL-STD-883, Test Method 1019, with a sample size per MIL-PRF-38535, Appendix C, test condition A (high dose rate).

Table 1-1. Device and Exposure Details

RHA TID Details: up to 100 krad(Si)	
TI Part Number	TPS7H6003-SP
Orderable Number	5962R2220101VXC
Device function	Half Bridge Gate Driver
Die Name	RTPS7H6003A0VM
Package	48-pin CFP (HBX)
Technology	LBC7 (250-nm Linear BiCMOS)
Quantity tested	HDR : <ul style="list-style-type: none"> • Five biased and five unbiased units at 3-krad(Si) levels • Five biased and five unbiased units at 10-krad(Si) levels • Five biased and five unbiased units at 30-krad(Si) levels • Five biased and five unbiased units at 50-krad(Si) levels • Five biased and five unbiased units at 100-krad(Si) levels • One correlation unit
Lot Accept/Reject	Passes 100 krad(Si), no observed fails
HDR radiation facility	Texas Instruments CLAB Dallas, Texas
Die Lot Number and Assembly Lot Number	2349610T11-18 / 3008205 MTT
HDR Dose Rate	194.3 rad(Si) / s
HDR Radiation Source	Gammacell 220 Excel (GC-220E) Co-60
Irradiation and Test Temperature	Ambient, room temperature controlled to 25°C ±6°C per MIL-STD-883 and MIL-STD-750

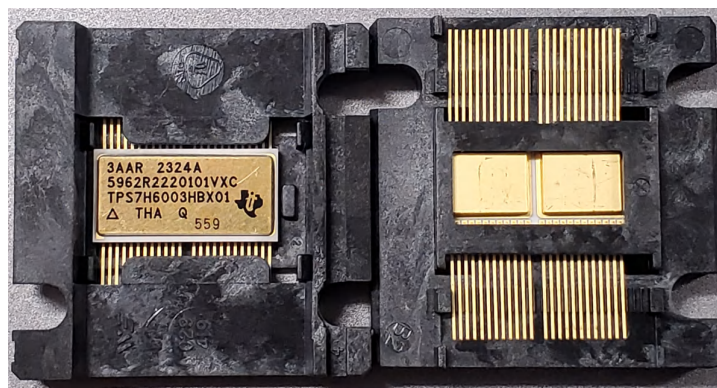

Figure 1-1. TPS7H6003-SP Device Used in Exposure

2 Total Dose Test Setup

2.1 Test Overview

The TPS7H6003-SP was tested according to MIL-STD-883, Test Method 1019.9. For this testing, conditions A and D were used. For this test, the product was irradiated up to the target radiation level, and then put through full electrical parametric testing on the production Automated Test Equipment (ATE). All devices remained functional passing all parametric test limits.

2.2 Test Description and Facilities

The TPS7H6003-SP HDR exposure was performed on biased devices in a Co-60 gammacell at the TI Dallas C-Lab facility in Dallas, Texas. The un-attenuated dose rate of this cell is 194.3 rad(Si) / s. After exposure, the devices were packed in dry ice (per MIL-STD-883 Method 1019.9 section 3.10) and post-radiation electrical testing at TI's Dallas Forest Lane facility. Test limit guard bands are set within SMD electrical test limits. Post-radiation measurements were taken within 30 minutes after removing device from the dry ice container. The devices were allowed to reach room temperature prior to electrical post-radiation measurements.

2.3 Test Setup Details

The devices under HDR exposure were tested in two conditions, biased and unbiased, as described in the following sections.

2.3.1 Unbiased

For the unbiased HDR conditions, the exposure was performed with all pins grounded.

2.3.2 Biased

Figure 2-2 and Figure 2-3 show HDR bias diagram & schematic.

Table 2-1. DUT Power Supply Bias and Vout measurements

Power Supply Bias				
	Edge Connector	BUS	Typical	Comments
Power Supply	BUS A	VIN	14VDC	14VDC - Fixed power supply
	BUS D	BOOT	14VDC	14VDCWRTSW - Floating power supply WRT to SW
	BUS B	ASW	0-150 V	Increase HV gradually. Recommend using safety interlock HV protection when working with high voltage.
DUT Vout Measurements				
VOUT Test Points	TP_PGOOD	ON	5 V	LS is ON
	TP_LO	PWM_LI	1.8 V	PWM mode
	TP_HO	PWM_LI DC WRT ASW	3.51 V	PWM mode
	TP_SW	SW = PSW = ASW	0-150 V	SW = PSW = ASW
	PWM_LI	DUT Mon	1.85 V	DUT monitor edge connector.

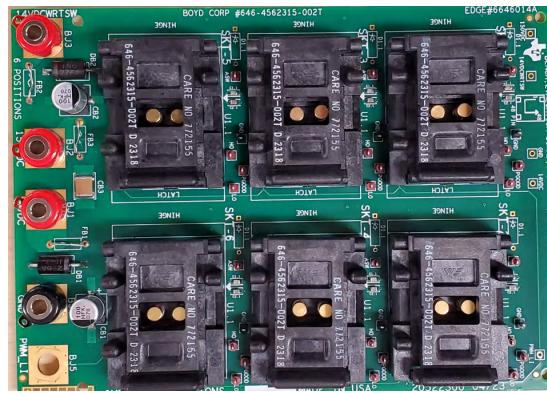

Figure 2-1. HDR TID Hardware

High-side Gate Driver

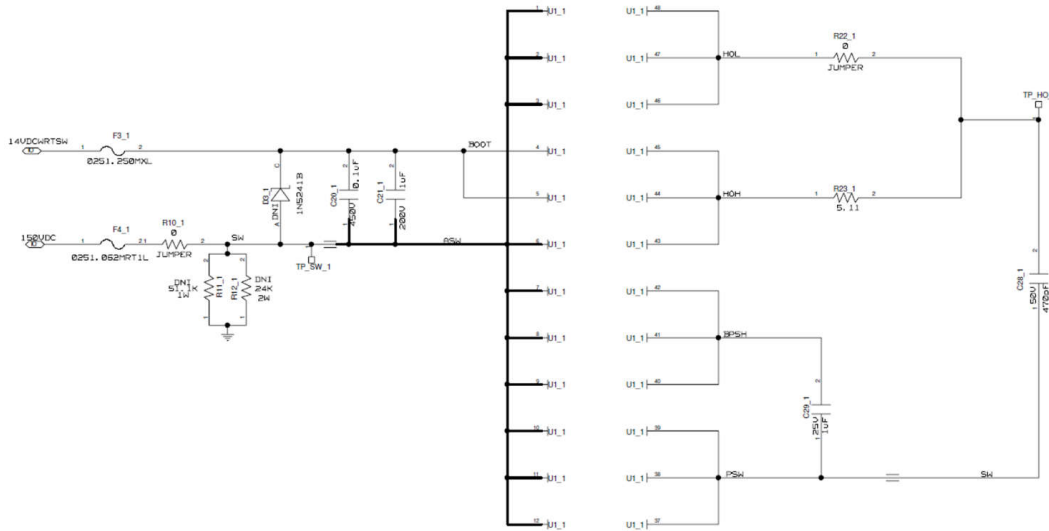

Figure 2-2. High-Side TID Bias Diagram

Low-side Gate Driver

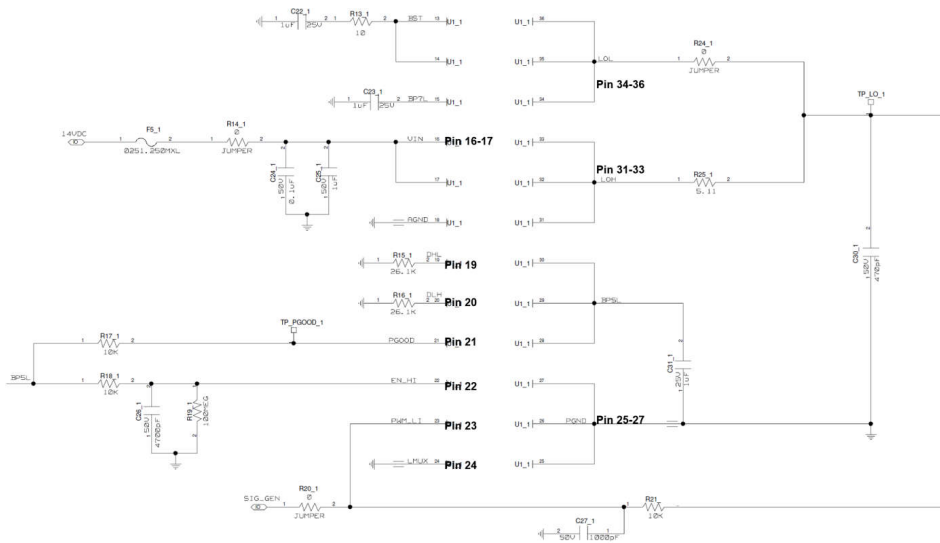

Figure 2-3. Low-Side TID Bias Diagram

2.4 Test Configuration and Condition

HDR devices were stressed up to 100 krad(Si) for biased and unbiased conditions.

Table 2-2. HDR Biased Device Information

Total Samples: 25 units + 1 control				
Exposure Levels:				
3 krad(Si)	10 krad(Si)	30 krad(Si)	50 krad(Si)	100 krad(Si)
134, 137, 138, 139, 236	237, 241, 242, 243, 244	132, 133, 135, 245, 246	172, 173, 174, 183, 186	178, 179, 180, 181, 182

Table 2-3. HDR Unbiased Device Information

Total Samples: 25 units + 1 control				
Exposure Levels:				
3 krad(Si)	10 krad(Si)	30 krad(Si)	50 krad(Si)	100 krad(Si)
58, 59, 60, 61, 62	63, 64, 65, 66, 150	141, 144, 145, 146, 147	67, 68, 69, 71, 72	95, 102, 104, 105, 106

3 TID Characterization Test Results

3.1 TID Characterization Results Summary

The results show that all TPS7H6003-SP devices were fully functional and within specification limits up to 100 krad(Si) HDR. Overall the TPS7H6003-SP show a strong degree of hardness to TID HDR exposure levels at 100 krad(Si) under bias & unbiased conditions. Performance is measured based on the difference between pre- and post-irradiation with respect to SMD electrical minimum and maximum specification. The measurements taken post-irradiation for each sample set showed a marginal shift for most parameters at each dose level for both biased and unbiased. (see [Section 3.2](#) for the electrical parameters). Note that test numbers are listed only for parameters tested post-TID.

See [Appendix A](#) for HDR report.

3.2 Data Sheet Electrical Parameters

Specifications are at ambient temperature $T_A = 25^\circ\text{C}$, $V_{IN} = 10\text{ V to }14\text{ V}$, $V_{BP5L} = V_{BP5H} = 5\text{ V}$, and no load on LOH, LOL, HOH, and HOL (unless otherwise noted).

Table 3-1. TPS7H6003-SP Data Sheet Electrical Parameters

Parameter	Test Conditions	MIN	MAX	UNIT	Test Number	
SUPPLY CURRENTS						
I_{QLS}	Low-side quiescent current	$V_{IN} = 12\text{ V}$, $BOOT = 10\text{ V}$	MODE = PWM, EN = 0 V	6.8	mA	35.0, 36.0, 37.0
			MODE = IIM, LI = HI = 0 V	8		35.2, 36.2, 37.2
I_{QHS}	High-side quiescent current	$V_{IN} = 12\text{ V}$, $BOOT = 10\text{ V}$	MODE = PWM, EN = 0 V	6.3	mA	35.1, 36.1, 37.1
			MODE = IIM, LI = HI = 0 V	6.3		35.3, 36.3, 37.3
I_{OP_LS}	Low-side operating current	MODE = PWM, no load for HOL and HOH	f = 500 kHz	9	mA	35.6, 36.6, 37.6
			f = 1 MHz	11		35.8, 36.8, 37.8
			f = 2 MHz	16		35.10, 36.10, 37.10
			f = 5 MHz	30		35.12, 36.12, 37.12
		MODE = IIM, no load for HOL and HOH	f = 500 kHz	9		35.14, 36.14, 37.14
			f = 1 MHz	12		35.16, 36.16, 37.16
			f = 2 MHz	17		35.18, 36.18, 37.18
			f = 5 MHz	30		35.20, 36.20, 37.20
I_{OP_HS}	High-side operating current	MODE = PWM, no load for HOL and HOH	f = 500 kHz	6.5	mA	35.7, 36.7, 37.7
			f = 1 MHz	8		35.9, 36.9, 37.9
			f = 2 MHz	10.5		35.11, 36.11, 37.11
			f = 5 MHz	17.5		35.13, 36.13, 37.13
		MODE = IIM, no load for HOL and HOH	f = 500 kHz	6.5		35.15, 36.15, 37.15
			f = 1 MHz	8		35.17, 36.17, 37.17
			f = 2 MHz	10.5		35.19, 36.19, 37.19
			f = 5 MHz	15		35.21, 36.21, 37.21
GATE DRIVER						
V_{OL}	Low-level output voltage	$I_{OL} = 100\text{ mA}$		0.15	V	45.0, 46.0, 47.0

Table 3-1. TPS7H6003-SP Data Sheet Electrical Parameters (continued)

Parameter		Test Conditions	MIN	MAX	UNIT	Test Number
BP5x – V _{OH}	High-level output voltage	I _{OH} = 100 mA		0.3	V	45.2, 46.2, 47.2
I _{OH}	Peak source current	H _{OH} , L _{OH} = 0 V, BP5x = 5 V	0.7	2.3	A	50.0, 50.1, 51.0, 51.1, 52.0, 52.1
I _{OL}	Peak sink current	H _{OL} , L _{OL} = 5 V, BP5x = 5 V	1.6	4.6	A	50.2, 51.2, 52.2
INTERNAL REGULATORS						
V _{BP5L}	Low-side 5-V regulator output voltage	C _{BP5L} = 1 µF	4.75	5.175	V	60.1, 60.4, 60.7, 60.10, 60.13, 60.16, 60.19, 60.22, 61.1, 61.4, 61.7, 61.10, 61.13, 61.16, 61.19, 61.22, 62.1, 62.4, 62.7, 62.10, 62.13, 62.16, 62.19, 62.22
V _{BP5H}	High-side 5-V regulator output voltage	C _{BP5H} = 1 µF	4.75	5.175	V	60.2, 60.5, 60.8, 60.11, 60.14, 60.17, 60.20, 60.23, 61.2, 61.5, 61.8, 61.11, 61.14, 61.17, 61.20, 61.23, 62.2, 62.5, 62.8, 62.11, 62.14, 62.17, 62.20, 62.23
V _{BP7L}	7-V regulator output voltage	C _{BP7L} = 1 µF	6.65	7.35	V	60.0, 60.3, 60.6, 60.9, 60.12, 60.15, 60.18, 60.21, 61.0, 61.3, 61.6, 61.9, 61.12, 61.15, 61.18, 61.21, 61.23, 62.0, 62.3, 62.6, 62.9, 62.12, 62.15, 62.18, 62.21
UNDERVOLTAGE PROTECTION						
BP5H _R	BP5H UVLO rising threshold	C _{BP5H} = 1 µF	4	4.5	V	85.1, 86.1, 87.1 ⁽¹⁾
BP5H _F	BP5H UVLO falling threshold	C _{BP5H} = 1 µF	3.8	4.3	V	85.2, 86.2, 87.2 ⁽¹⁾
BP5L _R	BP5L UVLO rising threshold	C _{BP5L} = 1 µF	4	4.5	V	80.1, 81.1, 82.1 ⁽¹⁾
BP5L _F	BP5L UVLO falling threshold	C _{BP5L} = 1 µF	3.8	4.3	V	80.2, 81.2, 82.2 ⁽¹⁾
BP7L _R	BP7L UVLO rising threshold	C _{BP7L} = 1 µF	6.2	6.8	V	80.4, 81.4, 82.4 ⁽¹⁾
BP7L _F	BP7L UVLO falling threshold	C _{BP7L} = 1 µF	5.9	6.5	V	80.5, 81.5, 82.5 ⁽¹⁾
VIN _R	VIN UVLO rising threshold		8	9	V	70
VIN _F	VIN UVLO falling threshold		7.5	8.5	V	70.1
BOOT _R	BOOT UVLO rising threshold		6.6	7.4	V	75
BOOT _F	BOOT UVLO falling threshold		6.2	7	V	75.1
INPUT PINS						
V _{IR}	Input rising edge threshold		1.80	2.65	V	90.0, 91.0, 92.0, 90.3, 91.3, 92.3

Table 3-1. TPS7H6003-SP Data Sheet Electrical Parameters (continued)

Parameter		Test Conditions	MIN	MAX	UNIT	Test Number	
V _{IF}	Input falling edge threshold		1.15	1.85	V	90.1, 91.1, 92.1, 90.4, 91.4, 92.4	
R _{PD}	Input pull-down resistance	V = 2.15 V applied at input (EN_HI or PWM_LI)	100	400	kΩ	90.6, 90.7, 91.6, 91.7, 92.6, 92.7	
PROGRAMMABLE DEAD TIME							
T _{DLH}	LO off to HO on dead time	MODE = PWM, LO falling to HO rising (90% to 10%), f ≤ 2 MHz	RLH = 3.32 kΩ	0	10	ns	95.0, 95.5, 95.10, 96.0, 96.5, 96.10, 97.0, 97.5, 97.10
			RLH = 11.8 kΩ	8	15.5		95.1, 95.6, 95.11, 96.1, 96.6, 96.11, 97.1, 97.6, 97.11
			RLH = 21 kΩ	15.5	24		95.2, 95.7, 95.12, 96.2, 96.7, 96.12, 97.2, 97.7, 97.12
			RLH = 52.3 kΩ	36	59		95.3, 95.8, 95.13, 96.3, 96.8, 96.13, 97.3, 97.8, 97.13
			RLH = 105 kΩ	74	113.5		95.4, 95.9, 95.14, 96.4, 96.9, 96.14, 97.4, 97.9, 97.14
T _{DHL}	HO off to LO on dead time	MODE = PWM, HO falling to LO rising (90% to 10%), f ≤ 2 MHz	RHL = 7.87 kΩ	0	10	ns	95.19, 95.24, 95.29, 96.19, 96.24, 96.29, 97.19, 97.24, 97.29
			RHL = 13.3 kΩ	6	15		95.20, 95.25, 95.30, 96.20, 96.25, 96.30, 97.20, 97.25, 97.30
			RHL = 23.7 kΩ	16	24.5		95.21, 95.26, 95.31, 96.21, 96.26, 96.31, 97.21, 97.26, 97.31
			RHL = 57.6 kΩ	44	61		95.22, 95.27, 95.32, 96.22, 96.27, 96.32, 97.22, 97.27, 97.32
			RHL = 113 kΩ	86	125		95.23, 95.28, 95.33, 96.23, 96.28, 96.33, 97.23, 97.28, 97.33
BOOTSTRAP DIODE SWITCH							
	Bootstrap diode switch parallel resistance	I _{BST_SW} = 1 mA	0.8	1.2	kΩ	100.1, 101.1, 102.1	
POWER GOOD							
	Logic-low output	I _{FLT} = 1 mA		0.4	V	105.0, 106.0, 107.0	
	PGOOD internal resistance	BP5L = 5 V, BP7L = 7 V, VIN = 12 V	0.7	1.9	MΩ	105.2, 106.2, 107.2	
	Minimum BP5L voltage for valid PGOOD output			2.45	V	105.1, 106.1, 107.1	

(1) Tests are only tested in production or SPI Test Mode.

Table 3-2. TPS7H6003-SP Switching Characteristics

Parameter		Test Conditions		MIN	MAX	UNIT	Test Number
t _{LPHL}	LO turnoff propagation delay	MODE = PWM	PWM rising to LOL falling		48	ns	110.0, 111.0, 112.0
		MODE = IIM	LI falling to LOL falling		38	ns	110.3, 110.7, 111.3, 111.7, 112.3, 112.7
t _{LPLH}	LO turnon propagation delay	MODE = IIM	LI rising to LOH rising		38	ns	110.2, 110.6, 111.2, 111.6, 112.2, 112.6
t _{HPHL}	HO turnoff propagation delay	MODE = PWM	PWM falling to HOL falling		50	ns	110.1, 111.1, 112.1
		MODE = IIM	HI falling to HOL falling		40		110.5, 110.9, 111.5, 111.9, 112.5, 112.9
t _{HPLH}	HO turnon propagation delay	MODE = IIM	HI rising to HOH rising		40	ns	110.4, 110.8, 111.4, 111.8, 112.4, 112.8
t _{MON}	Delay matching LO on and HO off	MODE = IIM			12	ns	110.1, 111.1, 112.1, 110.12, 111.12, 112.12
t _{MOFF}	Delay matching LO off and HO on	MODE = IIM			4	ns	110.11, 110.13, 111.11, 111.13, 112.11, 112.13
t _{HRC}	HO rise time	C _L = 1000 pF	10% to 90%		7.5	ns	115, 116, 117
t _{LRC}	LO rise time				7.5	ns	115.2, 116.2, 117.2
t _{HFC}	HO fall time		90% to 10%		5.5	ns	115.1, 116.1, 117.1
t _{LFC}	LO fall time				5.5	ns	115.3, 116.3, 117.3
t _{PW_IIM}	Minimum input pulse width (turn-on)	MODE = IIM			8	ns	120, 120.2, 120.4, 121, 121.2, 121.4, 122, 122.2, 122.4
t _{PW_IIM_OFF}	Minimum input pulse width (turn-off)	MODE = IIM			12	ns	120.1, 120.3, 120.5, 121.1, 121.3, 121.5, 122.1, 122.3, 122.5

4 Applicable and Reference Documents

4.1 Applicable Documents

- Texas Instruments, [TPS7H6003-SP Radiation-Hardness-Assured 200-V, 1.3-A, 2.5-A, Half-Bridge GaN FET Gate Driver](#), data sheet.
- Texas Instruments, [TPS7H6003EVM-CVAL Evaluation Module user's guide](#), EVM user's guide.
- Texas Instruments, [TPS7H6003-SP Single-Event Effects \(SEE\) Report](#), radiation report.

4.2 Reference Documents

Texas Instruments total ionizing dose radiation (total dose) test procedure follows the standards put forth in MIL-STD-883 TM 1019. The document can be found at the DLA website.

A Appendix: HDR TID Report

This appendix provides the TPS7H6003-SP HDR TID report data.

TID HDR Report
TPS7H6003-SP (5962R2220101VXC)

35.0 Iq LS VIN PWM VIN_10V		
Test Site	DAL-FL	DAL-FL
Tester	ETS364	ETS364
Test Number	EB672302	EB672302
Unit	mA	mA
Max Limit	6.8	6.8
Min Limit	1	1

krad(Si)	Serial #	pre_short (rtp)	(2)ST_Combo (rpt)	Delta
0	Ctrl	4.189	4.189	0.000
3	58	4.280	4.287	0.007
3	59	4.225	4.234	0.009
3	60	4.209	4.221	0.012
3	61	4.240	4.256	0.016
3	62	4.251	4.238	-0.013
3	134	4.169	4.359	0.190
3	137	4.194	4.361	0.167
3	138	4.220	4.348	0.128
3	139	4.441	4.431	-0.010
3	236	4.227	4.417	0.190
10	63	4.394	4.411	0.017
10	64	4.357	4.368	0.011
10	65	4.269	4.280	0.011
10	66	4.136	4.148	0.012
10	150	4.274	4.269	-0.005
10	237	4.321	4.411	0.091
10	241	4.455	4.356	-0.099
10	242	4.259	4.269	0.010
10	243	4.256	4.269	0.013
10	244	4.481	4.449	-0.032
30	141	4.285	4.365	0.080
30	144	4.207	4.291	0.083
30	145	4.380	4.463	0.083
30	146	4.327	4.393	0.066
30	147	4.396	4.460	0.064
30	132	4.203	4.280	0.077
30	133	4.429	4.536	0.107
30	135	4.459	4.238	-0.222
30	245	4.231	4.322	0.091
30	246	4.339	4.406	0.067
50	67	4.355	4.495	0.140
50	68	4.142	4.447	0.305
50	69	4.325	4.459	0.134
50	71	4.256	4.435	0.179
50	72	4.246	4.403	0.156
50	172	4.428	4.595	0.167
50	173	4.229	4.310	0.081
50	174	4.123	4.284	0.160
50	183	4.202	4.335	0.133
50	186	4.308	4.452	0.144
100	95	4.313	4.594	0.280
100	102	4.248	4.487	0.239
100	104	4.254	4.543	0.289
100	105	4.240	4.489	0.248
100	106	4.317	4.489	0.173
100	178	4.350	4.599	0.249
100	179	4.284	4.480	0.196
100	180	4.266	4.503	0.237
100	181	4.141	4.426	0.285
100	182	4.208	4.488	0.281
	Max	4.481	4.599	0.305
	Average	4.281	4.385	0.104
	Min	4.123	4.148	-0.222
	Std Dev	0.090	0.110	0.110

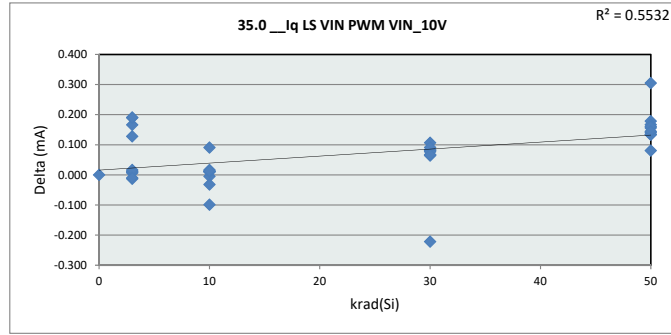

35.0 Iq LS VIN PWM VIN_10V						
Test Site	DAL-FL					
Tester	ETS364					
Test Number	EB672302					
Max Limit	6.8 mA					
Min Limit	1 mA					
krad(Si)	0	3	10	30	50	100
LL	1.000	1.000	1.000	1.000	1.000	1.000
Min	4.189	4.221	4.148	4.238	4.284	4.426
Average	4.189	4.315	4.323	4.375	4.421	4.510
Max	4.189	4.431	4.449	4.536	4.595	4.599
UL	6.800	6.800	6.800	6.800	6.800	6.800

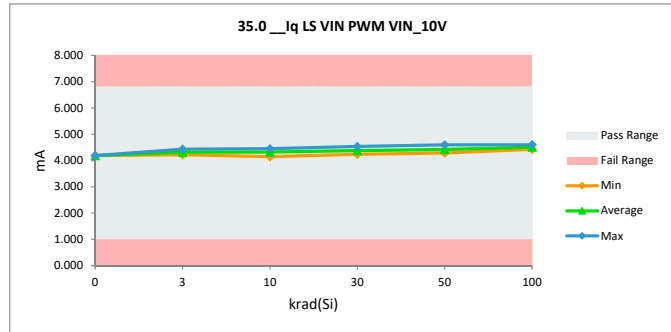

TID HDR Report
TPS7H6003-SP (5962R2220101VXC)

35.1 Iq HS BOOT PWM VIN_10V		
Test Site	DAL-FL	DAL-FL
Tester	ETS364	ETS364
Test Number	EB672302	EB672302
Unit	mA	mA
Max Limit	6.3	6.3
Min Limit	1	1

krad(Si)	Serial #	pre_short (rtp)	(2)ST_Combo (rpt)	Delta
0	Ctrl	3.564	3.564	0.000
3	58	3.549	3.562	0.013
3	59	3.638	3.626	-0.012
3	60	3.532	3.546	0.015
3	61	3.548	3.547	-0.001
3	62	3.558	3.548	-0.010
3	134	3.607	3.632	0.025
3	137	3.666	3.633	-0.033
3	138	3.658	3.618	-0.040
3	139	3.771	3.751	-0.020
3	236	3.617	3.839	0.222
10	63	3.651	3.674	0.023
10	64	3.655	3.656	0.000
10	65	3.586	3.593	0.007
10	66	3.567	3.586	0.019
10	150	3.690	3.685	-0.004
10	237	3.705	3.830	0.125
10	241	3.636	3.628	-0.008
10	242	3.615	3.613	-0.002
10	243	3.580	3.579	-0.001
10	244	3.647	3.633	-0.014
30	141	3.708	3.793	0.085
30	144	3.572	3.647	0.075
30	145	3.687	3.719	0.032
30	146	3.599	3.679	0.080
30	147	3.713	3.778	0.065
30	132	3.486	3.548	0.062
30	133	3.708	3.798	0.090
30	135	3.713	3.533	-0.180
30	245	3.738	3.812	0.074
30	246	3.722	3.821	0.098
50	67	3.670	3.778	0.108
50	68	3.579	3.858	0.279
50	69	3.651	3.770	0.119
50	71	3.548	3.689	0.141
50	72	3.724	3.843	0.120
50	172	3.687	3.796	0.109
50	173	3.596	3.736	0.140
50	174	3.717	3.847	0.131
50	183	3.599	3.767	0.169
50	186	3.571	3.709	0.139
100	95	3.665	3.859	0.194
100	102	3.500	3.678	0.177
100	104	3.554	3.788	0.233
100	105	3.591	3.805	0.213
100	106	3.550	3.741	0.191
100	178	3.766	4.022	0.256
100	179	3.612	3.866	0.253
100	180	3.584	3.778	0.193
100	181	3.604	3.844	0.240
100	182	3.616	3.867	0.251
	Max	3.771	4.022	0.279
	Average	3.629	3.716	0.087
	Min	3.486	3.533	-0.180
	Std Dev	0.069	0.114	0.099

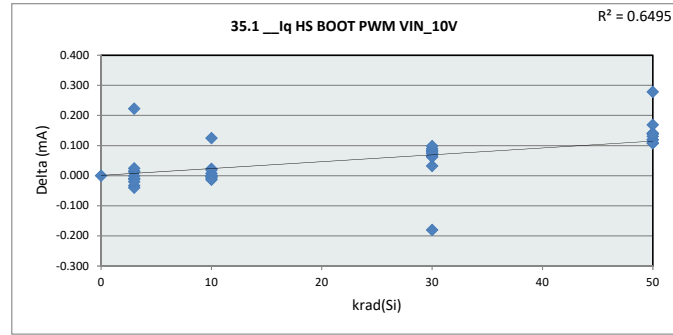

35.1 Iq HS BOOT		
Test Site	DAL-FL	
Tester	ETS364	
Test Number	EB672302	
Max Limit	6.3	mA
Min Limit	1	mA

krad(Si)	0	3	10	30	50	100
LL	1.000	1.000	1.000	1.000	1.000	1.000
Min	3.564	3.547	3.579	3.533	3.689	3.678
Average	3.564	3.630	3.648	3.713	3.779	3.825
Max	3.564	3.839	3.830	3.821	3.858	4.022
UL	6.300	6.300	6.300	6.300	6.300	6.300

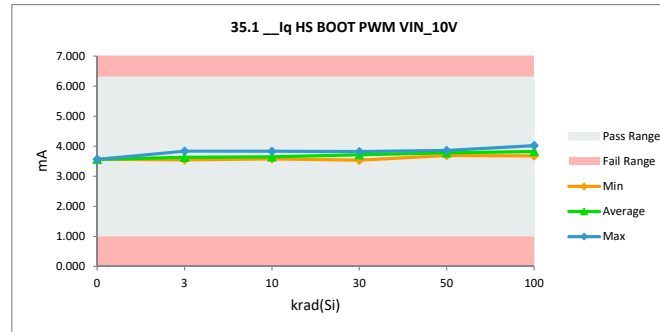

TID HDR Report
TPS7H6003-SP (5962R2220101VXC)

35.2 Iq LS VIN IIM Interlock V		
Test Site	DAL-FL	DAL-FL
Tester	ETS364	ETS364
Test Number	EB672302	EB672302
Unit	mA	mA
Max Limit	8	8
Min Limit	1	1

krad(Si)	Serial #	pre_short (rtp)	(2)'ST_Combo (rpt)	Delta
0	Ctrl	4.119	4.119	0.000
3	58	4.210	4.218	0.008
3	59	4.155	4.164	0.009
3	60	4.138	4.150	0.012
3	61	4.169	4.186	0.017
3	62	4.180	4.168	-0.012
3	134	4.098	4.287	0.189
3	137	4.124	4.289	0.165
3	138	4.149	4.276	0.128
3	139	4.368	4.359	-0.010
3	236	4.157	4.347	0.190
10	63	4.323	4.339	0.016
10	64	4.287	4.298	0.011
10	65	4.198	4.210	0.012
10	66	4.067	4.077	0.011
10	150	4.203	4.198	-0.005
10	237	4.250	4.340	0.090
10	241	4.384	4.285	-0.099
10	242	4.188	4.199	0.011
10	243	4.184	4.197	0.013
10	244	4.410	4.379	-0.031
30	141	4.214	4.295	0.081
30	144	4.136	4.219	0.083
30	145	4.309	4.391	0.081
30	146	4.257	4.323	0.066
30	147	4.324	4.389	0.065
30	132	4.132	4.208	0.076
30	133	4.357	4.464	0.107
30	135	4.388	4.167	-0.221
30	245	4.159	4.251	0.092
30	246	4.268	4.333	0.066
50	67	4.283	4.423	0.140
50	68	4.072	4.374	0.302
50	69	4.254	4.387	0.134
50	71	4.186	4.363	0.178
50	72	4.175	4.331	0.156
50	172	4.356	4.523	0.167
50	173	4.158	4.239	0.081
50	174	4.052	4.211	0.159
50	183	4.131	4.264	0.133
50	186	4.238	4.381	0.142
100	95	4.242	4.520	0.278
100	102	4.177	4.415	0.238
100	104	4.185	4.471	0.286
100	105	4.170	4.417	0.247
100	106	4.246	4.418	0.171
100	178	4.278	4.527	0.249
100	179	4.214	4.407	0.193
100	180	4.195	4.430	0.234
100	181	4.071	4.351	0.280
100	182	4.137	4.416	0.279
	Max	4.410	4.527	0.302
	Average	4.210	4.314	0.103
	Min	4.052	4.077	-0.221
	Std Dev	0.089	0.110	0.109

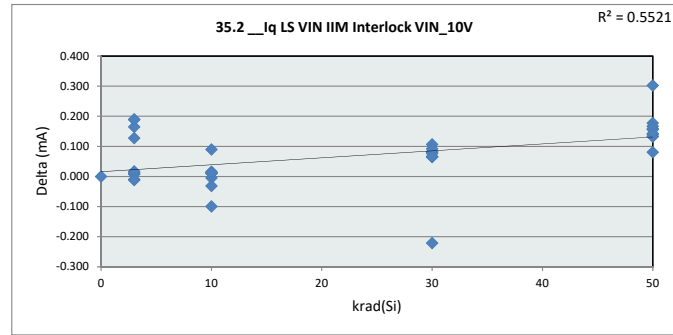

35.2 Iq LS VIN IIM						
Test Site	DAL-FL					
Tester	ETS364					
Test Number	EB672302					
Max Limit	8	mA				
Min Limit	1	mA				
krad(Si)	0	3	10	30	50	100
LL	1.000	1.000	1.000	1.000	1.000	1.000
Min	4.119	4.150	4.077	4.167	4.211	4.351
Average	4.119	4.244	4.252	4.304	4.350	4.437
Max	4.119	4.359	4.379	4.464	4.523	4.527
UL	8.000	8.000	8.000	8.000	8.000	8.000

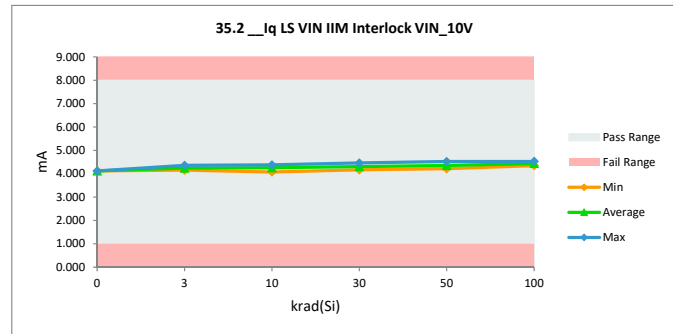

TID HDR Report
TPS7H6003-SP (5962R2220101VXC)

35.3 Iq HS BOOT IIM Interlock		
Test Site	DAL-FL	DAL-FL
Tester	ETS364	ETS364
Test Number	EB672302	EB672302
Unit	mA	mA
Max Limit	6.3	6.3
Min Limit	1	1

krad(Si)	Serial #	pre_short (rtp)	(2)ST_Combo (rpt)	Delta
0	Ctrl	3.563	3.563	0.000
3	58	3.549	3.562	0.013
3	59	3.638	3.626	-0.012
3	60	3.532	3.547	0.016
3	61	3.548	3.547	-0.001
3	62	3.558	3.549	-0.009
3	134	3.607	3.631	0.024
3	137	3.666	3.633	-0.033
3	138	3.658	3.618	-0.040
3	139	3.771	3.751	-0.020
3	236	3.616	3.840	0.223
10	63	3.651	3.673	0.022
10	64	3.655	3.654	-0.001
10	65	3.586	3.594	0.008
10	66	3.567	3.586	0.018
10	150	3.690	3.685	-0.005
10	237	3.705	3.830	0.124
10	241	3.636	3.628	-0.009
10	242	3.615	3.613	-0.003
10	243	3.579	3.578	-0.001
10	244	3.647	3.634	-0.013
30	141	3.708	3.791	0.083
30	144	3.572	3.647	0.074
30	145	3.687	3.719	0.032
30	146	3.598	3.679	0.081
30	147	3.713	3.779	0.065
30	132	3.486	3.548	0.062
30	133	3.708	3.797	0.088
30	135	3.714	3.533	-0.180
30	245	3.738	3.810	0.072
30	246	3.722	3.820	0.098
50	67	3.670	3.779	0.109
50	68	3.579	3.857	0.279
50	69	3.651	3.771	0.120
50	71	3.548	3.690	0.142
50	72	3.723	3.842	0.119
50	172	3.686	3.797	0.111
50	173	3.596	3.736	0.141
50	174	3.716	3.846	0.130
50	183	3.599	3.767	0.169
50	186	3.570	3.709	0.139
100	95	3.665	3.859	0.194
100	102	3.501	3.678	0.177
100	104	3.554	3.788	0.234
100	105	3.591	3.804	0.213
100	106	3.550	3.739	0.189
100	178	3.765	4.022	0.257
100	179	3.612	3.865	0.253
100	180	3.584	3.777	0.193
100	181	3.604	3.845	0.241
100	182	3.617	3.868	0.251
	Max	3.771	4.022	0.279
	Average	3.629	3.716	0.087
	Min	3.486	3.533	-0.180
	Std Dev	0.069	0.114	0.100

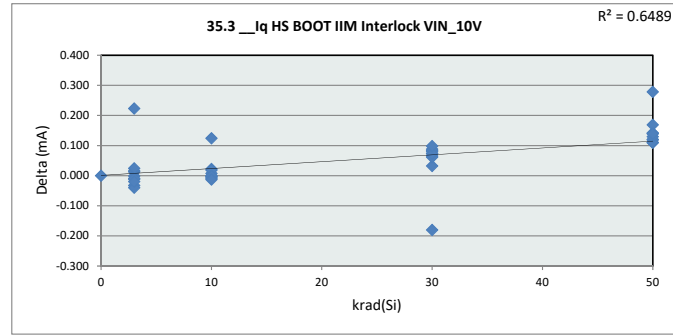

35.3 Iq HS BOOT		
Test Site	DAL-FL	
Tester	ETS364	
Test Number	EB672302	
Max Limit	6.3	mA
Min Limit	1	mA

krad(Si)	0	3	10	30	50	100
LL	1.000	1.000	1.000	1.000	1.000	1.000
Min	3.563	3.547	3.578	3.533	3.690	3.678
Average	3.563	3.630	3.647	3.712	3.780	3.824
Max	3.563	3.840	3.830	3.820	3.857	4.022
UL	6.300	6.300	6.300	6.300	6.300	6.300

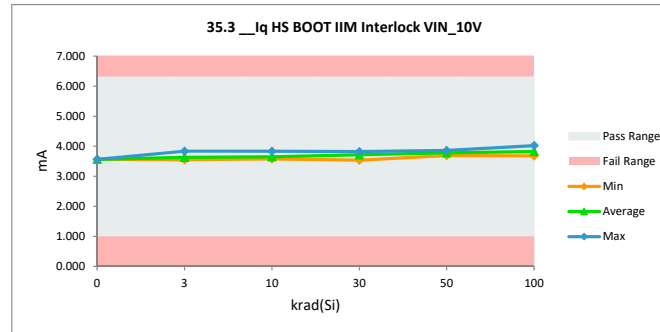

TID HDR Report
TPS7H6003-SP (5962R2220101VXC)

35.6 __Iop LS VIN PWM 500kHz		
Test Site	DAL-FL	DAL-FL
Tester	ETS364	ETS364
Test Number	EB672302	EB672302
Unit	mA	mA
Max Limit	9	9
Min Limit	1	1

krad(Si)	Serial #	pre_short (rtp)	(2)'ST_Combo (rpt)	Delta
0	Ctrl	6.310	6.310	0.000
3	58	6.380	6.380	0.000
3	59	6.264	6.270	0.006
3	60	6.270	6.276	0.006
3	61	6.315	6.326	0.011
3	62	6.367	6.352	-0.015
3	134	6.255	6.420	0.166
3	137	6.294	6.418	0.124
3	138	6.319	6.410	0.091
3	139	6.467	6.456	-0.011
3	236	6.335	6.483	0.148
10	63	6.491	6.488	-0.003
10	64	6.528	6.523	-0.005
10	65	6.444	6.437	-0.007
10	66	6.245	6.238	-0.007
10	150	6.341	6.323	-0.019
10	237	6.386	6.481	0.095
10	241	6.524	6.416	-0.108
10	242	6.339	6.338	-0.002
10	243	6.407	6.411	0.004
10	244	6.525	6.485	-0.040
30	141	6.399	6.433	0.034
30	144	6.370	6.400	0.030
30	145	6.446	6.482	0.036
30	146	6.386	6.406	0.020
30	147	6.460	6.481	0.021
30	132	6.343	6.373	0.030
30	133	6.526	6.585	0.060
30	135	6.540	6.296	-0.244
30	245	6.356	6.401	0.044
30	246	6.383	6.407	0.024
50	67	6.492	6.545	0.053
50	68	6.264	6.535	0.271
50	69	6.407	6.467	0.060
50	71	6.285	6.396	0.110
50	72	6.364	6.435	0.071
50	172	6.543	6.663	0.120
50	173	6.355	6.376	0.020
50	174	6.187	6.292	0.105
50	183	6.244	6.324	0.080
50	186	6.451	6.527	0.076
100	95	6.449	6.577	0.128
100	102	6.318	6.426	0.108
100	104	6.312	6.470	0.158
100	105	6.377	6.494	0.117
100	106	6.423	6.440	0.016
100	178	6.455	6.595	0.141
100	179	6.396	6.474	0.077
100	180	6.402	6.499	0.097
100	181	6.228	6.391	0.162
100	182	6.348	6.514	0.166
	Max	6.543	6.663	0.271
	Average	6.379	6.430	0.052
	Min	6.187	6.238	-0.244
	Std Dev	0.090	0.091	0.080

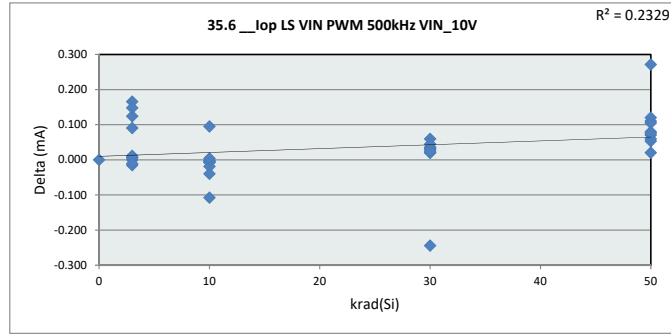

35.6 __Iop LS VIN P						
Test Site	DAL-FL					
Tester	ETS364					
Test Number	EB672302					
Max Limit	9	mA				
Min Limit	1	mA				
krad(Si)	0	3	10	30	50	100
LL	1.000	1.000	1.000	1.000	1.000	1.000
Min	6.310	6.270	6.238	6.296	6.292	6.391
Average	6.310	6.379	6.414	6.427	6.456	6.488
Max	6.310	6.483	6.523	6.585	6.663	6.595
UL	9.000	9.000	9.000	9.000	9.000	9.000

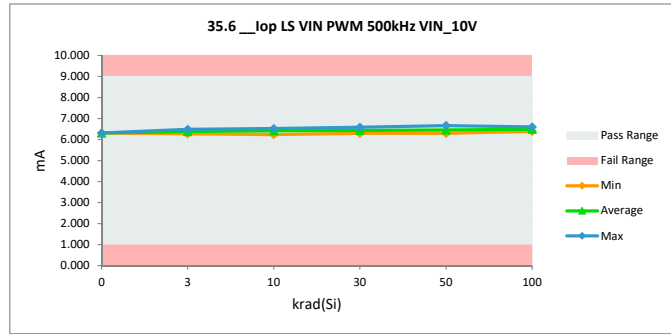

TID HDR Report
TPS7H6003-SP (5962R2220101VXC)

35.7 __Iop HS BOOT PWM 500kHz		
Test Site	DAL-FL	DAL-FL
Tester	ETS364	ETS364
Test Number	EB672302	EB672302
Unit	mA	mA
Max Limit	6.5	6.5
Min Limit	1	1

krad(Si)	Serial #	pre_short (rtp)	(2)'ST_Combo (rpt)	Delta
0	Ctrl	4.393	4.393	0.000
3	58	4.377	4.395	0.018
3	59	4.463	4.456	-0.006
3	60	4.352	4.372	0.019
3	61	4.372	4.377	0.004
3	62	4.381	4.379	-0.002
3	134	4.431	4.465	0.034
3	137	4.494	4.465	-0.028
3	138	4.484	4.451	-0.034
3	139	4.596	4.580	-0.016
3	236	4.437	4.670	0.234
10	63	4.474	4.503	0.029
10	64	4.482	4.486	0.003
10	65	4.414	4.425	0.012
10	66	4.388	4.413	0.025
10	150	4.519	4.518	-0.002
10	237	4.525	4.661	0.136
10	241	4.457	4.460	0.003
10	242	4.439	4.443	0.004
10	243	4.405	4.411	0.006
10	244	4.469	4.460	-0.008
30	141	4.534	4.625	0.090
30	144	4.393	4.472	0.079
30	145	4.517	4.552	0.035
30	146	4.419	4.505	0.087
30	147	4.536	4.604	0.069
30	132	4.313	4.377	0.064
30	133	4.530	4.625	0.095
30	135	4.538	4.361	-0.176
30	245	4.565	4.645	0.080
30	246	4.543	4.646	0.103
50	67	4.496	4.611	0.116
50	68	4.402	4.691	0.289
50	69	4.473	4.599	0.126
50	71	4.373	4.520	0.147
50	72	4.539	4.666	0.126
50	172	4.510	4.625	0.115
50	173	4.415	4.560	0.145
50	174	4.543	4.681	0.137
50	183	4.420	4.592	0.172
50	186	4.396	4.541	0.145
100	95	4.490	4.690	0.199
100	102	4.318	4.505	0.187
100	104	4.377	4.624	0.247
100	105	4.413	4.638	0.225
100	106	4.373	4.563	0.190
100	178	4.586	4.850	0.264
100	179	4.438	4.696	0.258
100	180	4.408	4.610	0.202
100	181	4.432	4.678	0.246
100	182	4.442	4.705	0.263
	Max	4.596	4.850	0.289
	Average	4.453	4.546	0.093
	Min	4.313	4.361	-0.176
	Std Dev	0.069	0.114	0.101

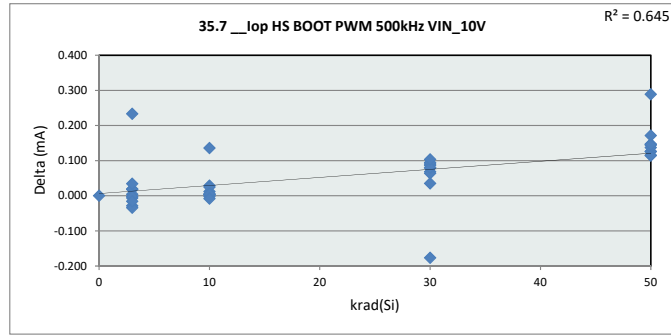

35.7 __Iop HS BOOT		
Test Site	DAL-FL	
Tester	ETS364	
Test Number	EB672302	
Max Limit	6.5	mA
Min Limit	1	mA

krad(Si)	0	3	10	30	50	100
LL	1.000	1.000	1.000	1.000	1.000	1.000
Min	4.393	4.372	4.411	4.361	4.520	4.505
Average	4.393	4.461	4.478	4.541	4.609	4.656
Max	4.393	4.671	4.661	4.646	4.691	4.850
UL	6.500	6.500	6.500	6.500	6.500	6.500

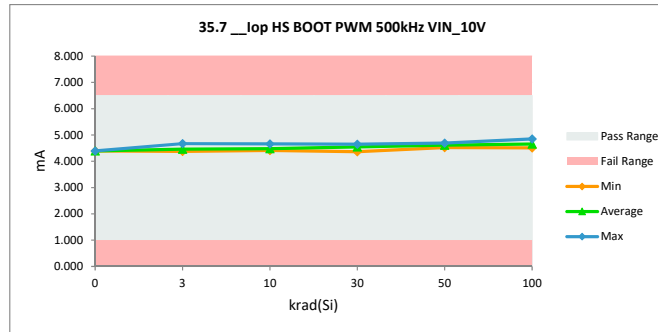

TID HDR Report
TPS7H6003-SP (5962R2220101VXC)

35.8 Iop LS VIN PWM 1MHz VIN		
Test Site	DAL-FL	DAL-FL
Tester	ETS364	ETS364
Test Number	EB672302	EB672302
Unit	mA	mA
Max Limit	11	11
Min Limit	1	1

krad(Si)	Serial #	pre_short (rtp)	(2)'ST_Combo (rpt)	Delta
0	Ctrl	8.007	8.007	0.000
3	58	8.074	8.076	0.002
3	59	7.947	7.953	0.006
3	60	7.946	7.953	0.008
3	61	8.009	8.022	0.012
3	62	8.063	8.050	-0.012
3	134	7.951	8.116	0.166
3	137	7.980	8.118	0.138
3	138	8.012	8.106	0.094
3	139	8.164	8.156	-0.009
3	236	8.020	8.175	0.154
10	63	8.188	8.191	0.003
10	64	8.224	8.224	-0.001
10	65	8.140	8.139	-0.001
10	66	7.929	7.926	-0.003
10	150	8.038	8.021	-0.017
10	237	8.080	8.169	0.089
10	241	8.218	8.114	-0.104
10	242	8.016	8.019	0.004
10	243	8.095	8.103	0.008
10	244	8.215	8.179	-0.036
30	141	8.095	8.143	0.048
30	144	8.069	8.115	0.046
30	145	8.154	8.202	0.048
30	146	8.071	8.102	0.030
30	147	8.160	8.192	0.032
30	132	8.040	8.082	0.041
30	133	8.225	8.298	0.073
30	135	8.231	7.997	-0.234
30	245	8.053	8.106	0.053
30	246	8.082	8.117	0.035
50	67	8.180	8.252	0.072
50	68	7.952	8.264	0.312
50	69	8.106	8.186	0.080
50	71	7.980	8.111	0.131
50	72	8.044	8.131	0.087
50	172	8.233	8.387	0.154
50	173	8.046	8.084	0.038
50	174	7.894	8.019	0.125
50	183	7.946	8.042	0.096
50	186	8.147	8.244	0.097
100	95	8.143	8.301	0.158
100	102	8.004	8.147	0.143
100	104	7.996	8.180	0.184
100	105	8.067	8.239	0.172
100	106	8.115	8.148	0.034
100	178	8.151	8.328	0.176
100	179	8.091	8.198	0.107
100	180	8.108	8.219	0.111
100	181	7.924	8.117	0.193
100	182	8.040	8.242	0.202
Max		8.233	8.387	0.312
Average		8.072	8.137	0.066
Min		7.894	7.926	-0.234
Std Dev		0.091	0.099	0.088

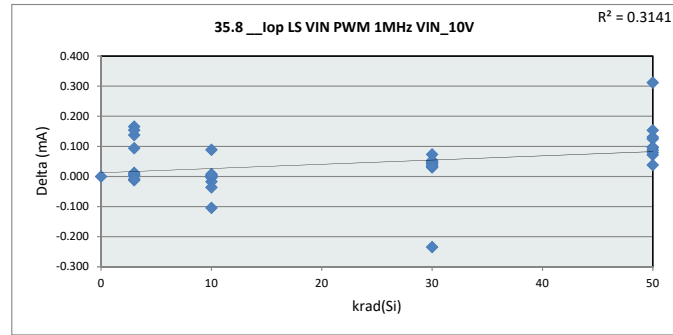

35.8 Iop LS VIN PWM 1MHz VIN_10V						
Test Site	DAL-FL					
Tester	ETS364					
Test Number	EB672302					
Max Limit	11	mA				
Min Limit	1	mA				
krad(Si)	0	3	10	30	50	100
LL	1.000	1.000	1.000	1.000	1.000	1.000
Min	8.007	7.953	7.926	7.997	8.019	8.117
Average	8.007	8.072	8.108	8.135	8.172	8.212
Max	8.007	8.175	8.224	8.298	8.387	8.328
UL	11.000	11.000	11.000	11.000	11.000	11.000

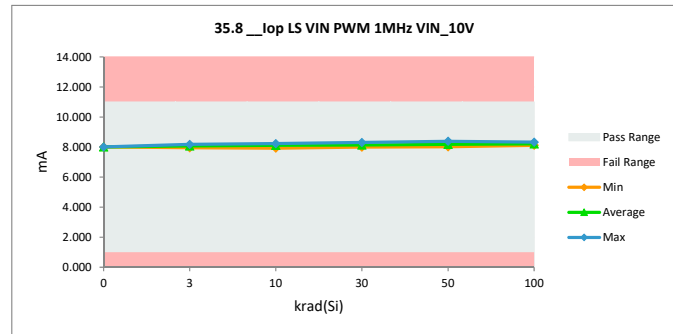

TID HDR Report

TPS7H6003-SP (5962R2220101VXC)

35.9 Iop HS BOOT PWM 1MHz		
Test Site	DAL-FL	DAL-FL
Tester	ETS364	ETS364
Test Number	EB672302	EB672302
Unit	mA	mA
Max Limit	8	8
Min Limit	1	1

krad(Si)	Serial #	pre_short (rtp)	(2)'ST_Combo (rpt)	Delta
0	Ctrl	5.220	5.220	0.000
3	58	5.201	5.226	0.025
3	59	5.284	5.285	0.001
3	60	5.170	5.197	0.028
3	61	5.193	5.204	0.011
3	62	5.202	5.208	0.007
3	134	5.251	5.297	0.046
3	137	5.319	5.297	-0.022
3	138	5.306	5.283	-0.024
3	139	5.418	5.410	-0.008
3	236	5.256	5.499	0.243
10	63	5.294	5.328	0.034
10	64	5.306	5.316	0.010
10	65	5.238	5.256	0.019
10	66	5.208	5.236	0.029
10	150	5.344	5.348	0.004
10	237	5.341	5.490	0.149
10	241	5.275	5.292	0.016
10	242	5.260	5.273	0.012
10	243	5.227	5.240	0.013
10	244	5.286	5.286	-0.001
30	141	5.358	5.458	0.100
30	144	5.211	5.298	0.087
30	145	5.344	5.386	0.042
30	146	5.236	5.330	0.094
30	147	5.353	5.429	0.076
30	132	5.135	5.206	0.071
30	133	5.350	5.455	0.105
30	135	5.356	5.189	-0.167
30	245	5.389	5.476	0.086
30	246	5.360	5.470	0.110
50	67	5.317	5.440	0.123
50	68	5.223	5.520	0.296
50	69	5.290	5.427	0.136
50	71	5.196	5.348	0.152
50	72	5.354	5.489	0.134
50	172	5.328	5.450	0.121
50	173	5.232	5.384	0.153
50	174	5.367	5.512	0.145
50	183	5.239	5.418	0.179
50	186	5.218	5.371	0.152
100	95	5.312	5.516	0.205
100	102	5.135	5.329	0.194
100	104	5.197	5.456	0.258
100	105	5.231	5.467	0.236
100	106	5.191	5.383	0.192
100	178	5.404	5.674	0.270
100	179	5.260	5.528	0.268
100	180	5.228	5.442	0.214
100	181	5.256	5.506	0.249
100	182	5.263	5.538	0.275
Max		5.418	5.674	0.296
Average		5.273	5.374	0.101
Min		5.135	5.189	-0.167
Std Dev		0.069	0.114	0.101

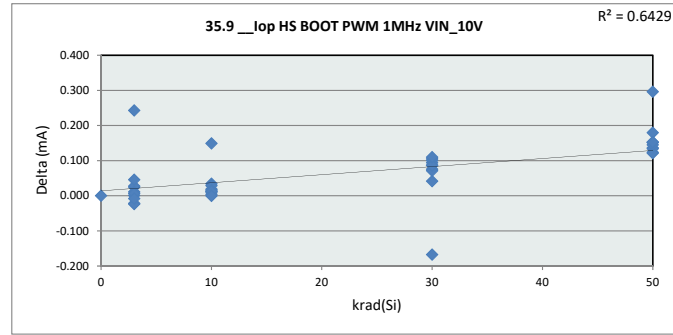

35.9 Iop HS BOOT		
Test Site	DAL-FL	
Tester	ETS364	
Test Number	EB672302	
Max Limit	8	mA
Min Limit	1	mA

krad(Si)	0	3	10	30	50	100
LL	1.000	1.000	1.000	1.000	1.000	1.000
Min	5.221	5.197	5.236	5.189	5.348	5.329
Average	5.221	5.291	5.307	5.370	5.436	5.484
Max	5.221	5.499	5.490	5.476	5.520	5.675
UL	8.000	8.000	8.000	8.000	8.000	8.000

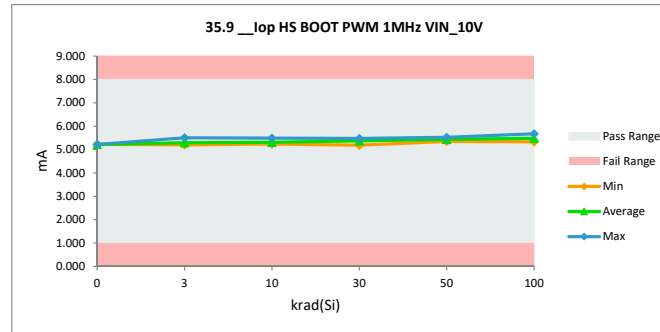

TID HDR Report
TPS7H6003-SP (5962R2220101VXC)

35.10 Top LS VIN PWM 2MHz V		
Test Site	DAL-FL	DAL-FL
Tester	ETS364	ETS364
Test Number	EB672302	EB672302
Unit	mA	mA
Max Limit	16	16
Min Limit	1	1

krad(Si)	Serial #	pre_short (rtp)	(2)ST_Combo (rpt)	Delta
0	Ctrl	11.378	11.378	0.000
3	58	11.436	11.450	0.013
3	59	11.302	11.320	0.018
3	60	11.283	11.302	0.020
3	61	11.379	11.392	0.014
3	62	11.441	11.424	-0.017
3	134	11.319	11.496	0.177
3	137	11.335	11.498	0.163
3	138	11.378	11.484	0.106
3	139	11.535	11.531	-0.004
3	236	11.379	11.541	0.162
10	63	11.563	11.572	0.010
10	64	11.597	11.598	0.001
10	65	11.516	11.533	0.017
10	66	11.273	11.275	0.001
10	150	11.418	11.416	-0.002
10	237	11.444	11.536	0.092
10	241	11.583	11.493	-0.090
10	242	11.347	11.359	0.012
10	243	11.456	11.465	0.009
10	244	11.571	11.546	-0.025
30	141	11.471	11.564	0.093
30	144	11.448	11.525	0.077
30	145	11.554	11.617	0.063
30	146	11.419	11.475	0.056
30	147	11.540	11.613	0.073
30	132	11.419	11.475	0.056
30	133	11.602	11.694	0.092
30	135	11.589	11.368	-0.221
30	245	11.423	11.509	0.086
30	246	11.468	11.539	0.071
50	67	11.533	11.662	0.129
50	68	11.303	11.700	0.397
50	69	11.480	11.628	0.148
50	71	11.351	11.521	0.170
50	72	11.388	11.535	0.147
50	172	11.594	11.839	0.246
50	173	11.409	11.493	0.084
50	174	11.285	11.476	0.190
50	183	11.323	11.486	0.163
50	186	11.523	11.649	0.125
100	95	11.513	11.757	0.244
100	102	11.352	11.599	0.246
100	104	11.339	11.616	0.277
100	105	11.439	11.724	0.285
100	106	11.477	11.562	0.085
100	178	11.521	11.800	0.279
100	179	11.456	11.648	0.192
100	180	11.490	11.659	0.170
100	181	11.289	11.575	0.287
100	182	11.401	11.703	0.302
	Max	11.602	11.839	0.397
	Average	11.438	11.542	0.104
	Min	11.273	11.275	-0.221
	Std Dev	0.095	0.123	0.115

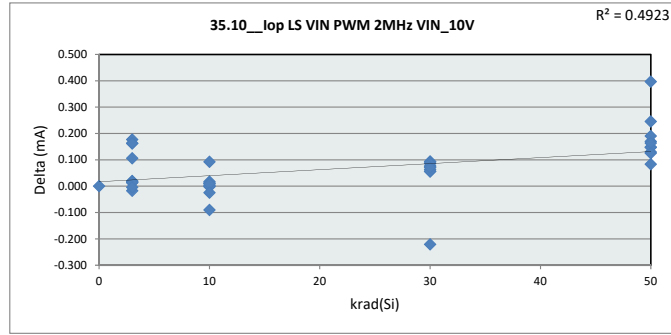

35.10 Top LS VIN						
Test Site	DAL-FL					
Tester	ETS364					
Test Number	EB672302					
Max Limit	16	mA				
Min Limit	1	mA				
krad(Si)	0	3	10	30	50	100
LL	1.000	1.000	1.000	1.000	1.000	1.000
Min	11.378	11.303	11.275	11.368	11.476	11.562
Average	11.378	11.444	11.479	11.538	11.599	11.664
Max	11.378	11.541	11.598	11.694	11.839	11.801
UL	16.000	16.000	16.000	16.000	16.000	16.000

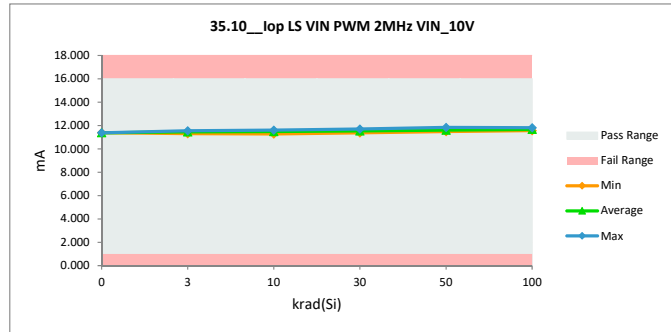

TID HDR Report
TPS7H6003-SP (5962R2220101VXC)

35.11_Top HS BOOT PWM 2MHz		
Test Site	DAL-FL	DAL-FL
Tester	ETS364	ETS364
Test Number	EB672302	EB672302
Unit	mA	mA
Max Limit	10.5	10.5
Min Limit	1	1

krad(Si)	Serial #	pre_short (rtp)	(2)'ST_Combo (rpt)	Delta
0	Ctrl	6.867	6.867	0.000
3	58	6.867	6.905	0.038
3	59	6.936	6.952	0.016
3	60	6.821	6.850	0.029
3	61	6.839	6.870	0.031
3	62	6.844	6.875	0.031
3	134	6.901	6.970	0.069
3	137	6.976	6.973	-0.002
3	138	6.950	6.955	0.005
3	139	7.075	7.081	0.006
3	236	6.898	7.177	0.280
10	63	6.946	6.976	0.030
10	64	6.965	6.984	0.018
10	65	6.902	6.914	0.012
10	66	6.842	6.887	0.045
10	150	7.007	7.003	-0.004
10	237	6.970	7.167	0.197
10	241	6.928	6.965	0.037
10	242	6.919	6.929	0.010
10	243	6.887	6.906	0.019
10	244	6.940	6.953	0.013
30	141	7.023	7.124	0.101
30	144	6.862	6.956	0.094
30	145	7.006	7.053	0.047
30	146	6.890	6.984	0.094
30	147	7.007	7.097	0.090
30	132	6.800	6.882	0.082
30	133	7.005	7.128	0.123
30	135	7.000	6.840	-0.160
30	245	7.060	7.155	0.096
30	246	7.011	7.123	0.112
50	67	6.960	7.093	0.133
50	68	6.882	7.195	0.313
50	69	6.944	7.088	0.144
50	71	6.837	6.990	0.153
50	72	6.994	7.142	0.148
50	172	6.968	7.105	0.137
50	173	6.882	7.043	0.161
50	174	7.025	7.180	0.155
50	183	6.891	7.088	0.196
50	186	6.863	7.024	0.161
100	95	6.971	7.181	0.210
100	102	6.782	6.985	0.203
100	104	6.854	7.130	0.276
100	105	6.885	7.127	0.242
100	106	6.847	7.028	0.181
100	178	7.053	7.330	0.277
100	179	6.921	7.202	0.281
100	180	6.886	7.115	0.228
100	181	6.923	7.176	0.253
100	182	6.920	7.213	0.293
	Max	7.075	7.330	0.313
	Average	6.926	7.038	0.112
	Min	6.782	6.840	-0.160
	Std Dev	0.070	0.116	0.103

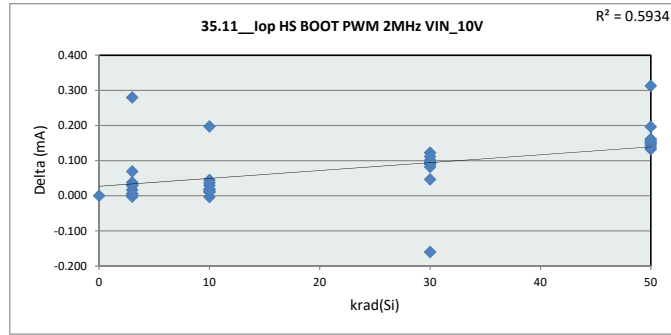

35.11_Top HS BOOT PWM 2MHz VIN_10V						
Test Site	DAL-FL					
Tester	ETS364					
Test Number	EB672302					
Max Limit	10.5	mA				
Min Limit	1	mA				
krad(Si)	0	3	10	30	50	100
LL	1.000	1.000	1.000	1.000	1.000	1.000
Min	6.867	6.850	6.887	6.840	6.990	6.985
Average	6.867	6.961	6.968	7.034	7.095	7.149
Max	6.867	7.177	7.167	7.155	7.195	7.330
UL	10.500	10.500	10.500	10.500	10.500	10.500

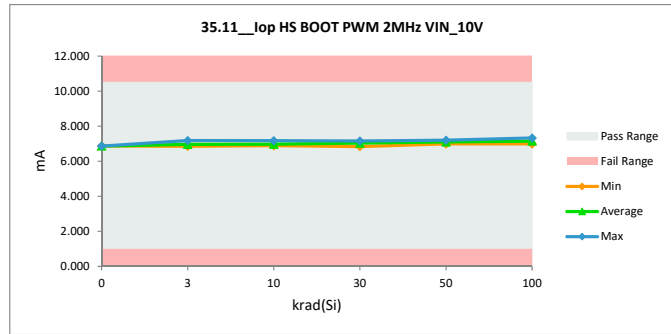

TID HDR Report
TPS7H6003-SP (5962R2220101VXC)

35.12_Top LS VIN PWM 5MHz V		
Test Site	DAL-FL	DAL-FL
Tester	ETS364	ETS364
Test Number	EB672302	EB672302
Unit	mA	mA
Max Limit	30	30
Min Limit	1	1

krad(Si)	Serial #	pre_short (rtp)	(2)ST_Combo (rpt)	Delta
0	Ctrl	20.187	20.187	0.000
3	58	17.994	18.000	0.006
3	59	18.156	18.228	0.073
3	60	17.972	18.018	0.045
3	61	18.154	18.168	0.013
3	62	18.034	18.020	-0.014
3	134	17.471	18.675	1.204
3	137	18.323	18.674	0.351
3	138	18.022	18.664	0.642
3	139	18.710	18.724	0.014
3	236	20.182	18.573	-1.609
10	63	18.430	18.458	0.028
10	64	17.827	17.984	0.157
10	65	18.435	18.465	0.030
10	66	17.871	17.980	0.108
10	150	18.030	18.104	0.073
10	237	18.505	18.569	0.064
10	241	18.579	18.670	0.091
10	242	17.649	17.728	0.078
10	243	18.105	18.278	0.173
10	244	18.523	18.476	-0.046
30	141	18.145	18.458	0.313
30	144	17.900	18.288	0.388
30	145	18.233	18.550	0.318
30	146	17.935	18.268	0.334
30	147	18.253	18.553	0.300
30	132	17.525	17.983	0.458
30	133	18.294	18.673	0.379
30	135	18.722	18.105	-0.616
30	245	18.153	18.448	0.296
30	246	17.803	18.132	0.329
50	67	18.295	18.669	0.375
50	68	20.288	18.804	-1.484
50	69	17.747	18.340	0.593
50	71	17.851	18.471	0.619
50	72	18.296	18.742	0.446
50	172	18.840	19.217	0.377
50	173	18.110	18.459	0.349
50	174	20.004	17.977	-2.026
50	183	17.860	18.332	0.472
50	186	17.994	18.588	0.594
100	95	18.231	18.650	0.419
100	102	17.819	18.709	0.890
100	104	18.060	18.795	0.736
100	105	17.992	18.879	0.887
100	106	17.785	18.508	0.723
100	178	18.106	19.043	0.937
100	179	17.641	18.552	0.911
100	180	19.048	18.399	-0.649
100	181	17.837	18.677	0.839
100	182	17.764	18.861	1.098
	Max	20.288	20.187	1.204
	Average	18.268	18.486	0.217
	Min	17.471	17.728	-2.026
	Std Dev	0.648	0.394	0.614

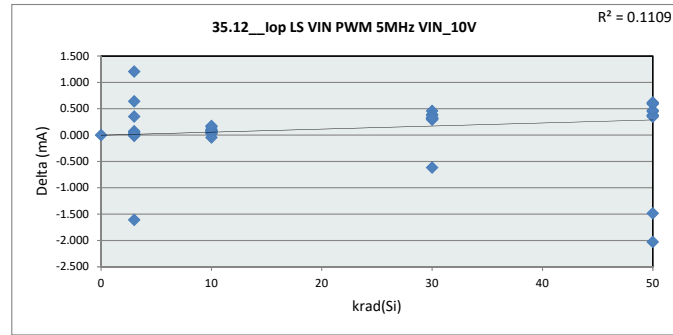

35.12_Top LS VIN PWM 5MHz V						
Test Site	DAL-FL					
Tester	ETS364					
Test Number	EB672302					
Max Limit	30	mA				
Min Limit	1	mA				
krad(Si)	0	3	10	30	50	100
LL	1.000	1.000	1.000	1.000	1.000	1.000
Min	20.187	18.000	17.728	17.983	17.977	18.399
Average	20.187	18.374	18.271	18.346	18.560	18.707
Max	20.187	18.724	18.670	18.673	19.217	19.043
UL	30.000	30.000	30.000	30.000	30.000	30.000

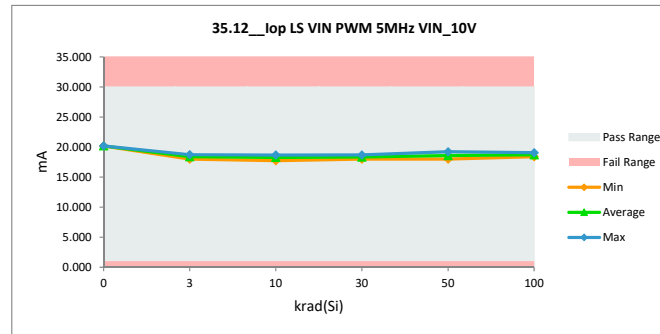

TID HDR Report
TPS7H6003-SP (5962R2220101VXC)

35.13 Top HS BOOT PWM 5MHz		
Test Site	DAL-FL	DAL-FL
Tester	ETS364	ETS364
Test Number	EB672302	EB672302
Unit	mA	mA
Max Limit	17.5	17.5
Min Limit	1	1

krad(Si)	Serial #	pre_short (rtp)	(2)ST_Combo (rpt)	Delta
0	Ctrl	13.392	13.392	0.000
3	58	12.649	13.150	0.501
3	59	11.287	12.018	0.731
3	60	11.960	12.610	0.650
3	61	10.816	10.886	0.069
3	62	10.839	11.072	0.233
3	134	13.553	11.398	-2.155
3	137	11.027	11.397	0.370
3	138	10.966	11.387	0.421
3	139	12.429	12.808	0.380
3	236	13.299	13.684	0.385
10	63	13.475	13.745	0.271
10	64	13.578	13.767	0.189
10	65	13.565	13.539	-0.026
10	66	10.833	10.910	0.078
10	150	13.719	13.751	0.033
10	237	10.982	13.687	2.705
10	241	13.148	11.396	-1.751
10	242	13.090	13.519	0.429
10	243	11.748	12.131	0.383
10	244	12.323	12.579	0.256
30	141	13.279	12.958	-0.321
30	144	12.499	12.365	-0.134
30	145	11.397	11.128	-0.269
30	146	12.573	12.334	-0.239
30	147	13.040	12.696	-0.344
30	132	12.560	12.437	-0.123
30	133	12.885	12.580	-0.306
30	135	10.963	10.514	-0.449
30	245	13.196	12.691	-0.504
30	246	13.651	13.302	-0.349
50	67	11.017	11.022	0.005
50	68	12.395	12.183	-0.212
50	69	13.298	12.538	-0.761
50	71	10.747	10.308	-0.439
50	72	12.060	11.831	-0.228
50	172	10.941	10.958	0.017
50	173	12.432	12.099	-0.333
50	174	13.744	13.342	-0.401
50	183	12.984	12.488	-0.496
50	186	10.748	10.485	-0.263
100	95	13.427	11.563	-1.864
100	102	11.901	10.970	-0.931
100	104	12.540	11.375	-1.165
100	105	11.982	10.780	-1.202
100	106	12.255	10.857	-1.398
100	178	12.157	11.390	-0.767
100	179	12.368	11.310	-1.057
100	180	13.258	11.936	-1.322
100	181	12.666	11.237	-1.430
100	182	11.837	11.140	-0.697
	Max	13.744	13.767	2.705
	Average	12.343	12.071	-0.271
	Min	10.747	10.308	-2.155
	Std Dev	0.969	1.022	0.791

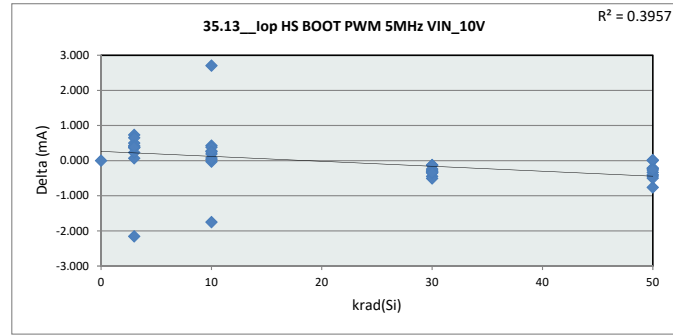

35.13 Top HS BOOT PWM 5MHz VIN_10V						
Test Site	DAL-FL					
Tester	ETS364					
Test Number	EB672302					
Max Limit	17.5 mA					
Min Limit	1 mA					
krad(Si)	0	3	10	30	50	100
LL	1.000	1.000	1.000	1.000	1.000	1.000
Min	13.392	10.886	10.910	10.514	10.308	10.780
Average	13.392	12.041	12.903	12.301	11.725	11.256
Max	13.392	13.685	13.767	13.302	13.342	11.936
UL	17.500	17.500	17.500	17.500	17.500	17.500

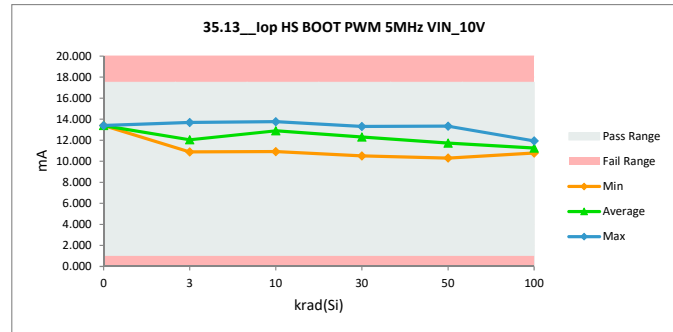

TID HDR Report
TPS7H6003-SP (5962R2220101VXC)

35.14 Top LS VIN IIM Interlock		
Test Site	DAL-FL	DAL-FL
Tester	ETS364	ETS364
Test Number	EB672302	EB672302
Unit	mA	mA
Max Limit	9	9
Min Limit	1	1

krad(Si)	Serial #	pre_short (rtp)	(2)ST_Combo (rpt)	Delta
0	Ctrl	5.719	5.719	0.000
3	58	5.806	5.810	0.004
3	59	5.734	5.742	0.008
3	60	5.715	5.724	0.009
3	61	5.758	5.774	0.016
3	62	5.786	5.773	-0.013
3	134	5.693	5.878	0.185
3	137	5.721	5.879	0.158
3	138	5.743	5.867	0.123
3	139	5.946	5.934	-0.012
3	236	5.754	5.929	0.175
10	63	5.914	5.926	0.012
10	64	5.905	5.910	0.005
10	65	5.816	5.824	0.008
10	66	5.661	5.666	0.005
10	150	5.789	5.780	-0.009
10	237	5.837	5.924	0.088
10	241	5.969	5.875	-0.093
10	242	5.771	5.779	0.008
10	243	5.794	5.804	0.010
10	244	5.987	5.951	-0.035
30	141	5.821	5.892	0.071
30	144	5.760	5.834	0.074
30	145	5.903	5.976	0.073
30	146	5.839	5.896	0.057
30	147	5.914	5.970	0.057
30	132	5.746	5.813	0.067
30	133	5.951	6.050	0.099
30	135	5.980	5.754	-0.226
30	245	5.763	5.847	0.084
30	246	5.850	5.907	0.058
50	67	5.888	6.013	0.125
50	68	5.673	5.985	0.312
50	69	5.847	5.973	0.125
50	71	5.766	5.936	0.170
50	72	5.780	5.919	0.139
50	172	5.953	6.129	0.176
50	173	5.760	5.841	0.081
50	174	5.643	5.799	0.156
50	183	5.717	5.849	0.132
50	186	5.850	5.987	0.137
100	95	5.853	6.105	0.253
100	102	5.762	5.984	0.222
100	104	5.766	6.031	0.265
100	105	5.778	6.016	0.239
100	106	5.845	5.982	0.137
100	178	5.877	6.124	0.247
100	179	5.817	6.001	0.185
100	180	5.805	6.020	0.215
100	181	5.663	5.935	0.271
100	182	5.744	6.016	0.273
	Max	5.987	6.129	0.312
	Average	5.806	5.903	0.097
	Min	5.643	5.666	-0.226
	Std Dev	0.088	0.108	0.107

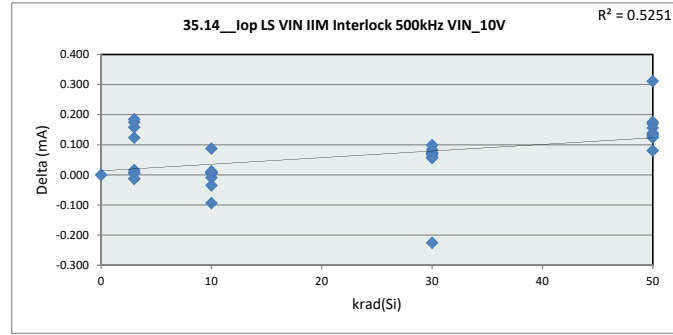

35.14 Top LS VIN IIM Interlock		
Test Site	DAL-FL	DAL-FL
Tester	ETS364	ETS364
Test Number	EB672302	EB672302
Max Limit	9	mA
Min Limit	1	mA

krad(Si)	0	3	10	30	50	100
LL	1.000	1.000	1.000	1.000	1.000	1.000
Min	5.719	5.724	5.666	5.754	5.799	5.935
Average	5.719	5.831	5.844	5.894	5.943	6.021
Max	5.719	5.934	5.951	6.050	6.129	6.124
UL	9.000	9.000	9.000	9.000	9.000	9.000

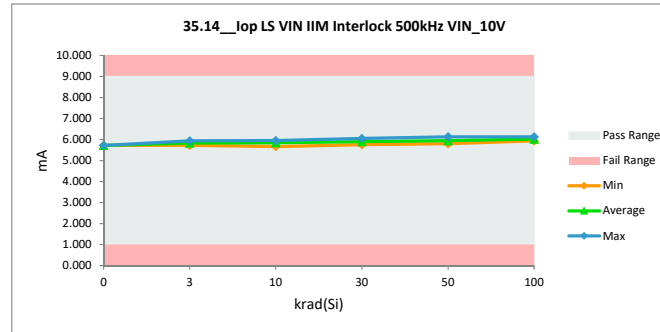

TID HDR Report
TPS7H6003-SP (5962R2220101VXC)

35.15_Top HS BOOT IIM Interlock		
Test Site	DAL-FL	DAL-FL
Tester	ETS364	ETS364
Test Number	EB672302	EB672302
Unit	mA	mA
Max Limit	6.5	6.5
Min Limit	1	1

krad(Si)	Serial #	pre_short (rtp)	(2)ST_Combo (rpt)	Delta
0	Ctrl	4.395	4.395	0.000
3	58	4.379	4.397	0.018
3	59	4.463	4.456	-0.008
3	60	4.356	4.374	0.018
3	61	4.375	4.378	0.003
3	62	4.384	4.381	-0.003
3	134	4.432	4.463	0.031
3	137	4.494	4.465	-0.029
3	138	4.484	4.450	-0.034
3	139	4.596	4.579	-0.017
3	236	4.439	4.670	0.231
10	63	4.474	4.503	0.028
10	64	4.483	4.487	0.004
10	65	4.414	4.427	0.013
10	66	4.393	4.414	0.021
10	150	4.517	4.516	-0.001
10	237	4.526	4.661	0.134
10	241	4.458	4.459	0.001
10	242	4.441	4.445	0.004
10	243	4.406	4.412	0.005
10	244	4.469	4.459	-0.010
30	141	4.534	4.625	0.091
30	144	4.394	4.476	0.081
30	145	4.518	4.552	0.034
30	146	4.422	4.507	0.085
30	147	4.535	4.603	0.068
30	132	4.315	4.377	0.062
30	133	4.532	4.625	0.092
30	135	4.536	4.361	-0.175
30	245	4.566	4.642	0.076
30	246	4.542	4.643	0.102
50	67	4.495	4.609	0.115
50	68	4.402	4.691	0.289
50	69	4.473	4.600	0.126
50	71	4.372	4.516	0.144
50	72	4.542	4.665	0.123
50	172	4.511	4.625	0.114
50	173	4.419	4.562	0.143
50	174	4.545	4.680	0.135
50	183	4.423	4.595	0.173
50	186	4.398	4.541	0.143
100	95	4.492	4.688	0.196
100	102	4.321	4.503	0.182
100	104	4.380	4.623	0.243
100	105	4.417	4.638	0.221
100	106	4.374	4.562	0.189
100	178	4.588	4.848	0.260
100	179	4.441	4.697	0.257
100	180	4.408	4.610	0.201
100	181	4.432	4.674	0.242
100	182	4.445	4.706	0.261
	Max	4.596	4.848	0.289
	Average	4.454	4.546	0.092
	Min	4.315	4.361	-0.175
	Std Dev	0.069	0.113	0.100

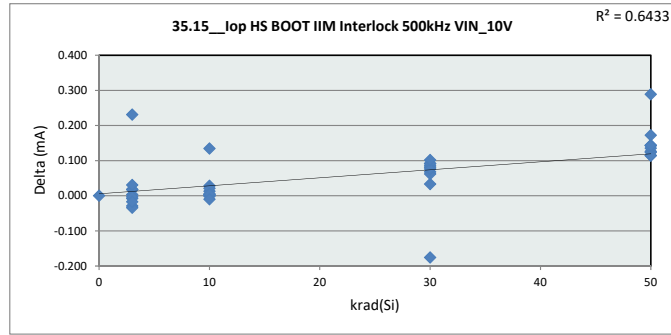

35.15_Top HS BOO

Test Site	DAL-FL
Tester	ETS364
Test Number	EB672302
Max Limit	6.5 mA
Min Limit	1 mA

krad(Si)	0	3	10	30	50	100
LL	1.000	1.000	1.000	1.000	1.000	1.000
Min	4.395	4.374	4.412	4.361	4.516	4.503
Average	4.395	4.461	4.478	4.541	4.608	4.655
Max	4.395	4.670	4.661	4.643	4.691	4.848
UL	6.500	6.500	6.500	6.500	6.500	6.500

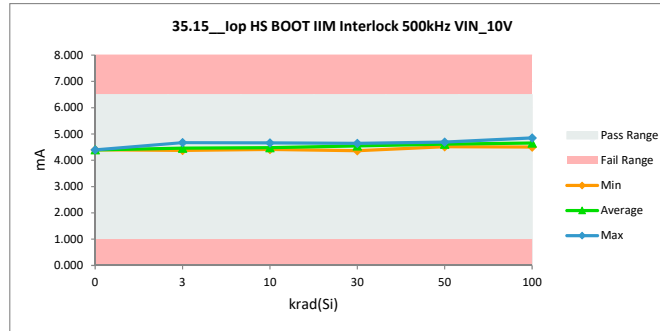

TID HDR Report
TPS7H6003-SP (5962R2220101VXC)

35.16 Top LS VIN IIM Interlock		
Test Site	DAL-FL	DAL-FL
Tester	ETS364	ETS364
Test Number	EB672302	EB672302
Unit	mA	mA
Max Limit	12	12
Min Limit	1	1

krad(Si)	Serial #	pre_short (rtp)	(2)ST_Combo (rpt)	Delta
0	Ctrl	7.184	7.184	0.000
3	58	7.271	7.279	0.008
3	59	7.197	7.206	0.008
3	60	7.164	7.174	0.011
3	61	7.226	7.243	0.017
3	62	7.254	7.242	-0.012
3	134	7.160	7.352	0.191
3	137	7.183	7.353	0.170
3	138	7.213	7.340	0.128
3	139	7.417	7.406	-0.011
3	236	7.212	7.390	0.178
10	63	7.382	7.395	0.013
10	64	7.372	7.379	0.007
10	65	7.284	7.293	0.009
10	66	7.118	7.127	0.009
10	150	7.263	7.253	-0.010
10	237	7.303	7.385	0.082
10	241	7.431	7.348	-0.083
10	242	7.222	7.234	0.012
10	243	7.251	7.266	0.015
10	244	7.449	7.417	-0.031
30	141	7.291	7.374	0.084
30	144	7.231	7.318	0.086
30	145	7.382	7.470	0.088
30	146	7.297	7.362	0.065
30	147	7.386	7.451	0.065
30	132	7.216	7.290	0.074
30	133	7.418	7.529	0.111
30	135	7.446	7.230	-0.217
30	245	7.232	7.324	0.091
30	246	7.320	7.389	0.069
50	67	7.349	7.495	0.145
50	68	7.130	7.479	0.349
50	69	7.318	7.463	0.144
50	71	7.234	7.424	0.191
50	72	7.237	7.396	0.159
50	172	7.423	7.627	0.204
50	173	7.222	7.319	0.097
50	174	7.117	7.294	0.177
50	183	7.187	7.339	0.152
50	186	7.318	7.474	0.155
100	95	7.320	7.606	0.286
100	102	7.218	7.476	0.258
100	104	7.221	7.519	0.298
100	105	7.237	7.528	0.291
100	106	7.307	7.466	0.160
100	178	7.345	7.627	0.282
100	179	7.285	7.498	0.213
100	180	7.280	7.512	0.232
100	181	7.126	7.432	0.306
100	182	7.207	7.515	0.308
	Max	7.449	7.627	0.349
	Average	7.272	7.382	0.110
	Min	7.117	7.127	-0.217
	Std Dev	0.089	0.118	0.117

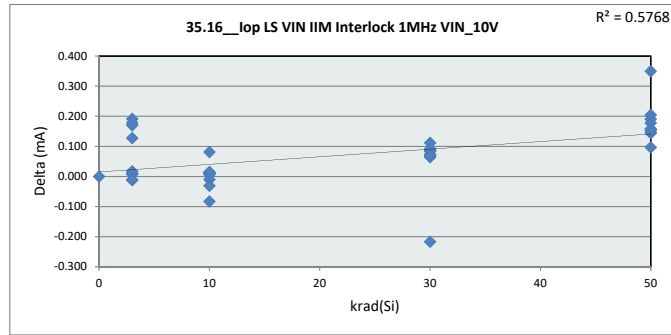

35.16 Top LS VIN I		
Test Site	DAL-FL	
Tester	ETS364	
Test Number	EB672302	
Max Limit	12	mA
Min Limit	1	mA

krad(Si)	0	3	10	30	50	100
LL	1.000	1.000	1.000	1.000	1.000	1.000
Min	7.184	7.174	7.127	7.230	7.294	7.432
Average	7.184	7.298	7.310	7.374	7.431	7.518
Max	7.184	7.406	7.417	7.529	7.627	7.627
UL	12.000	12.000	12.000	12.000	12.000	12.000

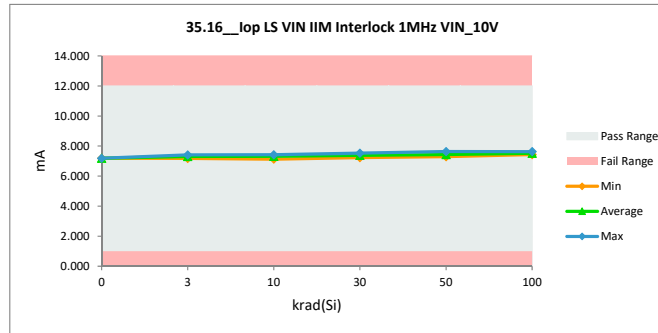

TID HDR Report
TPS7H6003-SP (5962R2220101VXC)

35.17_Top HS BOOT IIM Interlock		
Test Site	DAL-FL	DAL-FL
Tester	ETS364	ETS364
Test Number	EB672302	EB672302
Unit	mA	mA
Max Limit	8	8
Min Limit	1	1

krad(Si)	Serial #	pre_short (rtp)	(2)ST_Combo (rpt)	Delta
0	Ctrl	5.225	5.225	0.000
3	58	5.205	5.229	0.024
3	59	5.286	5.287	0.001
3	60	5.174	5.199	0.025
3	61	5.197	5.206	0.009
3	62	5.208	5.210	0.003
3	134	5.253	5.295	0.042
3	137	5.318	5.297	-0.021
3	138	5.306	5.281	-0.025
3	139	5.418	5.407	-0.011
3	236	5.258	5.499	0.242
10	63	5.295	5.327	0.032
10	64	5.307	5.318	0.011
10	65	5.236	5.254	0.018
10	66	5.213	5.241	0.028
10	150	5.342	5.344	0.002
10	237	5.345	5.490	0.145
10	241	5.277	5.292	0.015
10	242	5.263	5.275	0.012
10	243	5.231	5.243	0.011
10	244	5.288	5.286	-0.002
30	141	5.359	5.455	0.096
30	144	5.213	5.300	0.087
30	145	5.346	5.386	0.040
30	146	5.239	5.331	0.092
30	147	5.355	5.427	0.072
30	132	5.140	5.204	0.064
30	133	5.353	5.453	0.100
30	135	5.357	5.186	-0.170
30	245	5.391	5.473	0.082
30	246	5.356	5.466	0.110
50	67	5.315	5.437	0.122
50	68	5.223	5.520	0.297
50	69	5.293	5.421	0.129
50	71	5.193	5.344	0.151
50	72	5.357	5.489	0.132
50	172	5.331	5.450	0.119
50	173	5.237	5.385	0.148
50	174	5.369	5.510	0.141
50	183	5.243	5.419	0.176
50	186	5.222	5.370	0.148
100	95	5.313	5.515	0.203
100	102	5.137	5.326	0.189
100	104	5.203	5.456	0.254
100	105	5.239	5.468	0.229
100	106	5.195	5.386	0.191
100	178	5.407	5.675	0.268
100	179	5.265	5.529	0.264
100	180	5.228	5.437	0.208
100	181	5.256	5.502	0.246
100	182	5.269	5.542	0.273
	Max	5.418	5.675	0.297
	Average	5.275	5.374	0.098
	Min	5.137	5.186	-0.170
	Std Dev	0.068	0.113	0.101

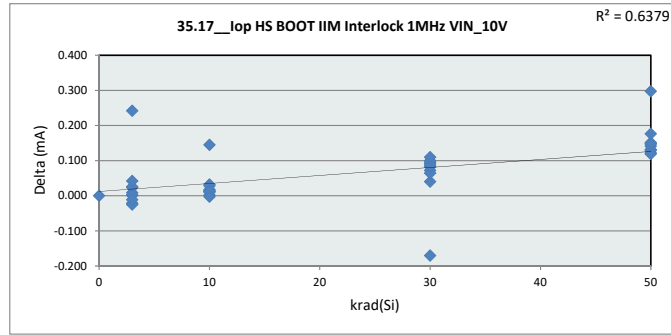

35.17_Top HS BOOT		
Test Site	DAL-FL	
Tester	ETS364	
Test Number	EB672302	
Max Limit	8	mA
Min Limit	1	mA

krad(Si)	0	3	10	30	50	100
LL	1.000	1.000	1.000	1.000	1.000	1.000
Min	5.225	5.199	5.242	5.186	5.344	5.326
Average	5.225	5.291	5.307	5.368	5.435	5.484
Max	5.225	5.500	5.490	5.473	5.520	5.675
UL	8.000	8.000	8.000	8.000	8.000	8.000

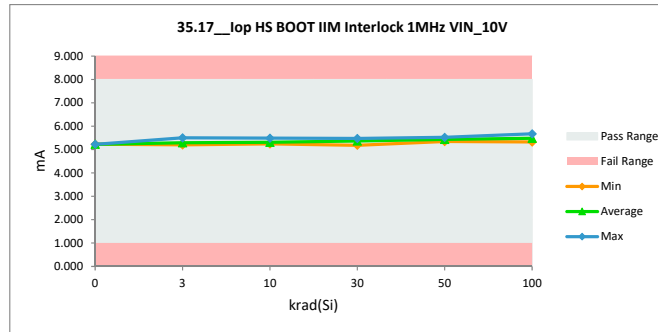

TID HDR Report
TPS7H6003-SP (5962R2220101VXC)

35.18_Top LS VIN IIM Interlock		
Test Site	DAL-FL	DAL-FL
Tester	ETS364	ETS364
Test Number	EB672302	EB672302
Unit	mA	mA
Max Limit	17	17
Min Limit	1	1

krad(Si)	Serial #	pre_short (rtp)	(2)ST_Combo (rpt)	Delta
0	Ctrl	10.107	10.107	0.000
3	58	10.193	10.207	0.013
3	59	10.116	10.123	0.008
3	60	10.055	10.068	0.013
3	61	10.154	10.174	0.020
3	62	10.181	10.171	-0.010
3	134	10.085	10.292	0.207
3	137	10.101	10.295	0.194
3	138	10.142	10.277	0.135
3	139	10.349	10.336	-0.014
3	236	10.122	10.307	0.185
10	63	10.310	10.332	0.022
10	64	10.298	10.312	0.014
10	65	10.209	10.226	0.017
10	66	10.023	10.038	0.015
10	150	10.204	10.197	-0.007
10	237	10.232	10.300	0.068
10	241	10.350	10.288	-0.062
10	242	10.116	10.135	0.019
10	243	10.160	10.181	0.020
10	244	10.366	10.340	-0.025
30	141	10.224	10.335	0.112
30	144	10.165	10.280	0.115
30	145	10.334	10.447	0.113
30	146	10.203	10.287	0.084
30	147	10.323	10.407	0.084
30	132	10.146	10.240	0.094
30	133	10.347	10.479	0.132
30	135	10.369	10.167	-0.202
30	245	10.161	10.272	0.111
30	246	10.255	10.342	0.088
50	67	10.264	10.448	0.183
50	68	10.037	10.465	0.428
50	69	10.252	10.438	0.186
50	71	10.162	10.395	0.233
50	72	10.142	10.340	0.198
50	172	10.353	10.618	0.265
50	173	10.137	10.268	0.131
50	174	10.057	10.279	0.221
50	183	10.122	10.318	0.196
50	186	10.245	10.443	0.198
100	95	10.249	10.604	0.355
100	102	10.124	10.455	0.331
100	104	10.127	10.490	0.363
100	105	10.151	10.541	0.389
100	106	10.224	10.426	0.202
100	178	10.272	10.631	0.359
100	179	10.211	10.489	0.278
100	180	10.219	10.493	0.274
100	181	10.047	10.425	0.378
100	182	10.122	10.506	0.384
	Max	10.369	10.631	0.428
	Average	10.194	10.334	0.140
	Min	10.023	10.038	-0.202
	Std Dev	0.094	0.141	0.140

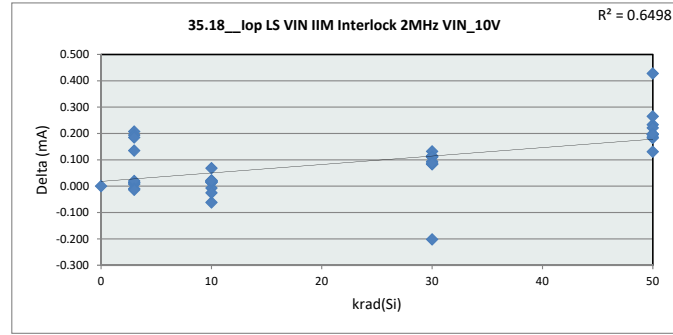

35.18_Top LS VIN I		
Test Site	DAL-FL	
Tester	ETS364	
Test Number	EB672302	
Max Limit	17	mA
Min Limit	1	mA

krad(Si)	0	3	10	30	50	100
LL	1.000	1.000	1.000	1.000	1.000	1.000
Min	10.107	10.068	10.038	10.167	10.268	10.425
Average	10.107	10.225	10.235	10.326	10.401	10.506
Max	10.107	10.336	10.340	10.479	10.618	10.631
UL	17.000	17.000	17.000	17.000	17.000	17.000

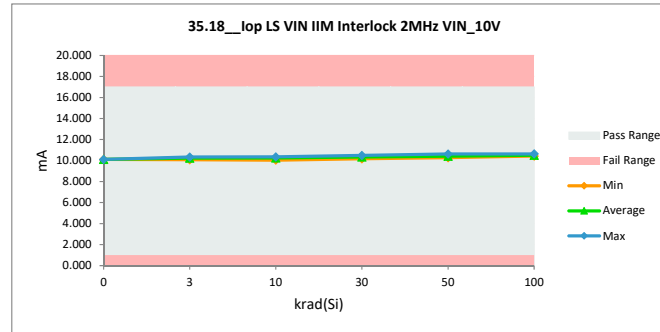

TID HDR Report
TPS7H6003-SP (5962R2220101VXC)

35.19_Top HS BOOT IIM Interlock		
Test Site	DAL-FL	DAL-FL
Tester	ETS364	ETS364
Test Number	EB672302	EB672302
Unit	mA	mA
Max Limit	10.5	10.5
Min Limit	1	1

krad(Si)	Serial #	pre_short (rtp)	(2)'ST_Combo (rpt)	Delta
0	Ctrl	6.883	6.883	0.000
3	58	6.856	6.889	0.032
3	59	6.929	6.941	0.012
3	60	6.811	6.846	0.035
3	61	6.842	6.858	0.016
3	62	6.852	6.869	0.017
3	134	6.897	6.952	0.056
3	137	6.967	6.955	-0.012
3	138	6.952	6.938	-0.014
3	139	7.062	7.057	-0.005
3	236	6.894	7.152	0.258
10	63	6.936	6.978	0.043
10	64	6.956	6.972	0.016
10	65	6.884	6.909	0.026
10	66	6.857	6.893	0.036
10	150	6.990	7.000	0.010
10	237	6.979	7.143	0.165
10	241	6.911	6.948	0.037
10	242	6.909	6.931	0.023
10	243	6.880	6.903	0.023
10	244	6.926	6.930	0.004
30	141	7.004	7.114	0.109
30	144	6.852	6.948	0.095
30	145	7.001	7.047	0.046
30	146	6.877	6.978	0.101
30	147	6.991	7.069	0.077
30	132	6.788	6.858	0.069
30	133	6.994	7.101	0.107
30	135	6.996	6.836	-0.161
30	245	7.040	7.128	0.088
30	246	6.985	7.106	0.120
50	67	6.956	7.089	0.134
50	68	6.867	7.179	0.313
50	69	6.929	7.072	0.143
50	71	6.835	6.994	0.159
50	72	6.987	7.129	0.143
50	172	6.970	7.097	0.127
50	173	6.878	7.031	0.153
50	174	7.017	7.174	0.157
50	183	6.882	7.065	0.183
50	186	6.872	7.028	0.157
100	95	6.956	7.163	0.207
100	102	6.769	6.972	0.203
100	104	6.845	7.117	0.272
100	105	6.884	7.128	0.244
100	106	6.836	7.027	0.191
100	178	7.044	7.320	0.277
100	179	6.915	7.191	0.276
100	180	6.869	7.097	0.228
100	181	6.904	7.156	0.252
100	182	6.920	7.208	0.288
Max		7.062	7.320	0.313
Average		6.918	7.027	0.109
Min		6.769	6.836	-0.161
Std Dev		0.068	0.113	0.102

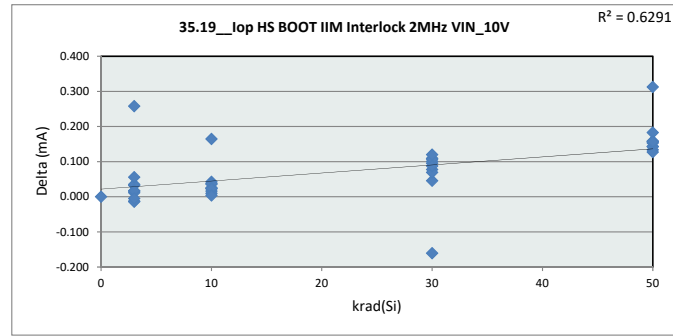

35.19_Top HS BOOT IIM Interlock 2MHz VIN_10V						
Test Site	DAL-FL					
Tester	ETS364					
Test Number	EB672302					
Max Limit	10.5	mA				
Min Limit	1	mA				
krad(Si)	0	3	10	30	50	100
LL	1.000	1.000	1.000	1.000	1.000	1.000
Min	6.883	6.847	6.893	6.836	6.994	6.972
Average	6.883	6.946	6.961	7.018	7.086	7.138
Max	6.883	7.152	7.143	7.128	7.179	7.320
UL	10.500	10.500	10.500	10.500	10.500	10.500

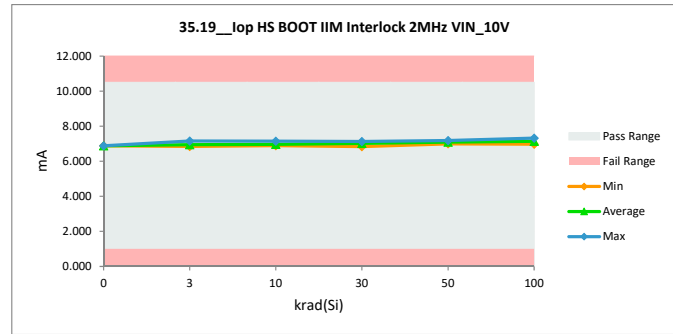

TID HDR Report
TPS7H6003-SP (5962R2220101VXC)

35.20_Top LS VIN IIM Interlock		
Test Site	DAL-FL	DAL-FL
Tester	ETS364	ETS364
Test Number	EB672302	EB672302
Unit	mA	mA
Max Limit	30	30
Min Limit	1	1

krad(Si)	Serial #	pre_short (rtp)	(2)ST_Comb (rpt)	Delta
0	Ctrl	19.174	19.174	0.000
3	58	19.261	19.253	-0.007
3	59	19.187	19.167	-0.020
3	60	19.032	19.025	-0.007
3	61	19.262	19.256	-0.006
3	62	19.254	19.241	-0.013
3	134	19.182	19.395	0.213
3	137	19.172	19.396	0.224
3	138	19.222	19.383	0.161
3	139	19.447	19.376	-0.071
3	236	19.169	19.317	0.148
10	63	19.405	19.406	0.001
10	64	19.395	19.398	0.002
10	65	19.270	19.291	0.021
10	66	19.040	19.056	0.016
10	150	19.339	19.291	-0.048
10	237	19.324	19.307	-0.017
10	241	19.407	19.395	-0.012
10	242	19.110	19.111	0.001
10	243	19.195	19.210	0.014
10	244	19.402	19.385	-0.016
30	141	19.342	19.498	0.156
30	144	19.290	19.439	0.149
30	145	19.506	19.645	0.139
30	146	19.217	19.341	0.125
30	147	19.406	19.535	0.128
30	132	19.241	19.375	0.134
30	133	19.432	19.607	0.175
30	135	19.428	19.278	-0.151
30	245	19.244	19.363	0.119
30	246	19.354	19.476	0.123
50	67	19.330	19.598	0.269
50	68	19.071	19.701	0.631
50	69	19.381	19.658	0.277
50	71	19.274	19.593	0.318
50	72	19.170	19.445	0.275
50	172	19.453	19.864	0.411
50	173	19.179	19.376	0.197
50	174	19.189	19.515	0.326
50	183	19.245	19.535	0.290
50	186	19.337	19.619	0.283
100	95	19.333	19.856	0.523
100	102	19.129	19.671	0.542
100	104	19.152	19.653	0.502
100	105	19.199	19.862	0.662
100	106	19.271	19.572	0.300
100	178	19.372	19.930	0.558
100	179	19.293	19.741	0.448
100	180	19.345	19.710	0.365
100	181	19.122	19.663	0.541
100	182	19.179	19.749	0.570
Max		19.506	19.930	0.662
Average		19.269	19.465	0.195
Min		19.032	19.025	-0.151
Std Dev		0.114	0.216	0.210

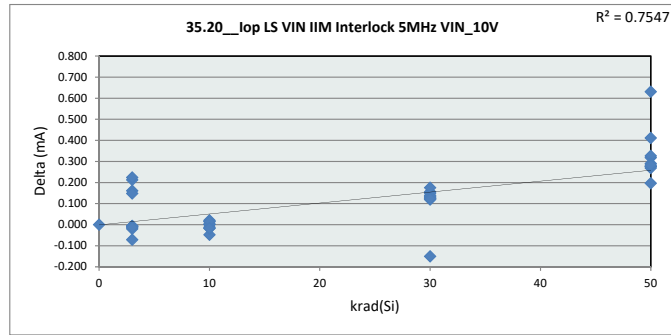

35.20_Top LS VIN		
Test Site	DAL-FL	
Tester	ETS364	
Test Number	EB672302	
Max Limit	30	mA
Min Limit	1	mA

krad(Si)	0	3	10	30	50	100
LL	1.000	1.000	1.000	1.000	1.000	1.000
Min	19.174	19.025	19.056	19.278	19.376	19.572
Average	19.174	19.281	19.285	19.456	19.590	19.741
Max	19.174	19.396	19.406	19.645	19.864	19.930
UL	30.000	30.000	30.000	30.000	30.000	30.000

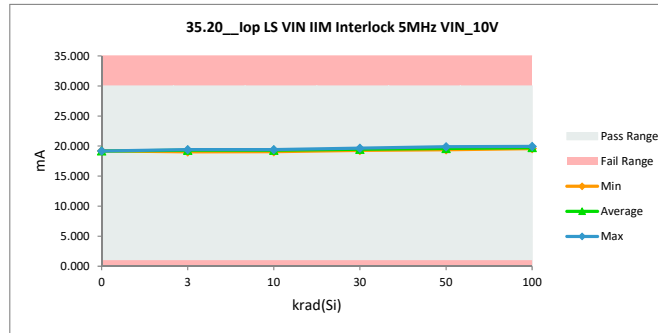

TID HDR Report
TPS7H6003-SP (5962R2220101VXC)

35.21_Top HS BOOT IIM Interlock		
Test Site	DAL-FL	DAL-FL
Tester	ETS364	ETS364
Test Number	EB672302	EB672302
Unit	mA	mA
Max Limit	15	15
Min Limit	1	1

krad(Si)	Serial #	pre_short (rtp)	(2)ST_Combo (rpt)	Delta
0	Ctrl	11.646	11.646	0.000
3	58	11.638	11.606	-0.033
3	59	11.698	11.701	0.003
3	60	11.556	11.562	0.007
3	61	11.610	11.566	-0.043
3	62	11.635	11.640	0.005
3	134	11.654	11.637	-0.017
3	137	11.763	11.640	-0.123
3	138	11.699	11.628	-0.071
3	139	11.809	11.729	-0.080
3	236	11.646	11.804	0.158
10	63	11.671	11.722	0.051
10	64	11.745	11.678	-0.067
10	65	11.642	11.657	0.015
10	66	11.645	11.593	-0.052
10	150	11.771	11.751	-0.020
10	237	11.715	11.796	0.081
10	241	11.663	11.639	-0.024
10	242	11.705	11.707	0.002
10	243	11.685	11.690	0.005
10	244	11.698	11.596	-0.102
30	141	11.785	11.880	0.095
30	144	11.592	11.687	0.095
30	145	11.765	11.746	-0.019
30	146	11.658	11.741	0.083
30	147	11.743	11.722	-0.020
30	132	11.585	11.539	-0.045
30	133	11.727	11.763	0.036
30	135	11.710	11.539	-0.171
30	245	11.821	11.830	0.009
30	246	11.698	11.804	0.106
50	67	11.691	11.757	0.065
50	68	11.658	11.893	0.234
50	69	11.624	11.794	0.170
50	71	11.594	11.709	0.114
50	72	11.736	11.838	0.102
50	172	11.708	11.756	0.048
50	173	11.653	11.707	0.054
50	174	11.770	11.941	0.171
50	183	11.641	11.746	0.105
50	186	11.637	11.715	0.078
100	95	11.712	11.832	0.120
100	102	11.521	11.705	0.184
100	104	11.607	11.899	0.292
100	105	11.649	11.863	0.214
100	106	11.592	11.711	0.119
100	178	11.759	11.961	0.202
100	179	11.727	11.907	0.180
100	180	11.604	11.867	0.264
100	181	11.691	11.846	0.155
100	182	11.726	11.942	0.217
Max		11.821	11.961	0.292
Average		11.680	11.738	0.058
Min		11.521	11.539	-0.171
Std Dev		0.066	0.109	0.105

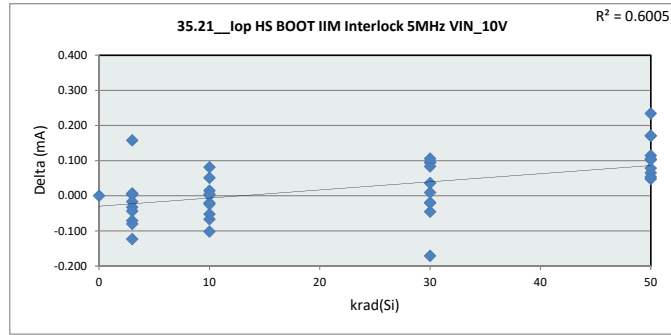

35.21_Top HS BOOT IIM Interlock 5MHz VIN_10V		
Test Site	DAL-FL	DAL-FL
Tester	ETS364	ETS364
Test Number	EB672302	EB672302
Max Limit	15	mA
Min Limit	1	mA

krad(Si)	0	3	10	30	50	100
LL	1.000	1.000	1.000	1.000	1.000	1.000
Min	11.646	11.562	11.593	11.539	11.707	11.705
Average	11.646	11.651	11.683	11.725	11.786	11.853
Max	11.646	11.804	11.796	11.880	11.941	11.961
UL	15.000	15.000	15.000	15.000	15.000	15.000

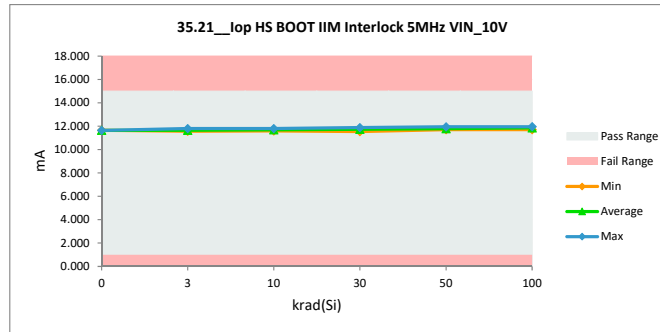

TID HDR Report
TPS7H6003-SP (5962R2220101VXC)

36.0 Iq LS VIN PWM VIN_12V		
Test Site	DAL-FL	DAL-FL
Tester	ETS364	ETS364
Test Number	EB672302	EB672302
Unit	mA	mA
Max Limit	6.8	6.8
Min Limit	1	1

krad(Si)	Serial #	pre_short (rtp)	(2)ST_Combo (rpt)	Delta
0	Ctrl	4.213	4.213	0.000
3	58	4.303	4.311	0.008
3	59	4.248	4.257	0.009
3	60	4.231	4.244	0.013
3	61	4.263	4.280	0.017
3	62	4.273	4.261	-0.012
3	134	4.192	4.382	0.191
3	137	4.218	4.384	0.166
3	138	4.243	4.371	0.129
3	139	4.464	4.453	-0.010
3	236	4.248	4.440	0.192
10	63	4.417	4.433	0.016
10	64	4.380	4.391	0.011
10	65	4.291	4.303	0.012
10	66	4.158	4.169	0.011
10	150	4.298	4.292	-0.006
10	237	4.344	4.434	0.090
10	241	4.478	4.380	-0.098
10	242	4.281	4.291	0.010
10	243	4.277	4.290	0.013
10	244	4.504	4.472	-0.032
30	141	4.308	4.389	0.081
30	144	4.229	4.313	0.083
30	145	4.404	4.484	0.080
30	146	4.349	4.416	0.067
30	147	4.418	4.483	0.065
30	132	4.227	4.302	0.075
30	133	4.452	4.558	0.106
30	135	4.483	4.261	-0.222
30	245	4.254	4.346	0.092
30	246	4.361	4.428	0.067
50	67	4.378	4.516	0.139
50	68	4.164	4.470	0.307
50	69	4.348	4.483	0.135
50	71	4.279	4.458	0.180
50	72	4.269	4.426	0.158
50	172	4.451	4.618	0.167
50	173	4.252	4.335	0.083
50	174	4.147	4.307	0.160
50	183	4.225	4.360	0.135
50	186	4.332	4.474	0.142
100	95	4.337	4.617	0.280
100	102	4.270	4.508	0.239
100	104	4.276	4.565	0.290
100	105	4.264	4.515	0.251
100	106	4.338	4.511	0.174
100	178	4.372	4.626	0.253
100	179	4.307	4.502	0.195
100	180	4.289	4.527	0.237
100	181	4.164	4.447	0.283
100	182	4.230	4.510	0.280
	Max	4.504	4.626	0.307
	Average	4.304	4.408	0.104
	Min	4.147	4.169	-0.222
	Std Dev	0.090	0.111	0.110

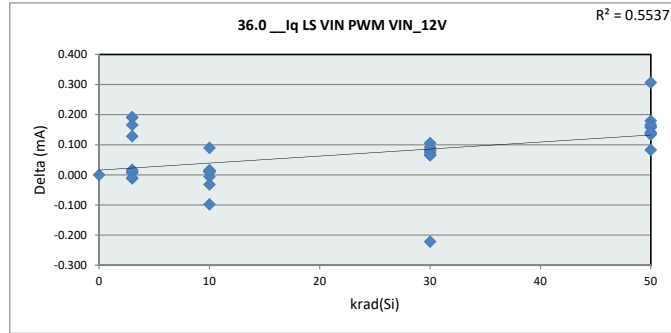

36.0 Iq LS VIN PWM VIN_12V						
Test Site	DAL-FL					
Tester	ETS364					
Test Number	EB672302					
Max Limit	6.8 mA					
Min Limit	1 mA					
krad(Si)	0	3	10	30	50	100
LL	1.000	1.000	1.000	1.000	1.000	1.000
Min	4.213	4.244	4.169	4.261	4.307	4.447
Average	4.213	4.338	4.346	4.398	4.445	4.533
Max	4.213	4.454	4.472	4.558	4.618	4.626
UL	6.800	6.800	6.800	6.800	6.800	6.800

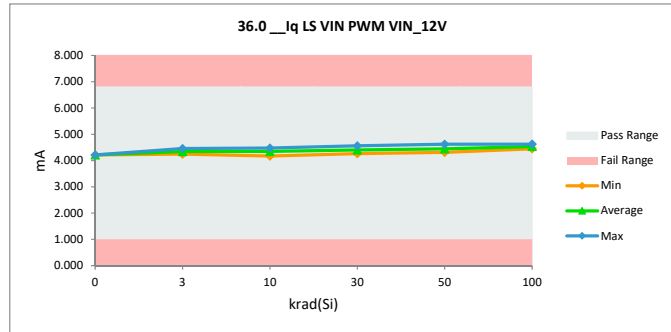

TID HDR Report
TPS7H6003-SP (5962R2220101VXC)

36.1 Iq HS BOOT PWM VIN_12V		
Test Site	DAL-FL	DAL-FL
Tester	ETS364	ETS364
Test Number	EB672302	EB672302
Unit	mA	mA
Max Limit	6.3	6.3
Min Limit	1	1

krad(Si)	Serial #	pre_short (rtp)	(2)ST_Combo (rpt)	Delta
0	Ctrl	3.585	3.585	0.000
3	58	3.571	3.583	0.012
3	59	3.661	3.649	-0.012
3	60	3.554	3.569	0.015
3	61	3.570	3.570	-0.001
3	62	3.580	3.571	-0.009
3	134	3.630	3.654	0.024
3	137	3.688	3.656	-0.032
3	138	3.681	3.641	-0.041
3	139	3.794	3.774	-0.020
3	236	3.638	3.862	0.223
10	63	3.674	3.696	0.022
10	64	3.677	3.677	0.000
10	65	3.609	3.617	0.008
10	66	3.588	3.608	0.020
10	150	3.713	3.707	-0.006
10	237	3.728	3.853	0.125
10	241	3.659	3.650	-0.009
10	242	3.637	3.635	-0.003
10	243	3.601	3.600	-0.001
10	244	3.670	3.657	-0.013
30	141	3.730	3.815	0.085
30	144	3.595	3.669	0.074
30	145	3.709	3.741	0.032
30	146	3.620	3.700	0.080
30	147	3.736	3.801	0.065
30	132	3.508	3.569	0.061
30	133	3.731	3.820	0.089
30	135	3.736	3.556	-0.179
30	245	3.761	3.833	0.072
30	246	3.745	3.843	0.098
50	67	3.693	3.802	0.109
50	68	3.601	3.881	0.280
50	69	3.674	3.793	0.119
50	71	3.570	3.711	0.141
50	72	3.745	3.864	0.119
50	172	3.709	3.819	0.110
50	173	3.619	3.758	0.140
50	174	3.740	3.870	0.130
50	183	3.621	3.788	0.167
50	186	3.593	3.732	0.139
100	95	3.688	3.882	0.194
100	102	3.522	3.699	0.177
100	104	3.576	3.810	0.234
100	105	3.614	3.827	0.213
100	106	3.572	3.761	0.189
100	178	3.787	4.044	0.257
100	179	3.635	3.887	0.253
100	180	3.608	3.800	0.192
100	181	3.627	3.867	0.240
100	182	3.638	3.891	0.253
	Max	3.794	4.044	0.280
	Average	3.651	3.738	0.087
	Min	3.508	3.556	-0.179
	Std Dev	0.069	0.114	0.100

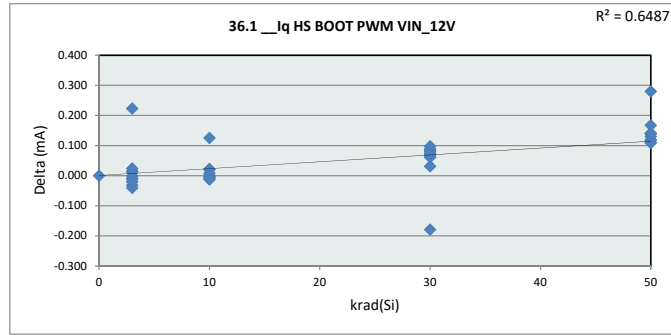

36.1 Iq HS BOOT		
Test Site	DAL-FL	
Tester	ETS364	
Test Number	EB672302	
Max Limit	6.3	mA
Min Limit	1	mA

krad(Si)	0	3	10	30	50	100
LL	1.000	1.000	1.000	1.000	1.000	1.000
Min	3.585	3.569	3.600	3.557	3.711	3.699
Average	3.585	3.653	3.670	3.735	3.802	3.847
Max	3.585	3.862	3.853	3.843	3.881	4.044
UL	6.300	6.300	6.300	6.300	6.300	6.300

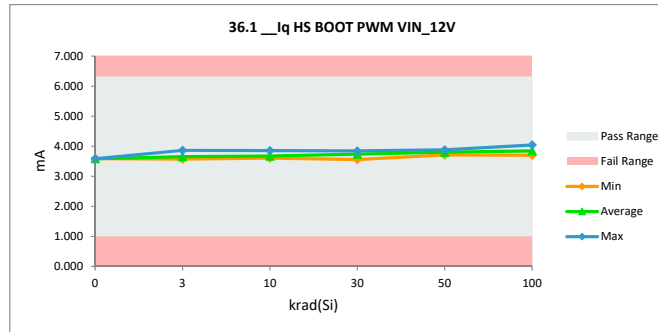

TID HDR Report
TPS7H6003-SP (5962R2220101VXC)

36.2 Iq LS VIN IIM Interlock V		
Test Site	DAL-FL	DAL-FL
Tester	ETS364	ETS364
Test Number	EB672302	EB672302
Unit	mA	mA
Max Limit	8	8
Min Limit	1	1

krad(Si)	Serial #	pre_short (rtp)	(2)'ST_Combo (rpt)	Delta
0	Ctrl	4.141	4.141	0.000
3	58	4.233	4.240	0.007
3	59	4.178	4.188	0.010
3	60	4.160	4.173	0.013
3	61	4.193	4.210	0.017
3	62	4.202	4.190	-0.012
3	134	4.121	4.311	0.190
3	137	4.147	4.312	0.165
3	138	4.171	4.299	0.128
3	139	4.391	4.382	-0.010
3	236	4.178	4.369	0.190
10	63	4.347	4.362	0.015
10	64	4.309	4.321	0.012
10	65	4.220	4.233	0.012
10	66	4.088	4.098	0.011
10	150	4.227	4.220	-0.007
10	237	4.273	4.363	0.089
10	241	4.406	4.308	-0.098
10	242	4.210	4.221	0.011
10	243	4.206	4.218	0.012
10	244	4.433	4.401	-0.032
30	141	4.236	4.317	0.082
30	144	4.157	4.241	0.084
30	145	4.332	4.413	0.081
30	146	4.279	4.345	0.066
30	147	4.347	4.410	0.064
30	132	4.156	4.230	0.074
30	133	4.381	4.488	0.106
30	135	4.411	4.189	-0.223
30	245	4.183	4.273	0.090
30	246	4.291	4.357	0.066
50	67	4.307	4.443	0.136
50	68	4.094	4.399	0.305
50	69	4.277	4.411	0.134
50	71	4.208	4.384	0.176
50	72	4.197	4.356	0.159
50	172	4.379	4.545	0.166
50	173	4.181	4.263	0.082
50	174	4.076	4.234	0.158
50	183	4.155	4.287	0.132
50	186	4.261	4.403	0.141
100	95	4.265	4.543	0.279
100	102	4.199	4.436	0.237
100	104	4.206	4.494	0.288
100	105	4.193	4.442	0.249
100	106	4.268	4.439	0.172
100	178	4.301	4.553	0.252
100	179	4.236	4.429	0.193
100	180	4.218	4.454	0.236
100	181	4.093	4.374	0.281
100	182	4.159	4.440	0.281
	Max	4.433	4.553	0.305
	Average	4.233	4.336	0.103
	Min	4.076	4.098	-0.223
	Std Dev	0.089	0.110	0.110

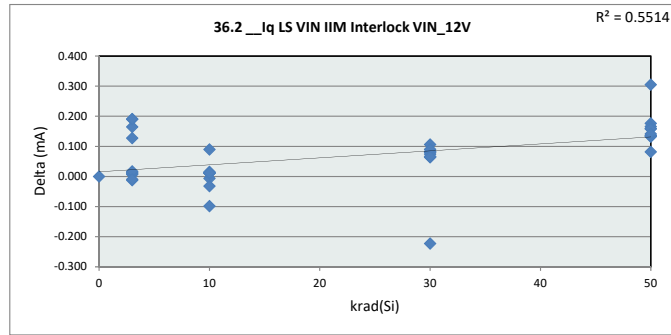

36.2 Iq LS VIN IIM						
Test Site	DAL-FL					
Tester	ETS364					
Test Number	EB672302					
Max Limit	8	mA				
Min Limit	1	mA				
krad(Si)	0	3	10	30	50	100
LL	1.000	1.000	1.000	1.000	1.000	1.000
Min	4.141	4.173	4.099	4.189	4.234	4.374
Average	4.141	4.267	4.275	4.326	4.372	4.460
Max	4.141	4.382	4.401	4.488	4.545	4.553
UL	8.000	8.000	8.000	8.000	8.000	8.000

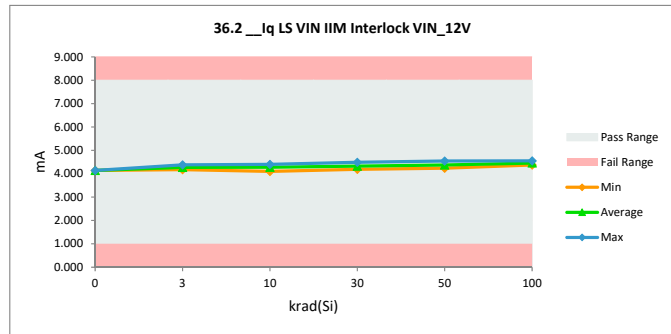

TID HDR Report
TPS7H6003-SP (5962R2220101VXC)

36.3 Iq HS BOOT IIM Interlock		
Test Site	DAL-FL	DAL-FL
Tester	ETS364	ETS364
Test Number	EB672302	EB672302
Unit	mA	mA
Max Limit	6.3	6.3
Min Limit	1	1

krad(Si)	Serial #	pre_short (rtp)	(2)'ST_Combo (rpt)	Delta
0	Ctrl	3.585	3.585	0.000
3	58	3.572	3.583	0.012
3	59	3.661	3.648	-0.012
3	60	3.554	3.569	0.014
3	61	3.570	3.569	-0.001
3	62	3.580	3.571	-0.009
3	134	3.629	3.654	0.025
3	137	3.689	3.655	-0.033
3	138	3.681	3.641	-0.040
3	139	3.794	3.773	-0.020
3	236	3.638	3.862	0.224
10	63	3.674	3.696	0.023
10	64	3.677	3.677	0.000
10	65	3.609	3.617	0.008
10	66	3.589	3.609	0.020
10	150	3.712	3.707	-0.005
10	237	3.728	3.853	0.125
10	241	3.658	3.650	-0.008
10	242	3.637	3.634	-0.003
10	243	3.601	3.600	-0.001
10	244	3.670	3.657	-0.013
30	141	3.730	3.815	0.085
30	144	3.594	3.669	0.074
30	145	3.709	3.742	0.033
30	146	3.620	3.700	0.079
30	147	3.736	3.802	0.066
30	132	3.508	3.568	0.060
30	133	3.731	3.820	0.089
30	135	3.736	3.556	-0.180
30	245	3.761	3.832	0.071
30	246	3.745	3.842	0.097
50	67	3.693	3.802	0.109
50	68	3.601	3.881	0.280
50	69	3.674	3.793	0.120
50	71	3.570	3.711	0.141
50	72	3.745	3.864	0.119
50	172	3.709	3.819	0.110
50	173	3.618	3.758	0.139
50	174	3.739	3.871	0.132
50	183	3.621	3.788	0.167
50	186	3.593	3.731	0.138
100	95	3.688	3.881	0.194
100	102	3.522	3.697	0.176
100	104	3.576	3.810	0.234
100	105	3.613	3.826	0.213
100	106	3.572	3.763	0.191
100	178	3.788	4.044	0.257
100	179	3.635	3.887	0.253
100	180	3.607	3.799	0.192
100	181	3.626	3.866	0.240
100	182	3.638	3.890	0.251
	Max	3.794	4.044	0.280
	Average	3.651	3.738	0.087
	Min	3.508	3.556	-0.180
	Std Dev	0.069	0.114	0.100

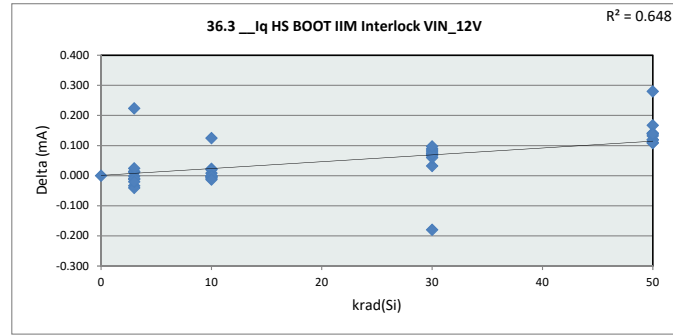

36.3 Iq HS BOOT		
Test Site	DAL-FL	
Tester	ETS364	
Test Number	EB672302	
Max Limit	6.3	mA
Min Limit	1	mA

krad(Si)	0	3	10	30	50	100
LL	1.000	1.000	1.000	1.000	1.000	1.000
Min	3.585	3.569	3.600	3.556	3.711	3.698
Average	3.585	3.653	3.670	3.734	3.802	3.846
Max	3.585	3.862	3.853	3.842	3.881	4.045
UL	6.300	6.300	6.300	6.300	6.300	6.300

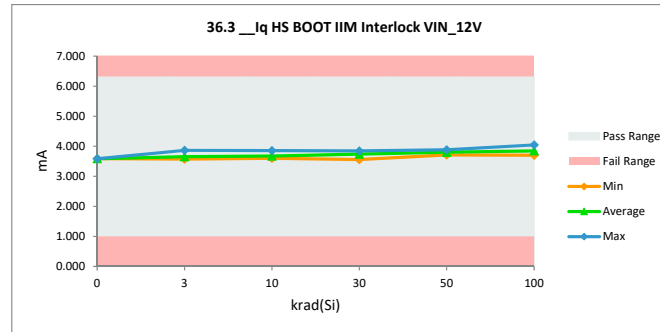

TID HDR Report
TPS7H6003-SP (5962R2220101VXC)

36.6 __Iop LS VIN PWM 500kHz		
Test Site	DAL-FL	DAL-FL
Tester	ETS364	ETS364
Test Number	EB672302	EB672302
Unit	mA	mA
Max Limit	9	9
Min Limit	1	1

krad(Si)	Serial #	pre_short (rtp)	(2)'ST_Combo (rpt)	Delta
0	Ctrl	6.334	6.334	0.000
3	58	6.402	6.403	0.001
3	59	6.287	6.293	0.006
3	60	6.293	6.299	0.006
3	61	6.339	6.351	0.012
3	62	6.391	6.377	-0.014
3	134	6.278	6.444	0.166
3	137	6.318	6.445	0.127
3	138	6.344	6.433	0.090
3	139	6.492	6.481	-0.011
3	236	6.357	6.508	0.150
10	63	6.516	6.514	-0.003
10	64	6.552	6.548	-0.005
10	65	6.468	6.463	-0.005
10	66	6.269	6.262	-0.006
10	150	6.365	6.347	-0.018
10	237	6.409	6.503	0.094
10	241	6.549	6.440	-0.109
10	242	6.361	6.361	0.000
10	243	6.430	6.435	0.005
10	244	6.549	6.508	-0.041
30	141	6.423	6.457	0.034
30	144	6.392	6.425	0.033
30	145	6.471	6.505	0.034
30	146	6.410	6.428	0.019
30	147	6.484	6.505	0.021
30	132	6.367	6.396	0.028
30	133	6.550	6.610	0.060
30	135	6.565	6.322	-0.243
30	245	6.379	6.425	0.046
30	246	6.406	6.432	0.026
50	67	6.517	6.567	0.050
50	68	6.287	6.561	0.274
50	69	6.431	6.491	0.060
50	71	6.310	6.418	0.108
50	72	6.386	6.458	0.072
50	172	6.568	6.688	0.120
50	173	6.378	6.400	0.022
50	174	6.212	6.317	0.104
50	183	6.269	6.347	0.078
50	186	6.474	6.552	0.079
100	95	6.473	6.603	0.130
100	102	6.341	6.451	0.110
100	104	6.336	6.492	0.156
100	105	6.400	6.518	0.118
100	106	6.446	6.464	0.018
100	178	6.479	6.621	0.141
100	179	6.419	6.498	0.079
100	180	6.428	6.527	0.099
100	181	6.252	6.418	0.166
100	182	6.372	6.536	0.164
	Max	6.568	6.688	0.274
	Average	6.403	6.455	0.052
	Min	6.212	6.262	-0.243
	Std Dev	0.090	0.091	0.081

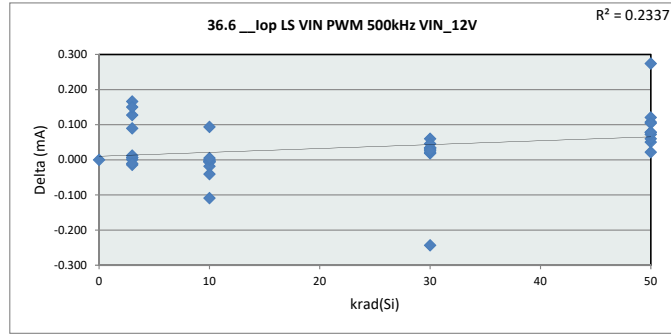

36.6 __Iop LS VIN P						
Test Site	DAL-FL					
Tester	ETS364					
Test Number	EB672302					
Max Limit	9	mA				
Min Limit	1	mA				
krad(Si)	0	3	10	30	50	100
LL	1.000	1.000	1.000	1.000	1.000	1.000
Min	6.334	6.293	6.263	6.322	6.317	6.418
Average	6.334	6.403	6.438	6.450	6.480	6.513
Max	6.334	6.508	6.548	6.610	6.688	6.621
UL	9.000	9.000	9.000	9.000	9.000	9.000

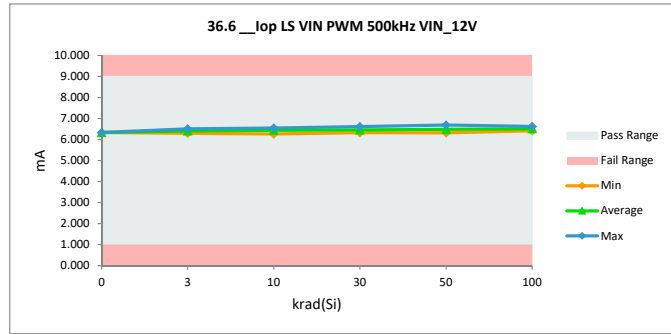

TID HDR Report
TPS7H6003-SP (5962R2220101VXC)

36.7 __Iop HS BOOT PWM 500kHz		
Test Site	DAL-FL	DAL-FL
Tester	ETS364	ETS364
Test Number	EB672302	EB672302
Unit	mA	mA
Max Limit	6.5	6.5
Min Limit	1	1

krad(Si)	Serial #	pre_short (rtp)	(2)ST_Combo (rpt)	Delta
0	Ctrl	4.414	4.414	0.000
3	58	4.399	4.416	0.017
3	59	4.484	4.481	-0.003
3	60	4.374	4.394	0.021
3	61	4.396	4.399	0.003
3	62	4.404	4.402	-0.002
3	134	4.453	4.486	0.033
3	137	4.516	4.487	-0.030
3	138	4.507	4.474	-0.033
3	139	4.618	4.604	-0.014
3	236	4.459	4.692	0.233
10	63	4.497	4.524	0.027
10	64	4.504	4.509	0.005
10	65	4.437	4.451	0.013
10	66	4.411	4.434	0.024
10	150	4.541	4.539	-0.002
10	237	4.547	4.683	0.136
10	241	4.479	4.483	0.004
10	242	4.461	4.464	0.003
10	243	4.427	4.432	0.004
10	244	4.492	4.484	-0.007
30	141	4.557	4.646	0.089
30	144	4.415	4.497	0.081
30	145	4.540	4.577	0.037
30	146	4.442	4.527	0.085
30	147	4.557	4.630	0.073
30	132	4.335	4.398	0.063
30	133	4.553	4.649	0.096
30	135	4.559	4.385	-0.174
30	245	4.589	4.665	0.076
30	246	4.564	4.669	0.105
50	67	4.518	4.634	0.115
50	68	4.425	4.712	0.286
50	69	4.496	4.623	0.127
50	71	4.394	4.540	0.145
50	72	4.562	4.689	0.128
50	172	4.532	4.647	0.115
50	173	4.438	4.580	0.142
50	174	4.567	4.704	0.137
50	183	4.442	4.615	0.173
50	186	4.419	4.565	0.146
100	95	4.514	4.711	0.197
100	102	4.341	4.527	0.186
100	104	4.399	4.645	0.245
100	105	4.436	4.658	0.223
100	106	4.395	4.585	0.190
100	178	4.608	4.871	0.263
100	179	4.459	4.721	0.262
100	180	4.431	4.634	0.203
100	181	4.454	4.700	0.246
100	182	4.463	4.726	0.263
	Max	4.618	4.871	0.286
	Average	4.475	4.568	0.093
	Min	4.335	4.385	-0.174
	Std Dev	0.069	0.114	0.100

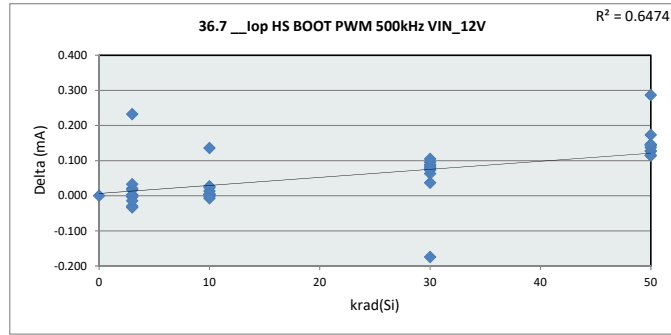

36.7 __Iop HS BOOT		
Test Site	DAL-FL	
Tester	ETS364	
Test Number	EB672302	
Max Limit	6.5	mA
Min Limit	1	mA

krad(Si)	0	3	10	30	50	100
LL	1.000	1.000	1.000	1.000	1.000	1.000
Min	4.414	4.394	4.432	4.385	4.540	4.527
Average	4.414	4.484	4.500	4.564	4.631	4.678
Max	4.414	4.692	4.683	4.669	4.712	4.871
UL	6.500	6.500	6.500	6.500	6.500	6.500

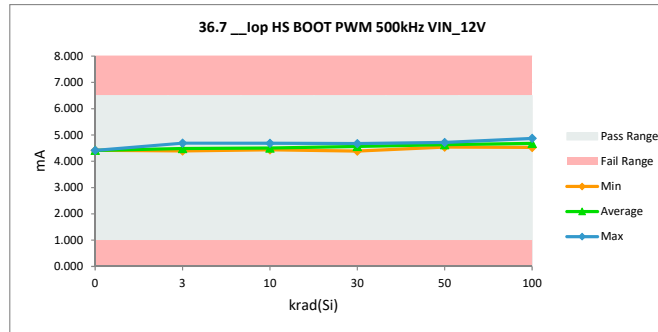

TID HDR Report
TPS7H6003-SP (5962R2220101VXC)

36.8 Iop LS VIN PWM 1MHz V		
Test Site	DAL-FL	DAL-FL
Tester	ETS364	ETS364
Test Number	EB672302	EB672302
Unit	mA	mA
Max Limit	11	11
Min Limit	1	1

krad(Si)	Serial #	pre_short (rtp)	(2)'ST_Combo (rpt)	Delta
0	Ctrl	8.033	8.033	0.000
3	58	8.099	8.103	0.004
3	59	7.973	7.979	0.006
3	60	7.971	7.979	0.008
3	61	8.035	8.047	0.012
3	62	8.088	8.075	-0.013
3	134	7.977	8.143	0.166
3	137	8.005	8.144	0.139
3	138	8.039	8.132	0.093
3	139	8.190	8.179	-0.010
3	236	8.046	8.202	0.156
10	63	8.215	8.217	0.002
10	64	8.250	8.250	-0.001
10	65	8.165	8.164	-0.002
10	66	7.955	7.950	-0.005
10	150	8.066	8.048	-0.018
10	237	8.106	8.196	0.089
10	241	8.244	8.140	-0.104
10	242	8.041	8.044	0.003
10	243	8.120	8.127	0.007
10	244	8.241	8.204	-0.037
30	141	8.122	8.169	0.047
30	144	8.095	8.141	0.046
30	145	8.180	8.228	0.048
30	146	8.097	8.125	0.028
30	147	8.186	8.217	0.030
30	132	8.067	8.107	0.040
30	133	8.251	8.322	0.071
30	135	8.258	8.023	-0.235
30	245	8.080	8.134	0.054
30	246	8.107	8.141	0.034
50	67	8.206	8.279	0.073
50	68	7.977	8.292	0.316
50	69	8.133	8.214	0.081
50	71	8.006	8.135	0.130
50	72	8.070	8.159	0.089
50	172	8.261	8.413	0.152
50	173	8.073	8.113	0.039
50	174	7.922	8.047	0.125
50	183	7.972	8.069	0.097
50	186	8.173	8.269	0.096
100	95	8.171	8.331	0.160
100	102	8.029	8.174	0.145
100	104	8.021	8.205	0.183
100	105	8.095	8.265	0.170
100	106	8.141	8.176	0.035
100	178	8.177	8.355	0.178
100	179	8.115	8.221	0.106
100	180	8.135	8.247	0.113
100	181	7.949	8.144	0.195
100	182	8.066	8.268	0.201
	Max	8.261	8.413	0.316
	Average	8.098	8.164	0.066
	Min	7.922	7.950	-0.235
	Std Dev	0.091	0.099	0.089

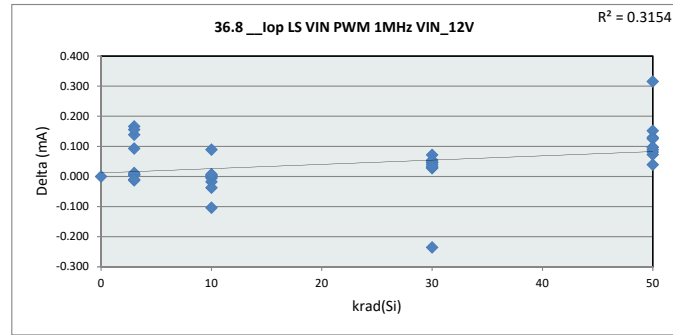

36.8 Iop LS VIN P						
Test Site	DAL-FL					
Tester	ETS364					
Test Number	EB672302					
Max Limit	11	mA				
Min Limit	1	mA				
krad(Si)	0	3	10	30	50	100
LL	1.000	1.000	1.000	1.000	1.000	1.000
Min	8.033	7.979	7.950	8.023	8.047	8.144
Average	8.033	8.098	8.134	8.161	8.199	8.239
Max	8.033	8.202	8.250	8.322	8.413	8.355
UL	11.000	11.000	11.000	11.000	11.000	11.000

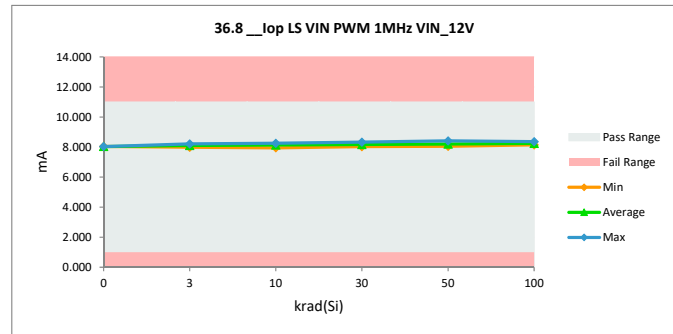

TID HDR Report
TPS7H6003-SP (5962R2220101VXC)

36.9 Iop HS BOOT PWM 1MHz		
Test Site	DAL-FL	DAL-FL
Tester	ETS364	ETS364
Test Number	EB672302	EB672302
Unit	mA	mA
Max Limit	8	8
Min Limit	1	1

krad(Si)	Serial #	pre_short (rtp)	(2)'ST_Combo (rpt)	Delta
0	Ctrl	5.244	5.244	0.000
3	58	5.224	5.248	0.025
3	59	5.306	5.309	0.003
3	60	5.191	5.218	0.026
3	61	5.215	5.226	0.011
3	62	5.224	5.231	0.006
3	134	5.272	5.317	0.045
3	137	5.342	5.319	-0.023
3	138	5.330	5.305	-0.025
3	139	5.441	5.431	-0.010
3	236	5.277	5.522	0.245
10	63	5.317	5.349	0.032
10	64	5.328	5.339	0.011
10	65	5.260	5.280	0.020
10	66	5.229	5.259	0.030
10	150	5.367	5.370	0.003
10	237	5.364	5.511	0.147
10	241	5.297	5.313	0.017
10	242	5.282	5.294	0.012
10	243	5.248	5.263	0.015
10	244	5.309	5.309	0.000
30	141	5.380	5.480	0.100
30	144	5.234	5.323	0.089
30	145	5.367	5.408	0.040
30	146	5.260	5.351	0.091
30	147	5.376	5.451	0.075
30	132	5.158	5.228	0.070
30	133	5.374	5.478	0.104
30	135	5.379	5.211	-0.168
30	245	5.412	5.497	0.086
30	246	5.382	5.493	0.111
50	67	5.339	5.462	0.122
50	68	5.244	5.542	0.298
50	69	5.316	5.450	0.134
50	71	5.216	5.367	0.150
50	72	5.376	5.510	0.135
50	172	5.351	5.472	0.120
50	173	5.254	5.404	0.150
50	174	5.390	5.537	0.147
50	183	5.261	5.442	0.181
50	186	5.241	5.393	0.152
100	95	5.334	5.538	0.204
100	102	5.157	5.351	0.193
100	104	5.220	5.477	0.257
100	105	5.254	5.488	0.234
100	106	5.214	5.406	0.193
100	178	5.427	5.695	0.268
100	179	5.281	5.552	0.270
100	180	5.251	5.463	0.212
100	181	5.278	5.529	0.251
100	182	5.285	5.561	0.276
	Max	5.441	5.695	0.298
	Average	5.296	5.396	0.101
	Min	5.157	5.211	-0.168
	Std Dev	0.070	0.114	0.101

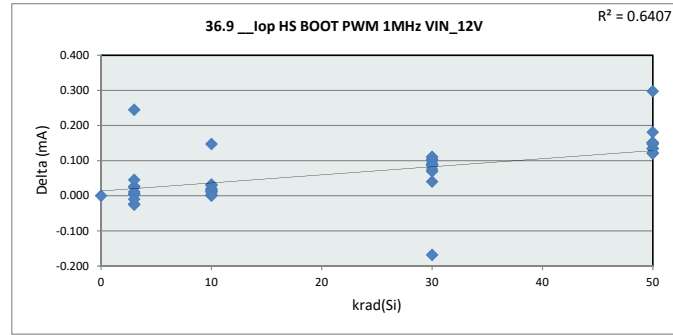

36.9 Iop HS BOOT		
Test Site	DAL-FL	
Tester	ETS364	
Test Number	EB672302	
Max Limit	8	mA
Min Limit	1	mA

krad(Si)	0	3	10	30	50	100
LL	1.000	1.000	1.000	1.000	1.000	1.000
Min	5.244	5.218	5.259	5.211	5.367	5.351
Average	5.244	5.313	5.329	5.392	5.458	5.506
Max	5.244	5.522	5.511	5.497	5.542	5.695
UL	8.000	8.000	8.000	8.000	8.000	8.000

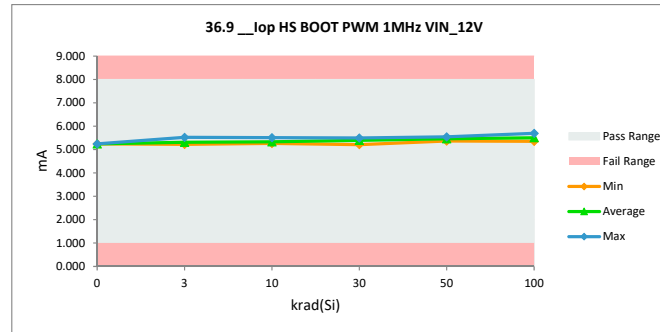

TID HDR Report
TPS7H6003-SP (5962R2220101VXC)

36.10_Top LS VIN PWM 2MHz V		
Test Site	DAL-FL	DAL-FL
Tester	ETS364	ETS364
Test Number	EB672302	EB672302
Unit	mA	mA
Max Limit	16	16
Min Limit	1	1

krad(Si)	Serial #	pre_short (rtp)	(2)ST_Combo (rpt)	Delta
0	Ctrl	11.408	11.408	0.000
3	58	11.468	11.481	0.013
3	59	11.334	11.352	0.018
3	60	11.313	11.332	0.019
3	61	11.411	11.423	0.012
3	62	11.472	11.456	-0.016
3	134	11.351	11.528	0.178
3	137	11.365	11.530	0.165
3	138	11.409	11.517	0.108
3	139	11.565	11.563	-0.002
3	236	11.408	11.573	0.164
10	63	11.594	11.603	0.009
10	64	11.628	11.629	0.000
10	65	11.546	11.566	0.020
10	66	11.305	11.306	0.001
10	150	11.449	11.448	-0.001
10	237	11.476	11.568	0.092
10	241	11.615	11.526	-0.089
10	242	11.377	11.390	0.013
10	243	11.487	11.496	0.010
10	244	11.602	11.578	-0.024
30	141	11.503	11.595	0.093
30	144	11.480	11.557	0.078
30	145	11.586	11.650	0.064
30	146	11.448	11.504	0.056
30	147	11.570	11.645	0.075
30	132	11.450	11.506	0.056
30	133	11.634	11.726	0.092
30	135	11.620	11.399	-0.220
30	245	11.455	11.541	0.086
30	246	11.501	11.570	0.069
50	67	11.565	11.694	0.130
50	68	11.334	11.731	0.397
50	69	11.509	11.660	0.150
50	71	11.382	11.550	0.169
50	72	11.417	11.568	0.152
50	172	11.624	11.870	0.246
50	173	11.440	11.525	0.085
50	174	11.318	11.505	0.187
50	183	11.354	11.518	0.163
50	186	11.555	11.682	0.127
100	95	11.543	11.792	0.249
100	102	11.383	11.630	0.247
100	104	11.368	11.645	0.277
100	105	11.470	11.757	0.288
100	106	11.507	11.596	0.089
100	178	11.552	11.832	0.280
100	179	11.487	11.682	0.195
100	180	11.521	11.696	0.175
100	181	11.319	11.610	0.291
100	182	11.433	11.734	0.301
	Max	11.634	11.870	0.397
	Average	11.469	11.573	0.105
	Min	11.305	11.306	-0.220
	Std Dev	0.095	0.124	0.115

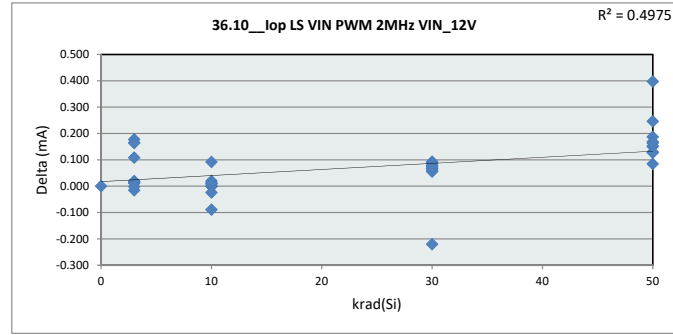

36.10_Top LS VIN PWM 2MHz V		
Test Site	DAL-FL	DAL-FL
Tester	ETS364	ETS364
Test Number	EB672302	EB672302
Max Limit	16	mA
Min Limit	1	mA

krad(Si)	0	3	10	30	50	100
LL	1.000	1.000	1.000	1.000	1.000	1.000
Min	11.408	11.332	11.306	11.399	11.506	11.596
Average	11.408	11.476	11.511	11.569	11.630	11.698
Max	11.408	11.573	11.629	11.726	11.870	11.832
UL	16.000	16.000	16.000	16.000	16.000	16.000

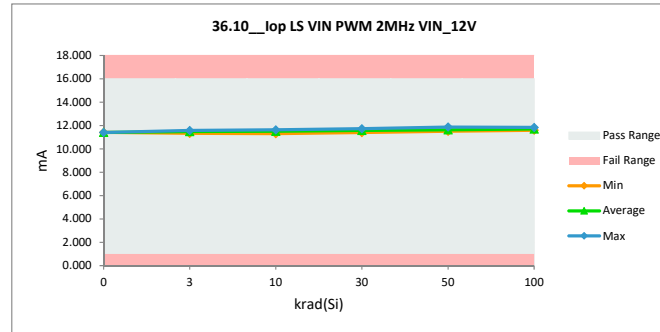

TID HDR Report
TPS7H6003-SP (5962R2220101VXC)

36.11_Top HS BOOT PWM 2MHz		
Test Site	DAL-FL	DAL-FL
Tester	ETS364	ETS364
Test Number	EB672302	EB672302
Unit	mA	mA
Max Limit	10.5	10.5
Min Limit	1	1

krad(Si)	Serial #	pre_short (rtp)	(2)ST_Combo (rpt)	Delta
0	Ctrl	6.890	6.890	0.000
3	58	6.889	6.925	0.036
3	59	6.959	6.976	0.017
3	60	6.843	6.872	0.028
3	61	6.861	6.892	0.031
3	62	6.868	6.898	0.030
3	134	6.924	6.994	0.069
3	137	6.997	6.994	-0.003
3	138	6.973	6.980	0.008
3	139	7.100	7.105	0.006
3	236	6.920	7.201	0.281
10	63	6.971	6.998	0.027
10	64	6.988	7.005	0.017
10	65	6.926	6.938	0.011
10	66	6.865	6.907	0.041
10	150	7.032	7.028	-0.004
10	237	6.994	7.191	0.197
10	241	6.950	6.989	0.038
10	242	6.940	6.950	0.010
10	243	6.908	6.929	0.020
10	244	6.964	6.977	0.013
30	141	7.047	7.148	0.102
30	144	6.886	6.979	0.093
30	145	7.029	7.076	0.047
30	146	6.912	7.006	0.093
30	147	7.031	7.121	0.090
30	132	6.823	6.904	0.081
30	133	7.031	7.150	0.119
30	135	7.023	6.864	-0.159
30	245	7.083	7.177	0.094
30	246	7.034	7.144	0.111
50	67	6.982	7.118	0.136
50	68	6.904	7.216	0.312
50	69	6.968	7.112	0.144
50	71	6.858	7.008	0.150
50	72	7.018	7.165	0.147
50	172	6.992	7.128	0.136
50	173	6.905	7.067	0.162
50	174	7.051	7.204	0.153
50	183	6.915	7.110	0.196
50	186	6.887	7.044	0.158
100	95	6.994	7.204	0.210
100	102	6.804	7.006	0.202
100	104	6.877	7.150	0.272
100	105	6.909	7.147	0.238
100	106	6.869	7.051	0.182
100	178	7.076	7.350	0.273
100	179	6.945	7.227	0.282
100	180	6.911	7.136	0.226
100	181	6.947	7.199	0.252
100	182	6.944	7.233	0.290
	Max	7.100	7.350	0.312
	Average	6.949	7.060	0.111
	Min	6.804	6.864	-0.159
	Std Dev	0.071	0.116	0.102

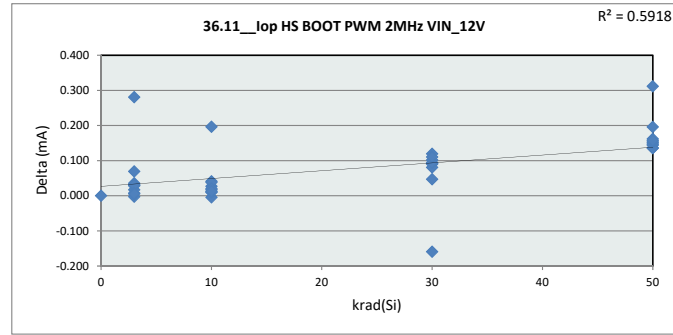

36.11_Top HS BOO

Test Site	DAL-FL
Tester	ETS364
Test Number	EB672302
Max Limit	10.5 mA
Min Limit	1 mA

krad(Si)	0	3	10	30	50	100
LL	1.000	1.000	1.000	1.000	1.000	1.000
Min	6.890	6.872	6.907	6.864	7.008	7.006
Average	6.890	6.984	6.991	7.057	7.117	7.170
Max	6.890	7.201	7.191	7.177	7.216	7.350
UL	10.500	10.500	10.500	10.500	10.500	10.500

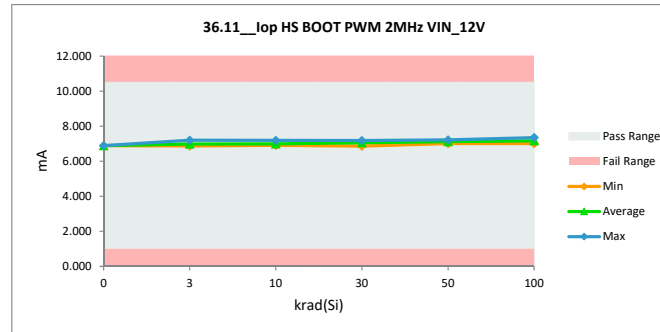

TID HDR Report
TPS7H6003-SP (5962R2220101VXC)

36.12_Top LS VIN PWM 5MHz V		
Test Site	DAL-FL	DAL-FL
Tester	ETS364	ETS364
Test Number	EB672302	EB672302
Unit	mA	mA
Max Limit	30	30
Min Limit	1	1

krad(Si)	Serial #	pre_short (rtp)	(2)ST_Combo (rpt)	Delta
0	Ctrl	20.233	20.233	0.000
3	58	18.018	18.024	0.006
3	59	18.184	18.256	0.072
3	60	17.999	18.042	0.043
3	61	18.181	18.196	0.015
3	62	18.061	18.044	-0.017
3	134	17.489	18.700	1.211
3	137	18.348	18.699	0.350
3	138	18.048	18.693	0.645
3	139	18.736	18.751	0.015
3	236	20.230	18.597	-1.633
10	63	18.458	18.487	0.029
10	64	17.851	18.015	0.164
10	65	18.464	18.496	0.032
10	66	17.898	18.007	0.108
10	150	18.058	18.132	0.074
10	237	18.533	18.597	0.063
10	241	18.604	18.701	0.097
10	242	17.671	17.763	0.092
10	243	18.132	18.299	0.167
10	244	18.555	18.504	-0.051
30	141	18.174	18.485	0.312
30	144	17.926	18.319	0.393
30	145	18.260	18.579	0.318
30	146	17.963	18.297	0.333
30	147	18.285	18.588	0.303
30	132	17.546	18.012	0.466
30	133	18.321	18.696	0.375
30	135	18.751	18.130	-0.621
30	245	18.183	18.479	0.296
30	246	17.827	18.153	0.326
50	67	18.323	18.694	0.371
50	68	20.323	18.836	-1.487
50	69	17.773	18.376	0.603
50	71	17.878	18.493	0.615
50	72	18.325	18.770	0.445
50	172	18.867	19.247	0.381
50	173	18.141	18.487	0.346
50	174	20.058	18.012	-2.046
50	183	17.887	18.359	0.472
50	186	18.015	18.613	0.598
100	95	18.257	18.674	0.417
100	102	17.840	18.735	0.894
100	104	18.090	18.816	0.726
100	105	18.011	18.908	0.896
100	106	17.807	18.534	0.727
100	178	18.139	19.072	0.933
100	179	17.664	18.574	0.910
100	180	18.909	18.414	-0.495
100	181	17.863	18.705	0.841
100	182	17.791	18.885	1.094
	Max	20.323	20.233	1.211
	Average	18.293	18.513	0.220
	Min	17.489	17.763	-2.046
	Std Dev	0.650	0.395	0.613

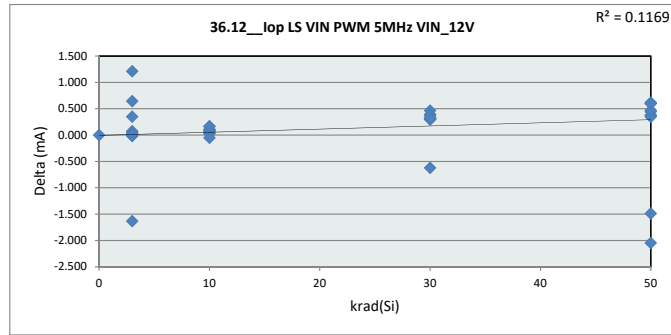

36.12_Top LS VIN PWM 5MHz V						
Test Site	DAL-FL					
Tester	ETS364					
Test Number	EB672302					
Max Limit	30	mA				
Min Limit	1	mA				
krad(Si)	0	3	10	30	50	100
LL	1.000	1.000	1.000	1.000	1.000	1.000
Min	20.233	18.024	17.763	18.012	18.012	18.415
Average	20.233	18.400	18.300	18.374	18.589	18.732
Max	20.233	18.751	18.701	18.696	19.248	19.072
UL	30.000	30.000	30.000	30.000	30.000	30.000

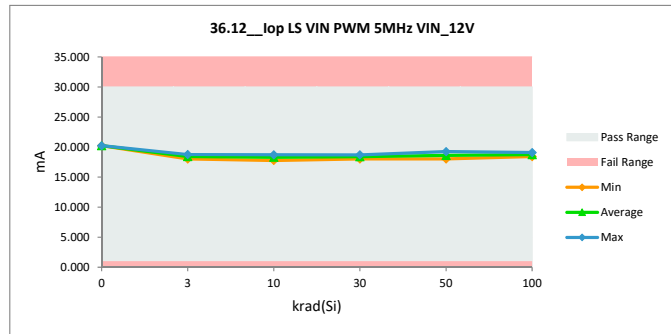

TID HDR Report
TPS7H6003-SP (5962R2220101VXC)

36.13 Top HS BOOT PWM 5MHz		
Test Site	DAL-FL	DAL-FL
Tester	ETS364	ETS364
Test Number	EB672302	EB672302
Unit	mA	mA
Max Limit	17.5	17.5
Min Limit	1	1

krad(Si)	Serial #	pre_short (rtp)	(2)ST_Combo (rpt)	Delta
0	Ctrl	13.399	13.399	0.000
3	58	12.713	13.116	0.403
3	59	11.273	12.035	0.762
3	60	12.049	12.608	0.559
3	61	10.892	10.913	0.022
3	62	10.856	11.093	0.238
3	134	13.571	11.486	-2.085
3	137	11.048	11.425	0.377
3	138	11.000	11.423	0.424
3	139	12.410	12.795	0.385
3	236	13.346	13.719	0.374
10	63	13.479	13.772	0.293
10	64	13.673	13.796	0.123
10	65	13.602	13.546	-0.056
10	66	10.768	10.916	0.148
10	150	13.743	13.784	0.041
10	237	10.994	13.741	2.747
10	241	13.235	11.419	-1.816
10	242	13.243	13.604	0.361
10	243	11.689	12.182	0.493
10	244	12.394	12.653	0.259
30	141	13.195	13.002	-0.193
30	144	12.421	12.392	-0.029
30	145	11.469	11.156	-0.313
30	146	12.498	12.357	-0.141
30	147	13.036	12.762	-0.274
30	132	12.590	12.451	-0.138
30	133	12.911	12.602	-0.308
30	135	10.990	10.566	-0.425
30	245	13.191	12.683	-0.508
30	246	13.685	13.282	-0.404
50	67	11.013	11.032	0.019
50	68	12.446	12.213	-0.233
50	69	13.291	12.590	-0.701
50	71	10.840	10.327	-0.512
50	72	12.111	11.910	-0.202
50	172	10.979	10.997	0.018
50	173	12.315	12.117	-0.198
50	174	13.774	13.392	-0.382
50	183	13.056	12.489	-0.567
50	186	10.834	10.506	-0.328
100	95	13.461	11.596	-1.866
100	102	11.995	11.006	-0.989
100	104	12.489	11.398	-1.091
100	105	12.045	10.791	-1.254
100	106	12.221	10.883	-1.338
100	178	12.198	11.416	-0.782
100	179	12.388	11.340	-1.048
100	180	13.326	12.001	-1.325
100	181	12.737	11.264	-1.473
100	182	11.843	11.177	-0.666
	Max	13.774	13.796	2.747
	Average	12.367	12.100	-0.267
	Min	10.768	10.327	-2.085
	Std Dev	0.970	1.022	0.792

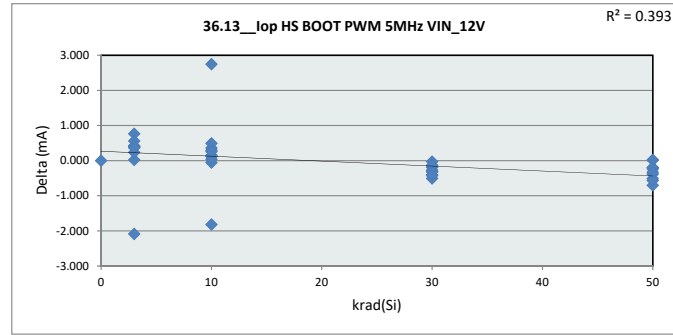

36.13 Top HS BOOT

Test Site	DAL-FL
Tester	ETS364
Test Number	EB672302
Max Limit	17.5 mA
Min Limit	1 mA

krad(Si)	0	3	10	30	50	100
LL	1.000	1.000	1.000	1.000	1.000	1.000
Min	13.399	10.913	10.916	10.566	10.327	10.791
Average	13.399	12.061	12.941	12.325	11.757	11.287
Max	13.399	13.719	13.796	13.282	13.392	12.001
UL	17.500	17.500	17.500	17.500	17.500	17.500

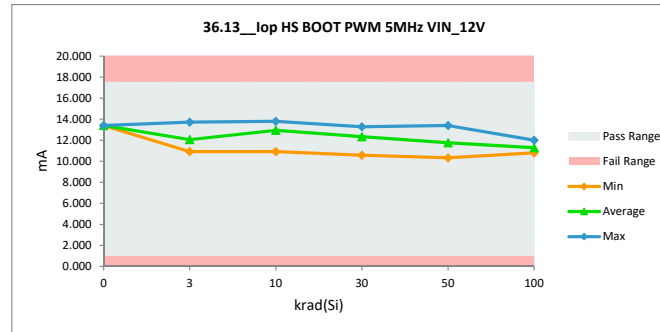

TID HDR Report
TPS7H6003-SP (5962R2220101VXC)

36.14 Top LS VIN IIM Interlock		
Test Site	DAL-FL	DAL-FL
Tester	ETS364	ETS364
Test Number	EB672302	EB672302
Unit	mA	mA
Max Limit	9	9
Min Limit	1	1

krad(Si)	Serial #	pre_short (rtp)	(2)'ST_Combo (rpt)	Delta
0	Ctrl	5.743	5.743	0.000
3	58	5.829	5.834	0.005
3	59	5.759	5.768	0.009
3	60	5.738	5.749	0.011
3	61	5.782	5.798	0.016
3	62	5.810	5.797	-0.013
3	134	5.719	5.903	0.185
3	137	5.745	5.905	0.159
3	138	5.768	5.893	0.125
3	139	5.971	5.958	-0.013
3	236	5.777	5.953	0.176
10	63	5.939	5.951	0.012
10	64	5.928	5.936	0.008
10	65	5.841	5.849	0.008
10	66	5.684	5.690	0.006
10	150	5.815	5.803	-0.011
10	237	5.861	5.947	0.086
10	241	5.992	5.900	-0.092
10	242	5.793	5.804	0.010
10	243	5.816	5.827	0.011
10	244	6.010	5.977	-0.033
30	141	5.844	5.917	0.073
30	144	5.783	5.858	0.075
30	145	5.927	6.002	0.075
30	146	5.862	5.919	0.057
30	147	5.937	5.992	0.055
30	132	5.771	5.837	0.066
30	133	5.976	6.075	0.099
30	135	6.005	5.779	-0.226
30	245	5.788	5.872	0.084
30	246	5.872	5.931	0.059
50	67	5.913	6.036	0.123
50	68	5.696	6.010	0.314
50	69	5.873	5.996	0.123
50	71	5.788	5.959	0.171
50	72	5.804	5.945	0.142
50	172	5.978	6.152	0.174
50	173	5.786	5.866	0.080
50	174	5.666	5.822	0.156
50	183	5.742	5.873	0.131
50	186	5.873	6.011	0.138
100	95	5.877	6.133	0.256
100	102	5.786	6.007	0.221
100	104	5.787	6.052	0.264
100	105	5.802	6.042	0.240
100	106	5.868	6.009	0.141
100	178	5.902	6.149	0.247
100	179	5.841	6.024	0.184
100	180	5.830	6.044	0.214
100	181	5.686	5.963	0.277
100	182	5.770	6.044	0.274
	Max	6.010	6.152	0.314
	Average	5.830	5.928	0.097
	Min	5.666	5.690	-0.226
	Std Dev	0.088	0.108	0.107

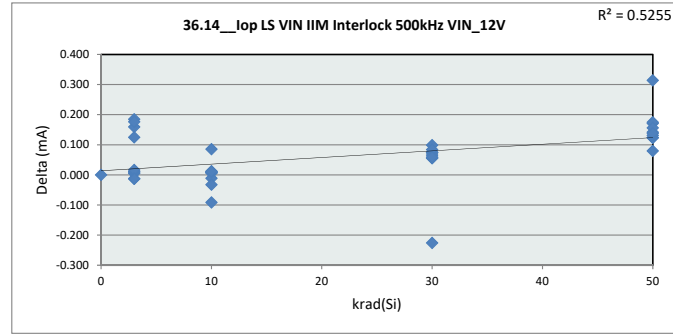

36.14 Top LS VIN IIM

Test Site	DAL-FL
Tester	ETS364
Test Number	EB672302
Max Limit	9 mA
Min Limit	1 mA

krad(Si)	0	3	10	30	50	100
LL	1.000	1.000	1.000	1.000	1.000	1.000
Min	5.743	5.749	5.690	5.779	5.822	5.963
Average	5.743	5.856	5.868	5.918	5.967	6.047
Max	5.743	5.958	5.978	6.075	6.152	6.149
UL	9.000	9.000	9.000	9.000	9.000	9.000

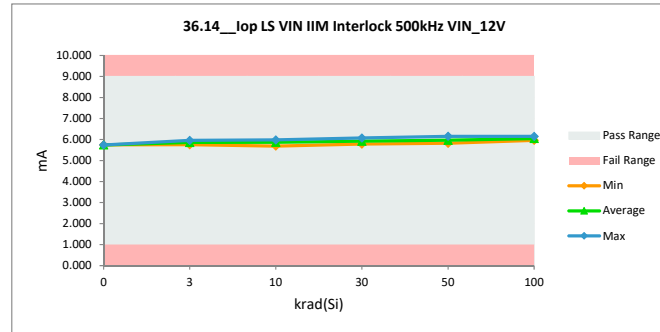

TID HDR Report
TPS7H6003-SP (5962R2220101VXC)

36.15 Top HS BOOT IIM Interlock		
Test Site	DAL-FL	DAL-FL
Tester	ETS364	ETS364
Test Number	EB672302	EB672302
Unit	mA	mA
Max Limit	6.5	6.5
Min Limit	1	1

krad(Si)	Serial #	pre_short (rtp)	(2)ST_Combo (rpt)	Delta
0	Ctrl	4.418	4.418	0.000
3	58	4.401	4.419	0.018
3	59	4.486	4.479	-0.007
3	60	4.378	4.397	0.019
3	61	4.397	4.401	0.004
3	62	4.407	4.403	-0.004
3	134	4.454	4.486	0.032
3	137	4.516	4.487	-0.028
3	138	4.508	4.474	-0.034
3	139	4.620	4.602	-0.017
3	236	4.461	4.692	0.231
10	63	4.498	4.525	0.027
10	64	4.506	4.509	0.003
10	65	4.436	4.449	0.013
10	66	4.414	4.437	0.023
10	150	4.541	4.538	-0.002
10	237	4.549	4.683	0.134
10	241	4.481	4.483	0.002
10	242	4.464	4.465	0.002
10	243	4.429	4.432	0.004
10	244	4.492	4.483	-0.010
30	141	4.558	4.647	0.088
30	144	4.417	4.496	0.079
30	145	4.541	4.577	0.036
30	146	4.443	4.528	0.085
30	147	4.558	4.626	0.068
30	132	4.337	4.399	0.062
30	133	4.556	4.649	0.093
30	135	4.560	4.384	-0.176
30	245	4.588	4.664	0.076
30	246	4.564	4.666	0.102
50	67	4.517	4.630	0.113
50	68	4.425	4.714	0.288
50	69	4.497	4.622	0.124
50	71	4.395	4.538	0.143
50	72	4.565	4.688	0.123
50	172	4.533	4.646	0.114
50	173	4.442	4.586	0.145
50	174	4.567	4.703	0.137
50	183	4.444	4.616	0.171
50	186	4.420	4.562	0.142
100	95	4.514	4.711	0.197
100	102	4.342	4.524	0.182
100	104	4.404	4.643	0.239
100	105	4.440	4.660	0.220
100	106	4.397	4.587	0.191
100	178	4.610	4.871	0.261
100	179	4.463	4.721	0.259
100	180	4.431	4.631	0.200
100	181	4.453	4.698	0.244
100	182	4.467	4.728	0.261
	Max	4.620	4.871	0.288
	Average	4.477	4.568	0.092
	Min	4.337	4.384	-0.176
	Std Dev	0.069	0.113	0.100

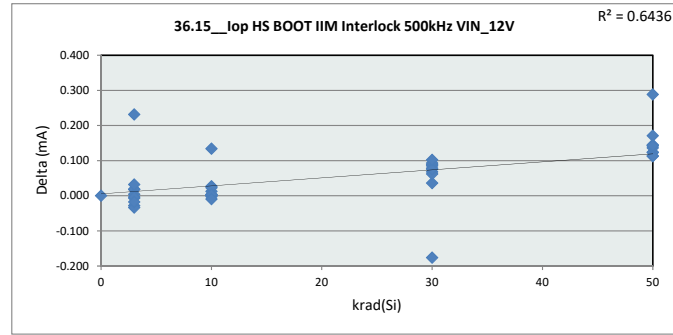

36.15 Top HS BOOT IIM Interlock

Test Site	DAL-FL
Tester	ETS364
Test Number	EB672302
Max Limit	6.5 mA
Min Limit	1 mA

krad(Si)	0	3	10	30	50	100
LL	1.000	1.000	1.000	1.000	1.000	1.000
Min	4.418	4.397	4.433	4.384	4.538	4.524
Average	4.418	4.484	4.500	4.564	4.630	4.678
Max	4.418	4.692	4.683	4.666	4.714	4.871
UL	6.500	6.500	6.500	6.500	6.500	6.500

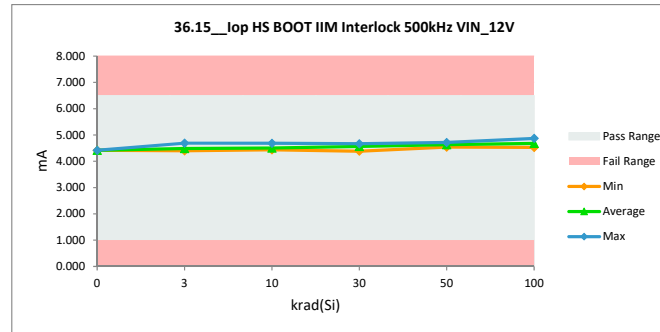

TID HDR Report
TPS7H6003-SP (5962R2220101VXC)

36.16 Top LS VIN IIM Interlock		
Test Site	DAL-FL	DAL-FL
Tester	ETS364	ETS364
Test Number	EB672302	EB672302
Unit	mA	mA
Max Limit	12	12
Min Limit	1	1

krad(Si)	Serial #	pre_short (rtp)	(2)ST_Combo (rpt)	Delta
0	Ctrl	7.209	7.209	0.000
3	58	7.298	7.303	0.006
3	59	7.224	7.231	0.006
3	60	7.189	7.201	0.012
3	61	7.253	7.269	0.016
3	62	7.281	7.267	-0.014
3	134	7.187	7.379	0.192
3	137	7.210	7.380	0.170
3	138	7.238	7.368	0.129
3	139	7.443	7.431	-0.011
3	236	7.238	7.417	0.179
10	63	7.408	7.423	0.015
10	64	7.398	7.406	0.008
10	65	7.310	7.320	0.011
10	66	7.143	7.152	0.008
10	150	7.290	7.279	-0.011
10	237	7.331	7.412	0.081
10	241	7.458	7.376	-0.082
10	242	7.247	7.259	0.012
10	243	7.276	7.289	0.013
10	244	7.473	7.444	-0.030
30	141	7.317	7.401	0.085
30	144	7.256	7.346	0.090
30	145	7.409	7.496	0.087
30	146	7.322	7.386	0.064
30	147	7.412	7.476	0.065
30	132	7.242	7.316	0.074
30	133	7.445	7.555	0.111
30	135	7.474	7.257	-0.217
30	245	7.259	7.351	0.092
30	246	7.347	7.414	0.067
50	67	7.376	7.519	0.143
50	68	7.156	7.507	0.351
50	69	7.345	7.489	0.144
50	71	7.259	7.448	0.189
50	72	7.262	7.424	0.161
50	172	7.449	7.653	0.204
50	173	7.248	7.346	0.098
50	174	7.142	7.320	0.179
50	183	7.213	7.367	0.155
50	186	7.344	7.502	0.158
100	95	7.346	7.636	0.290
100	102	7.246	7.503	0.257
100	104	7.246	7.543	0.297
100	105	7.264	7.553	0.288
100	106	7.333	7.494	0.161
100	178	7.371	7.654	0.283
100	179	7.311	7.526	0.215
100	180	7.306	7.540	0.234
100	181	7.153	7.462	0.309
100	182	7.233	7.545	0.312
	Max	7.474	7.654	0.351
	Average	7.298	7.409	0.111
	Min	7.142	7.152	-0.217
	Std Dev	0.090	0.119	0.118

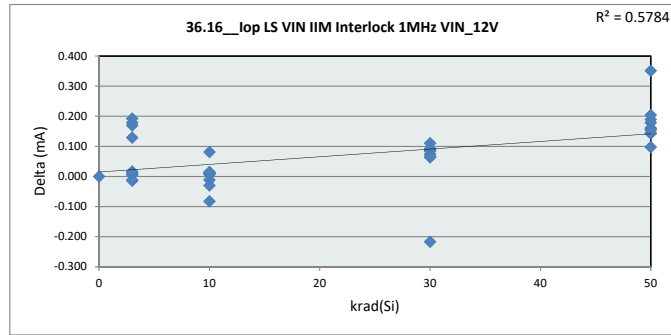

36.16 Top LS VIN I		
Test Site	DAL-FL	
Tester	ETS364	
Test Number	EB672302	
Max Limit	12	mA
Min Limit	1	mA

krad(Si)	0	3	10	30	50	100
LL	1.000	1.000	1.000	1.000	1.000	1.000
Min	7.209	7.201	7.152	7.257	7.320	7.462
Average	7.209	7.325	7.336	7.400	7.458	7.546
Max	7.209	7.432	7.444	7.555	7.653	7.654
UL	12.000	12.000	12.000	12.000	12.000	12.000

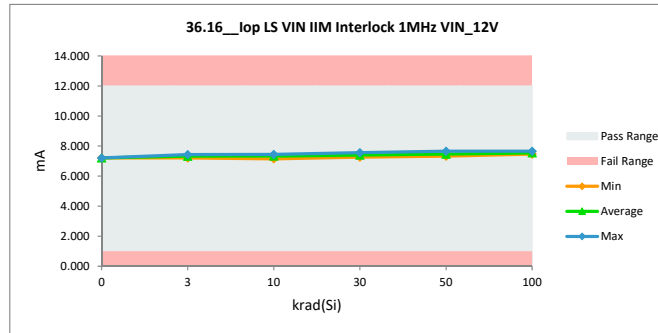

TID HDR Report
TPS7H6003-SP (5962R2220101VXC)

36.17_Top HS BOOT IIM Interlock		
Test Site	DAL-FL	DAL-FL
Tester	ETS364	ETS364
Test Number	EB672302	EB672302
Unit	mA	mA
Max Limit	8	8
Min Limit	1	1

krad(Si)	Serial #	pre_short (rtp)	(2)'ST_Combo (rpt)	Delta
0	Ctrl	5.247	5.247	0.000
3	58	5.227	5.251	0.024
3	59	5.308	5.307	-0.001
3	60	5.195	5.221	0.026
3	61	5.220	5.227	0.007
3	62	5.230	5.231	0.001
3	134	5.275	5.318	0.042
3	137	5.341	5.320	-0.021
3	138	5.329	5.304	-0.025
3	139	5.440	5.431	-0.009
3	236	5.278	5.523	0.244
10	63	5.318	5.350	0.032
10	64	5.330	5.338	0.009
10	65	5.259	5.279	0.020
10	66	5.236	5.262	0.026
10	150	5.365	5.366	0.002
10	237	5.367	5.514	0.147
10	241	5.298	5.313	0.015
10	242	5.285	5.295	0.010
10	243	5.252	5.263	0.010
10	244	5.313	5.306	-0.006
30	141	5.381	5.477	0.096
30	144	5.236	5.322	0.086
30	145	5.369	5.409	0.040
30	146	5.262	5.350	0.088
30	147	5.376	5.450	0.074
30	132	5.162	5.227	0.065
30	133	5.375	5.476	0.100
30	135	5.380	5.211	-0.169
30	245	5.414	5.495	0.081
30	246	5.379	5.486	0.107
50	67	5.339	5.459	0.120
50	68	5.247	5.545	0.298
50	69	5.316	5.446	0.129
50	71	5.216	5.365	0.149
50	72	5.378	5.510	0.132
50	172	5.353	5.470	0.117
50	173	5.261	5.409	0.148
50	174	5.391	5.535	0.144
50	183	5.265	5.439	0.174
50	186	5.246	5.393	0.147
100	95	5.336	5.536	0.200
100	102	5.158	5.347	0.189
100	104	5.225	5.478	0.253
100	105	5.262	5.490	0.228
100	106	5.216	5.405	0.189
100	178	5.429	5.696	0.268
100	179	5.287	5.553	0.266
100	180	5.251	5.463	0.212
100	181	5.279	5.527	0.248
100	182	5.292	5.562	0.269
Max		5.440	5.696	0.298
Average		5.298	5.396	0.098
Min		5.158	5.211	-0.169
Std Dev		0.069	0.114	0.101

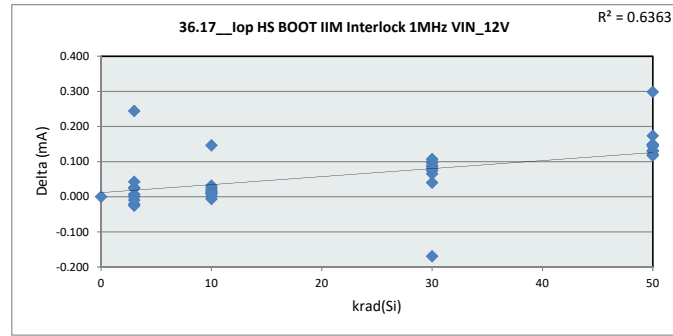

36.17_Top HS BOOT IIM Interlock 1MHz VIN_12V		
Test Site	DAL-FL	DAL-FL
Tester	ETS364	ETS364
Test Number	EB672302	EB672302
Max Limit	8	mA
Min Limit	1	mA

krad(Si)	0	3	10	30	50	100
LL	1.000	1.000	1.000	1.000	1.000	1.000
Min	5.247	5.221	5.262	5.211	5.365	5.347
Average	5.247	5.313	5.329	5.390	5.457	5.506
Max	5.247	5.523	5.514	5.495	5.545	5.696
UL	8.000	8.000	8.000	8.000	8.000	8.000

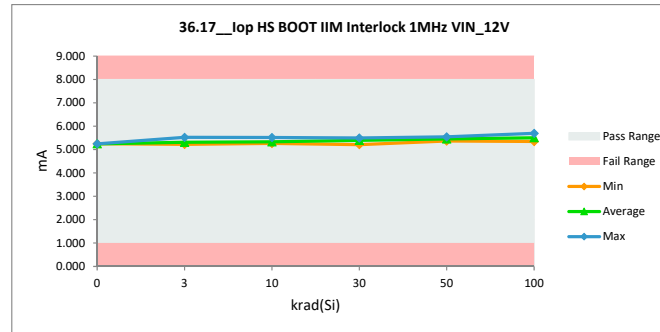

TID HDR Report
TPS7H6003-SP (5962R2220101VXC)

36.18_Top LS VIN IIM Interlock		
Test Site	DAL-FL	DAL-FL
Tester	ETS364	ETS364
Test Number	EB672302	EB672302
Unit	mA	mA
Max Limit	17	17
Min Limit	1	1

krad(Si)	Serial #	pre_short (rtp)	(2)ST_Combo (rpt)	Delta
0	Ctrl	10.136	10.136	0.000
3	58	10.226	10.237	0.010
3	59	10.146	10.154	0.008
3	60	10.084	10.099	0.014
3	61	10.185	10.205	0.020
3	62	10.212	10.203	-0.009
3	134	10.115	10.324	0.209
3	137	10.131	10.326	0.195
3	138	10.171	10.310	0.139
3	139	10.380	10.368	-0.011
3	236	10.152	10.339	0.187
10	63	10.339	10.362	0.022
10	64	10.329	10.343	0.014
10	65	10.241	10.258	0.017
10	66	10.055	10.069	0.014
10	150	10.235	10.226	-0.008
10	237	10.262	10.333	0.070
10	241	10.379	10.320	-0.059
10	242	10.145	10.164	0.019
10	243	10.189	10.211	0.022
10	244	10.395	10.370	-0.025
30	141	10.255	10.364	0.109
30	144	10.195	10.311	0.116
30	145	10.363	10.477	0.114
30	146	10.234	10.318	0.084
30	147	10.353	10.437	0.084
30	132	10.177	10.272	0.095
30	133	10.377	10.511	0.134
30	135	10.400	10.200	-0.200
30	245	10.194	10.305	0.111
30	246	10.285	10.373	0.087
50	67	10.297	10.480	0.183
50	68	10.067	10.498	0.431
50	69	10.283	10.469	0.186
50	71	10.193	10.427	0.234
50	72	10.172	10.372	0.200
50	172	10.385	10.649	0.264
50	173	10.167	10.302	0.135
50	174	10.088	10.310	0.222
50	183	10.153	10.349	0.196
50	186	10.276	10.475	0.198
100	95	10.277	10.638	0.361
100	102	10.156	10.487	0.332
100	104	10.156	10.518	0.362
100	105	10.182	10.573	0.391
100	106	10.255	10.458	0.203
100	178	10.304	10.664	0.361
100	179	10.242	10.522	0.279
100	180	10.251	10.529	0.278
100	181	10.077	10.458	0.381
100	182	10.153	10.537	0.384
	Max	10.400	10.664	0.431
	Average	10.225	10.365	0.140
	Min	10.055	10.069	-0.200
	Std Dev	0.094	0.142	0.141

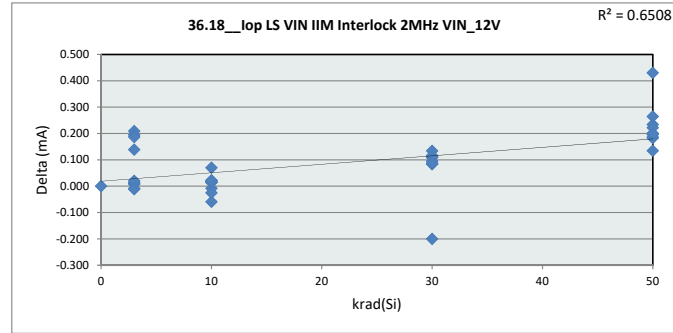

36.18_Top LS VIN I		
Test Site	DAL-FL	
Tester	ETS364	
Test Number	EB672302	
Max Limit	17	mA
Min Limit	1	mA

krad(Si)	0	3	10	30	50	100
LL	1.000	1.000	1.000	1.000	1.000	1.000
Min	10.136	10.099	10.069	10.201	10.302	10.458
Average	10.136	10.256	10.266	10.357	10.433	10.538
Max	10.136	10.369	10.370	10.511	10.649	10.664
UL	17.000	17.000	17.000	17.000	17.000	17.000

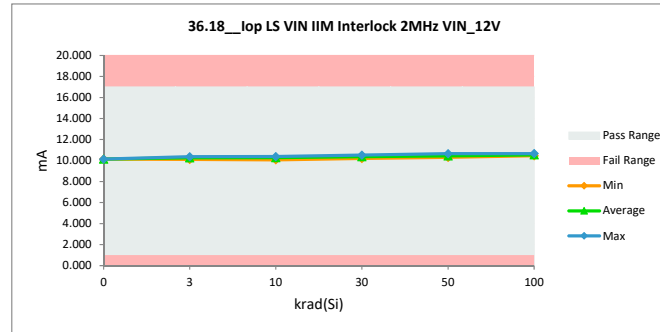

TID HDR Report
TPS7H6003-SP (5962R2220101VXC)

36.19_Top HS BOOT IIM Interlock		
Test Site	DAL-FL	DAL-FL
Tester	ETS364	ETS364
Test Number	EB672302	EB672302
Unit	mA	mA
Max Limit	10.5	10.5
Min Limit	1	1

krad(Si)	Serial #	pre_short (rtp)	(2)ST_Combo (rpt)	Delta
0	Ctrl	6.905	6.905	0.000
3	58	6.878	6.910	0.032
3	59	6.951	6.965	0.013
3	60	6.833	6.867	0.034
3	61	6.865	6.882	0.016
3	62	6.876	6.891	0.015
3	134	6.918	6.976	0.057
3	137	6.990	6.977	-0.012
3	138	6.974	6.963	-0.011
3	139	7.084	7.080	-0.004
3	236	6.916	7.175	0.259
10	63	6.958	7.000	0.042
10	64	6.979	6.995	0.016
10	65	6.907	6.933	0.026
10	66	6.879	6.912	0.034
10	150	7.013	7.024	0.010
10	237	7.002	7.167	0.165
10	241	6.933	6.971	0.038
10	242	6.931	6.953	0.023
10	243	6.902	6.924	0.022
10	244	6.950	6.952	0.003
30	141	7.028	7.137	0.109
30	144	6.875	6.971	0.096
30	145	7.023	7.072	0.048
30	146	6.901	7.000	0.099
30	147	7.014	7.094	0.080
30	132	6.813	6.880	0.068
30	133	7.017	7.127	0.110
30	135	7.019	6.859	-0.160
30	245	7.063	7.151	0.088
30	246	7.009	7.128	0.119
50	67	6.979	7.110	0.131
50	68	6.887	7.201	0.314
50	69	6.953	7.095	0.142
50	71	6.858	7.017	0.159
50	72	7.009	7.153	0.145
50	172	6.994	7.122	0.127
50	173	6.900	7.055	0.154
50	174	7.040	7.197	0.157
50	183	6.906	7.086	0.180
50	186	6.894	7.046	0.152
100	95	6.980	7.186	0.206
100	102	6.791	6.995	0.204
100	104	6.869	7.138	0.269
100	105	6.906	7.152	0.245
100	106	6.858	7.048	0.190
100	178	7.067	7.341	0.275
100	179	6.935	7.210	0.275
100	180	6.892	7.122	0.230
100	181	6.926	7.181	0.255
100	182	6.941	7.232	0.291
	Max	7.084	7.341	0.314
	Average	6.941	7.050	0.109
	Min	6.791	6.859	-0.160
	Std Dev	0.068	0.113	0.102

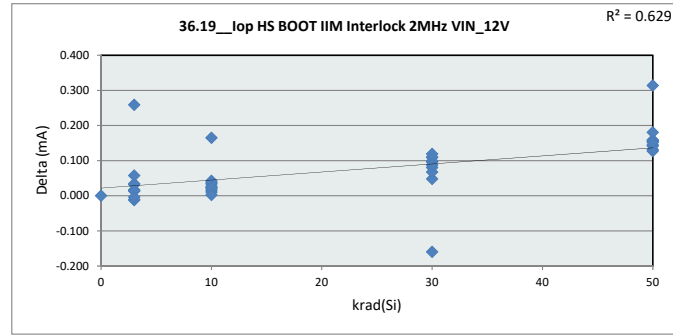

36.19_Top HS BOOT IIM Interlock 2MHz VIN_12V		
Test Site	DAL-FL	DAL-FL
Tester	ETS364	ETS364
Test Number	EB672302	EB672302
Max Limit	10.5	mA
Min Limit	1	mA

krad(Si)	0	3	10	30	50	100
LL	1.000	1.000	1.000	1.000	1.000	1.000
Min	6.905	6.867	6.913	6.859	7.017	6.995
Average	6.905	6.969	6.983	7.042	7.108	7.160
Max	6.905	7.175	7.167	7.151	7.201	7.341
UL	10.500	10.500	10.500	10.500	10.500	10.500

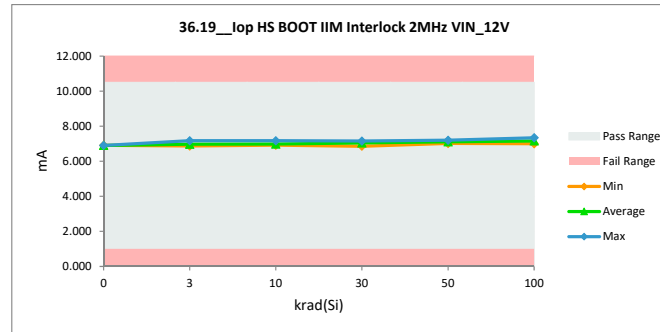

TID HDR Report
TPS7H6003-SP (5962R2220101VXC)

36.20_Top LS VIN IIM Interlock		
Test Site	DAL-FL	DAL-FL
Tester	ETS364	ETS364
Test Number	EB672302	EB672302
Unit	mA	mA
Max Limit	30	30
Min Limit	1	1

krad(Si)	Serial #	pre_short (rtp)	(2)ST_Combo (rpt)	Delta
0	Ctrl	19.223	19.223	0.000
3	58	19.312	19.306	-0.006
3	59	19.238	19.216	-0.023
3	60	19.079	19.077	-0.002
3	61	19.314	19.308	-0.006
3	62	19.304	19.294	-0.010
3	134	19.233	19.451	0.218
3	137	19.220	19.452	0.232
3	138	19.274	19.431	0.157
3	139	19.497	19.427	-0.070
3	236	19.221	19.369	0.148
10	63	19.448	19.461	0.013
10	64	19.445	19.447	0.002
10	65	19.324	19.345	0.021
10	66	19.091	19.105	0.014
10	150	19.392	19.347	-0.045
10	237	19.372	19.361	-0.012
10	241	19.461	19.438	-0.023
10	242	19.162	19.161	-0.001
10	243	19.246	19.263	0.017
10	244	19.455	19.433	-0.022
30	141	19.396	19.553	0.158
30	144	19.338	19.496	0.158
30	145	19.554	19.697	0.143
30	146	19.267	19.396	0.129
30	147	19.460	19.589	0.129
30	132	19.294	19.430	0.136
30	133	19.484	19.659	0.174
30	135	19.480	19.325	-0.155
30	245	19.297	19.422	0.125
30	246	19.405	19.531	0.126
50	67	19.385	19.652	0.267
50	68	19.124	19.755	0.631
50	69	19.430	19.708	0.278
50	71	19.327	19.638	0.310
50	72	19.220	19.503	0.282
50	172	19.508	19.919	0.411
50	173	19.228	19.433	0.204
50	174	19.241	19.564	0.324
50	183	19.291	19.587	0.296
50	186	19.385	19.669	0.285
100	95	19.389	19.914	0.525
100	102	19.179	19.733	0.554
100	104	19.204	19.703	0.499
100	105	19.250	19.920	0.670
100	106	19.323	19.629	0.305
100	178	19.423	19.980	0.557
100	179	19.347	19.796	0.449
100	180	19.396	19.764	0.368
100	181	19.175	19.722	0.547
100	182	19.231	19.799	0.567
	Max	19.554	19.980	0.670
	Average	19.320	19.518	0.197
	Min	19.079	19.077	-0.155
	Std Dev	0.114	0.217	0.211

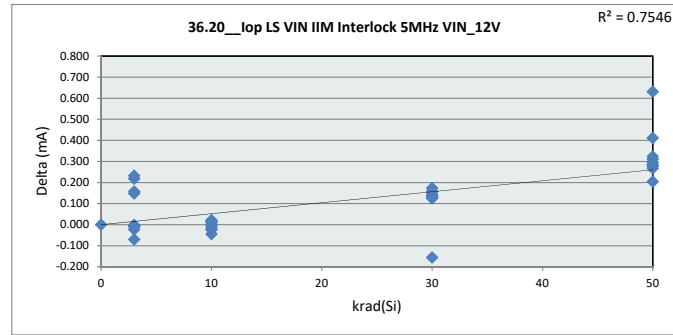

36.20_Top LS VIN IIM Interlock 5MHz VIN_12V						
Test Site	DAL-FL					
Tester	ETS364					
Test Number	EB672302					
Max Limit	30	mA				
Min Limit	1	mA				
krad(Si)	0	3	10	30	50	100
LL	1.000	1.000	1.000	1.000	1.000	1.000
Min	19.223	19.077	19.105	19.325	19.433	19.629
Average	19.223	19.333	19.336	19.510	19.643	19.796
Max	19.223	19.452	19.461	19.697	19.919	19.980
UL	30.000	30.000	30.000	30.000	30.000	30.000

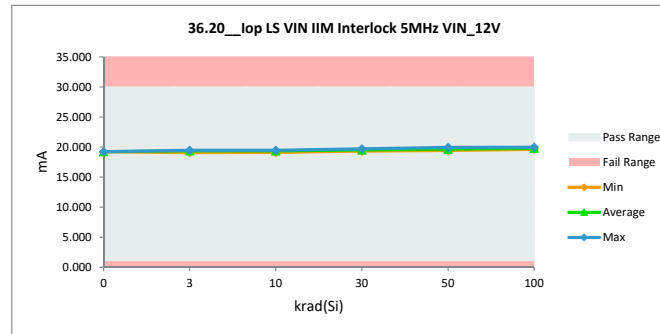

TID HDR Report
TPS7H6003-SP (5962R2220101VXC)

36.21_Top HS BOOT IIM Interlock		
Test Site	DAL-FL	DAL-FL
Tester	ETS364	ETS364
Test Number	EB672302	EB672302
Unit	mA	mA
Max Limit	15	15
Min Limit	1	1

krad(Si)	Serial #	pre_short (rtp)	(2)ST_Combo (rpt)	Delta
0	Ctrl	11.665	11.665	0.000
3	58	11.656	11.624	-0.032
3	59	11.696	11.717	0.021
3	60	11.581	11.584	0.003
3	61	11.627	11.590	-0.037
3	62	11.649	11.660	0.011
3	134	11.667	11.665	-0.002
3	137	11.770	11.668	-0.101
3	138	11.716	11.644	-0.072
3	139	11.844	11.750	-0.094
3	236	11.667	11.822	0.155
10	63	11.699	11.747	0.048
10	64	11.760	11.695	-0.066
10	65	11.666	11.680	0.014
10	66	11.651	11.609	-0.041
10	150	11.793	11.776	-0.018
10	237	11.747	11.815	0.068
10	241	11.679	11.654	-0.025
10	242	11.711	11.726	0.016
10	243	11.725	11.711	-0.014
10	244	11.712	11.612	-0.100
30	141	11.794	11.903	0.109
30	144	11.625	11.710	0.085
30	145	11.791	11.764	-0.027
30	146	11.661	11.765	0.104
30	147	11.744	11.743	-0.002
30	132	11.590	11.563	-0.028
30	133	11.755	11.778	0.023
30	135	11.722	11.551	-0.170
30	245	11.852	11.856	0.004
30	246	11.725	11.825	0.099
50	67	11.700	11.779	0.079
50	68	11.689	11.907	0.218
50	69	11.660	11.814	0.154
50	71	11.618	11.721	0.103
50	72	11.744	11.862	0.118
50	172	11.723	11.778	0.055
50	173	11.685	11.734	0.049
50	174	11.790	11.961	0.171
50	183	11.673	11.761	0.088
50	186	11.652	11.731	0.079
100	95	11.725	11.853	0.128
100	102	11.553	11.729	0.176
100	104	11.630	11.918	0.287
100	105	11.678	11.890	0.211
100	106	11.607	11.731	0.124
100	178	11.785	11.972	0.187
100	179	11.729	11.922	0.193
100	180	11.623	11.890	0.267
100	181	11.696	11.872	0.176
100	182	11.750	11.953	0.203
	Max	11.852	11.972	0.287
	Average	11.699	11.758	0.059
	Min	11.553	11.551	-0.170
	Std Dev	0.065	0.109	0.103

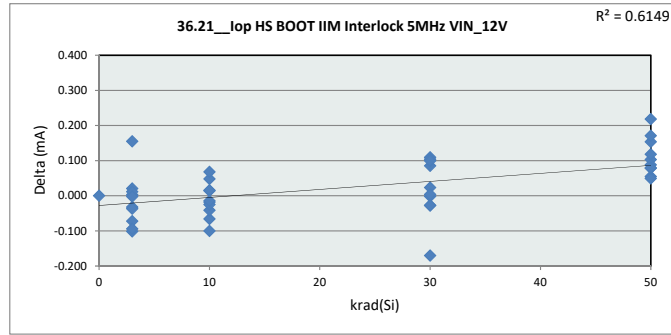

36.21_Top HS BOOT IIM Interlock 5MHz VIN_12V		
Test Site	DAL-FL	DAL-FL
Tester	ETS364	ETS364
Test Number	EB672302	EB672302
Max Limit	15	mA
Min Limit	1	mA

krad(Si)	0	3	10	30	50	100
LL	1.000	1.000	1.000	1.000	1.000	1.000
Min	11.666	11.584	11.609	11.551	11.721	11.729
Average	11.666	11.673	11.702	11.746	11.805	11.873
Max	11.666	11.822	11.815	11.904	11.961	11.972
UL	15.000	15.000	15.000	15.000	15.000	15.000

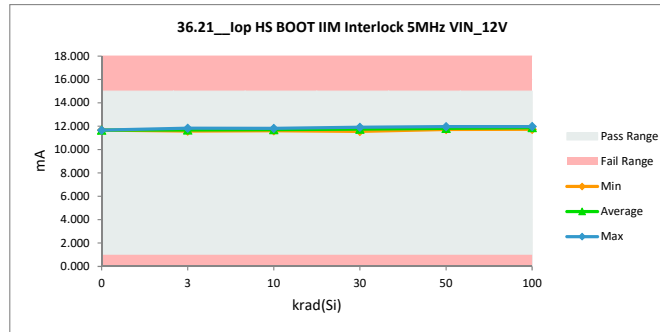

TID HDR Report
TPS7H6003-SP (5962R2220101VXC)

37.0 Iq LS VIN PWM VIN_14V		
Test Site	DAL-FL	DAL-FL
Tester	ETS364	ETS364
Test Number	EB672302	EB672302
Unit	mA	mA
Max Limit	30	6.8
Min Limit	1	1

krad(Si)	Serial #	pre_short (rtp)	(2)ST_Combo (rpt)	Delta
0	Ctrl	4.235	4.235	0.000
3	58	4.325	4.333	0.008
3	59	4.270	4.280	0.010
3	60	4.252	4.266	0.013
3	61	4.286	4.302	0.016
3	62	4.295	4.284	-0.012
3	134	4.215	4.405	0.190
3	137	4.240	4.406	0.167
3	138	4.267	4.394	0.128
3	139	4.487	4.477	-0.010
3	236	4.271	4.463	0.192
10	63	4.440	4.456	0.015
10	64	4.403	4.413	0.011
10	65	4.314	4.327	0.013
10	66	4.180	4.190	0.010
10	150	4.320	4.314	-0.006
10	237	4.367	4.456	0.089
10	241	4.501	4.402	-0.099
10	242	4.303	4.314	0.011
10	243	4.299	4.312	0.013
10	244	4.527	4.495	-0.032
30	141	4.330	4.413	0.083
30	144	4.252	4.338	0.085
30	145	4.426	4.509	0.082
30	146	4.371	4.438	0.067
30	147	4.440	4.504	0.064
30	132	4.249	4.324	0.074
30	133	4.475	4.581	0.107
30	135	4.505	4.284	-0.221
30	245	4.277	4.369	0.092
30	246	4.385	4.450	0.065
50	67	4.401	4.538	0.136
50	68	4.185	4.494	0.308
50	69	4.371	4.507	0.136
50	71	4.301	4.481	0.180
50	72	4.290	4.450	0.160
50	172	4.475	4.641	0.166
50	173	4.274	4.358	0.083
50	174	4.170	4.330	0.161
50	183	4.248	4.380	0.132
50	186	4.355	4.498	0.143
100	95	4.360	4.641	0.281
100	102	4.292	4.534	0.241
100	104	4.297	4.587	0.289
100	105	4.286	4.537	0.252
100	106	4.361	4.535	0.174
100	178	4.396	4.649	0.254
100	179	4.329	4.524	0.195
100	180	4.312	4.549	0.238
100	181	4.187	4.470	0.283
100	182	4.253	4.533	0.280
	Max	4.527	4.649	0.308
	Average	4.326	4.431	0.104
	Min	4.170	4.190	-0.221
	Std Dev	0.090	0.111	0.111

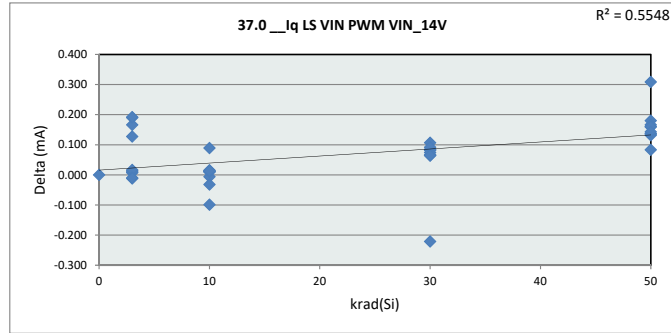

37.0 Iq LS VIN PW		
Test Site	DAL-FL	
Tester	ETS364	
Test Number	EB672302	
Max Limit	6.8	mA
Min Limit	1	mA

krad(Si)	0	3	10	30	50	100
LL	1.000	1.000	1.000	1.000	1.000	1.000
Min	4.235	4.266	4.190	4.284	4.330	4.470
Average	4.235	4.361	4.368	4.421	4.468	4.556
Max	4.235	4.477	4.495	4.581	4.641	4.649
UL	6.800	6.800	6.800	6.800	6.800	6.800

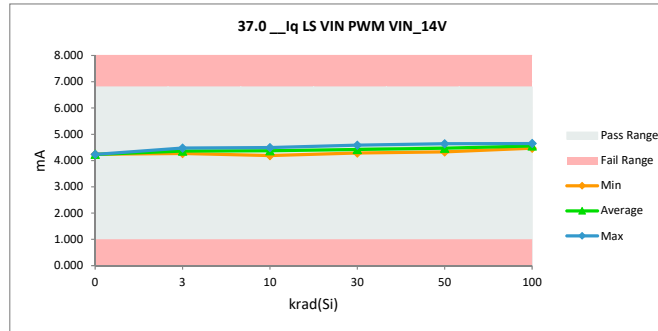

TID HDR Report
TPS7H6003-SP (5962R2220101VXC)

37.1 Iq HS BOOT PWM VIN_14		
Test Site	DAL-FL	DAL-FL
Tester	ETS364	ETS364
Test Number	EB672302	EB672302
Unit	mA	mA
Max Limit	15	6.3
Min Limit	1	1

krad(Si)	Serial #	pre_short (rtp)	(2)ST_Combo (rpt)	Delta
0	Ctrl	3.628	3.628	0.000
3	58	3.615	3.628	0.013
3	59	3.705	3.693	-0.012
3	60	3.597	3.612	0.016
3	61	3.615	3.613	-0.001
3	62	3.624	3.615	-0.010
3	134	3.674	3.699	0.025
3	137	3.734	3.701	-0.033
3	138	3.726	3.686	-0.040
3	139	3.839	3.819	-0.020
3	236	3.681	3.907	0.226
10	63	3.719	3.741	0.022
10	64	3.722	3.722	0.000
10	65	3.654	3.662	0.009
10	66	3.632	3.652	0.020
10	150	3.759	3.753	-0.006
10	237	3.773	3.897	0.124
10	241	3.704	3.696	-0.009
10	242	3.681	3.678	-0.003
10	243	3.644	3.642	-0.002
10	244	3.715	3.701	-0.014
30	141	3.775	3.860	0.085
30	144	3.640	3.714	0.074
30	145	3.755	3.787	0.032
30	146	3.664	3.744	0.079
30	147	3.780	3.845	0.065
30	132	3.553	3.612	0.059
30	133	3.776	3.864	0.088
30	135	3.781	3.600	-0.181
30	245	3.806	3.877	0.071
30	246	3.790	3.887	0.097
50	67	3.738	3.846	0.108
50	68	3.643	3.927	0.284
50	69	3.719	3.838	0.119
50	71	3.614	3.753	0.139
50	72	3.789	3.907	0.118
50	172	3.754	3.862	0.108
50	173	3.663	3.802	0.139
50	174	3.785	3.916	0.131
50	183	3.665	3.833	0.168
50	186	3.638	3.776	0.137
100	95	3.733	3.926	0.193
100	102	3.565	3.741	0.177
100	104	3.618	3.853	0.235
100	105	3.658	3.872	0.214
100	106	3.616	3.805	0.189
100	178	3.832	4.087	0.255
100	179	3.679	3.933	0.254
100	180	3.652	3.844	0.192
100	181	3.671	3.913	0.242
100	182	3.682	3.935	0.253
	Max	3.839	4.087	0.284
	Average	3.696	3.782	0.087
	Min	3.553	3.600	-0.181
	Std Dev	0.070	0.114	0.100

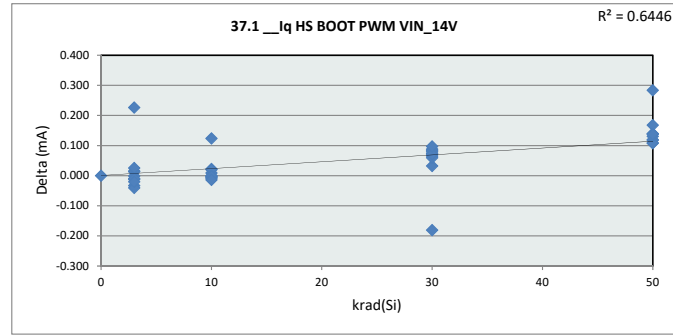

37.1 Iq HS BOOT		
Test Site	DAL-FL	
Tester	ETS364	
Test Number	EB672302	
Max Limit	6.3	mA
Min Limit	1	mA

krad(Si)	0	3	10	30	50	100
LL	1.000	1.000	1.000	1.000	1.000	1.000
Min	3.628	3.612	3.642	3.600	3.753	3.741
Average	3.628	3.697	3.714	3.779	3.846	3.891
Max	3.628	3.907	3.897	3.887	3.927	4.087
UL	6.300	6.300	6.300	6.300	6.300	6.300

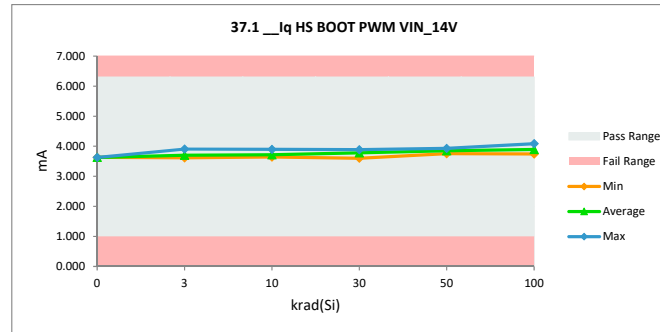

TID HDR Report
TPS7H6003-SP (5962R2220101VXC)

37.2 Iq LS VIN IIM Interlock V		
Test Site	DAL-FL	DAL-FL
Tester	ETS364	ETS364
Test Number	EB672302	EB672302
Unit	mA	mA
Max Limit	6.8	8
Min Limit	1	1

krad(Si)	Serial #	pre_short (rtp)	(2)ST_Combo (rpt)	Delta
0	Ctrl	4.163	4.163	0.000
3	58	4.255	4.261	0.006
3	59	4.200	4.210	0.009
3	60	4.182	4.195	0.013
3	61	4.214	4.231	0.017
3	62	4.225	4.212	-0.013
3	134	4.143	4.333	0.190
3	137	4.170	4.335	0.165
3	138	4.194	4.323	0.129
3	139	4.415	4.405	-0.010
3	236	4.201	4.392	0.191
10	63	4.370	4.384	0.014
10	64	4.333	4.343	0.010
10	65	4.243	4.256	0.013
10	66	4.110	4.121	0.010
10	150	4.249	4.244	-0.006
10	237	4.295	4.385	0.090
10	241	4.429	4.330	-0.099
10	242	4.232	4.243	0.011
10	243	4.228	4.240	0.012
10	244	4.456	4.425	-0.031
30	141	4.259	4.340	0.081
30	144	4.180	4.265	0.085
30	145	4.355	4.437	0.083
30	146	4.301	4.368	0.067
30	147	4.369	4.432	0.063
30	132	4.178	4.253	0.075
30	133	4.404	4.510	0.106
30	135	4.434	4.213	-0.221
30	245	4.205	4.297	0.091
30	246	4.314	4.380	0.066
50	67	4.330	4.464	0.135
50	68	4.116	4.423	0.307
50	69	4.300	4.435	0.135
50	71	4.229	4.408	0.179
50	72	4.219	4.377	0.158
50	172	4.402	4.568	0.166
50	173	4.204	4.285	0.081
50	174	4.097	4.257	0.159
50	183	4.177	4.308	0.132
50	186	4.285	4.425	0.141
100	95	4.289	4.567	0.279
100	102	4.222	4.462	0.240
100	104	4.228	4.515	0.286
100	105	4.215	4.465	0.250
100	106	4.290	4.464	0.174
100	178	4.324	4.574	0.250
100	179	4.259	4.453	0.194
100	180	4.241	4.479	0.238
100	181	4.116	4.399	0.283
100	182	4.182	4.459	0.277
	Max	4.456	4.574	0.307
	Average	4.255	4.359	0.104
	Min	4.097	4.121	-0.221
	Std Dev	0.090	0.110	0.110

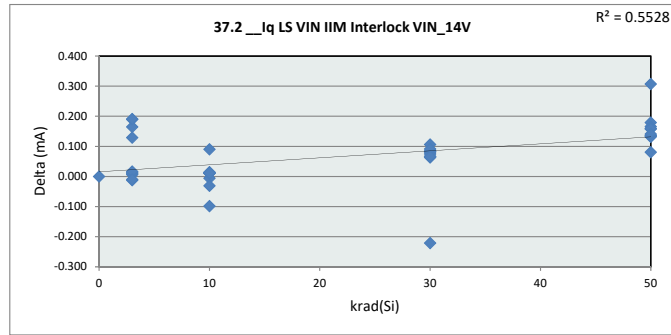

37.2 Iq LS VIN IIM						
Test Site	DAL-FL					
Tester	ETS364					
Test Number	EB672302					
Max Limit	8	mA				
Min Limit	1	mA				
krad(Si)	0	3	10	30	50	100
LL	1.000	1.000	1.000	1.000	1.000	1.000
Min	4.163	4.195	4.121	4.213	4.257	4.399
Average	4.163	4.290	4.297	4.349	4.395	4.484
Max	4.163	4.405	4.425	4.510	4.568	4.574
UL	8.000	8.000	8.000	8.000	8.000	8.000

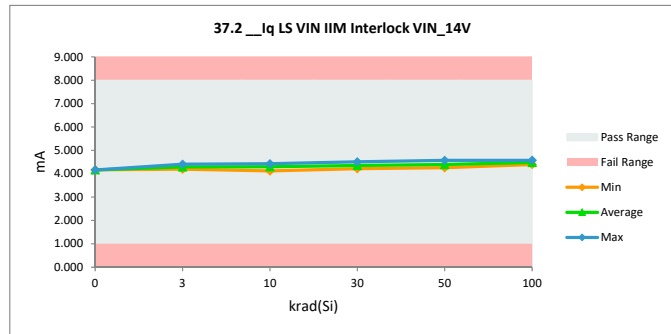

TID HDR Report
TPS7H6003-SP (5962R2220101VXC)

37.3 Iq HS BOOT IIM Interlock		
Test Site	DAL-FL	DAL-FL
Tester	ETS364	ETS364
Test Number	EB672302	EB672302
Unit	mA	mA
Max Limit	6.3	6.3
Min Limit	1	1

krad(Si)	Serial #	pre_short (rtp)	(2)ST_Combo (rpt)	Delta
0	Ctrl	3.628	3.628	0.000
3	58	3.614	3.628	0.013
3	59	3.705	3.693	-0.012
3	60	3.597	3.612	0.015
3	61	3.614	3.613	-0.001
3	62	3.624	3.615	-0.010
3	134	3.674	3.699	0.025
3	137	3.734	3.701	-0.033
3	138	3.727	3.686	-0.040
3	139	3.839	3.819	-0.020
3	236	3.680	3.907	0.226
10	63	3.718	3.741	0.022
10	64	3.722	3.722	0.000
10	65	3.654	3.662	0.009
10	66	3.632	3.651	0.019
10	150	3.759	3.753	-0.006
10	237	3.773	3.896	0.124
10	241	3.704	3.695	-0.009
10	242	3.681	3.678	-0.003
10	243	3.644	3.642	-0.002
10	244	3.714	3.700	-0.014
30	141	3.775	3.861	0.086
30	144	3.639	3.714	0.075
30	145	3.755	3.788	0.033
30	146	3.664	3.743	0.079
30	147	3.780	3.845	0.065
30	132	3.553	3.611	0.058
30	133	3.776	3.864	0.088
30	135	3.781	3.600	-0.181
30	245	3.806	3.878	0.072
30	246	3.790	3.886	0.096
50	67	3.738	3.846	0.108
50	68	3.643	3.928	0.285
50	69	3.718	3.837	0.119
50	71	3.614	3.754	0.140
50	72	3.789	3.907	0.118
50	172	3.754	3.862	0.108
50	173	3.663	3.802	0.139
50	174	3.785	3.916	0.131
50	183	3.665	3.832	0.167
50	186	3.639	3.776	0.137
100	95	3.733	3.927	0.194
100	102	3.564	3.741	0.177
100	104	3.619	3.853	0.235
100	105	3.658	3.873	0.215
100	106	3.616	3.805	0.188
100	178	3.833	4.086	0.253
100	179	3.678	3.931	0.252
100	180	3.652	3.843	0.191
100	181	3.671	3.913	0.243
100	182	3.682	3.934	0.252
Max		3.839	4.086	0.285
Average		3.695	3.782	0.087
Min		3.553	3.600	-0.181
Std Dev		0.070	0.114	0.100

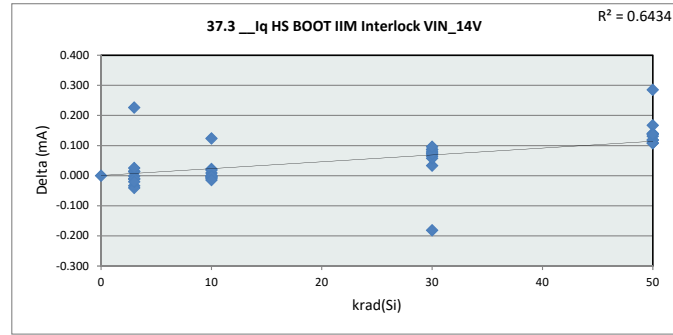

37.3 Iq HS BOOT		
Test Site	DAL-FL	
Tester	ETS364	
Test Number	EB672302	
Max Limit	6.3	mA
Min Limit	1	mA

krad(Si)	0	3	10	30	50	100
LL	1.000	1.000	1.000	1.000	1.000	1.000
Min	3.628	3.612	3.642	3.600	3.754	3.741
Average	3.628	3.697	3.714	3.779	3.846	3.891
Max	3.628	3.907	3.896	3.886	3.928	4.086
UL	6.300	6.300	6.300	6.300	6.300	6.300

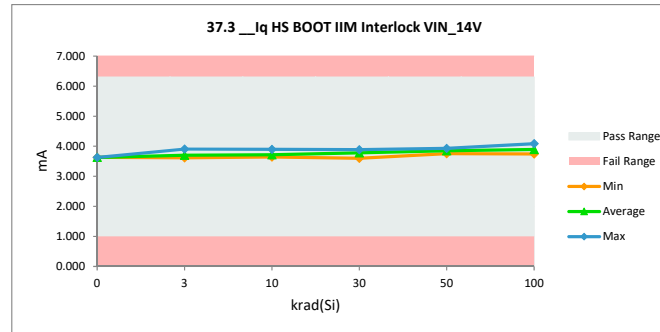

TID HDR Report
TPS7H6003-SP (5962R2220101VXC)

37.6 __Iop LS VIN PWM 500kHz		
Test Site	DAL-FL	DAL-FL
Tester	ETS364	ETS364
Test Number	EB672302	EB672302
Unit	mA	mA
Max Limit	9	9
Min Limit	1	1

krad(Si)	Serial #	pre_short (rtp)	(2)'ST_Combo (rpt)	Delta
0	Ctrl	6.358	6.358	0.000
3	58	6.427	6.427	0.000
3	59	6.311	6.316	0.005
3	60	6.317	6.323	0.006
3	61	6.363	6.373	0.010
3	62	6.416	6.401	-0.015
3	134	6.302	6.468	0.166
3	137	6.341	6.468	0.127
3	138	6.367	6.458	0.091
3	139	6.516	6.506	-0.010
3	236	6.381	6.530	0.149
10	63	6.538	6.536	-0.002
10	64	6.575	6.570	-0.005
10	65	6.491	6.486	-0.006
10	66	6.293	6.285	-0.008
10	150	6.390	6.371	-0.019
10	237	6.434	6.526	0.092
10	241	6.572	6.464	-0.108
10	242	6.385	6.384	0.000
10	243	6.453	6.456	0.003
10	244	6.573	6.532	-0.041
30	141	6.447	6.482	0.035
30	144	6.418	6.449	0.031
30	145	6.495	6.531	0.036
30	146	6.433	6.451	0.018
30	147	6.507	6.529	0.023
30	132	6.391	6.419	0.028
30	133	6.574	6.633	0.059
30	135	6.589	6.346	-0.243
30	245	6.404	6.450	0.046
30	246	6.432	6.457	0.025
50	67	6.542	6.590	0.048
50	68	6.311	6.585	0.274
50	69	6.456	6.517	0.062
50	71	6.334	6.443	0.109
50	72	6.410	6.483	0.073
50	172	6.591	6.713	0.121
50	173	6.402	6.426	0.023
50	174	6.236	6.339	0.103
50	183	6.293	6.370	0.077
50	186	6.499	6.577	0.078
100	95	6.499	6.628	0.129
100	102	6.366	6.473	0.107
100	104	6.359	6.516	0.157
100	105	6.424	6.542	0.118
100	106	6.470	6.489	0.019
100	178	6.503	6.645	0.142
100	179	6.443	6.520	0.077
100	180	6.451	6.549	0.099
100	181	6.276	6.441	0.165
100	182	6.396	6.559	0.163
	Max	6.591	6.713	0.274
	Average	6.427	6.478	0.052
	Min	6.236	6.285	-0.243
	Std Dev	0.090	0.091	0.081

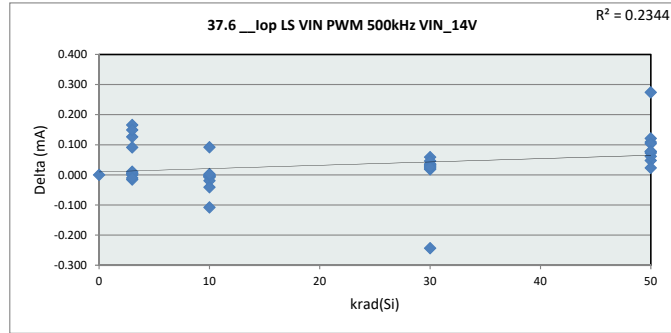

37.6 __Iop LS VIN P						
Test Site	DAL-FL					
Tester	ETS364					
Test Number	EB672302					
Max Limit	9	mA				
Min Limit	1	mA				
krad(Si)	0	3	10	30	50	100
LL	1.000	1.000	1.000	1.000	1.000	1.000
Min	6.358	6.316	6.285	6.346	6.339	6.441
Average	6.358	6.427	6.461	6.475	6.504	6.536
Max	6.358	6.530	6.570	6.633	6.713	6.645
UL	9.000	9.000	9.000	9.000	9.000	9.000

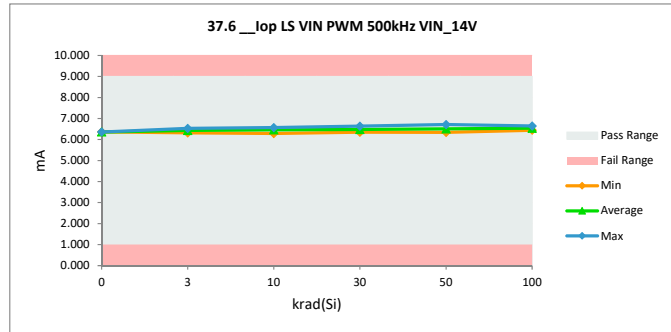

TID HDR Report

TPS7H6003-SP (5962R2220101VXC)

37.7 __Iop HS BOOT PWM 500kHz		
Test Site	DAL-FL	DAL-FL
Tester	ETS364	ETS364
Test Number	EB672302	EB672302
Unit	mA	mA
Max Limit	6.5	6.5
Min Limit	1	1

krad(Si)	Serial #	pre_short (rtp)	(2)'ST_Combo (rpt)	Delta
0	Ctrl	4.457	4.457	0.000
3	58	4.443	4.461	0.017
3	59	4.531	4.523	-0.008
3	60	4.418	4.437	0.019
3	61	4.439	4.442	0.003
3	62	4.448	4.444	-0.003
3	134	4.497	4.531	0.034
3	137	4.561	4.532	-0.029
3	138	4.552	4.520	-0.033
3	139	4.663	4.649	-0.015
3	236	4.501	4.736	0.236
10	63	4.542	4.569	0.027
10	64	4.549	4.553	0.003
10	65	4.482	4.493	0.012
10	66	4.454	4.477	0.022
10	150	4.588	4.584	-0.003
10	237	4.593	4.726	0.133
10	241	4.524	4.528	0.004
10	242	4.505	4.508	0.004
10	243	4.469	4.472	0.003
10	244	4.536	4.527	-0.009
30	141	4.602	4.693	0.091
30	144	4.460	4.540	0.080
30	145	4.586	4.622	0.036
30	146	4.485	4.568	0.083
30	147	4.602	4.672	0.070
30	132	4.379	4.442	0.062
30	133	4.599	4.693	0.094
30	135	4.604	4.428	-0.176
30	245	4.633	4.709	0.076
30	246	4.610	4.711	0.101
50	67	4.563	4.678	0.115
50	68	4.467	4.758	0.291
50	69	4.541	4.666	0.125
50	71	4.439	4.585	0.146
50	72	4.605	4.730	0.125
50	172	4.577	4.691	0.114
50	173	4.482	4.627	0.145
50	174	4.611	4.749	0.138
50	183	4.487	4.658	0.172
50	186	4.463	4.608	0.144
100	95	4.558	4.755	0.197
100	102	4.384	4.567	0.183
100	104	4.443	4.686	0.244
100	105	4.480	4.706	0.226
100	106	4.438	4.628	0.190
100	178	4.652	4.914	0.261
100	179	4.504	4.766	0.262
100	180	4.476	4.675	0.199
100	181	4.498	4.744	0.246
100	182	4.507	4.772	0.264
	Max	4.663	4.914	0.291
	Average	4.519	4.612	0.093
	Min	4.379	4.428	-0.176
	Std Dev	0.070	0.114	0.101

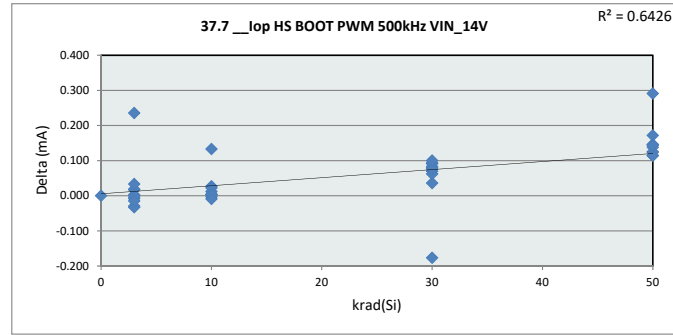

37.7 __Iop HS BOOT		
Test Site	DAL-FL	
Tester	ETS364	
Test Number	EB672302	
Max Limit	6.5	mA
Min Limit	1	mA

krad(Si)	0	3	10	30	50	100
LL	1.000	1.000	1.000	1.000	1.000	1.000
Min	4.457	4.437	4.472	4.428	4.585	4.567
Average	4.457	4.527	4.544	4.608	4.675	4.721
Max	4.457	4.736	4.726	4.711	4.758	4.914
UL	6.500	6.500	6.500	6.500	6.500	6.500

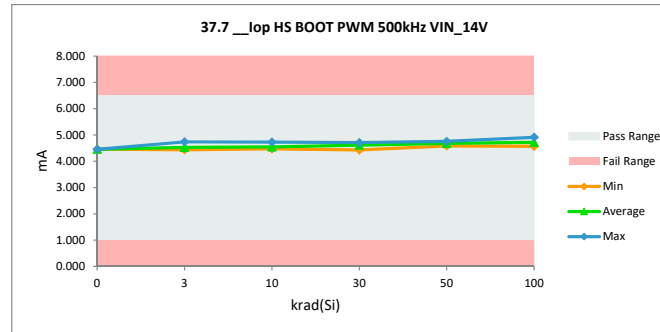

TID HDR Report
TPS7H6003-SP (5962R2220101VXC)

37.8 Iop LS VIN PWM 1MHz VIN		
Test Site	DAL-FL	DAL-FL
Tester	ETS364	ETS364
Test Number	EB672302	EB672302
Unit	mA	mA
Max Limit	11	11
Min Limit	1	1

krad(Si)	Serial #	pre_short (rtp)	(2)'ST_Combo (rpt)	Delta
0	Ctrl	8.058	8.058	0.000
3	58	8.124	8.128	0.004
3	59	7.998	8.005	0.006
3	60	7.996	8.005	0.009
3	61	8.061	8.073	0.012
3	62	8.116	8.101	-0.014
3	134	8.002	8.169	0.167
3	137	8.033	8.169	0.136
3	138	8.063	8.158	0.096
3	139	8.217	8.206	-0.011
3	236	8.071	8.226	0.155
10	63	8.241	8.243	0.003
10	64	8.276	8.274	-0.002
10	65	8.193	8.191	-0.002
10	66	7.979	7.975	-0.003
10	150	8.091	8.076	-0.016
10	237	8.131	8.220	0.090
10	241	8.269	8.166	-0.103
10	242	8.066	8.070	0.003
10	243	8.144	8.153	0.009
10	244	8.267	8.231	-0.036
30	141	8.148	8.194	0.046
30	144	8.122	8.168	0.045
30	145	8.206	8.256	0.049
30	146	8.122	8.151	0.029
30	147	8.211	8.243	0.032
30	132	8.093	8.132	0.039
30	133	8.277	8.348	0.071
30	135	8.284	8.049	-0.235
30	245	8.105	8.159	0.054
30	246	8.136	8.168	0.032
50	67	8.233	8.303	0.070
50	68	8.001	8.317	0.316
50	69	8.160	8.238	0.079
50	71	8.031	8.162	0.131
50	72	8.094	8.186	0.091
50	172	8.286	8.438	0.152
50	173	8.099	8.138	0.039
50	174	7.947	8.071	0.124
50	183	7.997	8.093	0.096
50	186	8.199	8.297	0.098
100	95	8.197	8.358	0.161
100	102	8.056	8.200	0.144
100	104	8.046	8.234	0.187
100	105	8.118	8.290	0.171
100	106	8.167	8.200	0.034
100	178	8.203	8.383	0.180
100	179	8.141	8.249	0.108
100	180	8.159	8.275	0.116
100	181	7.975	8.170	0.196
100	182	8.091	8.291	0.200
	Max	8.286	8.438	0.316
	Average	8.124	8.189	0.066
	Min	7.947	7.975	-0.235
	Std Dev	0.092	0.099	0.089

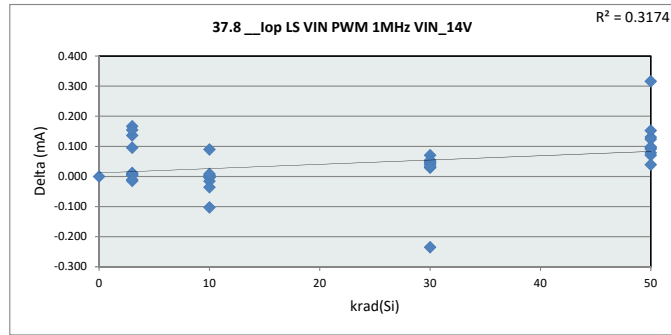

37.8 Iop LS VIN P						
Test Site	DAL-FL					
Tester	ETS364					
Test Number	EB672302					
Max Limit	11	mA				
Min Limit	1	mA				
krad(Si)	0	3	10	30	50	100
LL	1.000	1.000	1.000	1.000	1.000	1.000
Min	8.058	8.005	7.975	8.049	8.071	8.170
Average	8.058	8.124	8.160	8.187	8.224	8.265
Max	8.058	8.226	8.274	8.348	8.438	8.383
UL	11.000	11.000	11.000	11.000	11.000	11.000

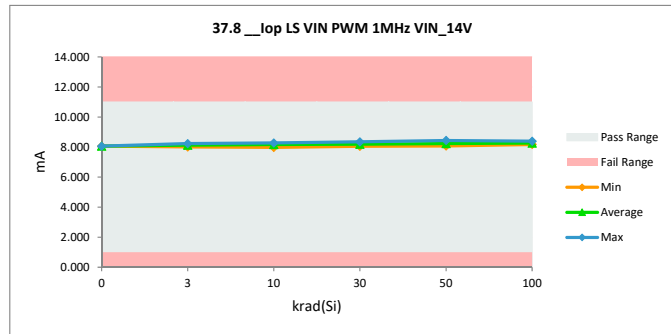

TID HDR Report

TPS7H6003-SP (5962R2220101VXC)

37.9 Iop HS BOOT PWM 1MHz		
Test Site	DAL-FL	DAL-FL
Tester	ETS364	ETS364
Test Number	EB672302	EB672302
Unit	mA	mA
Max Limit	8	8
Min Limit	1	1

krad(Si)	Serial #	pre_short (rtp)	(2)'ST_Combo (rpt)	Delta
0	Ctrl	5.287	5.287	0.000
3	58	5.268	5.293	0.025
3	59	5.352	5.352	0.000
3	60	5.236	5.263	0.027
3	61	5.261	5.270	0.010
3	62	5.271	5.274	0.004
3	134	5.317	5.362	0.045
3	137	5.387	5.364	-0.023
3	138	5.375	5.349	-0.025
3	139	5.486	5.477	-0.010
3	236	5.320	5.564	0.245
10	63	5.362	5.395	0.032
10	64	5.374	5.383	0.009
10	65	5.306	5.325	0.019
10	66	5.273	5.302	0.029
10	150	5.413	5.417	0.005
10	237	5.409	5.556	0.147
10	241	5.341	5.359	0.018
10	242	5.326	5.338	0.012
10	243	5.292	5.304	0.012
10	244	5.354	5.350	-0.004
30	141	5.425	5.526	0.101
30	144	5.279	5.366	0.088
30	145	5.414	5.454	0.041
30	146	5.303	5.393	0.090
30	147	5.420	5.496	0.076
30	132	5.202	5.273	0.071
30	133	5.418	5.523	0.105
30	135	5.425	5.256	-0.169
30	245	5.456	5.540	0.084
30	246	5.428	5.536	0.109
50	67	5.385	5.508	0.122
50	68	5.287	5.587	0.300
50	69	5.361	5.493	0.132
50	71	5.262	5.412	0.150
50	72	5.419	5.555	0.135
50	172	5.397	5.517	0.120
50	173	5.298	5.450	0.152
50	174	5.434	5.580	0.146
50	183	5.305	5.484	0.179
50	186	5.288	5.438	0.150
100	95	5.380	5.585	0.204
100	102	5.200	5.390	0.190
100	104	5.262	5.520	0.258
100	105	5.299	5.535	0.236
100	106	5.259	5.452	0.193
100	178	5.470	5.739	0.269
100	179	5.326	5.595	0.269
100	180	5.296	5.509	0.213
100	181	5.324	5.575	0.252
100	182	5.329	5.606	0.276
Max		5.486	5.739	0.300
Average		5.340	5.441	0.100
Min		5.200	5.256	-0.169
Std Dev		0.070	0.114	0.102

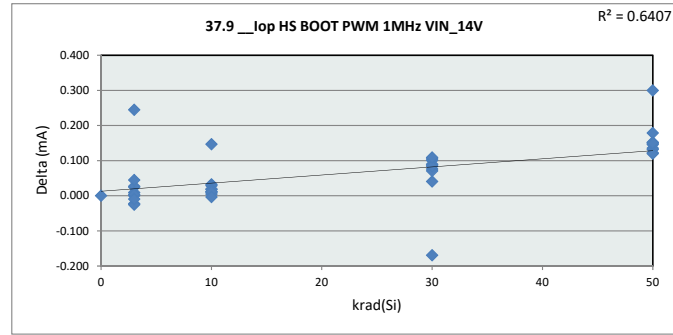

37.9 Iop HS BOOT		
Test Site	DAL-FL	
Tester	ETS364	
Test Number	EB672302	
Max Limit	8	mA
Min Limit	1	mA

krad(Si)	0	3	10	30	50	100
LL	1.000	1.000	1.000	1.000	1.000	1.000
Min	5.287	5.263	5.302	5.256	5.413	5.390
Average	5.287	5.357	5.373	5.436	5.502	5.551
Max	5.287	5.564	5.556	5.540	5.587	5.739
UL	8.000	8.000	8.000	8.000	8.000	8.000

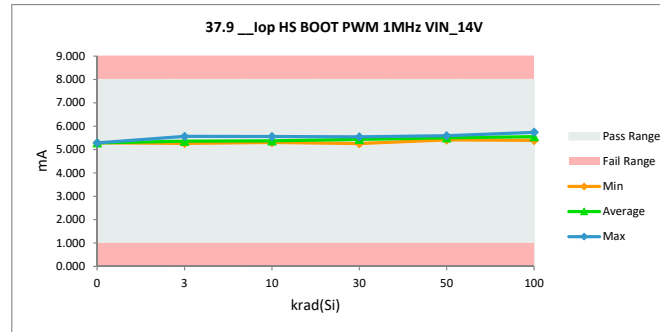

TID HDR Report
TPS7H6003-SP (5962R2220101VXC)

37.10_Top LS VIN PWM 2MHz V		
Test Site	DAL-FL	DAL-FL
Tester	ETS364	ETS364
Test Number	EB672302	EB672302
Unit	mA	mA
Max Limit	16	16
Min Limit	1	1

krad(Si)	Serial #	pre_short (rtp)	(2)ST_Combo (rpt)	Delta
0	Ctrl	11.437	11.437	0.000
3	58	11.498	11.510	0.012
3	59	11.362	11.383	0.021
3	60	11.342	11.362	0.020
3	61	11.441	11.453	0.012
3	62	11.503	11.486	-0.018
3	134	11.379	11.557	0.179
3	137	11.396	11.559	0.163
3	138	11.439	11.547	0.108
3	139	11.595	11.593	-0.001
3	236	11.438	11.602	0.164
10	63	11.625	11.634	0.009
10	64	11.659	11.660	0.001
10	65	11.577	11.595	0.018
10	66	11.336	11.334	-0.001
10	150	11.481	11.478	-0.002
10	237	11.504	11.597	0.093
10	241	11.644	11.554	-0.090
10	242	11.406	11.420	0.013
10	243	11.515	11.523	0.008
10	244	11.633	11.611	-0.022
30	141	11.532	11.627	0.095
30	144	11.510	11.588	0.078
30	145	11.615	11.682	0.066
30	146	11.477	11.534	0.057
30	147	11.601	11.674	0.073
30	132	11.481	11.535	0.055
30	133	11.663	11.756	0.092
30	135	11.650	11.429	-0.221
30	245	11.484	11.572	0.088
30	246	11.531	11.602	0.071
50	67	11.594	11.724	0.129
50	68	11.364	11.763	0.399
50	69	11.541	11.688	0.147
50	71	11.413	11.581	0.169
50	72	11.446	11.599	0.153
50	172	11.655	11.901	0.245
50	173	11.471	11.554	0.082
50	174	11.347	11.536	0.189
50	183	11.383	11.547	0.163
50	186	11.585	11.713	0.128
100	95	11.575	11.823	0.248
100	102	11.412	11.661	0.248
100	104	11.398	11.676	0.279
100	105	11.500	11.788	0.288
100	106	11.538	11.627	0.089
100	178	11.583	11.865	0.282
100	179	11.516	11.712	0.196
100	180	11.552	11.725	0.174
100	181	11.349	11.637	0.289
100	182	11.462	11.766	0.304
	Max	11.663	11.901	0.399
	Average	11.499	11.603	0.105
	Min	11.336	11.334	-0.221
	Std Dev	0.096	0.124	0.116

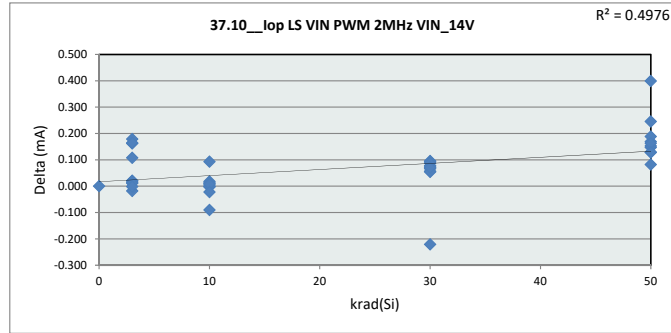

37.10_Top LS VIN PWM 2MHz VIN_14V						
Test Site	DAL-FL					
Tester	ETS364					
Test Number	EB672302					
Max Limit	16	mA				
Min Limit	1	mA				
krad(Si)	0	3	10	30	50	100
LL	1.000	1.000	1.000	1.000	1.000	1.000
Min	11.437	11.362	11.334	11.429	11.536	11.627
Average	11.437	11.505	11.541	11.600	11.661	11.728
Max	11.437	11.602	11.660	11.756	11.901	11.865
UL	16.000	16.000	16.000	16.000	16.000	16.000

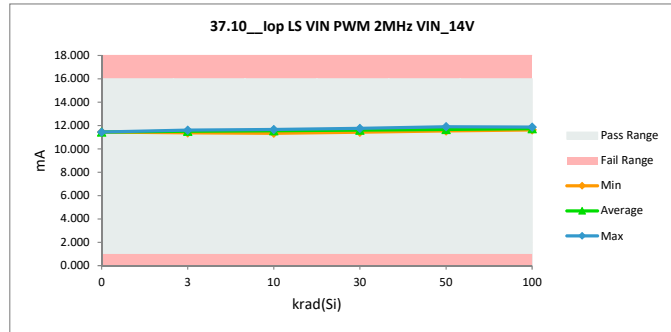

TID HDR Report
TPS7H6003-SP (5962R2220101VXC)

37.11_Iop HS BOOT PWM 2MHz		
Test Site	DAL-FL	DAL-FL
Tester	ETS364	ETS364
Test Number	EB672302	EB672302
Unit	mA	mA
Max Limit	10.5	10.5
Min Limit	1	1

krad(Si)	Serial #	pre_short (rtp)	(2)ST_Combo (rpt)	Delta
0	Ctrl	6.935	6.935	0.000
3	58	6.934	6.972	0.038
3	59	7.003	7.022	0.019
3	60	6.888	6.917	0.029
3	61	6.907	6.938	0.031
3	62	6.913	6.941	0.029
3	134	6.970	7.037	0.067
3	137	7.044	7.040	-0.004
3	138	7.019	7.025	0.006
3	139	7.146	7.152	0.006
3	236	6.962	7.245	0.283
10	63	7.017	7.044	0.027
10	64	7.035	7.051	0.017
10	65	6.971	6.983	0.012
10	66	6.910	6.951	0.041
10	150	7.078	7.074	-0.004
10	237	7.039	7.235	0.196
10	241	6.997	7.034	0.037
10	242	6.986	6.995	0.008
10	243	6.953	6.971	0.017
10	244	7.011	7.023	0.011
30	141	7.093	7.194	0.101
30	144	6.932	7.026	0.093
30	145	7.077	7.123	0.046
30	146	6.958	7.050	0.092
30	147	7.077	7.163	0.086
30	132	6.868	6.948	0.079
30	133	7.076	7.197	0.121
30	135	7.068	6.907	-0.161
30	245	7.128	7.224	0.096
30	246	7.081	7.191	0.110
50	67	7.028	7.161	0.133
50	68	6.947	7.264	0.317
50	69	7.015	7.156	0.141
50	71	6.903	7.056	0.154
50	72	7.062	7.210	0.148
50	172	7.036	7.172	0.137
50	173	6.951	7.114	0.163
50	174	7.097	7.248	0.151
50	183	6.960	7.153	0.193
50	186	6.931	7.094	0.163
100	95	7.042	7.250	0.208
100	102	6.848	7.050	0.202
100	104	6.921	7.195	0.274
100	105	6.954	7.197	0.242
100	106	6.915	7.095	0.180
100	178	7.123	7.393	0.270
100	179	6.990	7.271	0.281
100	180	6.957	7.180	0.224
100	181	6.993	7.244	0.251
100	182	6.990	7.281	0.291
	Max	7.146	7.393	0.317
	Average	6.995	7.106	0.111
	Min	6.848	6.907	-0.161
	Std Dev	0.071	0.117	0.103

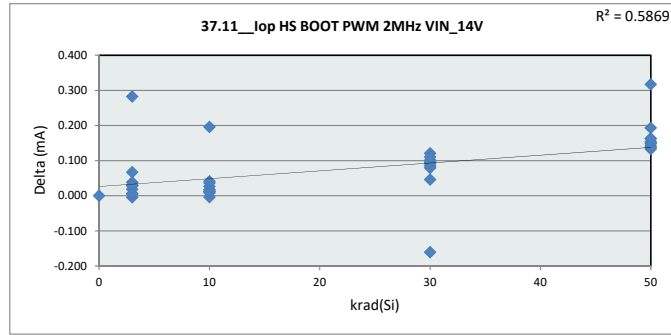

37.11_Iop HS BOO

Test Site	DAL-FL
Tester	ETS364
Test Number	EB672302
Max Limit	10.5 mA
Min Limit	1 mA

krad(Si)	0	3	10	30	50	100
LL	1.000	1.000	1.000	1.000	1.000	1.000
Min	6.935	6.917	6.951	6.907	7.056	7.050
Average	6.935	7.029	7.036	7.102	7.163	7.216
Max	6.935	7.245	7.235	7.224	7.264	7.393
UL	10.500	10.500	10.500	10.500	10.500	10.500

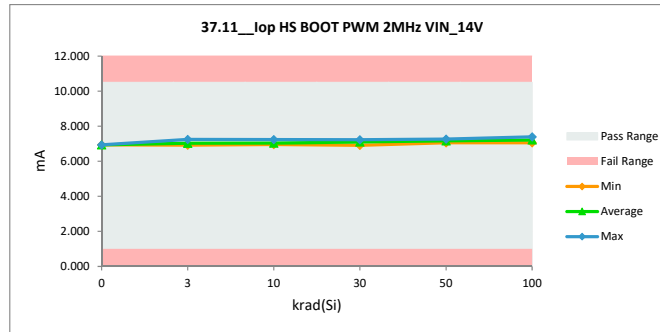

TID HDR Report
TPS7H6003-SP (5962R2220101VXC)

37.12_Top LS VIN PWM 5MHz V		
Test Site	DAL-FL	DAL-FL
Tester	ETS364	ETS364
Test Number	EB672302	EB672302
Unit	mA	mA
Max Limit	30	30
Min Limit	1	1

krad(Si)	Serial #	pre_short (rtp)	(2)ST_Combo (rpt)	Delta
0	Ctrl	20.263	20.263	0.000
3	58	18.050	18.051	0.001
3	59	18.211	18.284	0.073
3	60	18.029	18.063	0.034
3	61	18.207	18.223	0.016
3	62	18.087	18.074	-0.013
3	134	17.502	18.727	1.225
3	137	18.374	18.728	0.354
3	138	18.074	18.720	0.646
3	139	18.762	18.778	0.016
3	236	20.249	18.625	-1.624
10	63	18.482	18.512	0.031
10	64	17.877	18.034	0.157
10	65	18.490	18.522	0.032
10	66	17.917	18.028	0.111
10	150	18.088	18.160	0.073
10	237	18.559	18.621	0.062
10	241	18.629	18.727	0.097
10	242	17.688	17.778	0.090
10	243	18.153	18.324	0.171
10	244	18.575	18.531	-0.044
30	141	18.199	18.510	0.311
30	144	17.949	18.347	0.398
30	145	18.289	18.603	0.315
30	146	17.990	18.322	0.332
30	147	18.303	18.613	0.310
30	132	17.567	18.038	0.472
30	133	18.347	18.726	0.379
30	135	18.775	18.159	-0.616
30	245	18.207	18.504	0.297
30	246	17.855	18.177	0.322
50	67	18.352	18.717	0.365
50	68	20.329	18.863	-1.465
50	69	17.797	18.398	0.602
50	71	17.902	18.521	0.618
50	72	18.344	18.794	0.451
50	172	18.895	19.273	0.378
50	173	18.164	18.511	0.346
50	174	20.093	18.038	-2.055
50	183	17.914	18.385	0.471
50	186	18.045	18.641	0.596
100	95	18.285	18.686	0.401
100	102	17.868	18.760	0.892
100	104	18.113	18.845	0.732
100	105	18.039	18.931	0.892
100	106	17.830	18.561	0.732
100	178	18.160	19.095	0.934
100	179	17.691	18.604	0.913
100	180	18.263	18.444	0.180
100	181	17.891	18.732	0.841
100	182	17.815	18.909	1.094
	Max	20.329	20.263	1.225
	Average	18.305	18.539	0.234
	Min	17.502	17.778	-2.055
	Std Dev	0.643	0.396	0.604

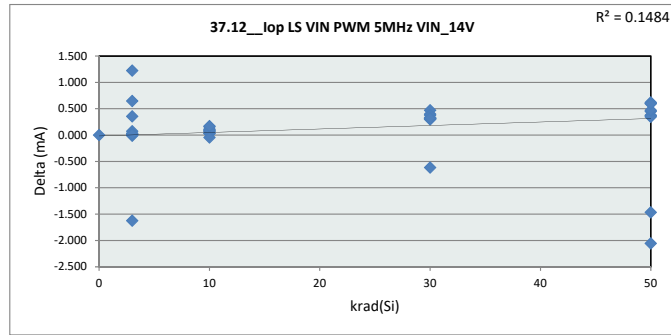

37.12_Top LS VIN PWM 5MHz V						
Test Site	DAL-FL					
Tester	ETS364					
Test Number	EB672302					
Max Limit	30	mA				
Min Limit	1	mA				
krad(Si)	0	3	10	30	50	100
LL	1.000	1.000	1.000	1.000	1.000	1.000
Min	20.263	18.051	17.778	18.038	18.038	18.444
Average	20.263	18.427	18.324	18.400	18.614	18.757
Max	20.263	18.778	18.727	18.726	19.273	19.095
UL	30.000	30.000	30.000	30.000	30.000	30.000

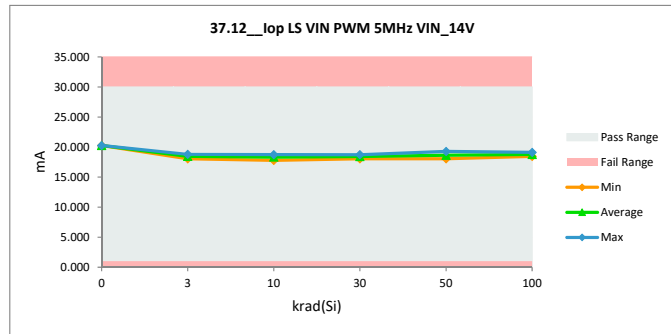

TID HDR Report

TPS7H6003-SP (5962R2220101VXC)

37.13 Top HS BOOT PWM 5MHz		
Test Site	DAL-FL	DAL-FL
Tester	ETS364	ETS364
Test Number	EB672302	EB672302
Unit	mA	mA
Max Limit	17.5	17.5
Min Limit	1	1

krad(Si)	Serial #	pre_short (rtp)	(2)ST_Combo (rpt)	Delta
0	Ctrl	13.436	13.436	0.000
3	58	12.674	13.169	0.495
3	59	11.377	12.090	0.713
3	60	12.068	12.654	0.586
3	61	10.942	10.954	0.012
3	62	10.913	11.143	0.230
3	134	13.638	11.471	-2.167
3	137	11.139	11.479	0.340
3	138	11.045	11.498	0.452
3	139	12.477	12.839	0.362
3	236	13.363	13.772	0.409
10	63	13.588	13.826	0.239
10	64	13.661	13.847	0.186
10	65	13.662	13.601	-0.061
10	66	10.806	10.958	0.152
10	150	13.801	13.831	0.030
10	237	11.034	13.774	2.740
10	241	13.325	11.518	-1.807
10	242	13.336	13.626	0.290
10	243	11.724	12.208	0.484
10	244	12.493	12.675	0.183
30	141	13.333	13.015	-0.318
30	144	12.598	12.445	-0.153
30	145	11.485	11.204	-0.281
30	146	12.511	12.412	-0.099
30	147	13.096	12.825	-0.271
30	132	12.650	12.516	-0.134
30	133	12.957	12.656	-0.302
30	135	11.040	10.608	-0.431
30	245	13.274	12.752	-0.522
30	246	13.719	13.334	-0.385
50	67	11.024	11.131	0.107
50	68	12.414	12.243	-0.171
50	69	13.375	12.649	-0.726
50	71	10.877	10.372	-0.505
50	72	12.207	11.913	-0.294
50	172	11.020	11.040	0.019
50	173	12.456	12.188	-0.268
50	174	13.827	13.416	-0.410
50	183	12.979	12.584	-0.395
50	186	10.831	10.566	-0.264
100	95	13.454	11.658	-1.797
100	102	12.011	11.018	-0.993
100	104	12.534	11.443	-1.091
100	105	12.032	10.850	-1.182
100	106	12.306	10.981	-1.326
100	178	12.220	11.466	-0.755
100	179	12.382	11.390	-0.992
100	180	13.310	12.022	-1.288
100	181	12.771	11.311	-1.460
100	182	11.924	11.174	-0.750
Max		13.827	13.847	2.740
Average		12.414	12.148	-0.266
Min		10.806	10.372	-2.167
Std Dev		0.972	1.020	0.787

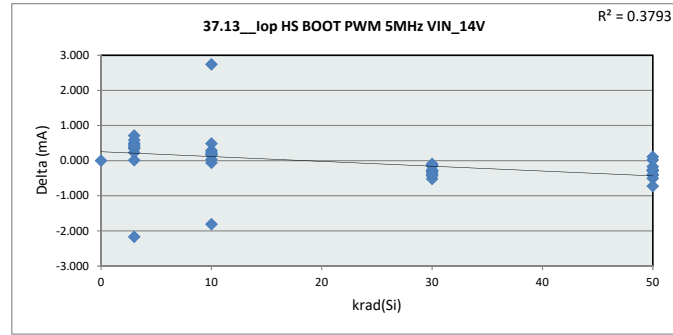

37.13 Top HS BOOT PWM 5MHz VIN_14V						
Test Site	DAL-FL					
Tester	ETS364					
Test Number	EB672302					
Max Limit	17.5			mA		
Min Limit	1			mA		
krad(Si)	0	3	10	30	50	100
LL	1.000	1.000	1.000	1.000	1.000	1.000
Min	13.436	10.954	10.958	10.608	10.372	10.850
Average	13.436	12.107	12.987	12.377	11.810	11.331
Max	13.436	13.772	13.848	13.334	13.416	12.022
UL	17.500	17.500	17.500	17.500	17.500	17.500

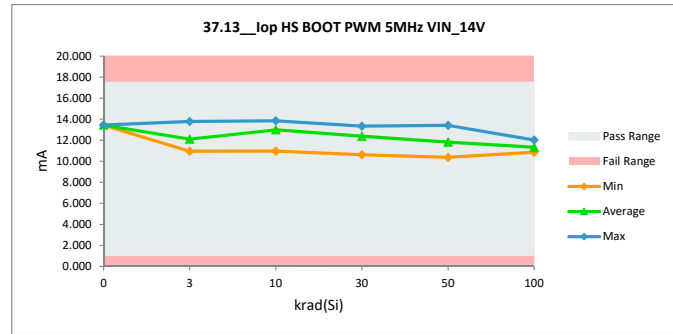

TID HDR Report
TPS7H6003-SP (5962R2220101VXC)

37.14 Top LS VIN IIM Interlock		
Test Site	DAL-FL	DAL-FL
Tester	ETS364	ETS364
Test Number	EB672302	EB672302
Unit	mA	mA
Max Limit	9	9
Min Limit	1	1

krad(Si)	Serial #	pre_short (rtp)	(2)ST_Combo (rpt)	Delta
0	Ctrl	5.767	5.767	0.000
3	58	5.852	5.858	0.006
3	59	5.784	5.789	0.005
3	60	5.761	5.771	0.010
3	61	5.807	5.822	0.016
3	62	5.834	5.821	-0.013
3	134	5.742	5.927	0.185
3	137	5.769	5.929	0.160
3	138	5.793	5.917	0.124
3	139	5.995	5.984	-0.010
3	236	5.799	5.977	0.178
10	63	5.963	5.975	0.011
10	64	5.954	5.958	0.004
10	65	5.865	5.871	0.007
10	66	5.708	5.714	0.006
10	150	5.840	5.830	-0.010
10	237	5.884	5.972	0.087
10	241	6.016	5.925	-0.091
10	242	5.817	5.827	0.010
10	243	5.840	5.850	0.010
10	244	6.033	6.001	-0.032
30	141	5.867	5.940	0.073
30	144	5.809	5.883	0.074
30	145	5.952	6.028	0.076
30	146	5.886	5.941	0.055
30	147	5.962	6.018	0.057
30	132	5.794	5.861	0.066
30	133	6.000	6.099	0.099
30	135	6.028	5.805	-0.224
30	245	5.813	5.895	0.082
30	246	5.898	5.957	0.059
50	67	5.937	6.057	0.120
50	68	5.719	6.035	0.316
50	69	5.897	6.020	0.123
50	71	5.814	5.983	0.169
50	72	5.826	5.971	0.145
50	172	6.002	6.176	0.174
50	173	5.810	5.888	0.078
50	174	5.690	5.848	0.157
50	183	5.765	5.897	0.132
50	186	5.898	6.036	0.137
100	95	5.902	6.157	0.255
100	102	5.810	6.030	0.220
100	104	5.811	6.078	0.267
100	105	5.826	6.064	0.238
100	106	5.892	6.031	0.139
100	178	5.926	6.174	0.249
100	179	5.865	6.047	0.182
100	180	5.854	6.067	0.213
100	181	5.710	5.984	0.274
100	182	5.793	6.063	0.270
	Max	6.033	6.176	0.316
	Average	5.855	5.951	0.097
	Min	5.690	5.714	-0.224
	Std Dev	0.088	0.108	0.107

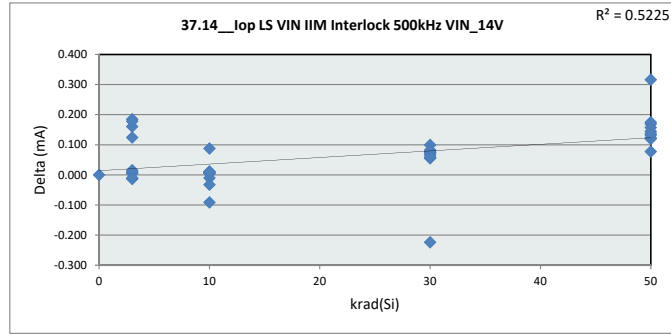

37.14 Top LS VIN IIM

Test Site	DAL-FL
Tester	ETS364
Test Number	EB672302
Max Limit	9 mA
Min Limit	1 mA

krad(Si)	0	3	10	30	50	100
LL	1.000	1.000	1.000	1.000	1.000	1.000
Min	5.767	5.771	5.714	5.805	5.848	5.984
Average	5.767	5.880	5.892	5.943	5.991	6.069
Max	5.767	5.984	6.001	6.099	6.176	6.174
UL	9.000	9.000	9.000	9.000	9.000	9.000

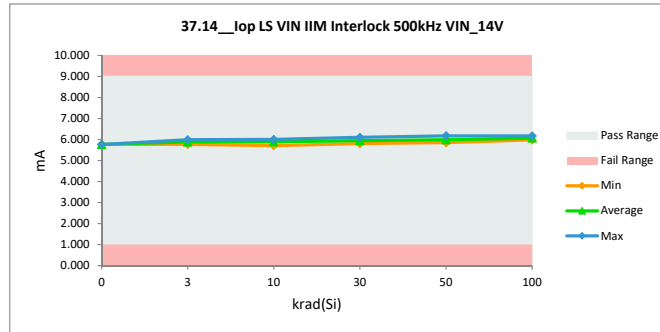

TID HDR Report
TPS7H6003-SP (5962R2220101VXC)

37.15_Top HS BOOT IIM Interlock		
Test Site	DAL-FL	DAL-FL
Tester	ETS364	ETS364
Test Number	EB672302	EB672302
Unit	mA	mA
Max Limit	6.5	6.5
Min Limit	1	1

krad(Si)	Serial #	pre_short (rtp)	(2)ST_Combo (rpt)	Delta
0	Ctrl	4.461	4.461	0.000
3	58	4.446	4.463	0.017
3	59	4.531	4.523	-0.008
3	60	4.420	4.438	0.019
3	61	4.441	4.444	0.002
3	62	4.452	4.446	-0.006
3	134	4.499	4.530	0.031
3	137	4.561	4.533	-0.029
3	138	4.552	4.518	-0.034
3	139	4.665	4.648	-0.017
3	236	4.502	4.738	0.236
10	63	4.543	4.568	0.025
10	64	4.551	4.553	0.003
10	65	4.482	4.492	0.010
10	66	4.457	4.481	0.023
10	150	4.587	4.583	-0.004
10	237	4.594	4.728	0.134
10	241	4.525	4.529	0.003
10	242	4.507	4.509	0.002
10	243	4.471	4.475	0.004
10	244	4.536	4.527	-0.009
30	141	4.603	4.693	0.090
30	144	4.462	4.542	0.079
30	145	4.586	4.623	0.037
30	146	4.486	4.569	0.082
30	147	4.602	4.669	0.068
30	132	4.381	4.441	0.060
30	133	4.600	4.694	0.094
30	135	4.605	4.427	-0.178
30	245	4.634	4.710	0.076
30	246	4.609	4.711	0.102
50	67	4.563	4.675	0.112
50	68	4.466	4.760	0.293
50	69	4.542	4.663	0.121
50	71	4.439	4.582	0.143
50	72	4.608	4.731	0.123
50	172	4.578	4.690	0.112
50	173	4.486	4.630	0.144
50	174	4.614	4.749	0.135
50	183	4.489	4.660	0.171
50	186	4.467	4.609	0.142
100	95	4.561	4.754	0.194
100	102	4.385	4.566	0.181
100	104	4.445	4.688	0.243
100	105	4.484	4.705	0.220
100	106	4.441	4.628	0.188
100	178	4.655	4.916	0.261
100	179	4.506	4.763	0.257
100	180	4.475	4.675	0.200
100	181	4.499	4.745	0.246
100	182	4.511	4.772	0.262
	Max	4.665	4.916	0.293
	Average	4.521	4.612	0.091
	Min	4.381	4.427	-0.178
	Std Dev	0.069	0.114	0.101

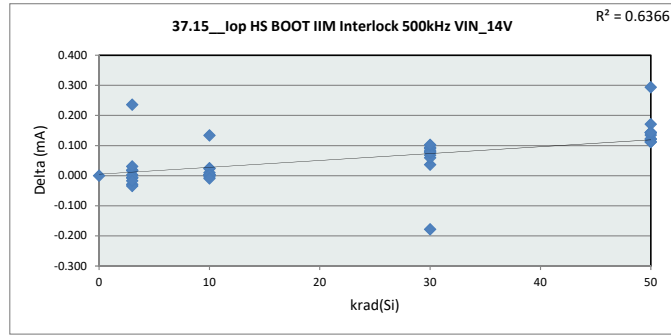

37.15_Top HS BOO

Test Site	DAL-FL
Tester	ETS364
Test Number	EB672302
Max Limit	6.5 mA
Min Limit	1 mA

krad(Si)	0	3	10	30	50	100
LL	1.000	1.000	1.000	1.000	1.000	1.000
Min	4.461	4.438	4.475	4.427	4.583	4.566
Average	4.461	4.528	4.545	4.608	4.675	4.721
Max	4.461	4.738	4.728	4.711	4.760	4.916
UL	6.500	6.500	6.500	6.500	6.500	6.500

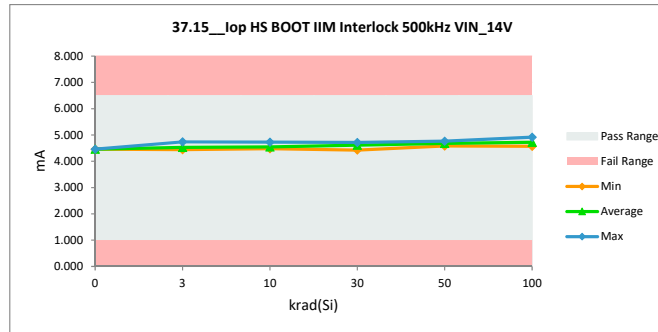

TID HDR Report
TPS7H6003-SP (5962R2220101VXC)

37.16_Top LS VIN IIM Interlock		
Test Site	DAL-FL	DAL-FL
Tester	ETS364	ETS364
Test Number	EB672302	EB672302
Unit	mA	mA
Max Limit	12	12
Min Limit	1	1

krad(Si)	Serial #	pre_short (rtp)	(2)'ST_Combo (rpt)	Delta
0	Ctrl	7.236	7.236	0.000
3	58	7.323	7.330	0.007
3	59	7.251	7.256	0.005
3	60	7.214	7.225	0.011
3	61	7.278	7.295	0.017
3	62	7.306	7.292	-0.014
3	134	7.213	7.404	0.191
3	137	7.235	7.405	0.170
3	138	7.265	7.392	0.127
3	139	7.469	7.456	-0.014
3	236	7.263	7.444	0.181
10	63	7.434	7.449	0.015
10	64	7.424	7.431	0.008
10	65	7.336	7.344	0.008
10	66	7.168	7.177	0.009
10	150	7.317	7.307	-0.010
10	237	7.357	7.437	0.080
10	241	7.484	7.402	-0.082
10	242	7.272	7.283	0.012
10	243	7.302	7.316	0.014
10	244	7.500	7.470	-0.030
30	141	7.343	7.426	0.083
30	144	7.284	7.370	0.086
30	145	7.435	7.523	0.088
30	146	7.346	7.411	0.064
30	147	7.437	7.502	0.065
30	132	7.269	7.342	0.073
30	133	7.472	7.581	0.109
30	135	7.497	7.281	-0.216
30	245	7.285	7.378	0.093
30	246	7.373	7.442	0.069
50	67	7.403	7.544	0.141
50	68	7.180	7.533	0.353
50	69	7.371	7.514	0.143
50	71	7.285	7.475	0.190
50	72	7.288	7.449	0.161
50	172	7.475	7.679	0.204
50	173	7.274	7.371	0.097
50	174	7.169	7.347	0.178
50	183	7.240	7.391	0.151
50	186	7.369	7.529	0.159
100	95	7.374	7.662	0.287
100	102	7.271	7.527	0.256
100	104	7.271	7.570	0.299
100	105	7.291	7.579	0.288
100	106	7.359	7.521	0.162
100	178	7.398	7.681	0.283
100	179	7.336	7.553	0.217
100	180	7.331	7.567	0.235
100	181	7.178	7.489	0.310
100	182	7.259	7.565	0.306
	Max	7.500	7.681	0.353
	Average	7.324	7.434	0.111
	Min	7.168	7.177	-0.216
	Std Dev	0.090	0.119	0.118

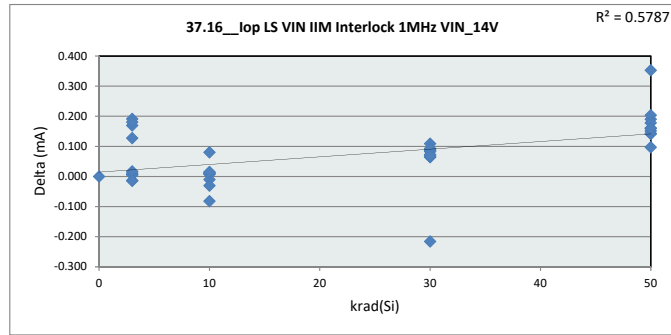

37.16_Top LS VIN I		
Test Site	DAL-FL	
Tester	ETS364	
Test Number	EB672302	
Max Limit	12	mA
Min Limit	1	mA

krad(Si)	0	3	10	30	50	100
LL	1.000	1.000	1.000	1.000	1.000	1.000
Min	7.236	7.225	7.177	7.281	7.347	7.489
Average	7.236	7.350	7.362	7.425	7.483	7.571
Max	7.236	7.456	7.470	7.581	7.679	7.681
UL	12.000	12.000	12.000	12.000	12.000	12.000

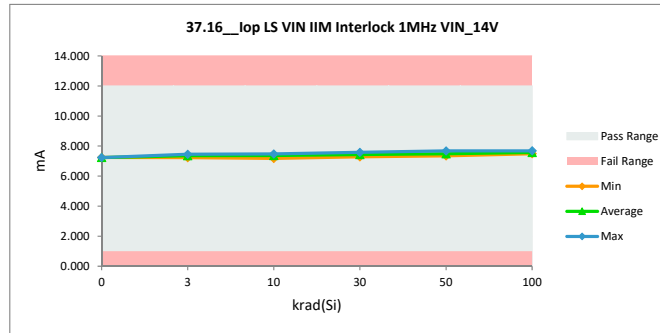

TID HDR Report
TPS7H6003-SP (5962R2220101VXC)

37.17_Iop HS BOOT IIM Interlock		
Test Site	DAL-FL	DAL-FL
Tester	ETS364	ETS364
Test Number	EB672302	EB672302
Unit	mA	mA
Max Limit	8	8
Min Limit	1	1

krad(Si)	Serial #	pre_short (rtp) (2)	ST_Combo (rpt) (Delta
0	Ctrl	5.290	5.290	0.000
3	58	5.273	5.294	0.022
3	59	5.353	5.353	-0.001
3	60	5.239	5.264	0.025
3	61	5.264	5.272	0.008
3	62	5.274	5.276	0.002
3	134	5.320	5.361	0.042
3	137	5.385	5.363	-0.022
3	138	5.376	5.348	-0.027
3	139	5.486	5.475	-0.011
3	236	5.321	5.566	0.245
10	63	5.364	5.396	0.032
10	64	5.375	5.383	0.008
10	65	5.305	5.321	0.016
10	66	5.279	5.306	0.027
10	150	5.410	5.413	0.003
10	237	5.412	5.558	0.146
10	241	5.343	5.359	0.017
10	242	5.329	5.338	0.008
10	243	5.295	5.305	0.010
10	244	5.356	5.352	-0.005
30	141	5.426	5.523	0.097
30	144	5.281	5.366	0.085
30	145	5.415	5.454	0.039
30	146	5.305	5.393	0.088
30	147	5.421	5.493	0.072
30	132	5.206	5.270	0.064
30	133	5.420	5.520	0.100
30	135	5.426	5.253	-0.173
30	245	5.459	5.539	0.081
30	246	5.424	5.532	0.107
50	67	5.383	5.503	0.120
50	68	5.287	5.590	0.303
50	69	5.361	5.490	0.129
50	71	5.260	5.411	0.151
50	72	5.423	5.552	0.130
50	172	5.398	5.516	0.118
50	173	5.306	5.450	0.144
50	174	5.437	5.581	0.145
50	183	5.309	5.485	0.177
50	186	5.291	5.439	0.148
100	95	5.382	5.582	0.199
100	102	5.201	5.389	0.188
100	104	5.267	5.521	0.254
100	105	5.306	5.536	0.231
100	106	5.261	5.450	0.189
100	178	5.474	5.739	0.265
100	179	5.331	5.596	0.265
100	180	5.297	5.507	0.210
100	181	5.323	5.573	0.251
100	182	5.336	5.608	0.272
	Max	5.486	5.739	0.303
	Average	5.342	5.440	0.098
	Min	5.201	5.253	-0.173
	Std Dev	0.069	0.114	0.101

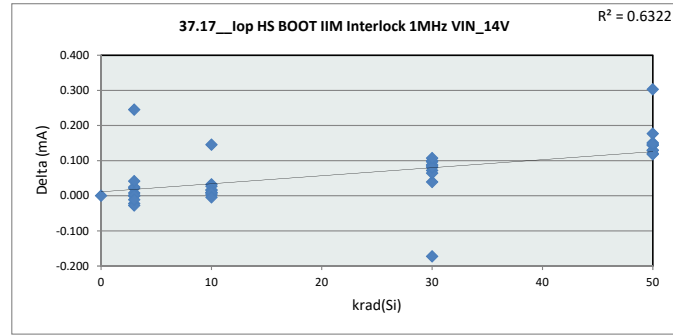

37.17_Iop HS BOOT		
Test Site	DAL-FL	
Tester	ETS364	
Test Number	EB672302	
Max Limit	8	mA
Min Limit	1	mA

krad(Si)	0	3	10	30	50	100
LL	1.000	1.000	1.000	1.000	1.000	1.000
Min	5.290	5.264	5.305	5.253	5.411	5.389
Average	5.290	5.357	5.373	5.434	5.502	5.550
Max	5.290	5.566	5.558	5.539	5.590	5.739
UL	8.000	8.000	8.000	8.000	8.000	8.000

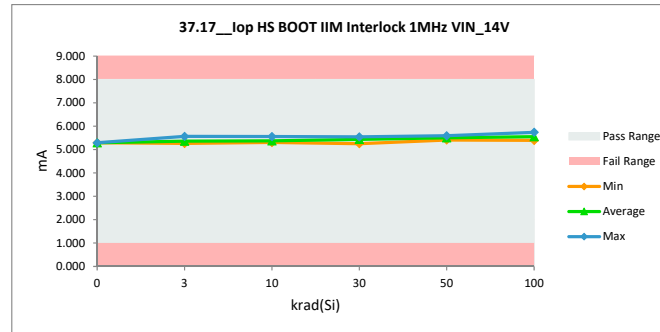

TID HDR Report
TPS7H6003-SP (5962R2220101VXC)

37.18_Top LS VIN IIM Interlock		
Test Site	DAL-FL	DAL-FL
Tester	ETS364	ETS364
Test Number	EB672302	EB672302
Unit	mA	mA
Max Limit	17	17
Min Limit	1	1

krad(Si)	Serial #	pre_short (rtp)	(2)ST_Combo (rpt)	Delta
0	Ctrl	10.167	10.167	0.000
3	58	10.256	10.268	0.012
3	59	10.176	10.183	0.007
3	60	10.115	10.128	0.014
3	61	10.214	10.236	0.021
3	62	10.241	10.233	-0.008
3	134	10.145	10.353	0.208
3	137	10.161	10.354	0.192
3	138	10.202	10.341	0.139
3	139	10.410	10.397	-0.014
3	236	10.182	10.368	0.186
10	63	10.368	10.393	0.024
10	64	10.360	10.372	0.013
10	65	10.270	10.287	0.017
10	66	10.083	10.097	0.014
10	150	10.265	10.257	-0.008
10	237	10.293	10.361	0.068
10	241	10.410	10.349	-0.062
10	242	10.173	10.192	0.019
10	243	10.218	10.238	0.020
10	244	10.424	10.401	-0.023
30	141	10.285	10.394	0.109
30	144	10.227	10.339	0.113
30	145	10.394	10.509	0.115
30	146	10.262	10.347	0.085
30	147	10.383	10.467	0.084
30	132	10.208	10.302	0.094
30	133	10.407	10.539	0.132
30	135	10.431	10.229	-0.202
30	245	10.222	10.337	0.116
30	246	10.317	10.405	0.088
50	67	10.327	10.508	0.181
50	68	10.096	10.529	0.433
50	69	10.312	10.499	0.187
50	71	10.221	10.456	0.235
50	72	10.200	10.401	0.201
50	172	10.415	10.680	0.265
50	173	10.199	10.331	0.133
50	174	10.118	10.341	0.223
50	183	10.181	10.377	0.195
50	186	10.305	10.505	0.199
100	95	10.311	10.668	0.357
100	102	10.184	10.516	0.333
100	104	10.185	10.550	0.365
100	105	10.212	10.603	0.391
100	106	10.284	10.489	0.205
100	178	10.335	10.694	0.359
100	179	10.273	10.552	0.280
100	180	10.281	10.559	0.278
100	181	10.108	10.486	0.378
100	182	10.183	10.568	0.384
	Max	10.431	10.694	0.433
	Average	10.255	10.395	0.140
	Min	10.083	10.097	-0.202
	Std Dev	0.095	0.142	0.141

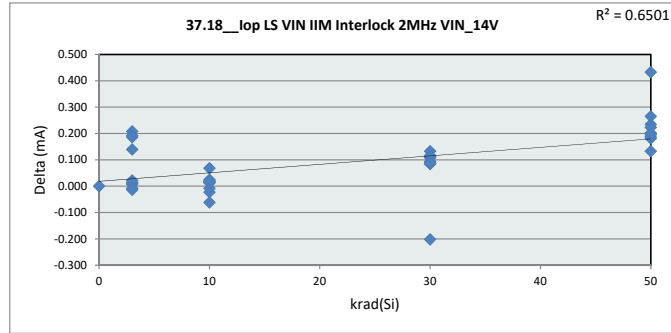

37.18_Top LS VIN I		
Test Site	DAL-FL	
Tester	ETS364	
Test Number	EB672302	
Max Limit	17	mA
Min Limit	1	mA

krad(Si)	0	3	10	30	50	100
LL	1.000	1.000	1.000	1.000	1.000	1.000
Min	10.167	10.128	10.097	10.229	10.331	10.486
Average	10.167	10.286	10.295	10.387	10.463	10.569
Max	10.167	10.397	10.402	10.539	10.680	10.694
UL	17.000	17.000	17.000	17.000	17.000	17.000

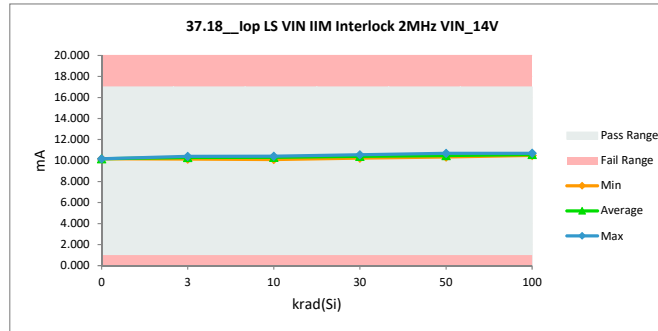

TID HDR Report
TPS7H6003-SP (5962R2220101VXC)

37.19_Top HS BOOT IIM Interlock		
Test Site	DAL-FL	DAL-FL
Tester	ETS364	ETS364
Test Number	EB672302	EB672302
Unit	mA	mA
Max Limit	10.5	10.5
Min Limit	1	1

krad(Si)	Serial #	pre_short (rtp)	(2)ST_Combo (rpt)	Delta
0	Ctrl	6.949	6.949	0.000
3	58	6.924	6.957	0.033
3	59	6.997	7.009	0.011
3	60	6.878	6.911	0.034
3	61	6.909	6.925	0.016
3	62	6.920	6.935	0.015
3	134	6.964	7.019	0.055
3	137	7.035	7.021	-0.013
3	138	7.020	7.008	-0.012
3	139	7.130	7.126	-0.004
3	236	6.959	7.218	0.259
10	63	7.003	7.046	0.043
10	64	7.024	7.038	0.014
10	65	6.953	6.977	0.024
10	66	6.923	6.954	0.032
10	150	7.060	7.068	0.009
10	237	7.048	7.211	0.163
10	241	6.979	7.017	0.038
10	242	6.974	6.997	0.023
10	243	6.945	6.967	0.022
10	244	6.995	6.998	0.003
30	141	7.072	7.183	0.110
30	144	6.920	7.019	0.099
30	145	7.070	7.116	0.047
30	146	6.944	7.040	0.096
30	147	7.059	7.136	0.077
30	132	6.857	6.926	0.069
30	133	7.064	7.170	0.106
30	135	7.064	6.902	-0.162
30	245	7.108	7.195	0.087
30	246	7.054	7.171	0.118
50	67	7.024	7.153	0.129
50	68	6.931	7.247	0.315
50	69	6.998	7.139	0.140
50	71	6.902	7.060	0.157
50	72	7.053	7.194	0.142
50	172	7.040	7.165	0.126
50	173	6.945	7.097	0.152
50	174	7.086	7.241	0.156
50	183	6.949	7.132	0.183
50	186	6.941	7.093	0.152
100	95	7.025	7.230	0.204
100	102	6.836	7.034	0.199
100	104	6.912	7.183	0.272
100	105	6.951	7.195	0.244
100	106	6.904	7.092	0.188
100	178	7.111	7.386	0.275
100	179	6.981	7.257	0.276
100	180	6.938	7.166	0.228
100	181	6.971	7.226	0.255
100	182	6.985	7.273	0.288
	Max	7.130	7.386	0.315
	Average	6.986	7.094	0.108
	Min	6.836	6.902	-0.162
	Std Dev	0.069	0.113	0.102

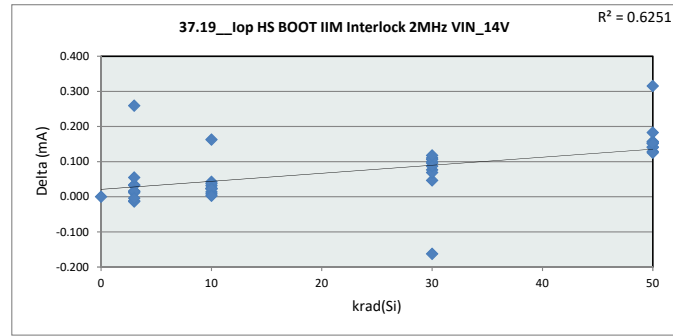

37.19_Top HS BOOT IIM Interlock 2MHz VIN_14V		
Test Site	DAL-FL	DAL-FL
Tester	ETS364	ETS364
Test Number	EB672302	EB672302
Max Limit	10.5	mA
Min Limit	1	mA

krad(Si)	0	3	10	30	50	100
LL	1.000	1.000	1.000	1.000	1.000	1.000
Min	6.949	6.911	6.954	6.902	7.060	7.034
Average	6.949	7.013	7.027	7.086	7.152	7.204
Max	6.949	7.218	7.211	7.195	7.247	7.386
UL	10.500	10.500	10.500	10.500	10.500	10.500

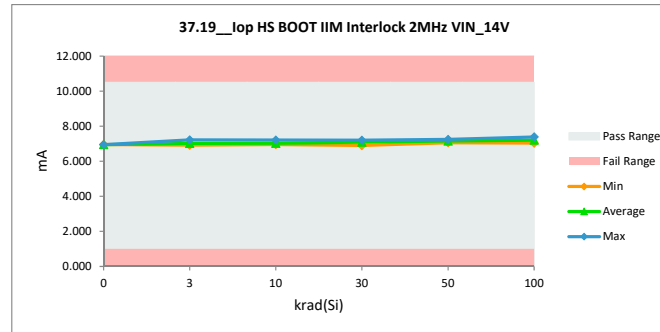

TID HDR Report
TPS7H6003-SP (5962R2220101VXC)

37.20_Top LS VIN IIM Interlock		
Test Site	DAL-FL	DAL-FL
Tester	ETS364	ETS364
Test Number	EB672302	EB672302
Unit	mA	mA
Max Limit	30	30
Min Limit	1	1

krad(Si)	Serial #	pre_short (rtp)	(2)ST_Combo (rpt)	Delta
0	Ctrl	19.223	19.223	0.000
3	58	19.312	19.306	-0.006
3	59	19.238	19.216	-0.023
3	60	19.079	19.077	-0.002
3	61	19.314	19.308	-0.006
3	62	19.304	19.294	-0.010
3	134	19.233	19.451	0.218
3	137	19.220	19.452	0.232
3	138	19.274	19.431	0.157
3	139	19.497	19.427	-0.070
3	236	19.221	19.369	0.148
10	63	19.448	19.461	0.013
10	64	19.445	19.447	0.002
10	65	19.324	19.345	0.021
10	66	19.091	19.105	0.014
10	150	19.392	19.347	-0.045
10	237	19.372	19.361	-0.012
10	241	19.461	19.438	-0.023
10	242	19.162	19.161	-0.001
10	243	19.246	19.263	0.017
10	244	19.455	19.433	-0.022
30	141	19.396	19.553	0.158
30	144	19.338	19.496	0.158
30	145	19.554	19.697	0.143
30	146	19.267	19.396	0.129
30	147	19.460	19.589	0.129
30	132	19.294	19.430	0.136
30	133	19.484	19.659	0.174
30	135	19.480	19.325	-0.155
30	245	19.297	19.422	0.125
30	246	19.405	19.531	0.126
50	67	19.385	19.652	0.267
50	68	19.124	19.755	0.631
50	69	19.430	19.708	0.278
50	71	19.327	19.638	0.310
50	72	19.220	19.503	0.282
50	172	19.508	19.919	0.411
50	173	19.228	19.433	0.204
50	174	19.241	19.564	0.324
50	183	19.291	19.587	0.296
50	186	19.385	19.669	0.285
100	95	19.389	19.914	0.525
100	102	19.179	19.733	0.554
100	104	19.204	19.703	0.499
100	105	19.250	19.920	0.670
100	106	19.323	19.629	0.305
100	178	19.423	19.980	0.557
100	179	19.347	19.796	0.449
100	180	19.396	19.764	0.368
100	181	19.175	19.722	0.547
100	182	19.231	19.799	0.567
	Max	19.554	19.980	0.670
	Average	19.320	19.518	0.197
	Min	19.079	19.077	-0.155
	Std Dev	0.114	0.217	0.211

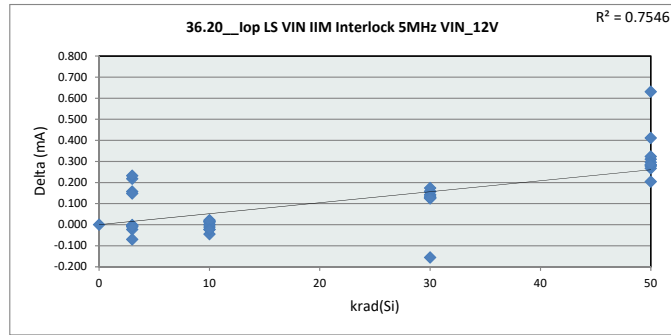

36.20_Top LS VIN IIM Interlock		
Test Site	DAL-FL	DAL-FL
Tester	ETS364	ETS364
Test Number	EB672302	EB672302
Max Limit	30	mA
Min Limit	1	mA

krad(Si)	0	3	10	30	50	100
LL	1.000	1.000	1.000	1.000	1.000	1.000
Min	19.223	19.077	19.105	19.325	19.433	19.629
Average	19.223	19.333	19.336	19.510	19.643	19.796
Max	19.223	19.452	19.461	19.697	19.919	19.980
UL	30.000	30.000	30.000	30.000	30.000	30.000

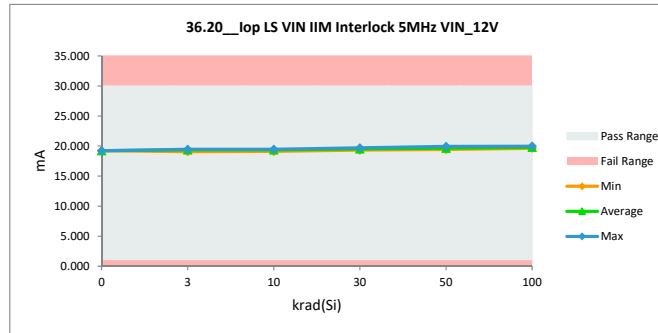

TID HDR Report
TPS7H6003-SP (5962R2220101VXC)

37.21_Top HS BOOT IIM Interlock		
Test Site	DAL-FL	DAL-FL
Tester	ETS364	ETS364
Test Number	EB672302	EB672302
Unit	mA	mA
Max Limit	15	15
Min Limit	1	1

krad(Si)	Serial #	pre_short (rtp)	(2)ST_Combos (rpt)	Delta
0	Ctrl	11.665	11.665	0.000
3	58	11.656	11.624	-0.032
3	59	11.696	11.717	0.021
3	60	11.581	11.584	0.003
3	61	11.627	11.590	-0.037
3	62	11.649	11.660	0.011
3	134	11.667	11.665	-0.002
3	137	11.770	11.668	-0.101
3	138	11.716	11.644	-0.072
3	139	11.844	11.750	-0.094
3	236	11.667	11.822	0.155
10	63	11.699	11.747	0.048
10	64	11.760	11.695	-0.066
10	65	11.666	11.680	0.014
10	66	11.651	11.609	-0.041
10	150	11.793	11.776	-0.018
10	237	11.747	11.815	0.068
10	241	11.679	11.654	-0.025
10	242	11.711	11.726	0.016
10	243	11.725	11.711	-0.014
10	244	11.712	11.612	-0.100
30	141	11.794	11.903	0.109
30	144	11.625	11.710	0.085
30	145	11.791	11.764	-0.027
30	146	11.661	11.765	0.104
30	147	11.744	11.743	-0.002
30	132	11.590	11.563	-0.028
30	133	11.755	11.778	0.023
30	135	11.722	11.551	-0.170
30	245	11.852	11.856	0.004
30	246	11.725	11.825	0.099
50	67	11.700	11.779	0.079
50	68	11.689	11.907	0.218
50	69	11.660	11.814	0.154
50	71	11.618	11.721	0.103
50	72	11.744	11.862	0.118
50	172	11.723	11.778	0.055
50	173	11.685	11.734	0.049
50	174	11.790	11.961	0.171
50	183	11.673	11.761	0.088
50	186	11.652	11.731	0.079
100	95	11.725	11.853	0.128
100	102	11.553	11.729	0.176
100	104	11.630	11.918	0.287
100	105	11.678	11.890	0.211
100	106	11.607	11.731	0.124
100	178	11.785	11.972	0.187
100	179	11.729	11.922	0.193
100	180	11.623	11.890	0.267
100	181	11.696	11.872	0.176
100	182	11.750	11.953	0.203
	Max	11.852	11.972	0.287
	Average	11.699	11.758	0.059
	Min	11.553	11.551	-0.170
	Std Dev	0.065	0.109	0.103

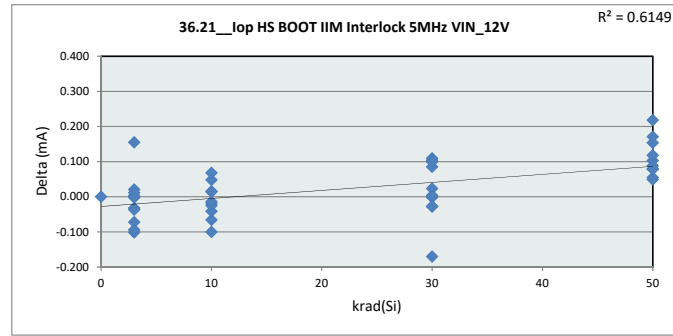

36.21_Top HS BOOT IIM Interlock 5MHz VIN_12V		
Test Site	DAL-FL	DAL-FL
Tester	ETS364	ETS364
Test Number	EB672302	EB672302
Max Limit	15	mA
Min Limit	1	mA

krad(Si)	0	3	10	30	50	100
LL	1.000	1.000	1.000	1.000	1.000	1.000
Min	11.666	11.584	11.609	11.551	11.721	11.729
Average	11.666	11.673	11.702	11.746	11.805	11.873
Max	11.666	11.822	11.815	11.904	11.961	11.972
UL	15.000	15.000	15.000	15.000	15.000	15.000

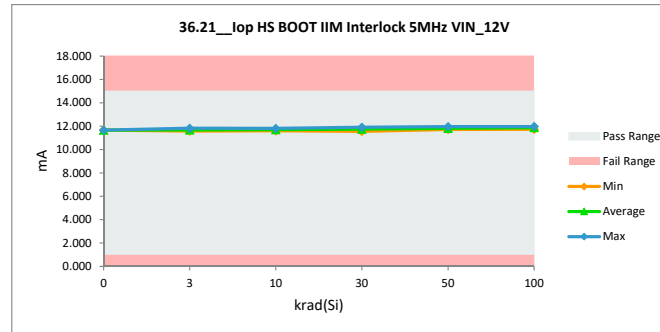

TID HDR Report
TPS7H6003-SP (5962R2220101VXC)

45.0 VOL LO VIN 10V		
Test Site	DAL-FL	DAL-FL
Tester	ETS364	ETS364
Test Number	EB672302	EB672302
Unit	V	V
Max Limit	0.15	0.15
Min Limit	0	0

krad(Si)	Serial #	pre_short (rtp)	(2)'ST_Combo (rpt)	Delta
0	Ctrl	0.068	0.068	0.000
3	58	0.068	0.068	0.000
3	59	0.068	0.067	-0.001
3	60	0.069	0.068	-0.001
3	61	0.067	0.067	-0.001
3	62	0.067	0.066	-0.001
3	134	0.068	0.068	-0.001
3	137	0.069	0.068	-0.001
3	138	0.069	0.067	-0.001
3	139	0.069	0.067	-0.001
3	236	0.068	0.068	-0.001
10	63	0.068	0.067	-0.001
10	64	0.068	0.066	-0.002
10	65	0.068	0.067	-0.001
10	66	0.068	0.067	-0.001
10	150	0.069	0.067	-0.002
10	237	0.069	0.068	-0.002
10	241	0.069	0.068	-0.002
10	242	0.070	0.068	-0.002
10	243	0.069	0.067	-0.002
10	244	0.070	0.067	-0.002
30	141	0.069	0.066	-0.002
30	144	0.068	0.066	-0.002
30	145	0.068	0.066	-0.002
30	146	0.069	0.066	-0.002
30	147	0.069	0.067	-0.003
30	132	0.069	0.067	-0.002
30	133	0.069	0.068	-0.002
30	135	0.069	0.067	-0.003
30	245	0.069	0.067	-0.002
30	246	0.069	0.067	-0.002
50	67	0.069	0.066	-0.002
50	68	0.068	0.066	-0.001
50	69	0.068	0.066	-0.002
50	71	0.068	0.066	-0.002
50	72	0.069	0.066	-0.002
50	172	0.069	0.067	-0.003
50	173	0.069	0.067	-0.002
50	174	0.068	0.066	-0.002
50	183	0.069	0.066	-0.002
50	186	0.068	0.066	-0.002
100	95	0.068	0.066	-0.002
100	102	0.068	0.065	-0.003
100	104	0.068	0.065	-0.003
100	105	0.068	0.065	-0.003
100	106	0.068	0.066	-0.003
100	178	0.069	0.066	-0.002
100	179	0.068	0.066	-0.003
100	180	0.069	0.067	-0.002
100	181	0.069	0.066	-0.002
100	182	0.069	0.066	-0.003
Max	0.070	0.068	0.000	
Average	0.069	0.067	-0.002	
Min	0.067	0.065	-0.003	
Std Dev	0.001	0.001	0.001	

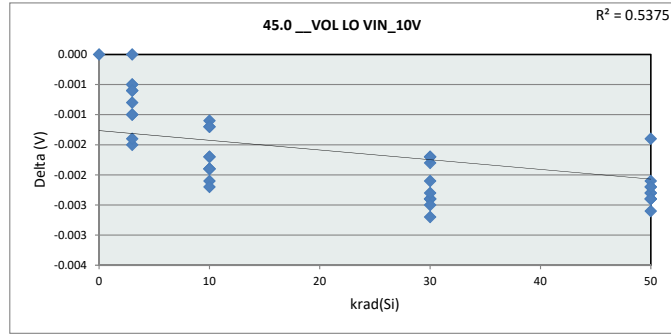

45.0 VOL LO VIN		
Test Site	DAL-FL	
Tester	ETS364	
Test Number	EB672302	
Max Limit	0.15	V
Min Limit	0	V

krad(Si)	0	3	10	30	50	100
LL	0.000	0.000	0.000	0.000	0.000	0.000
Min	0.068	0.066	0.066	0.066	0.066	0.065
Average	0.068	0.067	0.067	0.067	0.066	0.066
Max	0.068	0.068	0.068	0.068	0.067	0.067
UL	0.150	0.150	0.150	0.150	0.150	0.150

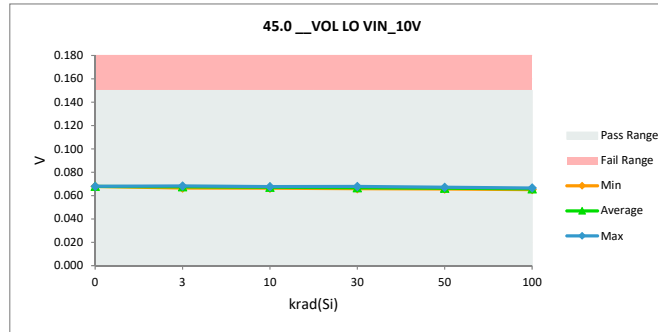

TID HDR Report
TPS7H6003-SP (5962R2220101VXC)

45.2_VOH Delta LO VIN_10V		
Test Site	DAL-FL	DAL-FL
Tester	ETS364	ETS364
Test Number	EB672302	EB672302
Unit	V	V
Max Limit	0.3	0.3
Min Limit	0	0

krad(Si)	Serial #	pre_short (rtp)	(2)'ST_Combo (rpt)	Delta
0	Ctrl	0.125	0.125	0.000
3	58	0.128	0.128	0.000
3	59	0.129	0.128	-0.001
3	60	0.125	0.125	0.000
3	61	0.128	0.128	-0.001
3	62	0.128	0.126	-0.001
3	134	0.129	0.129	0.000
3	137	0.129	0.129	0.000
3	138	0.130	0.128	-0.002
3	139	0.129	0.128	-0.002
3	236	0.128	0.128	0.000
10	63	0.129	0.128	-0.001
10	64	0.129	0.127	-0.002
10	65	0.127	0.126	-0.001
10	66	0.125	0.124	-0.001
10	150	0.130	0.128	-0.002
10	237	0.129	0.128	-0.002
10	241	0.129	0.129	0.000
10	242	0.128	0.126	-0.002
10	243	0.127	0.125	-0.002
10	244	0.129	0.127	-0.002
30	141	0.130	0.128	-0.001
30	144	0.128	0.127	-0.002
30	145	0.131	0.129	-0.002
30	146	0.129	0.127	-0.002
30	147	0.129	0.127	-0.002
30	132	0.129	0.128	-0.001
30	133	0.129	0.127	-0.001
30	135	0.128	0.126	-0.001
30	245	0.129	0.127	-0.002
30	246	0.128	0.127	-0.001
50	67	0.127	0.126	0.000
50	68	0.126	0.128	0.002
50	69	0.128	0.127	-0.001
50	71	0.128	0.128	0.000
50	72	0.126	0.125	0.000
50	172	0.130	0.127	-0.002
50	173	0.129	0.127	-0.001
50	174	0.128	0.127	-0.001
50	183	0.128	0.127	-0.001
50	186	0.130	0.128	-0.002
100	95	128.600	0.129	-128.471
100	102	126.100	0.126	-125.974
100	104	126.900	0.127	-126.773
100	105	127.600	0.127	-127.473
100	106	127.600	0.129	-127.471
100	178	0.128	0.127	-0.001
100	179	0.129	0.128	-0.001
100	180	0.129	0.129	0.000
100	181	0.128	0.128	0.000
100	182	0.127	0.126	-0.001
Max		128.600	0.129	0.002
Average		12.602	0.127	-12.475
Min		0.125	0.124	-128.471
Std Dev		38.212	0.001	38.212

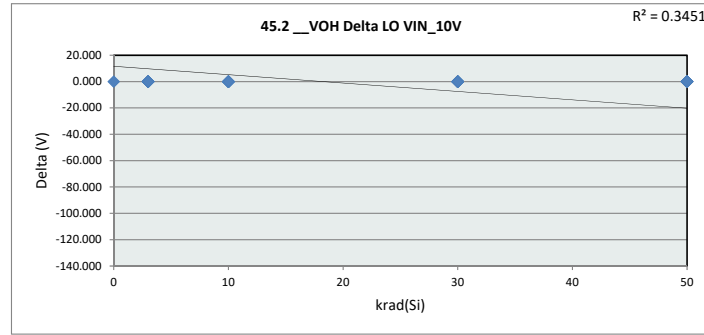

45.2_VOH Delta LO		
Test Site	DAL-FL	
Tester	ETS364	
Test Number	EB672302	
Max Limit	0.3	V
Min Limit	0	V

krad(Si)	0	3	10	30	50	100
LL	0.000	0.000	0.000	0.000	0.000	0.000
Min	0.125	0.125	0.124	0.127	0.125	0.126
Average	0.125	0.128	0.127	0.127	0.127	0.128
Max	0.125	0.129	0.129	0.129	0.129	0.129
UL	0.300	0.300	0.300	0.300	0.300	0.300

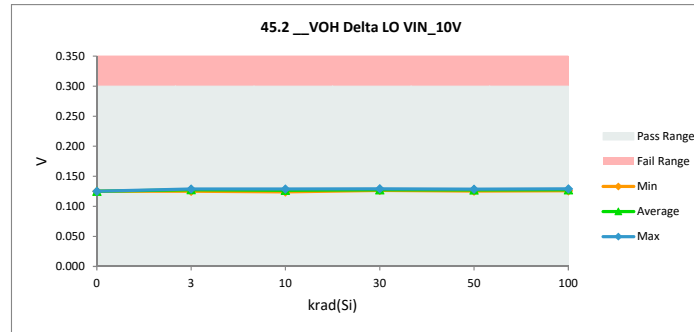

TID HDR Report
TPS7H6003-SP (5962R2220101VXC)

46.0_VOL LO VIN_12V		
Test Site	DAL-FL	DAL-FL
Tester	ETS364	ETS364
Test Number	EB672302	EB672302
Unit	V	V
Max Limit	0.15	0.15
Min Limit	0	0

krad(Si)	Serial #	pre_short (rtp)	(2)'ST_Combo (rpt)	Delta
0	Ctrl	0.068	0.068	0.000
3	58	0.068	0.068	0.000
3	59	0.068	0.067	-0.001
3	60	0.069	0.068	0.000
3	61	0.067	0.067	0.000
3	62	0.067	0.066	-0.001
3	134	0.068	0.068	-0.001
3	137	0.069	0.068	-0.001
3	138	0.069	0.067	-0.001
3	139	0.069	0.067	-0.001
3	236	0.068	0.068	-0.001
10	63	0.068	0.067	-0.001
10	64	0.068	0.066	-0.002
10	65	0.068	0.067	-0.001
10	66	0.068	0.067	-0.001
10	150	0.069	0.067	-0.002
10	237	0.069	0.068	-0.002
10	241	0.069	0.068	-0.002
10	242	0.070	0.068	-0.002
10	243	0.068	0.066	-0.002
10	244	0.069	0.067	-0.002
30	141	0.068	0.066	-0.002
30	144	0.068	0.066	-0.002
30	145	0.068	0.066	-0.002
30	146	0.069	0.066	-0.002
30	147	0.069	0.067	-0.003
30	132	0.069	0.067	-0.002
30	133	0.069	0.068	-0.002
30	135	0.069	0.067	-0.003
30	245	0.069	0.067	-0.002
30	246	0.069	0.067	-0.002
50	67	0.068	0.066	-0.002
50	68	0.068	0.066	-0.001
50	69	0.068	0.066	-0.002
50	71	0.068	0.066	-0.002
50	72	0.069	0.066	-0.002
50	172	0.069	0.067	-0.003
50	173	0.069	0.067	-0.002
50	174	0.068	0.066	-0.002
50	183	0.068	0.066	-0.002
50	186	0.068	0.066	-0.002
100	95	0.068	0.066	-0.002
100	102	0.068	0.065	-0.003
100	104	0.068	0.065	-0.003
100	105	0.068	0.065	-0.003
100	106	0.068	0.066	-0.003
100	178	0.069	0.066	-0.002
100	179	0.068	0.066	-0.002
100	180	0.069	0.066	-0.002
100	181	0.069	0.066	-0.003
100	182	0.069	0.066	-0.002
Max		0.070	0.068	0.000
Average		0.069	0.067	-0.002
Min		0.067	0.065	-0.003
Std Dev		0.001	0.001	0.001

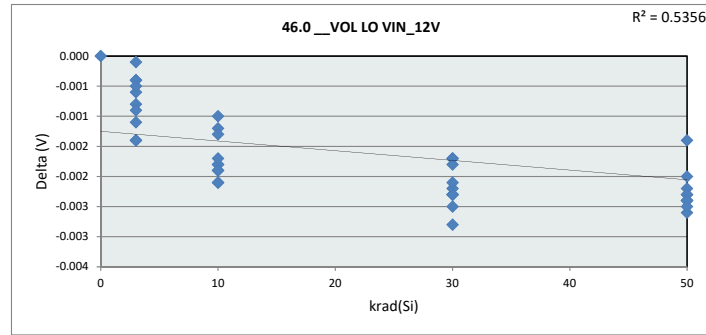

46.0_VOL LO VIN		
Test Site	DAL-FL	
Tester	ETS364	
Test Number	EB672302	
Max Limit	0.15	V
Min Limit	0	V

krad(Si)	0	3	10	30	50	100
LL	0.000	0.000	0.000	0.000	0.000	0.000
Min	0.068	0.066	0.066	0.066	0.066	0.065
Average	0.068	0.067	0.067	0.067	0.066	0.066
Max	0.068	0.068	0.068	0.068	0.067	0.066
UL	0.150	0.150	0.150	0.150	0.150	0.150

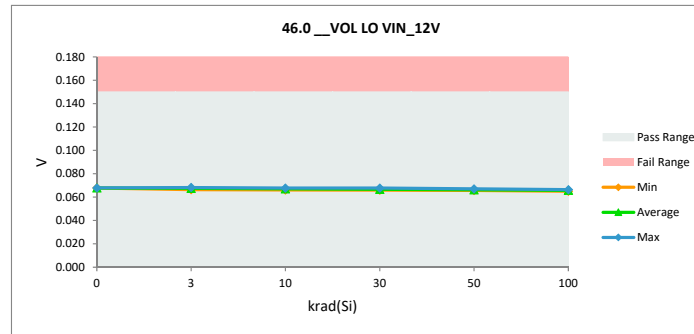

TID HDR Report
TPS7H6003-SP (5962R2220101VXC)

46.2_VOH Delta LO VIN_12V		
Test Site	DAL-FL	DAL-FL
Tester	ETS364	ETS364
Test Number	EB672302	EB672302
Unit	V	V
Max Limit	0.3	0.3
Min Limit	0	0

krad(Si)	Serial #	pre_short (rtp)	(2)'ST_Combo (rpt)	Delta
0	Ctrl	0.125	0.125	0.000
3	58	0.128	0.128	0.000
3	59	0.129	0.128	-0.001
3	60	0.125	0.125	-0.001
3	61	0.128	0.128	-0.001
3	62	0.127	0.126	-0.001
3	134	0.129	0.129	0.000
3	137	0.129	0.129	0.000
3	138	0.130	0.128	-0.002
3	139	0.129	0.127	-0.002
3	236	0.128	0.128	0.000
10	63	0.129	0.128	-0.001
10	64	0.129	0.127	-0.002
10	65	0.127	0.126	-0.001
10	66	0.125	0.124	-0.001
10	150	0.131	0.128	-0.002
10	237	0.129	0.127	-0.002
10	241	0.129	0.129	0.000
10	242	0.128	0.126	-0.002
10	243	0.127	0.125	-0.002
10	244	0.129	0.126	-0.002
30	141	0.130	0.129	-0.001
30	144	0.128	0.126	-0.002
30	145	0.131	0.129	-0.001
30	146	0.129	0.127	-0.001
30	147	0.128	0.127	-0.002
30	132	0.129	0.127	-0.001
30	133	0.129	0.127	-0.001
30	135	0.127	0.126	-0.001
30	245	0.129	0.127	-0.002
30	246	0.128	0.127	-0.001
50	67	0.127	0.127	0.000
50	68	0.126	0.128	0.002
50	69	0.128	0.127	-0.001
50	71	0.128	0.128	0.000
50	72	0.126	0.125	0.000
50	172	0.130	0.127	-0.002
50	173	0.129	0.128	-0.001
50	174	0.128	0.127	-0.001
50	183	0.128	0.127	-0.001
50	186	0.130	0.128	-0.002
100	95	128.500	0.129	-128.371
100	102	125.900	0.126	-125.774
100	104	127.000	0.127	-126.873
100	105	127.700	0.127	-127.573
100	106	127.600	0.129	-127.471
100	178	0.127	0.127	-0.001
100	179	0.129	0.128	-0.001
100	180	0.129	0.129	0.000
100	181	0.128	0.127	-0.001
100	182	0.127	0.126	-0.001
Max		128.500	0.129	0.002
Average		12.600	0.127	-12.473
Min		0.125	0.124	-128.371
Std Dev		38.206	0.001	38.206

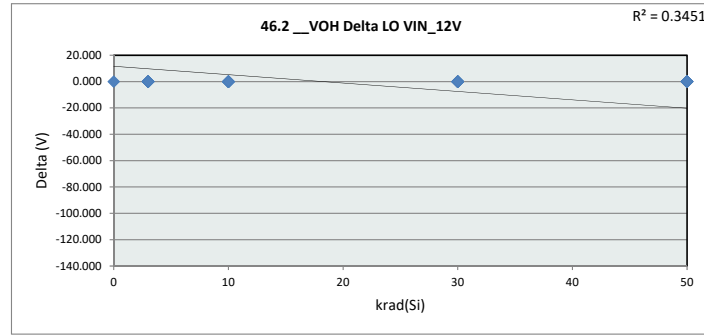

46.2_VOH Delta LO		
Test Site	DAL-FL	
Tester	ETS364	
Test Number	EB672302	
Max Limit	0.3	V
Min Limit	0	V

krad(Si)	0	3	10	30	50	100
LL	0.000	0.000	0.000	0.000	0.000	0.000
Min	0.125	0.125	0.124	0.126	0.126	0.126
Average	0.125	0.128	0.127	0.127	0.127	0.127
Max	0.125	0.129	0.129	0.129	0.128	0.129
UL	0.300	0.300	0.300	0.300	0.300	0.300

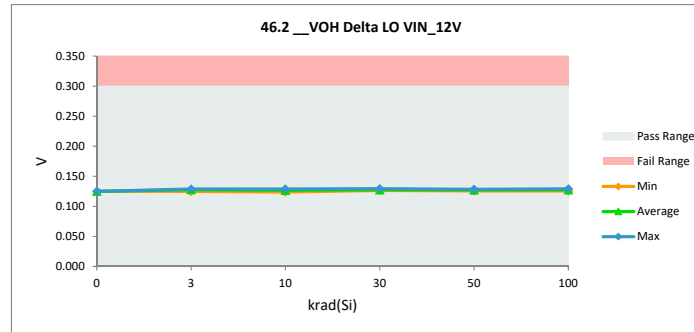

TID HDR Report
TPS7H6003-SP (5962R2220101VXC)

47.0_VOL LO VIN_14V		
Test Site	DAL-FL	DAL-FL
Tester	ETS364	ETS364
Test Number	EB672302	EB672302
Unit	V	V
Max Limit	0.15	0.15
Min Limit	0	0

krad(Si)	Serial #	pre_short (rtp)	(2)'ST_Combo (rpt) (Delta
0	Ctrl	0.068	0.068	0.000
3	58	0.068	0.067	0.000
3	59	0.068	0.067	-0.001
3	60	0.069	0.068	0.000
3	61	0.067	0.067	-0.001
3	62	0.067	0.066	-0.001
3	134	0.068	0.068	-0.001
3	137	0.069	0.068	-0.001
3	138	0.069	0.067	-0.001
3	139	0.069	0.067	-0.002
3	236	0.068	0.068	-0.001
10	63	0.068	0.067	-0.001
10	64	0.068	0.066	-0.002
10	65	0.068	0.067	-0.001
10	66	0.068	0.067	-0.001
10	150	0.069	0.067	-0.002
10	237	0.069	0.068	-0.002
10	241	0.069	0.068	-0.002
10	242	0.070	0.068	-0.002
10	243	0.068	0.066	-0.002
10	244	0.069	0.067	-0.002
30	141	0.068	0.066	-0.002
30	144	0.068	0.066	-0.002
30	145	0.068	0.066	-0.002
30	146	0.069	0.066	-0.002
30	147	0.069	0.067	-0.003
30	132	0.069	0.067	-0.002
30	133	0.069	0.068	-0.002
30	135	0.069	0.067	-0.003
30	245	0.069	0.067	-0.002
30	246	0.069	0.067	-0.002
50	67	0.068	0.066	-0.002
50	68	0.068	0.066	-0.001
50	69	0.068	0.066	-0.002
50	71	0.068	0.066	-0.002
50	72	0.069	0.066	-0.002
50	172	0.069	0.067	-0.003
50	173	0.069	0.067	-0.002
50	174	0.068	0.066	-0.002
50	183	0.069	0.066	-0.002
50	186	0.068	0.066	-0.002
100	95	0.068	0.066	-0.002
100	102	0.068	0.065	-0.003
100	104	0.068	0.065	-0.003
100	105	0.068	0.065	-0.003
100	106	0.068	0.066	-0.003
100	178	0.069	0.066	-0.002
100	179	0.068	0.066	-0.003
100	180	0.069	0.067	-0.002
100	181	0.069	0.066	-0.003
100	182	0.069	0.066	-0.003
Max	0.070	0.068	0.000	
Average	0.069	0.067	-0.002	
Min	0.067	0.065	-0.003	
Std Dev	0.001	0.001	0.001	

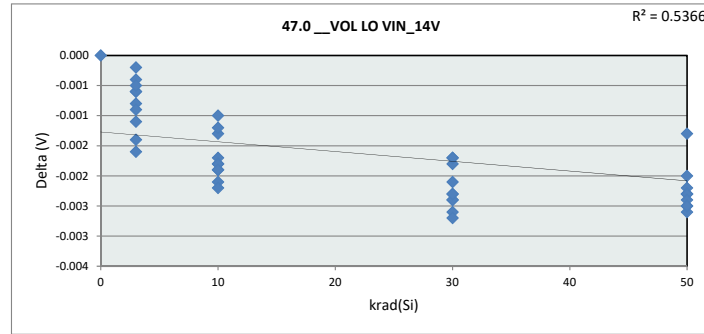

47.0_VOL LO VIN		
Test Site	DAL-FL	
Tester	ETS364	
Test Number	EB672302	
Max Limit	0.15	V
Min Limit	0	V

krad(Si)	0	3	10	30	50	100
LL	0.000	0.000	0.000	0.000	0.000	0.000
Min	0.068	0.066	0.066	0.066	0.066	0.065
Average	0.068	0.067	0.067	0.067	0.066	0.066
Max	0.068	0.068	0.068	0.068	0.067	0.067
UL	0.150	0.150	0.150	0.150	0.150	0.150

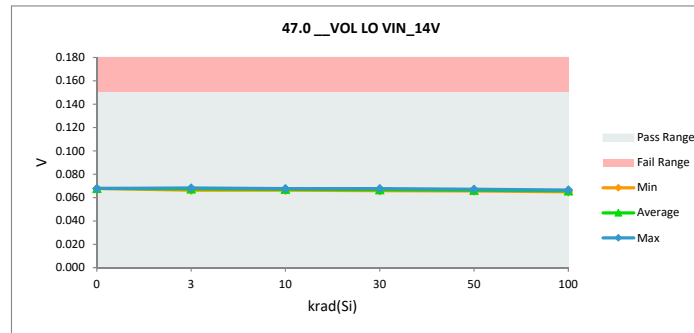

TID HDR Report
TPS7H6003-SP (5962R2220101VXC)

47.2_VOH Delta LO VIN_14V		
Test Site	DAL-FL	DAL-FL
Tester	ETS364	ETS364
Test Number	EB672302	EB672302
Unit	V	V
Max Limit	0.3	0.3
Min Limit	0	0

krad(Si)	Serial #	pre_short (rtp)	(2)'ST_Combo (rpt)	Delta
0	Ctrl	0.125	0.125	0.000
3	58	0.128	0.128	0.000
3	59	0.129	0.128	-0.001
3	60	0.125	0.125	0.000
3	61	0.128	0.127	-0.001
3	62	0.127	0.126	-0.001
3	134	0.129	0.129	0.000
3	137	0.129	0.129	0.000
3	138	0.130	0.128	-0.002
3	139	0.129	0.127	-0.002
3	236	0.128	0.128	0.000
10	63	0.129	0.128	-0.001
10	64	0.129	0.127	-0.002
10	65	0.127	0.126	-0.001
10	66	0.125	0.124	-0.001
10	150	0.131	0.128	-0.002
10	237	0.129	0.127	-0.002
10	241	0.129	0.128	0.000
10	242	0.128	0.126	-0.002
10	243	0.127	0.125	-0.002
10	244	0.129	0.126	-0.002
30	141	0.130	0.129	-0.001
30	144	0.128	0.127	-0.002
30	145	0.131	0.129	-0.002
30	146	0.129	0.127	-0.001
30	147	0.129	0.127	-0.002
30	132	0.129	0.128	-0.001
30	133	0.129	0.127	-0.002
30	135	0.127	0.126	-0.001
30	245	0.128	0.127	-0.001
30	246	0.128	0.127	-0.001
50	67	0.127	0.126	0.000
50	68	0.126	0.128	0.002
50	69	0.128	0.127	-0.001
50	71	0.128	0.128	0.000
50	72	0.126	0.125	0.000
50	172	0.130	0.127	-0.002
50	173	0.128	0.128	-0.001
50	174	0.128	0.127	-0.001
50	183	0.128	0.127	-0.001
50	186	0.130	0.128	-0.002
100	95	0.129	0.129	0.000
100	102	0.126	0.126	0.000
100	104	0.127	0.127	0.000
100	105	0.128	0.127	0.000
100	106	0.127	0.129	0.001
100	178	0.128	0.127	-0.001
100	179	0.129	0.128	-0.001
100	180	0.129	0.129	0.001
100	181	0.128	0.128	-0.001
100	182	0.127	0.126	-0.001
Max		0.131	0.129	0.002
Average		0.128	0.127	-0.001
Min		0.125	0.124	-0.002
Std Dev		0.001	0.001	0.001

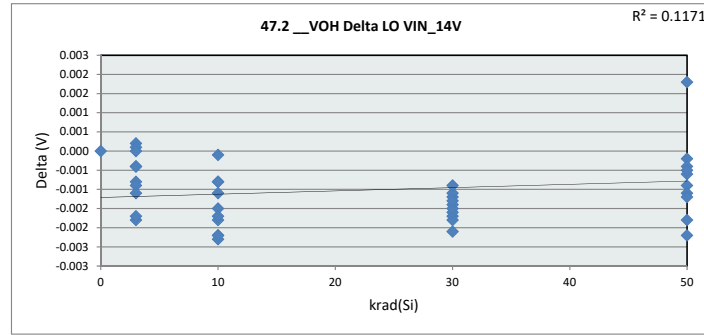

47.2_VOH Delta LO VIN_14V

47.2_VOH Delta LO VIN_14V		
Test Site	DAL-FL	DAL-FL
Tester	ETS364	ETS364
Test Number	EB672302	EB672302
Max Limit	0.3	V
Min Limit	0	V

krad(Si)	0	3	10	30	50	100
LL	0.000	0.000	0.000	0.000	0.000	0.000
Min	0.125	0.125	0.124	0.127	0.125	0.126
Average	0.125	0.128	0.127	0.127	0.127	0.128
Max	0.125	0.129	0.129	0.129	0.128	0.129
UL	0.300	0.300	0.300	0.300	0.300	0.300

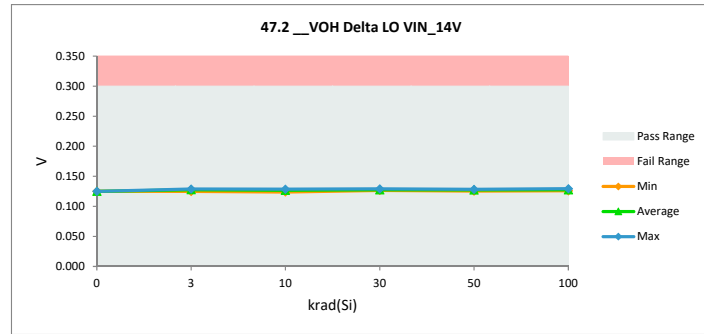

TID HDR Report
TPS7H6003-SP (5962R2220101VXC)

50.0 IOH LO VIN 10V		
Test Site	DAL-FL	DAL-FL
Tester	ETS364	ETS364
Test Number	EB672302	EB672302
Unit	A	A
Max Limit	2.3	2.3
Min Limit	0.7	0.7

krad(Si)	Serial #	pre_short (rtp)	(2)ST_Combo (rpt)	Delta
0	Ctrl	1.278	1.278	0.000
3	58	1.265	1.263	-0.002
3	59	1.257	1.260	0.003
3	60	1.286	1.287	0.001
3	61	1.261	1.262	0.001
3	62	1.269	1.272	0.003
3	134	1.263	1.253	-0.010
3	137	1.263	1.253	-0.010
3	138	1.247	1.255	0.008
3	139	1.254	1.259	0.005
3	236	1.270	1.269	-0.001
10	63	1.250	1.250	0.000
10	64	1.258	1.263	0.005
10	65	1.274	1.275	0.001
10	66	1.292	1.294	0.002
10	150	1.243	1.250	0.007
10	237	1.260	1.271	0.011
10	241	1.264	1.253	-0.011
10	242	1.275	1.279	0.004
10	243	1.279	1.287	0.008
10	244	1.259	1.265	0.007
30	141	1.251	1.249	-0.002
30	144	1.263	1.260	-0.002
30	145	1.239	1.238	-0.002
30	146	1.263	1.262	-0.002
30	147	1.262	1.263	0.001
30	132	1.259	1.257	-0.002
30	133	1.260	1.258	-0.003
30	135	1.273	1.269	-0.003
30	245	1.265	1.264	-0.001
30	246	1.262	1.259	-0.002
50	67	1.279	1.269	-0.010
50	68	1.284	1.239	-0.045
50	69	1.266	1.256	-0.010
50	71	1.268	1.256	-0.012
50	72	1.281	1.270	-0.011
50	172	1.250	1.249	-0.001
50	173	1.271	1.267	-0.003
50	174	1.260	1.256	-0.003
50	183	1.261	1.258	-0.003
50	186	1.253	1.251	-0.002
100	95	1.260	1.236	-0.024
100	102	1.280	1.260	-0.020
100	104	1.276	1.255	-0.021
100	105	1.268	1.244	-0.024
100	106	1.269	1.248	-0.022
100	178	1.272	1.259	-0.013
100	179	1.264	1.253	-0.011
100	180	1.258	1.246	-0.013
100	181	1.266	1.253	-0.013
100	182	1.274	1.262	-0.012
Max		1.292	1.294	0.011
Average		1.265	1.260	-0.005
Min		1.239	1.236	-0.045
Std Dev		0.011	0.012	0.010

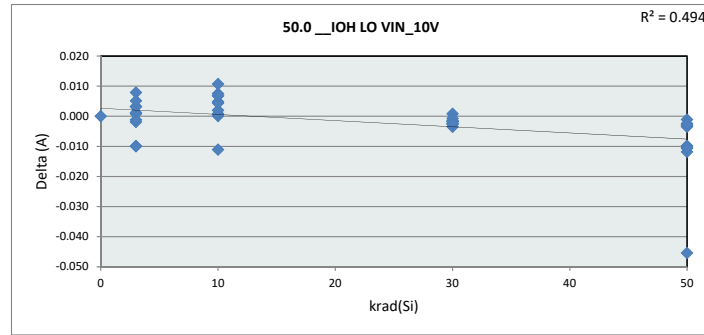

50.0 IOH LO VIN		
Test Site	DAL-FL	
Tester	ETS364	
Test Number	EB672302	
Max Limit	2.3	A
Min Limit	0.7	A

krad(Si)	0	3	10	30	50	100
LL	0.700	0.700	0.700	0.700	0.700	0.700
Min	1.278	1.253	1.250	1.238	1.239	1.236
Average	1.278	1.263	1.269	1.258	1.257	1.252
Max	1.278	1.287	1.294	1.269	1.270	1.262
UL	2.300	2.300	2.300	2.300	2.300	2.300

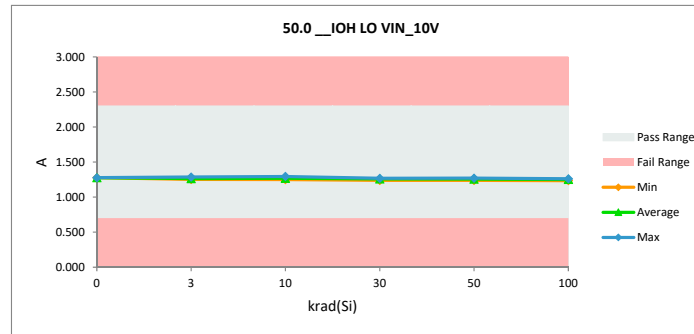

TID HDR Report TPS7H6003-SP (5962R2220101VXC)

50.1 IOH HO VIN_10V		
Test Site	DAL-FL	DAL-FL
Tester	ETS364	ETS364
Test Number	EB672302	EB672302
Unit	A	A
Max Limit	2.3	2.3
Min Limit	0.7	0.7

krad(Si)	Serial #	pre_short (rtp)	(2)ST_Combo (rpt)	Delta
0	Ctrl	1.276	1.276	0.000
3	58	1.269	1.265	-0.003
3	59	1.256	1.258	0.002
3	60	1.284	1.282	-0.001
3	61	1.263	1.263	0.000
3	62	1.266	1.268	0.003
3	134	1.266	1.247	-0.019
3	137	1.262	1.247	-0.015
3	138	1.252	1.249	-0.003
3	139	1.250	1.255	0.005
3	236	1.277	1.259	-0.018
10	63	1.250	1.250	0.000
10	64	1.255	1.258	0.003
10	65	1.270	1.270	0.000
10	66	1.286	1.286	0.000
10	150	1.253	1.257	0.005
10	237	1.257	1.260	0.003
10	241	1.265	1.248	-0.017
10	242	1.275	1.276	0.001
10	243	1.289	1.293	0.004
10	244	1.262	1.266	0.005
30	141	1.250	1.247	-0.003
30	144	1.264	1.262	-0.002
30	145	1.243	1.240	-0.003
30	146	1.268	1.266	-0.002
30	147	1.257	1.255	-0.002
30	132	1.261	1.255	-0.005
30	133	1.259	1.253	-0.006
30	135	1.267	1.264	-0.004
30	245	1.256	1.252	-0.004
30	246	1.259	1.254	-0.005
50	67	1.273	1.261	-0.012
50	68	1.290	1.241	-0.049
50	69	1.269	1.259	-0.011
50	71	1.269	1.257	-0.012
50	72	1.278	1.267	-0.012
50	172	1.250	1.237	-0.012
50	173	1.267	1.253	-0.014
50	174	1.255	1.242	-0.013
50	183	1.263	1.252	-0.012
50	186	1.257	1.244	-0.012
100	95	1.253	1.230	-0.023
100	102	1.289	1.266	-0.023
100	104	1.274	1.252	-0.022
100	105	1.270	1.245	-0.025
100	106	1.269	1.245	-0.023
100	178	1.274	1.246	-0.028
100	179	1.264	1.238	-0.026
100	180	1.260	1.233	-0.026
100	181	1.267	1.239	-0.028
100	182	1.278	1.250	-0.028
Max		1.290	1.293	0.005
Average		1.265	1.256	-0.010
Min		1.243	1.230	-0.049
Std Dev		0.011	0.013	0.012

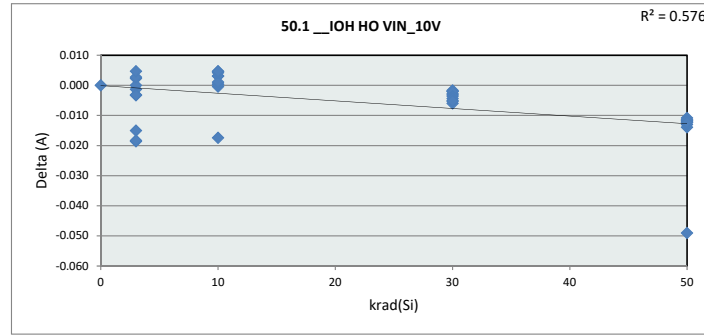

50.1 IOH HO VIN		
Test Site	DAL-FL	
Tester	ETS364	
Test Number	EB672302	
Max Limit	2.3	A
Min Limit	0.7	A

krad(Si)	0	3	10	30	50	100
LL	0.700	0.700	0.700	0.700	0.700	0.700
Min	1.276	1.247	1.248	1.240	1.237	1.230
Average	1.276	1.259	1.266	1.255	1.251	1.244
Max	1.276	1.282	1.293	1.266	1.267	1.266
UL	2.300	2.300	2.300	2.300	2.300	2.300

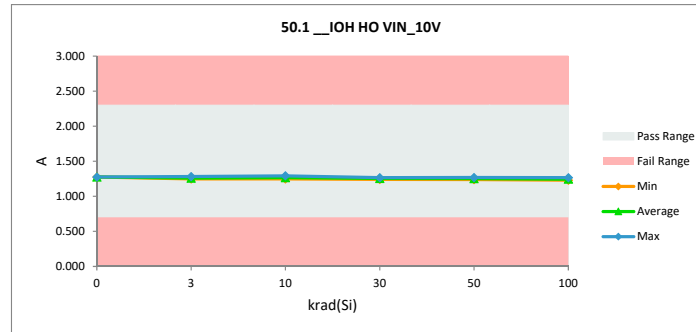

TID Report

TPS7H6003-SP (5962R2220101VXC)

50.2_IOL LO VIN_10V		
Test Site	DAL-FL	DAL-FL
Tester	ETS364	ETS364
Test Number	EB672302	EB672302
Unit	A	A
Max Limit	4.6	4.6
Min Limit	1.6	1.6

krad(Si)	Serial #	pre_short (rtp) (2)	ST_Combo (rpt) (Delta
0	248	2.508	2.508	0.000
3	58	2.564	2.571	0.007
3	59	2.533	2.550	0.017
3	60	2.528	2.538	0.010
3	61	2.569	2.579	0.010
3	62	2.562	2.584	0.022
3	134	2.539	2.532	-0.007
3	137	2.519	2.530	0.012
3	138	2.513	2.537	0.023
3	139	2.526	2.555	0.028
3	236	2.541	2.554	0.013
10	63	2.519	2.544	0.024
10	64	2.532	2.571	0.040
10	65	2.534	2.564	0.030
10	66	2.545	2.576	0.031
10	150	2.517	2.562	0.045
10	237	2.521	2.559	0.038
10	241	2.524	2.533	0.009
10	242	2.528	2.568	0.040
10	243	2.539	2.586	0.046
10	244	2.511	2.555	0.045
30	141	2.545	2.608	0.063
30	144	2.534	2.595	0.061
30	145	2.534	2.601	0.067
30	146	2.530	2.597	0.066
30	147	2.526	2.593	0.067
30	132	2.514	2.567	0.053
30	133	2.496	2.545	0.049
30	135	2.532	2.572	0.040
30	245	2.535	2.590	0.055
30	246	2.529	2.581	0.052
50	67	2.532	2.608	0.076
50	68	2.572	2.601	0.030
50	69	2.532	2.609	0.076
50	71	2.563	2.631	0.068
50	72	2.541	2.617	0.076
50	172	2.506	2.583	0.077
50	173	2.538	2.608	0.070
50	174	2.534	2.606	0.072
50	183	2.540	2.613	0.073
50	186	2.537	2.616	0.080
100	95	2533.200	2.644	-2530.556
100	102	2554.500	2.681	-2551.819
100	104	2562.400	2.684	-2559.716
100	105	2549.400	2.666	-2546.734
100	106	2551.000	2.665	-2548.335
100	178	2.534	2.632	0.098
100	179	2.542	2.646	0.104
100	180	2.520	2.620	0.100
100	181	2.517	2.619	0.102
100	182	2.546	2.649	0.104
Max		2562.400	2.684	0.104
Average		252.294	2.590	-249.704
Min		2.496	2.508	-2559.716
Std Dev		765.108	0.041	765.082

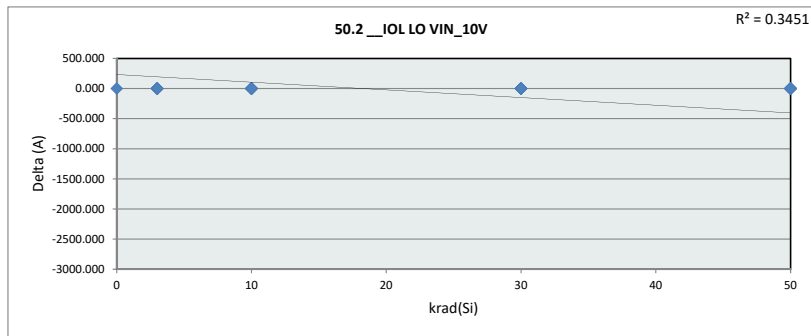

50.2_IOL LO VIN_10V		
Test Site	DAL-FL	
Tester	ETS364	
Test Number	EB672302	
Max Limit	4.6	A
Min Limit	1.6	A

krad(Si)	0	3	10	30	50	100
LL	1.600	1.600	1.600	1.600	1.600	1.600
Min	2.508	2.530	2.533	2.545	2.583	2.619
Average	2.508	2.553	2.562	2.585	2.609	2.651
Max	2.508	2.584	2.586	2.608	2.631	2.684
UL	4.600	4.600	4.600	4.600	4.600	4.600

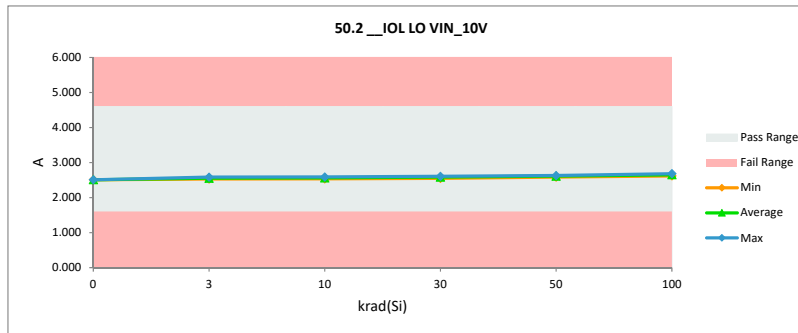

TID HDR Report
TPS7H6003-SP (5962R2220101VXC)

51.0_IQH LO VIN_12V		
Test Site	DAL-FL	DAL-FL
Tester	ETS364	ETS364
Test Number	EB672302	EB672302
Unit	A	A
Max Limit	2.3	2.3
Min Limit	0.7	0.7

krad(Si)	Serial #	pre_short (rtp)	(2)ST_Combo (rpt)	Delta
0	Ctrl	1.278	1.278	0.000
3	58	1.265	1.263	-0.002
3	59	1.257	1.260	0.003
3	60	1.286	1.287	0.000
3	61	1.261	1.262	0.001
3	62	1.269	1.273	0.004
3	134	1.263	1.253	-0.010
3	137	1.263	1.253	-0.010
3	138	1.247	1.255	0.008
3	139	1.254	1.259	0.005
3	236	1.271	1.269	-0.002
10	63	1.250	1.250	0.000
10	64	1.258	1.263	0.005
10	65	1.275	1.275	0.001
10	66	1.292	1.295	0.002
10	150	1.244	1.250	0.007
10	237	1.260	1.271	0.011
10	241	1.264	1.254	-0.011
10	242	1.275	1.280	0.005
10	243	1.280	1.286	0.007
10	244	1.259	1.266	0.007
30	141	1.251	1.249	-0.002
30	144	1.262	1.260	-0.002
30	145	1.239	1.238	-0.001
30	146	1.263	1.262	-0.001
30	147	1.263	1.263	0.000
30	132	1.259	1.257	-0.002
30	133	1.260	1.258	-0.002
30	135	1.273	1.269	-0.003
30	245	1.265	1.264	-0.001
30	246	1.261	1.260	-0.002
50	67	1.279	1.269	-0.010
50	68	1.284	1.239	-0.045
50	69	1.266	1.256	-0.010
50	71	1.268	1.256	-0.012
50	72	1.281	1.270	-0.011
50	172	1.250	1.249	-0.001
50	173	1.271	1.267	-0.004
50	174	1.260	1.256	-0.004
50	183	1.262	1.258	-0.003
50	186	1.254	1.250	-0.003
100	95	1.259	1.236	-0.023
100	102	1.280	1.260	-0.020
100	104	1.276	1.256	-0.021
100	105	1.268	1.244	-0.024
100	106	1.269	1.247	-0.022
100	178	1.272	1.258	-0.014
100	179	1.264	1.253	-0.011
100	180	1.258	1.246	-0.013
100	181	1.266	1.253	-0.013
100	182	1.274	1.262	-0.012
Max		1.292	1.295	0.011
Average		1.265	1.260	-0.005
Min		1.239	1.236	-0.045
Std Dev		0.011	0.012	0.010

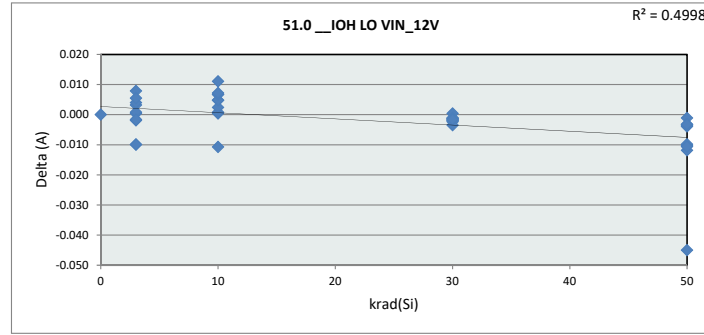

51.0_IQH LO VIN		
Test Site	DAL-FL	
Tester	ETS364	
Test Number	EB672302	
Max Limit	2.3	A
Min Limit	0.7	A

krad(Si)	0	3	10	30	50	100
LL	0.700	0.700	0.700	0.700	0.700	0.700
Min	1.278	1.253	1.250	1.238	1.239	1.236
Average	1.278	1.263	1.269	1.258	1.257	1.252
Max	1.278	1.287	1.295	1.269	1.270	1.262
UL	2.300	2.300	2.300	2.300	2.300	2.300

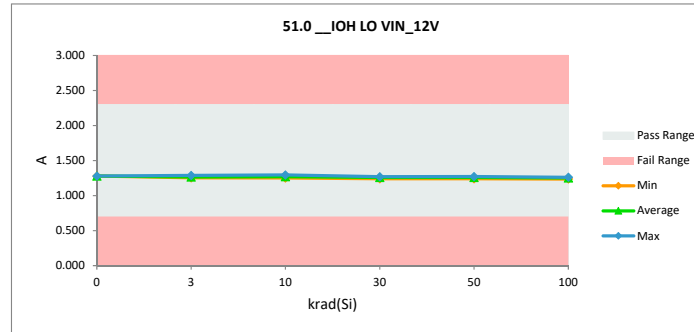

TID HDR Report
TPS7H6003-SP (5962R2220101VXC)

51.1 IOH HO VIN 12V		
Test Site	DAL-FL	DAL-FL
Tester	ETS364	ETS364
Test Number	EB672302	EB672302
Unit	A	A
Max Limit	2.3	2.3
Min Limit	0.7	0.7

krad(Si)	Serial #	pre_short (rtp)	(2)ST_Combo (rpt)	Delta
0	Ctrl	1.275	1.275	0.000
3	58	1.269	1.265	-0.004
3	59	1.256	1.259	0.003
3	60	1.284	1.283	-0.001
3	61	1.263	1.263	0.000
3	62	1.266	1.268	0.002
3	134	1.266	1.247	-0.019
3	137	1.262	1.246	-0.015
3	138	1.252	1.249	-0.004
3	139	1.250	1.255	0.005
3	236	1.276	1.259	-0.018
10	63	1.250	1.250	-0.001
10	64	1.255	1.258	0.003
10	65	1.270	1.270	0.000
10	66	1.286	1.286	0.000
10	150	1.253	1.258	0.005
10	237	1.256	1.260	0.004
10	241	1.265	1.247	-0.018
10	242	1.275	1.276	0.001
10	243	1.289	1.293	0.004
10	244	1.262	1.266	0.004
30	141	1.250	1.247	-0.003
30	144	1.265	1.262	-0.002
30	145	1.243	1.240	-0.003
30	146	1.268	1.266	-0.003
30	147	1.257	1.255	-0.002
30	132	1.261	1.255	-0.005
30	133	1.259	1.253	-0.006
30	135	1.267	1.264	-0.004
30	245	1.257	1.252	-0.005
30	246	1.260	1.253	-0.006
50	67	1.273	1.261	-0.012
50	68	1.290	1.241	-0.049
50	69	1.269	1.259	-0.011
50	71	1.270	1.257	-0.012
50	72	1.278	1.267	-0.011
50	172	1.249	1.237	-0.012
50	173	1.266	1.252	-0.014
50	174	1.255	1.242	-0.013
50	183	1.263	1.252	-0.012
50	186	1.256	1.244	-0.012
100	95	1.253	1.230	-0.023
100	102	1.289	1.266	-0.023
100	104	1.274	1.252	-0.022
100	105	1.270	1.245	-0.025
100	106	1.268	1.245	-0.023
100	178	1.274	1.246	-0.028
100	179	1.264	1.238	-0.026
100	180	1.260	1.233	-0.027
100	181	1.267	1.239	-0.028
100	182	1.278	1.250	-0.028
Max		1.290	1.293	0.005
Average		1.265	1.256	-0.010
Min		1.243	1.230	-0.049
Std Dev		0.011	0.013	0.012

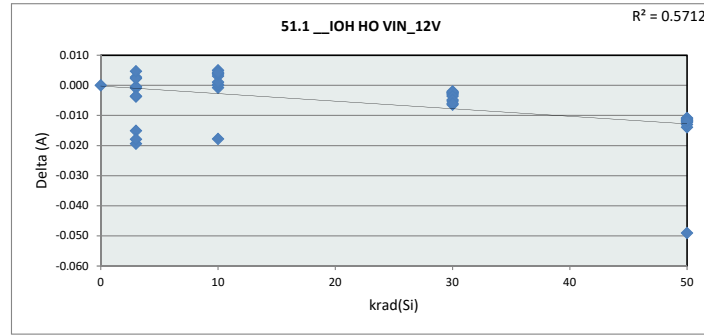

51.1 IOH HO VIN		
Test Site	DAL-FL	
Tester	ETS364	
Test Number	EB672302	
Max Limit	2.3	A
Min Limit	0.7	A

krad(Si)	0	3	10	30	50	100
LL	0.700	0.700	0.700	0.700	0.700	0.700
Min	1.275	1.246	1.247	1.240	1.237	1.230
Average	1.275	1.259	1.266	1.255	1.251	1.244
Max	1.275	1.283	1.293	1.266	1.267	1.266
UL	2.300	2.300	2.300	2.300	2.300	2.300

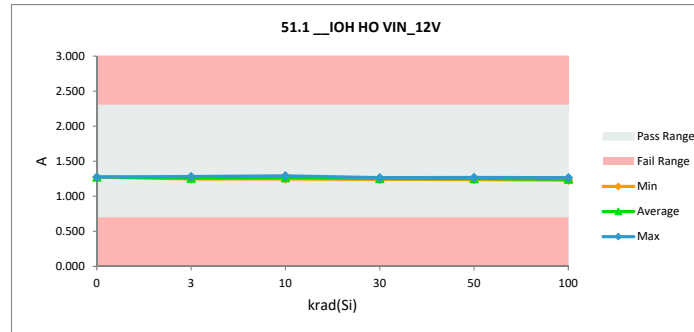

TID Report

TPS7H6003-SP (5962R2220101VXC)

51.2_IOL LO VIN_12V		
Test Site	DAL-FL	DAL-FL
Tester	ETS364	ETS364
Test Number	EB672302	EB672302
Unit	A	A
Max Limit	4.6	4.6
Min Limit	1.6	1.6

krad(Si)	Serial #	pre_short (rtp) (2)	ST_Combo (rpt) (Delta
0	248	2.509	2.509	0.000
3	58	2.564	2.571	0.007
3	59	2.533	2.549	0.016
3	60	2.526	2.538	0.012
3	61	2.566	2.578	0.012
3	62	2.564	2.584	0.020
3	134	2.537	2.532	-0.006
3	137	2.516	2.530	0.014
3	138	2.511	2.537	0.026
3	139	2.529	2.554	0.025
3	236	2.541	2.554	0.013
10	63	2.517	2.543	0.027
10	64	2.531	2.571	0.040
10	65	2.534	2.564	0.030
10	66	2.546	2.576	0.030
10	150	2.517	2.562	0.044
10	237	2.521	2.559	0.037
10	241	2.525	2.533	0.008
10	242	2.529	2.568	0.038
10	243	2.542	2.585	0.043
10	244	2.508	2.554	0.046
30	141	2.544	2.608	0.064
30	144	2.531	2.595	0.064
30	145	2.537	2.600	0.063
30	146	2.533	2.596	0.063
30	147	2.524	2.593	0.069
30	132	2.516	2.566	0.050
30	133	2.492	2.545	0.053
30	135	2.529	2.571	0.042
30	245	2.534	2.589	0.056
30	246	2.525	2.580	0.055
50	67	2.530	2.607	0.077
50	68	2.572	2.601	0.029
50	69	2.532	2.609	0.077
50	71	2.560	2.630	0.070
50	72	2.538	2.616	0.079
50	172	2.509	2.583	0.074
50	173	2.536	2.608	0.072
50	174	2.535	2.606	0.071
50	183	2.540	2.613	0.073
50	186	2.541	2.616	0.075
100	95	2533.200	2.643	-2530.557
100	102	2556.100	2.680	-2553.420
100	104	2565.200	2.682	-2562.517
100	105	2550.200	2.666	-2547.534
100	106	2550.200	2.665	-2547.535
100	178	2.533	2.632	0.099
100	179	2.542	2.646	0.103
100	180	2.519	2.619	0.100
100	181	2.516	2.618	0.102
100	182	2.544	2.649	0.105
Max		2565.200	2.682	0.105
Average		252.380	2.590	-249.790
Min		2.492	2.509	-2562.517
Std Dev		765.374	0.041	765.348

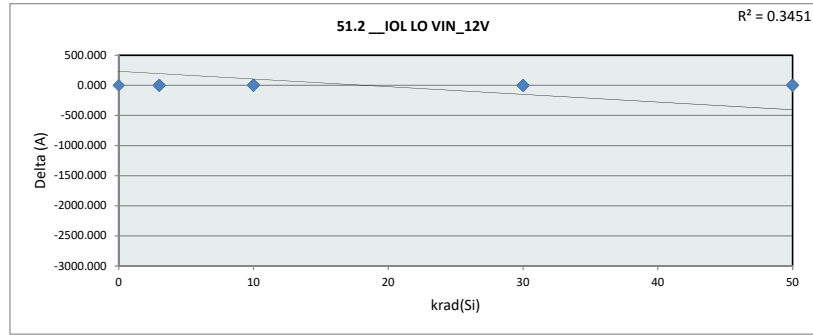

51.2_IOL LO VIN_12V		
Test Site	DAL-FL	
Tester	ETS364	
Test Number	EB672302	
Max Limit	4.6	A
Min Limit	1.6	A

krad(Si)	0	3	10	30	50	100
LL	1.600	1.600	1.600	1.600	1.600	1.600
Min	2.509	2.530	2.533	2.545	2.583	2.618
Average	2.509	2.553	2.562	2.584	2.609	2.650
Max	2.509	2.584	2.585	2.608	2.630	2.683
UL	4.600	4.600	4.600	4.600	4.600	4.600

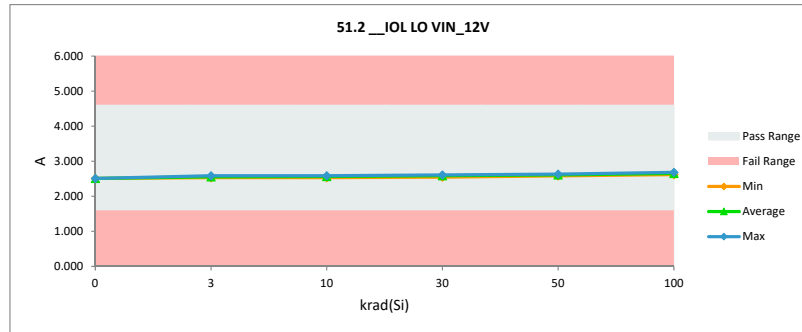

TID HDR Report

TPS7H6003-SP (5962R2220101VXC)

52.0 IOH LO VIN 14V		
Test Site	DAL-FL	DAL-FL
Tester	ETS364	ETS364
Test Number	EB672302	EB672302
Unit	A	A
Max Limit	2.3	2.3
Min Limit	0.7	0.7

krad(Si)	Serial #	pre_short (rtp)	(2)ST_Combo (rpt)	Delta
0	Ctrl	1.278	1.278	0.000
3	58	1.265	1.263	-0.002
3	59	1.257	1.260	0.003
3	60	1.286	1.287	0.000
3	61	1.261	1.262	0.001
3	62	1.269	1.273	0.003
3	134	1.263	1.253	-0.010
3	137	1.263	1.252	-0.010
3	138	1.247	1.255	0.007
3	139	1.253	1.259	0.006
3	236	1.271	1.269	-0.002
10	63	1.250	1.250	0.000
10	64	1.258	1.263	0.005
10	65	1.275	1.275	0.001
10	66	1.292	1.295	0.002
10	150	1.243	1.250	0.007
10	237	1.260	1.271	0.011
10	241	1.264	1.254	-0.011
10	242	1.275	1.279	0.004
10	243	1.279	1.287	0.008
10	244	1.258	1.266	0.008
30	141	1.251	1.250	-0.002
30	144	1.262	1.260	-0.002
30	145	1.239	1.238	-0.002
30	146	1.263	1.262	-0.002
30	147	1.263	1.263	0.000
30	132	1.259	1.257	-0.002
30	133	1.261	1.258	-0.003
30	135	1.272	1.269	-0.004
30	245	1.265	1.264	-0.001
30	246	1.262	1.260	-0.002
50	67	1.279	1.269	-0.011
50	68	1.284	1.239	-0.045
50	69	1.266	1.256	-0.010
50	71	1.268	1.256	-0.012
50	72	1.280	1.270	-0.010
50	172	1.250	1.249	-0.001
50	173	1.271	1.268	-0.003
50	174	1.260	1.256	-0.004
50	183	1.262	1.258	-0.003
50	186	1.254	1.251	-0.003
100	95	1.259	1.236	-0.023
100	102	1.280	1.260	-0.020
100	104	1.276	1.256	-0.021
100	105	1.268	1.245	-0.024
100	106	1.270	1.248	-0.022
100	178	1.272	1.259	-0.013
100	179	1.264	1.253	-0.011
100	180	1.258	1.246	-0.013
100	181	1.266	1.253	-0.013
100	182	1.274	1.262	-0.012
Max		1.292	1.295	0.011
Average		1.265	1.260	-0.005
Min		1.239	1.236	-0.045
Std Dev		0.011	0.012	0.010

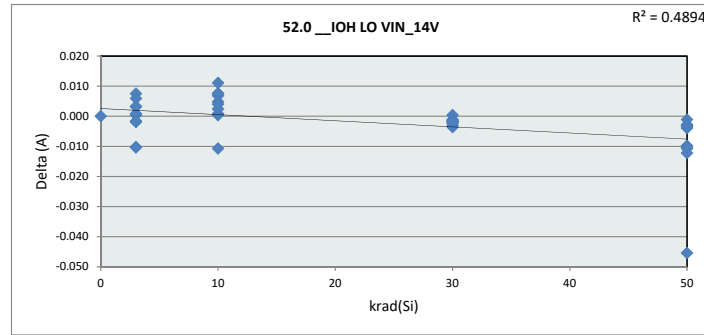

52.0 IOH LO VIN		
Test Site	DAL-FL	
Tester	ETS364	
Test Number	EB672302	
Max Limit	2.3	A
Min Limit	0.7	A

krad(Si)	0	3	10	30	50	100
LL	0.700	0.700	0.700	0.700	0.700	0.700
Min	1.278	1.252	1.250	1.238	1.239	1.236
Average	1.278	1.263	1.269	1.258	1.257	1.252
Max	1.278	1.287	1.295	1.269	1.270	1.262
UL	2.300	2.300	2.300	2.300	2.300	2.300

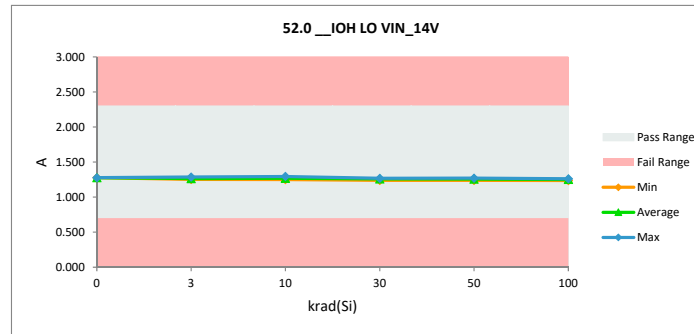

TID HDR Report
TPS7H6003-SP (5962R2220101VXC)

52.1 IOH HO VIN 14V		
Test Site	DAL-FL	DAL-FL
Tester	ETS364	ETS364
Test Number	EB672302	EB672302
Unit	A	A
Max Limit	2.3	2.3
Min Limit	0.7	0.7

krad(Si)	Serial #	pre_short (rtp)	(2)ST_Combo (rpt)	Delta
0	Ctrl	1.275	1.275	0.000
3	58	1.269	1.265	-0.003
3	59	1.256	1.258	0.002
3	60	1.284	1.283	-0.001
3	61	1.263	1.263	0.000
3	62	1.266	1.269	0.003
3	134	1.266	1.247	-0.019
3	137	1.262	1.247	-0.015
3	138	1.252	1.249	-0.003
3	139	1.250	1.255	0.004
3	236	1.276	1.259	-0.018
10	63	1.250	1.250	-0.001
10	64	1.254	1.258	0.003
10	65	1.270	1.270	0.001
10	66	1.286	1.286	0.000
10	150	1.253	1.258	0.005
10	237	1.256	1.260	0.003
10	241	1.265	1.248	-0.017
10	242	1.275	1.276	0.001
10	243	1.289	1.293	0.004
10	244	1.262	1.266	0.004
30	141	1.250	1.248	-0.003
30	144	1.265	1.262	-0.002
30	145	1.243	1.240	-0.003
30	146	1.268	1.266	-0.002
30	147	1.257	1.255	-0.002
30	132	1.260	1.255	-0.005
30	133	1.259	1.253	-0.006
30	135	1.267	1.264	-0.004
30	245	1.257	1.252	-0.005
30	246	1.259	1.254	-0.005
50	67	1.273	1.261	-0.012
50	68	1.291	1.241	-0.049
50	69	1.270	1.259	-0.011
50	71	1.269	1.257	-0.012
50	72	1.278	1.267	-0.011
50	172	1.249	1.237	-0.012
50	173	1.266	1.253	-0.013
50	174	1.255	1.242	-0.013
50	183	1.263	1.252	-0.012
50	186	1.256	1.244	-0.012
100	95	1.253	1.231	-0.023
100	102	1.289	1.266	-0.023
100	104	1.273	1.252	-0.021
100	105	1.270	1.245	-0.025
100	106	1.268	1.245	-0.023
100	178	1.274	1.246	-0.028
100	179	1.264	1.238	-0.026
100	180	1.260	1.233	-0.026
100	181	1.267	1.239	-0.028
100	182	1.278	1.250	-0.028
Max		1.291	1.293	0.005
Average		1.265	1.256	-0.010
Min		1.243	1.231	-0.049
Std Dev		0.011	0.013	0.012

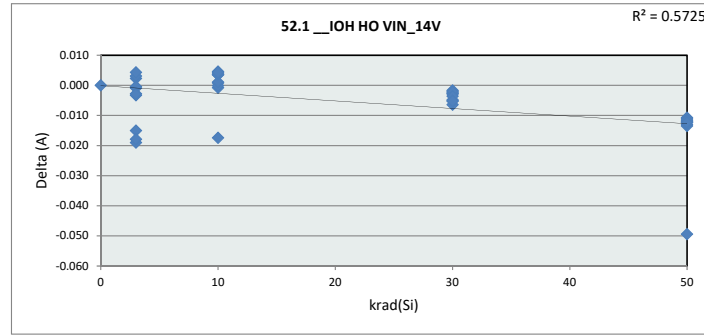

52.1 IOH HO VIN		
Test Site	DAL-FL	
Tester	ETS364	
Test Number	EB672302	
Max Limit	2.3	A
Min Limit	0.7	A

krad(Si)	0	3	10	30	50	100
LL	0.700	0.700	0.700	0.700	0.700	0.700
Min	1.275	1.247	1.248	1.240	1.237	1.231
Average	1.275	1.259	1.266	1.255	1.251	1.244
Max	1.275	1.283	1.293	1.266	1.267	1.266
UL	2.300	2.300	2.300	2.300	2.300	2.300

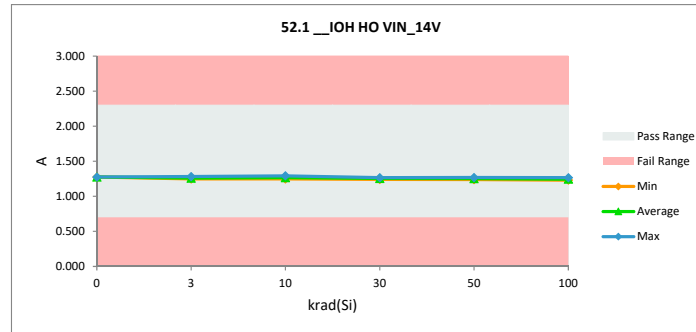

TID Report

TPS7H6003-SP (5962R2220101VXC)

52.2_IOL LO VIN_14V		
Test Site	DAL-FL	DAL-FL
Tester	ETS364	ETS364
Test Number	EB672302	EB672302
Unit	A	A
Max Limit	4.6	4.6
Min Limit	1.6	1.6

krad(Si)	Serial #	pre_short (rtp) (2)	ST_Combo (rpt) (Delta
0	248	2.509	2.509	0.000
3	58	2.564	2.571	0.007
3	59	2.532	2.549	0.017
3	60	2.525	2.537	0.013
3	61	2.568	2.578	0.010
3	62	2.562	2.584	0.022
3	134	2.536	2.532	-0.004
3	137	2.517	2.531	0.014
3	138	2.508	2.537	0.029
3	139	2.527	2.554	0.027
3	236	2.542	2.555	0.013
10	63	2.517	2.543	0.026
10	64	2.533	2.571	0.038
10	65	2.532	2.564	0.032
10	66	2.544	2.576	0.032
10	150	2.515	2.562	0.047
10	237	2.521	2.559	0.038
10	241	2.527	2.533	0.006
10	242	2.528	2.568	0.039
10	243	2.542	2.585	0.043
10	244	2.510	2.554	0.045
30	141	2.547	2.608	0.061
30	144	2.534	2.595	0.061
30	145	2.533	2.599	0.067
30	146	2.532	2.596	0.064
30	147	2.526	2.593	0.067
30	132	2.516	2.566	0.050
30	133	2.491	2.545	0.054
30	135	2.528	2.571	0.043
30	245	2.532	2.590	0.058
30	246	2.528	2.580	0.052
50	67	2.532	2.607	0.075
50	68	2.572	2.600	0.028
50	69	2.536	2.608	0.073
50	71	2.561	2.630	0.069
50	72	2.537	2.616	0.079
50	172	2.509	2.582	0.073
50	173	2.535	2.608	0.073
50	174	2.533	2.606	0.073
50	183	2.544	2.612	0.069
50	186	2.538	2.616	0.078
100	95	2528.900	2.643	-2526.257
100	102	2556.100	2.680	-2553.420
100	104	2565.200	2.682	-2562.518
100	105	2549.800	2.665	-2547.135
100	106	2548.200	2.665	-2545.535
100	178	2.533	2.632	0.099
100	179	2.538	2.645	0.107
100	180	2.517	2.619	0.102
100	181	2.512	2.618	0.105
100	182	2.545	2.649	0.104
Max		2565.200	2.682	0.107
Average		252.248	2.590	-249.659
Min		2.491	2.509	-2562.518
Std Dev		764.974	0.041	764.948

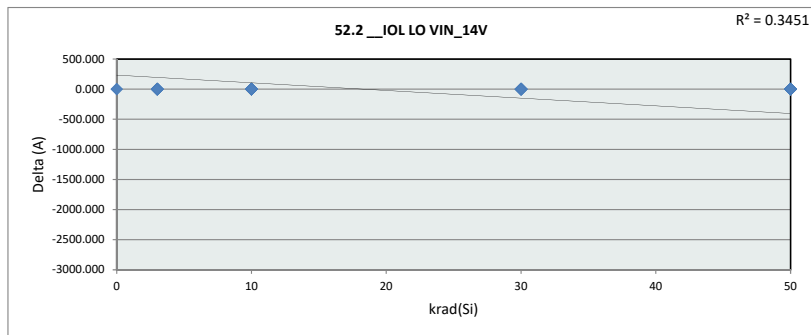

52.2_IOL LO VIN_14V		
Test Site	DAL-FL	
Tester	ETS364	
Test Number	EB672302	
Max Limit	4.6	A
Min Limit	1.6	A

krad(Si)	0	3	10	30	50	100
LL	1.600	1.600	1.600	1.600	1.600	1.600
Min	2.509	2.531	2.533	2.545	2.583	2.618
Average	2.509	2.553	2.561	2.584	2.609	2.650
Max	2.509	2.584	2.585	2.608	2.630	2.682
UL	4.600	4.600	4.600	4.600	4.600	4.600

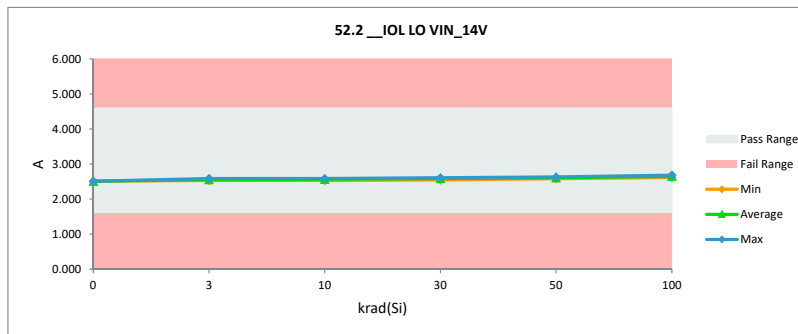

TID HDR Report
TPS7H6003-SP (5962R2220101VXC)

60.0_V_BP7L PWM 500kHz VIN		
Test Site	DAL-FL	DAL-FL
Tester	ETS364	ETS364
Test Number	EB672302	EB672302
Unit	V	V
Max Limit	7.35	7.35
Min Limit	6.65	6.65

krad(Si)	Serial #	pre_short (rtp)	(2)'ST_Combo (rpt)	Delta
0	Ctrl	7.046	7.046	0.000
3	58	7.053	7.054	0.001
3	59	7.010	7.012	0.001
3	60	6.984	6.985	0.001
3	61	6.995	6.992	-0.003
3	62	6.974	6.973	-0.002
3	134	7.043	7.012	-0.031
3	137	6.950	7.012	0.062
3	138	7.038	7.012	-0.026
3	139	6.986	6.985	-0.001
3	236	6.983	7.000	0.017
10	63	6.985	6.981	-0.003
10	64	7.008	7.003	-0.004
10	65	7.034	7.036	0.002
10	66	7.030	7.028	-0.002
10	150	7.027	7.022	-0.005
10	237	7.020	7.001	-0.020
10	241	7.029	7.012	-0.017
10	242	7.002	7.003	0.001
10	243	7.004	7.003	-0.001
10	244	7.076	7.071	-0.005
30	141	7.044	7.041	-0.003
30	144	6.998	6.996	-0.002
30	145	7.040	7.039	-0.001
30	146	7.017	7.010	-0.007
30	147	7.021	7.014	-0.007
30	132	7.043	7.044	0.001
30	133	7.042	7.032	-0.009
30	135	7.004	7.038	0.035
30	245	6.998	6.994	-0.004
30	246	7.014	7.007	-0.006
50	67	7.044	7.040	-0.004
50	68	7.007	6.985	-0.022
50	69	7.044	7.050	0.006
50	71	6.991	6.985	-0.006
50	72	7.007	7.001	-0.006
50	172	7.024	6.990	-0.034
50	173	7.036	7.024	-0.013
50	174	7.012	7.015	0.002
50	183	7.019	7.018	-0.001
50	186	6.987	6.989	0.002
100	95	7.002	7.028	0.026
100	102	6.955	6.948	-0.007
100	104	7.036	7.022	-0.014
100	105	7.023	6.997	-0.025
100	106	6.947	6.947	-0.001
100	178	7.053	7.036	-0.017
100	179	6.988	7.032	0.045
100	180	7.023	7.010	-0.012
100	181	7.027	7.016	-0.011
100	182	7.029	7.055	0.026
	Max	7.076	7.071	0.062
	Average	7.015	7.013	-0.002
	Min	6.947	6.947	-0.034
	Std Dev	0.027	0.026	0.017

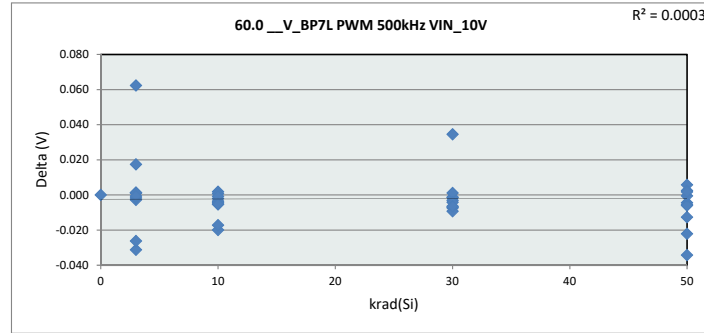

60.0_V_BP7L PWM

Test Site	DAL-FL
Tester	ETS364
Test Number	EB672302
Max Limit	7.35 V
Min Limit	6.65 V

krad(Si)	0	3	10	30	50	100
LL	6.650	6.650	6.650	6.650	6.650	6.650
Min	7.046	6.973	6.981	6.994	6.985	6.947
Average	7.046	7.004	7.016	7.022	7.010	7.009
Max	7.046	7.054	7.071	7.044	7.050	7.055
UL	7.350	7.350	7.350	7.350	7.350	7.350

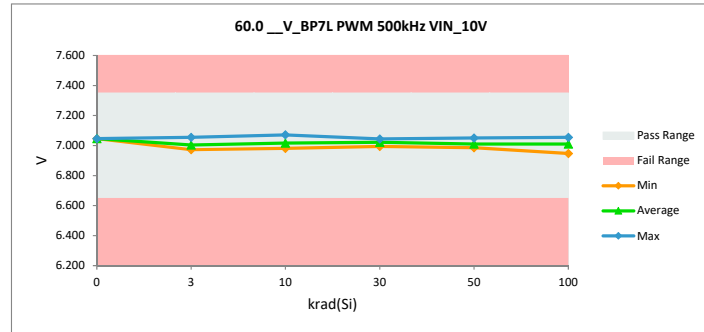

TID HDR Report
TPS7H6003-SP (5962R2220101VXC)

60.1_V_BP5L PWM 500kHz VIN		
Test Site	DAL-FL	DAL-FL
Tester	ETS364	ETS364
Test Number	EB672302	EB672302
Unit	V	V
Max Limit	5.175	5.175
Min Limit	4.75	4.75

krad(Si)	Serial #	pre_short (rtp)	(2)ST_Combo (rpt)	Delta
0	Ctrl	5.016	5.016	0.000
3	58	4.991	4.991	0.000
3	59	4.982	4.983	0.000
3	60	4.994	4.994	0.000
3	61	4.993	4.991	-0.001
3	62	5.004	5.005	0.001
3	134	4.989	4.995	0.006
3	137	4.980	4.995	0.015
3	138	4.997	4.995	-0.001
3	139	4.999	5.000	0.002
3	236	5.007	4.989	-0.018
10	63	5.004	5.001	-0.003
10	64	4.989	4.988	0.000
10	65	5.016	5.014	-0.002
10	66	5.003	5.001	-0.002
10	150	4.995	4.991	-0.004
10	237	5.015	4.989	-0.026
10	241	5.015	4.995	-0.019
10	242	4.981	4.981	0.000
10	243	5.004	5.006	0.002
10	244	4.999	5.000	0.001
30	141	5.003	5.000	-0.003
30	144	5.014	5.014	-0.001
30	145	5.012	5.008	-0.004
30	146	4.993	4.984	-0.009
30	147	5.023	5.020	-0.002
30	132	4.993	4.990	-0.003
30	133	5.007	5.005	-0.002
30	135	5.017	4.979	-0.038
30	245	5.005	4.998	-0.007
30	246	5.020	5.015	-0.005
50	67	4.983	4.977	-0.005
50	68	4.988	5.023	0.035
50	69	5.009	5.003	-0.006
50	71	5.001	5.000	-0.001
50	72	5.001	4.991	-0.010
50	172	5.009	5.052	0.043
50	173	4.983	4.973	-0.010
50	174	5.011	5.008	-0.004
50	183	5.006	5.004	-0.002
50	186	4.990	4.987	-0.003
100	95	4.996	4.977	-0.019
100	102	5.004	5.001	-0.003
100	104	4.991	4.969	-0.023
100	105	4.988	5.034	0.046
100	106	4.997	4.925	-0.071
100	178	5.012	5.015	0.003
100	179	4.986	4.964	-0.022
100	180	5.017	4.950	-0.068
100	181	5.000	4.987	-0.013
100	182	5.008	5.015	0.007
Max		5.023	5.052	0.046
Average		5.001	4.996	-0.005
Min		4.980	4.925	-0.071
Std Dev		0.011	0.020	0.019

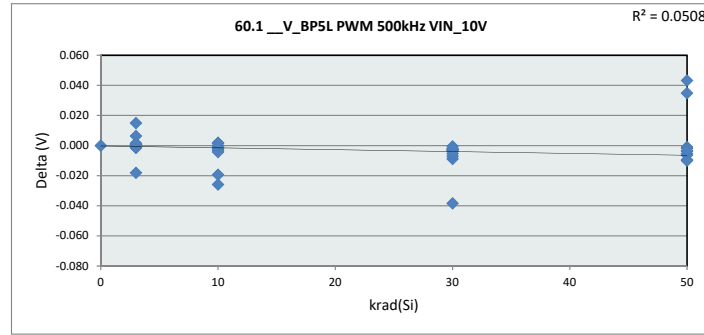

60.1_V_BP5L PWM		
Test Site	DAL-FL	
Tester	ETS364	
Test Number	EB672302	
Max Limit	5.175	V
Min Limit	4.75	V

krad(Si)	0	3	10	30	50	100
LL	4.750	4.750	4.750	4.750	4.750	4.750
Min	5.016	4.983	4.981	4.979	4.973	4.925
Average	5.016	4.994	4.997	5.001	5.002	4.984
Max	5.016	5.005	5.014	5.020	5.052	5.034
UL	5.175	5.175	5.175	5.175	5.175	5.175

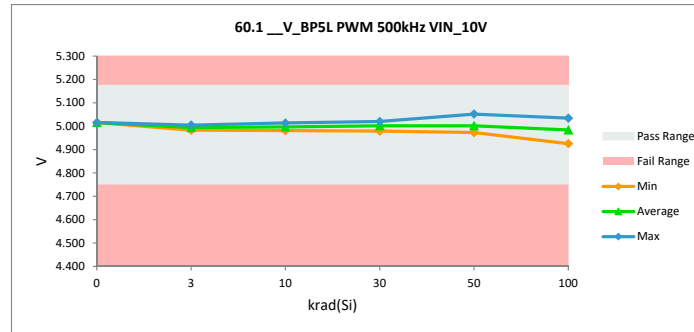

TID HDR Report
TPS7H6003-SP (5962R2220101VXC)

60.2_V_BP5H PWM 500kHz VI		
Test Site	DAL-FL	DAL-FL
Tester	ETS364	ETS364
Test Number	EB672302	EB672302
Unit	V	V
Max Limit	5.175	5.175
Min Limit	4.75	4.75

krad(Si)	Serial #	pre_short (rtp)	(2)'ST_Combo (rpt)	Delta
0	Ctrl	5.017	5.017	0.000
3	58	5.019	5.019	-0.001
3	59	5.006	5.005	-0.001
3	60	4.999	4.999	0.000
3	61	4.993	4.992	-0.001
3	62	4.986	4.985	-0.001
3	134	4.999	5.001	0.003
3	137	5.004	5.002	-0.002
3	138	4.984	5.002	0.017
3	139	4.994	4.995	0.001
3	236	5.004	5.008	0.003
10	63	4.986	4.984	-0.002
10	64	5.000	5.001	0.001
10	65	5.019	5.020	0.001
10	66	4.990	4.986	-0.004
10	150	5.006	5.004	-0.002
10	237	4.981	5.008	0.026
10	241	4.997	5.001	0.005
10	242	5.021	5.023	0.001
10	243	5.020	5.020	0.000
10	244	5.002	5.003	0.000
30	141	5.009	5.009	0.001
30	144	4.982	4.976	-0.006
30	145	5.011	5.006	-0.005
30	146	4.993	4.984	-0.010
30	147	4.996	4.993	-0.003
30	132	5.008	4.999	-0.009
30	133	4.998	4.999	0.001
30	135	5.004	4.987	-0.017
30	245	5.010	5.011	0.002
30	246	4.981	4.977	-0.004
50	67	5.009	5.010	0.002
50	68	4.998	5.005	0.007
50	69	4.988	4.983	-0.005
50	71	4.989	4.986	-0.003
50	72	4.982	4.982	0.000
50	172	4.992	4.985	-0.007
50	173	4.990	4.983	-0.007
50	174	5.000	4.991	-0.009
50	183	4.984	4.980	-0.004
50	186	4.986	4.983	-0.004
100	95	4.986	4.976	-0.011
100	102	4.983	4.989	0.006
100	104	5.004	5.023	0.019
100	105	4.998	5.018	0.021
100	106	4.989	4.961	-0.028
100	178	4.993	4.985	-0.008
100	179	4.996	4.992	-0.003
100	180	4.990	4.991	0.000
100	181	5.020	4.997	-0.023
100	182	5.010	5.033	0.023
	Max	5.021	5.033	0.026
	Average	4.998	4.997	-0.001
	Min	4.981	4.961	-0.028
	Std Dev	0.012	0.015	0.010

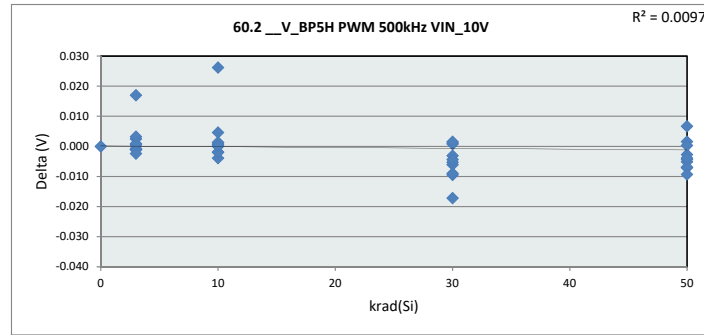

60.2_V_BP5H PWM		
Test Site	DAL-FL	
Tester	ETS364	
Test Number	EB672302	
Max Limit	5.175	V
Min Limit	4.75	V

krad(Si)	0	3	10	30	50	100
LL	4.750	4.750	4.750	4.750	4.750	4.750
Min	5.017	4.985	4.984	4.976	4.980	4.961
Average	5.017	5.001	5.005	4.994	4.989	4.996
Max	5.017	5.019	5.023	5.011	5.010	5.033
UL	5.175	5.175	5.175	5.175	5.175	5.175

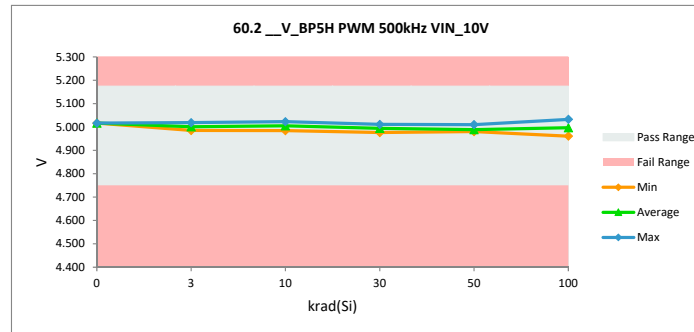

TID HDR Report
TPS7H6003-SP (5962R2220101VXC)

60.3 V BP7L PWM 1MHz VIN		
Test Site	DAL-FL	DAL-FL
Tester	ETS364	ETS364
Test Number	EB672302	EB672302
Unit	V	V
Max Limit	7.35	7.35
Min Limit	6.65	6.65

krad(Si)	Serial #	pre_short (rtp)	(2)ST_Combo (rpt)	Delta
0	Ctrl	7.042	7.042	0.000
3	58	7.048	7.050	0.001
3	59	7.006	7.007	0.001
3	60	6.980	6.981	0.001
3	61	6.991	6.988	-0.003
3	62	6.970	6.968	-0.002
3	134	7.039	7.008	-0.031
3	137	6.945	7.008	0.063
3	138	7.034	7.008	-0.026
3	139	6.982	6.981	-0.001
3	236	6.978	6.996	0.018
10	63	6.981	6.977	-0.003
10	64	7.004	6.999	-0.005
10	65	7.030	7.032	0.002
10	66	7.025	7.023	-0.002
10	150	7.023	7.017	-0.005
10	237	7.016	6.996	-0.020
10	241	7.024	7.008	-0.017
10	242	6.998	6.999	0.001
10	243	6.999	6.999	-0.001
10	244	7.072	7.067	-0.005
30	141	7.039	7.036	-0.003
30	144	6.994	6.992	-0.002
30	145	7.036	7.035	-0.002
30	146	7.013	7.005	-0.008
30	147	7.016	7.009	-0.007
30	132	7.039	7.040	0.001
30	133	7.037	7.028	-0.010
30	135	6.999	7.034	0.034
30	245	6.994	6.990	-0.004
30	246	7.009	7.002	-0.007
50	67	7.040	7.035	-0.005
50	68	7.002	6.980	-0.022
50	69	7.040	7.047	0.006
50	71	6.987	6.981	-0.006
50	72	7.002	6.996	-0.006
50	172	7.020	6.985	-0.035
50	173	7.032	7.019	-0.013
50	174	7.008	7.011	0.003
50	183	7.015	7.014	0.000
50	186	6.983	6.985	0.002
100	95	6.997	7.024	0.027
100	102	6.951	6.943	-0.008
100	104	7.032	7.017	-0.015
100	105	7.018	6.992	-0.026
100	106	6.943	6.942	-0.001
100	178	7.048	7.031	-0.017
100	179	6.984	7.029	0.045
100	180	7.018	7.006	-0.013
100	181	7.023	7.012	-0.011
100	182	7.025	7.052	0.027
Max		7.072	7.067	0.063
Average		7.010	7.008	-0.002
Min		6.943	6.942	-0.035
Std Dev		0.027	0.026	0.017

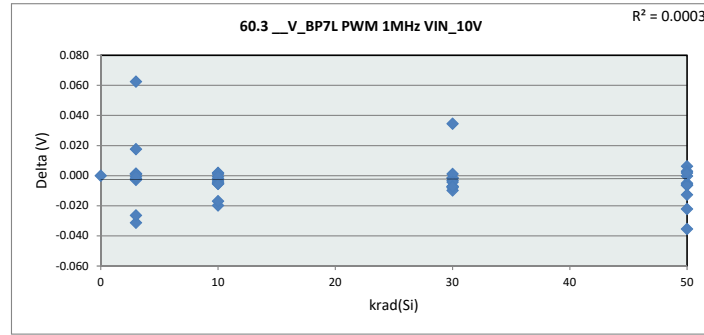

60.3 V BP7L PWM

Test Site	DAL-FL
Tester	ETS364
Test Number	EB672302
Max Limit	7.35 V
Min Limit	6.65 V

krad(Si)	0	3	10	30	50	100
LL	6.650	6.650	6.650	6.650	6.650	6.650
Min	7.042	6.968	6.977	6.990	6.980	6.942
Average	7.042	6.999	7.012	7.017	7.005	7.005
Max	7.042	7.050	7.067	7.040	7.047	7.052
UL	7.350	7.350	7.350	7.350	7.350	7.350

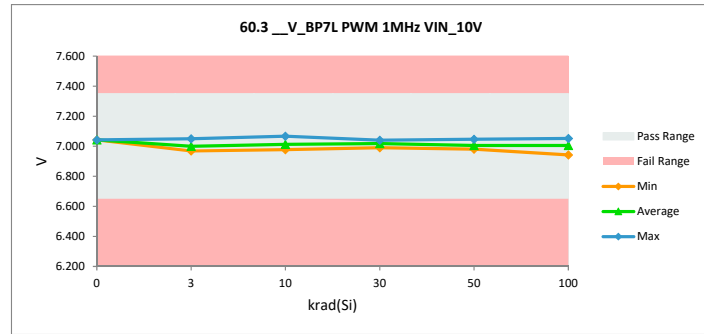

TID HDR Report
TPS7H6003-SP (5962R2220101VXC)

60.4 _V_BP5L PWM 1MHz VIN		
Test Site	DAL-FL	DAL-FL
Tester	ETS364	ETS364
Test Number	EB672302	EB672302
Unit	V	V
Max Limit	5.175	5.175
Min Limit	4.75	4.75

krad(Si)	Serial #	pre_short (rtp)	(2)'ST_Combo (rpt)	Delta
0	Ctrl	5.017	5.017	0.000
3	58	4.993	4.993	0.000
3	59	4.984	4.984	0.000
3	60	4.996	4.996	0.000
3	61	4.995	4.993	-0.001
3	62	5.005	5.006	0.001
3	134	4.990	4.997	0.007
3	137	4.982	4.997	0.015
3	138	4.998	4.997	-0.001
3	139	5.000	5.002	0.002
3	236	5.008	4.991	-0.018
10	63	5.005	5.003	-0.003
10	64	4.990	4.990	0.000
10	65	5.017	5.016	-0.002
10	66	5.005	5.003	-0.002
10	150	4.997	4.993	-0.004
10	237	5.016	4.991	-0.026
10	241	5.016	4.997	-0.019
10	242	4.983	4.983	0.000
10	243	5.005	5.008	0.002
10	244	5.000	5.002	0.002
30	141	5.005	5.002	-0.003
30	144	5.016	5.015	0.000
30	145	5.013	5.010	-0.003
30	146	4.995	4.986	-0.009
30	147	5.024	5.022	-0.002
30	132	4.995	4.992	-0.002
30	133	5.009	5.007	-0.002
30	135	5.019	4.980	-0.039
30	245	5.006	5.000	-0.007
30	246	5.021	5.016	-0.005
50	67	4.984	4.979	-0.005
50	68	4.990	5.025	0.036
50	69	5.011	5.005	-0.006
50	71	5.003	5.002	-0.001
50	72	5.002	4.993	-0.009
50	172	5.011	5.056	0.045
50	173	4.984	4.975	-0.010
50	174	5.013	5.010	-0.003
50	183	5.007	5.006	-0.001
50	186	4.992	4.989	-0.003
100	95	4.998	4.979	-0.019
100	102	5.006	5.003	-0.002
100	104	4.993	4.970	-0.023
100	105	4.990	5.037	0.047
100	106	4.998	4.926	-0.072
100	178	5.014	5.018	0.004
100	179	4.988	4.965	-0.023
100	180	5.019	4.951	-0.068
100	181	5.002	4.990	-0.012
100	182	5.010	5.017	0.008
	Max	5.024	5.056	0.047
	Average	5.002	4.998	-0.005
	Min	4.982	4.926	-0.072
	Std Dev	0.011	0.020	0.020

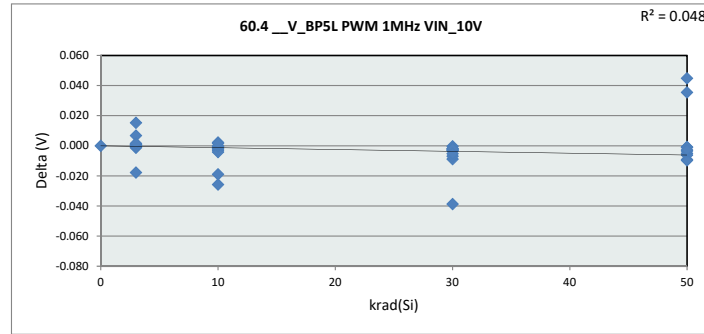

60.4 _V_BP5L PWM

Test Site	DAL-FL
Tester	ETS364
Test Number	EB672302
Max Limit	5.175 V
Min Limit	4.75 V

krad(Si)	0	3	10	30	50	100
LL	4.750	4.750	4.750	4.750	4.750	4.750
Min	5.018	4.984	4.983	4.980	4.975	4.926
Average	5.018	4.996	4.998	5.003	5.004	4.986
Max	5.018	5.006	5.016	5.022	5.056	5.037
UL	5.175	5.175	5.175	5.175	5.175	5.175

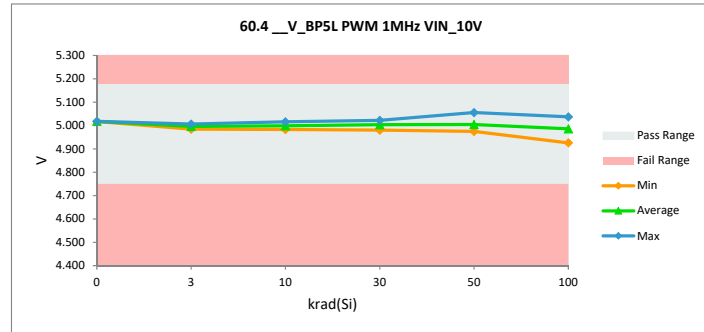

TID HDR Report
TPS7H6003-SP (5962R2220101VXC)

60.5 V BP5H PWM 1MHz VIN		
Test Site	DAL-FL	DAL-FL
Tester	ETS364	ETS364
Test Number	EB672302	EB672302
Unit	V	V
Max Limit	5.175	5.175
Min Limit	4.75	4.75

krad(Si)	Serial #	pre_short (rtp)	(2)ST_Combo (rpt)	Delta
0	Ctrl	5.017	5.017	0.000
3	58	5.020	5.019	-0.001
3	59	5.007	5.006	-0.001
3	60	4.999	5.000	0.001
3	61	4.993	4.992	-0.001
3	62	4.987	4.986	-0.001
3	134	5.000	5.002	0.003
3	137	5.004	5.002	-0.002
3	138	4.985	5.002	0.017
3	139	4.995	4.996	0.001
3	236	5.005	5.008	0.003
10	63	4.987	4.985	-0.002
10	64	5.001	5.002	0.001
10	65	5.020	5.020	0.001
10	66	4.991	4.987	-0.004
10	150	5.006	5.005	-0.002
10	237	4.982	5.008	0.026
10	241	4.997	5.002	0.005
10	242	5.022	5.023	0.001
10	243	5.021	5.021	0.000
10	244	5.003	5.003	0.000
30	141	5.009	5.010	0.001
30	144	4.983	4.977	-0.006
30	145	5.011	5.006	-0.005
30	146	4.994	4.984	-0.010
30	147	4.997	4.994	-0.003
30	132	5.009	5.000	-0.009
30	133	4.998	4.999	0.001
30	135	5.005	4.988	-0.017
30	245	5.010	5.011	0.002
30	246	4.982	4.977	-0.004
50	67	5.009	5.011	0.002
50	68	4.999	5.005	0.007
50	69	4.989	4.984	-0.005
50	71	4.990	4.987	-0.003
50	72	4.982	4.983	0.000
50	172	4.992	4.986	-0.007
50	173	4.991	4.984	-0.007
50	174	5.001	4.991	-0.009
50	183	4.985	4.981	-0.004
50	186	4.987	4.983	-0.004
100	95	4.987	4.977	-0.010
100	102	4.984	4.990	0.006
100	104	5.005	5.024	0.019
100	105	4.998	5.019	0.021
100	106	4.990	4.962	-0.028
100	178	4.993	4.985	-0.008
100	179	4.996	4.993	-0.003
100	180	4.991	4.991	0.000
100	181	5.021	4.997	-0.024
100	182	5.011	5.034	0.023
	Max	5.022	5.034	0.026
	Average	4.999	4.998	-0.001
	Min	4.982	4.962	-0.028
	Std Dev	0.011	0.015	0.010

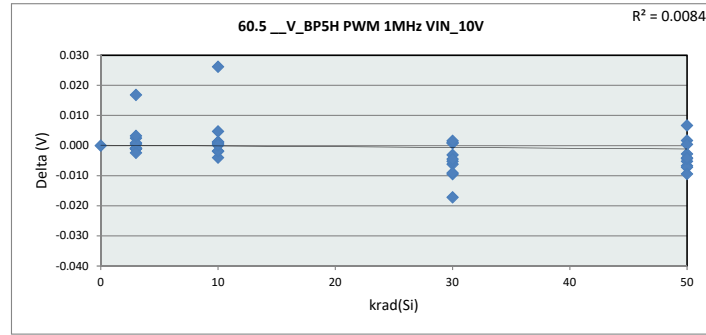

60.5 V BP5H PWM		
Test Site	DAL-FL	
Tester	ETS364	
Test Number	EB672302	
Max Limit	5.175	V
Min Limit	4.75	V

krad(Si)	0	3	10	30	50	100
LL	4.750	4.750	4.750	4.750	4.750	4.750
Min	5.017	4.986	4.985	4.977	4.981	4.962
Average	5.017	5.001	5.006	4.995	4.989	4.997
Max	5.017	5.019	5.023	5.012	5.011	5.034
UL	5.175	5.175	5.175	5.175	5.175	5.175

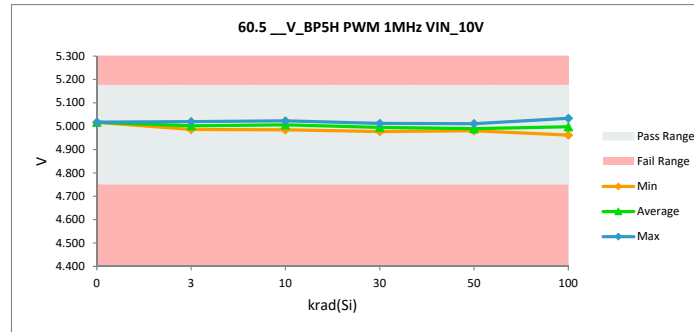

TID HDR Report
TPS7H6003-SP (5962R2220101VXC)

60.6_V_BP7L PWM 2MHz VIN		
Test Site	DAL-FL	DAL-FL
Tester	ETS364	ETS364
Test Number	EB672302	EB672302
Unit	V	V
Max Limit	7.35	7.35
Min Limit	6.65	6.65

krad(Si)	Serial #	pre_short (rtp)	(2)'ST_Combo (rpt)	Delta
0	Ctrl	7.034	7.034	0.000
3	58	7.040	7.042	0.002
3	59	6.998	6.999	0.001
3	60	6.971	6.973	0.001
3	61	6.983	6.980	-0.003
3	62	6.962	6.960	-0.002
3	134	7.031	7.000	-0.031
3	137	6.938	7.000	0.062
3	138	7.026	7.000	-0.026
3	139	6.974	6.973	0.000
3	236	6.970	6.988	0.018
10	63	6.973	6.969	-0.004
10	64	6.996	6.991	-0.005
10	65	7.021	7.023	0.002
10	66	7.016	7.014	-0.002
10	150	7.014	7.008	-0.006
10	237	7.008	6.988	-0.020
10	241	7.016	7.000	-0.016
10	242	6.990	6.991	0.001
10	243	6.991	6.990	-0.001
10	244	7.064	7.059	-0.005
30	141	7.031	7.027	-0.003
30	144	6.985	6.984	-0.002
30	145	7.028	7.026	-0.002
30	146	7.005	6.997	-0.009
30	147	7.008	7.000	-0.008
30	132	7.030	7.032	0.001
30	133	7.029	7.019	-0.010
30	135	6.991	7.025	0.035
30	245	6.986	6.981	-0.004
30	246	7.000	6.992	-0.008
50	67	7.032	7.026	-0.006
50	68	6.994	6.971	-0.022
50	69	7.032	7.039	0.007
50	71	6.978	6.971	-0.007
50	72	6.994	6.987	-0.007
50	172	7.012	6.975	-0.037
50	173	7.023	7.010	-0.013
50	174	6.999	7.003	0.004
50	183	7.007	7.007	0.000
50	186	6.975	6.977	0.002
100	95	6.989	7.015	0.026
100	102	6.942	6.934	-0.009
100	104	7.023	7.008	-0.015
100	105	7.010	6.983	-0.027
100	106	6.935	6.933	-0.002
100	178	7.039	7.022	-0.017
100	179	6.976	7.022	0.047
100	180	7.010	6.997	-0.013
100	181	7.015	7.004	-0.010
100	182	7.017	7.042	0.026
	Max	7.064	7.059	0.062
	Average	7.002	7.000	-0.002
	Min	6.935	6.933	-0.037
	Std Dev	0.027	0.026	0.017

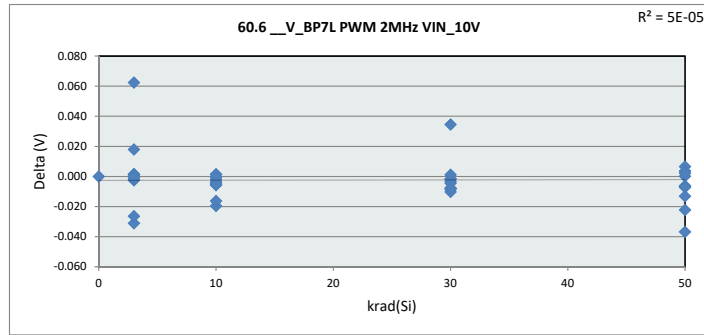

60.6_V_BP7L PWM		
Test Site	DAL-FL	
Tester	ETS364	
Test Number	EB672302	
Max Limit	7.35	V
Min Limit	6.65	V

krad(Si)	0	3	10	30	50	100
LL	6.650	6.650	6.650	6.650	6.650	6.650
Min	7.034	6.960	6.969	6.981	6.971	6.933
Average	7.034	6.991	7.003	7.008	6.997	6.996
Max	7.034	7.042	7.059	7.032	7.039	7.042
UL	7.350	7.350	7.350	7.350	7.350	7.350

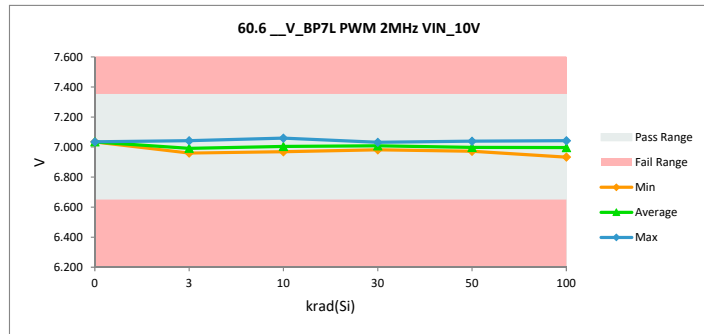

TID HDR Report
TPS7H6003-SP (5962R2220101VXC)

60.7 V_BP5L PWM 2MHz VIN		
Test Site	DAL-FL	DAL-FL
Tester	ETS364	ETS364
Test Number	EB672302	EB672302
Unit	V	V
Max Limit	5.175	5.175
Min Limit	4.75	4.75

krad(Si)	Serial #	pre_short (rtp)	(2)'ST_Combo (rpt)	Delta
0	Ctrl	5.021	5.021	0.000
3	58	4.996	4.997	0.001
3	59	4.988	4.988	0.001
3	60	5.000	5.000	0.000
3	61	4.999	4.998	-0.001
3	62	5.009	5.010	0.001
3	134	4.994	5.002	0.008
3	137	4.985	5.002	0.016
3	138	5.002	5.002	0.000
3	139	5.004	5.006	0.002
3	236	5.012	4.995	-0.017
10	63	5.009	5.006	-0.003
10	64	4.993	4.993	0.000
10	65	5.020	5.019	-0.001
10	66	5.009	5.007	-0.002
10	150	5.001	4.997	-0.004
10	237	5.020	4.994	-0.025
10	241	5.019	5.002	-0.018
10	242	4.986	4.987	0.000
10	243	5.009	5.011	0.002
10	244	5.004	5.006	0.002
30	141	5.009	5.006	-0.002
30	144	5.019	5.019	0.000
30	145	5.016	5.013	-0.003
30	146	4.998	4.989	-0.009
30	147	5.027	5.026	-0.001
30	132	4.998	4.997	-0.002
30	133	5.012	5.011	-0.002
30	135	5.022	4.984	-0.039
30	245	5.010	5.004	-0.006
30	246	5.024	5.019	-0.005
50	67	4.988	4.983	-0.004
50	68	4.993	5.031	0.037
50	69	5.015	5.009	-0.006
50	71	5.007	5.006	0.000
50	72	5.005	4.997	-0.009
50	172	5.015	5.063	0.048
50	173	4.988	4.979	-0.009
50	174	5.017	5.015	-0.002
50	183	5.011	5.011	0.000
50	186	4.995	4.994	-0.002
100	95	5.001	4.983	-0.018
100	102	5.009	5.007	-0.002
100	104	4.996	4.974	-0.022
100	105	4.993	5.043	0.049
100	106	5.001	4.927	-0.074
100	178	5.018	5.024	0.006
100	179	4.991	4.969	-0.022
100	180	5.022	4.953	-0.069
100	181	5.005	4.994	-0.011
100	182	5.013	5.022	0.009
Max		5.027	5.063	0.049
Average		5.006	5.002	-0.004
Min		4.985	4.927	-0.074
Std Dev		0.011	0.021	0.020

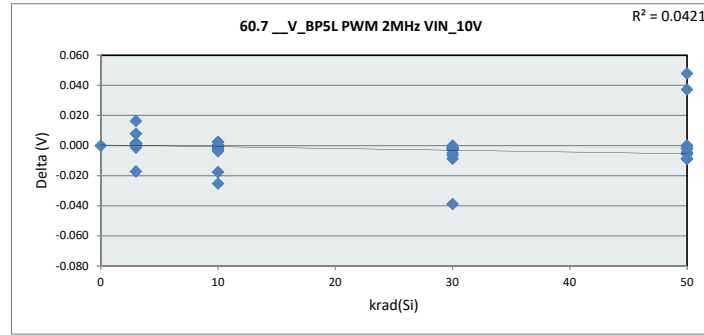

60.7 V_BP5L PWM						
Test Site	DAL-FL					
Tester	ETS364					
Test Number	EB672302					
Max Limit	5.175 V					
Min Limit	4.75 V					
krad(Si)	0	3	10	30	50	100
LL	4.750	4.750	4.750	4.750	4.750	4.750
Min	5.021	4.988	4.987	4.984	4.979	4.928
Average	5.021	5.000	5.002	5.007	5.009	4.990
Max	5.021	5.010	5.019	5.026	5.063	5.043
UL	5.175	5.175	5.175	5.175	5.175	5.175

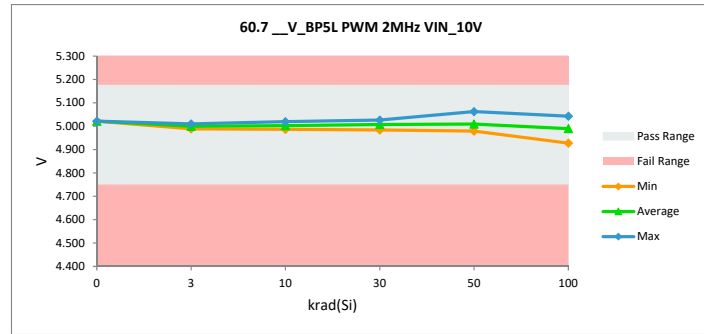

TID HDR Report
TPS7H6003-SP (5962R2220101VXC)

60.8 V BP5H PWM 2MHz VIN		
Test Site	DAL-FL	DAL-FL
Tester	ETS364	ETS364
Test Number	EB672302	EB672302
Unit	V	V
Max Limit	5.175	5.175
Min Limit	4.75	4.75

krad(Si)	Serial #	pre_short (rtp)	(2)'ST_Combo (rpt)	Delta
0	Ctrl	5.018	5.018	0.000
3	58	5.021	5.021	-0.001
3	59	5.008	5.007	-0.001
3	60	5.001	5.001	0.001
3	61	4.995	4.994	-0.001
3	62	4.988	4.987	-0.001
3	134	5.001	5.003	0.003
3	137	5.006	5.004	-0.002
3	138	4.986	5.003	0.017
3	139	4.996	4.997	0.001
3	236	5.006	5.009	0.003
10	63	4.988	4.986	-0.002
10	64	5.002	5.003	0.001
10	65	5.021	5.022	0.001
10	66	4.992	4.988	-0.004
10	150	5.008	5.006	-0.002
10	237	4.983	5.009	0.026
10	241	4.999	5.003	0.005
10	242	5.023	5.024	0.001
10	243	5.022	5.022	0.000
10	244	5.004	5.004	0.000
30	141	5.010	5.011	0.001
30	144	4.984	4.978	-0.006
30	145	5.013	5.008	-0.005
30	146	4.995	4.986	-0.010
30	147	4.998	4.995	-0.003
30	132	5.010	5.001	-0.009
30	133	4.999	5.001	0.001
30	135	5.006	4.989	-0.017
30	245	5.011	5.013	0.002
30	246	4.983	4.979	-0.004
50	67	5.010	5.012	0.002
50	68	5.000	5.007	0.007
50	69	4.990	4.985	-0.005
50	71	4.991	4.988	-0.003
50	72	4.984	4.984	0.000
50	172	4.994	4.987	-0.006
50	173	4.992	4.985	-0.007
50	174	5.002	4.993	-0.009
50	183	4.986	4.982	-0.005
50	186	4.989	4.984	-0.004
100	95	4.988	4.978	-0.010
100	102	4.985	4.991	0.006
100	104	5.006	5.026	0.020
100	105	4.999	5.021	0.022
100	106	4.991	4.963	-0.028
100	178	4.994	4.987	-0.008
100	179	4.997	4.994	-0.003
100	180	4.992	4.992	0.000
100	181	5.022	4.998	-0.024
100	182	5.012	5.035	0.023
	Max	5.023	5.035	0.026
	Average	5.000	4.999	-0.001
	Min	4.983	4.963	-0.028
	Std Dev	0.011	0.015	0.010

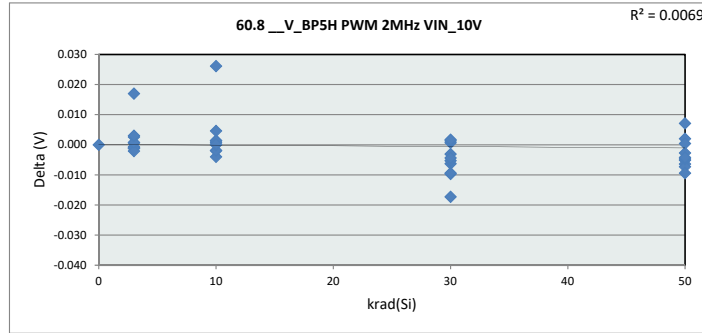

60.8 V BP5H PWM		
Test Site	DAL-FL	
Tester	ETS364	
Test Number	EB672302	
Max Limit	5.175	V
Min Limit	4.75	V

krad(Si)	0	3	10	30	50	100
LL	4.750	4.750	4.750	4.750	4.750	4.750
Min	5.018	4.987	4.986	4.978	4.982	4.963
Average	5.018	5.003	5.007	4.996	4.991	4.999
Max	5.018	5.021	5.024	5.013	5.012	5.035
UL	5.175	5.175	5.175	5.175	5.175	5.175

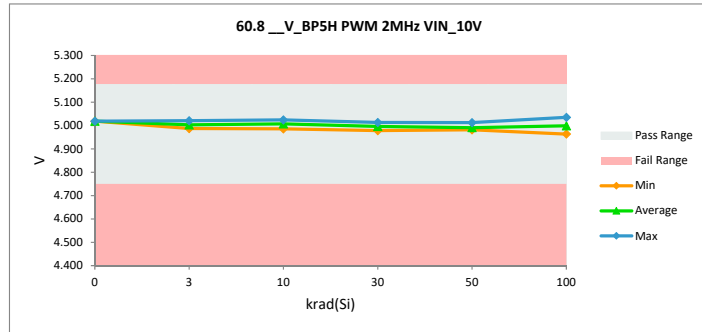

TID HDR Report
TPS7H6003-SP (5962R2220101VXC)

60.9_V_BP7L PWM 5MHz VIN		
Test Site	DAL-FL	DAL-FL
Tester	ETS364	ETS364
Test Number	EB672302	EB672302
Unit	V	V
Max Limit	7.35	7.35
Min Limit	6.65	6.65

krad(Si)	Serial #	pre_short (rtp)	(2)ST_Combo (rpt)	Delta
0	Ctrl	7.028	7.028	0.000
3	58	7.047	7.048	0.001
3	59	7.004	7.005	0.001
3	60	6.978	6.979	0.001
3	61	6.992	6.990	-0.002
3	62	6.969	6.968	-0.002
3	134	7.036	7.006	-0.030
3	137	6.944	7.006	0.062
3	138	7.033	7.006	-0.027
3	139	6.980	6.979	-0.001
3	236	6.962	6.994	0.032
10	63	6.979	6.976	-0.003
10	64	7.003	6.998	-0.004
10	65	7.028	7.029	0.001
10	66	7.024	7.023	-0.002
10	150	7.019	7.013	-0.007
10	237	7.013	6.994	-0.019
10	241	7.021	7.006	-0.015
10	242	6.996	6.998	0.002
10	243	6.999	6.998	-0.001
10	244	7.071	7.065	-0.005
30	141	7.038	7.036	-0.002
30	144	6.991	6.991	0.000
30	145	7.035	7.034	-0.002
30	146	7.012	7.003	-0.009
30	147	7.015	7.008	-0.007
30	132	7.037	7.040	0.003
30	133	7.035	7.023	-0.011
30	135	6.997	7.033	0.037
30	245	6.992	6.988	-0.004
30	246	7.006	6.997	-0.009
50	67	7.040	7.032	-0.008
50	68	6.984	6.978	-0.006
50	69	7.039	7.052	0.013
50	71	6.987	6.977	-0.010
50	72	7.002	6.995	-0.007
50	172	7.016	6.977	-0.039
50	173	7.030	7.016	-0.014
50	174	6.991	7.012	0.022
50	183	7.013	7.014	0.001
50	186	6.982	6.984	0.002
100	95	6.996	7.027	0.031
100	102	6.949	6.940	-0.009
100	104	7.030	7.013	-0.016
100	105	7.018	6.989	-0.029
100	106	6.942	6.941	-0.001
100	178	7.047	7.028	-0.018
100	179	6.983	7.034	0.051
100	180	7.008	7.003	-0.004
100	181	7.021	7.011	-0.010
100	182	7.024	7.051	0.027
	Max	7.071	7.065	0.062
	Average	7.008	7.007	-0.001
	Min	6.942	6.940	-0.039
	Std Dev	0.028	0.026	0.019

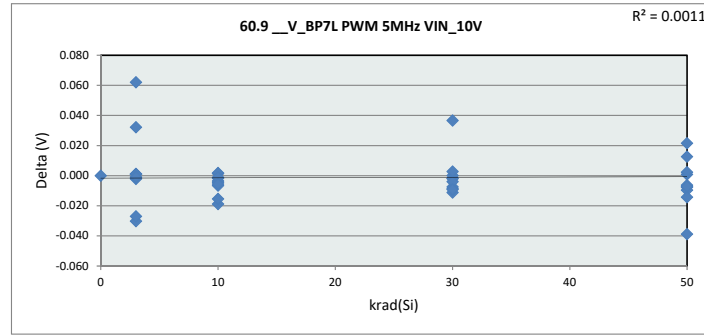

60.9_V_BP7L PWM						
Test Site	DAL-FL					
Tester	ETS364					
Test Number	EB672302					
Max Limit	7.35 V					
Min Limit	6.65 V					
krad(Si)	0	3	10	30	50	100
LL	6.650	6.650	6.650	6.650	6.650	6.650
Min	7.028	6.968	6.976	6.988	6.977	6.940
Average	7.028	6.998	7.010	7.015	7.004	7.004
Max	7.028	7.048	7.065	7.040	7.052	7.051
UL	7.350	7.350	7.350	7.350	7.350	7.350

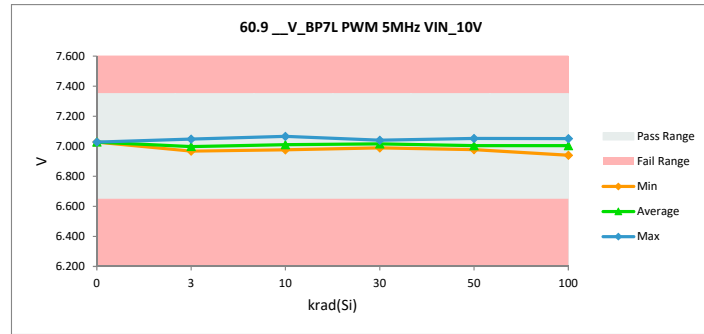

TID HDR Report

TPS7H6003-SP (5962R2220101VXC)

60.10_V_BP5L PWM 5MHz VIN		
Test Site	DAL-FL	DAL-FL
Tester	ETS364	ETS364
Test Number	EB672302	EB672302
Unit	V	V
Max Limit	5.175	5.175
Min Limit	4.75	4.75

krad(Si)	Serial #	pre_short (rtp) (2)	ST_Combo (rpt) (Delta
0	Ctrl	5.021	5.021	0.000
3	58	4.993	4.994	0.001
3	59	4.984	4.984	0.001
3	60	4.996	4.996	0.000
3	61	4.994	4.993	-0.001
3	62	5.005	5.006	0.001
3	134	4.991	4.997	0.005
3	137	4.982	4.997	0.015
3	138	4.998	4.997	-0.001
3	139	5.001	5.002	0.002
3	236	5.011	4.991	-0.020
10	63	5.005	5.002	-0.003
10	64	4.990	4.990	0.000
10	65	5.017	5.016	-0.002
10	66	5.004	5.002	-0.002
10	150	4.997	4.993	-0.004
10	237	5.016	4.991	-0.025
10	241	5.016	4.997	-0.020
10	242	4.983	4.983	0.000
10	243	5.005	5.007	0.002
10	244	5.001	5.002	0.001
30	141	5.004	5.001	-0.003
30	144	5.016	5.015	-0.001
30	145	5.013	5.010	-0.003
30	146	4.995	4.986	-0.009
30	147	5.024	5.022	-0.002
30	132	4.996	4.993	-0.003
30	133	5.009	5.007	-0.002
30	135	5.019	4.978	-0.041
30	245	5.006	5.000	-0.007
30	246	5.022	5.016	-0.006
50	67	4.984	4.979	-0.005
50	68	4.992	5.026	0.034
50	69	5.012	5.005	-0.007
50	71	5.002	5.002	-0.001
50	72	5.002	4.994	-0.009
50	172	5.011	5.061	0.050
50	173	4.984	4.974	-0.010
50	174	5.016	5.010	-0.007
50	183	5.007	5.006	-0.001
50	186	4.992	4.989	-0.003
100	95	4.998	4.978	-0.020
100	102	5.006	5.004	-0.002
100	104	4.993	4.970	-0.023
100	105	4.990	5.040	0.050
100	106	4.998	4.922	-0.076
100	178	5.014	5.019	0.005
100	179	4.987	4.963	-0.025
100	180	5.018	4.948	-0.071
100	181	5.002	4.989	-0.013
100	182	5.010	5.018	0.008
Max		5.024	5.061	0.050
Average		5.003	4.998	-0.005
Min		4.982	4.922	-0.076
Std Dev		0.011	0.022	0.021

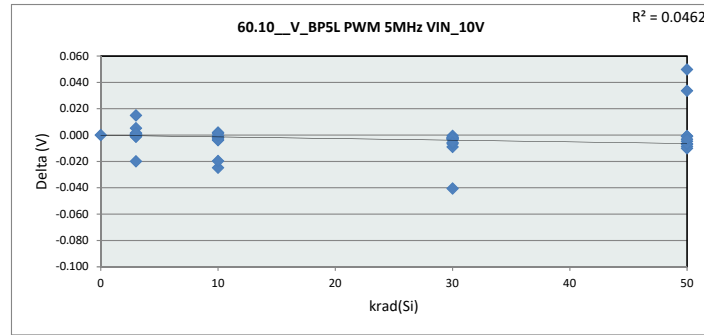

60.10_V_BP5L PWM

Test Site	DAL-FL
Tester	ETS364
Test Number	EB672302
Max Limit	5.175 V
Min Limit	4.75 V

krad(Si)	0	3	10	30	50	100
LL	4.750	4.750	4.750	4.750	4.750	4.750
Min	5.021	4.984	4.983	4.978	4.974	4.922
Average	5.021	4.996	4.998	5.003	5.005	4.985
Max	5.021	5.006	5.016	5.022	5.061	5.040
UL	5.175	5.175	5.175	5.175	5.175	5.175

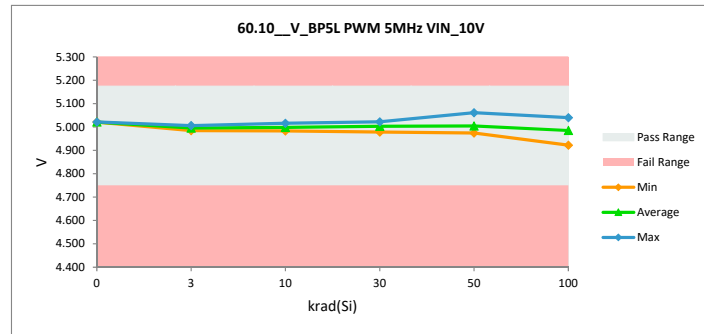

TID HDR Report
TPS7H6003-SP (5962R2220101VXC)

60.11_V_BP5H PWM 5MHz VIN		
Test Site	DAL-FL	DAL-FL
Tester	ETS364	ETS364
Test Number	EB672302	EB672302
Unit	V	V
Max Limit	5.175	5.175
Min Limit	4.75	4.75

krad(Si)	Serial #	pre_short (rtp)	(2)'ST_Combo (rpt)	Delta
0	Ctrl	5.021	5.021	0.000
3	58	5.023	5.023	-0.001
3	59	5.009	5.009	0.000
3	60	5.003	5.003	0.000
3	61	4.997	4.995	-0.002
3	62	4.990	4.989	-0.002
3	134	5.003	5.005	0.002
3	137	5.007	5.005	-0.002
3	138	4.988	5.005	0.017
3	139	4.997	4.998	0.001
3	236	5.009	5.011	0.002
10	63	4.990	4.988	-0.002
10	64	5.003	5.005	0.002
10	65	5.023	5.024	0.001
10	66	4.995	4.990	-0.004
10	150	5.010	5.008	-0.002
10	237	4.985	5.011	0.026
10	241	5.001	5.005	0.004
10	242	5.024	5.026	0.002
10	243	5.023	5.024	0.001
10	244	5.006	5.006	0.001
30	141	5.012	5.013	0.001
30	144	4.986	4.980	-0.006
30	145	5.014	5.010	-0.004
30	146	4.997	4.988	-0.009
30	147	4.999	4.996	-0.003
30	132	5.012	5.002	-0.010
30	133	5.001	5.003	0.002
30	135	5.007	4.990	-0.016
30	245	5.013	5.015	0.002
30	246	4.985	4.981	-0.004
50	67	5.012	5.015	0.003
50	68	5.002	5.009	0.007
50	69	4.992	4.988	-0.005
50	71	4.993	4.990	-0.003
50	72	4.985	4.986	0.001
50	172	4.996	4.990	-0.005
50	173	4.993	4.987	-0.006
50	174	5.005	4.995	-0.010
50	183	4.989	4.984	-0.005
50	186	4.991	4.987	-0.004
100	95	4.990	4.980	-0.010
100	102	4.987	4.995	0.008
100	104	5.008	5.030	0.022
100	105	5.001	5.024	0.023
100	106	4.993	4.966	-0.027
100	178	4.996	4.989	-0.007
100	179	4.999	4.996	-0.003
100	180	4.994	4.995	0.001
100	181	5.023	4.999	-0.024
100	182	5.013	5.040	0.026
Max		5.024	5.040	0.026
Average		5.002	5.001	0.000
Min		4.985	4.966	-0.027
Std Dev		0.011	0.015	0.010

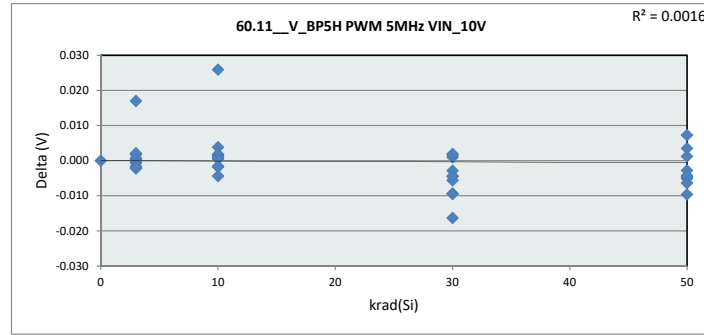

60.11_V_BP5H PW		
Test Site	DAL-FL	
Tester	ETS364	
Test Number	EB672302	
Max Limit	5.175	V
Min Limit	4.75	V

krad(Si)	0	3	10	30	50	100
LL	4.750	4.750	4.750	4.750	4.750	4.750
Min	5.021	4.989	4.988	4.980	4.984	4.966
Average	5.021	5.004	5.009	4.998	4.993	5.001
Max	5.021	5.023	5.026	5.015	5.015	5.040
UL	5.175	5.175	5.175	5.175	5.175	5.175

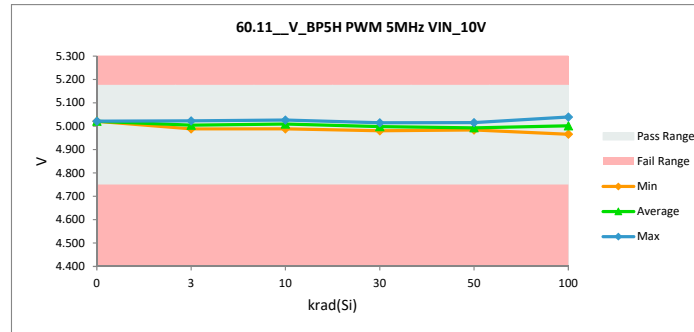

TID HDR Report

TPS7H6003-SP (5962R2220101VXC)

60.12_V_BP7L IIM 500kHz VIN		
Test Site	DAL-FL	DAL-FL
Tester	ETS364	ETS364
Test Number	EB672302	EB672302
Unit	V	V
Max Limit	7.35	7.35
Min Limit	6.65	6.65

krad(Si)	Serial #	pre_short (rtp)	(2)ST_Combo (rpt)	Delta
0	Ctrl	7.046	7.046	0.000
3	58	7.053	7.054	0.001
3	59	7.010	7.012	0.001
3	60	6.984	6.985	0.001
3	61	6.995	6.992	-0.003
3	62	6.974	6.972	-0.002
3	134	7.043	7.012	-0.031
3	137	6.949	7.012	0.063
3	138	7.038	7.011	-0.026
3	139	6.986	6.985	-0.001
3	236	6.983	7.000	0.017
10	63	6.984	6.981	-0.003
10	64	7.008	7.003	-0.004
10	65	7.034	7.036	0.002
10	66	7.029	7.027	-0.002
10	150	7.027	7.022	-0.005
10	237	7.020	7.000	-0.020
10	241	7.029	7.012	-0.017
10	242	7.002	7.003	0.001
10	243	7.004	7.003	-0.001
10	244	7.076	7.071	-0.005
30	141	7.043	7.041	-0.003
30	144	6.998	6.996	-0.001
30	145	7.040	7.039	-0.001
30	146	7.017	7.010	-0.007
30	147	7.021	7.014	-0.007
30	132	7.043	7.044	0.002
30	133	7.041	7.032	-0.009
30	135	7.003	7.038	0.035
30	245	6.998	6.994	-0.004
30	246	7.013	7.007	-0.006
50	67	7.044	7.040	-0.004
50	68	7.007	6.985	-0.022
50	69	7.044	7.050	0.006
50	71	6.991	6.985	-0.006
50	72	7.006	7.000	-0.006
50	172	7.024	6.990	-0.034
50	173	7.036	7.023	-0.013
50	174	7.012	7.015	0.003
50	183	7.018	7.018	0.000
50	186	6.987	6.989	0.002
100	95	7.001	7.028	0.027
100	102	6.955	6.948	-0.007
100	104	7.036	7.023	-0.013
100	105	7.022	6.997	-0.025
100	106	6.947	6.947	0.000
100	178	7.052	7.036	-0.016
100	179	6.988	7.033	0.045
100	180	7.023	7.010	-0.012
100	181	7.027	7.016	-0.011
100	182	7.029	7.055	0.026
	Max	7.076	7.071	0.063
	Average	7.015	7.013	-0.002
	Min	6.947	6.947	-0.034
	Std Dev	0.027	0.026	0.017

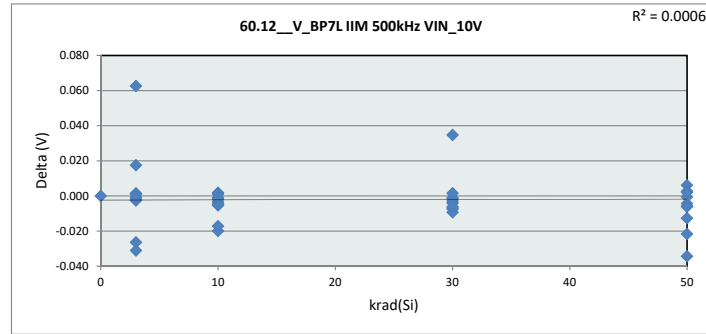

60.12_V_BP7L IIM		
Test Site	DAL-FL	
Tester	ETS364	
Test Number	EB672302	
Max Limit	7.35	V
Min Limit	6.65	V

krad(Si)	0	3	10	30	50	100
LL	6.650	6.650	6.650	6.650	6.650	6.650
Min	7.046	6.973	6.981	6.994	6.985	6.947
Average	7.046	7.004	7.016	7.021	7.010	7.009
Max	7.046	7.054	7.071	7.044	7.050	7.055
UL	7.350	7.350	7.350	7.350	7.350	7.350

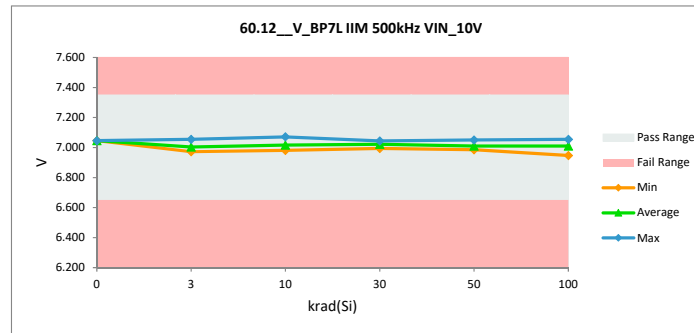

TID HDR Report
TPS7H6003-SP (5962R2220101VXC)

60.13_V_BP5L IIM 500kHz VIN		
Test Site	DAL-FL	DAL-FL
Tester	ETS364	ETS364
Test Number	EB672302	EB672302
Unit	V	V
Max Limit	5.175	5.175
Min Limit	4.75	4.75

krad(Si)	Serial #	pre_short (rtp)	(2)ST_Combo (rpt)	Delta
0	Ctrl	5.016	5.016	0.000
3	58	4.991	4.991	0.000
3	59	4.982	4.983	0.000
3	60	4.994	4.994	0.000
3	61	4.993	4.991	-0.001
3	62	5.004	5.004	0.001
3	134	4.989	4.995	0.006
3	137	4.980	4.995	0.015
3	138	4.997	4.995	-0.001
3	139	4.999	5.000	0.001
3	236	5.007	4.989	-0.018
10	63	5.004	5.001	-0.003
10	64	4.989	4.988	-0.001
10	65	5.016	5.014	-0.002
10	66	5.003	5.001	-0.002
10	150	4.996	4.991	-0.004
10	237	5.015	4.989	-0.026
10	241	5.015	4.995	-0.019
10	242	4.982	4.981	0.000
10	243	5.004	5.006	0.002
10	244	4.999	5.000	0.001
30	141	5.003	5.000	-0.003
30	144	5.014	5.014	-0.001
30	145	5.012	5.008	-0.004
30	146	4.993	4.984	-0.009
30	147	5.022	5.020	-0.002
30	132	4.993	4.991	-0.003
30	133	5.007	5.005	-0.002
30	135	5.017	4.979	-0.038
30	245	5.005	4.998	-0.007
30	246	5.020	5.015	-0.005
50	67	4.983	4.977	-0.005
50	68	4.988	5.023	0.035
50	69	5.009	5.003	-0.006
50	71	5.001	5.000	-0.001
50	72	5.001	4.991	-0.010
50	172	5.009	5.053	0.044
50	173	4.983	4.973	-0.010
50	174	5.011	5.008	-0.004
50	183	5.005	5.004	-0.002
50	186	4.990	4.987	-0.003
100	95	4.996	4.977	-0.019
100	102	5.004	5.001	-0.003
100	104	4.991	4.969	-0.023
100	105	4.988	5.034	0.046
100	106	4.996	4.925	-0.071
100	178	5.012	5.015	0.003
100	179	4.986	4.963	-0.023
100	180	5.017	4.950	-0.067
100	181	5.000	4.987	-0.013
100	182	5.008	5.015	0.007
Max		5.022	5.053	0.046
Average		5.001	4.996	-0.005
Min		4.980	4.925	-0.071
Std Dev		0.011	0.020	0.019

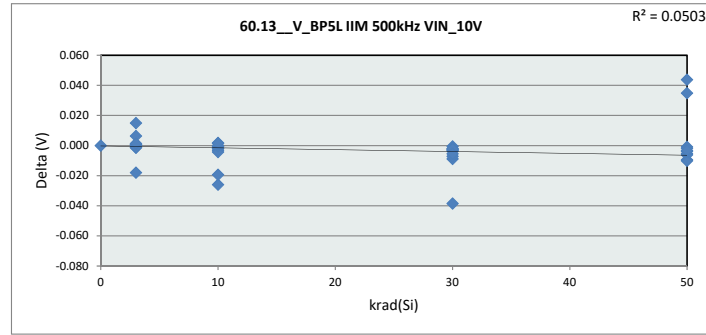

60.13_V_BP5L IIM						
Test Site	DAL-FL					
Tester	ETS364					
Test Number	EB672302					
Max Limit	5.175 V					
Min Limit	4.75 V					
krad(Si)	0	3	10	30	50	100
LL	4.750	4.750	4.750	4.750	4.750	4.750
Min	5.016	4.983	4.981	4.979	4.973	4.925
Average	5.016	4.994	4.997	5.001	5.002	4.984
Max	5.016	5.005	5.014	5.020	5.053	5.034
UL	5.175	5.175	5.175	5.175	5.175	5.175

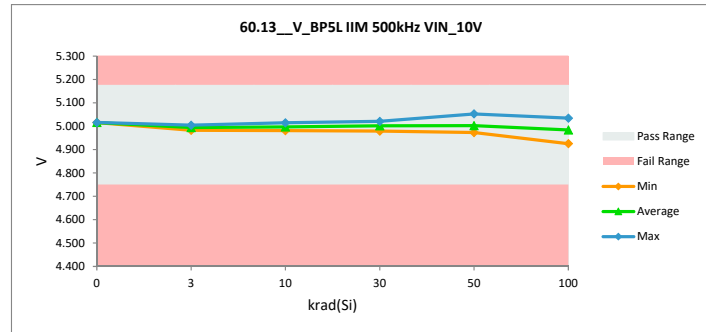

TID HDR Report
TPS7H6003-SP (5962R2220101VXC)

60.14_V_BP5H_IIM_500kHz_VIN		
Test Site	DAL-FL	DAL-FL
Tester	ETS364	ETS364
Test Number	EB672302	EB672302
Unit	V	V
Max Limit	5.175	5.175
Min Limit	4.75	4.75

krad(Si)	Serial #	pre_short (rtp)	(2)ST_Combo (rpt)	Delta
0	Ctrl	5.017	5.017	0.000
3	58	5.019	5.018	-0.001
3	59	5.006	5.005	-0.001
3	60	4.999	4.999	0.001
3	61	4.992	4.991	-0.001
3	62	4.986	4.985	-0.001
3	134	4.999	5.001	0.003
3	137	5.004	5.002	-0.002
3	138	4.984	5.001	0.017
3	139	4.994	4.995	0.001
3	236	5.004	5.007	0.003
10	63	4.986	4.984	-0.002
10	64	5.000	5.001	0.001
10	65	5.019	5.020	0.001
10	66	4.990	4.986	-0.004
10	150	5.006	5.004	-0.002
10	237	4.981	5.008	0.026
10	241	4.997	5.001	0.005
10	242	5.021	5.022	0.001
10	243	5.020	5.020	0.000
10	244	5.002	5.002	0.000
30	141	5.009	5.009	0.001
30	144	4.982	4.976	-0.006
30	145	5.011	5.006	-0.005
30	146	4.993	4.984	-0.009
30	147	4.996	4.993	-0.003
30	132	5.008	4.999	-0.009
30	133	4.998	4.999	0.001
30	135	5.004	4.987	-0.017
30	245	5.009	5.011	0.002
30	246	4.981	4.977	-0.004
50	67	5.009	5.010	0.002
50	68	4.998	5.005	0.007
50	69	4.988	4.983	-0.005
50	71	4.989	4.986	-0.003
50	72	4.982	4.982	0.000
50	172	4.992	4.985	-0.007
50	173	4.990	4.983	-0.007
50	174	5.000	4.991	-0.009
50	183	4.984	4.980	-0.005
50	186	4.986	4.982	-0.004
100	95	4.986	4.976	-0.010
100	102	4.983	4.989	0.006
100	104	5.004	5.024	0.020
100	105	4.998	5.018	0.021
100	106	4.989	4.961	-0.028
100	178	4.992	4.985	-0.008
100	179	4.995	4.992	-0.003
100	180	4.990	4.991	0.000
100	181	5.020	4.997	-0.023
100	182	5.010	5.033	0.023
	Max	5.021	5.033	0.026
	Average	4.998	4.997	-0.001
	Min	4.981	4.961	-0.028
	Std Dev	0.012	0.015	0.010

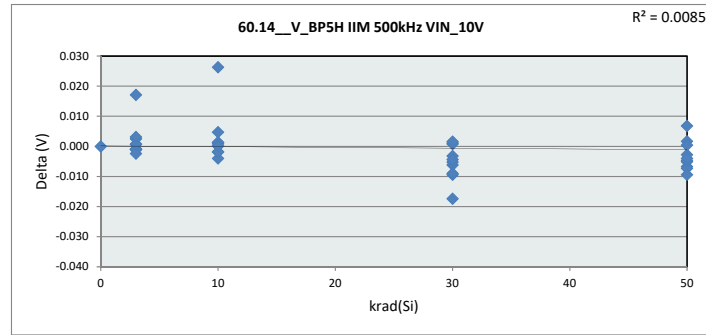

60.14_V_BP5H_IIM

Test Site	DAL-FL
Tester	ETS364
Test Number	EB672302
Max Limit	5.175 V
Min Limit	4.75 V

krad(Si)	0	3	10	30	50	100
LL	4.750	4.750	4.750	4.750	4.750	4.750
Min	5.017	4.985	4.984	4.976	4.980	4.961
Average	5.017	5.001	5.005	4.994	4.989	4.997
Max	5.017	5.019	5.022	5.011	5.010	5.033
UL	5.175	5.175	5.175	5.175	5.175	5.175

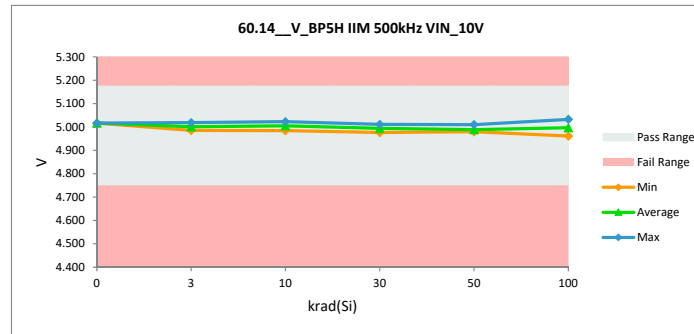

TID HDR Report
TPS7H6003-SP (5962R2220101VXC)

60.15_V_BP7L IIM 1MHz VIN_10V		
Test Site	DAL-FL	DAL-FL
Tester	ETS364	ETS364
Test Number	EB672302	EB672302
Unit	V	V
Max Limit	7.35	7.35
Min Limit	6.65	6.65

krad(Si)	Serial #	pre_short (rtp)	(2)ST_Combo (rpt)	Delta
0	Ctrl	7.042	7.042	0.000
3	58	7.048	7.050	0.002
3	59	7.006	7.008	0.001
3	60	6.979	6.980	0.001
3	61	6.990	6.988	-0.002
3	62	6.970	6.968	-0.002
3	134	7.039	7.008	-0.031
3	137	6.945	7.008	0.063
3	138	7.034	7.007	-0.026
3	139	6.982	6.981	-0.001
3	236	6.978	6.996	0.018
10	63	6.980	6.977	-0.003
10	64	7.003	6.999	-0.004
10	65	7.030	7.031	0.002
10	66	7.024	7.023	-0.002
10	150	7.022	7.017	-0.005
10	237	7.016	6.996	-0.020
10	241	7.024	7.008	-0.017
10	242	6.998	6.999	0.001
10	243	6.999	6.998	-0.001
10	244	7.072	7.067	-0.005
30	141	7.039	7.036	-0.003
30	144	6.993	6.992	-0.001
30	145	7.036	7.035	-0.001
30	146	7.013	7.005	-0.008
30	147	7.016	7.009	-0.007
30	132	7.038	7.040	0.001
30	133	7.037	7.028	-0.009
30	135	6.999	7.034	0.035
30	245	6.994	6.990	-0.004
30	246	7.009	7.002	-0.007
50	67	7.040	7.035	-0.005
50	68	7.002	6.980	-0.022
50	69	7.040	7.047	0.006
50	71	6.986	6.980	-0.006
50	72	7.002	6.996	-0.006
50	172	7.020	6.984	-0.036
50	173	7.032	7.019	-0.013
50	174	7.008	7.011	0.003
50	183	7.014	7.014	0.000
50	186	6.983	6.985	0.002
100	95	6.997	7.024	0.027
100	102	6.950	6.943	-0.007
100	104	7.031	7.017	-0.014
100	105	7.018	6.992	-0.026
100	106	6.943	6.942	-0.001
100	178	7.048	7.031	-0.017
100	179	6.983	7.030	0.046
100	180	7.018	7.005	-0.013
100	181	7.023	7.012	-0.010
100	182	7.024	7.052	0.028
Max		7.072	7.067	0.063
Average		7.010	7.008	-0.002
Min		6.943	6.942	-0.036
Std Dev		0.027	0.026	0.017

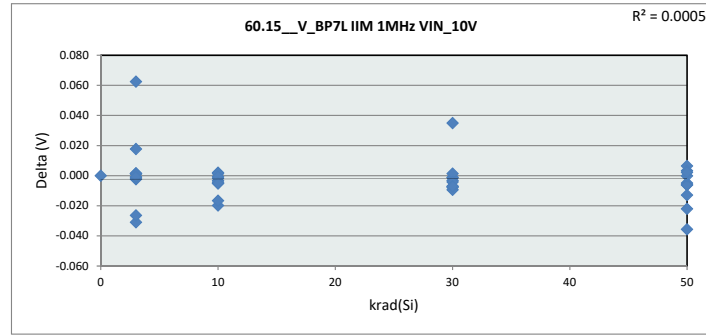

60.15_V_BP7L IIM		
Test Site	DAL-FL	
Tester	ETS364	
Test Number	EB672302	
Max Limit	7.35	V
Min Limit	6.65	V

krad(Si)	0	3	10	30	50	100
LL	6.650	6.650	6.650	6.650	6.650	6.650
Min	7.042	6.968	6.977	6.990	6.980	6.942
Average	7.042	6.999	7.012	7.017	7.005	7.005
Max	7.042	7.050	7.067	7.040	7.047	7.052
UL	7.350	7.350	7.350	7.350	7.350	7.350

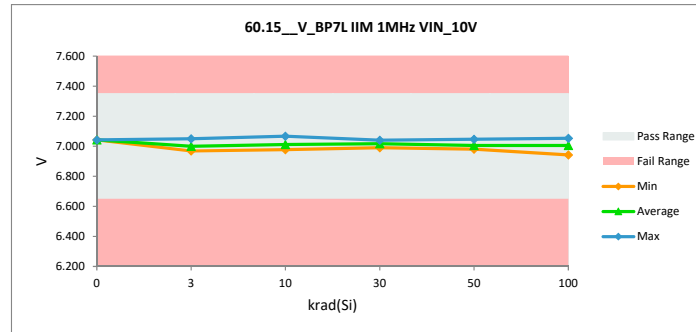

TID HDR Report
TPS7H6003-SP (5962R2220101VXC)

60.16_V_BP5L IIM 1MHz VIN		
Test Site	DAL-FL	DAL-FL
Tester	ETS364	ETS364
Test Number	EB672302	EB672302
Unit	V	V
Max Limit	5.175	5.175
Min Limit	4.75	4.75

krad(Si)	Serial #	pre_short (rtp)	(2)'ST_Combo (rpt)	Delta
0	Ctrl	5.017	5.017	0.000
3	58	4.993	4.993	0.000
3	59	4.984	4.984	0.000
3	60	4.996	4.996	0.000
3	61	4.995	4.994	-0.001
3	62	5.005	5.006	0.001
3	134	4.990	4.997	0.007
3	137	4.982	4.997	0.015
3	138	4.998	4.997	-0.001
3	139	5.001	5.002	0.001
3	236	5.009	4.991	-0.018
10	63	5.006	5.003	-0.003
10	64	4.990	4.990	0.000
10	65	5.017	5.016	-0.002
10	66	5.005	5.003	-0.002
10	150	4.997	4.993	-0.004
10	237	5.016	4.991	-0.026
10	241	5.016	4.997	-0.019
10	242	4.983	4.983	0.000
10	243	5.006	5.008	0.002
10	244	5.001	5.002	0.002
30	141	5.005	5.002	-0.003
30	144	5.016	5.016	0.000
30	145	5.013	5.010	-0.003
30	146	4.995	4.986	-0.009
30	147	5.024	5.022	-0.002
30	132	4.995	4.993	-0.002
30	133	5.009	5.007	-0.002
30	135	5.019	4.980	-0.039
30	245	5.007	5.000	-0.007
30	246	5.021	5.016	-0.005
50	67	4.984	4.979	-0.005
50	68	4.990	5.026	0.036
50	69	5.011	5.005	-0.006
50	71	5.003	5.002	-0.001
50	72	5.002	4.993	-0.009
50	172	5.011	5.056	0.045
50	173	4.985	4.975	-0.010
50	174	5.013	5.010	-0.003
50	183	5.007	5.006	-0.001
50	186	4.992	4.989	-0.003
100	95	4.998	4.979	-0.019
100	102	5.006	5.003	-0.003
100	104	4.993	4.970	-0.023
100	105	4.990	5.037	0.047
100	106	4.998	4.926	-0.072
100	178	5.015	5.018	0.004
100	179	4.988	4.965	-0.023
100	180	5.019	4.951	-0.068
100	181	5.002	4.989	-0.012
100	182	5.010	5.017	0.007
Max		5.024	5.056	0.047
Average		5.003	4.998	-0.005
Min		4.982	4.926	-0.072
Std Dev		0.011	0.020	0.020

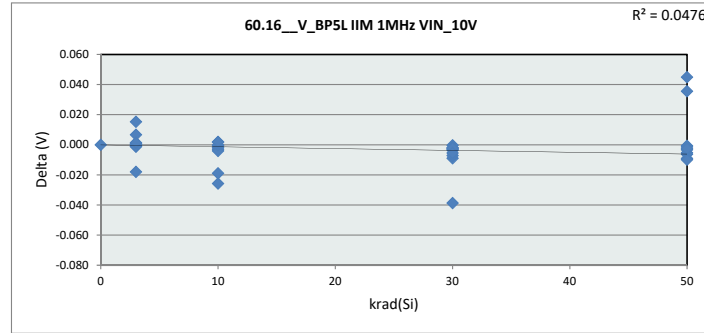

60.16_V_BP5L IIM		
Test Site	DAL-FL	
Tester	ETS364	
Test Number	EB672302	
Max Limit	5.175	V
Min Limit	4.75	V

krad(Si)	0	3	10	30	50	100
LL	4.750	4.750	4.750	4.750	4.750	4.750
Min	5.018	4.984	4.983	4.980	4.975	4.926
Average	5.018	4.996	4.999	5.003	5.004	4.986
Max	5.018	5.007	5.016	5.022	5.056	5.037
UL	5.175	5.175	5.175	5.175	5.175	5.175

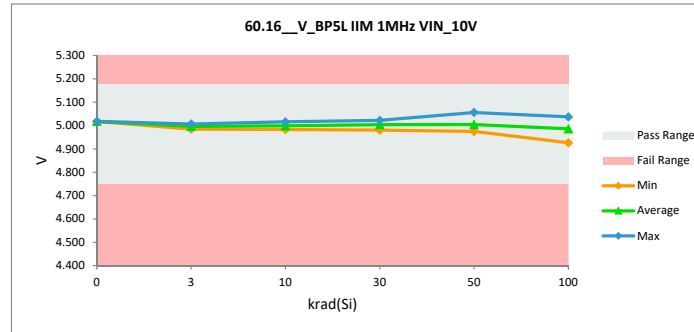

TID HDR Report
TPS7H6003-SP (5962R2220101VXC)

60.17_V_BP5H_IIM_1MHz_VIN		
Test Site	DAL-FL	DAL-FL
Tester	ETS364	ETS364
Test Number	EB672302	EB672302
Unit	V	V
Max Limit	5.175	5.175
Min Limit	4.75	4.75

krad(Si)	Serial #	pre_short (rtp)	(2)ST_Combo (rpt)	Delta
0	Ctrl	5.017	5.017	0.000
3	58	5.020	5.019	-0.001
3	59	5.007	5.006	-0.001
3	60	4.999	5.000	0.001
3	61	4.993	4.992	-0.001
3	62	4.987	4.986	-0.001
3	134	4.999	5.002	0.002
3	137	5.004	5.002	-0.002
3	138	4.985	5.002	0.017
3	139	4.995	4.995	0.001
3	236	5.005	5.008	0.003
10	63	4.986	4.985	-0.002
10	64	5.000	5.002	0.001
10	65	5.019	5.020	0.001
10	66	4.991	4.987	-0.004
10	150	5.006	5.005	-0.002
10	237	4.982	5.008	0.026
10	241	4.997	5.002	0.004
10	242	5.022	5.023	0.001
10	243	5.020	5.021	0.000
10	244	5.003	5.003	0.000
30	141	5.009	5.010	0.001
30	144	4.983	4.977	-0.006
30	145	5.011	5.006	-0.005
30	146	4.994	4.984	-0.009
30	147	4.997	4.994	-0.003
30	132	5.009	4.999	-0.009
30	133	4.998	4.999	0.001
30	135	5.005	4.987	-0.017
30	245	5.010	5.011	0.002
30	246	4.982	4.977	-0.004
50	67	5.009	5.011	0.002
50	68	4.999	5.005	0.007
50	69	4.989	4.984	-0.005
50	71	4.990	4.987	-0.003
50	72	4.982	4.983	0.001
50	172	4.992	4.986	-0.007
50	173	4.991	4.984	-0.007
50	174	5.001	4.991	-0.009
50	183	4.985	4.980	-0.005
50	186	4.987	4.983	-0.004
100	95	4.987	4.977	-0.010
100	102	4.984	4.989	0.005
100	104	5.005	5.025	0.020
100	105	4.998	5.020	0.021
100	106	4.990	4.962	-0.028
100	178	4.993	4.985	-0.008
100	179	4.996	4.993	-0.003
100	180	4.991	4.991	0.001
100	181	5.020	4.997	-0.023
100	182	5.010	5.034	0.023
	Max	5.022	5.034	0.026
	Average	4.999	4.998	-0.001
	Min	4.982	4.962	-0.028
	Std Dev	0.011	0.015	0.010

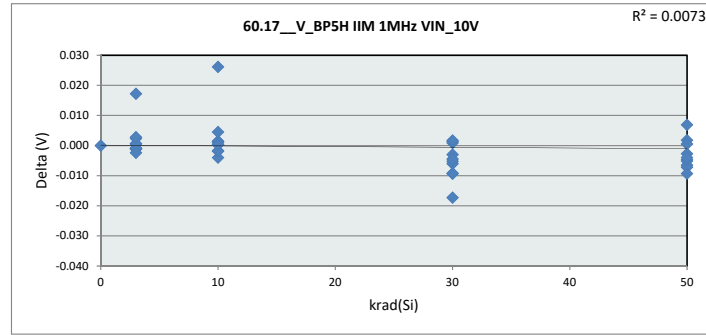

60.17_V_BP5H_IIM		
Test Site	DAL-FL	
Tester	ETS364	
Test Number	EB672302	
Max Limit	5.175	V
Min Limit	4.75	V

krad(Si)	0	3	10	30	50	100
LL	4.750	4.750	4.750	4.750	4.750	4.750
Min	5.017	4.986	4.985	4.977	4.980	4.962
Average	5.017	5.001	5.005	4.995	4.989	4.997
Max	5.017	5.019	5.023	5.011	5.011	5.034
UL	5.175	5.175	5.175	5.175	5.175	5.175

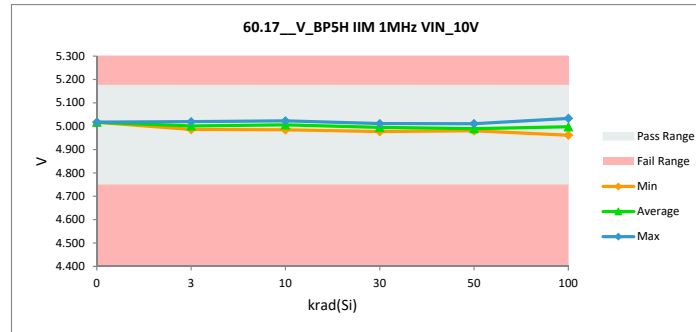

TID HDR Report
TPS7H6003-SP (5962R2220101VXC)

60.18_V_BP7L IIM 2MHz VIN_10V		
Test Site	DAL-FL	DAL-FL
Tester	ETS364	ETS364
Test Number	EB672302	EB672302
Unit	V	V
Max Limit	7.35	7.35
Min Limit	6.65	6.65

krad(Si)	Serial #	pre_short (rtp)	(2)'ST_Combo (rpt)	Delta
0	Ctrl	7.034	7.034	0.000
3	58	7.040	7.041	0.002
3	59	6.998	6.999	0.002
3	60	6.971	6.972	0.001
3	61	6.982	6.980	-0.002
3	62	6.962	6.960	-0.002
3	134	7.030	7.000	-0.031
3	137	6.937	7.000	0.063
3	138	7.026	6.999	-0.026
3	139	6.973	6.973	0.000
3	236	6.970	6.988	0.018
10	63	6.972	6.969	-0.003
10	64	6.995	6.991	-0.004
10	65	7.021	7.023	0.002
10	66	7.015	7.014	-0.002
10	150	7.014	7.008	-0.005
10	237	7.008	6.988	-0.020
10	241	7.016	7.000	-0.016
10	242	6.989	6.991	0.002
10	243	6.990	6.990	-0.001
10	244	7.064	7.059	-0.005
30	141	7.030	7.027	-0.003
30	144	6.985	6.983	-0.001
30	145	7.027	7.026	-0.001
30	146	7.005	6.997	-0.008
30	147	7.007	7.000	-0.007
30	132	7.030	7.032	0.002
30	133	7.029	7.018	-0.010
30	135	6.990	7.025	0.035
30	245	6.985	6.981	-0.004
30	246	7.000	6.991	-0.008
50	67	7.031	7.026	-0.006
50	68	6.993	6.971	-0.022
50	69	7.032	7.039	0.007
50	71	6.978	6.971	-0.007
50	72	6.994	6.987	-0.007
50	172	7.011	6.974	-0.037
50	173	7.023	7.010	-0.013
50	174	6.999	7.003	0.004
50	183	7.006	7.007	0.000
50	186	6.975	6.977	0.003
100	95	6.988	7.015	0.027
100	102	6.942	6.934	-0.008
100	104	7.023	7.008	-0.015
100	105	7.009	6.982	-0.027
100	106	6.934	6.933	-0.001
100	178	7.039	7.022	-0.017
100	179	6.975	7.023	0.047
100	180	7.009	6.997	-0.012
100	181	7.014	7.004	-0.010
100	182	7.016	7.043	0.027
Max		7.064	7.059	0.063
Average		7.002	7.000	-0.002
Min		6.934	6.933	-0.037
Std Dev		0.027	0.026	0.018

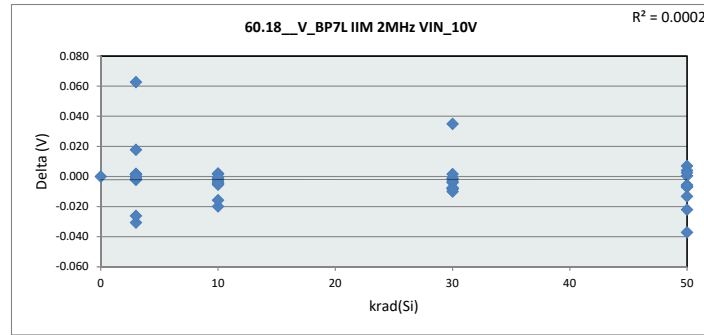

60.18_V_BP7L IIM		
Test Site	DAL-FL	
Tester	ETS364	
Test Number	EB672302	
Max Limit	7.35	V
Min Limit	6.65	V

krad(Si)	0	3	10	30	50	100
LL	6.650	6.650	6.650	6.650	6.650	6.650
Min	7.034	6.960	6.969	6.981	6.971	6.933
Average	7.034	6.991	7.003	7.008	6.996	6.996
Max	7.034	7.041	7.059	7.032	7.039	7.043
UL	7.350	7.350	7.350	7.350	7.350	7.350

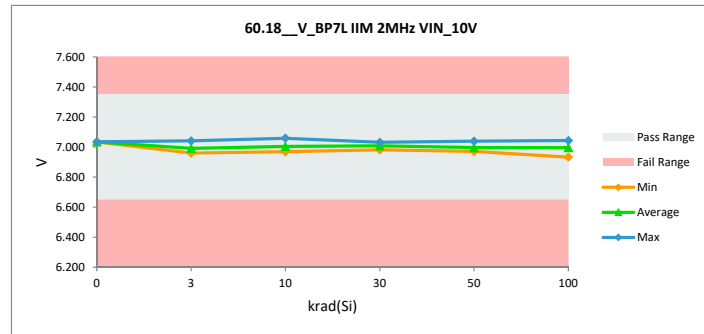

TID HDR Report
TPS7H6003-SP (5962R2220101VXC)

60.19_V_BP5L IIM 2MHz VIN		
Test Site	DAL-FL	DAL-FL
Tester	ETS364	ETS364
Test Number	EB672302	EB672302
Unit	V	V
Max Limit	5.175	5.175
Min Limit	4.75	4.75

krad(Si)	Serial #	pre_short (rtp)	(2)ST_Combo (rpt)	Delta
0	Ctrl	5.022	5.022	0.000
3	58	4.997	4.997	0.000
3	59	4.988	4.988	0.000
3	60	5.000	5.000	0.000
3	61	4.999	4.998	-0.001
3	62	5.009	5.010	0.001
3	134	4.994	5.002	0.008
3	137	4.986	5.002	0.016
3	138	5.002	5.002	0.000
3	139	5.004	5.006	0.002
3	236	5.012	4.995	-0.017
10	63	5.009	5.006	-0.003
10	64	4.994	4.993	0.000
10	65	5.021	5.019	-0.001
10	66	5.010	5.008	-0.002
10	150	5.001	4.997	-0.004
10	237	5.020	4.995	-0.025
10	241	5.020	5.002	-0.018
10	242	4.987	4.987	0.000
10	243	5.009	5.011	0.002
10	244	5.004	5.007	0.002
30	141	5.009	5.006	-0.003
30	144	5.020	5.020	0.000
30	145	5.017	5.014	-0.003
30	146	4.998	4.989	-0.009
30	147	5.028	5.026	-0.001
30	132	4.999	4.997	-0.002
30	133	5.013	5.011	-0.002
30	135	5.023	4.984	-0.039
30	245	5.011	5.004	-0.007
30	246	5.025	5.019	-0.005
50	67	4.988	4.983	-0.005
50	68	4.994	5.031	0.037
50	69	5.016	5.010	-0.006
50	71	5.007	5.007	0.000
50	72	5.006	4.997	-0.009
50	172	5.015	5.063	0.048
50	173	4.988	4.979	-0.009
50	174	5.017	5.015	-0.003
50	183	5.011	5.011	0.000
50	186	4.996	4.994	-0.002
100	95	5.002	4.983	-0.018
100	102	5.009	5.007	-0.002
100	104	4.996	4.974	-0.023
100	105	4.994	5.043	0.049
100	106	5.002	4.928	-0.074
100	178	5.019	5.025	0.006
100	179	4.991	4.969	-0.022
100	180	5.022	4.953	-0.069
100	181	5.005	4.994	-0.011
100	182	5.013	5.022	0.009
	Max	5.028	5.063	0.049
	Average	5.006	5.002	-0.004
	Min	4.986	4.928	-0.074
	Std Dev	0.011	0.021	0.020

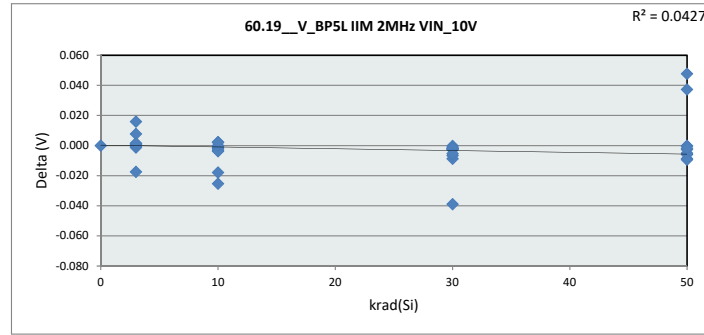

60.19_V_BP5L IIM		
Test Site	DAL-FL	
Tester	ETS364	
Test Number	EB672302	
Max Limit	5.175	V
Min Limit	4.75	V

krad(Si)	0	3	10	30	50	100
LL	4.750	4.750	4.750	4.750	4.750	4.750
Min	5.022	4.988	4.987	4.984	4.979	4.928
Average	5.022	5.000	5.002	5.007	5.009	4.990
Max	5.022	5.010	5.020	5.026	5.063	5.043
UL	5.175	5.175	5.175	5.175	5.175	5.175

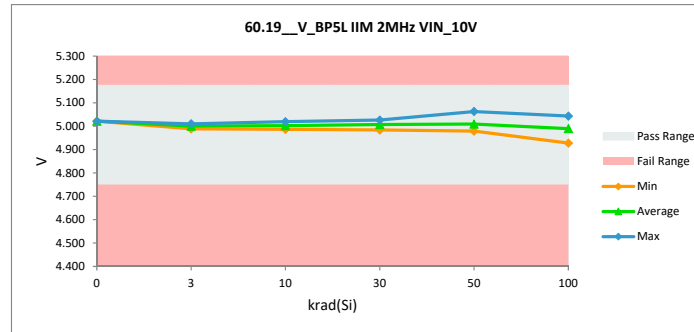

TID HDR Report
TPS7H6003-SP (5962R2220101VXC)

60.20_V_BP5H_IIM_2MHz_VIN		
Test Site	DAL-FL	DAL-FL
Tester	ETS364	ETS364
Test Number	EB672302	EB672302
Unit	V	V
Max Limit	5.175	5.175
Min Limit	4.75	4.75

krad(Si)	Serial #	pre_short (rtp)	(2)'ST_Combo (rpt)	Delta
0	Ctrl	5.018	5.018	0.000
3	58	5.021	5.020	-0.001
3	59	5.008	5.007	-0.001
3	60	5.001	5.001	0.000
3	61	4.994	4.993	-0.001
3	62	4.988	4.987	-0.001
3	134	5.001	5.003	0.003
3	137	5.006	5.003	-0.002
3	138	4.986	5.003	0.017
3	139	4.996	4.997	0.001
3	236	5.006	5.009	0.003
10	63	4.988	4.986	-0.002
10	64	5.001	5.003	0.002
10	65	5.021	5.022	0.001
10	66	4.992	4.988	-0.004
10	150	5.008	5.006	-0.002
10	237	4.983	5.009	0.026
10	241	4.999	5.003	0.004
10	242	5.023	5.024	0.002
10	243	5.022	5.022	0.000
10	244	5.004	5.004	0.000
30	141	5.010	5.011	0.001
30	144	4.984	4.978	-0.006
30	145	5.012	5.007	-0.005
30	146	4.995	4.986	-0.010
30	147	4.998	4.995	-0.003
30	132	5.009	5.000	-0.009
30	133	4.999	5.001	0.001
30	135	5.006	4.988	-0.017
30	245	5.011	5.013	0.002
30	246	4.983	4.978	-0.004
50	67	5.010	5.012	0.002
50	68	5.000	5.007	0.007
50	69	4.990	4.985	-0.005
50	71	4.990	4.988	-0.002
50	72	4.983	4.984	0.001
50	172	4.994	4.987	-0.006
50	173	4.992	4.985	-0.007
50	174	5.002	4.993	-0.009
50	183	4.986	4.981	-0.005
50	186	4.988	4.984	-0.004
100	95	4.988	4.978	-0.010
100	102	4.985	4.991	0.006
100	104	5.006	5.026	0.020
100	105	4.999	5.021	0.022
100	106	4.991	4.963	-0.028
100	178	4.994	4.986	-0.008
100	179	4.997	4.995	-0.002
100	180	4.992	4.992	0.000
100	181	5.021	4.998	-0.023
100	182	5.011	5.035	0.024
Max		5.023	5.035	0.026
Average		5.000	4.999	-0.001
Min		4.983	4.963	-0.028
Std Dev		0.011	0.015	0.010

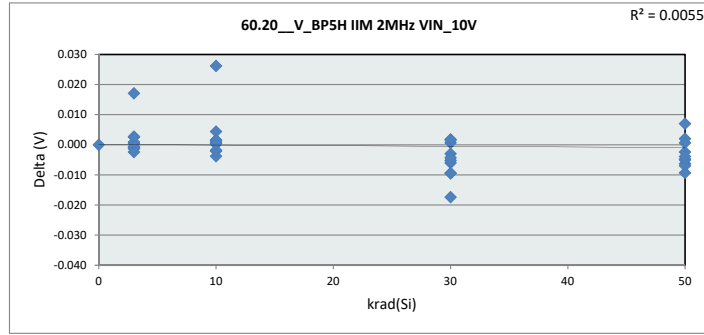

60.20_V_BP5H_IIM

Test Site	DAL-FL
Tester	ETS364
Test Number	EB672302
Max Limit	5.175 V
Min Limit	4.75 V

krad(Si)	0	3	10	30	50	100
LL	4.750	4.750	4.750	4.750	4.750	4.750
Min	5.018	4.987	4.986	4.978	4.981	4.963
Average	5.018	5.002	5.007	4.996	4.991	4.999
Max	5.018	5.020	5.024	5.013	5.012	5.035
UL	5.175	5.175	5.175	5.175	5.175	5.175

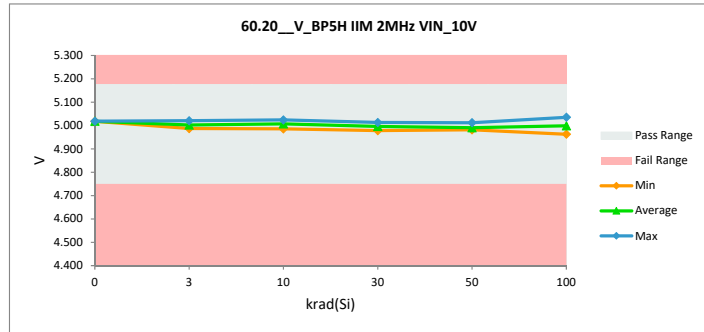

TID HDR Report
TPS7H6003-SP (5962R2220101VXC)

60.21_V_BP7L IIM 5MHz VIN		
Test Site	DAL-FL	DAL-FL
Tester	ETS364	ETS364
Test Number	EB672302	EB672302
Unit	V	V
Max Limit	7.35	7.35
Min Limit	6.65	6.65

krad(Si)	Serial #	pre_short (rtp)	(2)'ST_Combo (rpt)	Delta
0	Ctrl	7.011	7.011	0.000
3	58	7.014	7.017	0.003
3	59	6.974	6.977	0.003
3	60	6.946	6.948	0.003
3	61	6.957	6.957	-0.001
3	62	6.937	6.936	-0.001
3	134	7.006	6.977	-0.029
3	137	6.914	6.977	0.064
3	138	7.003	6.977	-0.025
3	139	6.949	6.950	0.001
3	236	6.944	6.964	0.020
10	63	6.949	6.946	-0.003
10	64	6.972	6.968	-0.005
10	65	6.995	6.997	0.002
10	66	6.988	6.987	-0.001
10	150	6.989	6.983	-0.006
10	237	6.983	6.964	-0.019
10	241	6.990	6.977	-0.012
10	242	6.965	6.968	0.003
10	243	6.964	6.965	0.001
10	244	7.039	7.036	-0.004
30	141	7.005	7.001	-0.003
30	144	6.960	6.959	-0.001
30	145	7.003	7.001	-0.002
30	146	6.982	6.972	-0.009
30	147	6.982	6.973	-0.009
30	132	7.006	7.008	0.002
30	133	7.004	6.993	-0.011
30	135	6.965	7.000	0.035
30	245	6.960	6.956	-0.004
30	246	6.974	6.964	-0.010
50	67	7.006	6.999	-0.007
50	68	6.966	6.945	-0.022
50	69	7.009	7.016	0.008
50	71	6.953	6.945	-0.008
50	72	6.969	6.962	-0.007
50	172	6.987	6.951	-0.037
50	173	6.997	6.984	-0.013
50	174	6.974	6.980	0.006
50	183	6.983	6.985	0.002
50	186	6.951	6.955	0.003
100	95	6.964	6.988	0.024
100	102	6.916	6.907	-0.009
100	104	6.997	6.981	-0.016
100	105	6.985	6.956	-0.029
100	106	6.910	6.907	-0.003
100	178	7.013	6.997	-0.015
100	179	6.951	6.999	0.048
100	180	6.984	6.973	-0.012
100	181	6.989	6.981	-0.008
100	182	6.991	7.021	0.030
	Max	7.039	7.036	0.064
	Average	6.977	6.975	-0.002
	Min	6.910	6.907	-0.037
	Std Dev	0.027	0.026	0.018

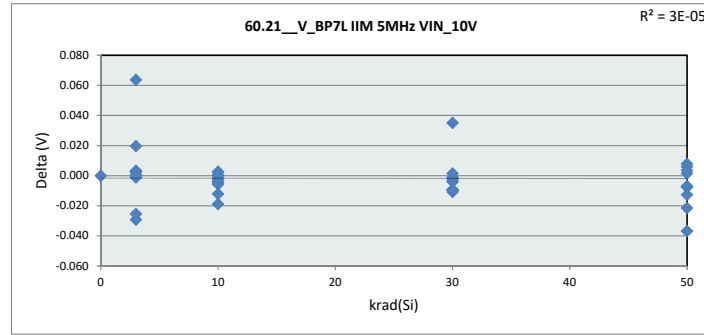

60.21_V_BP7L IIM		
Test Site	DAL-FL	
Tester	ETS364	
Test Number	EB672302	
Max Limit	7.35	V
Min Limit	6.65	V

krad(Si)	0	3	10	30	50	100
LL	6.650	6.650	6.650	6.650	6.650	6.650
Min	7.012	6.936	6.946	6.956	6.945	6.907
Average	7.012	6.968	6.979	6.983	6.972	6.971
Max	7.012	7.018	7.036	7.008	7.016	7.021
UL	7.350	7.350	7.350	7.350	7.350	7.350

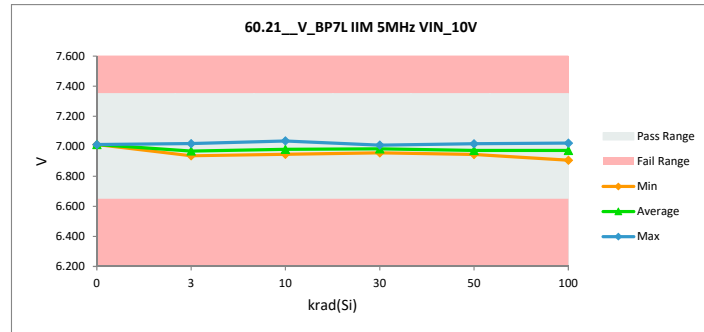

TID HDR Report
TPS7H6003-SP (5962R2220101VXC)

60.22_V_BP5L IIM 5MHz VIN		
Test Site	DAL-FL	DAL-FL
Tester	ETS364	ETS364
Test Number	EB672302	EB672302
Unit	V	V
Max Limit	5.175	5.175
Min Limit	4.75	4.75

krad(Si)	Serial #	pre_short (rtp)	(2)'ST_Combo (rpt)	Delta
0	Ctrl	5.036	5.036	0.000
3	58	5.010	5.011	0.000
3	59	5.001	5.002	0.000
3	60	5.014	5.014	-0.001
3	61	5.015	5.013	-0.002
3	62	5.022	5.024	0.002
3	134	5.006	5.017	0.011
3	137	4.999	5.017	0.019
3	138	5.016	5.018	0.002
3	139	5.017	5.019	0.002
3	236	5.024	5.008	-0.016
10	63	5.021	5.018	-0.003
10	64	5.005	5.006	0.001
10	65	5.033	5.033	-0.001
10	66	5.025	5.024	-0.001
10	150	5.015	5.012	-0.003
10	237	5.032	5.009	-0.023
10	241	5.032	5.018	-0.014
10	242	4.999	5.000	0.001
10	243	5.021	5.025	0.004
10	244	5.018	5.023	0.004
30	141	5.023	5.022	-0.001
30	144	5.033	5.034	0.001
30	145	5.028	5.027	-0.001
30	146	5.010	5.002	-0.008
30	147	5.040	5.040	0.001
30	132	5.012	5.012	0.000
30	133	5.026	5.024	-0.001
30	135	5.036	4.996	-0.040
30	245	5.024	5.019	-0.005
30	246	5.036	5.032	-0.004
50	67	5.001	4.998	-0.004
50	68	5.007	5.050	0.043
50	69	5.030	5.025	-0.005
50	71	5.021	5.022	0.002
50	72	5.018	5.011	-0.007
50	172	5.030	5.087	0.057
50	173	5.002	4.994	-0.007
50	174	5.032	5.033	0.001
50	183	5.025	5.028	0.004
50	186	5.008	5.010	0.002
100	95	5.014	4.998	-0.016
100	102	5.021	5.023	0.002
100	104	5.009	4.986	-0.023
100	105	5.007	5.063	0.056
100	106	5.014	4.933	-0.080
100	178	5.033	5.047	0.014
100	179	5.004	4.982	-0.021
100	180	5.035	4.962	-0.073
100	181	5.019	5.010	-0.009
100	182	5.026	5.040	0.014
	Max	5.040	5.087	0.057
	Average	5.019	5.017	-0.002
	Min	4.999	4.933	-0.080
	Std Dev	0.011	0.023	0.022

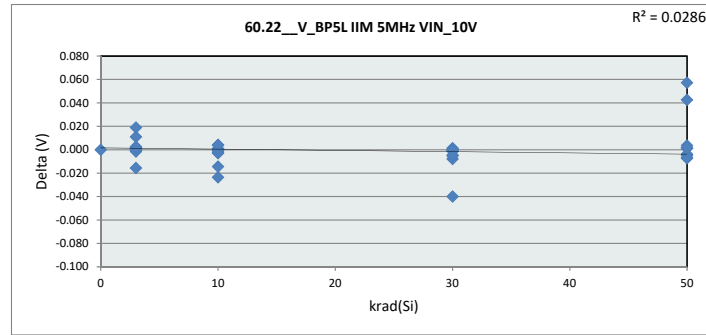

60.22_V_BP5L IIM		
Test Site	DAL-FL	
Tester	ETS364	
Test Number	EB672302	
Max Limit	5.175	V
Min Limit	4.75	V

krad(Si)	0	3	10	30	50	100
LL	4.750	4.750	4.750	4.750	4.750	4.750
Min	5.036	5.002	5.000	4.996	4.994	4.933
Average	5.036	5.014	5.017	5.021	5.026	5.004
Max	5.036	5.024	5.033	5.040	5.087	5.063
UL	5.175	5.175	5.175	5.175	5.175	5.175

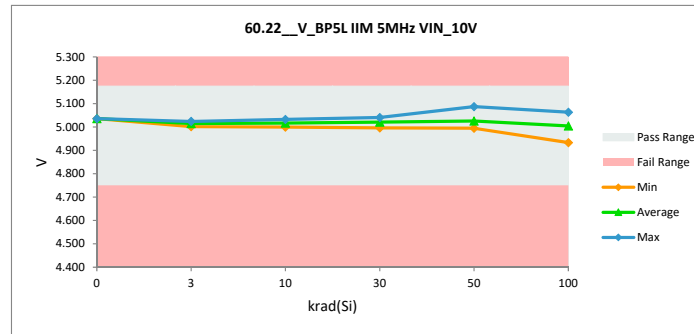

TID HDR Report
TPS7H6003-SP (5962R2220101VXC)

60.23_V_BP5H_IIM_5MHz_VIN		
Test Site	DAL-FL	DAL-FL
Tester	ETS364	ETS364
Test Number	EB672302	EB672302
Unit	V	V
Max Limit	5.175	5.175
Min Limit	4.75	4.75

krad(Si)	Serial #	pre_short (rtp)	(2)'ST_Combo (rpt)	Delta
0	Ctrl	5.022	5.022	0.000
3	58	5.025	5.024	-0.001
3	59	5.011	5.010	-0.001
3	60	5.005	5.005	0.000
3	61	4.997	4.997	-0.001
3	62	4.992	4.990	-0.001
3	134	5.004	5.007	0.003
3	137	5.009	5.007	-0.002
3	138	4.989	5.007	0.018
3	139	4.999	5.001	0.001
3	236	5.010	5.012	0.003
10	63	4.991	4.989	-0.002
10	64	5.005	5.007	0.002
10	65	5.024	5.025	0.001
10	66	4.995	4.991	-0.003
10	150	5.011	5.010	-0.001
10	237	4.986	5.012	0.026
10	241	5.003	5.007	0.004
10	242	5.026	5.028	0.002
10	243	5.025	5.025	0.000
10	244	5.008	5.009	0.001
30	141	5.014	5.015	0.001
30	144	4.987	4.981	-0.006
30	145	5.016	5.011	-0.005
30	146	4.999	4.989	-0.010
30	147	5.001	4.999	-0.003
30	132	5.013	5.002	-0.010
30	133	5.002	5.004	0.002
30	135	5.009	4.991	-0.017
30	245	5.014	5.017	0.002
30	246	4.986	4.982	-0.004
50	67	5.013	5.016	0.003
50	68	5.004	5.012	0.008
50	69	4.994	4.989	-0.004
50	71	4.994	4.992	-0.002
50	72	4.987	4.988	0.002
50	172	4.997	4.992	-0.005
50	173	4.995	4.989	-0.006
50	174	5.006	4.997	-0.009
50	183	4.990	4.985	-0.005
50	186	4.992	4.989	-0.003
100	95	4.992	4.983	-0.009
100	102	4.989	4.995	0.007
100	104	5.010	5.031	0.021
100	105	5.003	5.026	0.024
100	106	4.994	4.966	-0.028
100	178	4.997	4.990	-0.007
100	179	5.000	4.999	-0.001
100	180	4.995	4.996	0.001
100	181	5.025	5.001	-0.024
100	182	5.015	5.041	0.027
	Max	5.026	5.041	0.027
	Average	5.003	5.003	0.000
	Min	4.986	4.966	-0.028
	Std Dev	0.011	0.015	0.010

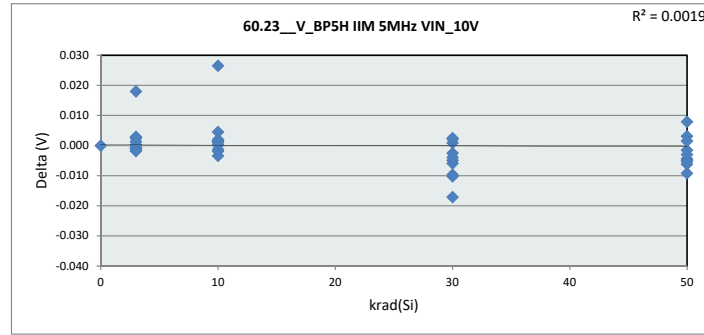

60.23_V_BP5H_IIM

Test Site	DAL-FL
Tester	ETS364
Test Number	EB672302
Max Limit	5.175 V
Min Limit	4.75 V

krad(Si)	0	3	10	30	50	100
LL	4.750	4.750	4.750	4.750	4.750	4.750
Min	5.022	4.991	4.989	4.981	4.985	4.966
Average	5.022	5.006	5.010	4.999	4.995	5.003
Max	5.022	5.024	5.028	5.017	5.016	5.041
UL	5.175	5.175	5.175	5.175	5.175	5.175

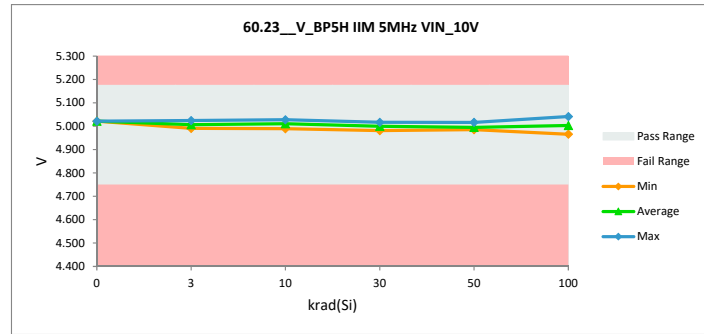

TID HDR Report
TPS7H6003-SP (5962R2220101VXC)

61.0_V_BP7L PWM 500kHz VIN		
Test Site	DAL-FL	DAL-FL
Tester	ETS364	ETS364
Test Number	EB672302	EB672302
Unit	V	V
Max Limit	7.35	7.35
Min Limit	6.65	6.65

krad(Si)	Serial #	pre_short (rtp)	(2)'ST_Combo (rpt)	Delta
0	Ctrl	7.047	7.047	0.000
3	58	7.053	7.055	0.001
3	59	7.011	7.012	0.001
3	60	6.984	6.986	0.001
3	61	6.995	6.992	-0.003
3	62	6.975	6.973	-0.002
3	134	7.043	7.012	-0.031
3	137	6.950	7.012	0.063
3	138	7.038	7.012	-0.026
3	139	6.986	6.986	-0.001
3	236	6.983	7.001	0.018
10	63	6.985	6.982	-0.003
10	64	7.008	7.004	-0.005
10	65	7.035	7.037	0.002
10	66	7.030	7.028	-0.002
10	150	7.028	7.022	-0.005
10	237	7.021	7.001	-0.020
10	241	7.029	7.012	-0.017
10	242	7.003	7.004	0.001
10	243	7.004	7.003	-0.001
10	244	7.077	7.072	-0.005
30	141	7.044	7.041	-0.003
30	144	6.998	6.997	-0.001
30	145	7.041	7.040	-0.001
30	146	7.018	7.010	-0.008
30	147	7.021	7.014	-0.007
30	132	7.043	7.045	0.001
30	133	7.042	7.033	-0.009
30	135	7.004	7.039	0.035
30	245	6.999	6.995	-0.004
30	246	7.014	7.008	-0.006
50	67	7.045	7.041	-0.004
50	68	7.008	6.986	-0.022
50	69	7.045	7.050	0.006
50	71	6.991	6.986	-0.006
50	72	7.007	7.001	-0.006
50	172	7.025	6.990	-0.034
50	173	7.037	7.024	-0.013
50	174	7.013	7.015	0.002
50	183	7.019	7.019	0.000
50	186	6.988	6.990	0.002
100	95	7.002	7.029	0.027
100	102	6.955	6.948	-0.007
100	104	7.037	7.023	-0.013
100	105	7.023	6.998	-0.025
100	106	6.948	6.947	-0.001
100	178	7.053	7.036	-0.017
100	179	6.988	7.033	0.045
100	180	7.023	7.011	-0.012
100	181	7.028	7.017	-0.011
100	182	7.030	7.056	0.026
	Max	7.077	7.072	0.063
	Average	7.015	7.013	-0.002
	Min	6.948	6.947	-0.034
	Std Dev	0.027	0.026	0.017

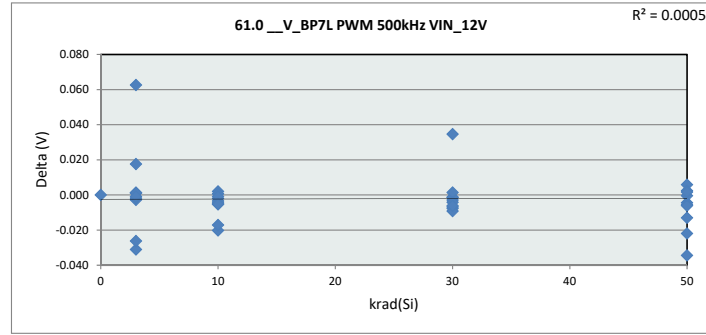

61.0_V_BP7L PWM		
Test Site	DAL-FL	
Tester	ETS364	
Test Number	EB672302	
Max Limit	7.35	V
Min Limit	6.65	V

krad(Si)	0	3	10	30	50	100
LL	6.650	6.650	6.650	6.650	6.650	6.650
Min	7.047	6.973	6.982	6.995	6.986	6.947
Average	7.047	7.004	7.016	7.022	7.010	7.010
Max	7.047	7.055	7.072	7.045	7.051	7.056
UL	7.350	7.350	7.350	7.350	7.350	7.350

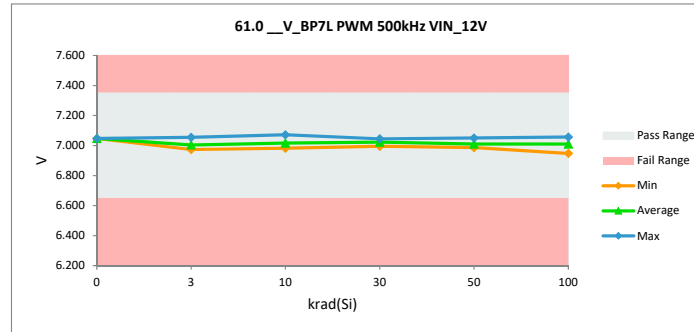

TID HDR Report
TPS7H6003-SP (5962R2220101VXC)

61.1 V_BPSL PWM 500kHz VIN		
Test Site	DAL-FL	DAL-FL
Tester	ETS364	ETS364
Test Number	EB672302	EB672302
Unit	V	V
Max Limit	5.175	5.175
Min Limit	4.75	4.75

krad(Si)	Serial #	pre_short (rtp)	(2)'ST_Combo (rpt)	Delta
0	Ctrl	5.016	5.016	0.000
3	58	4.991	4.992	0.001
3	59	4.983	4.983	0.000
3	60	4.994	4.995	0.000
3	61	4.993	4.992	-0.001
3	62	5.004	5.005	0.001
3	134	4.989	4.996	0.006
3	137	4.981	4.996	0.015
3	138	4.997	4.996	-0.001
3	139	4.999	5.001	0.001
3	236	5.007	4.989	-0.018
10	63	5.004	5.001	-0.003
10	64	4.989	4.988	0.000
10	65	5.016	5.015	-0.002
10	66	5.004	5.001	-0.002
10	150	4.996	4.991	-0.004
10	237	5.015	4.989	-0.026
10	241	5.015	4.996	-0.019
10	242	4.982	4.981	0.000
10	243	5.004	5.006	0.002
10	244	4.999	5.000	0.002
30	141	5.004	5.001	-0.003
30	144	5.015	5.014	-0.001
30	145	5.012	5.008	-0.004
30	146	4.993	4.984	-0.009
30	147	5.023	5.021	-0.002
30	132	4.993	4.991	-0.003
30	133	5.008	5.005	-0.002
30	135	5.017	4.979	-0.038
30	245	5.005	4.998	-0.007
30	246	5.020	5.015	-0.005
50	67	4.983	4.978	-0.005
50	68	4.989	5.023	0.035
50	69	5.010	5.003	-0.006
50	71	5.002	5.001	-0.001
50	72	5.001	4.992	-0.010
50	172	5.009	5.053	0.044
50	173	4.983	4.973	-0.010
50	174	5.012	5.008	-0.004
50	183	5.006	5.004	-0.002
50	186	4.991	4.987	-0.003
100	95	4.997	4.978	-0.019
100	102	5.005	5.002	-0.003
100	104	4.991	4.969	-0.022
100	105	4.989	5.034	0.046
100	106	4.997	4.926	-0.071
100	178	5.013	5.016	0.003
100	179	4.986	4.964	-0.022
100	180	5.017	4.951	-0.067
100	181	5.000	4.988	-0.013
100	182	5.009	5.015	0.006
Max		5.023	5.053	0.046
Average		5.001	4.996	-0.005
Min		4.981	4.926	-0.071
Std Dev		0.011	0.020	0.019

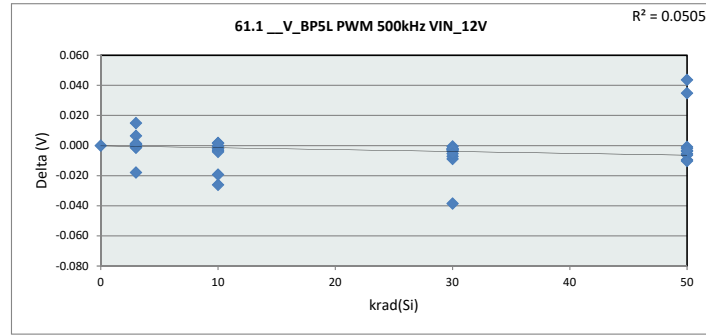

61.1 V_BPSL PWM		
Test Site	DAL-FL	
Tester	ETS364	
Test Number	EB672302	
Max Limit	5.175	V
Min Limit	4.75	V

krad(Si)	0	3	10	30	50	100
LL	4.750	4.750	4.750	4.750	4.750	4.750
Min	5.016	4.983	4.981	4.979	4.973	4.926
Average	5.016	4.994	4.997	5.002	5.002	4.984
Max	5.016	5.005	5.015	5.021	5.053	5.034
UL	5.175	5.175	5.175	5.175	5.175	5.175

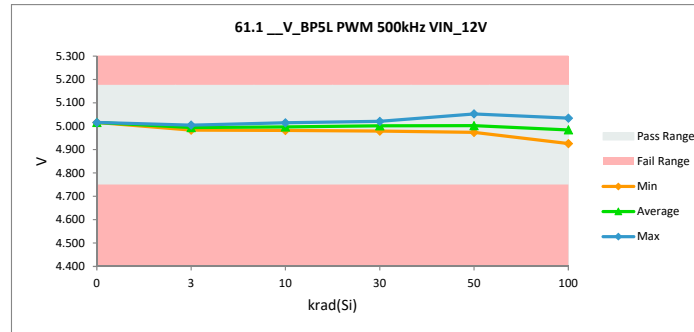

TID HDR Report
TPS7H6003-SP (5962R2220101VXC)

61.2_V_BP5H PWM 500kHz VI		
Test Site	DAL-FL	DAL-FL
Tester	ETS364	ETS364
Test Number	EB672302	EB672302
Unit	V	V
Max Limit	5.175	5.175
Min Limit	4.75	4.75

krad(Si)	Serial #	pre_short (rtp)	(2)'ST_Combo (rpt)	Delta
0	Ctrl	5.017	5.017	0.000
3	58	5.019	5.019	-0.001
3	59	5.006	5.005	-0.001
3	60	4.999	4.999	0.000
3	61	4.992	4.992	-0.001
3	62	4.986	4.985	-0.001
3	134	4.999	5.002	0.003
3	137	5.004	5.002	-0.002
3	138	4.984	5.001	0.017
3	139	4.994	4.995	0.001
3	236	5.004	5.008	0.003
10	63	4.986	4.984	-0.002
10	64	5.000	5.001	0.001
10	65	5.019	5.020	0.001
10	66	4.990	4.986	-0.004
10	150	5.006	5.004	-0.002
10	237	4.981	5.008	0.026
10	241	4.997	5.001	0.005
10	242	5.021	5.022	0.001
10	243	5.020	5.020	0.000
10	244	5.002	5.003	0.000
30	141	5.009	5.010	0.001
30	144	4.982	4.976	-0.006
30	145	5.011	5.006	-0.005
30	146	4.993	4.984	-0.009
30	147	4.996	4.993	-0.003
30	132	5.008	4.999	-0.009
30	133	4.998	4.999	0.001
30	135	5.004	4.987	-0.017
30	245	5.009	5.011	0.002
30	246	4.981	4.977	-0.004
50	67	5.009	5.010	0.002
50	68	4.998	5.005	0.007
50	69	4.988	4.983	-0.005
50	71	4.989	4.986	-0.003
50	72	4.982	4.982	0.000
50	172	4.992	4.985	-0.007
50	173	4.990	4.983	-0.007
50	174	5.000	4.991	-0.009
50	183	4.984	4.980	-0.005
50	186	4.987	4.982	-0.004
100	95	4.986	4.976	-0.011
100	102	4.983	4.989	0.005
100	104	5.004	5.023	0.019
100	105	4.998	5.018	0.020
100	106	4.989	4.961	-0.028
100	178	4.992	4.985	-0.008
100	179	4.996	4.993	-0.002
100	180	4.990	4.991	0.000
100	181	5.020	4.997	-0.023
100	182	5.010	5.032	0.022
Max		5.021	5.032	0.026
Average		4.998	4.997	-0.001
Min		4.981	4.961	-0.028
Std Dev		0.012	0.015	0.010

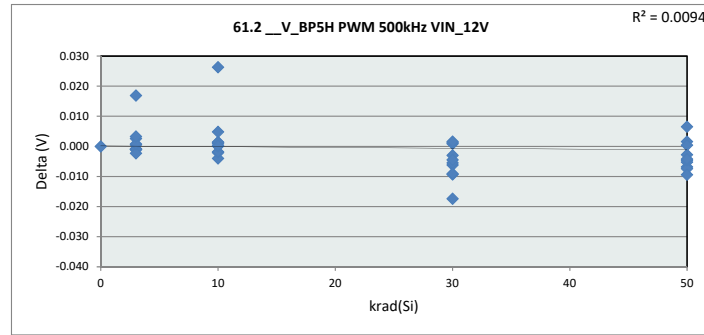

61.2_V_BP5H PWM		
Test Site	DAL-FL	
Tester	ETS364	
Test Number	EB672302	
Max Limit	5.175	V
Min Limit	4.75	V

krad(Si)	0	3	10	30	50	100
LL	4.750	4.750	4.750	4.750	4.750	4.750
Min	5.017	4.985	4.984	4.976	4.980	4.961
Average	5.017	5.001	5.005	4.994	4.989	4.997
Max	5.017	5.019	5.022	5.011	5.010	5.032
UL	5.175	5.175	5.175	5.175	5.175	5.175

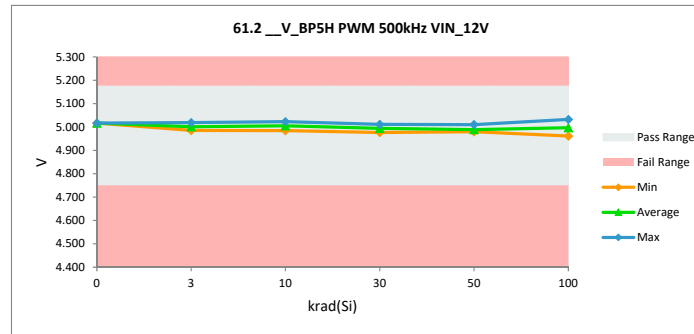

TID HDR Report
TPS7H6003-SP (5962R2220101VXC)

61.3 V_BP7L PWM 1MHz VIN		
Test Site	DAL-FL	DAL-FL
Tester	ETS364	ETS364
Test Number	EB672302	EB672302
Unit	V	V
Max Limit	7.35	7.35
Min Limit	6.65	6.65

krad(Si)	Serial #	pre_short (rtp)	(2)ST_Combo (rpt)	Delta
0	Ctrl	7.043	7.043	0.000
3	58	7.049	7.051	0.001
3	59	7.007	7.008	0.001
3	60	6.981	6.982	0.001
3	61	6.991	6.989	-0.003
3	62	6.971	6.969	-0.002
3	134	7.040	7.009	-0.031
3	137	6.946	7.009	0.062
3	138	7.035	7.008	-0.026
3	139	6.983	6.982	-0.001
3	236	6.979	6.997	0.018
10	63	6.981	6.978	-0.003
10	64	7.004	7.000	-0.004
10	65	7.031	7.033	0.002
10	66	7.026	7.024	-0.002
10	150	7.023	7.018	-0.005
10	237	7.017	6.997	-0.020
10	241	7.025	7.009	-0.017
10	242	6.999	7.000	0.001
10	243	7.000	6.999	-0.001
10	244	7.073	7.068	-0.005
30	141	7.040	7.037	-0.003
30	144	6.995	6.993	-0.002
30	145	7.037	7.035	-0.001
30	146	7.014	7.006	-0.008
30	147	7.017	7.010	-0.007
30	132	7.040	7.041	0.001
30	133	7.038	7.029	-0.009
30	135	7.000	7.035	0.035
30	245	6.995	6.991	-0.004
30	246	7.010	7.003	-0.007
50	67	7.041	7.036	-0.005
50	68	7.003	6.981	-0.022
50	69	7.041	7.047	0.006
50	71	6.988	6.982	-0.006
50	72	7.003	6.997	-0.006
50	172	7.021	6.985	-0.035
50	173	7.033	7.020	-0.013
50	174	7.009	7.012	0.003
50	183	7.015	7.015	0.000
50	186	6.984	6.986	0.002
100	95	6.998	7.025	0.027
100	102	6.951	6.944	-0.007
100	104	7.032	7.019	-0.014
100	105	7.019	6.993	-0.026
100	106	6.944	6.943	-0.001
100	178	7.049	7.032	-0.016
100	179	6.984	7.030	0.046
100	180	7.019	7.006	-0.013
100	181	7.024	7.014	-0.010
100	182	7.026	7.053	0.028
	Max	7.073	7.068	0.062
	Average	7.011	7.009	-0.002
	Min	6.944	6.943	-0.035
	Std Dev	0.027	0.026	0.017

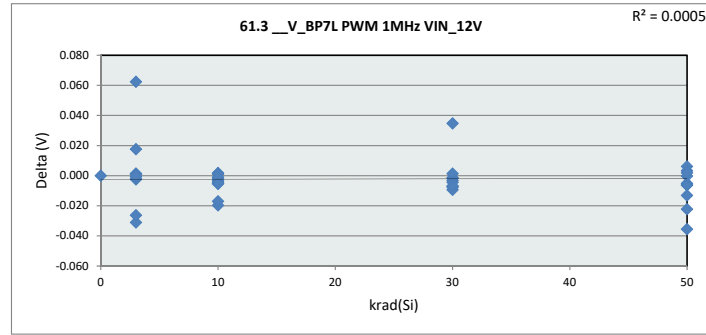

61.3 V_BP7L PWM		
Test Site	DAL-FL	
Tester	ETS364	
Test Number	EB672302	
Max Limit	7.35	V
Min Limit	6.65	V

krad(Si)	0	3	10	30	50	100
LL	6.650	6.650	6.650	6.650	6.650	6.650
Min	7.043	6.969	6.978	6.991	6.981	6.943
Average	7.043	7.000	7.013	7.018	7.006	7.006
Max	7.043	7.051	7.068	7.041	7.047	7.053
UL	7.350	7.350	7.350	7.350	7.350	7.350

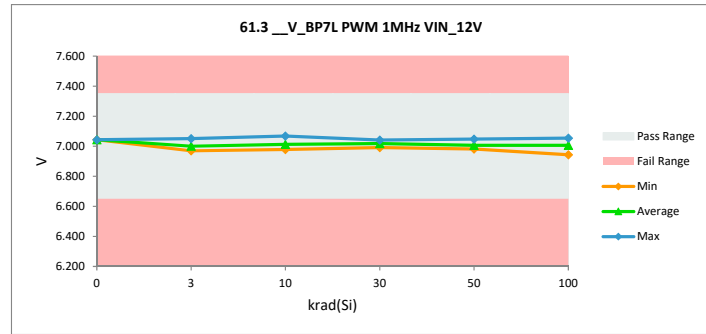

TID HDR Report
TPS7H6003-SP (5962R2220101VXC)

61.4 _V_BP5L PWM 1MHz VIN		
Test Site	DAL-FL	DAL-FL
Tester	ETS364	ETS364
Test Number	EB672302	EB672302
Unit	V	V
Max Limit	5.175	5.175
Min Limit	4.75	4.75

krad(Si)	Serial #	pre_short (rtp)	(2)'ST_Combo (rpt) (Delta
0	Ctrl	5.018	5.018	0.000
3	58	4.994	4.994	0.000
3	59	4.985	4.985	0.000
3	60	4.997	4.997	0.000
3	61	4.996	4.994	-0.001
3	62	5.006	5.007	0.001
3	134	4.991	4.998	0.007
3	137	4.983	4.998	0.015
3	138	4.999	4.998	-0.001
3	139	5.001	5.003	0.002
3	236	5.009	4.991	-0.018
10	63	5.006	5.003	-0.003
10	64	4.991	4.990	0.000
10	65	5.018	5.017	-0.002
10	66	5.006	5.004	-0.002
10	150	4.998	4.994	-0.004
10	237	5.017	4.991	-0.026
10	241	5.017	4.998	-0.019
10	242	4.984	4.984	0.000
10	243	5.006	5.008	0.002
10	244	5.001	5.003	0.002
30	141	5.006	5.003	-0.003
30	144	5.017	5.016	0.000
30	145	5.014	5.010	-0.003
30	146	4.995	4.986	-0.009
30	147	5.025	5.023	-0.002
30	132	4.996	4.993	-0.002
30	133	5.010	5.008	-0.002
30	135	5.020	4.981	-0.038
30	245	5.007	5.000	-0.007
30	246	5.022	5.017	-0.005
50	67	4.985	4.980	-0.005
50	68	4.991	5.027	0.036
50	69	5.012	5.006	-0.006
50	71	5.004	5.003	-0.001
50	72	5.003	4.994	-0.009
50	172	5.012	5.056	0.045
50	173	4.985	4.975	-0.010
50	174	5.014	5.011	-0.003
50	183	5.008	5.007	-0.001
50	186	4.993	4.990	-0.003
100	95	4.998	4.980	-0.019
100	102	5.007	5.004	-0.002
100	104	4.994	4.971	-0.022
100	105	4.990	5.037	0.047
100	106	4.999	4.927	-0.071
100	178	5.015	5.019	0.004
100	179	4.988	4.966	-0.022
100	180	5.019	4.952	-0.067
100	181	5.002	4.990	-0.012
100	182	5.010	5.018	0.008
Max		5.025	5.056	0.047
Average		5.003	4.999	-0.005
Min		4.983	4.927	-0.071
Std Dev		0.011	0.020	0.020

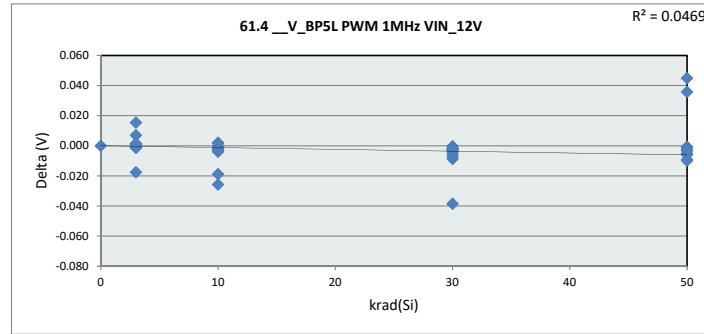

61.4 _V_BP5L PWM		
Test Site	DAL-FL	
Tester	ETS364	
Test Number	EB672302	
Max Limit	5.175	V
Min Limit	4.75	V

krad(Si)	0	3	10	30	50	100
LL	4.750	4.750	4.750	4.750	4.750	4.750
Min	5.018	4.985	4.984	4.981	4.975	4.927
Average	5.018	4.997	4.999	5.004	5.005	4.987
Max	5.018	5.007	5.017	5.023	5.057	5.038
UL	5.175	5.175	5.175	5.175	5.175	5.175

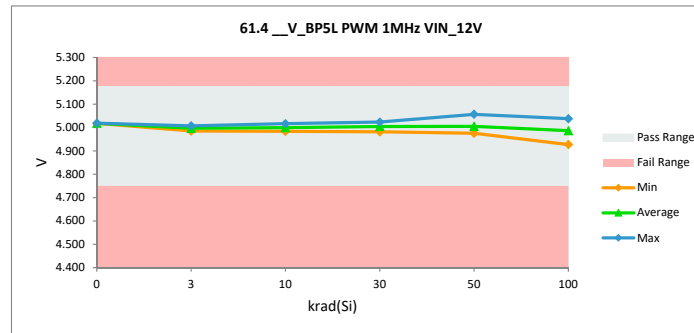

TID HDR Report
TPS7H6003-SP (5962R2220101VXC)

61.5 V BP5H PWM 1MHz VIN		
Test Site	DAL-FL	DAL-FL
Tester	ETS364	ETS364
Test Number	EB672302	EB672302
Unit	V	V
Max Limit	5.175	5.175
Min Limit	4.75	4.75

krad(Si)	Serial #	pre_short (rtp)	(2)'ST_Combo (rpt)	Delta
0	Ctrl	5.017	5.017	0.000
3	58	5.020	5.019	-0.001
3	59	5.007	5.006	-0.001
3	60	5.000	5.000	0.000
3	61	4.993	4.992	-0.001
3	62	4.987	4.986	-0.001
3	134	5.000	5.002	0.002
3	137	5.005	5.002	-0.002
3	138	4.985	5.002	0.017
3	139	4.995	4.996	0.001
3	236	5.005	5.008	0.003
10	63	4.987	4.985	-0.002
10	64	5.001	5.002	0.001
10	65	5.020	5.020	0.001
10	66	4.991	4.987	-0.004
10	150	5.007	5.005	-0.002
10	237	4.982	5.008	0.026
10	241	4.997	5.002	0.005
10	242	5.022	5.023	0.001
10	243	5.021	5.021	0.000
10	244	5.003	5.003	0.000
30	141	5.009	5.010	0.001
30	144	4.983	4.977	-0.006
30	145	5.012	5.006	-0.005
30	146	4.994	4.985	-0.010
30	147	4.997	4.994	-0.003
30	132	5.009	5.000	-0.009
30	133	4.998	4.999	0.001
30	135	5.005	4.988	-0.017
30	245	5.010	5.011	0.001
30	246	4.982	4.977	-0.004
50	67	5.009	5.011	0.002
50	68	4.999	5.005	0.007
50	69	4.989	4.984	-0.005
50	71	4.990	4.987	-0.003
50	72	4.982	4.983	0.000
50	172	4.992	4.986	-0.007
50	173	4.991	4.984	-0.007
50	174	5.001	4.992	-0.010
50	183	4.985	4.980	-0.005
50	186	4.987	4.983	-0.004
100	95	4.987	4.977	-0.010
100	102	4.984	4.989	0.005
100	104	5.005	5.024	0.019
100	105	4.998	5.019	0.021
100	106	4.990	4.962	-0.028
100	178	4.993	4.985	-0.008
100	179	4.996	4.994	-0.002
100	180	4.991	4.991	0.000
100	181	5.021	4.997	-0.024
100	182	5.011	5.034	0.023
	Max	5.022	5.034	0.026
	Average	4.999	4.998	-0.001
	Min	4.982	4.962	-0.028
	Std Dev	0.012	0.015	0.010

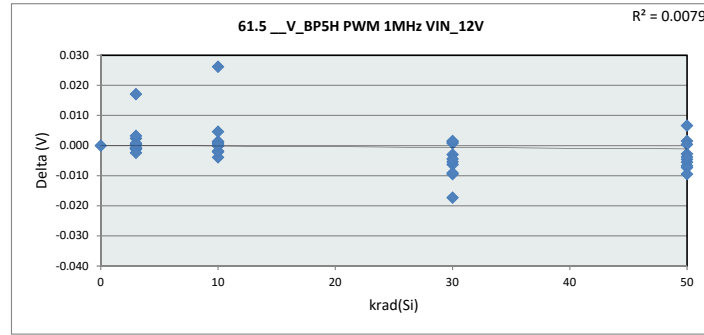

61.5 V BP5H PWM		
Test Site	DAL-FL	
Tester	ETS364	
Test Number	EB672302	
Max Limit	5.175	V
Min Limit	4.75	V

krad(Si)	0	3	10	30	50	100
LL	4.750	4.750	4.750	4.750	4.750	4.750
Min	5.017	4.986	4.985	4.977	4.980	4.962
Average	5.017	5.001	5.006	4.995	4.989	4.997
Max	5.017	5.020	5.023	5.012	5.011	5.034
UL	5.175	5.175	5.175	5.175	5.175	5.175

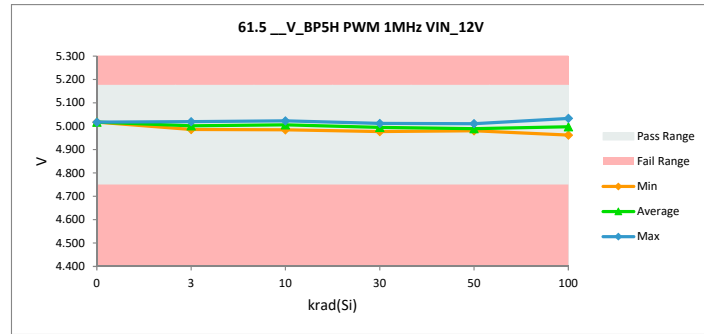

TID HDR Report
TPS7H6003-SP (5962R2220101VXC)

61.6_V_BP7L PWM 2MHz VIN		
Test Site	DAL-FL	DAL-FL
Tester	ETS364	ETS364
Test Number	EB672302	EB672302
Unit	V	V
Max Limit	7.35	7.35
Min Limit	6.65	6.65

krad(Si)	Serial #	pre_short (rtp)	(2)'ST_Combo (rpt)	Delta
0	Ctrl	7.036	7.036	0.000
3	58	7.042	7.043	0.002
3	59	7.000	7.001	0.001
3	60	6.973	6.974	0.001
3	61	6.984	6.982	-0.002
3	62	6.964	6.962	-0.002
3	134	7.033	7.001	-0.031
3	137	6.939	7.001	0.062
3	138	7.028	7.001	-0.026
3	139	6.976	6.975	0.000
3	236	6.972	6.990	0.018
10	63	6.974	6.971	-0.003
10	64	6.997	6.993	-0.004
10	65	7.023	7.025	0.002
10	66	7.018	7.016	-0.002
10	150	7.016	7.010	-0.006
10	237	7.010	6.990	-0.020
10	241	7.018	7.001	-0.016
10	242	6.992	6.993	0.001
10	243	6.993	6.992	-0.001
10	244	7.066	7.061	-0.005
30	141	7.033	7.029	-0.003
30	144	6.987	6.985	-0.002
30	145	7.030	7.028	-0.002
30	146	7.007	6.999	-0.008
30	147	7.010	7.002	-0.008
30	132	7.032	7.034	0.002
30	133	7.031	7.021	-0.010
30	135	6.992	7.027	0.035
30	245	6.988	6.983	-0.004
30	246	7.002	6.994	-0.008
50	67	7.034	7.028	-0.006
50	68	6.995	6.973	-0.022
50	69	7.034	7.041	0.007
50	71	6.980	6.973	-0.007
50	72	6.996	6.989	-0.006
50	172	7.014	6.977	-0.037
50	173	7.025	7.012	-0.013
50	174	7.001	7.005	0.004
50	183	7.008	7.008	0.000
50	186	6.977	6.979	0.002
100	95	6.991	7.017	0.026
100	102	6.944	6.936	-0.008
100	104	7.025	7.010	-0.015
100	105	7.012	6.984	-0.027
100	106	6.937	6.935	-0.002
100	178	7.041	7.024	-0.017
100	179	6.977	7.024	0.047
100	180	7.012	6.999	-0.013
100	181	7.016	7.006	-0.010
100	182	7.018	7.045	0.027
Max		7.066	7.061	0.062
Average		7.004	7.002	-0.002
Min		6.937	6.935	-0.037
Std Dev		0.027	0.026	0.018

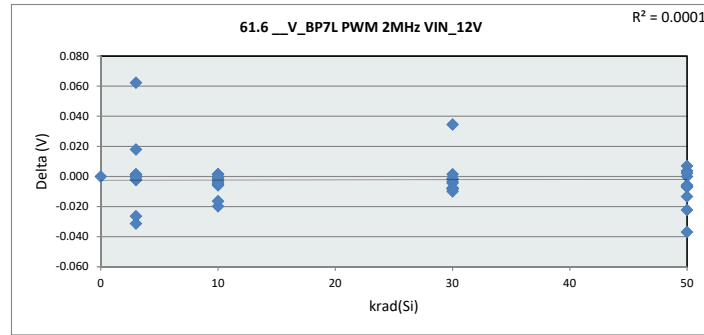

61.6_V_BP7L PWM		
Test Site	DAL-FL	
Tester	ETS364	
Test Number	EB672302	
Max Limit	7.35	V
Min Limit	6.65	V

krad(Si)	0	3	10	30	50	100
LL	6.650	6.650	6.650	6.650	6.650	6.650
Min	7.036	6.962	6.971	6.983	6.973	6.935
Average	7.036	6.993	7.005	7.010	6.999	6.998
Max	7.036	7.043	7.061	7.034	7.041	7.045
UL	7.350	7.350	7.350	7.350	7.350	7.350

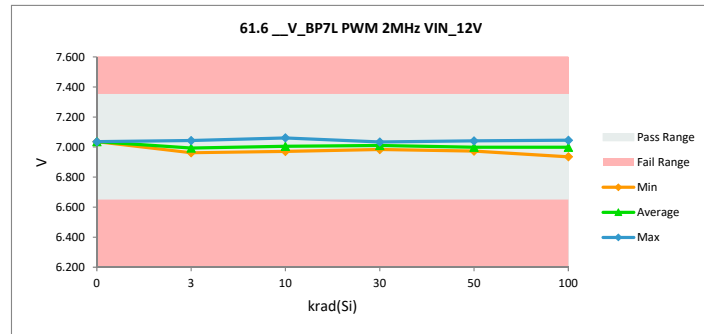

TID HDR Report
TPS7H6003-SP (5962R2220101VXC)

61.7 _V_BP5L PWM 2MHz VIN		
Test Site	DAL-FL	DAL-FL
Tester	ETS364	ETS364
Test Number	EB672302	EB672302
Unit	V	V
Max Limit	5.175	5.175
Min Limit	4.75	4.75

krad(Si)	Serial #	pre_short (rtp)	(2)'ST_Combo (rpt)	Delta
0	Ctrl	5.023	5.023	0.000
3	58	4.998	4.998	0.000
3	59	4.989	4.990	0.001
3	60	5.001	5.001	0.000
3	61	5.001	4.999	-0.001
3	62	5.010	5.012	0.001
3	134	4.995	5.003	0.008
3	137	4.987	5.003	0.016
3	138	5.003	5.003	0.000
3	139	5.005	5.007	0.002
3	236	5.013	4.996	-0.017
10	63	5.010	5.008	-0.003
10	64	4.995	4.995	0.000
10	65	5.022	5.021	-0.001
10	66	5.011	5.009	-0.002
10	150	5.002	4.999	-0.004
10	237	5.021	4.996	-0.025
10	241	5.021	5.003	-0.018
10	242	4.988	4.988	0.000
10	243	5.010	5.013	0.003
10	244	5.006	5.008	0.003
30	141	5.010	5.008	-0.002
30	144	5.021	5.021	0.000
30	145	5.018	5.015	-0.003
30	146	4.999	4.991	-0.009
30	147	5.029	5.028	-0.001
30	132	5.000	4.998	-0.002
30	133	5.014	5.012	-0.002
30	135	5.024	4.985	-0.039
30	245	5.012	5.005	-0.006
30	246	5.026	5.021	-0.005
50	67	4.990	4.985	-0.004
50	68	4.995	5.032	0.037
50	69	5.017	5.011	-0.006
50	71	5.008	5.008	0.000
50	72	5.007	4.999	-0.008
50	172	5.016	5.064	0.048
50	173	4.990	4.981	-0.009
50	174	5.019	5.017	-0.002
50	183	5.013	5.013	0.000
50	186	4.997	4.995	-0.002
100	95	5.003	4.985	-0.018
100	102	5.011	5.010	-0.001
100	104	4.997	4.975	-0.022
100	105	4.995	5.044	0.050
100	106	5.003	4.930	-0.073
100	178	5.020	5.027	0.007
100	179	4.993	4.971	-0.022
100	180	5.024	4.955	-0.069
100	181	5.007	4.996	-0.011
100	182	5.015	5.024	0.009
	Max	5.029	5.064	0.050
	Average	5.007	5.004	-0.004
	Min	4.987	4.930	-0.073
	Std Dev	0.011	0.021	0.020

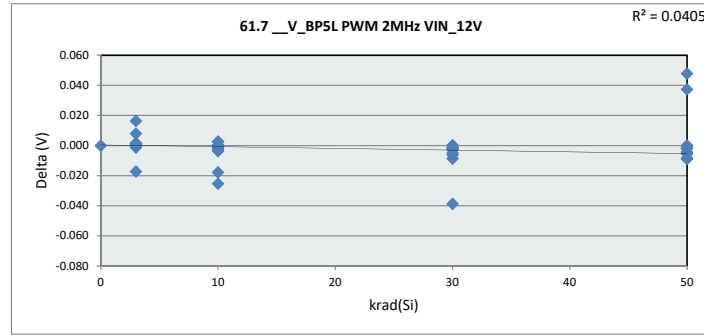

61.7 _V_BP5L PWM						
Test Site	DAL-FL					
Tester	ETS364					
Test Number	EB672302					
Max Limit	5.175 V					
Min Limit	4.75 V					
krad(Si)	0	3	10	30	50	100
LL	4.750	4.750	4.750	4.750	4.750	4.750
Min	5.023	4.990	4.988	4.985	4.981	4.930
Average	5.023	5.001	5.004	5.009	5.011	4.992
Max	5.023	5.012	5.021	5.028	5.064	5.044
UL	5.175	5.175	5.175	5.175	5.175	5.175

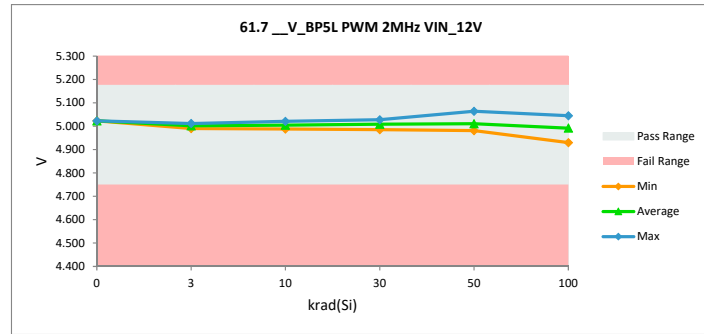

TID HDR Report
TPS7H6003-SP (5962R2220101VXC)

61.8 __V_BP5H_PWM_2MHz_VIN		
Test Site	DAL-FL	DAL-FL
Tester	ETS364	ETS364
Test Number	EB672302	EB672302
Unit	V	V
Max Limit	5.175	5.175
Min Limit	4.75	4.75

krad(Si)	Serial #	pre_short (rtp) (2)'ST	Combo (rpt) (Delta
0	Ctrl	5.019	5.019	0.000
3	58	5.022	5.021	-0.001
3	59	5.008	5.007	-0.001
3	60	5.001	5.001	0.000
3	61	4.995	4.994	-0.001
3	62	4.989	4.987	-0.001
3	134	5.001	5.004	0.003
3	137	5.006	5.004	-0.002
3	138	4.986	5.003	0.017
3	139	4.996	4.997	0.001
3	236	5.006	5.009	0.003
10	63	4.988	4.986	-0.002
10	64	5.002	5.003	0.002
10	65	5.021	5.022	0.001
10	66	4.992	4.989	-0.004
10	150	5.008	5.006	-0.002
10	237	4.983	5.009	0.026
10	241	4.999	5.004	0.005
10	242	5.023	5.024	0.001
10	243	5.022	5.022	0.000
10	244	5.004	5.005	0.000
30	141	5.011	5.011	0.001
30	144	4.984	4.978	-0.006
30	145	5.013	5.008	-0.005
30	146	4.996	4.986	-0.010
30	147	4.998	4.995	-0.003
30	132	5.010	5.001	-0.009
30	133	5.000	5.001	0.001
30	135	5.006	4.989	-0.017
30	245	5.011	5.013	0.002
30	246	4.983	4.979	-0.004
50	67	5.011	5.012	0.002
50	68	5.000	5.007	0.007
50	69	4.990	4.985	-0.005
50	71	4.991	4.989	-0.003
50	72	4.984	4.984	0.000
50	172	4.994	4.988	-0.006
50	173	4.992	4.985	-0.007
50	174	5.003	4.993	-0.009
50	183	4.987	4.982	-0.005
50	186	4.989	4.985	-0.004
100	95	4.989	4.978	-0.010
100	102	4.985	4.991	0.006
100	104	5.007	5.026	0.020
100	105	5.000	5.021	0.021
100	106	4.991	4.964	-0.028
100	178	4.995	4.987	-0.008
100	179	4.997	4.996	-0.002
100	180	4.992	4.993	0.000
100	181	5.022	4.998	-0.024
100	182	5.012	5.036	0.023
Max		5.023	5.036	0.026
Average		5.000	5.000	-0.001
Min		4.983	4.964	-0.028
Std Dev		0.011	0.015	0.010

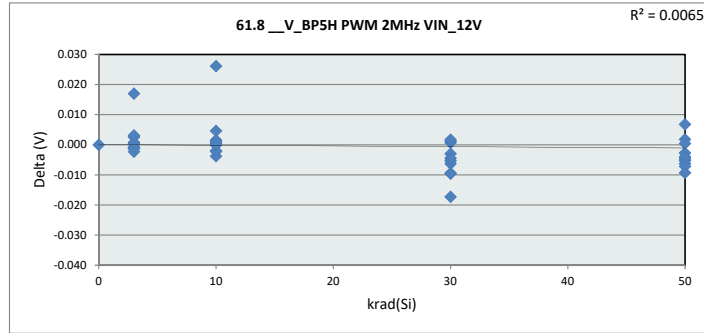

61.8 __V_BP5H_PWM		
Test Site	DAL-FL	
Tester	ETS364	
Test Number	EB672302	
Max Limit	5.175	V
Min Limit	4.75	V

krad(Si)	0	3	10	30	50	100
LL	4.750	4.750	4.750	4.750	4.750	4.750
Min	5.019	4.987	4.986	4.978	4.982	4.964
Average	5.019	5.003	5.007	4.996	4.991	4.999
Max	5.019	5.021	5.024	5.013	5.013	5.036
UL	5.175	5.175	5.175	5.175	5.175	5.175

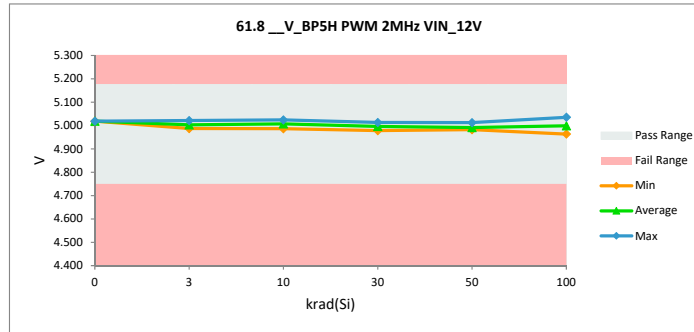

TID HDR Report
TPS7H6003-SP (5962R2220101VXC)

61.9_V_BP7L PWM 5MHz VIN		
Test Site	DAL-FL	DAL-FL
Tester	ETS364	ETS364
Test Number	EB672302	EB672302
Unit	V	V
Max Limit	7.35	7.35
Min Limit	6.65	6.65

krad(Si)	Serial #	pre_short (rtp)	(2)ST_Combo (rpt)	Delta
0	Ctrl	7.030	7.030	0.000
3	58	7.048	7.049	0.001
3	59	7.005	7.006	0.001
3	60	6.979	6.980	0.001
3	61	6.992	6.990	-0.002
3	62	6.970	6.968	-0.001
3	134	7.037	7.006	-0.030
3	137	6.944	7.006	0.062
3	138	7.034	7.006	-0.027
3	139	6.981	6.980	-0.001
3	236	6.965	6.995	0.030
10	63	6.979	6.976	-0.003
10	64	7.003	6.999	-0.004
10	65	7.029	7.030	0.001
10	66	7.025	7.023	-0.002
10	150	7.020	7.013	-0.007
10	237	7.014	6.995	-0.019
10	241	7.022	7.006	-0.016
10	242	6.997	6.998	0.002
10	243	6.999	6.998	-0.001
10	244	7.071	7.066	-0.005
30	141	7.039	7.037	-0.002
30	144	6.992	6.992	-0.001
30	145	7.036	7.034	-0.002
30	146	7.012	7.004	-0.009
30	147	7.016	7.008	-0.008
30	132	7.037	7.041	0.003
30	133	7.035	7.024	-0.011
30	135	6.997	7.034	0.037
30	245	6.993	6.989	-0.004
30	246	7.007	6.998	-0.009
50	67	7.041	7.032	-0.008
50	68	6.987	6.978	-0.009
50	69	7.040	7.052	0.013
50	71	6.987	6.978	-0.009
50	72	7.002	6.995	-0.007
50	172	7.017	6.977	-0.039
50	173	7.031	7.016	-0.015
50	174	6.994	7.013	0.019
50	183	7.013	7.014	0.001
50	186	6.983	6.985	0.002
100	95	6.996	7.028	0.032
100	102	6.949	6.941	-0.009
100	104	7.030	7.014	-0.016
100	105	7.018	6.989	-0.030
100	106	6.943	6.942	-0.001
100	178	7.047	7.029	-0.018
100	179	6.984	7.034	0.051
100	180	7.012	7.004	-0.008
100	181	7.022	7.012	-0.009
100	182	7.024	7.051	0.027
	Max	7.071	7.066	0.062
	Average	7.008	7.007	-0.001
	Min	6.943	6.941	-0.039
	Std Dev	0.028	0.026	0.019

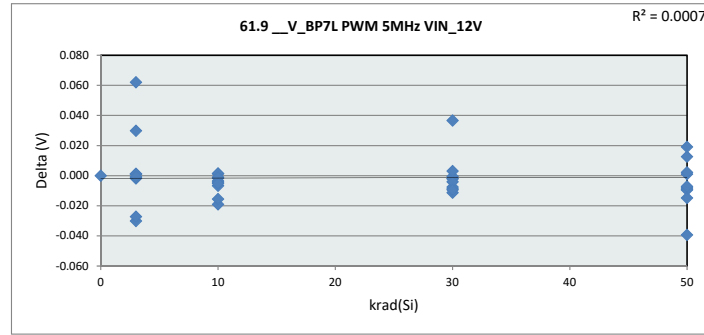

61.9_V_BP7L PWM		
Test Site	DAL-FL	
Tester	ETS364	
Test Number	EB672302	
Max Limit	7.35	V
Min Limit	6.65	V

krad(Si)	0	3	10	30	50	100
LL	6.650	6.650	6.650	6.650	6.650	6.650
Min	7.030	6.968	6.976	6.989	6.978	6.941
Average	7.030	6.999	7.011	7.016	7.004	7.004
Max	7.030	7.049	7.066	7.041	7.052	7.051
UL	7.350	7.350	7.350	7.350	7.350	7.350

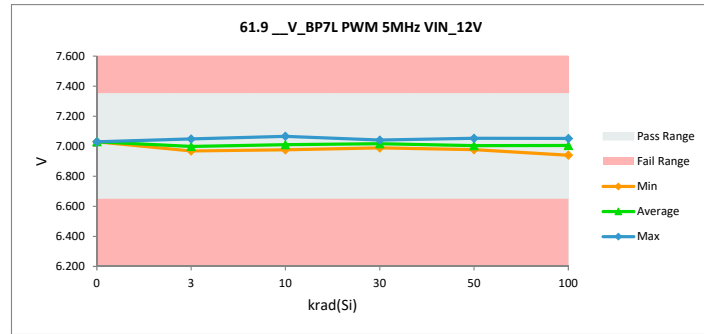

TID HDR Report
TPS7H6003-SP (5962R2220101VXC)

61.10_V_BP5L PWM 5MHz VIN		
Test Site	DAL-FL	DAL-FL
Tester	ETS364	ETS364
Test Number	EB672302	EB672302
Unit	V	V
Max Limit	5.175	5.175
Min Limit	4.75	4.75

krad(Si)	Serial #	pre_short (rtp)	(2)'ST_Combo (rpt)	Delta
0	Ctrl	5.024	5.024	0.000
3	58	4.994	4.994	0.001
3	59	4.984	4.985	0.001
3	60	4.996	4.997	0.000
3	61	4.995	4.994	-0.001
3	62	5.006	5.007	0.001
3	134	4.992	4.997	0.005
3	137	4.982	4.997	0.015
3	138	4.999	4.997	-0.001
3	139	5.001	5.003	0.002
3	236	5.013	4.992	-0.022
10	63	5.006	5.003	-0.003
10	64	4.991	4.990	0.000
10	65	5.018	5.016	-0.002
10	66	5.005	5.003	-0.002
10	150	4.998	4.994	-0.004
10	237	5.016	4.991	-0.025
10	241	5.017	4.997	-0.020
10	242	4.984	4.984	0.000
10	243	5.006	5.008	0.002
10	244	5.001	5.003	0.002
30	141	5.005	5.002	-0.003
30	144	5.017	5.016	-0.001
30	145	5.014	5.010	-0.003
30	146	4.995	4.986	-0.009
30	147	5.025	5.023	-0.002
30	132	4.996	4.994	-0.003
30	133	5.010	5.008	-0.002
30	135	5.019	4.979	-0.041
30	245	5.007	5.000	-0.007
30	246	5.022	5.017	-0.006
50	67	4.984	4.980	-0.005
50	68	4.995	5.027	0.032
50	69	5.012	5.005	-0.007
50	71	5.003	5.002	-0.001
50	72	5.003	4.994	-0.009
50	172	5.012	5.062	0.050
50	173	4.985	4.975	-0.010
50	174	5.019	5.010	-0.009
50	183	5.008	5.007	-0.001
50	186	4.993	4.990	-0.003
100	95	4.999	4.979	-0.020
100	102	5.007	5.004	-0.002
100	104	4.993	4.971	-0.023
100	105	4.990	5.040	0.050
100	106	4.999	4.923	-0.076
100	178	5.015	5.020	0.005
100	179	4.988	4.963	-0.025
100	180	5.020	4.949	-0.071
100	181	5.002	4.989	-0.013
100	182	5.011	5.019	0.008
Max		5.025	5.062	0.050
Average		5.003	4.998	-0.005
Min		4.982	4.923	-0.076
Std Dev		0.012	0.022	0.021

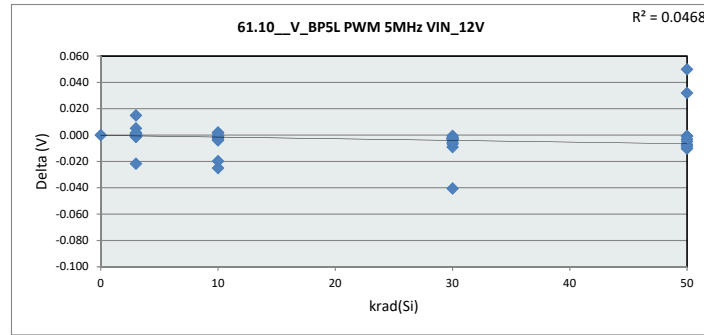

61.10_V_BP5L PWM		
Test Site	DAL-FL	
Tester	ETS364	
Test Number	EB672302	
Max Limit	5.175	V
Min Limit	4.75	V

krad(Si)	0	3	10	30	50	100
LL	4.750	4.750	4.750	4.750	4.750	4.750
Min	5.024	4.985	4.984	4.979	4.975	4.923
Average	5.024	4.996	4.999	5.003	5.005	4.986
Max	5.024	5.007	5.017	5.023	5.062	5.040
UL	5.175	5.175	5.175	5.175	5.175	5.175

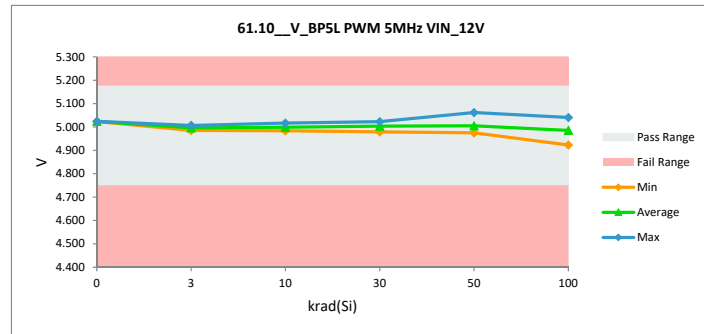

TID HDR Report
TPS7H6003-SP (5962R2220101VXC)

61.11_V_BP5H PWM 5MHz VIN		
Test Site	DAL-FL	DAL-FL
Tester	ETS364	ETS364
Test Number	EB672302	EB672302
Unit	V	V
Max Limit	5.175	5.175
Min Limit	4.75	4.75

krad(Si)	Serial #	pre_short (rtp) (2)	ST_Combo (rpt) (Delta
0	Ctrl	5.022	5.022	0.000
3	58	5.024	5.024	-0.001
3	59	5.010	5.010	0.000
3	60	5.004	5.004	0.000
3	61	4.998	4.996	-0.002
3	62	4.991	4.989	-0.002
3	134	5.004	5.006	0.001
3	137	5.008	5.006	-0.002
3	138	4.988	5.005	0.017
3	139	4.999	4.999	0.001
3	236	5.010	5.012	0.002
10	63	4.991	4.989	-0.002
10	64	5.004	5.006	0.002
10	65	5.024	5.025	0.001
10	66	4.995	4.991	-0.004
10	150	5.011	5.010	-0.002
10	237	4.985	5.012	0.026
10	241	5.002	5.005	0.003
10	242	5.025	5.027	0.002
10	243	5.024	5.025	0.001
10	244	5.007	5.008	0.001
30	141	5.013	5.014	0.001
30	144	4.987	4.981	-0.006
30	145	5.015	5.010	-0.005
30	146	4.998	4.989	-0.009
30	147	5.000	4.998	-0.003
30	132	5.013	5.003	-0.010
30	133	5.002	5.004	0.002
30	135	5.008	4.991	-0.016
30	245	5.014	5.016	0.002
30	246	4.986	4.982	-0.004
50	67	5.012	5.016	0.003
50	68	5.003	5.010	0.007
50	69	4.993	4.988	-0.005
50	71	4.994	4.991	-0.003
50	72	4.986	4.987	0.001
50	172	4.996	4.991	-0.005
50	173	4.995	4.988	-0.007
50	174	5.006	4.996	-0.010
50	183	4.989	4.985	-0.005
50	186	4.992	4.988	-0.004
100	95	4.991	4.981	-0.011
100	102	4.988	4.995	0.007
100	104	5.009	5.030	0.022
100	105	5.002	5.025	0.023
100	106	4.994	4.966	-0.028
100	178	4.997	4.990	-0.007
100	179	5.000	4.998	-0.002
100	180	4.995	4.995	0.000
100	181	5.024	4.999	-0.025
100	182	5.014	5.040	0.026
	Max	5.025	5.040	0.026
	Average	5.003	5.002	0.000
	Min	4.985	4.966	-0.028
	Std Dev	0.011	0.015	0.010

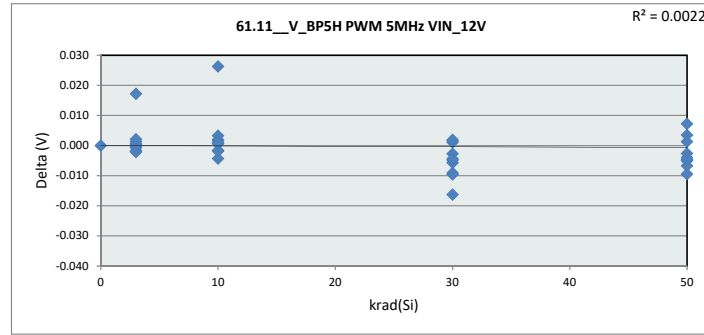

61.11_V_BP5H PW		
Test Site	DAL-FL	
Tester	ETS364	
Test Number	EB672302	
Max Limit	5.175	V
Min Limit	4.75	V

krad(Si)	0	3	10	30	50	100
LL	4.750	4.750	4.750	4.750	4.750	4.750
Min	5.022	4.989	4.989	4.981	4.985	4.966
Average	5.022	5.005	5.010	4.999	4.994	5.002
Max	5.022	5.024	5.027	5.016	5.016	5.040
UL	5.175	5.175	5.175	5.175	5.175	5.175

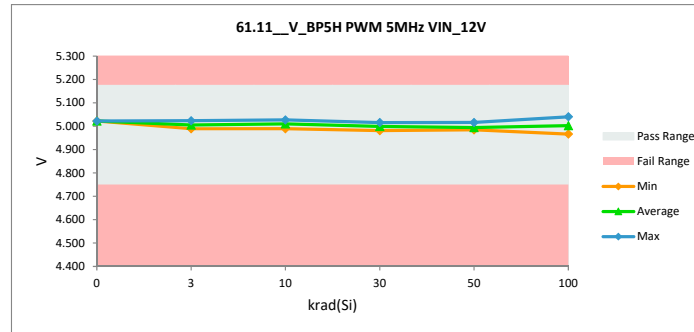

TID HDR Report
TPS7H6003-SP (5962R2220101VXC)

61.12_V_BP7L IIM 500kHz VIN		
Test Site	DAL-FL	DAL-FL
Tester	ETS364	ETS364
Test Number	EB672302	EB672302
Unit	V	V
Max Limit	7.35	7.35
Min Limit	6.65	6.65

krad(Si)	Serial #	pre_short (rtp) (2)	ST_Combo (rpt) (Delta
0	Ctrl	7.047	7.047	0.000
3	58	7.053	7.054	0.001
3	59	7.011	7.012	0.001
3	60	6.984	6.985	0.001
3	61	6.995	6.992	-0.003
3	62	6.975	6.973	-0.002
3	134	7.043	7.012	-0.031
3	137	6.950	7.012	0.063
3	138	7.038	7.012	-0.026
3	139	6.986	6.986	-0.001
3	236	6.983	7.001	0.017
10	63	6.985	6.982	-0.003
10	64	7.008	7.004	-0.004
10	65	7.035	7.037	0.002
10	66	7.030	7.028	-0.002
10	150	7.027	7.022	-0.005
10	237	7.021	7.001	-0.020
10	241	7.029	7.012	-0.017
10	242	7.003	7.004	0.001
10	243	7.004	7.003	-0.001
10	244	7.077	7.072	-0.005
30	141	7.044	7.041	-0.003
30	144	6.998	6.997	-0.002
30	145	7.041	7.039	-0.001
30	146	7.017	7.010	-0.008
30	147	7.021	7.014	-0.007
30	132	7.043	7.045	0.002
30	133	7.042	7.033	-0.009
30	135	7.004	7.039	0.035
30	245	6.999	6.995	-0.004
30	246	7.014	7.007	-0.006
50	67	7.045	7.040	-0.004
50	68	7.008	6.985	-0.022
50	69	7.044	7.051	0.006
50	71	6.991	6.985	-0.006
50	72	7.007	7.001	-0.006
50	172	7.025	6.990	-0.035
50	173	7.037	7.024	-0.013
50	174	7.012	7.015	0.003
50	183	7.019	7.018	0.000
50	186	6.988	6.989	0.002
100	95	7.002	7.029	0.027
100	102	6.955	6.948	-0.007
100	104	7.036	7.023	-0.013
100	105	7.023	6.998	-0.025
100	106	6.948	6.948	0.000
100	178	7.053	7.036	-0.017
100	179	6.988	7.034	0.045
100	180	7.023	7.011	-0.012
100	181	7.028	7.017	-0.010
100	182	7.029	7.057	0.027
	Max	7.077	7.072	0.063
	Average	7.015	7.013	-0.002
	Min	6.948	6.948	-0.035
	Std Dev	0.027	0.026	0.017

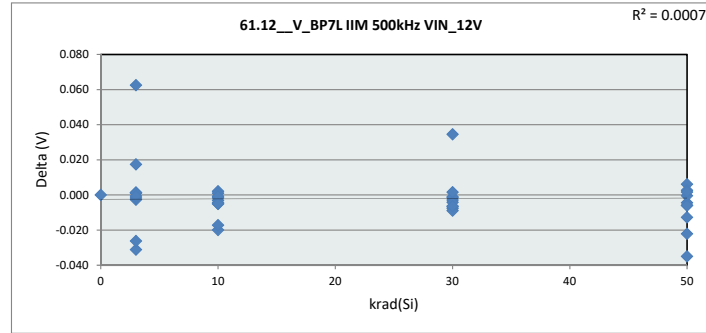

61.12_V_BP7L IIM

Test Site	DAL-FL
Tester	ETS364
Test Number	EB672302
Max Limit	7.35 V
Min Limit	6.65 V

krad(Si)	0	3	10	30	50	100
LL	6.650	6.650	6.650	6.650	6.650	6.650
Min	7.047	6.973	6.982	6.995	6.985	6.948
Average	7.047	7.004	7.016	7.022	7.010	7.010
Max	7.047	7.054	7.072	7.045	7.051	7.057
UL	7.350	7.350	7.350	7.350	7.350	7.350

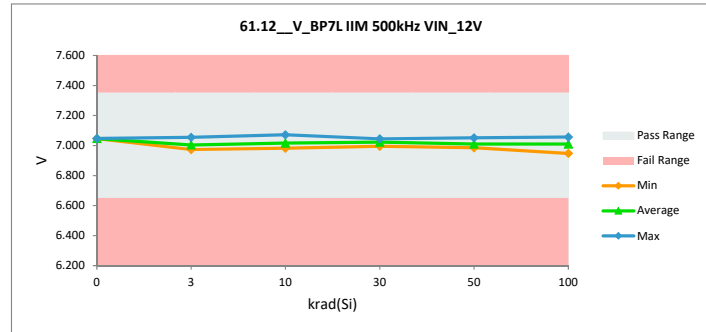

TID HDR Report
TPS7H6003-SP (5962R2220101VXC)

61.13_V_BP5L IIM 500kHz VIN		
Test Site	DAL-FL	DAL-FL
Tester	ETS364	ETS364
Test Number	EB672302	EB672302
Unit	V	V
Max Limit	5.175	5.175
Min Limit	4.75	4.75

krad(Si)	Serial #	pre_short (rtp)	(2)'ST_Combo (rpt)	Delta
0	Ctrl	5.016	5.016	0.000
3	58	4.991	4.992	0.000
3	59	4.983	4.983	0.000
3	60	4.994	4.994	0.000
3	61	4.993	4.992	-0.001
3	62	5.004	5.005	0.001
3	134	4.989	4.996	0.006
3	137	4.981	4.996	0.015
3	138	4.997	4.996	-0.001
3	139	4.999	5.001	0.002
3	236	5.007	4.989	-0.018
10	63	5.004	5.001	-0.003
10	64	4.989	4.988	-0.001
10	65	5.016	5.015	-0.002
10	66	5.004	5.002	-0.002
10	150	4.996	4.991	-0.004
10	237	5.015	4.989	-0.026
10	241	5.015	4.996	-0.019
10	242	4.982	4.981	0.000
10	243	5.004	5.006	0.002
10	244	4.999	5.000	0.001
30	141	5.004	5.001	-0.003
30	144	5.015	5.014	-0.001
30	145	5.012	5.008	-0.004
30	146	4.993	4.984	-0.009
30	147	5.023	5.021	-0.002
30	132	4.994	4.991	-0.003
30	133	5.008	5.005	-0.002
30	135	5.017	4.979	-0.039
30	245	5.005	4.998	-0.007
30	246	5.020	5.015	-0.005
50	67	4.983	4.978	-0.005
50	68	4.989	5.023	0.035
50	69	5.010	5.003	-0.006
50	71	5.002	5.001	-0.001
50	72	5.001	4.992	-0.010
50	172	5.009	5.053	0.044
50	173	4.983	4.973	-0.010
50	174	5.012	5.008	-0.004
50	183	5.006	5.004	-0.002
50	186	4.991	4.988	-0.003
100	95	4.997	4.977	-0.019
100	102	5.005	5.002	-0.003
100	104	4.992	4.969	-0.023
100	105	4.989	5.035	0.046
100	106	4.997	4.925	-0.071
100	178	5.013	5.016	0.003
100	179	4.986	4.964	-0.022
100	180	5.017	4.951	-0.067
100	181	5.000	4.987	-0.013
100	182	5.009	5.015	0.006
Max		5.023	5.053	0.046
Average		5.001	4.996	-0.005
Min		4.981	4.925	-0.071
Std Dev		0.011	0.020	0.019

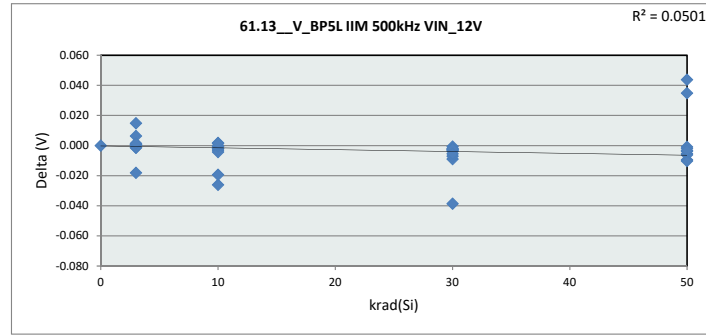

61.13_V_BP5L IIM		
Test Site	DAL-FL	
Tester	ETS364	
Test Number	EB672302	
Max Limit	5.175	V
Min Limit	4.75	V

krad(Si)	0	3	10	30	50	100
LL	4.750	4.750	4.750	4.750	4.750	4.750
Min	5.016	4.983	4.981	4.979	4.973	4.925
Average	5.016	4.994	4.997	5.002	5.002	4.984
Max	5.016	5.005	5.015	5.021	5.053	5.035
UL	5.175	5.175	5.175	5.175	5.175	5.175

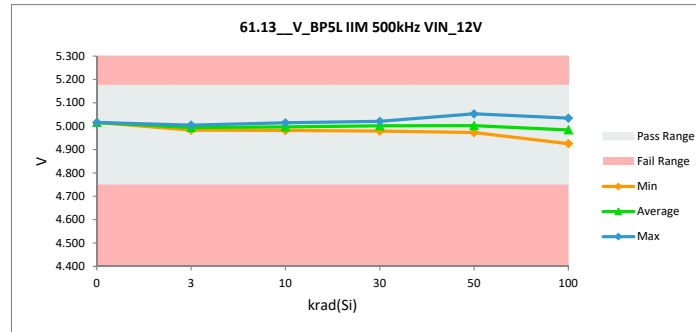

TID HDR Report
TPS7H6003-SP (5962R2220101VXC)

61.14 V_BP5H IIM 500kHz VIN		
Test Site	DAL-FL	DAL-FL
Tester	ETS364	ETS364
Test Number	EB672302	EB672302
Unit	V	V
Max Limit	5.175	5.175
Min Limit	4.75	4.75

krad(Si)	Serial #	pre_short (rtp)	(2)ST_Combo (rpt)	Delta
0	Ctrl	5.017	5.017	0.000
3	58	5.019	5.019	-0.001
3	59	5.006	5.005	-0.001
3	60	4.999	4.999	0.000
3	61	4.992	4.992	-0.001
3	62	4.986	4.985	-0.001
3	134	4.999	5.001	0.002
3	137	5.004	5.001	-0.003
3	138	4.984	5.001	0.017
3	139	4.994	4.995	0.001
3	236	5.004	5.007	0.003
10	63	4.986	4.984	-0.002
10	64	5.000	5.001	0.001
10	65	5.019	5.020	0.001
10	66	4.990	4.986	-0.004
10	150	5.006	5.004	-0.002
10	237	4.981	5.008	0.026
10	241	4.997	5.001	0.005
10	242	5.021	5.022	0.001
10	243	5.020	5.020	0.000
10	244	5.002	5.002	0.000
30	141	5.009	5.009	0.001
30	144	4.982	4.976	-0.006
30	145	5.011	5.006	-0.005
30	146	4.993	4.984	-0.009
30	147	4.996	4.993	-0.003
30	132	5.008	4.999	-0.009
30	133	4.998	4.999	0.001
30	135	5.004	4.987	-0.017
30	245	5.009	5.011	0.001
30	246	4.981	4.977	-0.004
50	67	5.009	5.010	0.002
50	68	4.998	5.005	0.007
50	69	4.988	4.983	-0.005
50	71	4.989	4.986	-0.003
50	72	4.982	4.982	0.000
50	172	4.992	4.985	-0.007
50	173	4.990	4.983	-0.007
50	174	5.000	4.991	-0.009
50	183	4.984	4.980	-0.005
50	186	4.986	4.983	-0.004
100	95	4.986	4.976	-0.010
100	102	4.983	4.989	0.005
100	104	5.004	5.024	0.019
100	105	4.998	5.019	0.021
100	106	4.989	4.962	-0.028
100	178	4.992	4.984	-0.008
100	179	4.996	4.993	-0.002
100	180	4.990	4.991	0.000
100	181	5.020	4.996	-0.024
100	182	5.010	5.032	0.022
	Max	5.021	5.032	0.026
	Average	4.998	4.997	-0.001
	Min	4.981	4.962	-0.028
	Std Dev	0.012	0.015	0.010

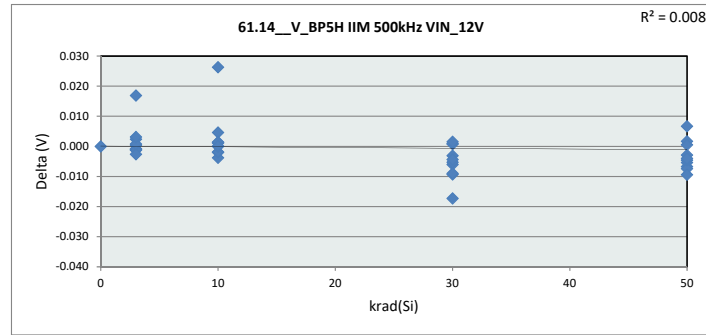

61.14 V_BP5H IIM		
Test Site	DAL-FL	
Tester	ETS364	
Test Number	EB672302	
Max Limit	5.175	V
Min Limit	4.75	V

krad(Si)	0	3	10	30	50	100
LL	4.750	4.750	4.750	4.750	4.750	4.750
Min	5.017	4.985	4.984	4.976	4.980	4.962
Average	5.017	5.001	5.005	4.994	4.989	4.997
Max	5.017	5.019	5.022	5.011	5.010	5.032
UL	5.175	5.175	5.175	5.175	5.175	5.175

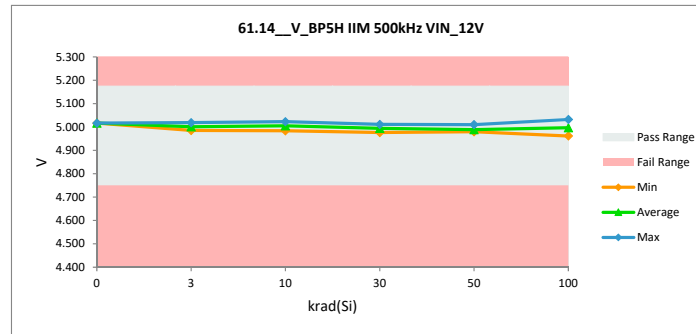

TID HDR Report
TPS7H6003-SP (5962R2220101VXC)

61.15_V_BP7L IIM 1MHz VIN_1		
Test Site	DAL-FL	DAL-FL
Tester	ETS364	ETS364
Test Number	EB672302	EB672302
Unit	V	V
Max Limit	7.35	7.35
Min Limit	6.65	6.65

krad(Si)	Serial #	pre_short (rtp) (2)	ST_Combo (rpt) (Delta
0	Ctrl	7.043	7.043	0.000
3	58	7.049	7.051	0.001
3	59	7.007	7.009	0.002
3	60	6.980	6.982	0.001
3	61	6.991	6.989	-0.003
3	62	6.971	6.969	-0.002
3	134	7.039	7.009	-0.031
3	137	6.946	7.009	0.063
3	138	7.035	7.009	-0.026
3	139	6.982	6.982	0.000
3	236	6.979	6.997	0.018
10	63	6.981	6.978	-0.003
10	64	7.004	7.000	-0.004
10	65	7.030	7.032	0.002
10	66	7.025	7.024	-0.002
10	150	7.023	7.018	-0.005
10	237	7.017	6.997	-0.020
10	241	7.025	7.008	-0.017
10	242	6.999	7.000	0.001
10	243	7.000	6.999	-0.001
10	244	7.073	7.068	-0.005
30	141	7.040	7.037	-0.003
30	144	6.994	6.993	-0.002
30	145	7.037	7.035	-0.001
30	146	7.014	7.006	-0.008
30	147	7.017	7.010	-0.007
30	132	7.039	7.041	0.002
30	133	7.038	7.029	-0.009
30	135	7.000	7.035	0.035
30	245	6.995	6.991	-0.004
30	246	7.010	7.003	-0.007
50	67	7.041	7.036	-0.005
50	68	7.003	6.981	-0.022
50	69	7.041	7.047	0.007
50	71	6.987	6.981	-0.006
50	72	7.003	6.997	-0.006
50	172	7.021	6.984	-0.036
50	173	7.033	7.020	-0.013
50	174	7.009	7.012	0.003
50	183	7.015	7.015	0.000
50	186	6.984	6.986	0.002
100	95	6.998	7.025	0.027
100	102	6.951	6.944	-0.007
100	104	7.032	7.018	-0.014
100	105	7.019	6.993	-0.026
100	106	6.944	6.943	-0.001
100	178	7.049	7.032	-0.017
100	179	6.984	7.030	0.046
100	180	7.019	7.007	-0.012
100	181	7.024	7.014	-0.010
100	182	7.025	7.051	0.026
	Max	7.073	7.068	0.063
	Average	7.011	7.009	-0.002
	Min	6.944	6.943	-0.036
	Std Dev	0.027	0.026	0.017

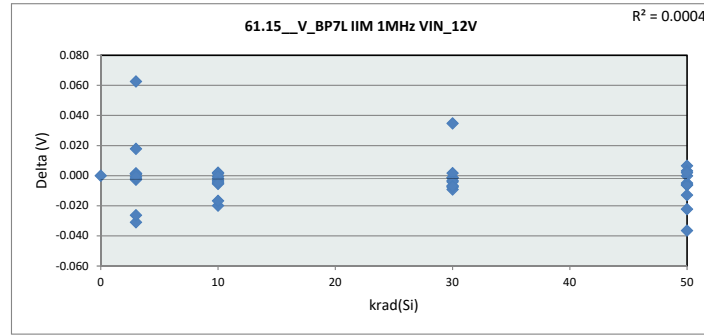

61.15_V_BP7L IIM		
Test Site	DAL-FL	
Tester	ETS364	
Test Number	EB672302	
Max Limit	7.35	V
Min Limit	6.65	V

krad(Si)	0	3	10	30	50	100
LL	6.650	6.650	6.650	6.650	6.650	6.650
Min	7.043	6.969	6.978	6.991	6.981	6.943
Average	7.043	7.000	7.012	7.018	7.006	7.006
Max	7.043	7.051	7.068	7.041	7.047	7.052
UL	7.350	7.350	7.350	7.350	7.350	7.350

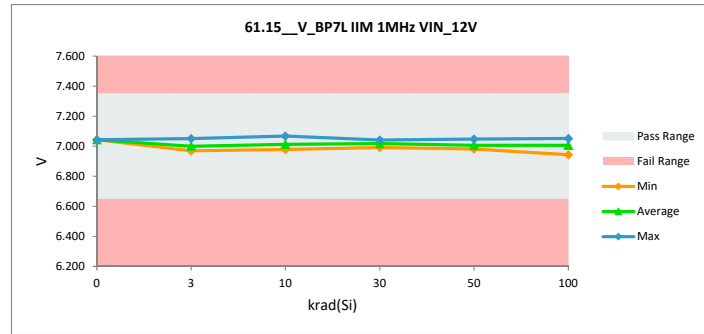

TID HDR Report
TPS7H6003-SP (5962R2220101VXC)

61.16_V_BP5L IIM 1MHz VIN_12V		
Test Site	DAL-FL	DAL-FL
Tester	ETS364	ETS364
Test Number	EB672302	EB672302
Unit	V	V
Max Limit	5.175	5.175
Min Limit	4.75	4.75

krad(Si)	Serial #	pre_short (rtp)	(2)ST_Combo (rpt)	Delta
0	Ctrl	5.018	5.018	0.000
3	58	4.994	4.994	0.000
3	59	4.985	4.985	0.000
3	60	4.997	4.997	0.000
3	61	4.996	4.994	-0.001
3	62	5.006	5.007	0.001
3	134	4.991	4.998	0.007
3	137	4.983	4.998	0.015
3	138	4.999	4.998	-0.001
3	139	5.001	5.003	0.002
3	236	5.009	4.991	-0.018
10	63	5.006	5.003	-0.003
10	64	4.991	4.991	0.000
10	65	5.019	5.017	-0.002
10	66	5.006	5.004	-0.002
10	150	4.998	4.994	-0.004
10	237	5.017	4.992	-0.026
10	241	5.017	4.998	-0.019
10	242	4.984	4.984	0.000
10	243	5.006	5.009	0.002
10	244	5.001	5.003	0.002
30	141	5.006	5.003	-0.003
30	144	5.017	5.016	0.000
30	145	5.014	5.011	-0.003
30	146	4.995	4.987	-0.009
30	147	5.025	5.023	-0.002
30	132	4.996	4.993	-0.003
30	133	5.010	5.008	-0.002
30	135	5.020	4.981	-0.039
30	245	5.008	5.001	-0.007
30	246	5.022	5.017	-0.005
50	67	4.985	4.980	-0.005
50	68	4.991	5.026	0.036
50	69	5.012	5.006	-0.006
50	71	5.004	5.003	0.000
50	72	5.003	4.994	-0.009
50	172	5.012	5.057	0.045
50	173	4.985	4.976	-0.010
50	174	5.014	5.011	-0.003
50	183	5.008	5.007	-0.001
50	186	4.993	4.990	-0.003
100	95	4.999	4.980	-0.019
100	102	5.007	5.004	-0.002
100	104	4.994	4.971	-0.023
100	105	4.991	5.038	0.047
100	106	4.999	4.926	-0.072
100	178	5.015	5.019	0.004
100	179	4.989	4.966	-0.022
100	180	5.020	4.952	-0.067
100	181	5.002	4.990	-0.012
100	182	5.011	5.018	0.007
Max		5.025	5.057	0.047
Average		5.003	4.999	-0.005
Min		4.983	4.926	-0.072
Std Dev		0.011	0.020	0.020

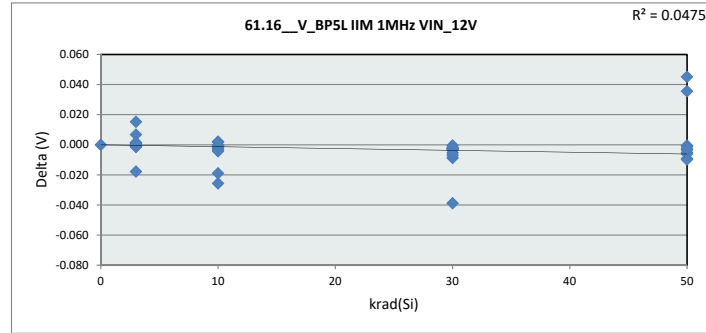

61.16_V_BP5L IIM		
Test Site	DAL-FL	
Tester	ETS364	
Test Number	EB672302	
Max Limit	5.175	V
Min Limit	4.75	V

krad(Si)	0	3	10	30	50	100
LL	4.750	4.750	4.750	4.750	4.750	4.750
Min	5.018	4.985	4.984	4.981	4.976	4.927
Average	5.018	4.997	4.999	5.004	5.005	4.987
Max	5.018	5.007	5.017	5.023	5.057	5.038
UL	5.175	5.175	5.175	5.175	5.175	5.175

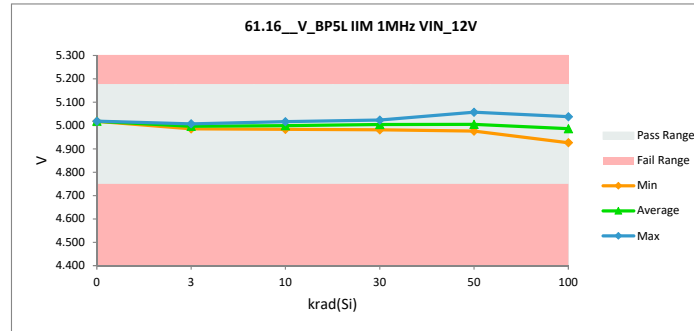

TID HDR Report
TPS7H6003-SP (5962R2220101VXC)

61.17 V BP5H IIM 1MHz VIN		
Test Site	DAL-FL	DAL-FL
Tester	ETS364	ETS364
Test Number	EB672302	EB672302
Unit	V	V
Max Limit	5.175	5.175
Min Limit	4.75	4.75

krad(Si)	Serial #	pre_short (rtp)	(2)ST_Combo (rpt)	Delta
0	Ctrl	5.017	5.017	0.000
3	58	5.020	5.019	-0.001
3	59	5.007	5.006	-0.001
3	60	5.000	5.000	0.000
3	61	4.993	4.992	-0.001
3	62	4.987	4.986	-0.001
3	134	4.999	5.002	0.003
3	137	5.005	5.002	-0.003
3	138	4.985	5.002	0.017
3	139	4.995	4.996	0.001
3	236	5.005	5.008	0.003
10	63	4.987	4.985	-0.002
10	64	5.001	5.002	0.001
10	65	5.019	5.020	0.001
10	66	4.991	4.987	-0.004
10	150	5.007	5.005	-0.002
10	237	4.982	5.008	0.026
10	241	4.997	5.002	0.005
10	242	5.022	5.023	0.001
10	243	5.021	5.021	0.000
10	244	5.003	5.003	0.000
30	141	5.009	5.010	0.001
30	144	4.983	4.977	-0.006
30	145	5.011	5.006	-0.005
30	146	4.994	4.984	-0.009
30	147	4.997	4.994	-0.003
30	132	5.009	4.999	-0.009
30	133	4.998	4.999	0.001
30	135	5.005	4.988	-0.017
30	245	5.010	5.011	0.001
30	246	4.982	4.977	-0.004
50	67	5.009	5.011	0.002
50	68	4.999	5.005	0.007
50	69	4.989	4.984	-0.005
50	71	4.990	4.987	-0.003
50	72	4.982	4.983	0.001
50	172	4.992	4.986	-0.007
50	173	4.991	4.984	-0.007
50	174	5.001	4.992	-0.009
50	183	4.985	4.980	-0.005
50	186	4.987	4.983	-0.004
100	95	4.987	4.977	-0.010
100	102	4.984	4.990	0.005
100	104	5.005	5.025	0.020
100	105	4.998	5.019	0.021
100	106	4.990	4.962	-0.027
100	178	4.993	4.985	-0.008
100	179	4.996	4.994	-0.002
100	180	4.991	4.991	0.000
100	181	5.021	4.997	-0.024
100	182	5.010	5.034	0.023
	Max	5.022	5.034	0.026
	Average	4.999	4.998	-0.001
	Min	4.982	4.962	-0.027
	Std Dev	0.011	0.015	0.010

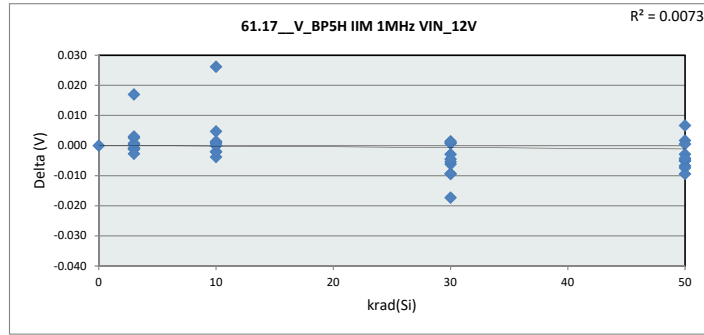

61.17 V BP5H IIM		
Test Site	DAL-FL	
Tester	ETS364	
Test Number	EB672302	
Max Limit	5.175	V
Min Limit	4.75	V

krad(Si)	0	3	10	30	50	100
LL	4.750	4.750	4.750	4.750	4.750	4.750
Min	5.017	4.986	4.985	4.977	4.980	4.962
Average	5.017	5.001	5.005	4.995	4.989	4.997
Max	5.017	5.019	5.023	5.011	5.011	5.034
UL	5.175	5.175	5.175	5.175	5.175	5.175

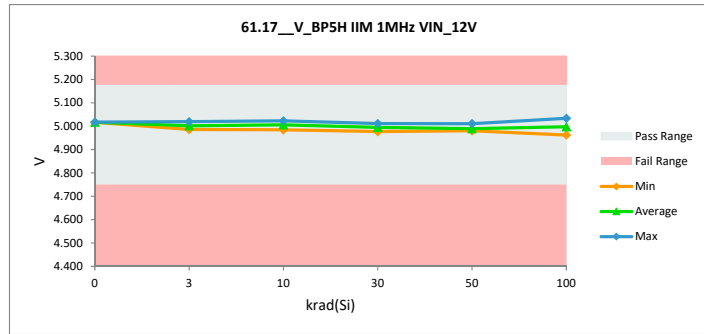

TID HDR Report
TPS7H6003-SP (5962R2220101VXC)

61.18_V_BP7L IIM 2MHz VIN_12V		
Test Site	DAL-FL	DAL-FL
Tester	ETS364	ETS364
Test Number	EB672302	EB672302
Unit	V	V
Max Limit	7.35	7.35
Min Limit	6.65	6.65

krad(Si)	Serial #	pre_short (rtp)	(2)'ST_Combo (rpt)	Delta
0	Ctrl	7.036	7.036	0.000
3	58	7.041	7.043	0.002
3	59	7.000	7.001	0.002
3	60	6.972	6.974	0.002
3	61	6.984	6.982	-0.002
3	62	6.963	6.962	-0.002
3	134	7.032	7.001	-0.031
3	137	6.939	7.001	0.063
3	138	7.027	7.001	-0.026
3	139	6.975	6.975	0.000
3	236	6.971	6.990	0.018
10	63	6.974	6.971	-0.003
10	64	6.997	6.993	-0.004
10	65	7.022	7.024	0.002
10	66	7.017	7.016	-0.002
10	150	7.016	7.010	-0.006
10	237	7.009	6.990	-0.020
10	241	7.017	7.001	-0.016
10	242	6.991	6.993	0.002
10	243	6.992	6.992	0.000
10	244	7.065	7.061	-0.005
30	141	7.032	7.029	-0.003
30	144	6.987	6.985	-0.002
30	145	7.029	7.028	-0.001
30	146	7.006	6.998	-0.008
30	147	7.009	7.002	-0.007
30	132	7.032	7.034	0.002
30	133	7.030	7.020	-0.010
30	135	6.992	7.027	0.035
30	245	6.987	6.983	-0.004
30	246	7.002	6.994	-0.008
50	67	7.033	7.027	-0.006
50	68	6.995	6.973	-0.022
50	69	7.034	7.041	0.008
50	71	6.980	6.973	-0.007
50	72	6.995	6.989	-0.006
50	172	7.013	6.975	-0.038
50	173	7.025	7.012	-0.013
50	174	7.001	7.005	0.004
50	183	7.008	7.008	0.000
50	186	6.977	6.979	0.003
100	95	6.990	7.017	0.027
100	102	6.944	6.935	-0.008
100	104	7.024	7.010	-0.015
100	105	7.011	6.984	-0.027
100	106	6.936	6.935	-0.001
100	178	7.041	7.024	-0.017
100	179	6.977	7.025	0.048
100	180	7.011	6.999	-0.012
100	181	7.016	7.006	-0.009
100	182	7.018	7.044	0.026
Max		7.065	7.061	0.063
Average		7.003	7.002	-0.002
Min		6.936	6.935	-0.038
Std Dev		0.027	0.026	0.018

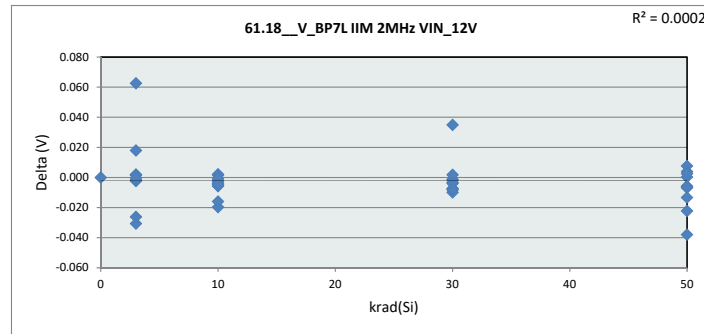

61.18_V_BP7L IIM		
Test Site	DAL-FL	
Tester	ETS364	
Test Number	EB672302	
Max Limit	7.35	V
Min Limit	6.65	V

krad(Si)	0	3	10	30	50	100
LL	6.650	6.650	6.650	6.650	6.650	6.650
Min	7.036	6.962	6.971	6.983	6.973	6.935
Average	7.036	6.993	7.005	7.010	6.998	6.998
Max	7.036	7.043	7.061	7.034	7.041	7.044
UL	7.350	7.350	7.350	7.350	7.350	7.350

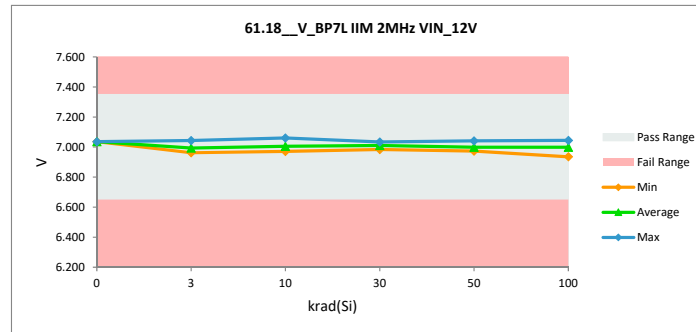

TID HDR Report
TPS7H6003-SP (5962R2220101VXC)

61.19_V_BP5L IIM 2MHz VIN_12V		
Test Site	DAL-FL	DAL-FL
Tester	ETS364	ETS364
Test Number	EB672302	EB672302
Unit	V	V
Max Limit	5.175	5.175
Min Limit	4.75	4.75

krad(Si)	Serial #	pre_short (rtp)	(2)'ST_Combo (rpt)	Delta
0	Ctrl	5.023	5.023	0.000
3	58	4.998	4.999	0.000
3	59	4.990	4.990	0.000
3	60	5.002	5.001	0.000
3	61	5.001	4.999	-0.002
3	62	5.011	5.012	0.001
3	134	4.996	5.003	0.008
3	137	4.987	5.003	0.016
3	138	5.004	5.004	0.000
3	139	5.006	5.007	0.002
3	236	5.014	4.996	-0.017
10	63	5.011	5.008	-0.003
10	64	4.995	4.995	0.000
10	65	5.023	5.021	-0.002
10	66	5.011	5.009	-0.002
10	150	5.003	4.999	-0.004
10	237	5.022	4.996	-0.025
10	241	5.021	5.003	-0.018
10	242	4.988	4.988	0.000
10	243	5.011	5.013	0.002
10	244	5.006	5.008	0.002
30	141	5.011	5.008	-0.003
30	144	5.022	5.021	0.000
30	145	5.018	5.015	-0.003
30	146	5.000	4.991	-0.009
30	147	5.029	5.028	-0.001
30	132	5.000	4.999	-0.002
30	133	5.014	5.012	-0.002
30	135	5.024	4.985	-0.039
30	245	5.012	5.006	-0.007
30	246	5.026	5.021	-0.005
50	67	4.990	4.985	-0.005
50	68	4.996	5.033	0.037
50	69	5.017	5.011	-0.006
50	71	5.009	5.009	0.000
50	72	5.007	4.999	-0.009
50	172	5.017	5.065	0.048
50	173	4.990	4.981	-0.009
50	174	5.019	5.017	-0.002
50	183	5.013	5.013	0.000
50	186	4.997	4.996	-0.002
100	95	5.003	4.985	-0.018
100	102	5.011	5.009	-0.002
100	104	4.998	4.976	-0.022
100	105	4.995	5.045	0.049
100	106	5.003	4.929	-0.074
100	178	5.020	5.027	0.006
100	179	4.993	4.971	-0.022
100	180	5.024	4.956	-0.068
100	181	5.007	4.996	-0.011
100	182	5.015	5.024	0.009
	Max	5.029	5.065	0.049
	Average	5.008	5.004	-0.004
	Min	4.987	4.929	-0.074
	Std Dev	0.011	0.021	0.020

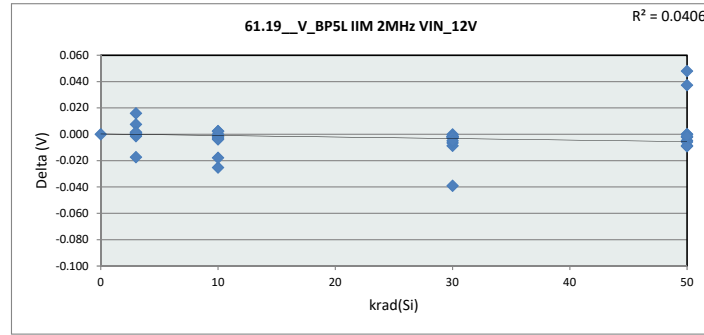

61.19_V_BP5L IIM		
Test Site	DAL-FL	
Tester	ETS364	
Test Number	EB672302	
Max Limit	5.175	V
Min Limit	4.75	V

krad(Si)	0	3	10	30	50	100
LL	4.750	4.750	4.750	4.750	4.750	4.750
Min	5.023	4.990	4.988	4.985	4.981	4.929
Average	5.023	5.001	5.004	5.009	5.011	4.992
Max	5.023	5.012	5.021	5.028	5.065	5.045
UL	5.175	5.175	5.175	5.175	5.175	5.175

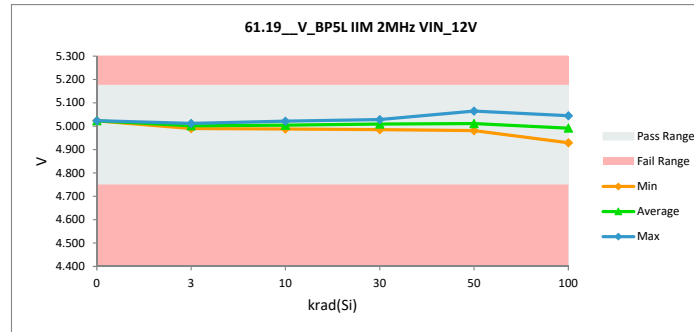

TID HDR Report
TPS7H6003-SP (5962R2220101VXC)

61.20_V_BP5H_IIM_2MHz_VIN		
Test Site	DAL-FL	DAL-FL
Tester	ETS364	ETS364
Test Number	EB672302	EB672302
Unit	V	V
Max Limit	5.175	5.175
Min Limit	4.75	4.75

krad(Si)	Serial #	pre_short (rtp)	(2)'ST_Combo (rpt)	Delta
0	Ctrl	5.018	5.018	0.000
3	58	5.022	5.021	-0.001
3	59	5.008	5.007	-0.001
3	60	5.001	5.001	0.000
3	61	4.995	4.994	-0.001
3	62	4.988	4.987	-0.001
3	134	5.001	5.003	0.002
3	137	5.006	5.003	-0.003
3	138	4.986	5.003	0.017
3	139	4.996	4.997	0.001
3	236	5.006	5.009	0.003
10	63	4.988	4.986	-0.002
10	64	5.002	5.003	0.002
10	65	5.021	5.022	0.001
10	66	4.992	4.988	-0.004
10	150	5.008	5.006	-0.002
10	237	4.983	5.009	0.026
10	241	4.999	5.003	0.004
10	242	5.023	5.024	0.001
10	243	5.022	5.022	0.000
10	244	5.004	5.005	0.000
30	141	5.011	5.011	0.001
30	144	4.984	4.978	-0.006
30	145	5.013	5.008	-0.005
30	146	4.996	4.986	-0.010
30	147	4.998	4.995	-0.003
30	132	5.010	5.000	-0.010
30	133	5.000	5.001	0.001
30	135	5.006	4.989	-0.017
30	245	5.011	5.013	0.002
30	246	4.983	4.979	-0.004
50	67	5.010	5.012	0.002
50	68	5.000	5.007	0.007
50	69	4.990	4.985	-0.005
50	71	4.991	4.989	-0.003
50	72	4.984	4.984	0.000
50	172	4.994	4.987	-0.006
50	173	4.992	4.985	-0.007
50	174	5.002	4.993	-0.010
50	183	4.986	4.982	-0.005
50	186	4.989	4.985	-0.004
100	95	4.989	4.978	-0.010
100	102	4.985	4.991	0.005
100	104	5.006	5.026	0.019
100	105	5.000	5.021	0.022
100	106	4.991	4.963	-0.028
100	178	4.994	4.986	-0.008
100	179	4.997	4.995	-0.002
100	180	4.992	4.992	0.000
100	181	5.022	4.997	-0.024
100	182	5.012	5.036	0.024
	Max	5.023	5.036	0.026
	Average	5.000	4.999	-0.001
	Min	4.983	4.963	-0.028
	Std Dev	0.011	0.015	0.010

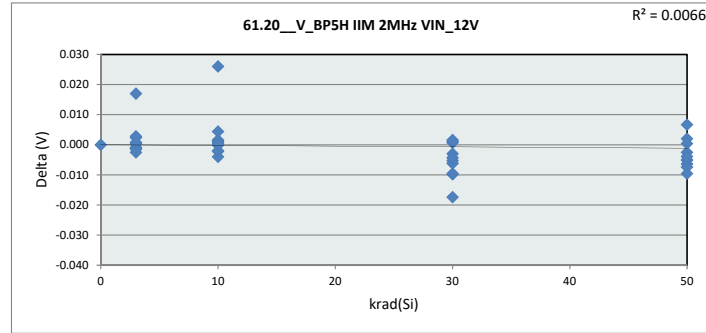

61.20_V_BP5H_IIM

Test Site	DAL-FL
Tester	ETS364
Test Number	EB672302
Max Limit	5.175 V
Min Limit	4.75 V

krad(Si)	0	3	10	30	50	100
LL	4.750	4.750	4.750	4.750	4.750	4.750
Min	5.018	4.987	4.986	4.978	4.982	4.963
Average	5.018	5.003	5.007	4.996	4.991	4.999
Max	5.018	5.021	5.024	5.013	5.012	5.036
UL	5.175	5.175	5.175	5.175	5.175	5.175

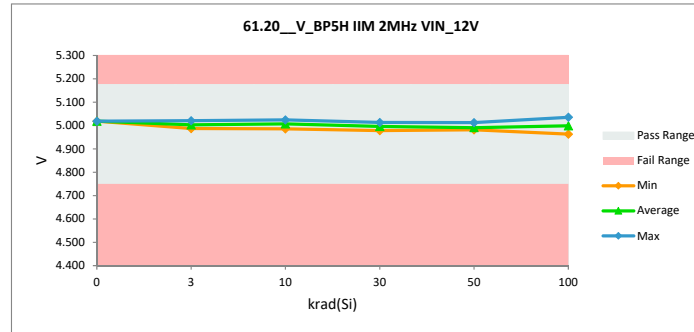

TID HDR Report
TPS7H6003-SP (5962R2220101VXC)

61.21_V_BP7L IIM 5MHz VIN_12V		
Test Site	DAL-FL	DAL-FL
Tester	ETS364	ETS364
Test Number	EB672302	EB672302
Unit	V	V
Max Limit	7.35	7.35
Min Limit	6.65	6.65

krad(Si)	Serial #	pre_short (rtp)	(2)'ST_Combo (rpt)	Delta
0	Ctrl	7.015	7.015	0.000
3	58	7.019	7.022	0.003
3	59	6.978	6.981	0.002
3	60	6.950	6.952	0.002
3	61	6.962	6.961	-0.001
3	62	6.942	6.941	-0.001
3	134	7.010	6.981	-0.029
3	137	6.918	6.981	0.064
3	138	7.006	6.981	-0.025
3	139	6.953	6.954	0.001
3	236	6.949	6.968	0.020
10	63	6.953	6.950	-0.002
10	64	6.976	6.972	-0.005
10	65	6.999	7.002	0.002
10	66	6.993	6.992	-0.001
10	150	6.993	6.987	-0.006
10	237	6.987	6.968	-0.019
10	241	6.994	6.981	-0.013
10	242	6.969	6.972	0.003
10	243	6.969	6.970	0.000
10	244	7.044	7.040	-0.004
30	141	7.009	7.005	-0.004
30	144	6.964	6.963	-0.001
30	145	7.008	7.005	-0.002
30	146	6.985	6.976	-0.009
30	147	6.986	6.978	-0.009
30	132	7.011	7.012	0.002
30	133	7.008	6.997	-0.010
30	135	6.970	7.005	0.035
30	245	6.964	6.961	-0.004
30	246	6.978	6.969	-0.010
50	67	7.010	7.003	-0.007
50	68	6.971	6.949	-0.022
50	69	7.012	7.021	0.008
50	71	6.957	6.950	-0.007
50	72	6.973	6.966	-0.007
50	172	6.991	6.954	-0.038
50	173	7.002	6.989	-0.013
50	174	6.978	6.984	0.006
50	183	6.987	6.989	0.002
50	186	6.955	6.959	0.004
100	95	6.968	6.994	0.025
100	102	6.921	6.912	-0.009
100	104	7.001	6.986	-0.016
100	105	6.989	6.961	-0.028
100	106	6.914	6.912	-0.002
100	178	7.017	7.002	-0.016
100	179	6.956	7.004	0.049
100	180	6.989	6.977	-0.011
100	181	6.993	6.985	-0.008
100	182	6.996	7.025	0.030
Max		7.044	7.040	0.064
Average		6.981	6.980	-0.002
Min		6.914	6.912	-0.038
Std Dev		0.027	0.026	0.018

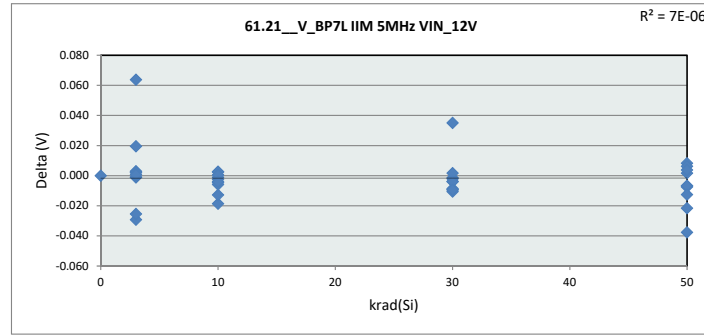

61.21_V_BP7L IIM		
Test Site	DAL-FL	
Tester	ETS364	
Test Number	EB672302	
Max Limit	7.35	V
Min Limit	6.65	V

krad(Si)	0	3	10	30	50	100
LL	6.650	6.650	6.650	6.650	6.650	6.650
Min	7.015	6.941	6.950	6.961	6.949	6.912
Average	7.015	6.972	6.983	6.987	6.976	6.976
Max	7.015	7.022	7.040	7.012	7.021	7.025
UL	7.350	7.350	7.350	7.350	7.350	7.350

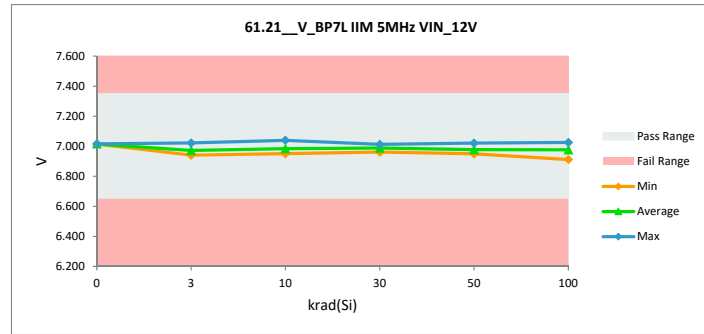

TID HDR Report
TPS7H6003-SP (5962R2220101VXC)

61.22_V_BP5L IIM 5MHz VIN		
Test Site	DAL-FL	DAL-FL
Tester	ETS364	ETS364
Test Number	EB672302	EB672302
Unit	V	V
Max Limit	5.175	5.175
Min Limit	4.75	4.75

krad(Si)	Serial #	pre_short (rtp)	(2)'ST_Combo (rpt)	Delta
0	Ctrl	5.040	5.040	0.000
3	58	5.015	5.015	0.000
3	59	5.005	5.006	0.000
3	60	5.018	5.018	-0.001
3	61	5.020	5.018	-0.002
3	62	5.027	5.028	0.002
3	134	5.010	5.022	0.011
3	137	5.003	5.021	0.019
3	138	5.019	5.022	0.002
3	139	5.021	5.023	0.002
3	236	5.028	5.012	-0.016
10	63	5.025	5.022	-0.003
10	64	5.010	5.010	0.001
10	65	5.038	5.037	-0.001
10	66	5.030	5.029	-0.001
10	150	5.019	5.016	-0.003
10	237	5.036	5.013	-0.024
10	241	5.036	5.022	-0.015
10	242	5.003	5.004	0.001
10	243	5.025	5.030	0.004
10	244	5.023	5.027	0.004
30	141	5.027	5.027	-0.001
30	144	5.037	5.039	0.002
30	145	5.032	5.032	-0.001
30	146	5.014	5.006	-0.007
30	147	5.044	5.045	0.001
30	132	5.016	5.017	0.000
30	133	5.030	5.029	-0.001
30	135	5.040	5.000	-0.040
30	245	5.029	5.023	-0.005
30	246	5.041	5.036	-0.004
50	67	5.006	5.003	-0.003
50	68	5.012	5.055	0.043
50	69	5.034	5.030	-0.004
50	71	5.025	5.027	0.002
50	72	5.022	5.015	-0.007
50	172	5.034	5.092	0.058
50	173	5.006	5.000	-0.007
50	174	5.036	5.038	0.002
50	183	5.029	5.033	0.004
50	186	5.012	5.014	0.002
100	95	5.018	5.002	-0.016
100	102	5.026	5.027	0.002
100	104	5.014	4.992	-0.021
100	105	5.011	5.069	0.058
100	106	5.018	4.938	-0.080
100	178	5.038	5.052	0.015
100	179	5.008	4.988	-0.020
100	180	5.039	4.968	-0.071
100	181	5.023	5.015	-0.008
100	182	5.030	5.045	0.015
	Max	5.044	5.092	0.058
	Average	5.024	5.021	-0.002
	Min	5.003	4.938	-0.080
	Std Dev	0.011	0.023	0.022

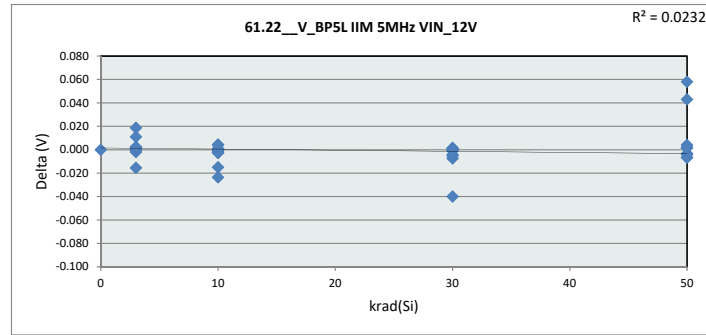

61.22_V_BP5L IIM						
Test Site	DAL-FL					
Tester	ETS364					
Test Number	EB672302					
Max Limit	5.175 V					
Min Limit	4.75 V					
krad(Si)	0	3	10	30	50	100
LL	4.750	4.750	4.750	4.750	4.750	4.750
Min	5.040	5.006	5.004	5.000	5.000	4.938
Average	5.040	5.018	5.021	5.025	5.031	5.010
Max	5.040	5.028	5.037	5.045	5.092	5.069
UL	5.175	5.175	5.175	5.175	5.175	5.175

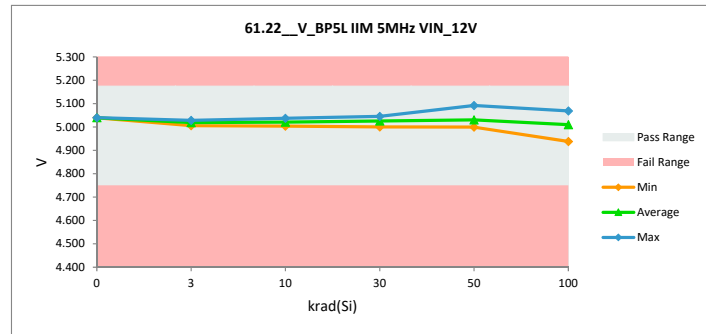

TID HDR Report
TPS7H6003-SP (5962R2220101VXC)

61.23_V_BP5H_IIM_5MHz_VIN		
Test Site	DAL-FL	DAL-FL
Tester	ETS364	ETS364
Test Number	EB672302	EB672302
Unit	V	V
Max Limit	5.175	5.175
Min Limit	4.75	4.75

krad(Si)	Serial #	pre_short (rtp)	(2)'ST_Combo (rpt)	Delta
0	Ctrl	5.023	5.023	0.000
3	58	5.026	5.025	-0.001
3	59	5.012	5.011	-0.001
3	60	5.005	5.005	0.000
3	61	4.999	4.998	-0.001
3	62	4.993	4.991	-0.002
3	134	5.005	5.008	0.003
3	137	5.010	5.008	-0.002
3	138	4.990	5.008	0.018
3	139	5.000	5.001	0.001
3	236	5.011	5.013	0.003
10	63	4.992	4.990	-0.003
10	64	5.006	5.007	0.002
10	65	5.025	5.026	0.001
10	66	4.996	4.992	-0.003
10	150	5.012	5.010	-0.002
10	237	4.987	5.013	0.026
10	241	5.004	5.008	0.005
10	242	5.027	5.028	0.001
10	243	5.026	5.026	0.000
10	244	5.009	5.009	0.001
30	141	5.015	5.016	0.001
30	144	4.988	4.982	-0.006
30	145	5.017	5.011	-0.005
30	146	5.000	4.990	-0.010
30	147	5.002	4.999	-0.003
30	132	5.014	5.003	-0.010
30	133	5.003	5.005	0.002
30	135	5.010	4.992	-0.017
30	245	5.015	5.017	0.002
30	246	4.987	4.983	-0.004
50	67	5.014	5.017	0.003
50	68	5.005	5.012	0.007
50	69	4.994	4.990	-0.005
50	71	4.995	4.993	-0.002
50	72	4.988	4.989	0.001
50	172	4.998	4.993	-0.006
50	173	4.997	4.990	-0.007
50	174	5.007	4.997	-0.010
50	183	4.991	4.985	-0.006
50	186	4.993	4.990	-0.003
100	95	4.993	4.983	-0.010
100	102	4.990	4.996	0.006
100	104	5.011	5.031	0.021
100	105	5.004	5.027	0.024
100	106	4.995	4.967	-0.028
100	178	4.998	4.991	-0.007
100	179	5.001	5.000	-0.001
100	180	4.996	4.997	0.001
100	181	5.026	5.001	-0.025
100	182	5.016	5.042	0.026
	Max	5.027	5.042	0.026
	Average	5.004	5.004	-0.001
	Min	4.987	4.967	-0.028
	Std Dev	0.011	0.015	0.010

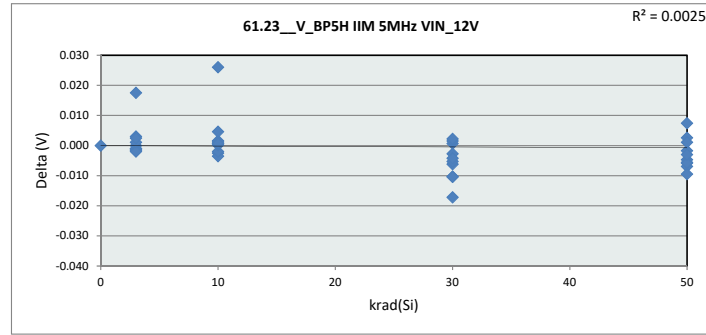

61.23_V_BP5H_IIM		
Test Site	DAL-FL	
Tester	ETS364	
Test Number	EB672302	
Max Limit	5.175	V
Min Limit	4.75	V

krad(Si)	0	3	10	30	50	100
LL	4.750	4.750	4.750	4.750	4.750	4.750
Min	5.023	4.991	4.990	4.982	4.985	4.967
Average	5.023	5.007	5.011	5.000	4.995	5.003
Max	5.023	5.025	5.028	5.018	5.017	5.042
UL	5.175	5.175	5.175	5.175	5.175	5.175

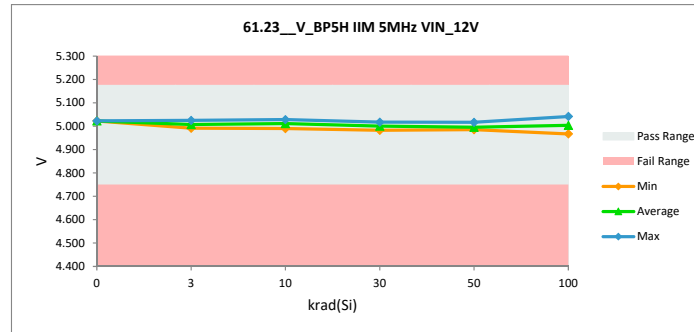

TID HDR Report

TPS7H6003-SP (5962R2220101VXC)

62.0_V_BP7L PWM 500kHz VIN		
Test Site	DAL-FL	DAL-FL
Tester	ETS364	ETS364
Test Number	EB672302	EB672302
Unit	V	V
Max Limit	7.35	7.35
Min Limit	6.65	6.65

krad(Si)	Serial #	pre_short (rtp)	(2)ST_Combo (rpt)	Delta
0	Ctrl	7.047	7.047	0.000
3	58	7.054	7.055	0.001
3	59	7.011	7.013	0.001
3	60	6.985	6.986	0.001
3	61	6.996	6.993	-0.003
3	62	6.975	6.973	-0.002
3	134	7.043	7.012	-0.031
3	137	6.950	7.013	0.062
3	138	7.039	7.012	-0.026
3	139	6.987	6.986	-0.001
3	236	6.984	7.001	0.017
10	63	6.985	6.982	-0.003
10	64	7.008	7.004	-0.004
10	65	7.035	7.037	0.002
10	66	7.030	7.029	-0.002
10	150	7.028	7.023	-0.005
10	237	7.021	7.001	-0.020
10	241	7.030	7.012	-0.017
10	242	7.003	7.004	0.001
10	243	7.004	7.004	-0.001
10	244	7.077	7.072	-0.005
30	141	7.044	7.041	-0.003
30	144	6.998	6.997	-0.001
30	145	7.041	7.040	-0.001
30	146	7.018	7.010	-0.008
30	147	7.022	7.015	-0.007
30	132	7.044	7.045	0.001
30	133	7.042	7.033	-0.009
30	135	7.004	7.039	0.034
30	245	6.999	6.995	-0.004
30	246	7.014	7.008	-0.006
50	67	7.045	7.041	-0.004
50	68	7.008	6.986	-0.022
50	69	7.045	7.051	0.006
50	71	6.992	6.986	-0.005
50	72	7.007	7.001	-0.006
50	172	7.025	6.991	-0.034
50	173	7.037	7.024	-0.013
50	174	7.013	7.015	0.002
50	183	7.019	7.019	-0.001
50	186	6.988	6.990	0.002
100	95	7.003	7.029	0.026
100	102	6.956	6.949	-0.007
100	104	7.037	7.023	-0.013
100	105	7.023	6.998	-0.025
100	106	6.948	6.948	0.000
100	178	7.054	7.037	-0.017
100	179	6.989	7.033	0.045
100	180	7.024	7.011	-0.013
100	181	7.028	7.017	-0.011
100	182	7.030	7.056	0.026
	Max	7.077	7.072	0.062
	Average	7.016	7.014	-0.002
	Min	6.948	6.948	-0.034
	Std Dev	0.027	0.026	0.017

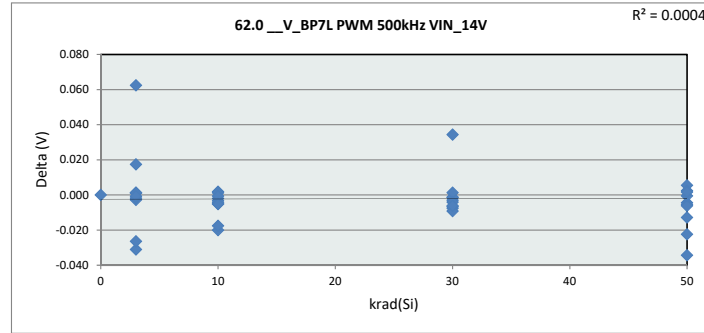

62.0_V_BP7L PWM		
Test Site	DAL-FL	
Tester	ETS364	
Test Number	EB672302	
Max Limit	7.35	V
Min Limit	6.65	V

krad(Si)	0	3	10	30	50	100
LL	6.650	6.650	6.650	6.650	6.650	6.650
Min	7.047	6.973	6.982	6.995	6.986	6.948
Average	7.047	7.004	7.017	7.022	7.010	7.010
Max	7.047	7.055	7.072	7.045	7.051	7.056
UL	7.350	7.350	7.350	7.350	7.350	7.350

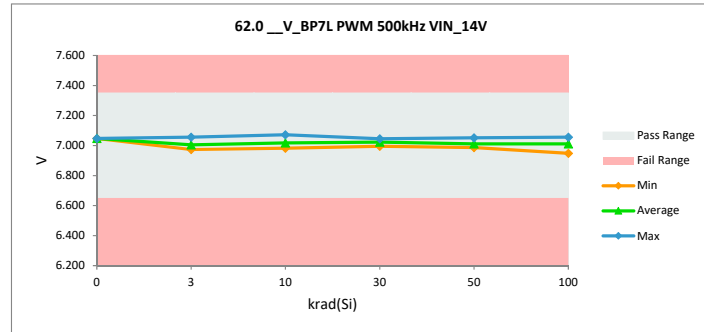

TID HDR Report
TPS7H6003-SP (5962R2220101VXC)

62.1 _V_BP5L PWM 500kHz VIN		
Test Site	DAL-FL	DAL-FL
Tester	ETS364	ETS364
Test Number	EB672302	EB672302
Unit	V	V
Max Limit	5.175	5.175
Min Limit	4.75	4.75

krad(Si)	Serial #	pre_short (rtp)	(2)'ST_Combo (rpt)	Delta
0	Ctrl	5.016	5.016	0.000
3	58	4.992	4.992	0.000
3	59	4.983	4.983	0.001
3	60	4.995	4.995	0.000
3	61	4.993	4.992	-0.001
3	62	5.004	5.005	0.001
3	134	4.989	4.996	0.006
3	137	4.981	4.996	0.015
3	138	4.997	4.996	-0.001
3	139	4.999	5.001	0.001
3	236	5.008	4.989	-0.018
10	63	5.004	5.001	-0.003
10	64	4.989	4.989	0.000
10	65	5.017	5.015	-0.002
10	66	5.004	5.002	-0.002
10	150	4.996	4.992	-0.004
10	237	5.016	4.990	-0.026
10	241	5.015	4.996	-0.019
10	242	4.982	4.982	0.000
10	243	5.004	5.006	0.002
10	244	4.999	5.001	0.001
30	141	5.004	5.001	-0.003
30	144	5.015	5.014	-0.001
30	145	5.012	5.009	-0.004
30	146	4.994	4.984	-0.009
30	147	5.023	5.021	-0.002
30	132	4.994	4.991	-0.003
30	133	5.008	5.005	-0.002
30	135	5.018	4.979	-0.038
30	245	5.005	4.998	-0.007
30	246	5.021	5.015	-0.005
50	67	4.983	4.978	-0.005
50	68	4.989	5.023	0.035
50	69	5.010	5.003	-0.006
50	71	5.002	5.001	-0.001
50	72	5.001	4.992	-0.010
50	172	5.010	5.053	0.043
50	173	4.983	4.973	-0.010
50	174	5.012	5.008	-0.004
50	183	5.006	5.004	-0.002
50	186	4.991	4.988	-0.003
100	95	4.997	4.978	-0.019
100	102	5.005	5.002	-0.003
100	104	4.992	4.969	-0.023
100	105	4.989	5.035	0.046
100	106	4.997	4.926	-0.071
100	178	5.013	5.016	0.003
100	179	4.986	4.964	-0.022
100	180	5.018	4.952	-0.066
100	181	5.000	4.988	-0.012
100	182	5.009	5.015	0.006
Max		5.023	5.053	0.046
Average		5.001	4.996	-0.005
Min		4.981	4.926	-0.071
Std Dev		0.011	0.020	0.019

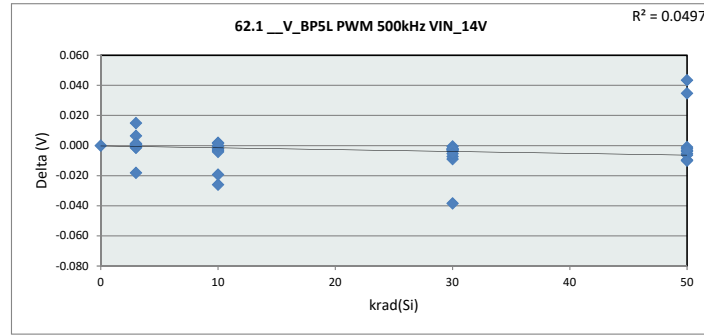

62.1 _V_BP5L PWM		
Test Site	DAL-FL	
Tester	ETS364	
Test Number	EB672302	
Max Limit	5.175	V
Min Limit	4.75	V

krad(Si)	0	3	10	30	50	100
LL	4.750	4.750	4.750	4.750	4.750	4.750
Min	5.016	4.983	4.982	4.979	4.973	4.926
Average	5.016	4.994	4.997	5.002	5.002	4.984
Max	5.016	5.005	5.015	5.021	5.053	5.035
UL	5.175	5.175	5.175	5.175	5.175	5.175

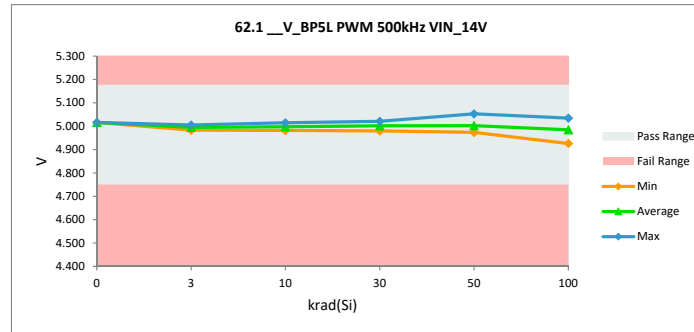

TID HDR Report
TPS7H6003-SP (5962R2220101VXC)

62.2_V_BP5H PWM 500kHz VI		
Test Site	DAL-FL	DAL-FL
Tester	ETS364	ETS364
Test Number	EB672302	EB672302
Unit	V	V
Max Limit	5.175	5.175
Min Limit	4.75	4.75

krad(Si)	Serial #	pre_short (rtp)	(2)'ST_Combo (rpt)	Delta
0	Ctrl	5.017	5.017	0.000
3	58	5.019	5.019	-0.001
3	59	5.006	5.005	-0.001
3	60	4.999	4.999	0.001
3	61	4.993	4.992	-0.001
3	62	4.986	4.985	-0.001
3	134	4.999	5.001	0.003
3	137	5.004	5.002	-0.002
3	138	4.984	5.001	0.017
3	139	4.994	4.995	0.001
3	236	5.004	5.008	0.003
10	63	4.986	4.984	-0.002
10	64	5.000	5.001	0.001
10	65	5.019	5.020	0.001
10	66	4.990	4.986	-0.004
10	150	5.006	5.004	-0.002
10	237	4.981	5.008	0.026
10	241	4.997	5.001	0.005
10	242	5.021	5.022	0.001
10	243	5.020	5.020	0.000
10	244	5.002	5.002	0.000
30	141	5.009	5.010	0.001
30	144	4.982	4.976	-0.006
30	145	5.011	5.006	-0.005
30	146	4.993	4.984	-0.010
30	147	4.996	4.993	-0.003
30	132	5.008	4.999	-0.009
30	133	4.998	4.999	0.001
30	135	5.004	4.987	-0.017
30	245	5.009	5.011	0.001
30	246	4.981	4.977	-0.004
50	67	5.009	5.010	0.002
50	68	4.998	5.005	0.006
50	69	4.988	4.983	-0.006
50	71	4.989	4.986	-0.003
50	72	4.982	4.982	0.000
50	172	4.992	4.985	-0.007
50	173	4.990	4.983	-0.007
50	174	5.000	4.991	-0.009
50	183	4.984	4.980	-0.004
50	186	4.986	4.983	-0.004
100	95	4.986	4.976	-0.010
100	102	4.983	4.988	0.005
100	104	5.004	5.023	0.018
100	105	4.998	5.018	0.020
100	106	4.989	4.962	-0.028
100	178	4.992	4.984	-0.008
100	179	4.996	4.992	-0.003
100	180	4.990	4.990	0.000
100	181	5.020	4.997	-0.023
100	182	5.010	5.032	0.022
	Max	5.021	5.032	0.026
	Average	4.998	4.997	-0.001
	Min	4.981	4.962	-0.028
	Std Dev	0.012	0.015	0.010

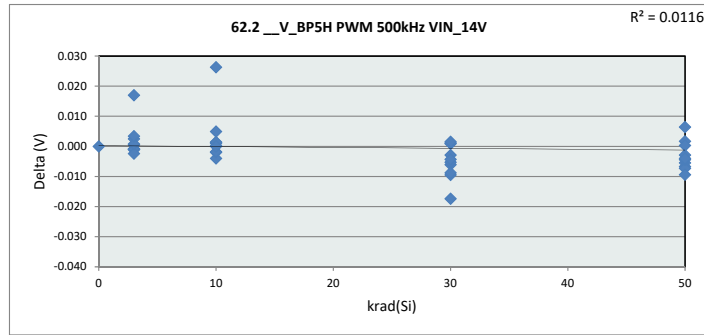

62.2_V_BP5H PWM		
Test Site	DAL-FL	
Tester	ETS364	
Test Number	EB672302	
Max Limit	5.175	V
Min Limit	4.75	V

krad(Si)	0	3	10	30	50	100
LL	4.750	4.750	4.750	4.750	4.750	4.750
Min	5.017	4.985	4.984	4.976	4.980	4.962
Average	5.017	5.001	5.005	4.994	4.989	4.996
Max	5.017	5.019	5.022	5.011	5.010	5.032
UL	5.175	5.175	5.175	5.175	5.175	5.175

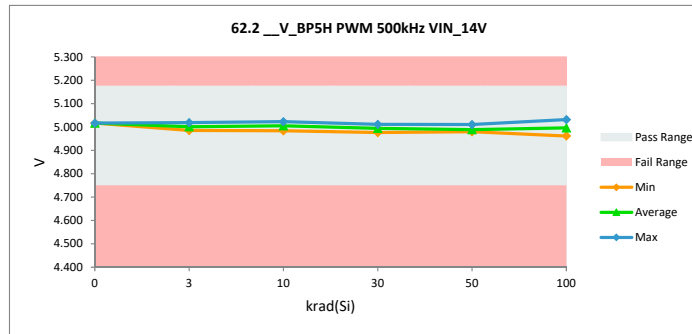

TID HDR Report
TPS7H6003-SP (5962R2220101VXC)

62.3 V_BP7L PWM 1MHz VIN		
Test Site	DAL-FL	DAL-FL
Tester	ETS364	ETS364
Test Number	EB672302	EB672302
Unit	V	V
Max Limit	7.35	7.35
Min Limit	6.65	6.65

krad(Si)	Serial #	pre_short (rtp)	(2)'ST_Combo (rpt)	Delta
0	Ctrl	7.044	7.044	0.000
3	58	7.050	7.051	0.001
3	59	7.008	7.009	0.001
3	60	6.981	6.982	0.001
3	61	6.992	6.990	-0.003
3	62	6.972	6.970	-0.002
3	134	7.040	7.009	-0.031
3	137	6.947	7.009	0.062
3	138	7.035	7.009	-0.026
3	139	6.983	6.983	-0.001
3	236	6.980	6.998	0.018
10	63	6.982	6.978	-0.003
10	64	7.005	7.001	-0.004
10	65	7.031	7.033	0.002
10	66	7.027	7.025	-0.002
10	150	7.024	7.019	-0.005
10	237	7.017	6.998	-0.020
10	241	7.026	7.009	-0.017
10	242	7.000	7.001	0.001
10	243	7.001	7.000	-0.001
10	244	7.074	7.069	-0.005
30	141	7.041	7.037	-0.003
30	144	6.995	6.994	-0.002
30	145	7.038	7.036	-0.002
30	146	7.015	7.007	-0.008
30	147	7.018	7.011	-0.007
30	132	7.040	7.042	0.002
30	133	7.039	7.029	-0.009
30	135	7.001	7.035	0.034
30	245	6.996	6.991	-0.004
30	246	7.011	7.004	-0.007
50	67	7.042	7.037	-0.005
50	68	7.004	6.982	-0.022
50	69	7.042	7.048	0.006
50	71	6.988	6.982	-0.006
50	72	7.004	6.997	-0.006
50	172	7.022	6.986	-0.036
50	173	7.034	7.021	-0.013
50	174	7.009	7.012	0.003
50	183	7.016	7.016	0.000
50	186	6.985	6.986	0.002
100	95	6.999	7.025	0.026
100	102	6.952	6.945	-0.008
100	104	7.033	7.020	-0.014
100	105	7.020	6.994	-0.026
100	106	6.945	6.944	-0.001
100	178	7.050	7.033	-0.017
100	179	6.985	7.031	0.046
100	180	7.020	7.008	-0.012
100	181	7.024	7.014	-0.011
100	182	7.026	7.053	0.026
	Max	7.074	7.069	0.062
	Average	7.012	7.010	-0.002
	Min	6.945	6.944	-0.036
	Std Dev	0.027	0.026	0.017

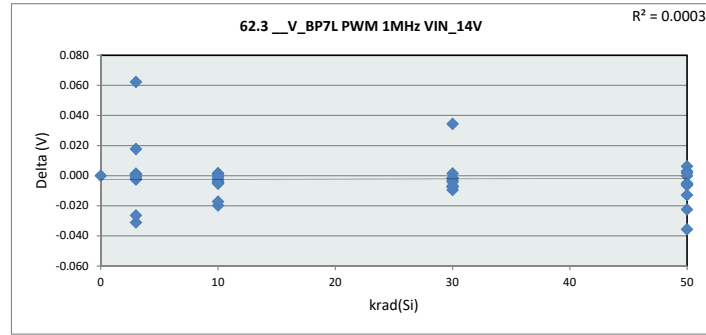

62.3 V_BP7L PWM

Test Site	DAL-FL
Tester	ETS364
Test Number	EB672302
Max Limit	7.35 V
Min Limit	6.65 V

krad(Si)	0	3	10	30	50	100
LL	6.650	6.650	6.650	6.650	6.650	6.650
Min	7.044	6.970	6.979	6.991	6.982	6.944
Average	7.044	7.001	7.013	7.019	7.007	7.007
Max	7.044	7.051	7.069	7.042	7.048	7.053
UL	7.350	7.350	7.350	7.350	7.350	7.350

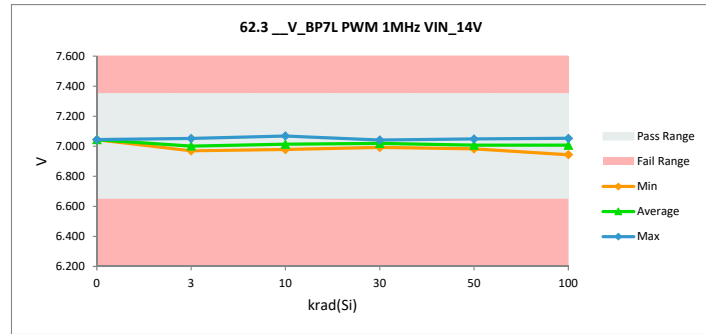

TID HDR Report
TPS7H6003-SP (5962R2220101VXC)

62.4 V BP5L PWM 1MHz VIN		
Test Site	DAL-FL	DAL-FL
Tester	ETS364	ETS364
Test Number	EB672302	EB672302
Unit	V	V
Max Limit	5.175	5.175
Min Limit	4.75	4.75

krad(Si)	Serial #	pre_short (rtp) (2)'ST	Combo (rpt) (Delta
0	Ctrl	5.019	5.019	0.000
3	58	4.994	4.995	0.000
3	59	4.985	4.986	0.001
3	60	4.997	4.997	0.000
3	61	4.996	4.995	-0.002
3	62	5.007	5.008	0.001
3	134	4.992	4.998	0.007
3	137	4.983	4.998	0.015
3	138	4.999	4.999	-0.001
3	139	5.002	5.003	0.002
3	236	5.010	4.992	-0.018
10	63	5.007	5.004	-0.003
10	64	4.991	4.991	0.000
10	65	5.019	5.017	-0.002
10	66	5.007	5.005	-0.002
10	150	4.998	4.994	-0.004
10	237	5.018	4.992	-0.026
10	241	5.017	4.999	-0.019
10	242	4.984	4.984	0.000
10	243	5.007	5.009	0.002
10	244	5.002	5.003	0.002
30	141	5.006	5.003	-0.003
30	144	5.017	5.017	0.000
30	145	5.014	5.011	-0.003
30	146	4.996	4.987	-0.009
30	147	5.025	5.024	-0.002
30	132	4.996	4.994	-0.002
30	133	5.010	5.008	-0.002
30	135	5.020	4.982	-0.039
30	245	5.008	5.001	-0.007
30	246	5.023	5.017	-0.005
50	67	4.986	4.981	-0.005
50	68	4.991	5.027	0.036
50	69	5.012	5.006	-0.006
50	71	5.004	5.003	-0.001
50	72	5.004	4.995	-0.009
50	172	5.012	5.057	0.045
50	173	4.986	4.976	-0.010
50	174	5.015	5.011	-0.003
50	183	5.009	5.007	-0.001
50	186	4.993	4.991	-0.003
100	95	4.999	4.980	-0.019
100	102	5.007	5.005	-0.002
100	104	4.994	4.972	-0.022
100	105	4.991	5.039	0.048
100	106	4.999	4.927	-0.072
100	178	5.016	5.020	0.004
100	179	4.989	4.967	-0.022
100	180	5.020	4.954	-0.066
100	181	5.003	4.991	-0.012
100	182	5.011	5.018	0.007
	Max	5.025	5.057	0.048
	Average	5.004	4.999	-0.005
	Min	4.983	4.927	-0.072
	Std Dev	0.011	0.020	0.020

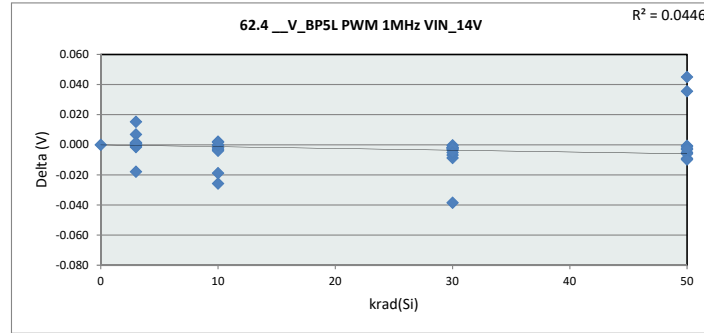

62.4 V BP5L PWM

Test Site	DAL-FL
Tester	ETS364
Test Number	EB672302
Max Limit	5.175 V
Min Limit	4.75 V

krad(Si)	0	3	10	30	50	100
LL	4.750	4.750	4.750	4.750	4.750	4.750
Min	5.019	4.986	4.984	4.982	4.976	4.927
Average	5.019	4.997	5.000	5.004	5.005	4.987
Max	5.019	5.008	5.017	5.024	5.057	5.039
UL	5.175	5.175	5.175	5.175	5.175	5.175

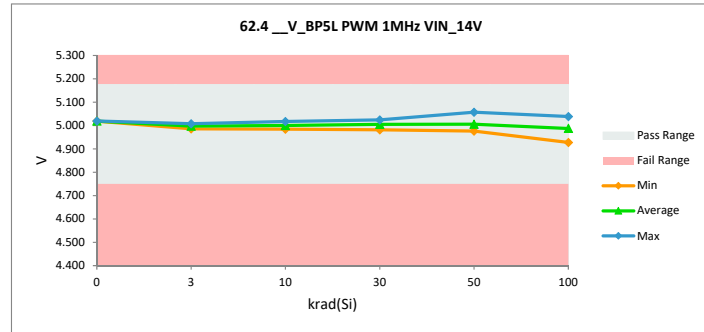

TID HDR Report
TPS7H6003-SP (5962R2220101VXC)

62.5 V BP5H PWM 1MHz VIN		
Test Site	DAL-FL	DAL-FL
Tester	ETS364	ETS364
Test Number	EB672302	EB672302
Unit	V	V
Max Limit	5.175	5.175
Min Limit	4.75	4.75

krad(Si)	Serial #	pre_short (rtp)	(2)'ST_Combo (rpt)	Delta
0	Ctrl	5.017	5.017	0.000
3	58	5.020	5.019	-0.001
3	59	5.007	5.006	-0.001
3	60	5.000	5.000	0.000
3	61	4.993	4.992	-0.001
3	62	4.987	4.986	-0.001
3	134	5.000	5.002	0.002
3	137	5.005	5.002	-0.002
3	138	4.985	5.002	0.017
3	139	4.995	4.996	0.001
3	236	5.005	5.008	0.003
10	63	4.987	4.984	-0.002
10	64	5.001	5.002	0.001
10	65	5.020	5.021	0.001
10	66	4.991	4.987	-0.004
10	150	5.007	5.005	-0.002
10	237	4.982	5.008	0.026
10	241	4.997	5.002	0.005
10	242	5.022	5.023	0.001
10	243	5.021	5.021	0.000
10	244	5.003	5.003	0.000
30	141	5.009	5.010	0.001
30	144	4.983	4.977	-0.006
30	145	5.012	5.006	-0.005
30	146	4.994	4.985	-0.010
30	147	4.997	4.994	-0.003
30	132	5.009	5.000	-0.009
30	133	4.998	4.999	0.001
30	135	5.005	4.988	-0.017
30	245	5.010	5.012	0.002
30	246	4.982	4.978	-0.004
50	67	5.009	5.011	0.002
50	68	4.999	5.005	0.007
50	69	4.989	4.984	-0.005
50	71	4.990	4.987	-0.003
50	72	4.982	4.983	0.000
50	172	4.992	4.986	-0.007
50	173	4.991	4.984	-0.007
50	174	5.001	4.992	-0.010
50	183	4.985	4.981	-0.004
50	186	4.987	4.983	-0.004
100	95	4.987	4.977	-0.010
100	102	4.984	4.989	0.005
100	104	5.005	5.024	0.019
100	105	4.998	5.019	0.021
100	106	4.990	4.962	-0.028
100	178	4.993	4.985	-0.008
100	179	4.996	4.993	-0.003
100	180	4.991	4.991	0.000
100	181	5.021	4.997	-0.023
100	182	5.011	5.033	0.022
Max		5.022	5.033	0.026
Average		4.999	4.998	-0.001
Min		4.982	4.962	-0.028
Std Dev		0.012	0.015	0.010

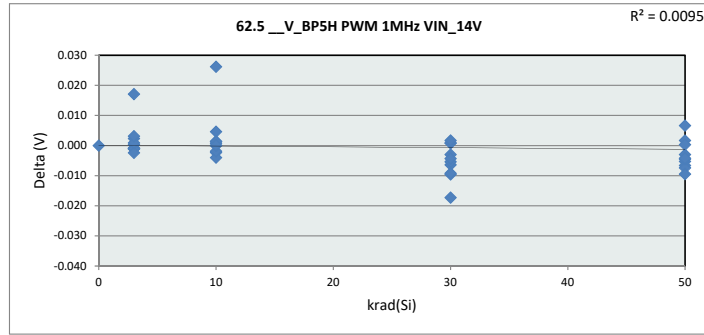

62.5 V BP5H PWM		
Test Site	DAL-FL	
Tester	ETS364	
Test Number	EB672302	
Max Limit	5.175	V
Min Limit	4.75	V

krad(Si)	0	3	10	30	50	100
LL	4.750	4.750	4.750	4.750	4.750	4.750
Min	5.017	4.986	4.985	4.977	4.981	4.962
Average	5.017	5.001	5.006	4.995	4.989	4.997
Max	5.017	5.020	5.023	5.012	5.011	5.033
UL	5.175	5.175	5.175	5.175	5.175	5.175

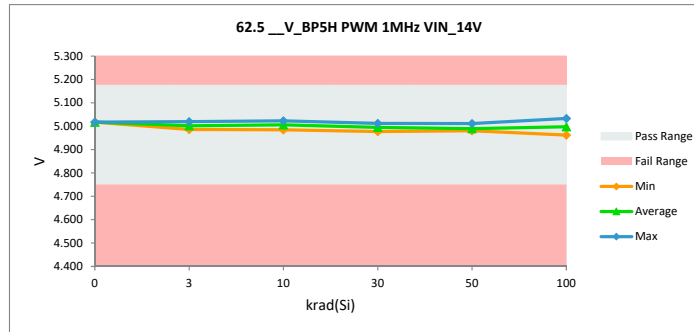

TID HDR Report
TPS7H6003-SP (5962R2220101VXC)

62.6_V_BP7L PWM 2MHz VIN		
Test Site	DAL-FL	DAL-FL
Tester	ETS364	ETS364
Test Number	EB672302	EB672302
Unit	V	V
Max Limit	7.35	7.35
Min Limit	6.65	6.65

krad(Si)	Serial #	pre_short (rtp)	(2)ST_Combo (rpt)	Delta
0	Ctrl	7.037	7.037	0.000
3	58	7.043	7.045	0.001
3	59	7.001	7.003	0.002
3	60	6.974	6.976	0.001
3	61	6.986	6.983	-0.002
3	62	6.965	6.963	-0.002
3	134	7.034	7.003	-0.031
3	137	6.940	7.003	0.062
3	138	7.029	7.003	-0.026
3	139	6.977	6.976	-0.001
3	236	6.973	6.991	0.018
10	63	6.976	6.972	-0.004
10	64	6.999	6.994	-0.005
10	65	7.025	7.026	0.001
10	66	7.019	7.017	-0.002
10	150	7.017	7.012	-0.006
10	237	7.011	6.991	-0.020
10	241	7.019	7.003	-0.017
10	242	6.993	6.994	0.001
10	243	6.994	6.994	-0.001
10	244	7.067	7.062	-0.005
30	141	7.034	7.031	-0.003
30	144	6.988	6.987	-0.001
30	145	7.031	7.030	-0.001
30	146	7.008	7.000	-0.008
30	147	7.011	7.004	-0.007
30	132	7.033	7.035	0.002
30	133	7.032	7.022	-0.010
30	135	6.994	7.029	0.034
30	245	6.989	6.984	-0.004
30	246	7.003	6.996	-0.008
50	67	7.035	7.029	-0.006
50	68	6.997	6.974	-0.023
50	69	7.035	7.042	0.007
50	71	6.982	6.975	-0.007
50	72	6.997	6.990	-0.007
50	172	7.015	6.978	-0.037
50	173	7.027	7.014	-0.013
50	174	7.003	7.006	0.004
50	183	7.009	7.010	0.000
50	186	6.978	6.980	0.002
100	95	6.992	7.019	0.026
100	102	6.946	6.937	-0.009
100	104	7.026	7.012	-0.015
100	105	7.013	6.986	-0.027
100	106	6.938	6.937	-0.001
100	178	7.043	7.026	-0.017
100	179	6.979	7.026	0.047
100	180	7.013	7.001	-0.013
100	181	7.018	7.008	-0.010
100	182	7.020	7.046	0.027
	Max	7.067	7.062	0.062
	Average	7.005	7.003	-0.002
	Min	6.938	6.937	-0.037
	Std Dev	0.027	0.026	0.018

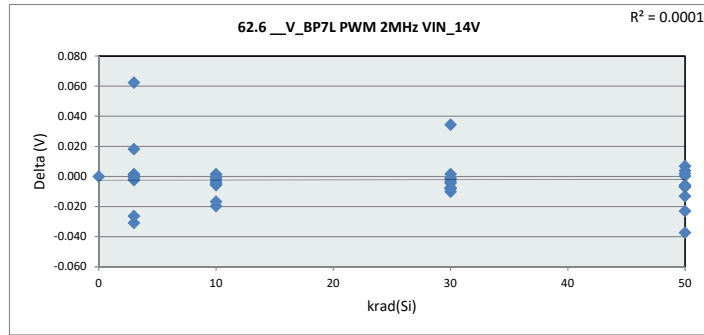

62.6_V_BP7L PWM		
Test Site	DAL-FL	
Tester	ETS364	
Test Number	EB672302	
Max Limit	7.35	V
Min Limit	6.65	V

krad(Si)	0	3	10	30	50	100
LL	6.650	6.650	6.650	6.650	6.650	6.650
Min	7.037	6.963	6.972	6.985	6.974	6.937
Average	7.037	6.995	7.006	7.012	7.000	7.000
Max	7.037	7.045	7.062	7.035	7.042	7.046
UL	7.350	7.350	7.350	7.350	7.350	7.350

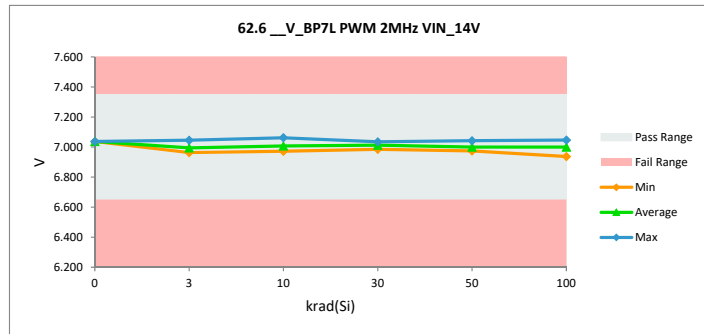

TID HDR Report
TPS7H6003-SP (5962R2220101VXC)

62.7 _V_BP5L PWM 2MHz VIN		
Test Site	DAL-FL	DAL-FL
Tester	ETS364	ETS364
Test Number	EB672302	EB672302
Unit	V	V
Max Limit	5.175	5.175
Min Limit	4.75	4.75

krad(Si)	Serial #	pre_short (rtp)	(2)'ST_Combo (rpt) (Delta
0	Ctrl	5.024	5.024	0.000
3	58	4.999	5.000	0.000
3	59	4.990	4.991	0.001
3	60	5.002	5.002	0.000
3	61	5.002	5.001	-0.001
3	62	5.012	5.013	0.001
3	134	4.996	5.004	0.008
3	137	4.988	5.004	0.016
3	138	5.004	5.004	0.000
3	139	5.006	5.008	0.002
3	236	5.014	4.997	-0.017
10	63	5.011	5.009	-0.003
10	64	4.996	4.996	0.000
10	65	5.024	5.022	-0.001
10	66	5.012	5.010	-0.002
10	150	5.003	5.000	-0.003
10	237	5.022	4.997	-0.025
10	241	5.022	5.004	-0.018
10	242	4.989	4.989	0.000
10	243	5.011	5.014	0.003
10	244	5.007	5.009	0.002
30	141	5.011	5.009	-0.002
30	144	5.022	5.022	0.000
30	145	5.019	5.016	-0.002
30	146	5.000	4.992	-0.008
30	147	5.030	5.029	-0.001
30	132	5.001	4.999	-0.002
30	133	5.015	5.014	-0.001
30	135	5.025	4.986	-0.039
30	245	5.013	5.007	-0.006
30	246	5.027	5.022	-0.005
50	67	4.991	4.987	-0.004
50	68	4.996	5.034	0.038
50	69	5.018	5.012	-0.005
50	71	5.009	5.009	0.000
50	72	5.008	5.000	-0.008
50	172	5.017	5.066	0.048
50	173	4.991	4.982	-0.009
50	174	5.020	5.018	-0.002
50	183	5.014	5.014	0.000
50	186	4.998	4.997	-0.001
100	95	5.004	4.986	-0.018
100	102	5.012	5.011	-0.001
100	104	4.999	4.977	-0.022
100	105	4.996	5.046	0.050
100	106	5.004	4.931	-0.073
100	178	5.021	5.028	0.007
100	179	4.994	4.972	-0.022
100	180	5.025	4.957	-0.068
100	181	5.008	4.997	-0.011
100	182	5.016	5.025	0.009
Max		5.030	5.066	0.050
Average		5.009	5.005	-0.004
Min		4.988	4.931	-0.073
Std Dev		0.011	0.021	0.020

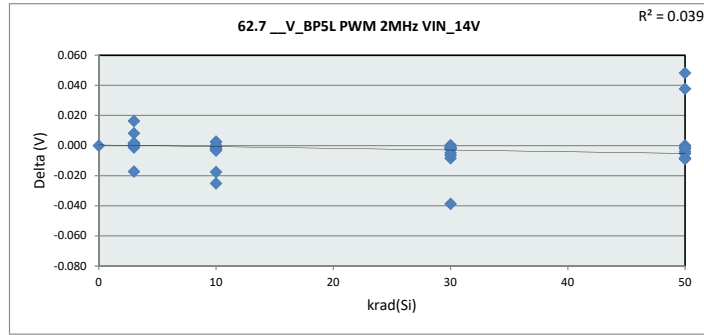

62.7 _V_BP5L PWM		
Test Site	DAL-FL	
Tester	ETS364	
Test Number	EB672302	
Max Limit	5.175	V
Min Limit	4.75	V

krad(Si)	0	3	10	30	50	100
LL	4.750	4.750	4.750	4.750	4.750	4.750
Min	5.024	4.991	4.989	4.987	4.982	4.931
Average	5.024	5.002	5.005	5.010	5.012	4.993
Max	5.024	5.013	5.022	5.029	5.066	5.046
UL	5.175	5.175	5.175	5.175	5.175	5.175

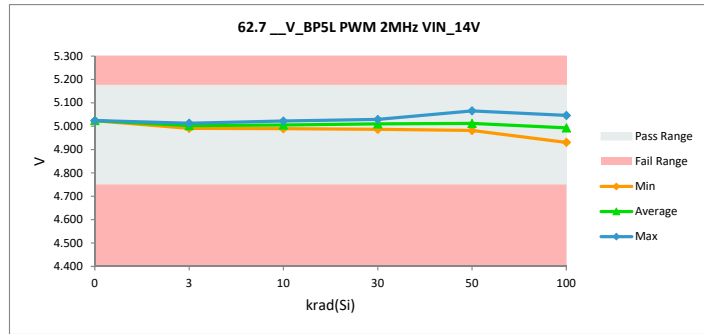

TID HDR Report
TPS7H6003-SP (5962R2220101VXC)

62.8 __V_BP5H_PWM_2MHz_VIN		
Test Site	DAL-FL	DAL-FL
Tester	ETS364	ETS364
Test Number	EB672302	EB672302
Unit	V	V
Max Limit	5.175	5.175
Min Limit	4.75	4.75

krad(Si)	Serial #	pre_short (rtp)	(2)'ST_Combo (rpt)	Delta
0	Ctrl	5.019	5.019	0.000
3	58	5.022	5.021	-0.001
3	59	5.009	5.007	-0.001
3	60	5.002	5.002	0.000
3	61	4.995	4.994	-0.001
3	62	4.989	4.988	-0.001
3	134	5.002	5.004	0.003
3	137	5.006	5.004	-0.002
3	138	4.987	5.004	0.017
3	139	4.996	4.997	0.001
3	236	5.007	5.010	0.003
10	63	4.988	4.986	-0.002
10	64	5.002	5.004	0.001
10	65	5.021	5.022	0.001
10	66	4.993	4.989	-0.004
10	150	5.008	5.006	-0.002
10	237	4.984	5.010	0.026
10	241	4.999	5.004	0.005
10	242	5.023	5.024	0.001
10	243	5.022	5.022	0.000
10	244	5.005	5.005	0.000
30	141	5.011	5.012	0.001
30	144	4.985	4.978	-0.006
30	145	5.013	5.008	-0.005
30	146	4.996	4.986	-0.010
30	147	4.999	4.996	-0.003
30	132	5.011	5.001	-0.010
30	133	5.000	5.001	0.001
30	135	5.006	4.989	-0.017
30	245	5.012	5.013	0.002
30	246	4.984	4.979	-0.005
50	67	5.011	5.013	0.002
50	68	5.001	5.008	0.007
50	69	4.991	4.985	-0.005
50	71	4.991	4.989	-0.003
50	72	4.984	4.984	0.000
50	172	4.994	4.988	-0.007
50	173	4.993	4.985	-0.007
50	174	5.003	4.993	-0.010
50	183	4.987	4.982	-0.005
50	186	4.989	4.985	-0.004
100	95	4.989	4.979	-0.010
100	102	4.986	4.991	0.005
100	104	5.007	5.026	0.019
100	105	5.000	5.021	0.021
100	106	4.992	4.964	-0.027
100	178	4.995	4.987	-0.008
100	179	4.998	4.996	-0.002
100	180	4.993	4.993	0.000
100	181	5.022	4.998	-0.024
100	182	5.012	5.035	0.023
Max		5.023	5.035	0.026
Average		5.001	5.000	-0.001
Min		4.984	4.964	-0.027
Std Dev		0.011	0.015	0.010

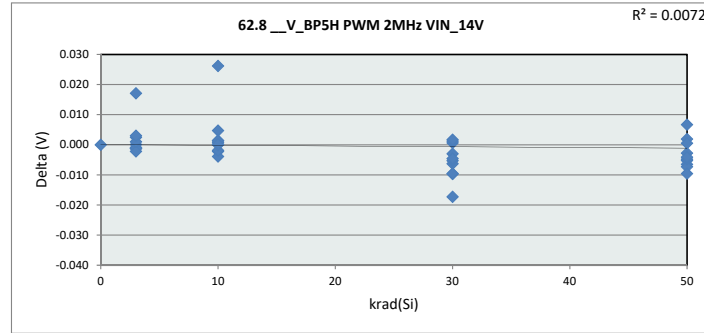

62.8 __V_BP5H_PWM		
Test Site	DAL-FL	
Tester	ETS364	
Test Number	EB672302	
Max Limit	5.175	V
Min Limit	4.75	V

krad(Si)	0	3	10	30	50	100
LL	4.750	4.750	4.750	4.750	4.750	4.750
Min	5.019	4.988	4.986	4.978	4.982	4.964
Average	5.019	5.003	5.007	4.996	4.991	4.999
Max	5.019	5.021	5.024	5.013	5.013	5.035
UL	5.175	5.175	5.175	5.175	5.175	5.175

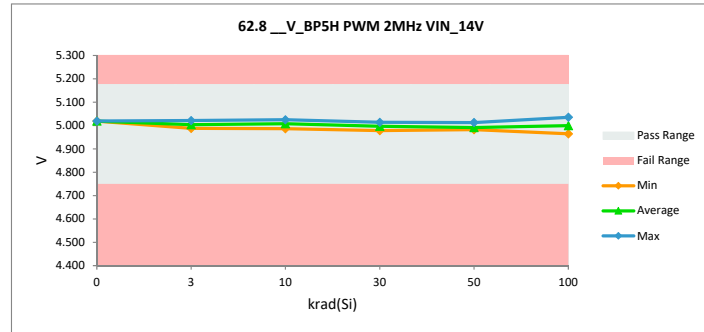

TID HDR Report
TPS7H6003-SP (5962R2220101VXC)

62.9_V_BP7L PWM 5MHz VIN		
Test Site	DAL-FL	DAL-FL
Tester	ETS364	ETS364
Test Number	EB672302	EB672302
Unit	V	V
Max Limit	7.35	7.35
Min Limit	6.65	6.65

krad(Si)	Serial #	pre_short (rtp)	(2)ST_Combo (rpt)	Delta
0	Ctrl	7.032	7.032	0.000
3	58	7.048	7.049	0.001
3	59	7.005	7.006	0.001
3	60	6.979	6.980	0.001
3	61	6.993	6.991	-0.002
3	62	6.970	6.969	-0.002
3	134	7.037	7.007	-0.031
3	137	6.945	7.007	0.062
3	138	7.034	7.006	-0.027
3	139	6.981	6.980	-0.001
3	236	6.967	6.995	0.028
10	63	6.980	6.976	-0.003
10	64	7.004	7.000	-0.004
10	65	7.029	7.030	0.001
10	66	7.025	7.024	-0.002
10	150	7.020	7.014	-0.007
10	237	7.014	6.995	-0.019
10	241	7.022	7.007	-0.016
10	242	6.997	6.999	0.002
10	243	7.000	6.999	-0.001
10	244	7.072	7.067	-0.005
30	141	7.039	7.037	-0.002
30	144	6.993	6.992	0.000
30	145	7.036	7.034	-0.002
30	146	7.013	7.004	-0.009
30	147	7.016	7.009	-0.008
30	132	7.038	7.041	0.003
30	133	7.036	7.024	-0.012
30	135	6.998	7.034	0.036
30	245	6.993	6.989	-0.004
30	246	7.008	6.998	-0.010
50	67	7.041	7.033	-0.008
50	68	6.989	6.979	-0.011
50	69	7.040	7.052	0.012
50	71	6.988	6.978	-0.010
50	72	7.002	6.995	-0.007
50	172	7.017	6.978	-0.039
50	173	7.031	7.017	-0.015
50	174	6.996	7.013	0.017
50	183	7.014	7.014	0.001
50	186	6.983	6.985	0.002
100	95	6.997	7.028	0.031
100	102	6.950	6.941	-0.009
100	104	7.031	7.014	-0.016
100	105	7.019	6.989	-0.029
100	106	6.944	6.942	-0.002
100	178	7.048	7.029	-0.019
100	179	6.984	7.035	0.051
100	180	7.016	7.004	-0.012
100	181	7.022	7.012	-0.010
100	182	7.025	7.052	0.027
	Max	7.072	7.067	0.062
	Average	7.009	7.008	-0.001
	Min	6.944	6.941	-0.039
	Std Dev	0.028	0.026	0.019

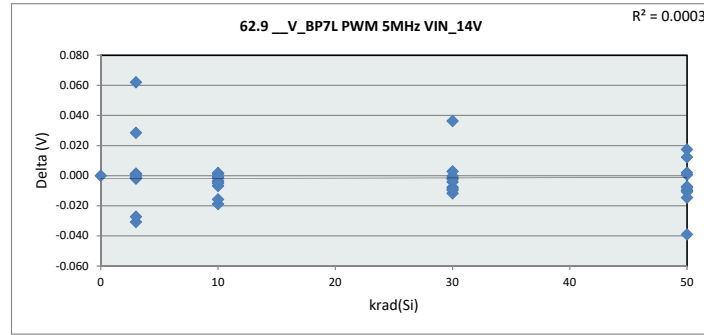

62.9_V_BP7L PWM		
Test Site	DAL-FL	
Tester	ETS364	
Test Number	EB672302	
Max Limit	7.35	V
Min Limit	6.65	V

krad(Si)	0	3	10	30	50	100
LL	6.650	6.650	6.650	6.650	6.650	6.650
Min	7.032	6.969	6.976	6.989	6.978	6.941
Average	7.032	6.999	7.011	7.016	7.004	7.005
Max	7.032	7.049	7.067	7.041	7.053	7.052
UL	7.350	7.350	7.350	7.350	7.350	7.350

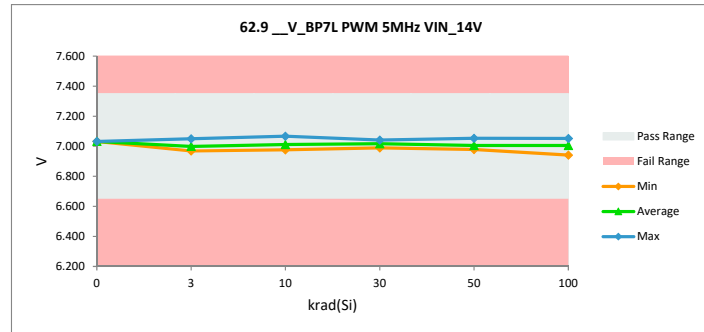

TID HDR Report
TPS7H6003-SP (5962R2220101VXC)

62.10_V_BP5L PWM 5MHz VIN		
Test Site	DAL-FL	DAL-FL
Tester	ETS364	ETS364
Test Number	EB672302	EB672302
Unit	V	V
Max Limit	5.175	5.175
Min Limit	4.75	4.75

krad(Si)	Serial #	pre_short (rtp)	(2)'ST_Combo (rpt)	Delta
0	Ctrl	5.025	5.025	0.000
3	58	4.994	4.995	0.001
3	59	4.985	4.986	0.001
3	60	4.997	4.997	0.000
3	61	4.995	4.994	-0.001
3	62	5.006	5.007	0.001
3	134	4.993	4.998	0.005
3	137	4.983	4.998	0.015
3	138	4.999	4.998	-0.001
3	139	5.002	5.003	0.001
3	236	5.015	4.992	-0.023
10	63	5.006	5.003	-0.003
10	64	4.991	4.991	0.000
10	65	5.019	5.017	-0.002
10	66	5.006	5.004	-0.002
10	150	4.998	4.994	-0.004
10	237	5.017	4.992	-0.025
10	241	5.017	4.998	-0.019
10	242	4.985	4.984	0.000
10	243	5.006	5.009	0.002
10	244	5.002	5.003	0.002
30	141	5.005	5.003	-0.003
30	144	5.017	5.017	-0.001
30	145	5.014	5.011	-0.003
30	146	4.996	4.986	-0.009
30	147	5.025	5.023	-0.002
30	132	4.997	4.994	-0.003
30	133	5.010	5.008	-0.002
30	135	5.020	4.979	-0.041
30	245	5.008	5.001	-0.007
30	246	5.023	5.017	-0.006
50	67	4.985	4.980	-0.005
50	68	4.997	5.028	0.030
50	69	5.013	5.006	-0.007
50	71	5.003	5.003	-0.001
50	72	5.003	4.995	-0.009
50	172	5.012	5.063	0.050
50	173	4.985	4.975	-0.010
50	174	5.021	5.011	-0.010
50	183	5.009	5.007	-0.001
50	186	4.993	4.990	-0.003
100	95	4.999	4.979	-0.020
100	102	5.007	5.005	-0.002
100	104	4.994	4.971	-0.023
100	105	4.991	5.041	0.050
100	106	4.999	4.923	-0.076
100	178	5.015	5.021	0.005
100	179	4.989	4.964	-0.025
100	180	5.021	4.950	-0.071
100	181	5.003	4.990	-0.013
100	182	5.011	5.019	0.008
Max		5.025	5.063	0.050
Average		5.004	4.999	-0.005
Min		4.983	4.923	-0.076
Std Dev		0.012	0.022	0.021

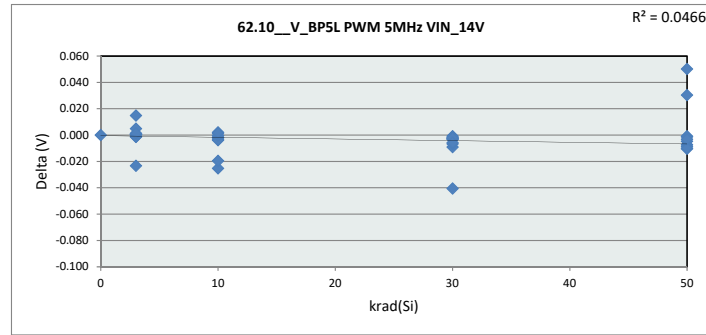

62.10_V_BP5L PW		
Test Site	DAL-FL	
Tester	ETS364	
Test Number	EB672302	
Max Limit	5.175	V
Min Limit	4.75	V

krad(Si)	0	3	10	30	50	100
LL	4.750	4.750	4.750	4.750	4.750	4.750
Min	5.026	4.986	4.984	4.979	4.975	4.923
Average	5.026	4.997	5.000	5.004	5.006	4.986
Max	5.026	5.007	5.017	5.023	5.063	5.041
UL	5.175	5.175	5.175	5.175	5.175	5.175

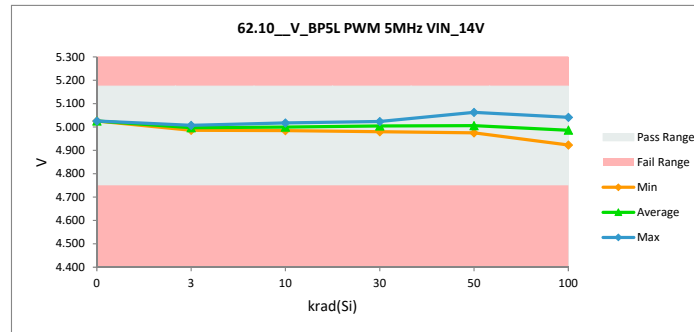

TID HDR Report
TPS7H6003-SP (5962R2220101VXC)

62.11_V_BP5H PWM 5MHz VIN		
Test Site	DAL-FL	DAL-FL
Tester	ETS364	ETS364
Test Number	EB672302	EB672302
Unit	V	V
Max Limit	5.175	5.175
Min Limit	4.75	4.75

krad(Si)	Serial #	pre_short (rtp)	(2)'ST_Combo (rpt)	Delta
0	Ctrl	5.024	5.024	0.000
3	58	5.026	5.025	-0.001
3	59	5.012	5.011	0.000
3	60	5.006	5.006	0.000
3	61	4.999	4.997	-0.002
3	62	4.992	4.991	-0.002
3	134	5.006	5.007	0.001
3	137	5.009	5.007	-0.002
3	138	4.990	5.007	0.018
3	139	5.000	5.001	0.001
3	236	5.011	5.013	0.002
10	63	4.993	4.991	-0.002
10	64	5.006	5.008	0.002
10	65	5.026	5.027	0.001
10	66	4.997	4.992	-0.004
10	150	5.013	5.011	-0.001
10	237	4.987	5.014	0.027
10	241	5.004	5.007	0.003
10	242	5.027	5.028	0.002
10	243	5.026	5.026	0.001
10	244	5.009	5.010	0.001
30	141	5.015	5.016	0.001
30	144	4.988	4.983	-0.006
30	145	5.016	5.011	-0.005
30	146	5.000	4.990	-0.009
30	147	5.002	4.999	-0.003
30	132	5.014	5.004	-0.010
30	133	5.004	5.005	0.002
30	135	5.009	4.993	-0.016
30	245	5.016	5.017	0.002
30	246	4.988	4.983	-0.005
50	67	5.014	5.017	0.003
50	68	5.004	5.012	0.007
50	69	4.995	4.990	-0.005
50	71	4.995	4.993	-0.002
50	72	4.988	4.989	0.001
50	172	4.997	4.992	-0.005
50	173	4.996	4.990	-0.007
50	174	5.007	4.998	-0.010
50	183	4.991	4.986	-0.005
50	186	4.993	4.989	-0.004
100	95	4.993	4.982	-0.011
100	102	4.990	4.997	0.007
100	104	5.010	5.032	0.021
100	105	5.003	5.027	0.023
100	106	4.995	4.968	-0.028
100	178	4.998	4.991	-0.007
100	179	5.001	4.999	-0.002
100	180	4.997	4.997	0.000
100	181	5.026	5.001	-0.025
100	182	5.016	5.041	0.026
Max		5.027	5.041	0.027
Average		5.004	5.004	0.000
Min		4.987	4.968	-0.028
Std Dev		0.011	0.015	0.010

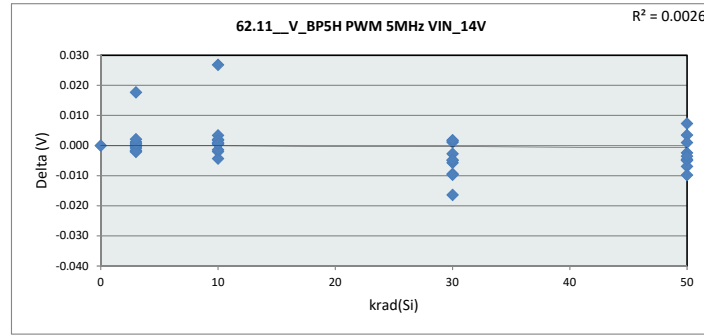

62.11_V_BP5H PW		
Test Site	DAL-FL	
Tester	ETS364	
Test Number	EB672302	
Max Limit	5.175	V
Min Limit	4.75	V

krad(Si)	0	3	10	30	50	100
LL	4.750	4.750	4.750	4.750	4.750	4.750
Min	5.024	4.991	4.991	4.983	4.986	4.968
Average	5.024	5.007	5.011	5.000	4.995	5.003
Max	5.024	5.025	5.028	5.017	5.017	5.041
UL	5.175	5.175	5.175	5.175	5.175	5.175

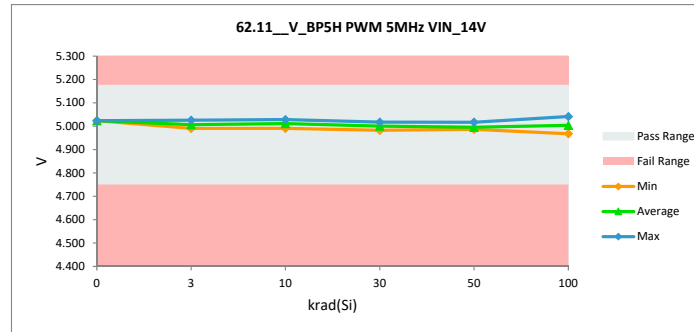

TID HDR Report
TPS7H6003-SP (5962R2220101VXC)

62.12_V_BP7L IIM 500kHz VIN		
Test Site	DAL-FL	DAL-FL
Tester	ETS364	ETS364
Test Number	EB672302	EB672302
Unit	V	V
Max Limit	7.35	7.35
Min Limit	6.65	6.65

krad(Si)	Serial #	pre_short (rtp)	(2)ST_Combo (rpt)	Delta
0	Ctrl	7.047	7.047	0.000
3	58	7.054	7.055	0.001
3	59	7.011	7.012	0.001
3	60	6.985	6.986	0.001
3	61	6.996	6.993	-0.003
3	62	6.975	6.973	-0.002
3	134	7.044	7.013	-0.031
3	137	6.950	7.012	0.062
3	138	7.038	7.012	-0.026
3	139	6.987	6.986	-0.001
3	236	6.984	7.001	0.018
10	63	6.985	6.982	-0.003
10	64	7.008	7.004	-0.004
10	65	7.035	7.037	0.002
10	66	7.030	7.028	-0.002
10	150	7.028	7.023	-0.005
10	237	7.021	7.001	-0.020
10	241	7.030	7.012	-0.017
10	242	7.003	7.004	0.001
10	243	7.004	7.004	-0.001
10	244	7.077	7.072	-0.005
30	141	7.044	7.041	-0.003
30	144	6.998	6.997	-0.001
30	145	7.041	7.040	-0.001
30	146	7.018	7.010	-0.008
30	147	7.021	7.015	-0.007
30	132	7.043	7.045	0.002
30	133	7.042	7.033	-0.009
30	135	7.004	7.039	0.035
30	245	6.999	6.995	-0.004
30	246	7.014	7.008	-0.006
50	67	7.045	7.041	-0.005
50	68	7.008	6.986	-0.022
50	69	7.045	7.051	0.006
50	71	6.992	6.986	-0.005
50	72	7.007	7.001	-0.006
50	172	7.025	6.990	-0.035
50	173	7.037	7.024	-0.013
50	174	7.013	7.015	0.003
50	183	7.019	7.019	0.000
50	186	6.988	6.990	0.002
100	95	7.002	7.029	0.027
100	102	6.956	6.949	-0.007
100	104	7.037	7.023	-0.013
100	105	7.023	6.999	-0.024
100	106	6.948	6.948	0.000
100	178	7.053	7.036	-0.017
100	179	6.988	7.033	0.045
100	180	7.023	7.011	-0.012
100	181	7.028	7.017	-0.011
100	182	7.030	7.056	0.026
	Max	7.077	7.072	0.062
	Average	7.015	7.013	-0.002
	Min	6.948	6.948	-0.035
	Std Dev	0.027	0.026	0.017

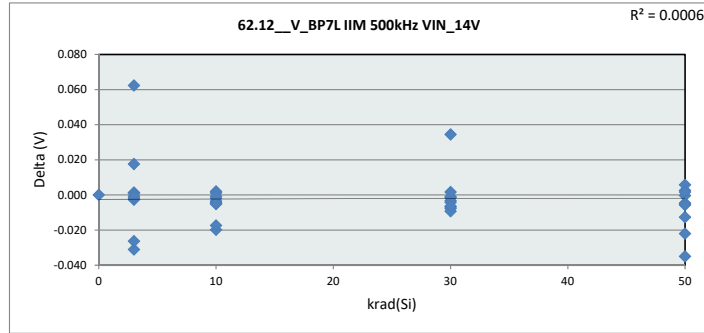

62.12_V_BP7L IIM

Test Site	DAL-FL
Tester	ETS364
Test Number	EB672302
Max Limit	7.35 V
Min Limit	6.65 V

krad(Si)	0	3	10	30	50	100
LL	6.650	6.650	6.650	6.650	6.650	6.650
Min	7.047	6.973	6.982	6.995	6.986	6.948
Average	7.047	7.004	7.017	7.022	7.010	7.010
Max	7.047	7.055	7.072	7.045	7.051	7.056
UL	7.350	7.350	7.350	7.350	7.350	7.350

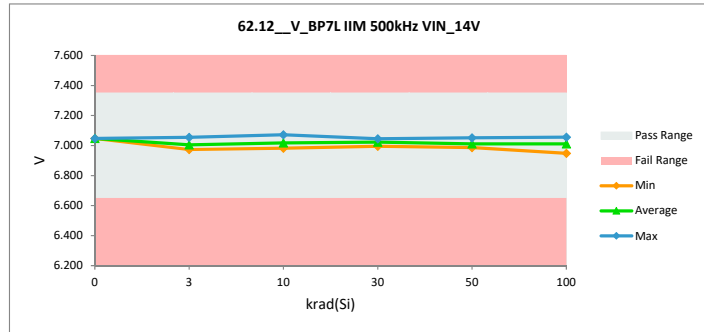

TID HDR Report
TPS7H6003-SP (5962R2220101VXC)

62.13_V_BP5L IIM 500kHz VIN		
Test Site	DAL-FL	DAL-FL
Tester	ETS364	ETS364
Test Number	EB672302	EB672302
Unit	V	V
Max Limit	5.175	5.175
Min Limit	4.75	4.75

krad(Si)	Serial #	pre_short (rtp)	(2)ST_Combo (rpt)	Delta
0	Ctrl	5.016	5.016	0.000
3	58	4.992	4.992	0.000
3	59	4.983	4.983	0.000
3	60	4.995	4.995	0.000
3	61	4.993	4.992	-0.001
3	62	5.004	5.005	0.001
3	134	4.989	4.996	0.006
3	137	4.981	4.996	0.015
3	138	4.997	4.996	-0.001
3	139	4.999	5.001	0.001
3	236	5.008	4.989	-0.018
10	63	5.005	5.001	-0.003
10	64	4.989	4.989	0.000
10	65	5.017	5.015	-0.002
10	66	5.004	5.002	-0.002
10	150	4.996	4.991	-0.004
10	237	5.016	4.990	-0.026
10	241	5.015	4.996	-0.019
10	242	4.982	4.982	0.000
10	243	5.005	5.006	0.002
10	244	4.999	5.001	0.001
30	141	5.004	5.001	-0.003
30	144	5.015	5.014	-0.001
30	145	5.012	5.009	-0.004
30	146	4.994	4.984	-0.009
30	147	5.023	5.021	-0.002
30	132	4.994	4.991	-0.003
30	133	5.008	5.006	-0.002
30	135	5.018	4.979	-0.038
30	245	5.005	4.998	-0.007
30	246	5.021	5.015	-0.005
50	67	4.983	4.978	-0.005
50	68	4.989	5.024	0.035
50	69	5.010	5.004	-0.006
50	71	5.002	5.001	-0.001
50	72	5.001	4.992	-0.009
50	172	5.010	5.053	0.044
50	173	4.984	4.973	-0.010
50	174	5.012	5.008	-0.004
50	183	5.006	5.004	-0.002
50	186	4.991	4.988	-0.003
100	95	4.997	4.977	-0.019
100	102	5.005	5.002	-0.003
100	104	4.992	4.969	-0.023
100	105	4.989	5.035	0.046
100	106	4.997	4.925	-0.071
100	178	5.013	5.016	0.003
100	179	4.987	4.964	-0.022
100	180	5.018	4.951	-0.066
100	181	5.000	4.988	-0.012
100	182	5.009	5.015	0.006
Max		5.023	5.053	0.046
Average		5.001	4.996	-0.005
Min		4.981	4.925	-0.071
Std Dev		0.011	0.020	0.019

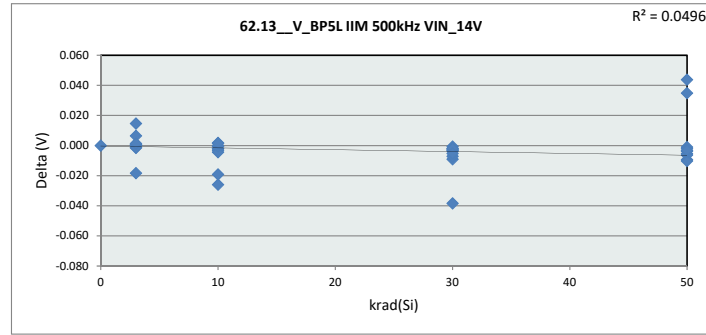

62.13_V_BP5L IIM		
Test Site	DAL-FL	
Tester	ETS364	
Test Number	EB672302	
Max Limit	5.175	V
Min Limit	4.75	V

krad(Si)	0	3	10	30	50	100
LL	4.750	4.750	4.750	4.750	4.750	4.750
Min	5.016	4.983	4.982	4.979	4.973	4.926
Average	5.016	4.994	4.997	5.002	5.002	4.984
Max	5.016	5.005	5.015	5.021	5.053	5.035
UL	5.175	5.175	5.175	5.175	5.175	5.175

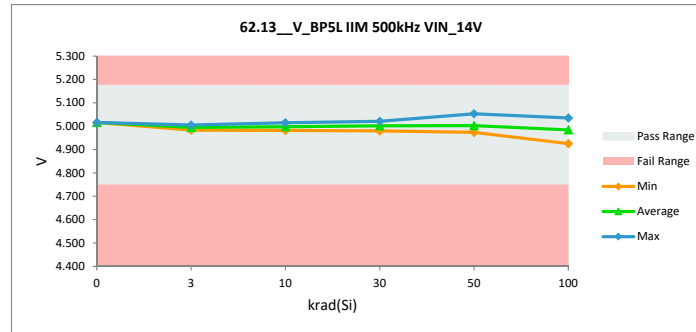

TID HDR Report
TPS7H6003-SP (5962R2220101VXC)

62.14_V_BP5H_IIM_500kHz_VIN		
Test Site	DAL-FL	DAL-FL
Tester	ETS364	ETS364
Test Number	EB672302	EB672302
Unit	V	V
Max Limit	5.175	5.175
Min Limit	4.75	4.75

krad(Si)	Serial #	pre_short (rtp)	(2)'ST_Combo (rpt)	Delta
0	Ctrl	5.016	5.016	0.000
3	58	5.019	5.019	-0.001
3	59	5.006	5.005	-0.001
3	60	4.999	4.999	0.000
3	61	4.993	4.991	-0.001
3	62	4.986	4.985	-0.001
3	134	4.999	5.001	0.002
3	137	5.004	5.001	-0.003
3	138	4.984	5.001	0.017
3	139	4.994	4.995	0.001
3	236	5.004	5.007	0.003
10	63	4.986	4.984	-0.002
10	64	5.000	5.001	0.001
10	65	5.019	5.020	0.001
10	66	4.990	4.986	-0.004
10	150	5.006	5.004	-0.002
10	237	4.981	5.007	0.026
10	241	4.997	5.001	0.005
10	242	5.021	5.022	0.001
10	243	5.020	5.020	0.000
10	244	5.002	5.002	0.000
30	141	5.009	5.009	0.000
30	144	4.982	4.976	-0.006
30	145	5.011	5.006	-0.005
30	146	4.993	4.984	-0.010
30	147	4.996	4.993	-0.003
30	132	5.008	4.999	-0.009
30	133	4.998	4.999	0.001
30	135	5.004	4.987	-0.017
30	245	5.009	5.011	0.001
30	246	4.981	4.977	-0.005
50	67	5.009	5.010	0.002
50	68	4.998	5.004	0.006
50	69	4.988	4.983	-0.005
50	71	4.989	4.986	-0.003
50	72	4.981	4.982	0.000
50	172	4.992	4.985	-0.007
50	173	4.990	4.983	-0.008
50	174	5.000	4.991	-0.009
50	183	4.984	4.980	-0.004
50	186	4.986	4.983	-0.004
100	95	4.986	4.976	-0.010
100	102	4.983	4.989	0.005
100	104	5.004	5.023	0.019
100	105	4.998	5.018	0.020
100	106	4.989	4.962	-0.027
100	178	4.992	4.984	-0.008
100	179	4.996	4.993	-0.002
100	180	4.990	4.990	0.000
100	181	5.020	4.996	-0.024
100	182	5.010	5.032	0.022
	Max	5.021	5.032	0.026
	Average	4.998	4.997	-0.001
	Min	4.981	4.962	-0.027
	Std Dev	0.012	0.015	0.010

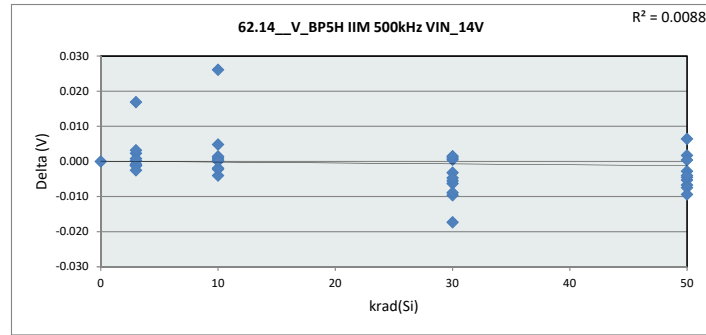

62.14_V_BP5H_IIM		
Test Site	DAL-FL	
Tester	ETS364	
Test Number	EB672302	
Max Limit	5.175	V
Min Limit	4.75	V

krad(Si)	0	3	10	30	50	100
LL	4.750	4.750	4.750	4.750	4.750	4.750
Min	5.016	4.985	4.984	4.976	4.980	4.962
Average	5.016	5.001	5.005	4.994	4.989	4.996
Max	5.016	5.019	5.022	5.011	5.010	5.032
UL	5.175	5.175	5.175	5.175	5.175	5.175

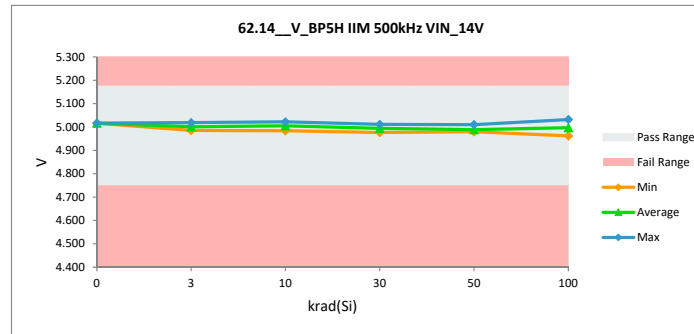

TID HDR Report
TPS7H6003-SP (5962R2220101VXC)

62.15_V_BP7L IIM 1MHz VIN_14V		
Test Site	DAL-FL	DAL-FL
Tester	ETS364	ETS364
Test Number	EB672302	EB672302
Unit	V	V
Max Limit	7.35	7.35
Min Limit	6.65	6.65

krad(Si)	Serial #	pre_short (rtp)	(2)ST_Combo (rpt)	Delta
0	Ctrl	7.044	7.044	0.000
3	58	7.050	7.051	0.001
3	59	7.008	7.009	0.001
3	60	6.981	6.982	0.001
3	61	6.992	6.990	-0.002
3	62	6.972	6.970	-0.002
3	134	7.040	7.009	-0.031
3	137	6.947	7.009	0.062
3	138	7.035	7.009	-0.026
3	139	6.983	6.983	0.000
3	236	6.980	6.998	0.018
10	63	6.982	6.978	-0.003
10	64	7.005	7.001	-0.004
10	65	7.031	7.033	0.002
10	66	7.026	7.024	-0.002
10	150	7.024	7.019	-0.005
10	237	7.017	6.998	-0.020
10	241	7.026	7.009	-0.017
10	242	6.999	7.001	0.001
10	243	7.001	7.000	-0.001
10	244	7.073	7.068	-0.005
30	141	7.041	7.038	-0.003
30	144	6.995	6.994	-0.001
30	145	7.037	7.036	-0.001
30	146	7.014	7.007	-0.008
30	147	7.018	7.011	-0.007
30	132	7.040	7.042	0.002
30	133	7.039	7.029	-0.010
30	135	7.001	7.035	0.034
30	245	6.996	6.991	-0.004
30	246	7.010	7.004	-0.007
50	67	7.042	7.037	-0.005
50	68	7.004	6.982	-0.022
50	69	7.041	7.048	0.007
50	71	6.988	6.982	-0.006
50	72	7.004	6.997	-0.006
50	172	7.021	6.985	-0.036
50	173	7.033	7.021	-0.013
50	174	7.009	7.012	0.003
50	183	7.016	7.016	0.000
50	186	6.984	6.987	0.002
100	95	6.999	7.026	0.027
100	102	6.952	6.945	-0.007
100	104	7.033	7.019	-0.014
100	105	7.020	6.994	-0.025
100	106	6.945	6.944	-0.001
100	178	7.049	7.033	-0.017
100	179	6.985	7.031	0.046
100	180	7.020	7.007	-0.012
100	181	7.024	7.014	-0.010
100	182	7.026	7.052	0.026
	Max	7.073	7.068	0.062
	Average	7.012	7.010	-0.002
	Min	6.945	6.944	-0.036
	Std Dev	0.027	0.026	0.017

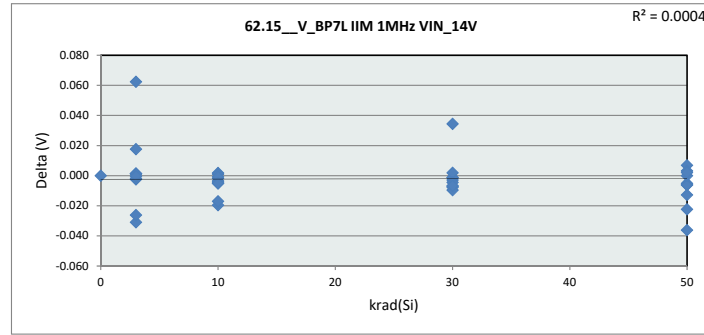

62.15_V_BP7L IIM		
Test Site	DAL-FL	
Tester	ETS364	
Test Number	EB672302	
Max Limit	7.35	V
Min Limit	6.65	V

krad(Si)	0	3	10	30	50	100
LL	6.650	6.650	6.650	6.650	6.650	6.650
Min	7.044	6.970	6.978	6.991	6.982	6.944
Average	7.044	7.001	7.013	7.019	7.007	7.007
Max	7.044	7.051	7.068	7.042	7.048	7.052
UL	7.350	7.350	7.350	7.350	7.350	7.350

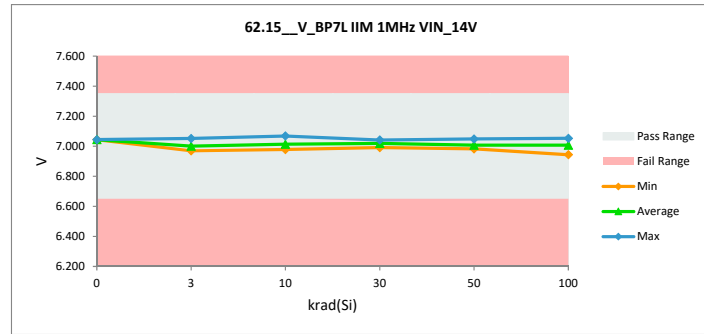

TID HDR Report
TPS7H6003-SP (5962R2220101VXC)

62.16_V_BP5L IIM 1MHz VIN_14V		
Test Site	DAL-FL	DAL-FL
Tester	ETS364	ETS364
Test Number	EB672302	EB672302
Unit	V	V
Max Limit	5.175	5.175
Min Limit	4.75	4.75

krad(Si)	Serial #	pre_short (rtp)	(2)'ST_Combo (rpt) (Delta
0	Ctrl	5.019	5.019	0.000
3	58	4.994	4.995	0.000
3	59	4.985	4.986	0.000
3	60	4.997	4.997	0.000
3	61	4.996	4.995	-0.001
3	62	5.007	5.008	0.001
3	134	4.992	4.999	0.007
3	137	4.983	4.998	0.015
3	138	5.000	4.999	-0.001
3	139	5.002	5.003	0.002
3	236	5.010	4.992	-0.018
10	63	5.007	5.004	-0.003
10	64	4.991	4.991	0.000
10	65	5.019	5.017	-0.002
10	66	5.007	5.005	-0.002
10	150	4.999	4.994	-0.004
10	237	5.018	4.992	-0.026
10	241	5.017	4.999	-0.019
10	242	4.984	4.984	0.000
10	243	5.007	5.009	0.002
10	244	5.002	5.003	0.002
30	141	5.006	5.004	-0.003
30	144	5.017	5.017	0.000
30	145	5.015	5.011	-0.003
30	146	4.996	4.987	-0.009
30	147	5.025	5.023	-0.002
30	132	4.996	4.994	-0.002
30	133	5.010	5.008	-0.002
30	135	5.020	4.982	-0.039
30	245	5.008	5.001	-0.007
30	246	5.023	5.018	-0.005
50	67	4.986	4.981	-0.005
50	68	4.991	5.027	0.036
50	69	5.013	5.007	-0.006
50	71	5.004	5.004	-0.001
50	72	5.004	4.995	-0.009
50	172	5.012	5.057	0.045
50	173	4.986	4.976	-0.010
50	174	5.015	5.011	-0.003
50	183	5.009	5.008	-0.001
50	186	4.993	4.991	-0.003
100	95	4.999	4.980	-0.019
100	102	5.007	5.005	-0.002
100	104	4.994	4.972	-0.022
100	105	4.991	5.039	0.048
100	106	4.999	4.927	-0.072
100	178	5.016	5.020	0.004
100	179	4.989	4.967	-0.022
100	180	5.020	4.953	-0.067
100	181	5.003	4.991	-0.012
100	182	5.011	5.018	0.007
Max		5.025	5.057	0.048
Average		5.004	4.999	-0.005
Min		4.983	4.927	-0.072
Std Dev		0.011	0.020	0.020

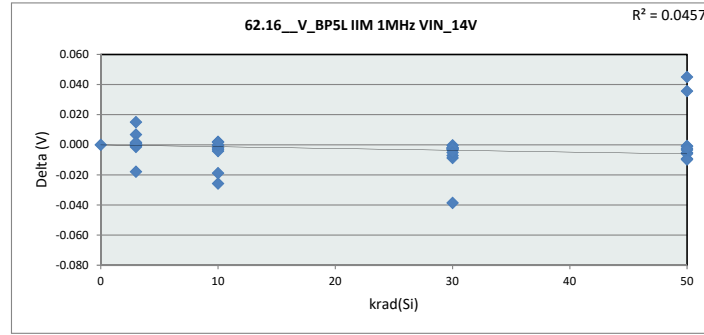

62.16_V_BP5L IIM		
Test Site	DAL-FL	
Tester	ETS364	
Test Number	EB672302	
Max Limit	5.175	V
Min Limit	4.75	V

krad(Si)	0	3	10	30	50	100
LL	4.750	4.750	4.750	4.750	4.750	4.750
Min	5.019	4.986	4.984	4.982	4.976	4.928
Average	5.019	4.997	5.000	5.004	5.006	4.987
Max	5.019	5.008	5.017	5.024	5.057	5.039
UL	5.175	5.175	5.175	5.175	5.175	5.175

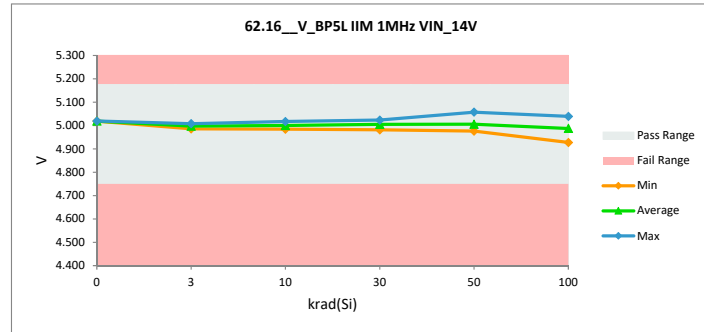

TID HDR Report
TPS7H6003-SP (5962R2220101VXC)

62.17_V_BP5H_IIM_1MHz_VIN		
Test Site	DAL-FL	DAL-FL
Tester	ETS364	ETS364
Test Number	EB672302	EB672302
Unit	V	V
Max Limit	5.175	5.175
Min Limit	4.75	4.75

krad(Si)	Serial #	pre_short (rtp)	(2)'ST_Combo (rpt)	Delta
0	Ctrl	5.017	5.017	0.000
3	58	5.020	5.019	-0.001
3	59	5.007	5.006	-0.001
3	60	5.000	5.000	0.000
3	61	4.994	4.992	-0.001
3	62	4.987	4.986	-0.001
3	134	5.000	5.002	0.002
3	137	5.005	5.002	-0.003
3	138	4.985	5.002	0.017
3	139	4.995	4.996	0.001
3	236	5.005	5.008	0.003
10	63	4.987	4.984	-0.002
10	64	5.001	5.002	0.001
10	65	5.020	5.020	0.000
10	66	4.991	4.987	-0.004
10	150	5.007	5.005	-0.002
10	237	4.982	5.008	0.026
10	241	4.997	5.002	0.005
10	242	5.022	5.023	0.001
10	243	5.021	5.021	0.000
10	244	5.003	5.003	0.000
30	141	5.009	5.010	0.001
30	144	4.983	4.977	-0.006
30	145	5.012	5.006	-0.005
30	146	4.994	4.984	-0.010
30	147	4.997	4.994	-0.003
30	132	5.009	5.000	-0.009
30	133	4.998	4.999	0.001
30	135	5.005	4.988	-0.017
30	245	5.010	5.011	0.001
30	246	4.982	4.977	-0.005
50	67	5.009	5.011	0.002
50	68	4.999	5.005	0.007
50	69	4.989	4.984	-0.005
50	71	4.990	4.987	-0.003
50	72	4.982	4.983	0.000
50	172	4.993	4.986	-0.007
50	173	4.991	4.984	-0.007
50	174	5.001	4.992	-0.010
50	183	4.985	4.980	-0.005
50	186	4.987	4.983	-0.004
100	95	4.987	4.977	-0.010
100	102	4.984	4.989	0.005
100	104	5.005	5.025	0.019
100	105	4.999	5.019	0.021
100	106	4.990	4.962	-0.028
100	178	4.993	4.985	-0.008
100	179	4.996	4.994	-0.003
100	180	4.991	4.991	0.000
100	181	5.021	4.997	-0.024
100	182	5.011	5.033	0.022
	Max	5.022	5.033	0.026
	Average	4.999	4.998	-0.001
	Min	4.982	4.962	-0.028
	Std Dev	0.011	0.015	0.010

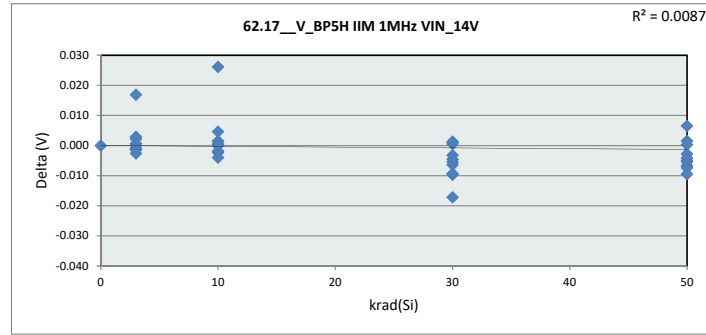

62.17_V_BP5H_IIM		
Test Site	DAL-FL	
Tester	ETS364	
Test Number	EB672302	
Max Limit	5.175	V
Min Limit	4.75	V

krad(Si)	0	3	10	30	50	100
LL	4.750	4.750	4.750	4.750	4.750	4.750
Min	5.017	4.986	4.985	4.977	4.980	4.962
Average	5.017	5.001	5.006	4.995	4.989	4.997
Max	5.017	5.020	5.023	5.012	5.011	5.033
UL	5.175	5.175	5.175	5.175	5.175	5.175

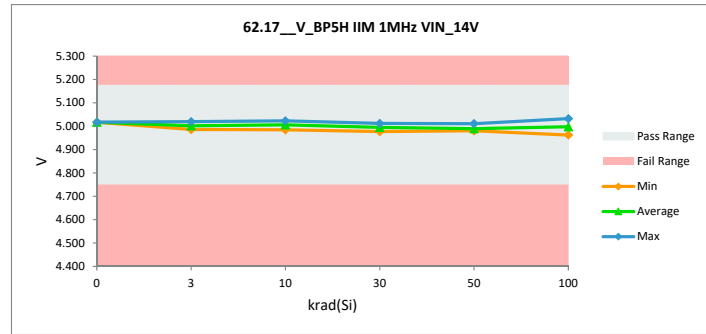

TID HDR Report
TPS7H6003-SP (5962R2220101VXC)

62.18_V_BP7L IIM 2MHz VIN_14V		
Test Site	DAL-FL	DAL-FL
Tester	ETS364	ETS364
Test Number	EB672302	EB672302
Unit	V	V
Max Limit	7.35	7.35
Min Limit	6.65	6.65

krad(Si)	Serial #	pre_short (rtp)	(2)ST_Combo (rpt)	Delta
0	Ctrl	7.037	7.037	0.000
3	58	7.043	7.044	0.002
3	59	7.001	7.003	0.002
3	60	6.974	6.975	0.001
3	61	6.985	6.983	-0.002
3	62	6.965	6.963	-0.002
3	134	7.034	7.003	-0.031
3	137	6.940	7.003	0.063
3	138	7.029	7.003	-0.026
3	139	6.976	6.976	0.000
3	236	6.973	6.991	0.018
10	63	6.975	6.972	-0.004
10	64	6.998	6.994	-0.004
10	65	7.024	7.026	0.002
10	66	7.019	7.017	-0.002
10	150	7.017	7.011	-0.005
10	237	7.010	6.991	-0.020
10	241	7.019	7.003	-0.016
10	242	6.993	6.994	0.001
10	243	6.994	6.993	0.000
10	244	7.066	7.062	-0.005
30	141	7.033	7.030	-0.003
30	144	6.988	6.986	-0.002
30	145	7.031	7.029	-0.002
30	146	7.008	7.000	-0.008
30	147	7.011	7.003	-0.007
30	132	7.033	7.035	0.002
30	133	7.032	7.022	-0.010
30	135	6.994	7.028	0.035
30	245	6.988	6.984	-0.004
30	246	7.003	6.995	-0.008
50	67	7.035	7.029	-0.006
50	68	6.997	6.974	-0.023
50	69	7.035	7.043	0.008
50	71	6.981	6.974	-0.007
50	72	6.997	6.990	-0.006
50	172	7.014	6.977	-0.037
50	173	7.026	7.013	-0.013
50	174	7.002	7.006	0.004
50	183	7.009	7.010	0.000
50	186	6.978	6.980	0.003
100	95	6.992	7.019	0.027
100	102	6.945	6.937	-0.008
100	104	7.026	7.011	-0.015
100	105	7.013	6.986	-0.027
100	106	6.938	6.936	-0.001
100	178	7.042	7.025	-0.017
100	179	6.979	7.026	0.047
100	180	7.013	7.000	-0.012
100	181	7.017	7.008	-0.010
100	182	7.019	7.047	0.028
Max		7.066	7.062	0.063
Average		7.005	7.003	-0.002
Min		6.938	6.936	-0.037
Std Dev		0.027	0.026	0.018

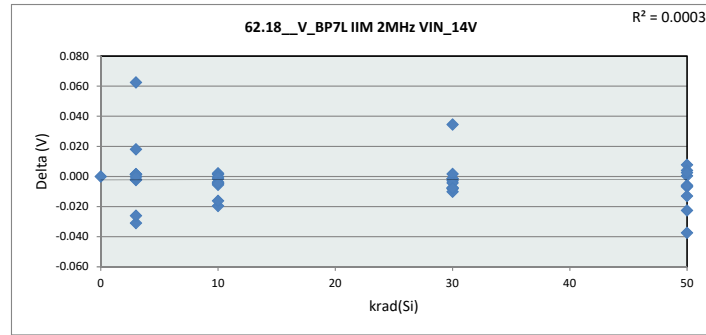

62.18_V_BP7L IIM		
Test Site	DAL-FL	
Tester	ETS364	
Test Number	EB672302	
Max Limit	7.35	V
Min Limit	6.65	V

krad(Si)	0	3	10	30	50	100
LL	6.650	6.650	6.650	6.650	6.650	6.650
Min	7.037	6.963	6.972	6.984	6.974	6.936
Average	7.037	6.994	7.006	7.011	7.000	7.000
Max	7.037	7.045	7.062	7.035	7.043	7.047
UL	7.350	7.350	7.350	7.350	7.350	7.350

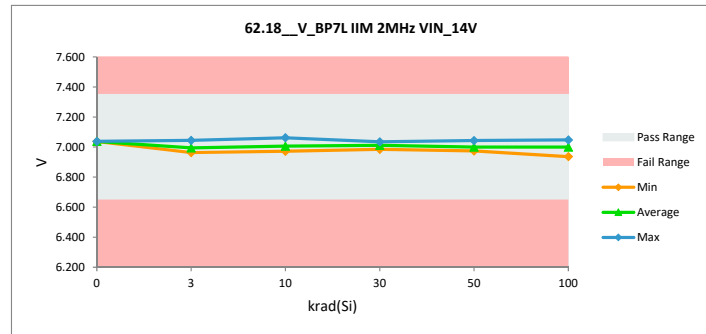

TID HDR Report
TPS7H6003-SP (5962R2220101VXC)

62.19_V_BP5L IIM 2MHz VIN_14V		
Test Site	DAL-FL	DAL-FL
Tester	ETS364	ETS364
Test Number	EB672302	EB672302
Unit	V	V
Max Limit	5.175	5.175
Min Limit	4.75	4.75

krad(Si)	Serial #	pre_short (rtp)	(2)'ST_Combo (rpt)	Delta
0	Ctrl	5.024	5.024	0.000
3	58	5.000	5.000	0.000
3	59	4.991	4.991	0.000
3	60	5.003	5.002	0.000
3	61	5.002	5.001	-0.002
3	62	5.012	5.013	0.001
3	134	4.997	5.004	0.008
3	137	4.989	5.004	0.016
3	138	5.005	5.005	0.000
3	139	5.007	5.009	0.002
3	236	5.015	4.997	-0.017
10	63	5.012	5.009	-0.003
10	64	4.996	4.996	0.000
10	65	5.024	5.022	-0.002
10	66	5.013	5.011	-0.002
10	150	5.004	5.000	-0.004
10	237	5.023	4.997	-0.025
10	241	5.023	5.005	-0.018
10	242	4.989	4.989	0.000
10	243	5.012	5.014	0.003
10	244	5.007	5.010	0.002
30	141	5.012	5.010	-0.002
30	144	5.023	5.023	0.000
30	145	5.019	5.016	-0.003
30	146	5.001	4.992	-0.009
30	147	5.030	5.029	-0.001
30	132	5.001	5.000	-0.002
30	133	5.015	5.014	-0.002
30	135	5.025	4.987	-0.039
30	245	5.014	5.007	-0.007
30	246	5.028	5.023	-0.005
50	67	4.991	4.986	-0.005
50	68	4.997	5.034	0.038
50	69	5.018	5.013	-0.005
50	71	5.010	5.010	0.000
50	72	5.009	5.000	-0.009
50	172	5.018	5.066	0.048
50	173	4.991	4.982	-0.009
50	174	5.020	5.018	-0.002
50	183	5.014	5.014	0.000
50	186	4.998	4.997	-0.002
100	95	5.004	4.986	-0.018
100	102	5.012	5.011	-0.002
100	104	4.999	4.977	-0.023
100	105	4.997	5.047	0.050
100	106	5.004	4.931	-0.073
100	178	5.022	5.028	0.007
100	179	4.994	4.973	-0.022
100	180	5.025	4.957	-0.068
100	181	5.008	4.997	-0.011
100	182	5.016	5.025	0.009
Max		5.030	5.066	0.050
Average		5.009	5.005	-0.004
Min		4.989	4.931	-0.073
Std Dev		0.011	0.021	0.020

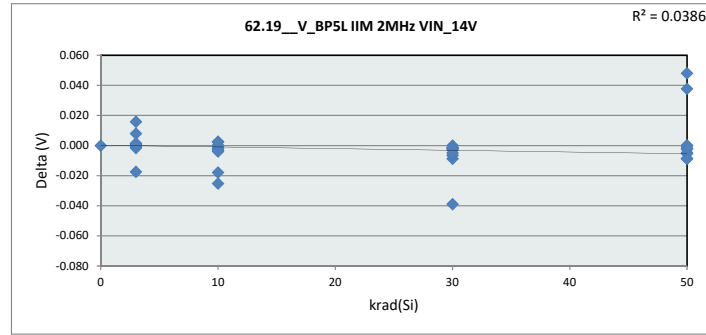

62.19_V_BP5L IIM		
Test Site	DAL-FL	
Tester	ETS364	
Test Number	EB672302	
Max Limit	5.175	V
Min Limit	4.75	V

krad(Si)	0	3	10	30	50	100
LL	4.750	4.750	4.750	4.750	4.750	4.750
Min	5.024	4.991	4.989	4.987	4.982	4.931
Average	5.024	5.003	5.005	5.010	5.012	4.993
Max	5.024	5.013	5.022	5.029	5.066	5.047
UL	5.175	5.175	5.175	5.175	5.175	5.175

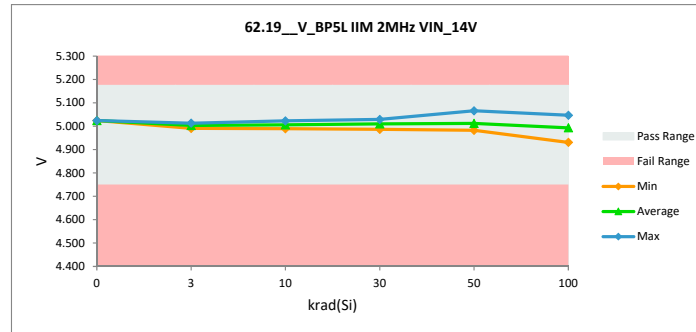

TID HDR Report
TPS7H6003-SP (5962R2220101VXC)

62.20_V_BP5H_IIM_2MHz_VIN		
Test Site	DAL-FL	DAL-FL
Tester	ETS364	ETS364
Test Number	EB672302	EB672302
Unit	V	V
Max Limit	5.175	5.175
Min Limit	4.75	4.75

krad(Si)	Serial #	pre_short (rtp) (2)	ST_Combo (rpt) (Delta
0	Ctrl	5.019	5.019	0.000
3	58	5.022	5.021	-0.001
3	59	5.009	5.007	-0.002
3	60	5.002	5.001	0.000
3	61	4.995	4.994	-0.001
3	62	4.989	4.988	-0.002
3	134	5.002	5.004	0.002
3	137	5.006	5.004	-0.003
3	138	4.987	5.004	0.017
3	139	4.997	4.997	0.001
3	236	5.007	5.009	0.003
10	63	4.989	4.986	-0.003
10	64	5.002	5.004	0.001
10	65	5.022	5.022	0.000
10	66	4.993	4.989	-0.004
10	150	5.008	5.006	-0.002
10	237	4.984	5.010	0.026
10	241	4.999	5.004	0.004
10	242	5.023	5.024	0.001
10	243	5.023	5.022	0.000
10	244	5.005	5.005	0.000
30	141	5.011	5.011	0.000
30	144	4.985	4.978	-0.007
30	145	5.014	5.008	-0.006
30	146	4.996	4.986	-0.010
30	147	4.999	4.995	-0.003
30	132	5.011	5.001	-0.010
30	133	5.000	5.001	0.001
30	135	5.006	4.989	-0.017
30	245	5.012	5.013	0.001
30	246	4.984	4.979	-0.005
50	67	5.011	5.012	0.001
50	68	5.001	5.008	0.007
50	69	4.991	4.985	-0.006
50	71	4.992	4.989	-0.003
50	72	4.984	4.984	0.000
50	172	4.995	4.988	-0.007
50	173	4.993	4.985	-0.007
50	174	5.003	4.993	-0.010
50	183	4.987	4.981	-0.005
50	186	4.989	4.985	-0.004
100	95	4.989	4.979	-0.010
100	102	4.986	4.991	0.005
100	104	5.007	5.026	0.019
100	105	5.000	5.022	0.021
100	106	4.992	4.964	-0.028
100	178	4.995	4.987	-0.008
100	179	4.998	4.995	-0.003
100	180	4.993	4.992	0.000
100	181	5.022	4.998	-0.024
100	182	5.012	5.036	0.023
Max		5.023	5.036	0.026
Average		5.001	5.000	-0.001
Min		4.984	4.964	-0.028
Std Dev		0.011	0.015	0.010

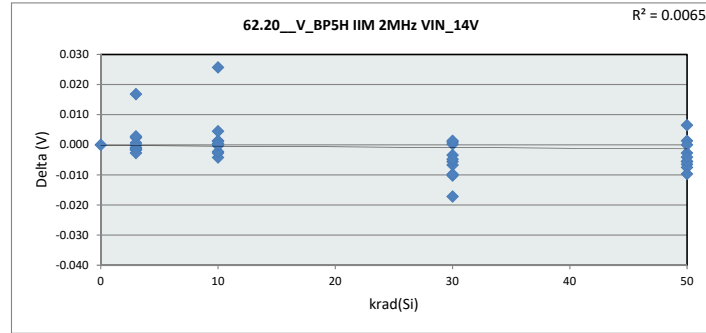

62.20_V_BP5H_IIM

Test Site	DAL-FL
Tester	ETS364
Test Number	EB672302
Max Limit	5.175 V
Min Limit	4.75 V

krad(Si)	0	3	10	30	50	100
LL	4.750	4.750	4.750	4.750	4.750	4.750
Min	5.019	4.988	4.986	4.978	4.981	4.964
Average	5.019	5.003	5.007	4.996	4.991	4.999
Max	5.019	5.021	5.024	5.013	5.012	5.036
UL	5.175	5.175	5.175	5.175	5.175	5.175

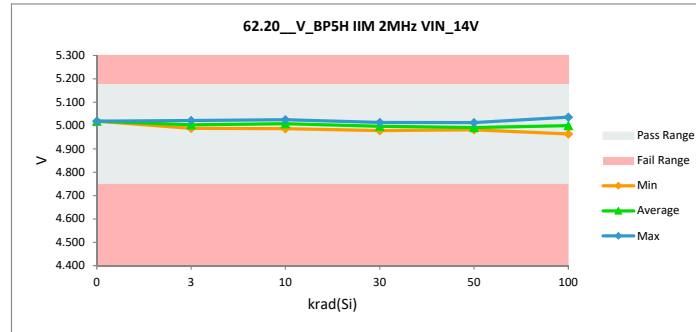

TID HDR Report
TPS7H6003-SP (5962R2220101VXC)

62.21_V_BP7L IIM 5MHz VIN_14V		
Test Site	DAL-FL	DAL-FL
Tester	ETS364	ETS364
Test Number	EB672302	EB672302
Unit	V	V
Max Limit	7.35	7.35
Min Limit	6.65	6.65

krad(Si)	Serial #	pre_short (rtp) (2)	ST_Combo (rpt) (Delta
0	Ctrl	7.019	7.019	0.000
3	58	7.022	7.025	0.003
3	59	6.981	6.984	0.002
3	60	6.953	6.956	0.002
3	61	6.966	6.964	-0.001
3	62	6.945	6.944	-0.001
3	134	7.014	6.984	-0.030
3	137	6.921	6.984	0.063
3	138	7.009	6.984	-0.025
3	139	6.957	6.957	0.001
3	236	6.952	6.972	0.019
10	63	6.956	6.953	-0.003
10	64	6.980	6.976	-0.004
10	65	7.003	7.005	0.002
10	66	6.997	6.996	-0.001
10	150	6.996	6.990	-0.006
10	237	6.990	6.971	-0.019
10	241	6.998	6.984	-0.013
10	242	6.973	6.975	0.003
10	243	6.973	6.973	0.001
10	244	7.047	7.043	-0.004
30	141	7.013	7.010	-0.003
30	144	6.968	6.967	-0.001
30	145	7.011	7.009	-0.002
30	146	6.989	6.980	-0.009
30	147	6.990	6.982	-0.008
30	132	7.014	7.016	0.002
30	133	7.011	7.001	-0.010
30	135	6.973	7.008	0.035
30	245	6.968	6.964	-0.004
30	246	6.982	6.973	-0.009
50	67	7.014	7.007	-0.007
50	68	6.975	6.953	-0.022
50	69	7.016	7.024	0.008
50	71	6.961	6.953	-0.007
50	72	6.976	6.970	-0.007
50	172	6.995	6.957	-0.037
50	173	7.006	6.993	-0.012
50	174	6.982	6.988	0.006
50	183	6.990	6.992	0.001
50	186	6.959	6.962	0.004
100	95	6.972	6.998	0.026
100	102	6.925	6.916	-0.008
100	104	7.005	6.990	-0.015
100	105	6.993	6.965	-0.028
100	106	6.918	6.916	-0.002
100	178	7.021	7.005	-0.016
100	179	6.959	7.008	0.049
100	180	6.993	6.981	-0.011
100	181	6.997	6.989	-0.008
100	182	6.999	7.030	0.031
Max		7.047	7.043	0.063
Average		6.985	6.983	-0.002
Min		6.918	6.916	-0.037
Std Dev		0.027	0.026	0.018

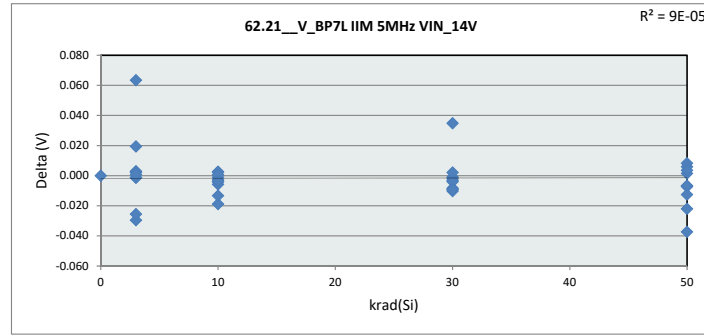

62.21_V_BP7L IIM		
Test Site	DAL-FL	
Tester	ETS364	
Test Number	EB672302	
Max Limit	7.35	V
Min Limit	6.65	V

krad(Si)	0	3	10	30	50	100
LL	6.650	6.650	6.650	6.650	6.650	6.650
Min	7.019	6.944	6.953	6.964	6.953	6.916
Average	7.019	6.975	6.987	6.991	6.980	6.980
Max	7.019	7.025	7.043	7.016	7.024	7.030
UL	7.350	7.350	7.350	7.350	7.350	7.350

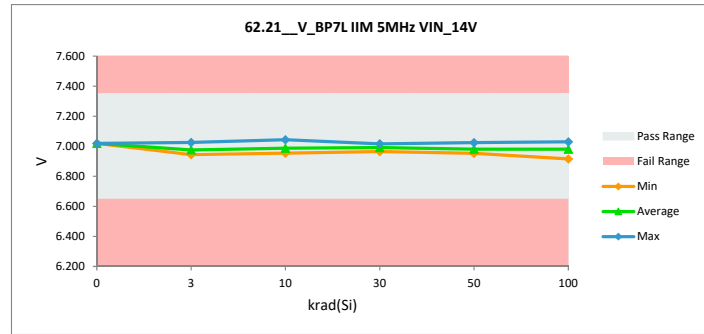

TID HDR Report
TPS7H6003-SP (5962R2220101VXC)

62.22_V_BP5L IIM 5MHz VIN		
Test Site	DAL-FL	DAL-FL
Tester	ETS364	ETS364
Test Number	EB672302	EB672302
Unit	V	V
Max Limit	5.175	5.175
Min Limit	4.75	4.75

krad(Si)	Serial #	pre_short (rtp)	(2)'ST_Combo (rpt)	Delta
0	Ctrl	5.043	5.043	0.000
3	58	5.018	5.018	0.000
3	59	5.008	5.009	0.000
3	60	5.021	5.020	0.000
3	61	5.023	5.021	-0.002
3	62	5.030	5.031	0.002
3	134	5.013	5.024	0.011
3	137	5.005	5.024	0.019
3	138	5.022	5.025	0.002
3	139	5.024	5.026	0.002
3	236	5.031	5.015	-0.016
10	63	5.028	5.025	-0.003
10	64	5.012	5.013	0.001
10	65	5.041	5.040	-0.001
10	66	5.034	5.032	-0.001
10	150	5.022	5.019	-0.003
10	237	5.040	5.016	-0.024
10	241	5.040	5.024	-0.015
10	242	5.005	5.007	0.001
10	243	5.029	5.033	0.004
10	244	5.025	5.030	0.004
30	141	5.030	5.030	-0.001
30	144	5.040	5.042	0.002
30	145	5.035	5.035	0.000
30	146	5.017	5.009	-0.007
30	147	5.048	5.048	0.001
30	132	5.019	5.020	0.001
30	133	5.033	5.032	-0.001
30	135	5.043	5.003	-0.040
30	245	5.032	5.027	-0.005
30	246	5.044	5.040	-0.004
50	67	5.009	5.006	-0.003
50	68	5.015	5.058	0.043
50	69	5.037	5.033	-0.004
50	71	5.028	5.030	0.002
50	72	5.025	5.019	-0.006
50	172	5.037	5.095	0.058
50	173	5.009	5.003	-0.006
50	174	5.039	5.041	0.002
50	183	5.032	5.036	0.004
50	186	5.015	5.017	0.002
100	95	5.022	5.006	-0.016
100	102	5.029	5.031	0.002
100	104	5.017	4.995	-0.022
100	105	5.014	5.073	0.059
100	106	5.021	4.942	-0.079
100	178	5.041	5.056	0.015
100	179	5.011	4.991	-0.020
100	180	5.042	4.971	-0.071
100	181	5.026	5.018	-0.008
100	182	5.033	5.049	0.016
	Max	5.048	5.095	0.059
	Average	5.027	5.025	-0.002
	Min	5.005	4.942	-0.079
	Std Dev	0.011	0.023	0.022

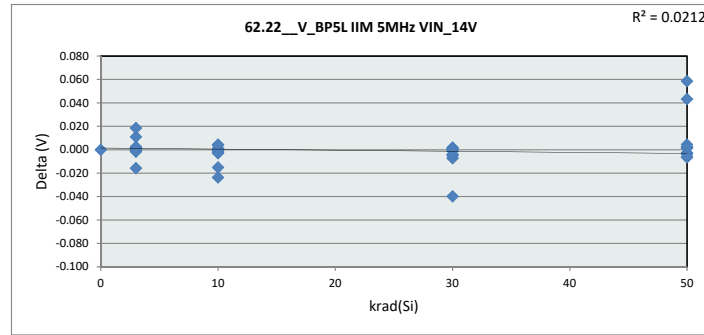

62.22_V_BP5L IIM		
Test Site	DAL-FL	
Tester	ETS364	
Test Number	EB672302	
Max Limit	5.175	V
Min Limit	4.75	V

krad(Si)	0	3	10	30	50	100
LL	4.750	4.750	4.750	4.750	4.750	4.750
Min	5.043	5.009	5.007	5.004	5.003	4.942
Average	5.043	5.021	5.024	5.029	5.034	5.013
Max	5.043	5.031	5.040	5.048	5.095	5.073
UL	5.175	5.175	5.175	5.175	5.175	5.175

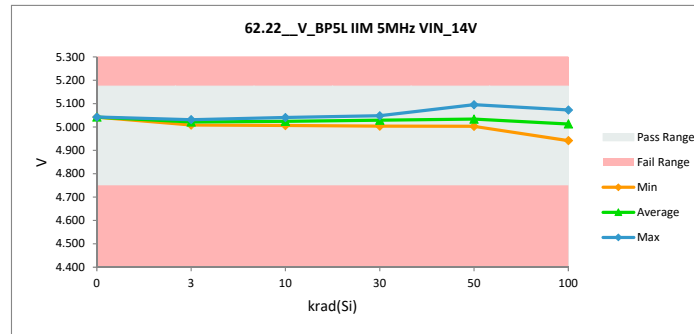

TID HDR Report
TPS7H6003-SP (5962R2220101VXC)

62.23_V_BP5H_IIM_5MHz_VIN		
Test Site	DAL-FL	DAL-FL
Tester	ETS364	ETS364
Test Number	EB672302	EB672302
Unit	V	V
Max Limit	5.175	5.175
Min Limit	4.75	4.75

krad(Si)	Serial #	pre_short (rtp)	(2)ST_Combo (rpt)	Delta
0	Ctrl	5.024	5.024	0.000
3	58	5.028	5.027	-0.001
3	59	5.014	5.012	-0.002
3	60	5.007	5.006	-0.001
3	61	5.001	5.000	-0.001
3	62	4.995	4.993	-0.002
3	134	5.007	5.010	0.003
3	137	5.012	5.010	-0.002
3	138	4.992	5.010	0.017
3	139	5.002	5.002	0.000
3	236	5.012	5.014	0.002
10	63	4.994	4.991	-0.003
10	64	5.008	5.009	0.001
10	65	5.027	5.027	0.000
10	66	4.998	4.995	-0.004
10	150	5.013	5.011	-0.003
10	237	4.989	5.014	0.025
10	241	5.005	5.010	0.005
10	242	5.028	5.029	0.001
10	243	5.028	5.028	0.000
10	244	5.011	5.011	0.000
30	141	5.017	5.016	0.000
30	144	4.990	4.983	-0.007
30	145	5.019	5.013	-0.005
30	146	5.002	4.990	-0.011
30	147	5.004	5.000	-0.003
30	132	5.016	5.005	-0.011
30	133	5.005	5.006	0.001
30	135	5.011	4.994	-0.017
30	245	5.017	5.019	0.001
30	246	4.988	4.983	-0.005
50	67	5.016	5.018	0.002
50	68	5.007	5.014	0.007
50	69	4.996	4.990	-0.006
50	71	4.997	4.995	-0.002
50	72	4.989	4.989	0.000
50	172	5.000	4.995	-0.006
50	173	4.999	4.991	-0.008
50	174	5.008	4.998	-0.010
50	183	4.992	4.986	-0.007
50	186	4.995	4.992	-0.003
100	95	4.994	4.984	-0.010
100	102	4.992	4.996	0.004
100	104	5.012	5.032	0.020
100	105	5.006	5.029	0.023
100	106	4.997	4.969	-0.029
100	178	5.000	4.992	-0.008
100	179	5.003	5.001	-0.002
100	180	4.998	4.997	-0.001
100	181	5.027	5.002	-0.025
100	182	5.018	5.043	0.025
	Max	5.028	5.043	0.025
	Average	5.006	5.005	-0.001
	Min	4.988	4.969	-0.029
	Std Dev	0.011	0.015	0.010

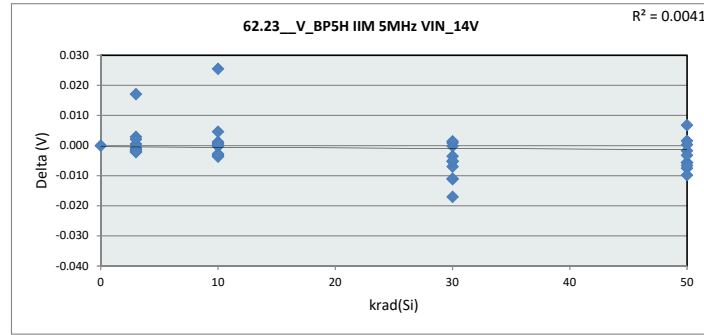

62.23_V_BP5H_IIM

Test Site	DAL-FL
Tester	ETS364
Test Number	EB672302
Max Limit	5.175 V
Min Limit	4.75 V

krad(Si)	0	3	10	30	50	100
LL	4.750	4.750	4.750	4.750	4.750	4.750
Min	5.024	4.993	4.991	4.983	4.986	4.969
Average	5.024	5.008	5.012	5.001	4.997	5.004
Max	5.024	5.027	5.029	5.019	5.018	5.043
UL	5.175	5.175	5.175	5.175	5.175	5.175

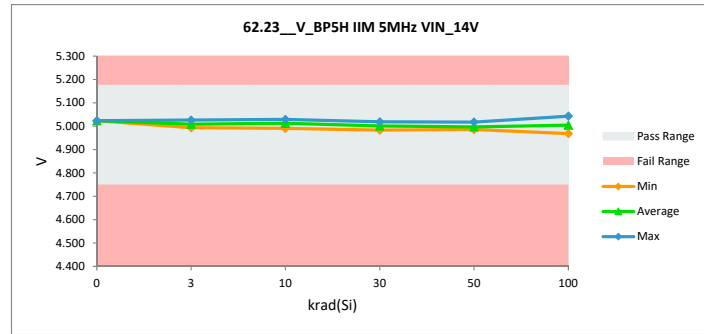

TID HDR Report
TPS7H6003-SP (5962R2220101VXC)

70.0 UVLO VIN Rise Thresh		
Test Site	DAL-FL	DAL-FL
Tester	ETS364	ETS364
Test Number	EB672302	EB672302
Unit	V	V
Max Limit	9	9
Min Limit	8	8

krad(Si)	Serial #	pre_short (rtp)	(2)ST_Combo (rpt)	Delta
0	Ctrl	8.585	8.585	0.000
3	58	8.590	8.590	0.000
3	59	8.655	8.655	0.000
3	60	8.565	8.560	-0.005
3	61	8.630	8.620	-0.010
3	62	8.570	8.565	-0.005
3	134	8.590	8.540	-0.050
3	137	8.565	8.540	-0.025
3	138	8.615	8.540	-0.075
3	139	8.635	8.640	0.005
3	236	8.630	8.630	0.000
10	63	8.580	8.565	-0.015
10	64	8.595	8.590	-0.005
10	65	8.585	8.580	-0.005
10	66	8.585	8.575	-0.010
10	150	8.635	8.620	-0.015
10	237	8.650	8.630	-0.020
10	241	8.610	8.540	-0.070
10	242	8.620	8.610	-0.010
10	243	8.570	8.560	-0.010
10	244	8.705	8.695	-0.010
30	141	8.635	8.620	-0.015
30	144	8.660	8.635	-0.025
30	145	8.620	8.605	-0.015
30	146	8.605	8.605	0.000
30	147	8.590	8.575	-0.015
30	132	8.640	8.640	0.000
30	133	8.570	8.545	-0.025
30	135	8.640	8.620	-0.020
30	245	8.580	8.560	-0.020
30	246	8.525	8.530	0.005
50	67	8.620	8.605	-0.015
50	68	8.570	8.605	0.035
50	69	8.645	8.630	-0.015
50	71	8.640	8.630	-0.010
50	72	8.650	8.640	-0.010
50	172	8.580	8.530	-0.050
50	173	8.635	8.610	-0.025
50	174	8.695	8.665	-0.030
50	183	8.565	8.515	-0.050
50	186	8.570	8.530	-0.040
100	95	8.600	8.585	-0.015
100	102	8.600	8.605	0.005
100	104	8.580	8.560	-0.020
100	105	8.655	8.635	-0.020
100	106	8.600	8.580	-0.020
100	178	8.725	8.670	-0.055
100	179	8.620	8.570	-0.050
100	180	8.665	8.595	-0.070
100	181	8.575	8.500	-0.075
100	182	8.565	8.505	-0.060
Max		8.725	8.695	0.035
Average		8.611	8.591	-0.021
Min		8.525	8.500	-0.075
Std Dev		0.040	0.045	0.023

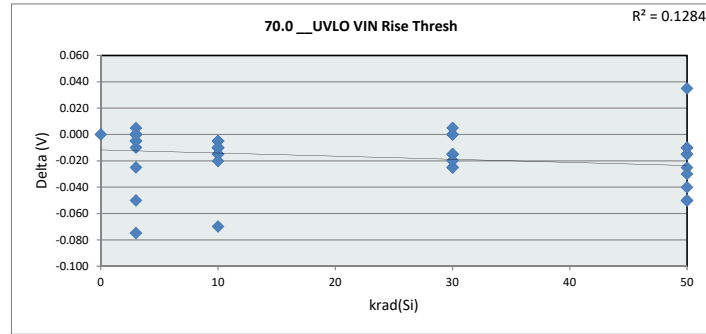

70.0 UVLO VIN Rise Thresh						
Test Site	DAL-FL					
Tester	ETS364					
Test Number	EB672302					
Max Limit	9	V				
Min Limit	8	V				
krad(Si)	0	3	10	30	50	100
LL	8.000	8.000	8.000	8.000	8.000	8.000
Min	8.585	8.540	8.540	8.530	8.515	8.500
Average	8.585	8.588	8.597	8.594	8.596	8.580
Max	8.585	8.655	8.695	8.640	8.665	8.670
UL	9.000	9.000	9.000	9.000	9.000	9.000

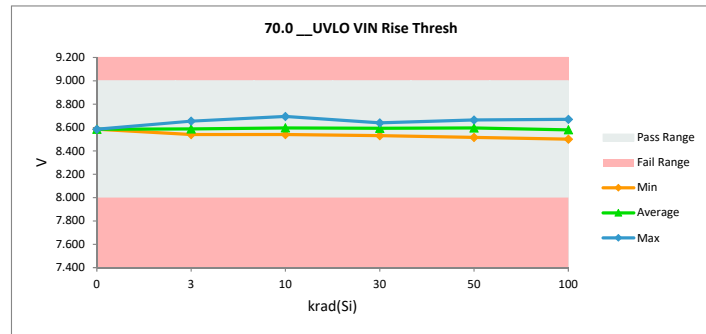

TID HDR Report
TPS7H6003-SP (5962R2220101VXC)

70.1 UVLO VIN Fall Thresh		
Test Site	DAL-FL	DAL-FL
Tester	ETS364	ETS364
Test Number	EB672302	EB672302
Unit	V	V
Max Limit	8.5	8.5
Min Limit	7.5	7.5

krad(Si)	Serial #	pre_short (rtp)	(2)'ST_Combo (rpt)	Delta
0	Ctrl	8.045	8.045	0.000
3	58	8.055	8.055	0.000
3	59	8.120	8.115	-0.005
3	60	8.035	8.030	-0.005
3	61	8.095	8.085	-0.010
3	62	8.035	8.030	-0.005
3	134	8.060	8.015	-0.045
3	137	8.035	8.015	-0.020
3	138	8.085	8.015	-0.070
3	139	8.100	8.105	0.005
3	236	8.095	8.095	0.000
10	63	8.050	8.030	-0.020
10	64	8.055	8.055	0.000
10	65	8.050	8.045	-0.005
10	66	8.050	8.045	-0.005
10	150	8.100	8.085	-0.015
10	237	8.120	8.095	-0.025
10	241	8.080	8.015	-0.065
10	242	8.085	8.075	-0.010
10	243	8.040	8.030	-0.010
10	244	8.165	8.160	-0.005
30	141	8.100	8.085	-0.015
30	144	8.120	8.100	-0.020
30	145	8.085	8.070	-0.015
30	146	8.075	8.070	-0.005
30	147	8.060	8.045	-0.015
30	132	8.105	8.105	0.000
30	133	8.035	8.015	-0.020
30	135	8.105	8.085	-0.020
30	245	8.045	8.030	-0.015
30	246	7.995	8.000	0.005
50	67	8.085	8.075	-0.010
50	68	8.035	8.065	0.030
50	69	8.110	8.095	-0.015
50	71	8.105	8.090	-0.015
50	72	8.115	8.105	-0.010
50	172	8.050	8.000	-0.050
50	173	8.100	8.075	-0.025
50	174	8.160	8.130	-0.030
50	183	8.035	7.985	-0.050
50	186	8.040	8.000	-0.040
100	95	8.070	8.050	-0.020
100	102	8.060	8.070	0.010
100	104	8.050	8.030	-0.020
100	105	8.115	8.100	-0.015
100	106	8.065	8.050	-0.015
100	178	8.190	8.135	-0.055
100	179	8.085	8.035	-0.050
100	180	8.125	8.060	-0.065
100	181	8.040	7.975	-0.065
100	182	8.035	7.975	-0.060
Max		8.190	8.160	0.030
Average		8.077	8.058	-0.020
Min		7.995	7.975	-0.070
Std Dev		0.039	0.042	0.022

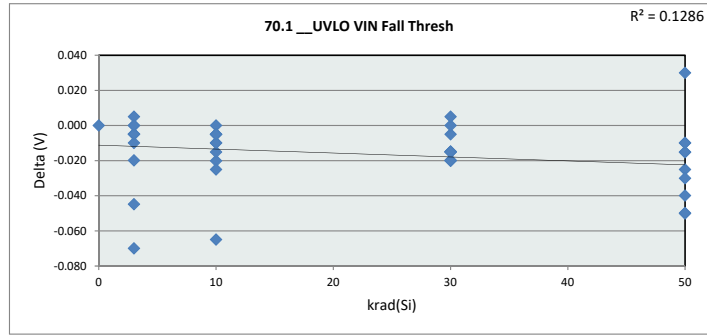

70.1 UVLO VIN Fa		
Test Site	DAL-FL	
Tester	ETS364	
Test Number	EB672302	
Max Limit	8.5	V
Min Limit	7.5	V

krad(Si)	0	3	10	30	50	100
LL	7.500	7.500	7.500	7.500	7.500	7.500
Min	8.045	8.015	8.015	8.000	7.985	7.975
Average	8.045	8.056	8.064	8.061	8.062	8.048
Max	8.045	8.115	8.160	8.105	8.130	8.135
UL	8.500	8.500	8.500	8.500	8.500	8.500

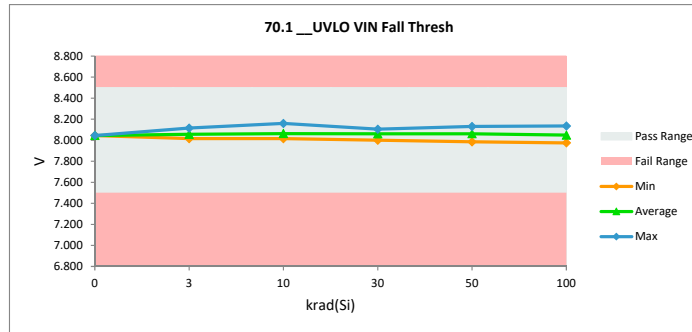

TID HDR Report
TPS7H6003-SP (5962R2220101VXC)

75.0 UVLO BOOT Rise Thresh		
Test Site	DAL-FL	DAL-FL
Tester	ETS364	ETS364
Test Number	EB672302	EB672302
Unit	V	V
Max Limit	7.4	7.4
Min Limit	6.6	6.6

krad(Si)	Serial #	pre_short (rtp)	(2)ST_Combo (rpt)	Delta
0	Ctrl	7.108	7.108	0.000
3	58	7.102	7.102	0.000
3	59	7.102	7.098	-0.005
3	60	7.068	7.068	0.000
3	61	7.098	7.098	0.000
3	62	7.128	7.123	-0.005
3	134	7.133	7.082	-0.050
3	137	7.098	7.082	-0.015
3	138	7.032	7.082	0.050
3	139	7.098	7.102	0.005
3	236	7.068	7.108	0.040
10	63	7.098	7.093	-0.005
10	64	7.073	7.068	-0.005
10	65	7.088	7.077	-0.010
10	66	6.992	6.992	0.000
10	150	7.057	7.052	-0.005
10	237	7.088	7.108	0.020
10	241	7.128	7.082	-0.045
10	242	7.013	7.022	0.010
10	243	7.088	7.093	0.005
10	244	7.093	7.117	0.025
30	141	7.077	7.082	0.005
30	144	7.068	7.057	-0.010
30	145	7.057	7.048	-0.010
30	146	7.077	7.068	-0.010
30	147	7.082	7.073	-0.010
30	132	7.098	7.098	0.000
30	133	7.032	7.043	0.010
30	135	7.137	7.128	-0.010
30	245	7.123	7.117	-0.005
30	246	7.068	7.068	0.000
50	67	7.057	7.032	-0.025
50	68	7.082	7.057	-0.025
50	69	7.167	7.148	-0.020
50	71	7.123	7.112	-0.010
50	72	7.063	7.063	0.000
50	172	7.073	7.043	-0.030
50	173	7.098	7.088	-0.010
50	174	7.073	7.052	-0.020
50	183	7.077	7.073	-0.005
50	186	7.043	7.032	-0.010
100	95	7.038	7.027	-0.010
100	102	7.093	7.057	-0.035
100	104	7.052	7.048	-0.005
100	105	7.052	7.048	-0.005
100	106	7.068	7.057	-0.010
100	178	7.102	7.052	-0.050
100	179	7.052	6.992	-0.060
100	180	7.177	7.137	-0.040
100	181	7.057	7.022	-0.035
100	182	7.157	7.088	-0.070
Max		7.177	7.148	0.050
Average		7.084	7.074	-0.010
Min		6.992	6.992	-0.070
Std Dev		0.037	0.034	0.022

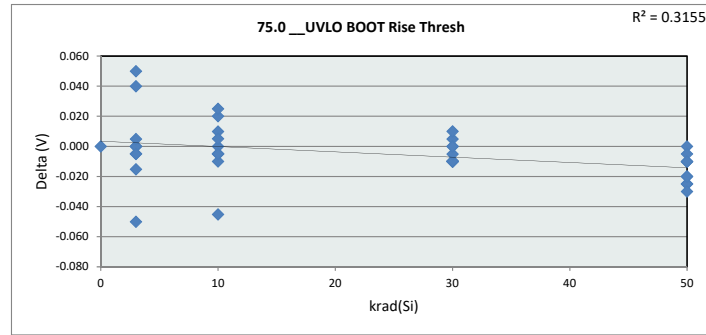

75.0 UVLO BOOT		
Test Site	DAL-FL	
Tester	ETS364	
Test Number	EB672302	
Max Limit	7.4	V
Min Limit	6.6	V

krad(Si)	0	3	10	30	50	100
LL	6.600	6.600	6.600	6.600	6.600	6.600
Min	7.108	7.068	6.993	7.043	7.033	6.993
Average	7.108	7.095	7.071	7.078	7.070	7.053
Max	7.108	7.123	7.118	7.128	7.148	7.137
UL	7.400	7.400	7.400	7.400	7.400	7.400

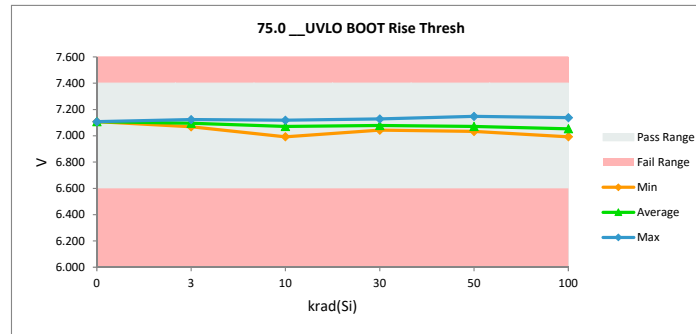

TID HDR Report
TPS7H6003-SP (5962R2220101VXC)

75.1 UVLO BOOT Fail Thresh		
Test Site	DAL-FL	DAL-FL
Tester	ETS364	ETS364
Test Number	EB672302	EB672302
Unit	V	V
Max Limit	7	7
Min Limit	6.2	6.2

krad(Si)	Serial #	pre_short (rtp)	(2)'ST_Combo (rpt)	Delta
0	Ctrl	6.668	6.668	0.000
3	58	6.663	6.663	0.000
3	59	6.657	6.652	-0.005
3	60	6.633	6.628	-0.005
3	61	6.657	6.657	0.000
3	62	6.677	6.677	0.000
3	134	6.693	6.638	-0.055
3	137	6.652	6.638	-0.015
3	138	6.597	6.638	0.040
3	139	6.663	6.668	0.005
3	236	6.628	6.668	0.040
10	63	6.652	6.652	0.000
10	64	6.633	6.628	-0.005
10	65	6.648	6.638	-0.010
10	66	6.557	6.557	0.000
10	150	6.622	6.617	-0.005
10	237	6.648	6.668	0.020
10	241	6.688	6.638	-0.050
10	242	6.578	6.588	0.010
10	243	6.657	6.663	0.005
10	244	6.663	6.677	0.015
30	141	6.642	6.638	-0.005
30	144	6.633	6.628	-0.005
30	145	6.622	6.617	-0.005
30	146	6.633	6.628	-0.005
30	147	6.638	6.628	-0.010
30	132	6.663	6.657	-0.005
30	133	6.597	6.608	0.010
30	135	6.693	6.688	-0.005
30	245	6.677	6.682	0.005
30	246	6.638	6.628	-0.010
50	67	6.622	6.603	-0.020
50	68	6.642	6.617	-0.025
50	69	6.723	6.702	-0.020
50	71	6.677	6.668	-0.010
50	72	6.622	6.622	0.000
50	172	6.633	6.608	-0.025
50	173	6.657	6.648	-0.010
50	174	6.633	6.617	-0.015
50	183	6.633	6.633	0.000
50	186	6.608	6.597	-0.010
100	95	6.603	6.592	-0.010
100	102	6.652	6.617	-0.035
100	104	6.617	6.608	-0.010
100	105	6.613	6.608	-0.005
100	106	6.622	6.617	-0.005
100	178	6.663	6.617	-0.045
100	179	6.613	6.562	-0.050
100	180	6.727	6.693	-0.035
100	181	6.617	6.582	-0.035
100	182	6.713	6.657	-0.055
Max		6.727	6.702	0.040
Average		6.644	6.635	-0.009
Min		6.557	6.557	-0.055
Std Dev		0.034	0.032	0.020

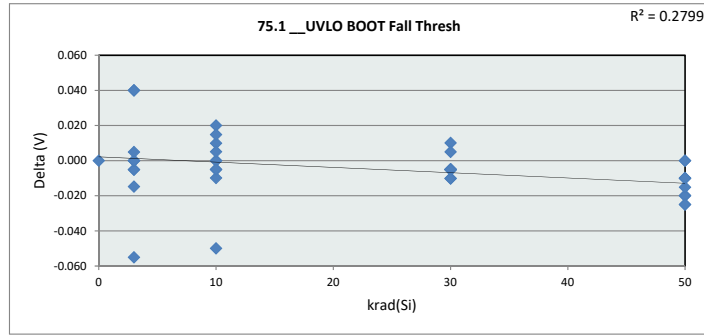

75.1 UVLO BOOT		
Test Site	DAL-FL	
Tester	ETS364	
Test Number	EB672302	
Max Limit	7	V
Min Limit	6.2	V

krad(Si)	0	3	10	30	50	100
LL	6.200	6.200	6.200	6.200	6.200	6.200
Min	6.668	6.628	6.558	6.608	6.598	6.562
Average	6.668	6.653	6.633	6.640	6.632	6.616
Max	6.668	6.677	6.677	6.688	6.703	6.693
UL	7.000	7.000	7.000	7.000	7.000	7.000

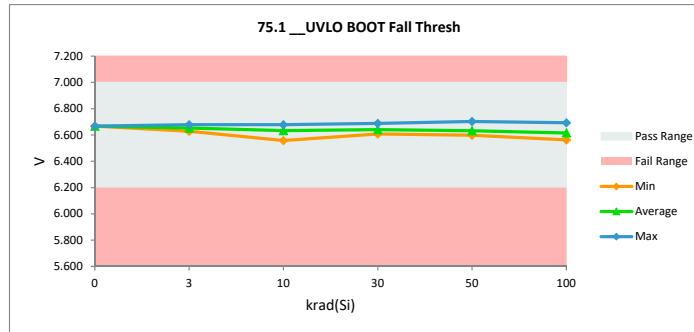

TID HDR Report
TPS7H6003-SP (5962R2220101VXC)

90.0_PWM_LI Rise Thresh VIN		
Test Site	DAL-FL	DAL-FL
Tester	ETS364	ETS364
Test Number	EB672302	EB672302
Unit	V	V
Max Limit	2.65	2.65
Min Limit	1.8	1.8

krad(Si)	Serial #	pre_short (rtp)	(2)ST_Combo (rpt)	Delta
0	Ctrl	2.200	2.200	0.000
3	58	2.255	2.235	-0.020
3	59	2.220	2.205	-0.015
3	60	2.310	2.310	0.000
3	61	2.220	2.195	-0.025
3	62	2.260	2.270	0.010
3	134	2.195	2.190	-0.005
3	137	2.205	2.185	-0.020
3	138	2.190	2.190	0.000
3	139	2.200	2.190	-0.010
3	236	2.230	2.235	0.005
10	63	2.215	2.215	0.000
10	64	2.245	2.230	-0.015
10	65	2.215	2.250	0.035
10	66	2.215	2.205	-0.010
10	150	2.225	2.190	-0.035
10	237	2.325	2.230	-0.095
10	241	2.200	2.190	-0.010
10	242	2.190	2.195	0.005
10	243	2.215	2.210	-0.005
10	244	2.190	2.175	-0.015
30	141	2.225	2.185	-0.040
30	144	2.205	2.165	-0.040
30	145	2.235	2.235	0.000
30	146	2.205	2.160	-0.045
30	147	2.210	2.190	-0.020
30	132	2.210	2.245	0.035
30	133	2.260	2.210	-0.050
30	135	2.285	2.255	-0.030
30	245	2.240	2.195	-0.045
30	246	2.265	2.215	-0.050
50	67	2.240	2.135	-0.105
50	68	2.240	2.185	-0.055
50	69	2.235	2.165	-0.070
50	71	2.220	2.195	-0.025
50	72	2.230	2.140	-0.090
50	172	2.255	2.205	-0.050
50	173	2.190	2.200	0.010
50	174	2.195	2.165	-0.030
50	183	2.285	2.235	-0.050
50	186	2.270	2.195	-0.075
100	95	2.325	2.145	-0.180
100	102	2.215	2.105	-0.110
100	104	2.240	2.130	-0.110
100	105	2.210	2.120	-0.090
100	106	2.220	2.135	-0.085
100	178	2.280	2.185	-0.095
100	179	2.225	2.135	-0.090
100	180	2.210	2.095	-0.115
100	181	2.275	2.215	-0.060
100	182	2.300	2.185	-0.115
Max		2.325	2.310	0.035
Average		2.234	2.193	-0.041
Min		2.190	2.095	-0.180
Std Dev		0.035	0.042	0.045

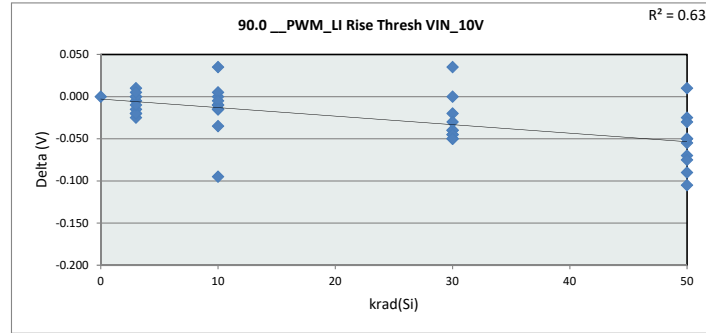

90.0_PWM_LI Rise		
Test Site	DAL-FL	
Tester	ETS364	
Test Number	EB672302	
Max Limit	2.65	V
Min Limit	1.8	V

krad(Si)	0	3	10	30	50	100
LL	1.800	1.800	1.800	1.800	1.800	1.800
Min	2.200	2.185	2.175	2.160	2.135	2.095
Average	2.200	2.221	2.209	2.206	2.182	2.145
Max	2.200	2.310	2.250	2.255	2.235	2.215
UL	2.650	2.650	2.650	2.650	2.650	2.650

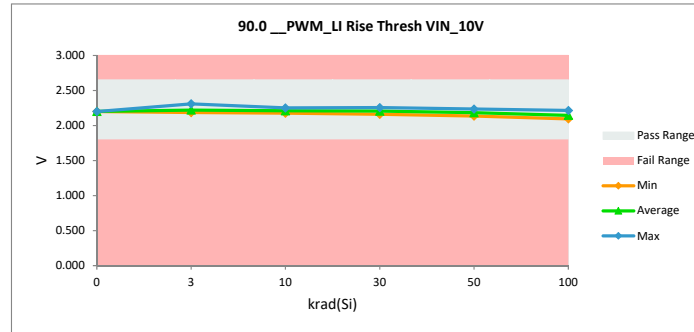

TID HDR Report
TPS7H6003-SP (5962R2220101VXC)

90.1 PWM_LI Fall Thresh VIN		
Test Site	DAL-FL	DAL-FL
Tester	ETS364	ETS364
Test Number	EB672302	EB672302
Unit	V	V
Max Limit	1.85	1.85
Min Limit	1.15	1.15

krad(Si)	Serial #	pre_short (rtp)	(2)'ST_Combo (rpt)	Delta
0	Ctrl	1.485	1.485	0.000
3	58	1.395	1.395	0.000
3	59	1.410	1.405	-0.005
3	60	1.470	1.420	-0.050
3	61	1.500	1.495	-0.005
3	62	1.505	1.475	-0.030
3	134	1.495	1.495	0.000
3	137	1.495	1.495	0.000
3	138	1.500	1.495	-0.005
3	139	1.505	1.500	-0.005
3	236	1.505	1.485	-0.020
10	63	1.425	1.410	-0.015
10	64	1.390	1.380	-0.010
10	65	1.450	1.440	-0.010
10	66	1.505	1.455	-0.050
10	150	1.420	1.430	0.010
10	237	1.450	1.485	0.035
10	241	1.510	1.495	-0.015
10	242	1.495	1.490	-0.005
10	243	1.500	1.495	-0.005
10	244	1.505	1.495	-0.010
30	141	1.490	1.395	-0.095
30	144	1.505	1.465	-0.040
30	145	1.475	1.400	-0.075
30	146	1.420	1.400	-0.020
30	147	1.510	1.485	-0.025
30	132	1.470	1.370	-0.100
30	133	1.505	1.480	-0.025
30	135	1.505	1.385	-0.120
30	245	1.505	1.485	-0.020
30	246	1.515	1.435	-0.080
50	67	1.485	1.435	-0.050
50	68	1.435	1.465	0.030
50	69	1.510	1.450	-0.060
50	71	1.455	1.465	0.010
50	72	1.505	1.465	-0.040
50	172	1.495	1.485	-0.010
50	173	1.510	1.480	-0.030
50	174	1.505	1.380	-0.125
50	183	1.420	1.400	-0.020
50	186	1.500	1.470	-0.030
100	95	1.380	1.335	-0.045
100	102	1.410	1.360	-0.050
100	104	1.460	1.410	-0.050
100	105	1.505	1.460	-0.045
100	106	1.415	1.310	-0.105
100	178	1.515	1.385	-0.130
100	179	1.505	1.445	-0.060
100	180	1.420	1.355	-0.065
100	181	1.495	1.455	-0.040
100	182	1.510	1.475	-0.035
Max		1.515	1.500	0.035
Average		1.475	1.441	-0.034
Min		1.380	1.310	-0.130
Std Dev		0.040	0.049	0.038

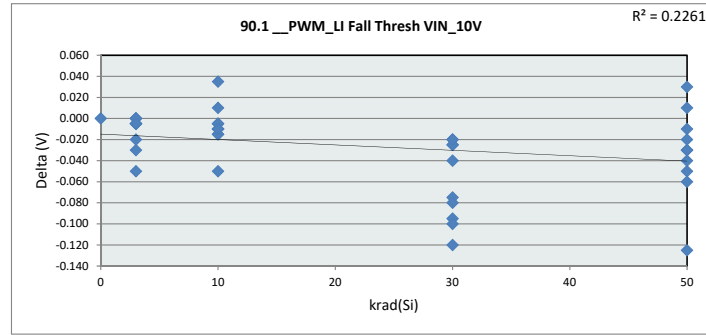

90.1 PWM_LI Fall						
Test Site	DAL-FL					
Tester	ETS364					
Test Number	EB672302					
Max Limit	1.85	V				
Min Limit	1.15	V				
krad(Si)	0	3	10	30	50	100
LL	1.150	1.150	1.150	1.150	1.150	1.150
Min	1.485	1.395	1.380	1.370	1.380	1.310
Average	1.485	1.466	1.458	1.430	1.450	1.399
Max	1.485	1.500	1.495	1.485	1.485	1.475
UL	1.850	1.850	1.850	1.850	1.850	1.850

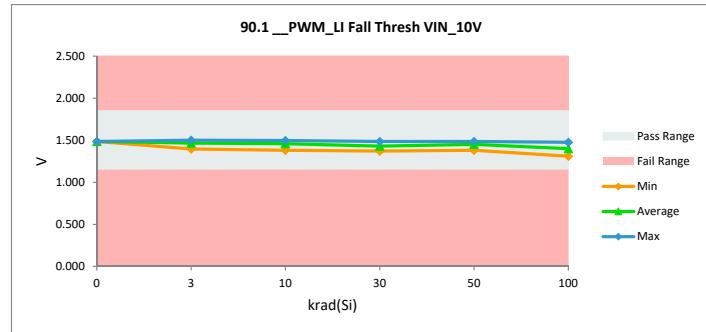

TID HDR Report
TPS7H6003-SP (5962R2220101VXC)

90.3 EN_HI Rise Thresh VIN		
Test Site	DAL-FL	DAL-FL
Tester	ETS364	ETS364
Test Number	EB672302	EB672302
Unit	V	V
Max Limit	2.65	2.65
Min Limit	1.8	1.8

krad(Si)	Serial #	pre_short (rtp)	(2)ST_Combo (rpt)	Delta
0	Ctrl	2.275	2.275	0.000
3	58	2.230	2.230	0.000
3	59	2.225	2.185	-0.040
3	60	2.200	2.225	0.025
3	61	2.280	2.255	-0.025
3	62	2.295	2.280	-0.015
3	134	2.265	2.225	-0.040
3	137	2.180	2.225	0.045
3	138	2.295	2.230	-0.065
3	139	2.200	2.250	0.050
3	236	2.230	2.340	0.110
10	63	2.185	2.170	-0.015
10	64	2.215	2.195	-0.020
10	65	2.310	2.280	-0.030
10	66	2.205	2.195	-0.010
10	150	2.255	2.245	-0.010
10	237	2.270	2.350	0.080
10	241	2.260	2.230	-0.030
10	242	2.190	2.190	0.000
10	243	2.325	2.295	-0.030
10	244	2.210	2.195	-0.015
30	141	2.195	2.165	-0.030
30	144	2.200	2.235	0.035
30	145	2.200	2.155	-0.045
30	146	2.255	2.225	-0.030
30	147	2.285	2.295	0.010
30	132	2.255	2.235	-0.020
30	133	2.210	2.170	-0.040
30	135	2.220	2.240	0.020
30	245	2.220	2.185	-0.035
30	246	2.240	2.225	-0.015
50	67	2.300	2.265	-0.035
50	68	2.245	2.160	-0.085
50	69	2.310	2.290	-0.020
50	71	2.310	2.245	-0.065
50	72	2.205	2.140	-0.065
50	172	2.215	2.180	-0.035
50	173	2.310	2.260	-0.050
50	174	2.190	2.250	0.060
50	183	2.295	2.215	-0.080
50	186	2.185	2.140	-0.045
100	95	2.285	2.135	-0.150
100	102	2.250	2.155	-0.095
100	104	2.305	2.210	-0.095
100	105	2.205	2.160	-0.045
100	106	2.190	2.055	-0.135
100	178	2.205	2.135	-0.070
100	179	2.185	2.110	-0.075
100	180	2.255	2.135	-0.120
100	181	2.190	2.110	-0.080
100	182	2.210	2.155	-0.055
Max		2.325	2.350	0.110
Average		2.240	2.210	-0.030
Min		2.180	2.055	-0.150
Std Dev		0.044	0.060	0.050

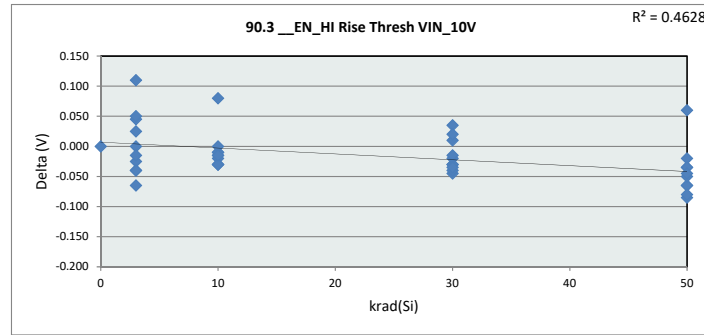

90.3 EN_HI Rise T		
Test Site	DAL-FL	
Tester	ETS364	
Test Number	EB672302	
Max Limit	2.65	V
Min Limit	1.8	V

krad(Si)	0	3	10	30	50	100
LL	1.800	1.800	1.800	1.800	1.800	1.800
Min	2.275	2.185	2.170	2.155	2.140	2.055
Average	2.275	2.245	2.235	2.213	2.215	2.136
Max	2.275	2.340	2.350	2.295	2.290	2.210
UL	2.650	2.650	2.650	2.650	2.650	2.650

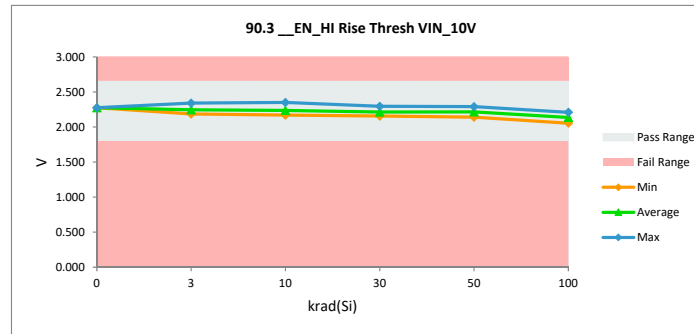

TID HDR Report
TPS7H6003-SP (5962R2220101VXC)

90.4 __EN_HI Fall Thresh VIN_1		
Test Site	DAL-FL	DAL-FL
Tester	ETS364	ETS364
Test Number	EB672302	EB672302
Unit	V	V
Max Limit	1.85	1.85
Min Limit	1.15	1.15

krad(Si)	Serial #	pre_short (rtp) (2)'ST_Combo (rpt) (Delta
0	Ctrl	1.430 1.430	0.000
3	58	1.455 1.495	0.040
3	59	1.435 1.410	-0.025
3	60	1.490 1.490	0.000
3	61	1.440 1.425	-0.015
3	62	1.460 1.445	-0.015
3	134	1.510 1.495	-0.015
3	137	1.495 1.500	0.005
3	138	1.405 1.500	0.095
3	139	1.510 1.500	-0.010
3	236	1.500 1.500	0.000
10	63	1.495 1.415	-0.080
10	64	1.445 1.485	0.040
10	65	1.420 1.410	-0.010
10	66	1.455 1.435	-0.020
10	150	1.425 1.380	-0.045
10	237	1.505 1.500	-0.005
10	241	1.520 1.500	-0.020
10	242	1.490 1.435	-0.055
10	243	1.505 1.500	-0.005
10	244	1.505 1.395	-0.110
30	141	1.510 1.465	-0.045
30	144	1.510 1.430	-0.080
30	145	1.510 1.485	-0.025
30	146	1.500 1.470	-0.030
30	147	1.515 1.410	-0.105
30	132	1.505 1.460	-0.045
30	133	1.515 1.460	-0.055
30	135	1.525 1.405	-0.120
30	245	1.420 1.370	-0.050
30	246	1.510 1.445	-0.065
50	67	1.510 1.430	-0.080
50	68	1.495 1.460	-0.035
50	69	1.510 1.410	-0.100
50	71	1.445 1.475	0.030
50	72	1.370 1.350	-0.020
50	172	1.515 1.405	-0.110
50	173	1.520 1.440	-0.080
50	174	1.510 1.470	-0.040
50	183	1.505 1.400	-0.105
50	186	1.505 1.465	-0.040
100	95	1.505 1.380	-0.125
100	102	1.385 1.320	-0.065
100	104	1.445 1.375	-0.070
100	105	1.470 1.470	0.000
100	106	1.390 1.375	-0.015
100	178	1.515 1.435	-0.080
100	179	1.495 1.435	-0.060
100	180	1.500 1.335	-0.165
100	181	1.505 1.440	-0.065
100	182	1.515 1.380	-0.135
	Max	1.525 1.500	0.095
	Average	1.481 1.437	-0.044
	Min	1.370 1.320	-0.165
	Std Dev	0.041 0.047	0.050

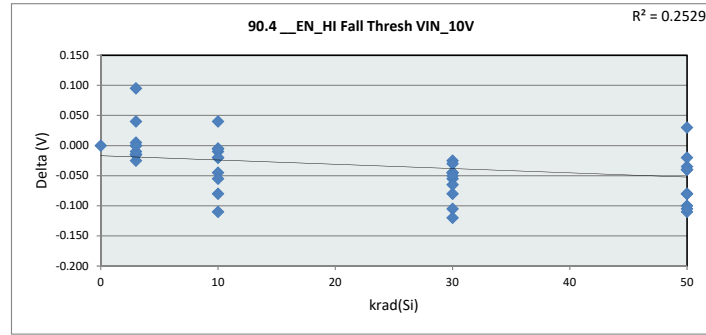

90.4 __EN_HI Fall T						
Test Site	DAL-FL					
Tester	ETS364					
Test Number	EB672302					
Max Limit	1.85	V				
Min Limit	1.15	V				
krad(Si)	0	3	10	30	50	100
LL	1.150	1.150	1.150	1.150	1.150	1.150
Min	1.430	1.410	1.380	1.370	1.350	1.320
Average	1.430	1.476	1.446	1.440	1.431	1.395
Max	1.430	1.500	1.500	1.485	1.475	1.470
UL	1.850	1.850	1.850	1.850	1.850	1.850

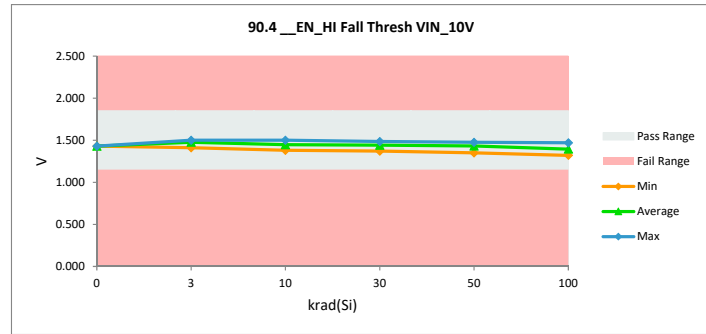

TID HDR Report
TPS7H6003-SP (5962R2220101VXC)

90.6_PWM_LI Pull Down Resist		
Test Site	DAL-FL	DAL-FL
Tester	ETS364	ETS364
Test Number	EB672302	EB672302
Unit	kOhms	KOHMS
Max Limit	400	400
Min Limit	100	100

krad(Si)	Serial #	pre_short (rtp)	(2)'ST_Combo (rpt)	Delta
0	Ctrl	203.572	203.572	0.000
3	58	200.855	200.570	-0.286
3	59	195.180	196.442	1.262
3	60	204.164	204.284	0.120
3	61	197.227	197.587	0.359
3	62	200.746	202.190	1.444
3	134	196.141	191.031	-5.111
3	137	195.102	190.941	-4.161
3	138	192.296	191.559	-0.737
3	139	190.260	192.331	2.071
3	236	207.196	195.126	-12.070
10	63	194.549	195.770	1.221
10	64	199.633	202.353	2.720
10	65	197.279	198.734	1.455
10	66	207.138	208.823	1.685
10	150	189.865	193.175	3.311
10	237	194.320	195.489	1.169
10	241	195.301	191.182	-4.119
10	242	203.229	205.352	2.123
10	243	205.911	208.937	3.026
10	244	193.561	196.477	2.915
30	141	193.621	195.953	2.332
30	144	193.926	196.374	2.449
30	145	192.772	194.891	2.118
30	146	202.290	204.892	2.602
30	147	201.721	204.747	3.026
30	132	195.986	197.899	1.913
30	133	193.333	195.331	1.998
30	135	195.179	200.517	5.338
30	245	196.863	199.314	2.452
30	246	194.759	196.986	2.226
50	67	196.201	197.382	1.181
50	68	208.817	195.405	-13.412
50	69	196.296	197.889	1.593
50	71	200.452	201.516	1.065
50	72	202.986	204.333	1.347
50	172	192.045	194.116	2.071
50	173	199.864	201.577	1.713
50	174	196.498	198.259	1.760
50	183	197.071	198.723	1.651
50	186	196.870	199.136	2.266
100	95	197.768	199.230	1.463
100	102	207.628	210.061	2.433
100	104	206.341	208.503	2.162
100	105	199.695	200.840	1.145
100	106	202.378	204.136	1.758
100	178	195.744	197.000	1.256
100	179	197.553	199.748	2.194
100	180	198.742	200.471	1.729
100	181	199.111	200.940	1.829
100	182	203.168	204.833	1.665
	Max	208.817	210.061	5.338
	Average	198.416	199.273	0.857
	Min	189.865	190.941	-13.412
	Std Dev	4.743	4.842	3.293

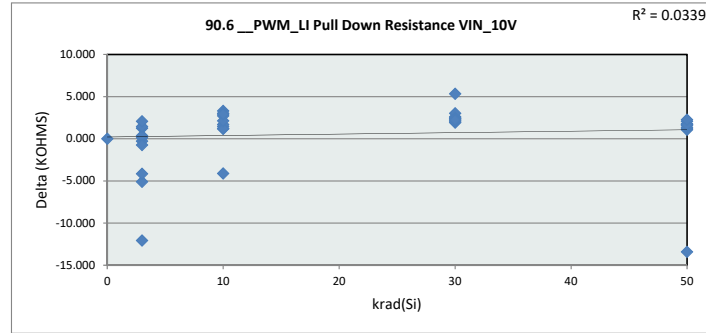

90.6_PWM_LI Pull		
Test Site	DAL-FL	
Tester	ETS364	
Test Number	EB672302	
Max Limit	400	KOHMS
Min Limit	100	KOHMS

krad(Si)	0	3	10	30	50	100
LL	100.000	100.000	100.000	100.000	100.000	100.000
Min	203.572	190.941	191.182	194.891	194.116	197.000
Average	203.572	196.206	199.629	198.690	198.834	202.576
Max	203.572	204.284	208.937	204.892	204.333	210.061
UL	400.000	400.000	400.000	400.000	400.000	400.000

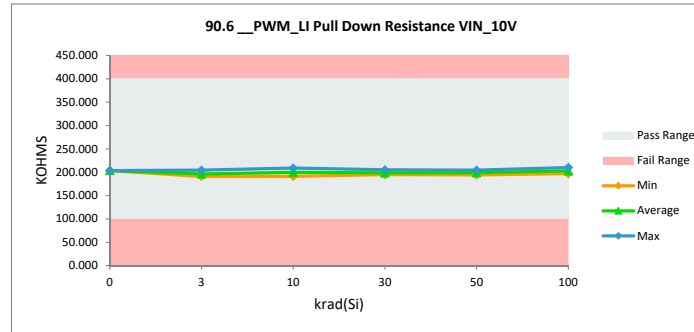

TID HDR Report
TPS7H6003-SP (5962R2220101VXC)

90.7 __EN_HI Pull Down Resista		
Test Site	DAL-FL	DAL-FL
Tester	ETS364	ETS364
Test Number	EB672302	EB672302
Unit	kOhms	KOHMS
Max Limit	400	400
Min Limit	100	100

krad(Si)	Serial #	pre_short (rtp)	(2)'ST_Combo (rpt)	Delta
0	Ctrl	203.336	203.336	0.000
3	58	199.609	199.241	-0.368
3	59	193.893	195.155	1.262
3	60	203.337	203.459	0.122
3	61	196.562	196.899	0.337
3	62	201.619	203.049	1.430
3	134	196.489	189.664	-6.826
3	137	195.107	189.592	-5.514
3	138	192.102	190.184	-1.918
3	139	189.414	191.541	2.127
3	236	205.815	194.632	-11.184
10	63	194.177	195.396	1.219
10	64	197.850	200.509	2.660
10	65	196.739	198.220	1.481
10	66	206.448	208.130	1.682
10	150	188.805	192.072	3.267
10	237	193.798	194.990	1.192
10	241	194.787	189.809	-4.977
10	242	202.391	204.531	2.140
10	243	205.279	208.303	3.025
10	244	193.661	196.614	2.953
30	141	192.852	195.173	2.321
30	144	193.910	196.368	2.459
30	145	191.580	193.677	2.097
30	146	202.717	205.357	2.640
30	147	200.615	203.593	2.978
30	132	194.827	196.752	1.926
30	133	192.569	194.530	1.961
30	135	194.563	198.482	3.919
30	245	196.915	199.371	2.457
30	246	193.709	195.885	2.176
50	67	196.484	197.661	1.177
50	68	207.372	195.008	-12.365
50	69	195.203	196.809	1.606
50	71	200.427	201.467	1.040
50	72	202.571	203.901	1.330
50	172	191.261	193.156	1.895
50	173	199.490	201.039	1.549
50	174	195.159	196.738	1.579
50	183	196.266	197.753	1.487
50	186	196.391	198.448	2.057
100	95	196.472	197.950	1.478
100	102	207.097	209.555	2.457
100	104	206.573	208.722	2.149
100	105	198.323	199.426	1.104
100	106	202.355	204.102	1.747
100	178	194.787	195.800	1.013
100	179	196.310	198.278	1.968
100	180	197.515	199.029	1.513
100	181	198.835	200.469	1.634
100	182	201.971	203.413	1.441
	Max	207.372	209.555	3.919
	Average	197.771	198.495	0.724
	Min	188.805	189.592	-12.365
	Std Dev	4.772	5.040	3.254

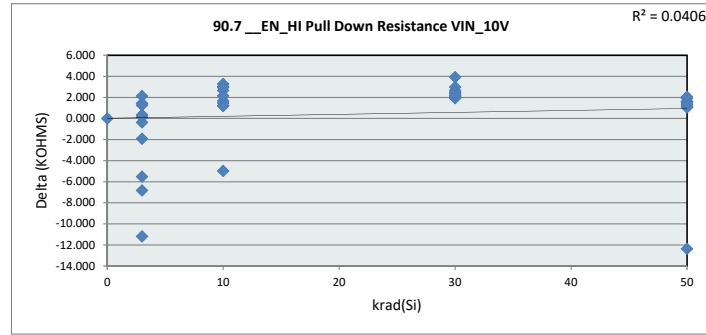

90.7 __EN_HI Pull D						
Test Site	DAL-FL					
Tester	ETS364					
Test Number	EB672302					
Max Limit	400	KOHMS				
Min Limit	100	KOHMS				
krad(Si)	0	3	10	30	50	100
LL	100.000	100.000	100.000	100.000	100.000	100.000
Min	203.336	189.592	189.810	193.677	193.156	195.800
Average	203.336	195.342	198.857	197.919	198.198	201.674
Max	203.336	203.459	208.303	205.357	203.901	209.555
UL	400.000	400.000	400.000	400.000	400.000	400.000

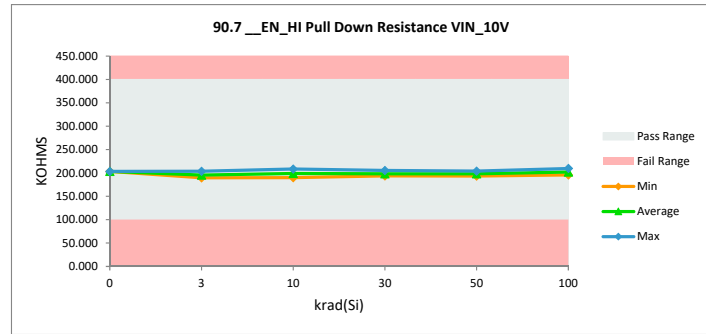

TID HDR Report
TPS7H6003-SP (5962R2220101VXC)

91.0 PWM_LI Rise Thresh VIN		
Test Site	DAL-FL	DAL-FL
Tester	ETS364	ETS364
Test Number	EB672302	EB672302
Unit	V	V
Max Limit	2.65	2.65
Min Limit	1.8	1.8

krad(Si)	Serial #	pre_short (rtp)	(2)ST_Combo (rpt)	Delta
0	Ctrl	2.225	2.225	0.000
3	58	2.235	2.240	0.005
3	59	2.220	2.210	-0.010
3	60	2.315	2.315	0.000
3	61	2.195	2.205	0.010
3	62	2.255	2.255	0.000
3	134	2.235	2.185	-0.050
3	137	2.185	2.190	0.005
3	138	2.190	2.185	-0.005
3	139	2.195	2.190	-0.005
3	236	2.225	2.220	-0.005
10	63	2.205	2.215	0.010
10	64	2.240	2.230	-0.010
10	65	2.220	2.245	0.025
10	66	2.215	2.205	-0.010
10	150	2.220	2.195	-0.025
10	237	2.305	2.225	-0.080
10	241	2.200	2.195	-0.005
10	242	2.195	2.175	-0.020
10	243	2.220	2.215	-0.005
10	244	2.190	2.180	-0.010
30	141	2.200	2.180	-0.020
30	144	2.205	2.165	-0.040
30	145	2.230	2.230	0.000
30	146	2.205	2.170	-0.035
30	147	2.225	2.190	-0.035
30	132	2.275	2.245	-0.030
30	133	2.265	2.235	-0.030
30	135	2.290	2.255	-0.035
30	245	2.245	2.165	-0.080
30	246	2.250	2.210	-0.040
50	67	2.240	2.155	-0.085
50	68	2.220	2.175	-0.045
50	69	2.240	2.165	-0.075
50	71	2.205	2.200	-0.005
50	72	2.240	2.140	-0.100
50	172	2.185	2.210	0.025
50	173	2.190	2.165	-0.025
50	174	2.215	2.165	-0.050
50	183	2.280	2.215	-0.065
50	186	2.195	2.210	0.015
100	95	2.320	2.155	-0.165
100	102	2.215	2.105	-0.110
100	104	2.235	2.130	-0.105
100	105	2.220	2.120	-0.100
100	106	2.235	2.150	-0.085
100	178	2.280	2.195	-0.085
100	179	2.200	2.140	-0.060
100	180	2.210	2.090	-0.120
100	181	2.285	2.220	-0.065
100	182	2.305	2.185	-0.120
	Max	2.320	2.315	0.025
	Average	2.231	2.193	-0.038
	Min	2.185	2.090	-0.165
	Std Dev	0.036	0.041	0.044

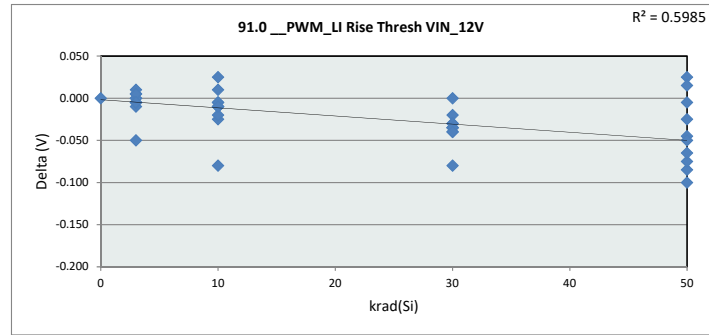

91.0 PWM_LI Rise		
Test Site	DAL-FL	
Tester	ETS364	
Test Number	EB672302	
Max Limit	2.65	V
Min Limit	1.8	V

krad(Si)	0	3	10	30	50	100
LL	1.800	1.800	1.800	1.800	1.800	1.800
Min	2.225	2.185	2.175	2.165	2.140	2.090
Average	2.225	2.220	2.208	2.205	2.180	2.149
Max	2.225	2.315	2.245	2.255	2.215	2.220
UL	2.650	2.650	2.650	2.650	2.650	2.650

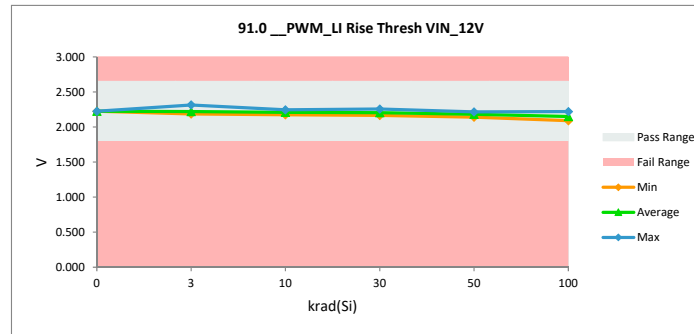

TID HDR Report
TPS7H6003-SP (5962R2220101VXC)

91.1 PWM_LI Fall Thresh VIN		
Test Site	DAL-FL	DAL-FL
Tester	ETS364	ETS364
Test Number	EB672302	EB672302
Unit	V	V
Max Limit	1.85	1.85
Min Limit	1.15	1.15

krad(Si)	Serial #	pre_short (rtp)	(2)'ST_Combo (rpt) (Delta
0	Ctrl	1.430	1.430	0.000
3	58	1.495	1.400	-0.095
3	59	1.405	1.445	0.040
3	60	1.420	1.410	-0.010
3	61	1.495	1.490	-0.005
3	62	1.510	1.460	-0.050
3	134	1.495	1.495	0.000
3	137	1.495	1.495	0.000
3	138	1.495	1.495	0.000
3	139	1.505	1.480	-0.025
3	236	1.505	1.490	-0.015
10	63	1.465	1.420	-0.045
10	64	1.400	1.390	-0.010
10	65	1.440	1.440	0.000
10	66	1.505	1.455	-0.050
10	150	1.410	1.420	0.010
10	237	1.455	1.485	0.030
10	241	1.510	1.495	-0.015
10	242	1.495	1.460	-0.035
10	243	1.500	1.460	-0.040
10	244	1.500	1.495	-0.005
30	141	1.405	1.390	-0.015
30	144	1.505	1.475	-0.030
30	145	1.510	1.410	-0.100
30	146	1.425	1.385	-0.040
30	147	1.475	1.450	-0.025
30	132	1.485	1.370	-0.115
30	133	1.510	1.425	-0.085
30	135	1.430	1.410	-0.020
30	245	1.505	1.485	-0.020
30	246	1.515	1.425	-0.090
50	67	1.500	1.465	-0.035
50	68	1.450	1.470	0.020
50	69	1.445	1.455	0.010
50	71	1.495	1.465	-0.030
50	72	1.505	1.450	-0.055
50	172	1.500	1.445	-0.055
50	173	1.500	1.440	-0.060
50	174	1.505	1.390	-0.115
50	183	1.445	1.385	-0.060
50	186	1.500	1.430	-0.070
100	95	1.370	1.350	-0.020
100	102	1.415	1.350	-0.065
100	104	1.500	1.440	-0.060
100	105	1.505	1.460	-0.045
100	106	1.500	1.320	-0.180
100	178	1.515	1.355	-0.160
100	179	1.510	1.460	-0.050
100	180	1.410	1.345	-0.065
100	181	1.500	1.425	-0.075
100	182	1.515	1.455	-0.060
Max		1.515	1.495	0.040
Average		1.476	1.435	-0.041
Min		1.370	1.320	-0.180
Std Dev		0.040	0.045	0.044

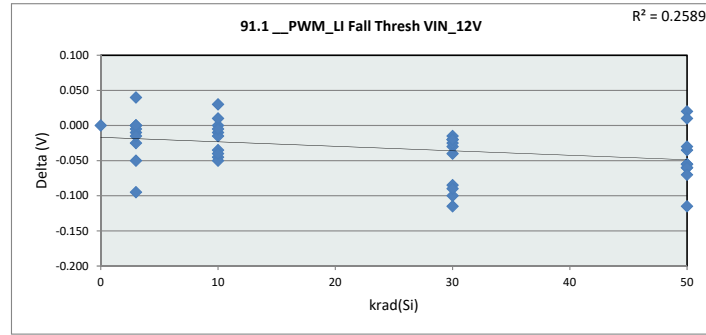

91.1 PWM_LI Fall						
Test Site	DAL-FL					
Tester	ETS364					
Test Number	EB672302					
Max Limit	1.85	V				
Min Limit	1.15	V				
krad(Si)	0	3	10	30	50	100
LL	1.150	1.150	1.150	1.150	1.150	1.150
Min	1.430	1.400	1.390	1.370	1.385	1.320
Average	1.430	1.466	1.452	1.423	1.440	1.396
Max	1.430	1.495	1.495	1.485	1.470	1.460
UL	1.850	1.850	1.850	1.850	1.850	1.850

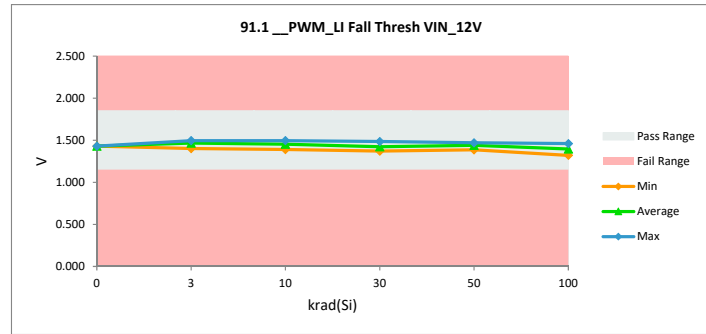

TID HDR Report
TPS7H6003-SP (5962R2220101VXC)

91.3 EN_HI Rise Thresh VIN		
Test Site	DAL-FL	DAL-FL
Tester	ETS364	ETS364
Test Number	EB672302	EB672302
Unit	V	V
Max Limit	2.65	2.65
Min Limit	1.8	1.8

krad(Si)	Serial #	pre_short (rtp)	(2)ST_Combo (rpt)	Delta
0	Ctrl	2.265	2.265	0.000
3	58	2.240	2.225	-0.015
3	59	2.225	2.240	0.015
3	60	2.205	2.210	0.005
3	61	2.195	2.260	0.065
3	62	2.285	2.280	-0.005
3	134	2.260	2.225	-0.035
3	137	2.195	2.190	-0.005
3	138	2.300	2.195	-0.105
3	139	2.245	2.255	0.010
3	236	2.270	2.350	0.080
10	63	2.185	2.180	-0.005
10	64	2.205	2.190	-0.015
10	65	2.275	2.255	-0.020
10	66	2.205	2.190	-0.015
10	150	2.285	2.260	-0.025
10	237	2.300	2.340	0.040
10	241	2.245	2.220	-0.025
10	242	2.190	2.180	-0.010
10	243	2.320	2.305	-0.015
10	244	2.210	2.200	-0.010
30	141	2.205	2.155	-0.050
30	144	2.195	2.230	0.035
30	145	2.210	2.155	-0.055
30	146	2.260	2.220	-0.040
30	147	2.315	2.315	0.000
30	132	2.260	2.260	0.000
30	133	2.205	2.185	-0.020
30	135	2.220	2.245	0.025
30	245	2.225	2.185	-0.040
30	246	2.250	2.240	-0.010
50	67	2.290	2.260	-0.030
50	68	2.245	2.175	-0.070
50	69	2.305	2.305	0.000
50	71	2.305	2.240	-0.065
50	72	2.230	2.140	-0.090
50	172	2.195	2.160	-0.035
50	173	2.300	2.250	-0.050
50	174	2.255	2.255	0.000
50	183	2.230	2.195	-0.035
50	186	2.180	2.135	-0.045
100	95	2.265	2.140	-0.125
100	102	2.235	2.155	-0.080
100	104	2.310	2.200	-0.110
100	105	2.250	2.145	-0.105
100	106	2.190	2.055	-0.135
100	178	2.205	2.155	-0.050
100	179	2.185	2.105	-0.080
100	180	2.250	2.125	-0.125
100	181	2.190	2.110	-0.080
100	182	2.210	2.140	-0.070
Max		2.320	2.350	0.080
Average		2.241	2.209	-0.032
Min		2.180	2.055	-0.135
Std Dev		0.041	0.062	0.047

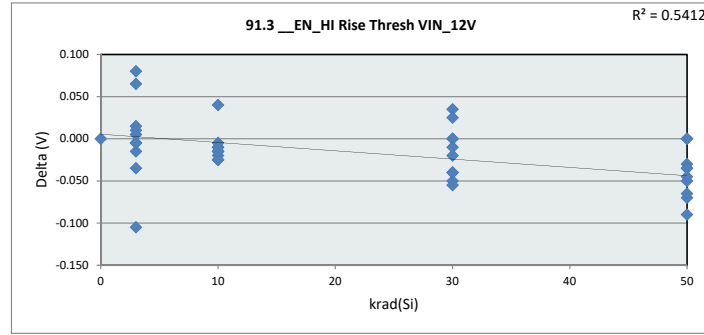

91.3 EN_HI Rise T						
Test Site	DAL-FL					
Tester	ETS364					
Test Number	EB672302					
Max Limit	2.65	V				
Min Limit	1.8	V				
krad(Si)	0	3	10	30	50	100
LL	1.800	1.800	1.800	1.800	1.800	1.800
Min	2.265	2.190	2.180	2.155	2.135	2.055
Average	2.265	2.243	2.232	2.219	2.212	2.133
Max	2.265	2.350	2.340	2.315	2.305	2.200
UL	2.650	2.650	2.650	2.650	2.650	2.650

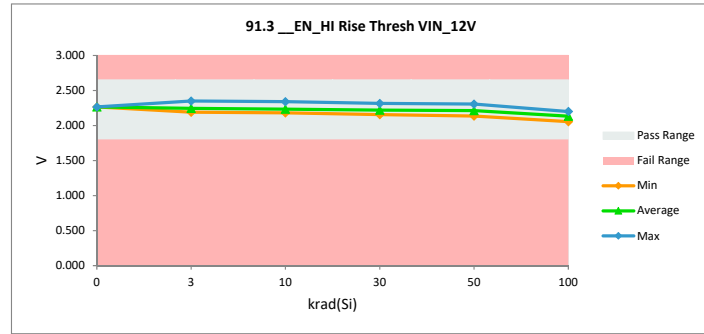

TID HDR Report
TPS7H6003-SP (5962R2220101VXC)

91.4 __EN_HI Fall Thresh VIN_1		
Test Site	DAL-FL	DAL-FL
Tester	ETS364	ETS364
Test Number	EB672302	EB672302
Unit	V	V
Max Limit	1.85	1.85
Min Limit	1.15	1.15

krad(Si)	Serial #	pre_short (rtp)	(2)'ST_Combo (rpt) (Delta
0	Ctrl	1.435	1.435	0.000
3	58	1.490	1.435	-0.055
3	59	1.400	1.410	0.010
3	60	1.500	1.425	-0.075
3	61	1.430	1.440	0.010
3	62	1.505	1.445	-0.060
3	134	1.510	1.500	-0.010
3	137	1.495	1.495	0.000
3	138	1.395	1.500	0.105
3	139	1.505	1.490	-0.015
3	236	1.500	1.500	0.000
10	63	1.495	1.405	-0.090
10	64	1.440	1.425	-0.015
10	65	1.420	1.410	-0.010
10	66	1.510	1.425	-0.085
10	150	1.430	1.395	-0.035
10	237	1.510	1.500	-0.010
10	241	1.515	1.500	-0.015
10	242	1.490	1.485	-0.005
10	243	1.510	1.480	-0.030
10	244	1.385	1.380	-0.005
30	141	1.510	1.480	-0.030
30	144	1.510	1.440	-0.070
30	145	1.505	1.430	-0.075
30	146	1.495	1.425	-0.070
30	147	1.510	1.405	-0.105
30	132	1.420	1.465	0.045
30	133	1.515	1.445	-0.070
30	135	1.515	1.410	-0.105
30	245	1.420	1.365	-0.055
30	246	1.510	1.445	-0.065
50	67	1.510	1.425	-0.085
50	68	1.505	1.455	-0.050
50	69	1.510	1.400	-0.110
50	71	1.430	1.435	0.005
50	72	1.380	1.345	-0.035
50	172	1.515	1.420	-0.095
50	173	1.510	1.465	-0.045
50	174	1.510	1.470	-0.040
50	183	1.505	1.385	-0.120
50	186	1.505	1.465	-0.040
100	95	1.480	1.395	-0.085
100	102	1.375	1.305	-0.070
100	104	1.435	1.375	-0.060
100	105	1.415	1.400	-0.015
100	106	1.390	1.380	-0.010
100	178	1.515	1.440	-0.075
100	179	1.500	1.435	-0.065
100	180	1.505	1.340	-0.165
100	181	1.510	1.400	-0.110
100	182	1.515	1.370	-0.145
	Max	1.515	1.500	0.105
	Average	1.476	1.429	-0.047
	Min	1.375	1.305	-0.165
	Std Dev	0.046	0.046	0.049

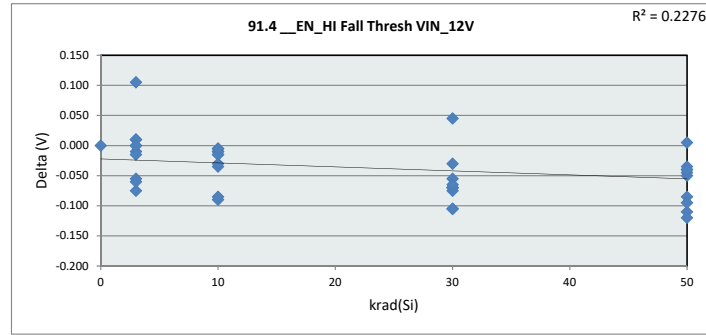

91.4 __EN_HI Fall T						
Test Site	DAL-FL					
Tester	ETS364					
Test Number	EB672302					
Max Limit	1.85	V				
Min Limit	1.15	V				
krad(Si)	0	3	10	30	50	100
LL	1.150	1.150	1.150	1.150	1.150	1.150
Min	1.435	1.410	1.380	1.365	1.345	1.305
Average	1.435	1.464	1.441	1.431	1.427	1.384
Max	1.435	1.500	1.500	1.480	1.470	1.440
UL	1.850	1.850	1.850	1.850	1.850	1.850

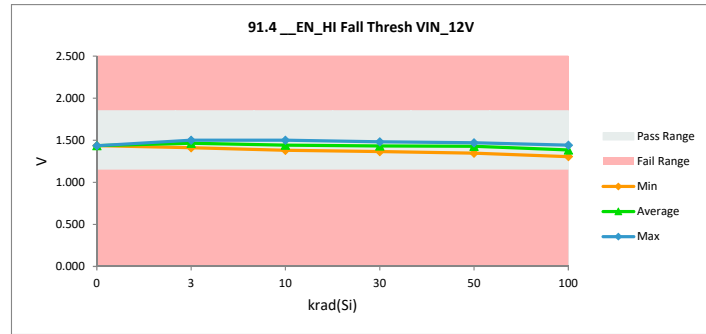

TID HDR Report
TPS7H6003-SP (5962R2220101VXC)

91.6 PWM_LI Pull Down Resist		
Test Site	DAL-FL	DAL-FL
Tester	ETS364	ETS364
Test Number	EB672302	EB672302
Unit	kOhms	KOHMS
Max Limit	400	400
Min Limit	100	100

krad(Si)	Serial #	pre_short (rtp)	(2)ST_Combo (rpt)	Delta
0	Ctrl	203.605	203.605	0.000
3	58	200.829	200.552	-0.277
3	59	195.149	196.432	1.284
3	60	204.147	204.292	0.145
3	61	197.227	197.570	0.342
3	62	200.713	202.110	1.397
3	134	196.108	191.050	-5.058
3	137	195.066	190.976	-4.090
3	138	192.287	191.576	-0.711
3	139	190.243	192.345	2.102
3	236	207.196	195.124	-12.072
10	63	194.535	195.747	1.212
10	64	199.627	202.330	2.703
10	65	197.255	198.710	1.455
10	66	207.129	208.832	1.702
10	150	189.870	193.173	3.303
10	237	194.307	195.473	1.166
10	241	195.276	191.215	-4.060
10	242	203.203	205.346	2.143
10	243	205.907	208.925	3.018
10	244	193.563	196.483	2.920
30	141	193.605	195.923	2.318
30	144	193.896	196.339	2.443
30	145	192.760	194.960	2.200
30	146	202.282	204.842	2.560
30	147	201.712	204.708	2.995
30	132	195.980	197.943	1.962
30	133	193.315	195.266	1.951
30	135	195.165	200.511	5.346
30	245	196.846	199.261	2.415
30	246	194.738	196.957	2.220
50	67	196.194	197.392	1.198
50	68	208.796	195.433	-13.363
50	69	196.279	197.875	1.597
50	71	200.452	201.447	0.995
50	72	202.987	204.350	1.363
50	172	192.041	194.112	2.071
50	173	199.841	201.590	1.749
50	174	196.485	198.222	1.737
50	183	197.040	198.700	1.661
50	186	196.844	199.106	2.262
100	95	197.744	199.218	1.474
100	102	207.599	210.051	2.451
100	104	206.331	208.486	2.155
100	105	199.704	200.866	1.162
100	106	202.362	204.096	1.734
100	178	195.708	197.025	1.317
100	179	197.536	199.716	2.180
100	180	198.719	200.423	1.704
100	181	199.092	200.957	1.864
100	182	203.151	204.861	1.710
	Max	208.796	210.051	5.346
	Average	198.401	199.265	0.864
	Min	189.870	190.976	-13.363
	Std Dev	4.745	4.835	3.283

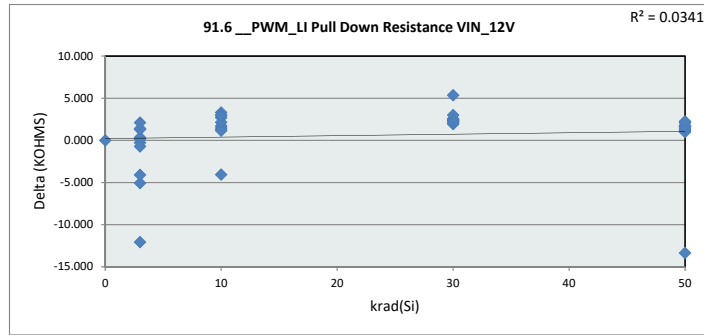

91.6 PWM_LI Pull		
Test Site	DAL-FL	
Tester	ETS364	
Test Number	EB672302	
Max Limit	400	KOHMS
Min Limit	100	KOHMS

krad(Si)	0	3	10	30	50	100
LL	100.000	100.000	100.000	100.000	100.000	100.000
Min	203.606	190.976	191.215	194.960	194.112	197.025
Average	203.606	196.203	199.624	198.671	198.823	202.570
Max	203.606	204.292	208.925	204.842	204.350	210.051
UL	400.000	400.000	400.000	400.000	400.000	400.000

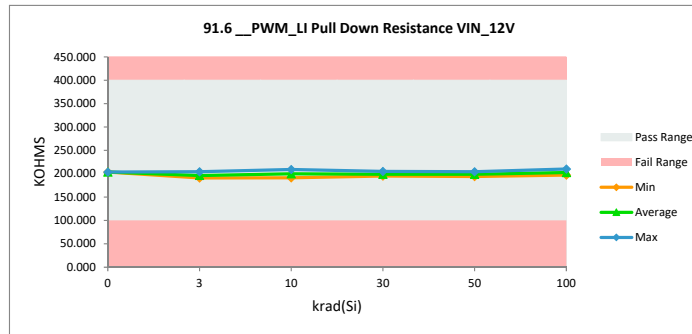

TID HDR Report
TPS7H6003-SP (5962R2220101VXC)

91.7 __EN_HI Pull Down Resista		
Test Site	DAL-FL	DAL-FL
Tester	ETS364	ETS364
Test Number	EB672302	EB672302
Unit	kOhms	KOHMS
Max Limit	400	400
Min Limit	100	100

krad(Si)	Serial #	pre_short (rtp)	(2)'ST_Combo (rpt)	Delta
0	Ctrl	203.364	203.364	0.000
3	58	199.574	199.295	-0.279
3	59	193.872	195.105	1.233
3	60	203.323	203.471	0.148
3	61	196.556	196.872	0.316
3	62	201.584	203.004	1.420
3	134	196.464	189.652	-6.812
3	137	195.087	189.578	-5.509
3	138	192.089	190.173	-1.916
3	139	189.402	191.545	2.143
3	236	205.805	194.622	-11.183
10	63	194.170	195.361	1.191
10	64	197.852	200.518	2.667
10	65	196.724	198.176	1.452
10	66	206.437	208.138	1.700
10	150	188.788	192.060	3.272
10	237	193.782	194.958	1.176
10	241	194.774	189.786	-4.988
10	242	202.374	204.537	2.163
10	243	205.260	208.291	3.031
10	244	193.684	196.628	2.944
30	141	192.839	195.180	2.340
30	144	193.906	196.337	2.432
30	145	191.575	193.738	2.163
30	146	202.688	205.296	2.608
30	147	200.597	203.584	2.987
30	132	194.803	196.787	1.984
30	133	192.528	194.497	1.969
30	135	194.548	198.410	3.862
30	245	196.902	199.316	2.414
30	246	193.692	195.869	2.178
50	67	196.476	197.669	1.193
50	68	207.376	195.014	-12.362
50	69	195.204	196.781	1.577
50	71	200.430	201.428	0.998
50	72	202.558	203.883	1.325
50	172	191.251	193.179	1.928
50	173	199.460	201.031	1.571
50	174	195.142	196.722	1.580
50	183	196.238	197.730	1.492
50	186	196.355	198.451	2.096
100	95	196.459	197.910	1.451
100	102	207.080	209.523	2.443
100	104	206.543	208.714	2.171
100	105	198.330	199.482	1.152
100	106	202.318	204.065	1.747
100	178	194.736	195.804	1.068
100	179	196.287	198.243	1.956
100	180	197.512	198.939	1.427
100	181	198.839	200.464	1.625
100	182	201.955	203.426	1.472
	Max	207.376	209.523	3.862
	Average	197.757	198.483	0.726
	Min	188.788	189.578	-12.362
	Std Dev	4.772	5.038	3.252

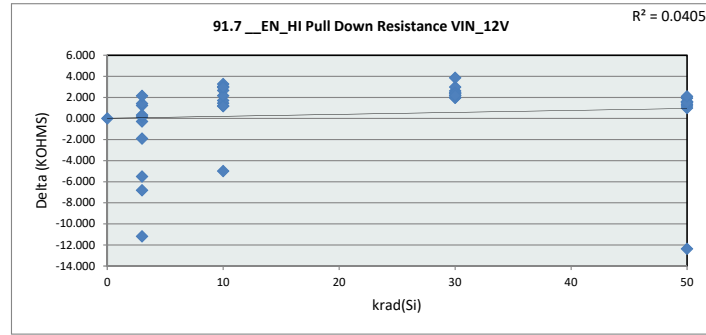

91.7 __EN_HI Pull D						
Test Site	DAL-FL					
Tester	ETS364					
Test Number	EB672302					
Max Limit	400	KOHMS				
Min Limit	100	KOHMS				
krad(Si)	0	3	10	30	50	100
LL	100.000	100.000	100.000	100.000	100.000	100.000
Min	203.364	189.578	189.786	193.738	193.179	195.804
Average	203.364	195.332	198.845	197.901	198.189	201.657
Max	203.364	203.471	208.291	205.296	203.883	209.523
UL	400.000	400.000	400.000	400.000	400.000	400.000

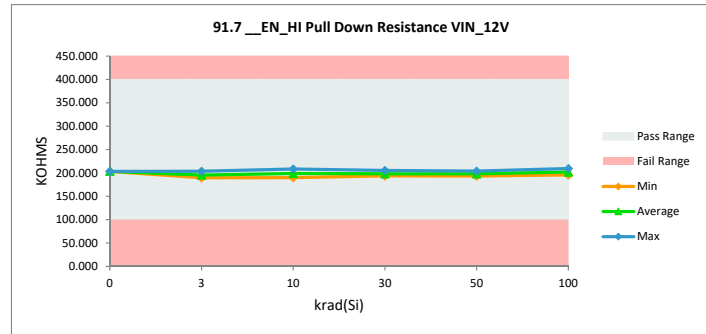

TID HDR Report
TPS7H6003-SP (5962R2220101VXC)

92.0_PWM_LI Rise Thresh VIN		
Test Site	DAL-FL	DAL-FL
Tester	ETS364	ETS364
Test Number	EB672302	EB672302
Unit	V	V
Max Limit	2.65	2.65
Min Limit	1.8	1.8

krad(Si)	Serial #	pre_short (rtp)	(2)ST_Combo (rpt)	Delta
0	Ctrl	2.200	2.200	0.000
3	58	2.240	2.230	-0.010
3	59	2.185	2.215	0.030
3	60	2.310	2.310	0.000
3	61	2.225	2.190	-0.035
3	62	2.255	2.270	0.015
3	134	2.240	2.185	-0.055
3	137	2.200	2.190	-0.010
3	138	2.190	2.185	-0.005
3	139	2.200	2.190	-0.010
3	236	2.220	2.240	0.020
10	63	2.180	2.215	0.035
10	64	2.225	2.230	0.005
10	65	2.265	2.245	-0.020
10	66	2.215	2.200	-0.015
10	150	2.195	2.190	-0.005
10	237	2.320	2.235	-0.085
10	241	2.200	2.190	-0.010
10	242	2.185	2.175	-0.010
10	243	2.220	2.220	0.000
10	244	2.190	2.180	-0.010
30	141	2.225	2.195	-0.030
30	144	2.205	2.165	-0.040
30	145	2.245	2.245	0.000
30	146	2.200	2.160	-0.040
30	147	2.225	2.205	-0.020
30	132	2.225	2.255	0.030
30	133	2.255	2.235	-0.020
30	135	2.295	2.250	-0.045
30	245	2.250	2.165	-0.085
30	246	2.260	2.215	-0.045
50	67	2.245	2.135	-0.110
50	68	2.225	2.175	-0.050
50	69	2.250	2.165	-0.085
50	71	2.205	2.190	-0.015
50	72	2.235	2.145	-0.090
50	172	2.230	2.195	-0.035
50	173	2.190	2.200	0.010
50	174	2.195	2.140	-0.055
50	183	2.290	2.215	-0.075
50	186	2.190	2.200	0.010
100	95	2.315	2.135	-0.180
100	102	2.215	2.110	-0.105
100	104	2.260	2.135	-0.125
100	105	2.210	2.120	-0.090
100	106	2.250	2.135	-0.115
100	178	2.235	2.180	-0.055
100	179	2.230	2.130	-0.100
100	180	2.235	2.105	-0.130
100	181	2.200	2.210	0.010
100	182	2.300	2.180	-0.120
	Max	2.320	2.310	0.035
	Average	2.230	2.192	-0.039
	Min	2.180	2.105	-0.180
	Std Dev	0.036	0.043	0.049

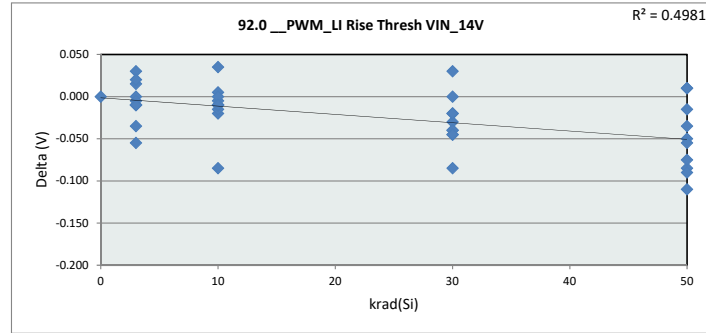

92.0_PWM_LI Rise		
Test Site	DAL-FL	
Tester	ETS364	
Test Number	EB672302	
Max Limit	2.65	V
Min Limit	1.8	V

krad(Si)	0	3	10	30	50	100
LL	1.800	1.800	1.800	1.800	1.800	1.800
Min	2.200	2.185	2.175	2.160	2.135	2.105
Average	2.200	2.221	2.208	2.209	2.176	2.144
Max	2.200	2.310	2.245	2.255	2.215	2.210
UL	2.650	2.650	2.650	2.650	2.650	2.650

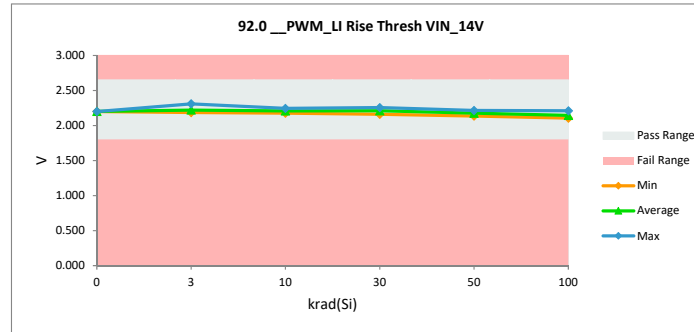

TID HDR Report
TPS7H6003-SP (5962R2220101VXC)

92.1 __PWM_LI Fall Thresh VIN		
Test Site	DAL-FL	DAL-FL
Tester	ETS364	ETS364
Test Number	EB672302	EB672302
Unit	V	V
Max Limit	1.85	1.85
Min Limit	1.15	1.15

krad(Si)	Serial #	pre_short (rtp)	(2)'ST_Combo (rpt)	Delta
0	Ctrl	1.470	1.470	0.000
3	58	1.395	1.385	-0.010
3	59	1.465	1.400	-0.065
3	60	1.420	1.410	-0.010
3	61	1.495	1.490	-0.005
3	62	1.505	1.500	-0.005
3	134	1.495	1.495	0.000
3	137	1.475	1.495	0.020
3	138	1.495	1.495	0.000
3	139	1.505	1.500	-0.005
3	236	1.495	1.485	-0.010
10	63	1.415	1.420	0.005
10	64	1.390	1.385	-0.005
10	65	1.480	1.440	-0.040
10	66	1.505	1.470	-0.035
10	150	1.490	1.410	-0.080
10	237	1.505	1.485	-0.020
10	241	1.440	1.495	0.055
10	242	1.495	1.490	-0.005
10	243	1.500	1.455	-0.045
10	244	1.500	1.495	-0.005
30	141	1.455	1.385	-0.070
30	144	1.505	1.475	-0.030
30	145	1.510	1.400	-0.110
30	146	1.505	1.395	-0.110
30	147	1.510	1.450	-0.060
30	132	1.490	1.375	-0.115
30	133	1.505	1.425	-0.080
30	135	1.510	1.390	-0.120
30	245	1.505	1.485	-0.020
30	246	1.510	1.490	-0.020
50	67	1.430	1.445	0.015
50	68	1.450	1.470	0.020
50	69	1.420	1.475	0.055
50	71	1.495	1.465	-0.030
50	72	1.510	1.465	-0.045
50	172	1.500	1.485	-0.015
50	173	1.510	1.415	-0.095
50	174	1.385	1.390	0.005
50	183	1.425	1.395	-0.030
50	186	1.500	1.420	-0.080
100	95	1.370	1.335	-0.035
100	102	1.410	1.350	-0.060
100	104	1.500	1.435	-0.065
100	105	1.505	1.460	-0.045
100	106	1.500	1.315	-0.185
100	178	1.515	1.360	-0.155
100	179	1.510	1.460	-0.050
100	180	1.510	1.340	-0.170
100	181	1.500	1.455	-0.045
100	182	1.510	1.440	-0.070
Max		1.515	1.500	0.055
Average		1.478	1.438	-0.041
Min		1.370	1.315	-0.185
Std Dev		0.040	0.050	0.052

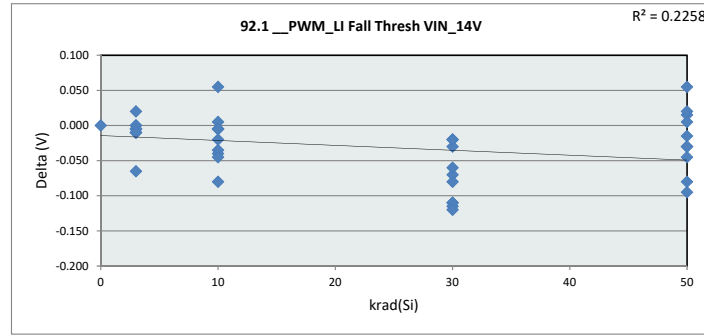

92.1 __PWM_LI Fall		
Test Site	DAL-FL	
Tester	ETS364	
Test Number	EB672302	
Max Limit	1.85	V
Min Limit	1.15	V

krad(Si)	0	3	10	30	50	100
LL	1.150	1.150	1.150	1.150	1.150	1.150
Min	1.470	1.385	1.385	1.375	1.390	1.315
Average	1.470	1.466	1.455	1.427	1.443	1.395
Max	1.470	1.500	1.495	1.490	1.485	1.460
UL	1.850	1.850	1.850	1.850	1.850	1.850

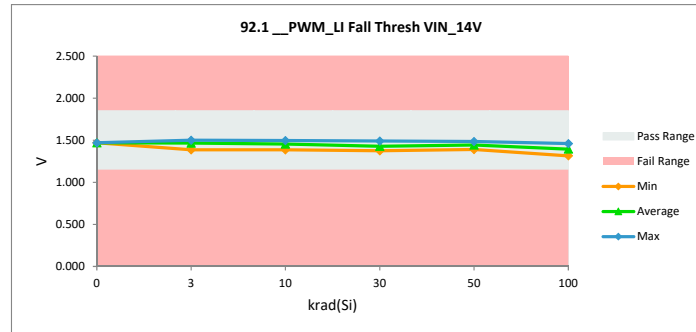

TID HDR Report
TPS7H6003-SP (5962R2220101VXC)

92.4 __EN_HI Fall Thresh VIN_1		
Test Site	DAL-FL	DAL-FL
Tester	ETS364	ETS364
Test Number	EB672302	EB672302
Unit	V	V
Max Limit	1.85	1.85
Min Limit	1.15	1.15

krad(Si)	Serial #	pre_short (rtp)	(2)'ST_Combo (rpt)	Delta
0	Ctrl	1.425	1.425	0.000
3	58	1.495	1.495	0.000
3	59	1.455	1.405	-0.050
3	60	1.505	1.420	-0.085
3	61	1.475	1.425	-0.050
3	62	1.500	1.440	-0.060
3	134	1.510	1.495	-0.015
3	137	1.495	1.500	0.005
3	138	1.505	1.500	-0.005
3	139	1.510	1.475	-0.035
3	236	1.495	1.500	0.005
10	63	1.495	1.420	-0.075
10	64	1.435	1.435	0.000
10	65	1.435	1.430	-0.005
10	66	1.510	1.440	-0.070
10	150	1.410	1.400	-0.010
10	237	1.420	1.500	0.080
10	241	1.515	1.495	-0.020
10	242	1.495	1.485	-0.010
10	243	1.510	1.440	-0.070
10	244	1.440	1.400	-0.040
30	141	1.505	1.480	-0.025
30	144	1.505	1.460	-0.045
30	145	1.485	1.430	-0.055
30	146	1.495	1.415	-0.080
30	147	1.510	1.410	-0.100
30	132	1.505	1.470	-0.035
30	133	1.515	1.465	-0.050
30	135	1.515	1.405	-0.110
30	245	1.420	1.390	-0.030
30	246	1.515	1.430	-0.085
50	67	1.510	1.420	-0.090
50	68	1.505	1.475	-0.030
50	69	1.510	1.415	-0.095
50	71	1.430	1.430	0.000
50	72	1.375	1.335	-0.040
50	172	1.515	1.420	-0.095
50	173	1.520	1.480	-0.040
50	174	1.510	1.470	-0.040
50	183	1.510	1.400	-0.110
50	186	1.505	1.465	-0.040
100	95	1.505	1.380	-0.125
100	102	1.385	1.310	-0.075
100	104	1.500	1.375	-0.125
100	105	1.425	1.470	0.045
100	106	1.435	1.420	-0.015
100	178	1.515	1.460	-0.055
100	179	1.500	1.435	-0.065
100	180	1.510	1.325	-0.185
100	181	1.500	1.445	-0.055
100	182	1.515	1.365	-0.150
	Max	1.520	1.500	0.080
	Average	1.484	1.435	-0.049
	Min	1.375	1.310	-0.185
	Std Dev	0.039	0.046	0.048

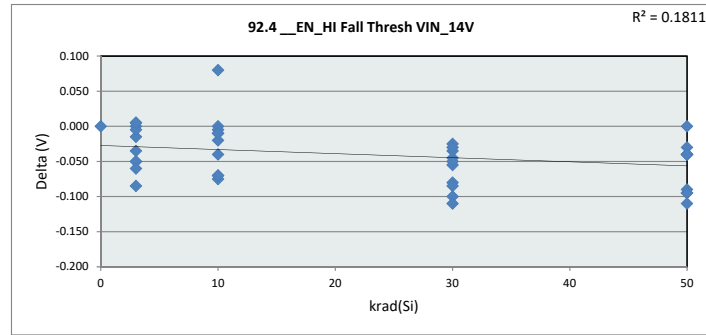

92.4 __EN_HI Fall T						
Test Site	DAL-FL					
Tester	ETS364					
Test Number	EB672302					
Max Limit	1.85	V				
Min Limit	1.15	V				
krad(Si)	0	3	10	30	50	100
LL	1.150	1.150	1.150	1.150	1.150	1.150
Min	1.425	1.405	1.400	1.390	1.335	1.310
Average	1.425	1.466	1.445	1.436	1.431	1.399
Max	1.425	1.500	1.500	1.480	1.480	1.470
UL	1.850	1.850	1.850	1.850	1.850	1.850

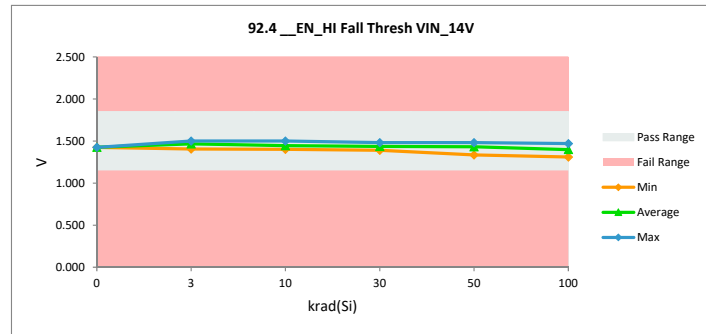

TID HDR Report
TPS7H6003-SP (5962R2220101VXC)

92.6 PWM_LI Pull Down Resist		
Test Site	DAL-FL	DAL-FL
Tester	ETS364	ETS364
Test Number	EB672302	EB672302
Unit	kOhms	KOHMS
Max Limit	400	400
Min Limit	100	100

krad(Si)	Serial #	pre_short (rtp)	(2)'ST_Combo (rpt)	Delta
0	Ctrl	203.577	203.577	0.000
3	58	200.789	200.480	-0.310
3	59	195.132	196.372	1.240
3	60	204.113	204.235	0.122
3	61	197.195	197.522	0.327
3	62	200.674	202.131	1.457
3	134	196.091	191.056	-5.036
3	137	195.053	190.991	-4.062
3	138	192.243	191.502	-0.740
3	139	190.198	192.271	2.073
3	236	207.156	195.100	-12.056
10	63	194.527	195.716	1.189
10	64	199.606	202.316	2.710
10	65	197.232	198.671	1.439
10	66	207.101	208.765	1.664
10	150	189.812	193.141	3.329
10	237	194.276	195.440	1.164
10	241	195.246	191.193	-4.053
10	242	203.177	205.326	2.149
10	243	205.857	208.829	2.972
10	244	193.535	196.441	2.907
30	141	193.595	195.899	2.304
30	144	193.876	196.320	2.445
30	145	192.749	194.933	2.184
30	146	202.236	204.819	2.583
30	147	201.671	204.641	2.970
30	132	195.930	197.963	2.033
30	133	193.275	195.254	1.979
30	135	195.121	200.479	5.357
30	245	196.784	199.251	2.466
30	246	194.711	196.923	2.212
50	67	196.171	197.359	1.188
50	68	208.763	195.429	-13.334
50	69	196.249	197.862	1.613
50	71	200.441	201.486	1.045
50	72	202.959	204.317	1.358
50	172	192.012	194.128	2.115
50	173	199.808	201.541	1.733
50	174	196.441	198.213	1.773
50	183	197.006	198.712	1.706
50	186	196.825	199.110	2.285
100	95	197.701	199.154	1.453
100	102	207.550	210.057	2.507
100	104	206.291	208.444	2.153
100	105	199.669	200.858	1.188
100	106	202.318	204.016	1.699
100	178	195.678	197.004	1.326
100	179	197.505	199.676	2.171
100	180	198.704	200.371	1.667
100	181	199.070	200.900	1.830
100	182	203.104	204.846	1.743
	Max	208.763	210.057	5.357
	Average	198.369	199.236	0.867
	Min	189.812	190.991	-13.334
	Std Dev	4.743	4.829	3.279

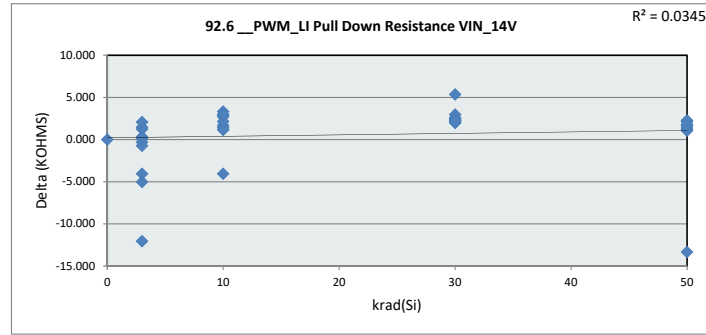

92.6 PWM_LI Pull		
Test Site	DAL-FL	
Tester	ETS364	
Test Number	EB672302	
Max Limit	400	KOHMS
Min Limit	100	KOHMS

krad(Si)	0	3	10	30	50	100
LL	100.000	100.000	100.000	100.000	100.000	100.000
Min	203.577	190.991	191.193	194.933	194.128	197.004
Average	203.577	196.166	199.584	198.648	198.816	202.533
Max	203.577	204.235	208.829	204.819	204.317	210.057
UL	400.000	400.000	400.000	400.000	400.000	400.000

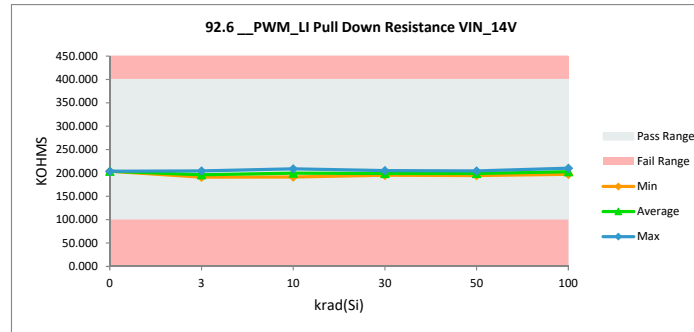

TID HDR Report
TPS7H6003-SP (5962R2220101VXC)

92.7 __EN_HI Pull Down Resista		
Test Site	DAL-FL	DAL-FL
Tester	ETS364	ETS364
Test Number	EB672302	EB672302
Unit	kOhms	KOHMS
Max Limit	400	400
Min Limit	100	100

krad(Si)	Serial #	pre_short (rtp)	(2)'ST_Combo (rpt)	Delta
0	Ctrl	203.324	203.324	0.000
3	58	199.551	199.220	-0.331
3	59	193.851	195.066	1.215
3	60	203.301	203.402	0.101
3	61	196.520	196.831	0.311
3	62	201.555	203.005	1.450
3	134	196.443	189.637	-6.806
3	137	195.072	189.588	-5.484
3	138	192.042	190.115	-1.926
3	139	189.374	191.482	2.108
3	236	205.784	194.624	-11.160
10	63	194.151	195.332	1.181
10	64	197.835	200.460	2.626
10	65	196.695	198.162	1.467
10	66	206.432	208.107	1.675
10	150	188.773	192.044	3.272
10	237	193.753	194.918	1.165
10	241	194.749	189.778	-4.971
10	242	202.339	204.511	2.172
10	243	205.240	208.216	2.976
10	244	193.642	196.565	2.923
30	141	192.825	195.114	2.289
30	144	193.850	196.304	2.453
30	145	191.553	193.729	2.176
30	146	202.670	205.256	2.586
30	147	200.557	203.504	2.947
30	132	194.783	196.772	1.989
30	133	192.493	194.464	1.971
30	135	194.531	198.389	3.858
30	245	196.846	199.267	2.422
30	246	193.654	195.850	2.197
50	67	196.450	197.635	1.185
50	68	207.344	195.007	-12.338
50	69	195.159	196.726	1.567
50	71	200.406	201.426	1.021
50	72	202.537	203.888	1.351
50	172	191.236	193.135	1.899
50	173	199.414	200.991	1.578
50	174	195.124	196.698	1.574
50	183	196.215	197.766	1.551
50	186	196.334	198.423	2.089
100	95	196.421	197.882	1.461
100	102	207.029	209.531	2.503
100	104	206.491	208.671	2.180
100	105	198.285	199.437	1.152
100	106	202.273	203.996	1.722
100	178	194.704	195.805	1.101
100	179	196.272	198.208	1.936
100	180	197.469	198.911	1.441
100	181	198.797	200.417	1.620
100	182	201.918	203.436	1.517
	Max	207.344	209.531	3.858
	Average	197.727	198.451	0.725
	Min	188.773	189.588	-12.338
	Std Dev	4.770	5.035	3.246

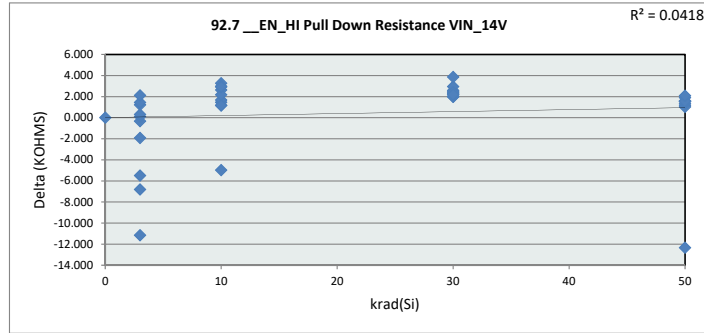

92.7 __EN_HI Pull D						
Test Site	DAL-FL					
Tester	ETS364					
Test Number	EB672302					
Max Limit	400	KOHMS				
Min Limit	100	KOHMS				
krad(Si)	0	3	10	30	50	100
LL	100.000	100.000	100.000	100.000	100.000	100.000
Min	203.324	189.588	189.778	193.729	193.135	195.805
Average	203.324	195.297	198.809	197.865	198.170	201.629
Max	203.324	203.402	208.216	205.256	203.888	209.531
UL	400.000	400.000	400.000	400.000	400.000	400.000

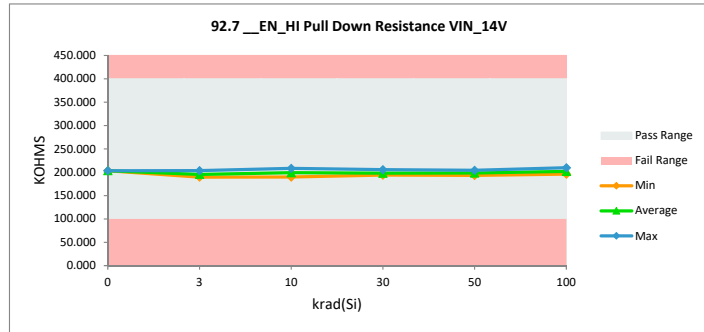

TID HDR Report
TPS7H6003-SP (5962R2220101VXC)

95.0 DLH Dead Time Min 500k		
Test Site	DAL-FL	DAL-FL
Tester	ETS364	ETS364
Test Number	EB672302	EB672302
Unit	nsec	
Max Limit	10	10
Min Limit	0	0

krad(Si)	Serial #	pre_short (rtp)	(2)'ST_Combo (rpt)	Delta
0	Ctrl	3.661	3.661	0.000
3	58	3.585	4.256	0.672
3	59	3.072	3.905	0.833
3	60	2.835	3.674	0.839
3	61	3.686	4.295	0.609
3	62	3.308	4.057	0.750
3	134	3.107	4.692	1.585
3	137	3.736	4.556	0.819
3	138	3.812	4.636	0.824
3	139	3.916	4.215	0.299
3	236	2.771	4.428	1.657
10	63	3.502	4.303	0.801
10	64	3.310	4.089	0.779
10	65	3.371	4.013	0.643
10	66	3.633	4.178	0.545
10	150	3.195	3.616	0.421
10	237	3.720	4.439	0.719
10	241	3.458	4.643	1.185
10	242	3.039	3.467	0.428
10	243	3.763	4.336	0.573
10	244	4.121	4.461	0.340
30	141	3.120	3.893	0.773
30	144	3.765	4.512	0.747
30	145	4.215	4.789	0.574
30	146	3.610	4.143	0.533
30	147	3.332	3.752	0.420
30	132	3.856	4.620	0.763
30	133	3.625	4.311	0.686
30	135	3.706	4.952	1.246
30	245	3.631	4.294	0.663
30	246	2.962	3.464	0.502
50	67	3.574	4.282	0.708
50	68	2.965	4.651	1.686
50	69	3.361	4.315	0.954
50	71	3.651	4.476	0.825
50	72	3.064	4.218	1.154
50	172	4.499	5.051	0.552
50	173	3.757	4.253	0.496
50	174	2.956	4.150	1.194
50	183	3.035	3.400	0.365
50	186	4.220	4.851	0.632
100	95	3.594	4.917	1.323
100	102	3.177	4.207	1.029
100	104	3.270	4.580	1.310
100	105	3.262	4.261	0.999
100	106	3.571	4.702	1.131
100	178	3.582	4.313	0.731
100	179	3.591	4.284	0.694
100	180	3.415	4.601	1.186
100	181	3.564	4.217	0.653
100	182	3.389	4.087	0.698
Max		4.499	5.051	1.686
Average		3.489	4.284	0.795
Min		2.771	3.400	0.000
Std Dev		0.368	0.386	0.349

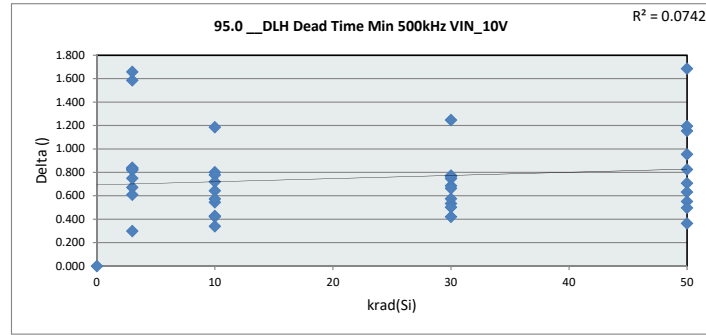

95.0 DLH Dead Time

Test Site	DAL-FL
Tester	ETS364
Test Number	EB672302
Max Limit	10
Min Limit	0

krad(Si)	0	3	10	30	50	100
LL	0.000	0.000	0.000	0.000	0.000	0.000
Min	3.661	3.674	3.467	3.464	3.400	4.087
Average	3.661	4.271	4.154	4.273	4.365	4.417
Max	3.661	4.692	4.643	4.953	5.051	4.917
UL	10.000	10.000	10.000	10.000	10.000	10.000

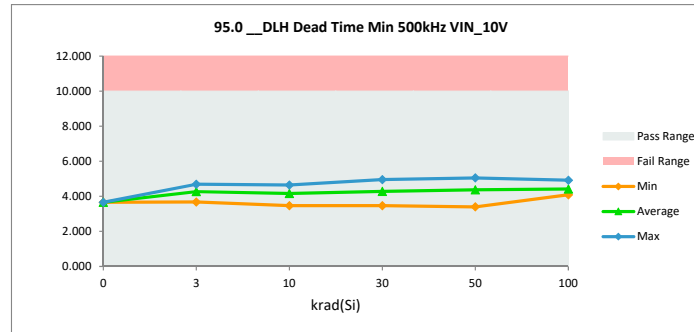

TID HDR Report
TPS7H6003-SP (5962R2220101VXC)

95.1 DLH Dead Time Small 500		
Test Site	DAL-FL	DAL-FL
Tester	ETS364	ETS364
Test Number	EB672302	EB672302
Unit	nsec	
Max Limit	15.5	15.5
Min Limit	8	8

krad(Si)	Serial #	pre_short (rtp)	(2)ST_Combos (rpt)	Delta
0	Ctrl	11.174	11.174	0.000
3	58	10.952	11.682	0.731
3	59	10.089	11.005	0.916
3	60	10.202	10.921	0.719
3	61	10.546	11.247	0.701
3	62	10.187	10.979	0.792
3	134	10.616	11.355	0.739
3	137	10.509	11.253	0.744
3	138	10.490	11.287	0.797
3	139	11.177	11.489	0.312
3	236	10.446	11.735	1.289
10	63	10.924	11.579	0.655
10	64	10.787	11.357	0.570
10	65	10.986	11.314	0.327
10	66	10.584	11.207	0.623
10	150	10.549	10.874	0.326
10	237	10.512	11.608	1.096
10	241	10.817	11.391	0.574
10	242	10.473	11.021	0.548
10	243	11.107	11.651	0.544
10	244	11.441	11.796	0.355
30	141	10.449	10.772	0.323
30	144	11.108	11.436	0.328
30	145	11.058	11.273	0.215
30	146	10.972	11.210	0.238
30	147	10.650	10.733	0.083
30	132	11.170	11.497	0.327
30	133	10.999	11.127	0.128
30	135	10.546	11.579	1.033
30	245	11.027	11.265	0.238
30	246	10.364	10.580	0.217
50	67	10.486	10.516	0.029
50	68	10.341	11.573	1.231
50	69	10.775	11.122	0.347
50	71	10.459	10.562	0.103
50	72	10.261	10.855	0.594
50	172	11.431	11.596	0.165
50	173	11.214	11.069	-0.145
50	174	10.315	10.991	0.677
50	183	10.287	10.111	-0.175
50	186	10.953	11.058	0.105
100	95	11.126	11.362	0.236
100	102	10.603	10.348	-0.255
100	104	10.771	11.018	0.247
100	105	10.685	10.517	-0.168
100	106	11.065	10.878	-0.187
100	178	10.834	10.601	-0.234
100	179	10.960	10.580	-0.380
100	180	10.897	10.847	-0.050
100	181	10.835	10.488	-0.347
100	182	10.590	10.377	-0.213
	Max	11.441	11.796	1.289
	Average	10.741	11.095	0.354
	Min	10.089	10.111	-0.380
	Std Dev	0.334	0.409	0.412

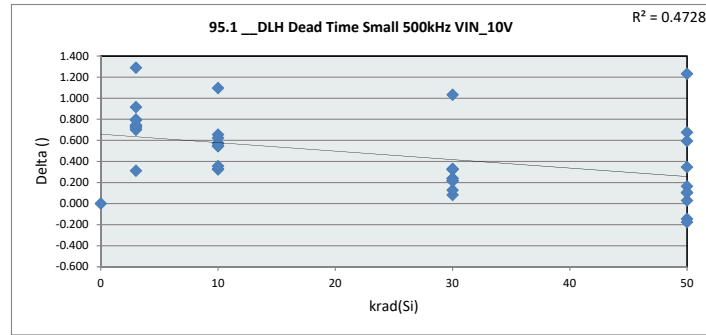

95.1 DLH Dead Time						
Test Site	DAL-FL					
Tester	ETS364					
Test Number	EB672302					
Max Limit	15.5					
Min Limit	8					
krad(Si)	0	3	10	30	50	100
LL	8.000	8.000	8.000	8.000	8.000	8.000
Min	11.174	10.921	10.874	10.581	10.111	10.348
Average	11.174	11.295	11.380	11.147	10.945	10.702
Max	11.174	11.735	11.796	11.579	11.596	11.362
UL	15.500	15.500	15.500	15.500	15.500	15.500

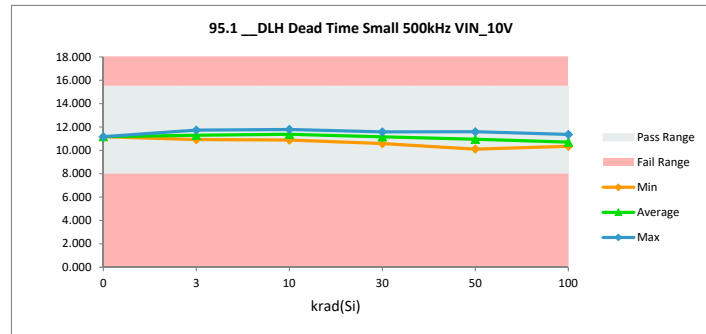

TID HDR Report
TPS7H6003-SP (5962R2220101VXC)

95.2 DLH Dead Time Mid 500k		
Test Site	DAL-FL	DAL-FL
Tester	ETS364	ETS364
Test Number	EB672302	EB672302
Unit	nsec	
Max Limit	24	
Min Limit	15.5	

krad(Si)	Serial #	pre_short (rtp) (2)	ST_Combo (rpt) (Delta
0	Ctrl	20.020	20.020	0.000
3	58	19.558	20.243	0.685
3	59	18.367	19.054	0.688
3	60	18.787	19.404	0.617
3	61	18.716	19.424	0.708
3	62	18.385	19.187	0.802
3	134	19.474	19.449	-0.025
3	137	18.734	19.230	0.496
3	138	18.604	19.282	0.678
3	139	19.708	19.957	0.249
3	236	19.563	20.112	0.550
10	63	19.633	20.059	0.426
10	64	19.629	20.067	0.437
10	65	19.738	20.086	0.347
10	66	18.848	19.293	0.445
10	150	19.253	19.585	0.332
10	237	18.632	20.273	1.642
10	241	19.396	19.379	-0.017
10	242	19.369	19.580	0.212
10	243	19.738	20.091	0.353
10	244	19.962	20.210	0.248
30	141	19.137	19.242	0.105
30	144	19.765	19.732	-0.033
30	145	19.267	19.387	0.120
30	146	19.581	19.494	-0.087
30	147	19.271	19.220	-0.051
30	132	19.901	19.955	0.054
30	133	19.603	19.552	-0.050
30	135	18.667	19.413	0.746
30	245	19.699	19.592	-0.107
30	246	19.215	19.021	-0.194
50	67	18.659	18.383	-0.275
50	68	19.117	19.876	0.759
50	69	19.432	19.417	-0.015
50	71	18.670	18.408	-0.262
50	72	18.883	19.221	0.338
50	172	19.556	19.317	-0.238
50	173	19.928	19.494	-0.433
50	174	19.241	19.702	0.462
50	183	19.089	18.653	-0.436
50	186	19.250	18.880	-0.370
100	95	19.826	19.297	-0.529
100	102	19.268	18.226	-1.042
100	104	19.528	18.888	-0.641
100	105	19.368	18.485	-0.883
100	106	19.718	18.713	-1.005
100	178	19.404	18.471	-0.933
100	179	19.584	18.595	-0.989
100	180	19.733	18.999	-0.734
100	181	19.578	18.375	-1.203
100	182	19.200	18.371	-0.829
	Max	20.020	20.273	1.642
	Average	19.319	19.341	0.022
	Min	18.367	18.226	-1.203
	Std Dev	0.434	0.564	0.593

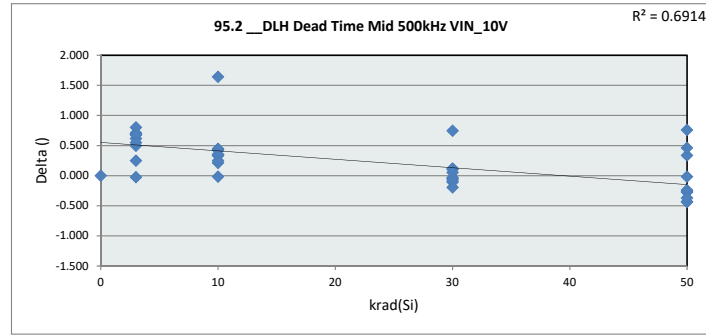

95.2 DLH Dead Time						
Test Site	DAL-FL					
Tester	ETS364					
Test Number	EB672302					
Max Limit	24					
Min Limit	15.5					
krad(Si)	0	3	10	30	50	100
LL	15.500	15.500	15.500	15.500	15.500	15.500
Min	20.020	19.054	19.293	19.021	18.383	18.226
Average	20.020	19.534	19.862	19.461	19.135	18.642
Max	20.020	20.243	20.273	19.955	19.876	19.297
UL	24.000	24.000	24.000	24.000	24.000	24.000

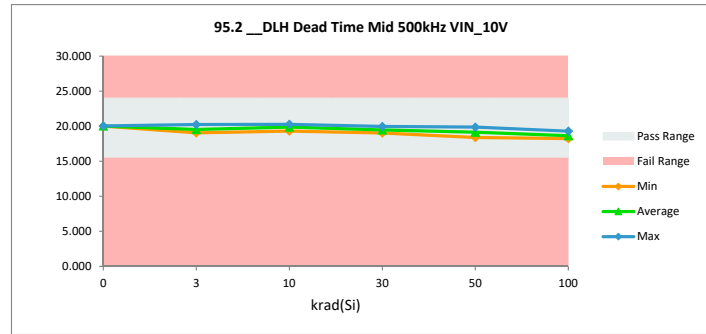

TID HDR Report
TPS7H6003-SP (5962R2220101VXC)

95.3 DLH Dead Time Large 500kHz VIN_10V		
Test Site	DAL-FL	DAL-FL
Tester	ETS364	ETS364
Test Number	EB672302	EB672302
Unit	nsec	
Max Limit	59	59
Min Limit	36	36

krad(Si)	Serial #	pre_short (rtp) (2)	ST_Combo (rpt) (Delta
0	Ctrl	49.371	49.371	0.000
3	58	48.109	48.454	0.345
3	59	45.855	46.365	0.510
3	60	47.098	47.610	0.512
3	61	45.810	46.293	0.483
3	62	45.507	46.097	0.590
3	134	48.703	45.869	-2.834
3	137	46.135	45.779	-0.356
3	138	45.556	45.849	0.293
3	139	47.891	47.861	-0.029
3	236	49.216	48.106	-1.110
10	63	48.646	48.867	0.221
10	64	48.924	49.083	0.160
10	65	49.070	49.217	0.147
10	66	45.823	45.991	0.168
10	150	48.448	48.512	0.063
10	237	45.273	48.308	3.035
10	241	48.008	45.806	-2.202
10	242	48.510	48.473	-0.036
10	243	48.140	48.006	-0.134
10	244	48.357	48.296	-0.061
30	141	47.994	47.246	-0.748
30	144	48.461	47.494	-0.967
30	145	46.479	45.529	-0.950
30	146	48.196	47.223	-0.973
30	147	47.909	47.075	-0.834
30	132	48.613	48.101	-0.511
30	133	48.170	47.209	-0.961
30	135	45.542	45.584	0.042
30	245	48.462	47.481	-0.980
30	246	48.272	47.217	-1.055
50	67	45.710	43.880	-1.831
50	68	48.121	47.365	-0.755
50	69	48.159	46.988	-1.171
50	71	45.541	44.324	-1.217
50	72	46.976	45.884	-1.092
50	172	46.329	45.129	-1.200
50	173	48.601	47.222	-1.379
50	174	48.482	47.640	-0.842
50	183	47.830	46.318	-1.512
50	186	45.955	44.825	-1.130
100	95	48.595	45.808	-2.787
100	102	47.710	44.414	-3.296
100	104	48.129	44.998	-3.131
100	105	47.914	44.708	-3.206
100	106	48.241	44.739	-3.502
100	178	47.452	44.518	-2.934
100	179	48.145	45.109	-3.036
100	180	48.711	45.798	-2.913
100	181	48.279	44.748	-3.531
100	182	47.357	44.718	-2.639
Max		49.371	49.371	3.035
Average		47.623	46.618	-1.005
Min		45.273	43.880	-3.531
Std Dev		1.173	1.483	1.363

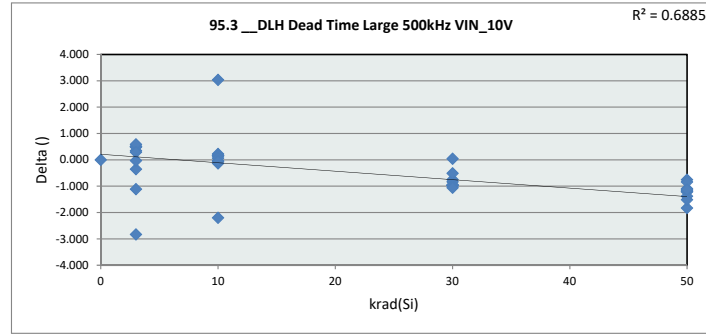

95.3 DLH Dead Time Large 500kHz VIN_10V						
Test Site	DAL-FL					
Tester	ETS364					
Test Number	EB672302					
Max Limit	59					
Min Limit	36					
krad(Si)	0	3	10	30	50	100
LL	36.000	36.000	36.000	36.000	36.000	36.000
Min	49.371	45.779	45.806	45.530	43.880	44.414
Average	49.371	46.828	48.056	47.016	45.957	44.956
Max	49.371	48.454	49.217	48.101	47.640	45.808
UL	59.000	59.000	59.000	59.000	59.000	59.000

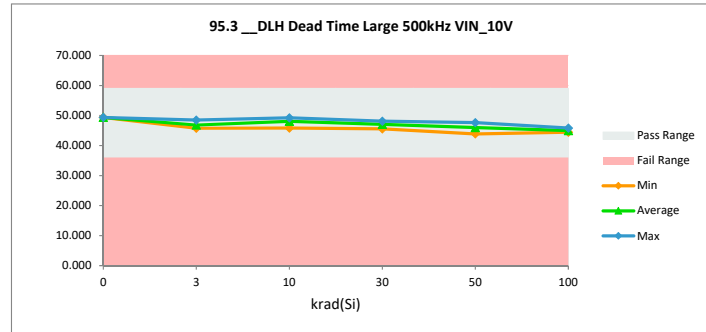

TID HDR Report
TPS7H6003-SP (5962R2220101VXC)

95.4 DLH Dead Time Max 500k		
Test Site	DAL-FL	DAL-FL
Tester	ETS364	ETS364
Test Number	EB672302	EB672302
Unit	nsec	
Max Limit	113.5	113.5
Min Limit	74	74

krad(Si)	Serial #	pre_short (rtp) (2)	ST_Combo (rpt) (Delta
0	Ctrl	96.123	96.123	0.000
3	58	93.610	93.757	0.147
3	59	89.372	89.829	0.456
3	60	91.965	92.301	0.336
3	61	88.696	89.227	0.531
3	62	88.454	88.636	0.182
3	134	95.769	87.922	-7.848
3	137	89.467	88.033	-1.434
3	138	88.094	88.075	-0.020
3	139	92.446	92.331	-0.115
3	236	96.940	93.574	-3.366
10	63	95.537	95.348	-0.189
10	64	96.212	95.906	-0.307
10	65	95.697	95.340	-0.357
10	66	88.340	88.093	-0.247
10	150	95.250	94.987	-0.263
10	237	87.681	93.451	5.770
10	241	94.448	88.116	-6.332
10	242	94.745	94.485	-0.261
10	243	92.969	92.425	-0.544
10	244	93.857	93.253	-0.604
30	141	94.372	92.297	-2.075
30	144	94.222	92.239	-1.984
30	145	89.355	86.635	-2.720
30	146	94.234	91.832	-2.402
30	147	93.525	91.366	-2.159
30	132	94.729	92.687	-2.042
30	133	93.642	91.372	-2.270
30	135	88.043	87.202	-0.841
30	245	94.926	92.120	-2.806
30	246	94.582	91.890	-2.692
50	67	87.481	84.169	-3.313
50	68	94.196	90.990	-3.206
50	69	94.181	91.064	-3.117
50	71	87.852	84.507	-3.345
50	72	91.929	88.513	-3.416
50	172	88.656	86.076	-2.579
50	173	94.084	90.927	-3.156
50	174	95.404	92.426	-2.979
50	183	94.011	90.604	-3.407
50	186	88.215	85.257	-2.957
100	95	94.460	87.688	-6.772
100	102	92.812	85.305	-7.507
100	104	93.567	86.534	-7.034
100	105	93.166	85.805	-7.360
100	106	93.995	85.957	-8.038
100	178	91.499	85.327	-6.172
100	179	94.000	87.271	-6.729
100	180	94.946	87.977	-6.969
100	181	93.601	86.435	-7.166
100	182	91.999	85.860	-6.139
Max		96.940	96.123	5.770
Average		92.693	89.991	-2.702
Min		87.481	84.169	-8.038
Std Dev		2.753	3.358	2.899

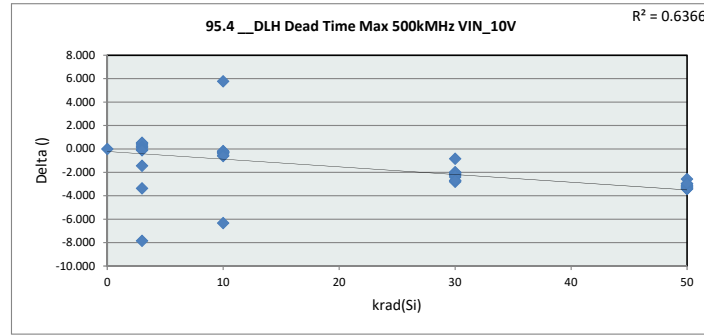

95.4 DLH Dead Time	
Test Site	DAL-FL
Tester	ETS364
Test Number	EB672302
Max Limit	113.5
Min Limit	74

krad(Si)	0	3	10	30	50	100
LL	74.000	74.000	74.000	74.000	74.000	74.000
Min	96.123	87.922	88.093	86.635	84.169	85.305
Average	96.123	90.368	93.140	90.964	88.453	86.416
Max	96.123	93.757	95.906	92.687	92.426	87.977
UL	113.500	113.500	113.500	113.500	113.500	113.500

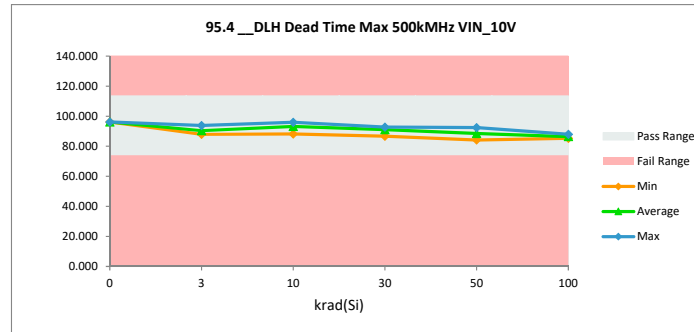

TID HDR Report
TPS7H6003-SP (5962R2220101VXC)

95.5 DLH Dead Time Min 1MHz		
Test Site	DAL-FL	DAL-FL
Tester	ETS364	ETS364
Test Number	EB672302	EB672302
Unit	nsec	
Max Limit	10	10
Min Limit	0	0

krad(Si)	Serial #	pre_short (rtp)	(2)'ST_Combo (rpt)	Delta
0	Ctrl	3.711	3.711	0.000
3	58	3.664	4.438	0.774
3	59	3.325	4.059	0.735
3	60	2.941	3.636	0.694
3	61	3.716	4.359	0.643
3	62	3.451	4.184	0.733
3	134	3.221	4.858	1.637
3	137	3.718	4.711	0.993
3	138	3.911	4.670	0.760
3	139	4.102	4.400	0.298
3	236	2.932	4.451	1.519
10	63	3.619	4.258	0.639
10	64	3.415	4.006	0.591
10	65	3.509	4.162	0.654
10	66	3.752	4.479	0.727
10	150	3.349	3.713	0.364
10	237	3.821	4.632	0.811
10	241	3.609	4.845	1.237
10	242	3.157	3.577	0.420
10	243	3.947	4.463	0.516
10	244	4.165	4.562	0.397
30	141	3.226	3.718	0.491
30	144	3.998	4.563	0.565
30	145	4.249	4.907	0.658
30	146	3.716	4.351	0.635
30	147	3.503	4.040	0.537
30	132	4.048	4.483	0.435
30	133	3.755	4.283	0.529
30	135	3.737	4.892	1.156
30	245	3.803	4.258	0.455
30	246	3.088	3.547	0.460
50	67	3.814	4.429	0.615
50	68	3.105	4.680	1.574
50	69	3.434	4.241	0.807
50	71	3.839	4.646	0.808
50	72	3.080	4.349	1.269
50	172	4.580	5.082	0.502
50	173	3.868	4.297	0.429
50	174	3.014	4.212	1.198
50	183	3.175	3.566	0.391
50	186	4.311	4.943	0.631
100	95	3.783	5.079	1.296
100	102	3.302	4.214	0.911
100	104	3.481	4.693	1.211
100	105	3.418	4.365	0.947
100	106	3.776	4.786	1.009
100	178	3.756	4.489	0.732
100	179	3.738	4.444	0.705
100	180	3.482	4.644	1.162
100	181	3.588	4.477	0.888
100	182	3.518	4.080	0.562
	Max	4.580	5.082	1.637
	Average	3.612	4.371	0.759
	Min	2.932	3.547	0.000
	Std Dev	0.363	0.393	0.345

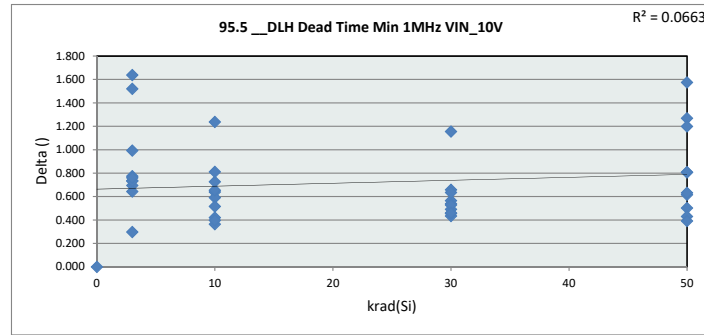

95.5 DLH Dead Time

Test Site	DAL-FL
Tester	ETS364
Test Number	EB672302
Max Limit	10
Min Limit	0

krad(Si)	0	3	10	30	50	100
LL	0.000	0.000	0.000	0.000	0.000	0.000
Min	3.711	3.636	3.577	3.547	3.567	4.080
Average	3.711	4.377	4.270	4.304	4.445	4.527
Max	3.711	4.858	4.846	4.907	5.082	5.079
UL	10.000	10.000	10.000	10.000	10.000	10.000

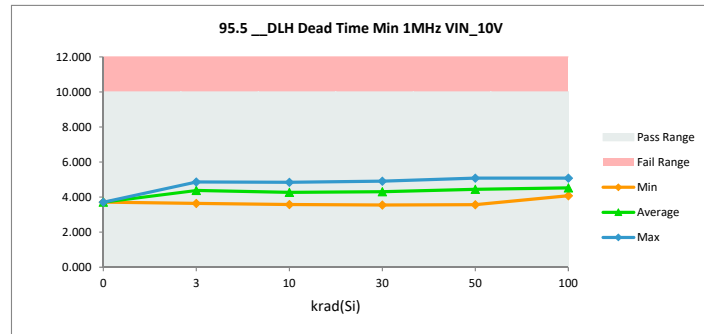

TID HDR Report
TPS7H6003-SP (5962R2220101VXC)

95.6 DLH Dead Time Small 1M		
Test Site	DAL-FL	DAL-FL
Tester	ETS364	ETS364
Test Number	EB672302	EB672302
Unit	nsec	
Max Limit	15.5	15.5
Min Limit	8	8

krad(Si)	Serial #	pre_short (rtp)	(2)ST_Combo (rpt)	Delta
0	Ctrl	10.913	10.913	0.000
3	58	10.889	11.445	0.557
3	59	9.972	10.789	0.817
3	60	10.123	10.713	0.590
3	61	10.531	11.194	0.662
3	62	10.066	10.771	0.705
3	134	10.498	11.209	0.711
3	137	10.422	11.318	0.895
3	138	10.426	11.363	0.936
3	139	11.031	11.337	0.306
3	236	10.393	11.471	1.078
10	63	10.783	11.415	0.633
10	64	10.717	11.147	0.430
10	65	10.844	11.241	0.397
10	66	10.441	11.043	0.602
10	150	10.473	10.812	0.339
10	237	10.458	11.593	1.135
10	241	10.698	11.348	0.650
10	242	10.436	10.818	0.382
10	243	11.012	11.415	0.404
10	244	11.349	11.502	0.152
30	141	10.280	10.596	0.316
30	144	11.019	11.218	0.199
30	145	10.910	11.163	0.253
30	146	10.860	10.976	0.116
30	147	10.512	10.662	0.150
30	132	11.032	11.364	0.332
30	133	10.896	11.034	0.138
30	135	10.448	11.314	0.866
30	245	10.978	11.159	0.181
30	246	10.202	10.267	0.065
50	67	10.421	10.440	0.019
50	68	10.326	11.334	1.008
50	69	10.613	11.017	0.404
50	71	10.369	10.525	0.156
50	72	10.129	10.835	0.706
50	172	11.317	11.332	0.015
50	173	11.077	10.913	-0.164
50	174	10.229	11.069	0.840
50	183	10.227	10.090	-0.137
50	186	10.891	11.145	0.254
100	95	11.015	11.176	0.161
100	102	10.465	10.193	-0.273
100	104	10.736	10.731	-0.005
100	105	10.533	10.492	-0.041
100	106	10.910	10.788	-0.122
100	178	10.749	10.561	-0.188
100	179	10.822	10.484	-0.338
100	180	10.738	10.854	0.116
100	181	10.743	10.519	-0.224
100	182	10.503	10.277	-0.226
Max		11.349	11.593	1.135
Average		10.636	10.968	0.333
Min		9.972	10.090	-0.338
Std Dev		0.323	0.382	0.384

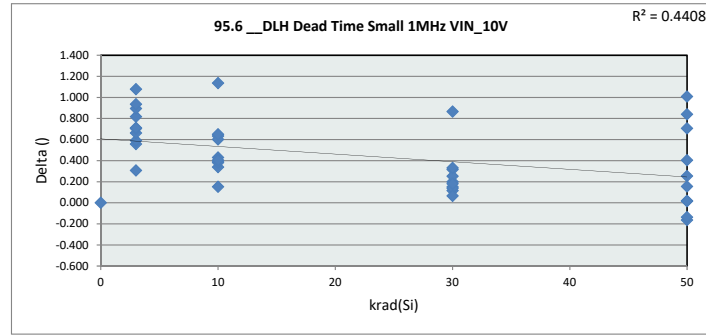

95.6 DLH Dead Time

Test Site	DAL-FL
Tester	ETS364
Test Number	EB672302
Max Limit	15.5
Min Limit	8

krad(Si)	0	3	10	30	50	100
LL	8.000	8.000	8.000	8.000	8.000	8.000
Min	10.913	10.713	10.812	10.267	10.090	10.193
Average	10.913	11.161	11.234	10.975	10.870	10.607
Max	10.913	11.471	11.593	11.364	11.334	11.176
UL	15.500	15.500	15.500	15.500	15.500	15.500

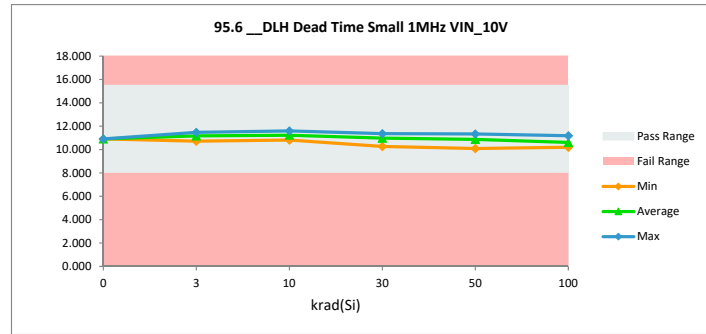

TID HDR Report
TPS7H6003-SP (5962R2220101VXC)

95.7_DLH Dead Time Mid 1MHz		
Test Site	DAL-FL	DAL-FL
Tester	ETS364	ETS364
Test Number	EB672302	EB672302
Unit	nsec	
Max Limit	24	
Min Limit	15.5	

krad(Si)	Serial #	pre_short (rtp)	(2)ST_Combo (rpt)	Delta
0	Ctrl	19.639	19.639	0.000
3	58	19.280	19.753	0.473
3	59	17.984	18.810	0.825
3	60	18.552	19.132	0.580
3	61	18.404	18.913	0.509
3	62	17.948	18.699	0.750
3	134	19.147	19.009	-0.138
3	137	18.306	18.955	0.649
3	138	18.288	18.892	0.603
3	139	19.234	19.691	0.457
3	236	19.151	19.690	0.538
10	63	19.247	19.736	0.489
10	64	19.299	19.763	0.463
10	65	19.238	19.858	0.621
10	66	18.436	18.909	0.473
10	150	18.888	19.144	0.256
10	237	18.232	19.732	1.501
10	241	18.952	18.924	-0.028
10	242	18.948	19.285	0.337
10	243	19.279	19.592	0.313
10	244	19.643	19.890	0.247
30	141	18.737	18.753	0.016
30	144	19.374	19.475	0.101
30	145	18.881	18.853	-0.028
30	146	19.191	19.199	0.008
30	147	18.870	18.774	-0.096
30	132	19.480	19.582	0.102
30	133	19.168	19.131	-0.037
30	135	18.329	19.006	0.678
30	245	19.228	19.220	-0.008
30	246	18.677	18.619	-0.058
50	67	18.340	17.979	-0.360
50	68	18.770	19.434	0.663
50	69	19.067	18.952	-0.115
50	71	18.233	18.087	-0.146
50	72	18.500	18.662	0.163
50	172	19.217	18.883	-0.334
50	173	19.455	19.110	-0.345
50	174	18.875	19.243	0.369
50	183	18.576	18.262	-0.314
50	186	18.801	18.621	-0.180
100	95	19.354	18.896	-0.459
100	102	18.710	17.793	-0.916
100	104	19.119	18.540	-0.579
100	105	18.920	18.132	-0.788
100	106	19.240	18.503	-0.737
100	178	19.062	18.249	-0.814
100	179	19.106	18.194	-0.912
100	180	19.337	18.697	-0.640
100	181	19.045	18.119	-0.926
100	182	18.844	17.951	-0.892
	Max	19.643	19.890	1.501
	Average	18.914	18.960	0.046
	Min	17.948	17.793	-0.926
	Std Dev	0.422	0.556	0.541

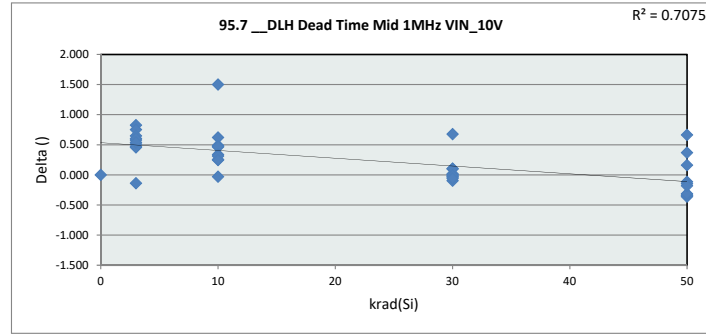

95.7_DLH Dead Time		
Test Site	DAL-FL	
Tester	ETS364	
Test Number	EB672302	
Max Limit	24	
Min Limit	15.5	

krad(Si)	0	3	10	30	50	100
LL	15.500	15.500	15.500	15.500	15.500	15.500
Min	19.640	18.699	18.909	18.619	17.979	17.793
Average	19.640	19.154	19.483	19.061	18.723	18.307
Max	19.640	19.754	19.890	19.582	19.434	18.896
UL	24.000	24.000	24.000	24.000	24.000	24.000

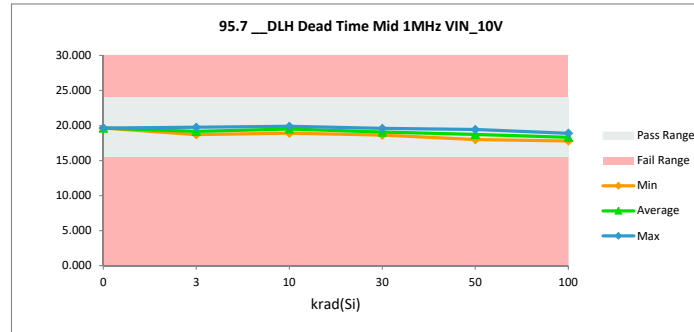

TID HDR Report
TPS7H6003-SP (5962R2220101VXC)

95.8 DLH Dead Time Large 1M		
Test Site	DAL-FL	DAL-FL
Tester	ETS364	ETS364
Test Number	EB672302	EB672302
Unit	nsec	
Max Limit	59	59
Min Limit	36	36

krad(Si)	Serial #	pre_short (rtp)	(2)'ST_Combo (rpt)	Delta
0	Ctrl	47.586	47.586	0.000
3	58	46.420	46.893	0.473
3	59	43.882	44.588	0.705
3	60	45.412	45.923	0.510
3	61	44.101	44.542	0.441
3	62	43.817	44.350	0.533
3	134	46.966	44.228	-2.738
3	137	44.335	44.149	-0.186
3	138	44.066	44.194	0.128
3	139	46.039	46.150	0.111
3	236	47.387	46.463	-0.924
10	63	46.879	47.141	0.261
10	64	47.061	47.284	0.223
10	65	47.092	47.526	0.433
10	66	44.069	44.330	0.261
10	150	46.484	46.812	0.328
10	237	43.647	46.479	2.831
10	241	46.317	44.223	-2.094
10	242	46.772	46.824	0.052
10	243	46.212	46.284	0.072
10	244	46.481	46.634	0.153
30	141	46.194	45.622	-0.571
30	144	46.544	45.683	-0.861
30	145	44.894	44.017	-0.877
30	146	46.331	45.523	-0.808
30	147	45.999	45.450	-0.550
30	132	46.886	46.087	-0.799
30	133	46.268	45.462	-0.805
30	135	43.815	44.238	0.423
30	245	46.647	45.859	-0.787
30	246	46.526	45.308	-1.218
50	67	43.929	42.638	-1.291
50	68	46.342	45.574	-0.769
50	69	46.528	45.237	-1.291
50	71	43.959	43.117	-0.842
50	72	45.309	44.248	-1.061
50	172	44.702	43.876	-0.826
50	173	46.804	45.391	-1.413
50	174	46.744	46.005	-0.739
50	183	46.053	44.544	-1.509
50	186	44.453	43.537	-0.916
100	95	46.704	44.075	-2.629
100	102	45.824	43.001	-2.822
100	104	46.334	43.444	-2.890
100	105	46.139	43.260	-2.879
100	106	46.426	43.346	-3.079
100	178	45.472	42.977	-2.495
100	179	46.357	43.570	-2.786
100	180	46.998	44.150	-2.848
100	181	46.445	43.183	-3.262
100	182	45.544	43.140	-2.404
Max		47.586	47.586	2.831
Average		45.847	44.984	-0.863
Min		43.647	42.638	-3.262
Std Dev		1.121	1.373	1.287

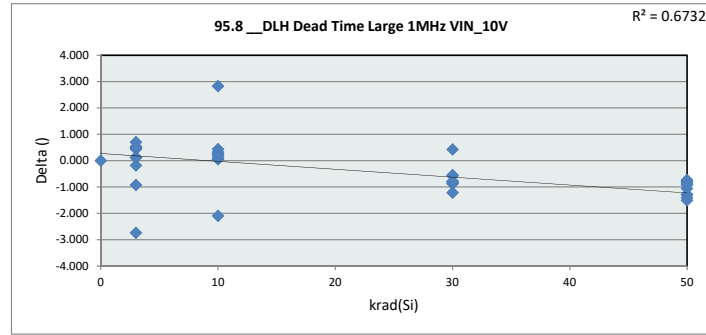

95.8 DLH Dead Time

Test Site	DAL-FL
Tester	ETS364
Test Number	EB672302
Max Limit	59
Min Limit	36

krad(Si)	0	3	10	30	50	100
LL	36.000	36.000	36.000	36.000	36.000	36.000
Min	47.586	44.149	44.223	44.017	42.638	42.977
Average	47.586	45.148	46.354	45.325	44.417	43.415
Max	47.586	46.893	47.526	46.087	46.005	44.150
UL	59.000	59.000	59.000	59.000	59.000	59.000

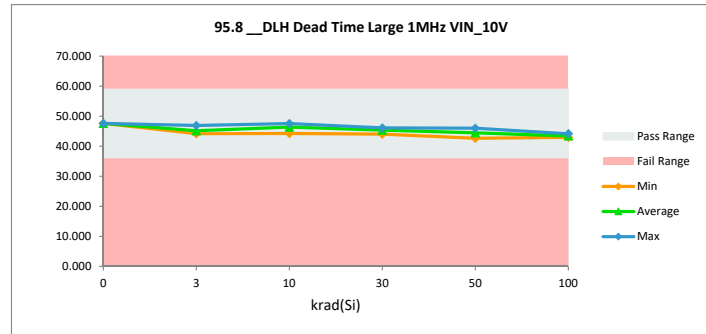

TID HDR Report
TPS7H6003-SP (5962R2220101VXC)

95.9 DLH Dead Time Max 1MHz		
Test Site	DAL-FL	DAL-FL
Tester	ETS364	ETS364
Test Number	EB672302	EB672302
Unit	nsec	
Max Limit	113.5	113.5
Min Limit	74	74

krad(Si)	Serial #	pre_short (rtp) (2)	ST_Combo (rpt) (Delta
0	Ctrl	91.711	91.711	0.000
3	58	88.898	89.303	0.405
3	59	84.863	85.453	0.590
3	60	87.528	87.809	0.281
3	61	84.321	84.818	0.497
3	62	84.009	84.353	0.344
3	134	91.131	83.793	-7.338
3	137	85.197	83.737	-1.461
3	138	83.764	83.779	0.015
3	139	87.800	87.964	0.164
3	236	92.384	89.160	-3.224
10	63	90.886	90.630	-0.257
10	64	91.546	91.440	-0.106
10	65	90.967	90.475	-0.492
10	66	84.041	83.934	-0.108
10	150	90.487	90.388	-0.099
10	237	83.451	89.021	5.570
10	241	89.687	83.828	-5.858
10	242	90.224	89.971	-0.252
10	243	88.367	87.958	-0.409
10	244	89.213	88.804	-0.409
30	141	89.576	87.913	-1.664
30	144	89.543	87.536	-2.006
30	145	84.871	82.813	-2.057
30	146	89.580	87.411	-2.169
30	147	88.893	87.007	-1.887
30	132	90.023	88.253	-1.770
30	133	89.001	87.147	-1.854
30	135	83.651	83.095	-0.557
30	245	90.109	87.827	-2.282
30	246	89.993	87.448	-2.545
50	67	83.330	80.343	-2.987
50	68	89.509	86.826	-2.684
50	69	89.563	86.773	-2.789
50	71	83.546	80.665	-2.881
50	72	87.353	84.538	-2.815
50	172	84.418	82.119	-2.299
50	173	89.474	86.577	-2.896
50	174	90.773	88.071	-2.702
50	183	89.243	86.255	-2.988
50	186	83.946	81.435	-2.511
100	95	89.755	83.754	-6.001
100	102	88.271	81.549	-6.722
100	104	89.047	82.737	-6.310
100	105	88.530	81.778	-6.751
100	106	89.307	82.161	-7.147
100	178	86.923	81.536	-5.386
100	179	89.313	83.423	-5.890
100	180	90.218	84.091	-6.127
100	181	89.061	82.528	-6.533
100	182	87.417	81.981	-5.436
Max		92.384	91.711	5.570
Average		88.132	85.763	-2.368
Min		83.330	80.343	-7.338
Std Dev		2.619	3.109	2.656

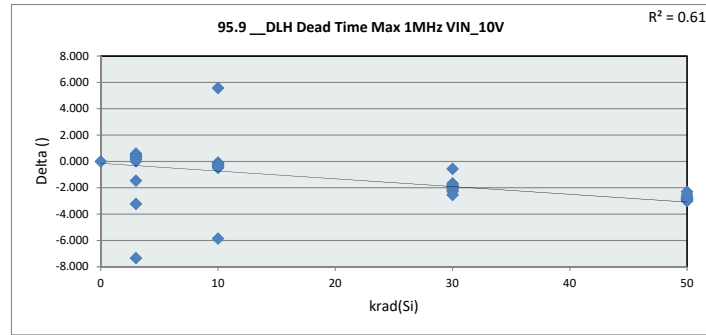

95.9 DLH Dead Time						
Test Site	DAL-FL					
Tester	ETS364					
Test Number	EB672302					
Max Limit	113.5					
Min Limit	74					
krad(Si)	0	3	10	30	50	100
LL	74.000	74.000	74.000	74.000	74.000	74.000
Min	91.711	83.737	83.829	82.814	80.343	81.536
Average	91.711	86.017	88.645	86.645	84.360	82.554
Max	91.711	89.304	91.440	88.253	88.071	84.092
UL	113.500	113.500	113.500	113.500	113.500	113.500

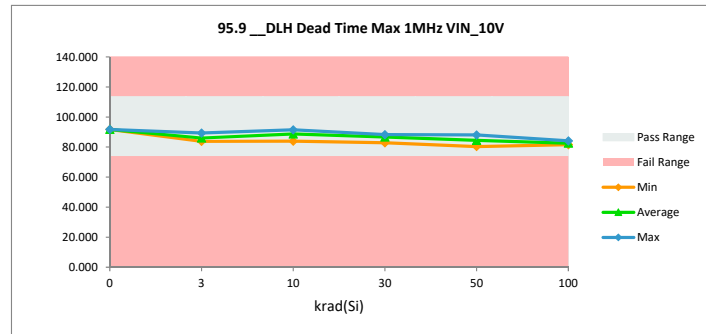

TID HDR Report
TPS7H6003-SP (5962R2220101VXC)

95.10_DLH Dead Time Min 2MHz		
Test Site	DAL-FL	DAL-FL
Tester	ETS364	ETS364
Test Number	EB672302	EB672302
Unit	nsec	
Max Limit	10	10
Min Limit	0	0

krad(Si)	Serial #	pre_short (rtp)	(2)'ST_Combo (rpt)	Delta
0	Ctrl	3.635	3.635	0.000
3	58	3.826	4.458	0.632
3	59	3.366	4.129	0.763
3	60	3.084	3.814	0.729
3	61	3.891	4.692	0.800
3	62	3.552	4.402	0.849
3	134	3.364	5.006	1.642
3	137	3.818	4.875	1.057
3	138	3.935	4.969	1.034
3	139	4.016	4.507	0.491
3	236	2.929	4.550	1.621
10	63	3.596	4.411	0.816
10	64	3.511	4.073	0.562
10	65	3.642	4.348	0.705
10	66	3.825	4.519	0.694
10	150	3.387	3.847	0.460
10	237	3.830	4.503	0.673
10	241	3.650	4.854	1.204
10	242	3.299	3.780	0.481
10	243	4.067	4.390	0.323
10	244	4.312	4.504	0.192
30	141	3.412	3.982	0.570
30	144	4.041	4.650	0.609
30	145	4.394	4.971	0.576
30	146	3.891	4.328	0.438
30	147	3.526	4.013	0.487
30	132	4.021	4.548	0.527
30	133	3.881	4.292	0.411
30	135	3.866	4.967	1.101
30	245	3.774	4.273	0.499
30	246	3.197	3.611	0.414
50	67	3.796	4.555	0.759
50	68	3.308	4.861	1.553
50	69	3.594	4.620	1.026
50	71	3.739	4.563	0.824
50	72	3.134	4.292	1.158
50	172	4.746	5.154	0.408
50	173	3.919	4.333	0.414
50	174	3.070	4.210	1.140
50	183	3.275	3.750	0.475
50	186	4.463	4.986	0.524
100	95	3.867	4.957	1.090
100	102	3.434	4.266	0.832
100	104	3.459	4.782	1.323
100	105	3.479	4.571	1.092
100	106	3.752	4.817	1.065
100	178	3.786	4.462	0.676
100	179	3.785	4.256	0.471
100	180	3.647	4.595	0.947
100	181	3.744	4.365	0.620
100	182	3.579	4.109	0.530
	Max	4.746	5.154	1.642
	Average	3.689	4.439	0.751
	Min	2.929	3.611	0.000
	Std Dev	0.361	0.381	0.354

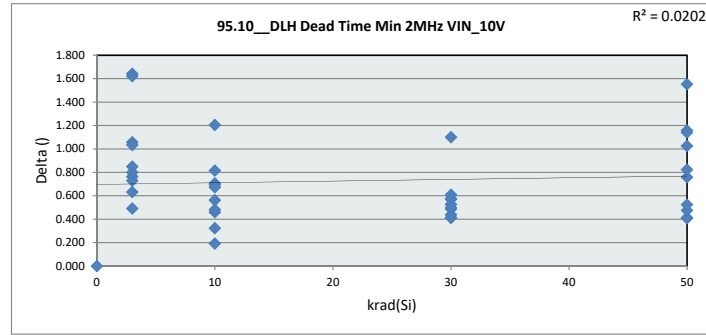

95.10_DLH Dead Time

Test Site	DAL-FL
Tester	ETS364
Test Number	EB672302
Max Limit	10
Min Limit	0

krad(Si)	0	3	10	30	50	100
LL	0.000	0.000	0.000	0.000	0.000	0.000
Min	3.635	3.814	3.780	3.611	3.750	4.109
Average	3.635	4.540	4.323	4.364	4.532	4.518
Max	3.635	5.006	4.854	4.971	5.154	4.957
UL	10.000	10.000	10.000	10.000	10.000	10.000

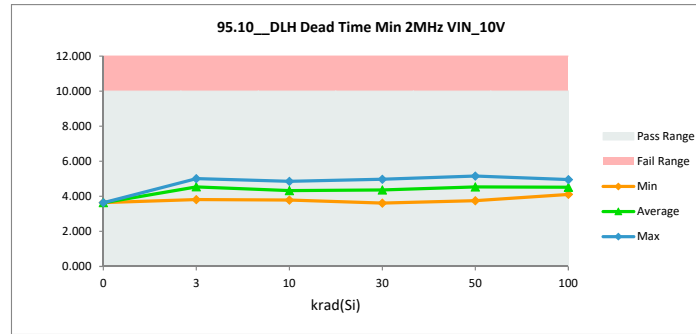

TID HDR Report
TPS7H6003-SP (5962R2220101VXC)

95.11_DLH Dead Time Small 2M		
Test Site	DAL-FL	DAL-FL
Tester	ETS364	ETS364
Test Number	EB672302	EB672302
Unit	nsec	
Max Limit	15.5	15.5
Min Limit	8	8

krad(Si)	Serial #	pre_short (rtp)	(2)ST_Combol (rpt)	Delta
0	Ctrl	10.991	10.991	0.000
3	58	10.819	11.538	0.719
3	59	9.947	10.917	0.970
3	60	10.060	10.662	0.602
3	61	10.451	11.229	0.778
3	62	10.006	10.788	0.782
3	134	10.435	11.247	0.812
3	137	10.340	11.271	0.931
3	138	10.394	11.305	0.911
3	139	10.915	11.379	0.464
3	236	10.261	11.409	1.148
10	63	10.696	11.277	0.580
10	64	10.671	11.139	0.468
10	65	10.727	11.336	0.609
10	66	10.474	11.199	0.726
10	150	10.381	10.673	0.293
10	237	10.403	11.568	1.165
10	241	10.658	11.397	0.739
10	242	10.369	10.993	0.624
10	243	10.946	11.441	0.495
10	244	11.310	11.454	0.145
30	141	10.233	10.565	0.331
30	144	11.040	11.302	0.262
30	145	10.877	11.154	0.278
30	146	10.826	10.907	0.081
30	147	10.462	10.598	0.136
30	132	10.943	11.221	0.278
30	133	10.825	11.125	0.300
30	135	10.350	11.307	0.957
30	245	10.796	11.103	0.307
30	246	10.157	10.462	0.305
50	67	10.340	10.385	0.045
50	68	10.284	11.238	0.955
50	69	10.595	10.935	0.340
50	71	10.243	10.404	0.160
50	72	10.115	10.866	0.751
50	172	11.260	11.441	0.180
50	173	11.037	11.034	-0.003
50	174	10.196	10.988	0.792
50	183	10.171	10.141	-0.031
50	186	10.904	10.920	0.016
100	95	10.915	11.236	0.321
100	102	10.437	10.341	-0.095
100	104	10.641	10.962	0.321
100	105	10.471	10.364	-0.107
100	106	10.888	10.714	-0.174
100	178	10.709	10.425	-0.285
100	179	10.714	10.359	-0.355
100	180	10.751	10.835	0.084
100	181	10.683	10.359	-0.324
100	182	10.444	10.269	-0.175
Max		11.310	11.568	1.165
Average		10.580	10.964	0.384
Min		9.947	10.141	-0.355
Std Dev		0.325	0.390	0.398

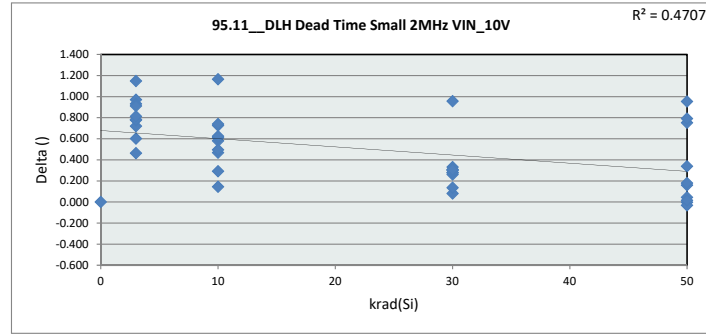

95.11_DLH Dead Time Small 2MHz VIN_10V						
Test Site	DAL-FL					
Tester	ETS364					
Test Number	EB672302					
Max Limit	15.5					
Min Limit	8					
krad(Si)	0	3	10	30	50	100
LL	8.000	8.000	8.000	8.000	8.000	8.000
Min	10.992	10.662	10.673	10.462	10.141	10.269
Average	10.992	11.175	11.248	10.974	10.835	10.586
Max	10.992	11.539	11.568	11.307	11.441	11.236
UL	15.500	15.500	15.500	15.500	15.500	15.500

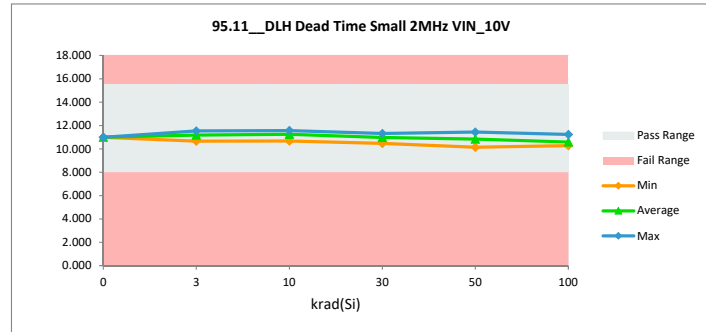

TID HDR Report
TPS7H6003-SP (5962R2220101VXC)

95.12_DLH Dead Time Mid 2MH		
Test Site	DAL-FL	DAL-FL
Tester	ETS364	ETS364
Test Number	EB672302	EB672302
Unit	nsec	
Max Limit	24	
Min Limit	15.5	

krad(Si)	Serial #	pre_short (rtp)	(2)ST_Combo (rpt)	Delta
0	Ctrl	19.579	19.579	0.000
3	58	19.041	19.670	0.630
3	59	17.789	18.511	0.722
3	60	18.226	18.814	0.588
3	61	18.193	18.810	0.617
3	62	17.851	18.641	0.790
3	134	18.833	18.722	-0.110
3	137	18.124	18.907	0.783
3	138	18.044	18.708	0.663
3	139	19.102	19.324	0.222
3	236	18.937	19.459	0.522
10	63	19.154	19.681	0.528
10	64	19.072	19.455	0.383
10	65	19.101	19.488	0.387
10	66	18.292	18.911	0.620
10	150	18.758	19.023	0.265
10	237	17.977	19.639	1.662
10	241	18.783	18.882	0.099
10	242	18.767	19.324	0.557
10	243	19.124	19.572	0.449
10	244	19.399	19.527	0.128
30	141	18.485	18.772	0.287
30	144	19.319	19.338	0.019
30	145	18.758	18.887	0.128
30	146	19.014	18.885	-0.129
30	147	18.750	18.590	-0.160
30	132	19.448	19.523	0.075
30	133	19.058	19.050	-0.007
30	135	18.078	18.927	0.849
30	245	19.044	18.877	-0.167
30	246	18.468	18.463	-0.005
50	67	18.129	17.769	-0.360
50	68	18.607	19.206	0.599
50	69	18.969	18.795	-0.174
50	71	18.063	17.773	-0.290
50	72	18.341	18.636	0.295
50	172	19.009	18.623	-0.386
50	173	19.329	18.903	-0.426
50	174	18.706	19.024	0.318
50	183	18.452	17.935	-0.518
50	186	18.654	18.344	-0.310
100	95	19.156	18.708	-0.448
100	102	18.576	17.785	-0.792
100	104	18.968	18.517	-0.451
100	105	18.684	17.940	-0.745
100	106	19.246	18.181	-1.066
100	178	18.711	18.063	-0.647
100	179	19.022	18.066	-0.956
100	180	19.244	18.543	-0.701
100	181	18.959	17.906	-1.053
100	182	18.605	17.843	-0.763
	Max	19.579	19.681	1.662
	Average	18.745	18.794	0.049
	Min	17.789	17.769	-1.066
	Std Dev	0.448	0.558	0.574

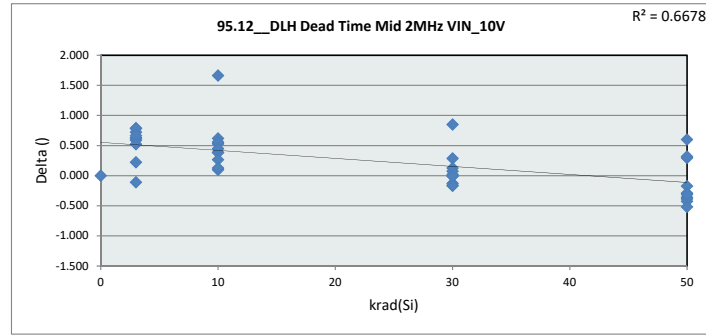

95.12_DLH Dead Time						
Test Site	DAL-FL					
Tester	ETS364					
Test Number	EB672302					
Max Limit	24					
Min Limit	15.5					
krad(Si)	0	3	10	30	50	100
LL	15.500	15.500	15.500	15.500	15.500	15.500
Min	19.579	18.511	18.882	18.463	17.769	17.785
Average	19.579	18.957	19.350	18.931	18.501	18.155
Max	19.579	19.670	19.682	19.523	19.206	18.708
UL	24.000	24.000	24.000	24.000	24.000	24.000

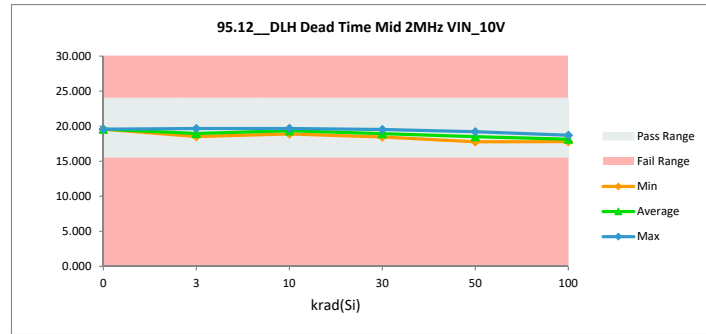

TID HDR Report
TPS7H6003-SP (5962R2220101VXC)

95.13 DLH Dead Time Large 2MHz		
Test Site	DAL-FL	DAL-FL
Tester	ETS364	ETS364
Test Number	EB672302	EB672302
Unit	nsec	
Max Limit	59	59
Min Limit	36	36

krad(Si)	Serial #	pre_short (rtp) (2)'ST	Combo (rpt) (Delta
0	Ctrl	47.443	47.443	0.000
3	58	46.044	46.660	0.616
3	59	43.600	44.319	0.719
3	60	45.033	45.629	0.596
3	61	43.772	44.335	0.563
3	62	43.456	44.133	0.677
3	134	46.664	43.832	-2.832
3	137	44.000	43.901	-0.098
3	138	43.688	43.891	0.202
3	139	45.705	45.799	0.094
3	236	47.126	46.188	-0.938
10	63	46.591	46.843	0.252
10	64	46.728	47.038	0.309
10	65	46.704	46.954	0.249
10	66	43.785	44.174	0.389
10	150	46.174	46.463	0.289
10	237	43.379	46.205	2.826
10	241	45.886	43.917	-1.969
10	242	46.419	46.436	0.017
10	243	45.865	46.104	0.240
10	244	46.211	46.328	0.118
30	141	45.762	45.084	-0.678
30	144	46.235	45.531	-0.705
30	145	44.377	43.826	-0.550
30	146	46.185	45.308	-0.877
30	147	45.627	45.022	-0.605
30	132	46.462	45.969	-0.493
30	133	45.857	45.188	-0.669
30	135	43.563	44.061	0.498
30	245	46.247	45.357	-0.890
30	246	46.063	45.000	-1.064
50	67	43.593	42.406	-1.187
50	68	45.961	45.255	-0.706
50	69	46.117	44.876	-1.241
50	71	43.613	42.722	-0.891
50	72	44.939	44.013	-0.927
50	172	44.266	43.438	-0.828
50	173	46.556	45.088	-1.468
50	174	46.496	45.539	-0.957
50	183	45.616	44.133	-1.483
50	186	44.132	43.256	-0.876
100	95	46.333	43.874	-2.459
100	102	45.582	42.814	-2.768
100	104	46.024	43.167	-2.856
100	105	45.832	42.890	-2.942
100	106	46.242	43.203	-3.039
100	178	45.183	42.890	-2.293
100	179	46.164	43.556	-2.608
100	180	46.669	44.088	-2.581
100	181	46.149	43.131	-3.018
100	182	45.150	42.888	-2.262
	Max	47.443	47.443	2.826
	Average	45.515	44.709	-0.806
	Min	43.379	42.406	-3.039
	Std Dev	1.132	1.340	1.265

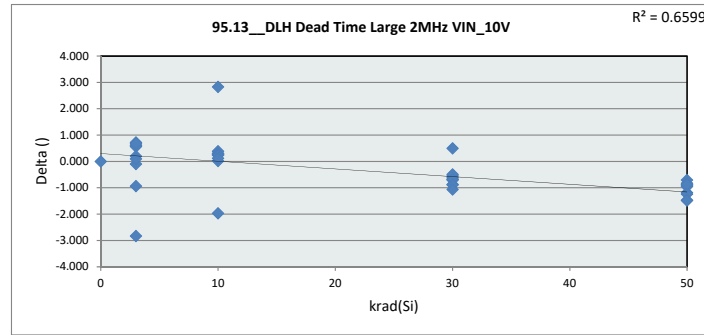

95.13 DLH Dead Time Large 2MHz VIN_10V						
Test Site	DAL-FL					
Tester	ETS364					
Test Number	EB672302					
Max Limit	59					
Min Limit	36					
krad(Si)	0	3	10	30	50	100
LL	36.000	36.000	36.000	36.000	36.000	36.000
Min	47.443	43.832	43.917	43.826	42.406	42.814
Average	47.443	44.869	46.046	45.035	44.072	43.250
Max	47.443	46.660	47.038	45.969	45.539	44.088
UL	59.000	59.000	59.000	59.000	59.000	59.000

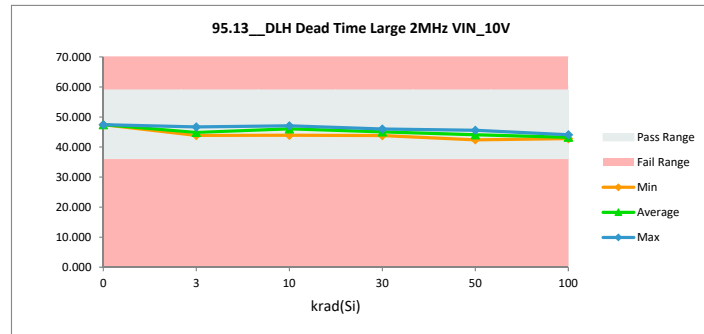

TID HDR Report
TPS7H6003-SP (5962R2220101VXC)

95.14 DLH Dead Time Max 2MHz		
Test Site	DAL-FL	DAL-FL
Tester	ETS364	ETS364
Test Number	EB672302	EB672302
Unit	nsec	
Max Limit	113.5	113.5
Min Limit	74	74

krad(Si)	Serial #	pre_short (rtp)	(2)'ST_Combo (rpt)	Delta
0	Ctrl	92.338	92.338	0.000
3	58	89.552	90.136	0.584
3	59	85.371	86.186	0.815
3	60	88.180	88.652	0.472
3	61	84.940	85.711	0.771
3	62	84.592	84.951	0.358
3	134	91.973	84.232	-7.741
3	137	85.742	84.111	-1.631
3	138	84.294	84.326	0.032
3	139	88.176	88.407	0.231
3	236	93.354	89.904	-3.450
10	63	91.579	91.461	-0.118
10	64	92.259	92.175	-0.083
10	65	91.545	91.495	-0.050
10	66	84.663	84.584	-0.079
10	150	91.155	91.324	0.169
10	237	83.941	89.690	5.749
10	241	90.490	84.180	-6.310
10	242	91.090	90.677	-0.413
10	243	89.083	88.822	-0.261
10	244	89.851	89.816	-0.035
30	141	90.278	88.498	-1.780
30	144	90.208	88.378	-1.830
30	145	85.438	83.293	-2.146
30	146	90.427	88.313	-2.114
30	147	89.469	87.923	-1.546
30	132	90.703	89.093	-1.610
30	133	89.716	87.617	-2.099
30	135	84.112	83.628	-0.485
30	245	90.811	88.437	-2.374
30	246	90.603	88.264	-2.339
50	67	83.746	81.032	-2.713
50	68	90.303	87.436	-2.867
50	69	90.177	87.317	-2.860
50	71	84.107	81.298	-2.809
50	72	88.011	85.267	-2.744
50	172	84.890	82.565	-2.325
50	173	90.251	87.382	-2.869
50	174	91.552	89.015	-2.538
50	183	89.980	87.036	-2.944
50	186	84.455	82.021	-2.434
100	95	90.339	84.514	-5.825
100	102	89.159	82.385	-6.774
100	104	89.889	83.724	-6.165
100	105	89.346	82.535	-6.812
100	106	90.137	83.030	-7.107
100	178	87.523	82.112	-5.411
100	179	90.063	84.152	-5.911
100	180	90.887	84.840	-6.047
100	181	89.819	83.275	-6.545
100	182	88.080	82.670	-5.410
Max		93.354	92.338	5.749
Average		88.797	86.475	-2.322
Min		83.746	81.032	-7.741
Std Dev		2.707	3.169	2.729

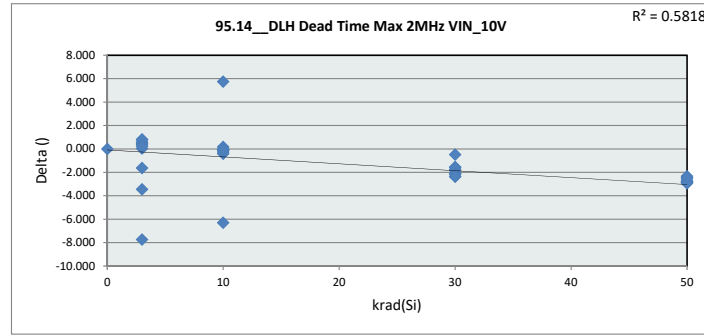

95.14 DLH Dead Time

Test Site	DAL-FL
Tester	ETS364
Test Number	EB672302
Max Limit	113.5
Min Limit	74

krad(Si)	0	3	10	30	50	100
LL	74.000	74.000	74.000	74.000	74.000	74.000
Min	92.338	84.111	84.180	83.293	81.032	82.112
Average	92.338	86.661	89.422	87.344	85.037	83.324
Max	92.338	90.136	92.176	89.093	89.015	84.840
UL	113.500	113.500	113.500	113.500	113.500	113.500

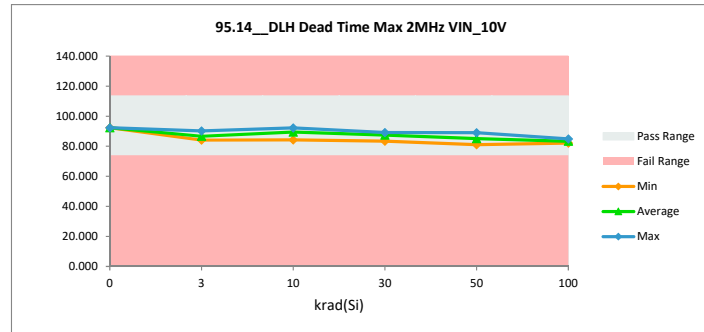

TID HDR Report

TPS7H6003-SP (5962R2220101VXC)

95.19 DHL Dead Time Min 500kHz		
Test Site	DAL-FL	DAL-FL
Tester	ETS364	ETS364
Test Number	EB672302	EB672302
Unit	nsec	
Max Limit	10	10
Min Limit	0	0

krad(Si)	Serial #	pre_short (rtp)	(2)ST_Combo (rpt)	Delta
0	Ctrl	3.894	3.894	0.000
3	58	4.570	3.974	-0.596
3	59	4.798	4.410	-0.388
3	60	4.726	4.408	-0.317
3	61	3.989	3.493	-0.496
3	62	4.000	3.322	-0.678
3	134	4.335	4.213	-0.122
3	137	4.298	4.151	-0.147
3	138	3.881	4.126	0.245
3	139	4.464	4.249	-0.214
3	236	4.141	4.580	0.440
10	63	4.786	4.349	-0.437
10	64	4.230	3.860	-0.370
10	65	4.556	4.017	-0.540
10	66	3.632	3.101	-0.531
10	150	4.838	4.817	-0.021
10	237	4.574	4.561	-0.013
10	241	4.615	4.241	-0.374
10	242	4.384	4.175	-0.209
10	243	3.417	3.575	0.158
10	244	4.085	4.004	-0.081
30	141	4.275	4.267	-0.008
30	144	4.172	3.903	-0.269
30	145	3.960	3.455	-0.505
30	146	4.147	4.102	-0.045
30	147	4.719	4.493	-0.226
30	132	3.808	3.839	0.031
30	133	4.588	4.596	0.008
30	135	4.609	3.340	-1.269
30	245	3.983	3.932	-0.051
30	246	4.433	4.390	-0.044
50	67	4.892	4.586	-0.306
50	68	3.880	4.044	0.164
50	69	4.716	4.164	-0.552
50	71	3.382	2.932	-0.450
50	72	4.609	4.099	-0.510
50	172	4.197	4.014	-0.183
50	173	4.163	4.231	0.067
50	174	4.248	4.112	-0.136
50	183	4.619	4.674	0.056
50	186	3.515	3.474	-0.042
100	95	4.832	4.466	-0.365
100	102	4.290	4.270	-0.019
100	104	4.756	4.617	-0.138
100	105	4.162	3.592	-0.570
100	106	4.046	4.244	0.198
100	178	4.383	4.492	0.109
100	179	3.986	4.337	0.351
100	180	4.363	4.468	0.105
100	181	4.405	4.313	-0.092
100	182	3.593	3.744	0.151
	Max	4.892	4.817	0.440
	Average	4.273	4.092	-0.181
	Min	3.382	2.932	-1.269
	Std Dev	0.389	0.421	0.308

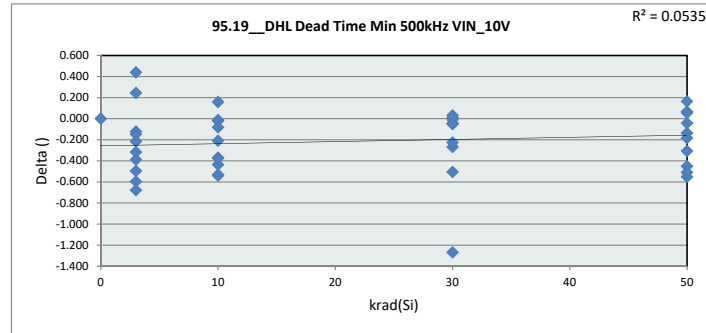

95.19 DHL Dead Time	
Test Site	DAL-FL
Tester	ETS364
Test Number	EB672302
Max Limit	10
Min Limit	0

krad(Si)	0	3	10	30	50	100
LL	0.000	0.000	0.000	0.000	0.000	0.000
Min	3.894	3.322	3.101	3.340	2.932	3.593
Average	3.894	4.093	4.070	4.032	4.033	4.254
Max	3.894	4.580	4.817	4.596	4.674	4.617
UL	10.000	10.000	10.000	10.000	10.000	10.000

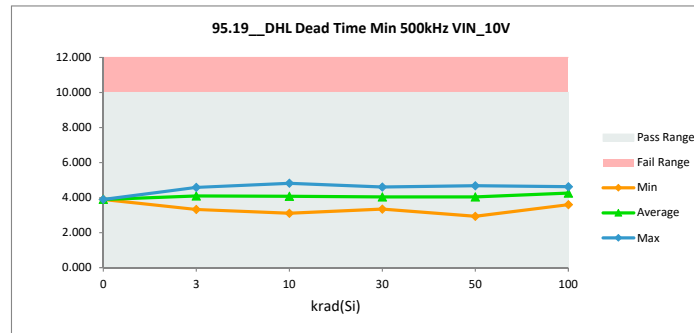

TID HDR Report

TPS7H6003-SP (5962R2220101VXC)

95.20 DHL Dead Time Small 50		
Test Site	DAL-FL	DAL-FL
Tester	ETS364	ETS364
Test Number	EB672302	EB672302
Unit	nsec	
Max Limit	15	15
Min Limit	6	6

krad(Si)	Serial #	pre_short (rtp)	(2)ST_Combo (rpt)	Delta
0	Ctrl	9.445	9.445	0.000
3	58	10.152	9.569	-0.583
3	59	10.111	9.767	-0.344
3	60	9.978	9.515	-0.463
3	61	9.597	9.006	-0.591
3	62	9.781	9.115	-0.666
3	134	9.920	9.618	-0.302
3	137	9.611	9.510	-0.102
3	138	9.548	9.632	0.083
3	139	9.842	9.634	-0.208
3	236	9.372	9.852	0.480
10	63	10.428	10.036	-0.392
10	64	9.862	9.560	-0.302
10	65	9.821	9.491	-0.330
10	66	9.363	8.880	-0.484
10	150	10.123	10.026	-0.097
10	237	10.142	9.913	-0.229
10	241	9.924	9.505	-0.419
10	242	9.994	9.572	-0.422
10	243	9.254	9.027	-0.227
10	244	9.642	9.338	-0.304
30	141	9.467	9.204	-0.263
30	144	9.741	9.502	-0.239
30	145	9.621	9.160	-0.461
30	146	9.700	9.403	-0.296
30	147	10.137	9.736	-0.401
30	132	9.663	9.496	-0.167
30	133	10.117	9.953	-0.164
30	135	10.220	8.663	-1.557
30	245	9.404	9.175	-0.229
30	246	9.772	9.675	-0.096
50	67	10.458	9.980	-0.479
50	68	9.478	9.313	-0.165
50	69	10.186	9.566	-0.620
50	71	9.158	8.328	-0.830
50	72	9.896	9.324	-0.572
50	172	9.538	9.039	-0.499
50	173	9.809	9.561	-0.247
50	174	9.903	9.310	-0.593
50	183	10.091	9.925	-0.167
50	186	9.287	8.930	-0.357
100	95	10.102	9.249	-0.853
100	102	9.842	9.208	-0.634
100	104	10.279	9.486	-0.793
100	105	9.948	8.852	-1.097
100	106	9.728	9.391	-0.337
100	178	9.950	9.642	-0.307
100	179	9.700	9.422	-0.278
100	180	10.026	9.753	-0.272
100	181	9.934	9.438	-0.496
100	182	9.167	8.846	-0.321
	Max	10.458	10.036	0.480
	Average	9.808	9.422	-0.386
	Min	9.158	8.328	-1.557
	Std Dev	0.317	0.362	0.305

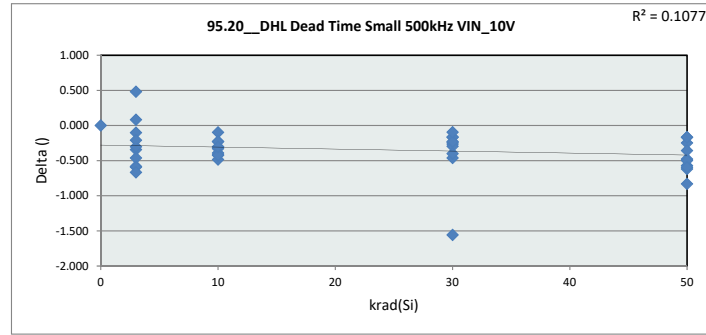

95.20 DHL Dead Time Small 500kHz VIN_10V

95.20 DHL Dead Time Small 500kHz VIN_10V	
Test Site	DAL-FL
Tester	ETS364
Test Number	EB672302
Max Limit	15
Min Limit	6

krad(Si)	0	3	10	30	50	100
LL	6.000	6.000	6.000	6.000	6.000	6.000
Min	9.445	9.006	8.880	8.663	8.328	8.846
Average	9.445	9.522	9.535	9.397	9.328	9.329
Max	9.445	9.853	10.036	9.953	9.980	9.753
UL	15.000	15.000	15.000	15.000	15.000	15.000

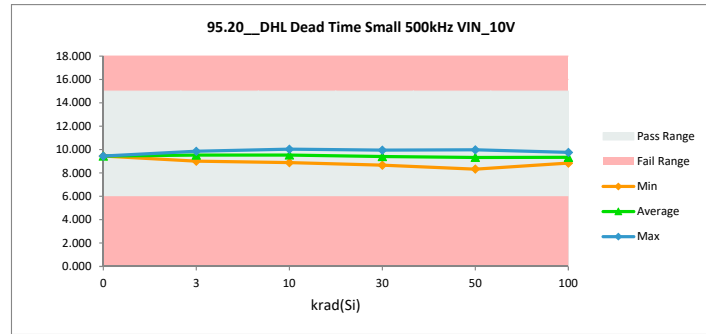

TID HDR Report
TPS7H6003-SP (5962R2220101VXC)

95.21 DHL Dead Time Mid 500kHz		
Test Site	DAL-FL	DAL-FL
Tester	ETS364	ETS364
Test Number	EB672302	EB672302
Unit	nsec	
Max Limit	24.5	24.5
Min Limit	16	16

krad(Si)	Serial #	pre_short (rtp) (2)	ST_Combo (rpt) (Delta
0	Ctrl	19.681	19.681	0.000
3	58	20.111	19.609	-0.502
3	59	19.847	19.336	-0.512
3	60	19.640	19.224	-0.416
3	61	19.797	19.296	-0.501
3	62	20.200	19.418	-0.781
3	134	20.038	19.383	-0.655
3	137	19.372	19.369	-0.003
3	138	19.676	19.231	-0.444
3	139	19.540	19.188	-0.352
3	236	19.131	19.721	0.590
10	63	20.621	20.197	-0.424
10	64	19.988	19.598	-0.390
10	65	19.664	19.157	-0.507
10	66	19.567	19.132	-0.435
10	150	19.843	19.868	0.025
10	237	20.186	19.743	-0.442
10	241	19.708	19.231	-0.477
10	242	20.219	19.696	-0.522
10	243	19.644	19.409	-0.235
10	244	19.550	19.311	-0.240
30	141	19.193	18.746	-0.448
30	144	19.848	19.210	-0.638
30	145	20.149	19.277	-0.871
30	146	19.764	19.243	-0.521
30	147	19.935	19.195	-0.740
30	132	19.973	19.642	-0.331
30	133	20.227	19.924	-0.303
30	135	20.177	18.982	-1.194
30	245	19.447	18.861	-0.585
30	246	19.518	19.122	-0.396
50	67	20.475	19.604	-0.871
50	68	19.641	19.152	-0.490
50	69	20.203	19.079	-1.123
50	71	19.443	18.279	-1.164
50	72	19.630	18.586	-1.044
50	172	19.452	18.656	-0.795
50	173	19.892	19.417	-0.474
50	174	19.954	19.093	-0.861
50	183	20.035	19.433	-0.602
50	186	19.635	18.801	-0.834
100	95	19.847	18.261	-1.586
100	102	19.947	18.729	-1.218
100	104	20.230	18.782	-1.448
100	105	20.280	18.565	-1.715
100	106	19.956	18.908	-1.048
100	178	20.002	18.988	-1.014
100	179	19.760	18.925	-0.835
100	180	20.087	19.071	-1.016
100	181	19.961	18.537	-1.424
100	182	19.303	18.444	-0.859
Max		20.621	20.197	0.590
Average		19.843	19.183	-0.660
Min		19.131	18.261	-1.715
Std Dev		0.321	0.424	0.432

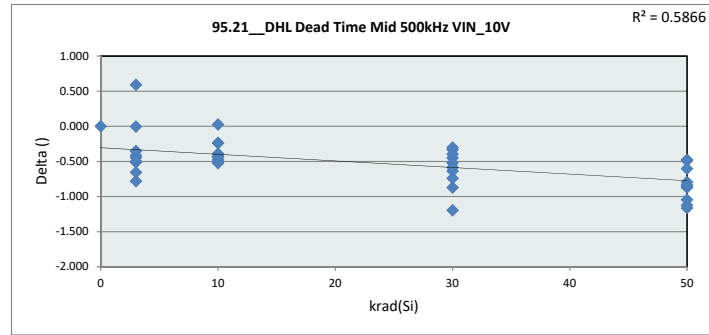

95.21 DHL Dead Time	
Test Site	DAL-FL
Tester	ETS364
Test Number	EB672302
Max Limit	24.5
Min Limit	16

krad(Si)	0	3	10	30	50	100
LL	16.000	16.000	16.000	16.000	16.000	16.000
Min	19.681	19.188	19.132	18.746	18.279	18.261
Average	19.681	19.377	19.534	19.220	19.010	18.721
Max	19.681	19.721	20.197	19.924	19.604	19.071
UL	24.500	24.500	24.500	24.500	24.500	24.500

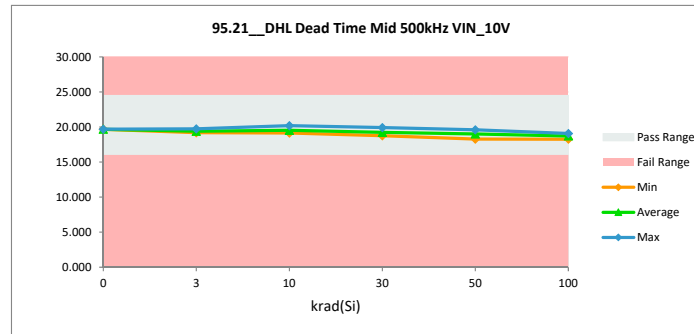

TID HDR Report
TPS7H6003-SP (5962R2220101VXC)

95.22 DHL Dead Time Large 50		
Test Site	DAL-FL	DAL-FL
Tester	ETS364	ETS364
Test Number	EB672302	EB672302
Unit	nsec	
Max Limit	61	61
Min Limit	44	44

krad(Si)	Serial #	pre_short (rtp) (2)	ST_Combo (rpt) (Delta
0	Ctrl	50.828	50.828	0.000
3	58	50.627	50.034	-0.593
3	59	49.081	48.541	-0.540
3	60	49.146	48.689	-0.458
3	61	51.139	50.487	-0.652
3	62	52.187	51.518	-0.668
3	134	50.615	49.101	-1.514
3	137	49.022	49.142	0.119
3	138	50.685	49.145	-1.540
3	139	49.482	49.103	-0.379
3	236	48.714	49.794	1.081
10	63	51.897	51.093	-0.804
10	64	51.275	50.730	-0.545
10	65	49.503	48.891	-0.612
10	66	50.871	50.094	-0.777
10	150	49.337	48.980	-0.357
10	237	50.657	49.795	-0.861
10	241	49.494	49.032	-0.462
10	242	50.887	50.429	-0.458
10	243	51.293	50.890	-0.402
10	244	50.030	49.527	-0.503
30	141	49.038	47.614	-1.424
30	144	50.883	49.610	-1.273
30	145	51.950	50.368	-1.582
30	146	50.600	49.470	-1.130
30	147	49.809	48.475	-1.334
30	132	51.461	50.546	-0.916
30	133	51.317	50.316	-1.001
30	135	50.541	49.772	-0.769
30	245	49.942	48.810	-1.132
30	246	49.071	48.107	-0.964
50	67	51.162	49.077	-2.086
50	68	50.524	49.322	-1.202
50	69	50.684	48.420	-2.264
50	71	50.977	48.598	-2.379
50	72	49.477	47.022	-2.455
50	172	49.513	47.492	-2.021
50	173	50.829	49.193	-1.636
50	174	50.804	48.527	-2.277
50	183	50.507	48.415	-2.092
50	186	51.416	49.338	-2.078
100	95	49.564	45.184	-4.380
100	102	50.673	46.956	-3.716
100	104	50.663	46.938	-3.725
100	105	52.195	48.109	-4.086
100	106	51.083	47.532	-3.551
100	178	50.455	47.270	-3.185
100	179	50.549	47.478	-3.071
100	180	51.068	47.681	-3.387
100	181	50.549	46.904	-3.646
100	182	50.256	47.077	-3.179
Max		52.195	51.518	1.081
Average		50.477	48.931	-1.546
Min		48.714	45.184	-4.380
Std Dev		0.870	1.324	1.242

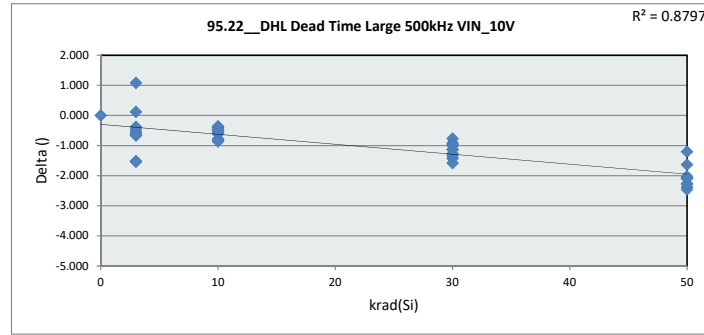

95.22 DHL Dead Ti	
Test Site	DAL-FL
Tester	ETS364
Test Number	EB672302
Max Limit	61
Min Limit	44

krad(Si)	0	3	10	30	50	100
LL	44.000	44.000	44.000	44.000	44.000	44.000
Min	50.828	48.541	48.891	47.614	47.022	45.184
Average	50.828	49.555	49.946	49.309	48.540	47.113
Max	50.828	51.518	51.093	50.546	49.338	48.109
UL	61.000	61.000	61.000	61.000	61.000	61.000

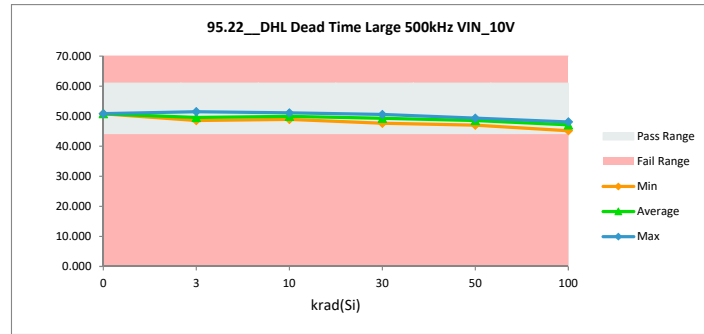

TID HDR Report

TPS7H6003-SP (5962R2220101VXC)

95.23 DHL Dead Time Max 500		
Test Site	DAL-FL	DAL-FL
Tester	ETS364	ETS364
Test Number	EB672302	EB672302
Unit	nsec	
Max Limit	125	
Min Limit	86	

krad(Si)	Serial #	pre_short (rtp)	(2)'ST_Combo (rpt)	Delta
0	Ctrl	99.754	99.754	0.000
3	58	98.378	97.771	-0.607
3	59	94.958	94.482	-0.477
3	60	95.744	95.353	-0.392
3	61	100.467	99.808	-0.660
3	62	102.719	102.023	-0.696
3	134	99.237	96.616	-2.621
3	137	96.255	96.620	0.366
3	138	99.902	96.485	-3.416
3	139	97.025	96.477	-0.548
3	236	95.358	97.394	2.036
10	63	100.995	100.015	-0.979
10	64	100.989	100.174	-0.815
10	65	96.761	95.796	-0.964
10	66	99.852	98.941	-0.911
10	150	95.493	94.971	-0.522
10	237	98.911	97.332	-1.579
10	241	96.676	96.576	-0.100
10	242	99.377	98.490	-0.887
10	243	101.195	100.457	-0.737
10	244	98.408	97.343	-1.065
30	141	95.913	93.398	-2.515
30	144	100.112	97.329	-2.783
30	145	102.299	99.576	-2.723
30	146	99.402	97.001	-2.401
30	147	97.197	94.738	-2.459
30	132	101.408	99.566	-1.842
30	133	100.803	98.765	-2.039
30	135	98.474	98.575	0.101
30	245	97.906	95.670	-2.236
30	246	95.789	94.005	-1.784
50	67	99.696	95.779	-3.917
50	68	99.325	97.715	-1.611
50	69	98.646	94.037	-4.609
50	71	100.603	96.166	-4.437
50	72	96.370	91.570	-4.800
50	172	96.807	92.719	-4.088
50	173	99.761	96.374	-3.387
50	174	99.501	94.959	-4.542
50	183	98.678	94.258	-4.421
50	186	101.959	97.450	-4.509
100	95	96.729	88.213	-8.516
100	102	99.267	91.651	-7.615
100	104	98.673	91.495	-7.178
100	105	102.758	95.263	-7.495
100	106	100.200	92.762	-7.438
100	178	98.625	91.625	-7.000
100	179	99.069	92.550	-6.520
100	180	99.958	92.603	-7.355
100	181	98.855	91.122	-7.732
100	182	99.048	92.116	-6.932
Max		102.758	102.023	2.036
Average		98.868	95.920	-2.948
Min		94.958	88.213	-8.516
Std Dev		1.989	2.959	2.671

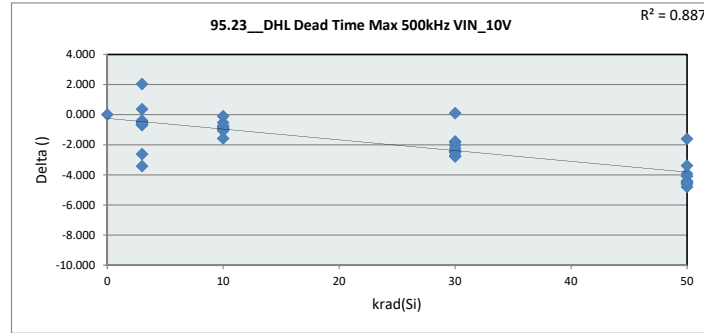

95.23 DHL Dead Time						
Test Site	DAL-FL					
Tester	ETS364					
Test Number	EB672302					
Max Limit	125					
Min Limit	86					
krad(Si)	0	3	10	30	50	100
LL	86.000	86.000	86.000	86.000	86.000	86.000
Min	99.754	94.482	94.971	93.398	91.570	88.213
Average	99.754	97.303	98.010	96.862	95.103	91.940
Max	99.754	102.023	100.457	99.576	97.715	95.263
UL	125.000	125.000	125.000	125.000	125.000	125.000

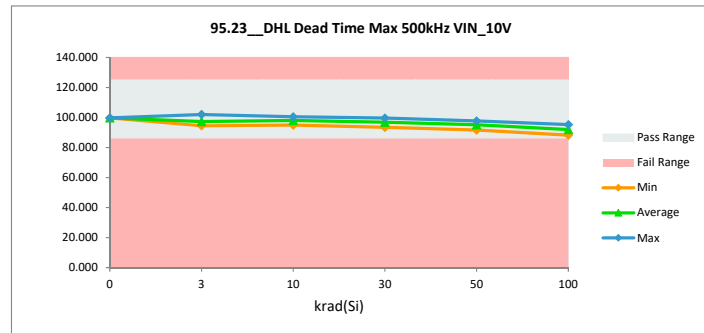

TID HDR Report
TPS7H6003-SP (5962R2220101VXC)

95.24 DHL Dead Time Min 1MHz		
Test Site	DAL-FL	DAL-FL
Tester	ETS364	ETS364
Test Number	EB672302	EB672302
Unit	nsec	
Max Limit	10	10
Min Limit	0	0

krad(Si)	Serial #	pre_short (rtp)	(2)ST_Combo (rpt)	Delta
0	Ctrl	4.233	4.233	0.000
3	58	4.865	4.263	-0.602
3	59	5.059	4.550	-0.509
3	60	4.998	4.466	-0.532
3	61	4.250	3.667	-0.583
3	62	4.217	3.546	-0.672
3	134	4.637	4.303	-0.334
3	137	4.589	4.325	-0.263
3	138	4.203	4.365	0.162
3	139	4.878	4.408	-0.471
3	236	4.333	4.536	0.202
10	63	5.099	4.698	-0.400
10	64	4.540	4.077	-0.463
10	65	4.723	4.260	-0.463
10	66	3.866	3.658	-0.208
10	150	5.099	5.032	-0.067
10	237	4.852	4.678	-0.174
10	241	4.889	4.486	-0.403
10	242	4.654	4.272	-0.382
10	243	3.713	3.749	0.036
10	244	4.415	4.117	-0.298
30	141	4.516	4.409	-0.107
30	144	4.479	4.152	-0.328
30	145	4.249	3.733	-0.516
30	146	4.329	4.128	-0.201
30	147	4.976	4.904	-0.073
30	132	4.150	4.054	-0.097
30	133	4.727	4.802	0.075
30	135	4.883	3.499	-1.385
30	245	4.142	4.126	-0.016
30	246	4.727	4.525	-0.202
50	67	5.113	4.883	-0.230
50	68	4.084	4.107	0.023
50	69	4.867	4.456	-0.411
50	71	3.596	3.019	-0.577
50	72	4.830	4.395	-0.436
50	172	4.422	4.259	-0.163
50	173	4.328	4.461	0.133
50	174	4.577	4.259	-0.319
50	183	4.848	4.896	0.048
50	186	3.830	3.814	-0.016
100	95	5.097	4.642	-0.455
100	102	4.477	4.624	0.147
100	104	5.027	4.696	-0.331
100	105	4.455	3.826	-0.629
100	106	4.424	4.336	-0.088
100	178	4.629	4.715	0.087
100	179	4.297	4.538	0.241
100	180	4.707	4.738	0.032
100	181	4.541	4.701	0.160
100	182	3.772	3.941	0.169
	Max	5.113	5.032	0.241
	Average	4.534	4.301	-0.233
	Min	3.596	3.019	-1.385
	Std Dev	0.389	0.414	0.304

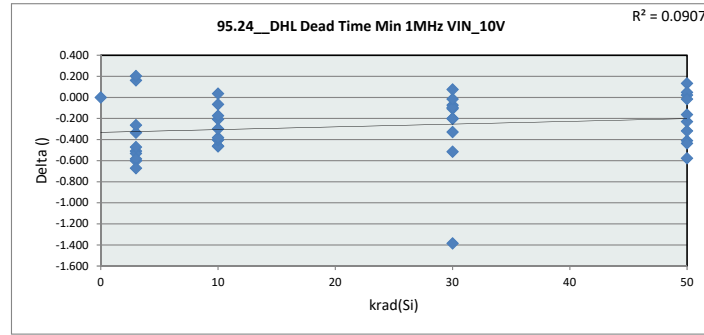

95.24 DHL Dead Time	
Test Site	DAL-FL
Tester	ETS364
Test Number	EB672302
Max Limit	10
Min Limit	0

krad(Si)	0	3	10	30	50	100
LL	0.000	0.000	0.000	0.000	0.000	0.000
Min	4.233	3.546	3.658	3.499	3.019	3.826
Average	4.233	4.243	4.303	4.233	4.255	4.476
Max	4.233	4.550	5.032	4.904	4.896	4.738
UL	10.000	10.000	10.000	10.000	10.000	10.000

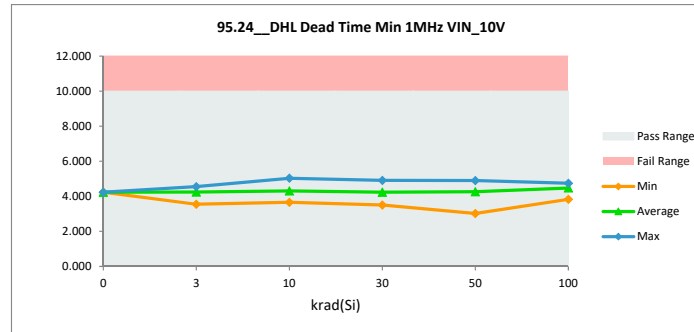

TID HDR Report
TPS7H6003-SP (5962R2220101VXC)

95.25 DHL Dead Time Small 1MHz		
Test Site	DAL-FL	DAL-FL
Tester	ETS364	ETS364
Test Number	EB672302	EB672302
Unit	nsec	
Max Limit	15	15
Min Limit	6	6

krad(Si)	Serial #	pre_short (rtp) (2)	ST_Combo (rpt) (Delta
0	Ctrl	9.773	9.773	0.000
3	58	10.380	9.922	-0.457
3	59	10.369	9.965	-0.405
3	60	10.253	9.731	-0.523
3	61	9.860	9.374	-0.486
3	62	10.015	9.431	-0.583
3	134	10.150	9.775	-0.375
3	137	9.873	9.804	-0.069
3	138	9.862	9.791	-0.071
3	139	10.062	9.738	-0.324
3	236	9.720	10.105	0.385
10	63	10.743	10.338	-0.406
10	64	10.167	9.824	-0.343
10	65	10.083	9.714	-0.369
10	66	9.642	9.228	-0.414
10	150	10.435	10.169	-0.266
10	237	10.383	9.999	-0.384
10	241	10.153	9.772	-0.381
10	242	10.305	9.929	-0.376
10	243	9.538	9.350	-0.188
10	244	9.948	9.759	-0.189
30	141	9.792	9.477	-0.314
30	144	10.025	9.677	-0.348
30	145	9.915	9.333	-0.582
30	146	9.907	9.704	-0.203
30	147	10.390	9.953	-0.437
30	132	9.894	9.808	-0.086
30	133	10.402	10.170	-0.233
30	135	10.423	9.088	-1.335
30	245	9.811	9.414	-0.396
30	246	9.985	9.897	-0.088
50	67	10.716	10.124	-0.591
50	68	9.699	9.527	-0.172
50	69	10.413	9.814	-0.598
50	71	9.337	8.485	-0.851
50	72	10.168	9.425	-0.743
50	172	9.840	9.270	-0.570
50	173	10.043	9.790	-0.253
50	174	10.182	9.530	-0.652
50	183	10.321	10.133	-0.188
50	186	9.573	9.308	-0.265
100	95	10.362	9.473	-0.889
100	102	10.042	9.345	-0.697
100	104	10.564	9.676	-0.888
100	105	10.237	9.004	-1.233
100	106	10.068	9.592	-0.477
100	178	10.175	9.912	-0.263
100	179	9.957	9.496	-0.461
100	180	10.310	9.906	-0.404
100	181	10.084	9.682	-0.402
100	182	9.449	9.048	-0.401
	Max	10.743	10.338	0.385
	Average	10.074	9.658	-0.417
	Min	9.337	8.485	-1.335
	Std Dev	0.310	0.349	0.292

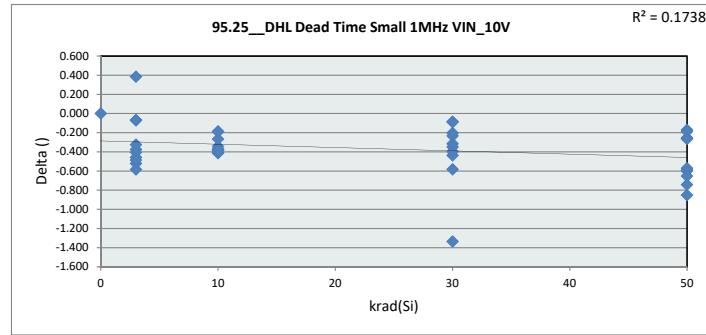

95.25 DHL Dead Time Small 1MHz VIN_10V

95.25 DHL Dead Time Small 1MHz VIN_10V	
Test Site	DAL-FL
Tester	ETS364
Test Number	EB672302
Max Limit	15
Min Limit	6

krad(Si)	0	3	10	30	50	100
LL	6.000	6.000	6.000	6.000	6.000	6.000
Min	9.773	9.374	9.228	9.088	8.485	9.004
Average	9.773	9.764	9.808	9.652	9.541	9.513
Max	9.773	10.105	10.338	10.170	10.133	9.912
UL	15.000	15.000	15.000	15.000	15.000	15.000

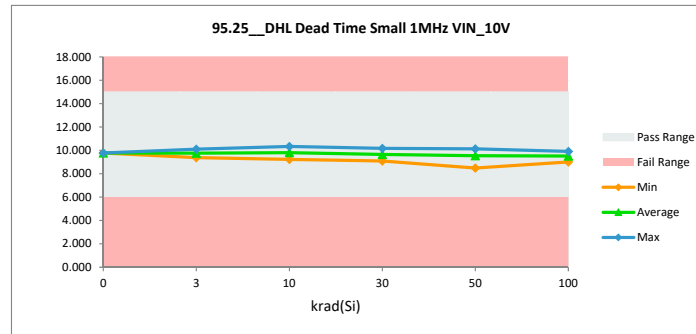

TID HDR Report
TPS7H6003-SP (5962R2220101VXC)

95.26 DHL Dead Time Mid 1MHz		
Test Site	DAL-FL	DAL-FL
Tester	ETS364	ETS364
Test Number	EB672302	EB672302
Unit	nsec	
Max Limit	24.5	24.5
Min Limit	16	16

krad(Si)	Serial #	pre_short (rtp)	(2)ST_Combo (rpt)	Delta
0	Ctrl	19.999	19.999	0.000
3	58	20.536	19.993	-0.543
3	59	20.129	19.663	-0.466
3	60	19.881	19.523	-0.358
3	61	20.245	19.605	-0.639
3	62	20.427	19.784	-0.642
3	134	20.327	19.544	-0.783
3	137	19.636	19.716	0.080
3	138	20.035	19.573	-0.463
3	139	19.875	19.532	-0.343
3	236	19.395	19.976	0.581
10	63	20.997	20.478	-0.519
10	64	20.438	19.943	-0.496
10	65	19.937	19.584	-0.353
10	66	19.939	19.378	-0.561
10	150	20.231	20.098	-0.133
10	237	20.491	19.955	-0.536
10	241	19.961	19.635	-0.326
10	242	20.409	19.980	-0.429
10	243	19.986	19.714	-0.272
10	244	19.925	19.587	-0.338
30	141	19.500	19.134	-0.367
30	144	20.224	19.576	-0.648
30	145	20.464	19.438	-1.026
30	146	20.045	19.616	-0.429
30	147	20.221	19.656	-0.565
30	132	20.272	19.965	-0.307
30	133	20.599	20.149	-0.450
30	135	20.522	19.229	-1.293
30	245	19.808	19.277	-0.531
30	246	19.779	19.388	-0.391
50	67	20.877	19.869	-1.007
50	68	19.912	19.360	-0.553
50	69	20.618	19.294	-1.325
50	71	19.810	18.369	-1.440
50	72	19.906	18.823	-1.083
50	172	19.769	18.885	-0.884
50	173	20.231	19.700	-0.531
50	174	20.309	19.259	-1.050
50	183	20.343	19.710	-0.633
50	186	20.065	19.236	-0.829
100	95	20.250	18.546	-1.704
100	102	20.150	18.948	-1.203
100	104	20.578	18.960	-1.618
100	105	20.646	18.860	-1.786
100	106	20.270	19.105	-1.165
100	178	20.272	19.355	-0.918
100	179	20.079	19.121	-0.958
100	180	20.452	19.335	-1.116
100	181	20.277	18.999	-1.278
100	182	19.609	18.682	-0.927
	Max	20.997	20.478	0.581
	Average	20.170	19.473	-0.697
	Min	19.395	18.369	-1.786
	Std Dev	0.337	0.437	0.465

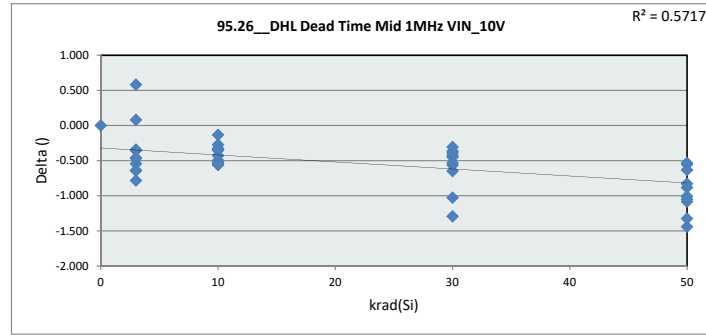

95.26 DHL Dead Time		
Test Site	DAL-FL	
Tester	ETS364	
Test Number	EB672302	
Max Limit	24.5	
Min Limit	16	

krad(Si)	0	3	10	30	50	100
LL	16.000	16.000	16.000	16.000	16.000	16.000
Min	19.999	19.523	19.378	19.134	18.370	18.546
Average	19.999	19.691	19.835	19.543	19.250	18.991
Max	19.999	19.993	20.478	20.149	19.870	19.355
UL	24.500	24.500	24.500	24.500	24.500	24.500

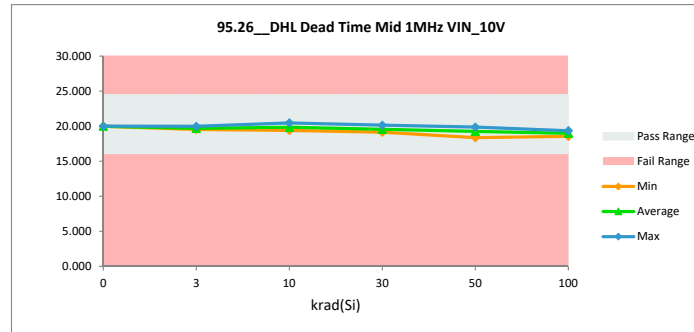

TID HDR Report
TPS7H6003-SP (5962R2220101VXC)

95.27 DHL Dead Time Large 1MHz		
Test Site	DAL-FL	DAL-FL
Tester	ETS364	ETS364
Test Number	EB672302	EB672302
Unit	nsec	
Max Limit	61	61
Min Limit	44	44

krad(Si)	Serial #	pre_short (rtp) (2)	ST_Combo (rpt) (Delta
0	Ctrl	51.524	51.524	0.000
3	58	51.222	50.588	-0.634
3	59	49.717	49.165	-0.551
3	60	49.695	49.097	-0.597
3	61	51.725	51.071	-0.654
3	62	52.813	52.104	-0.710
3	134	51.272	49.639	-1.633
3	137	49.674	49.699	0.025
3	138	51.382	49.656	-1.726
3	139	50.036	49.601	-0.435
3	236	49.384	50.212	0.828
10	63	52.415	51.727	-0.688
10	64	51.982	51.301	-0.681
10	65	50.204	49.464	-0.740
10	66	51.451	50.620	-0.831
10	150	49.927	49.509	-0.418
10	237	51.282	50.385	-0.896
10	241	50.068	49.590	-0.478
10	242	51.548	50.618	-0.931
10	243	51.927	51.595	-0.332
10	244	50.653	49.996	-0.657
30	141	49.520	48.105	-1.415
30	144	51.591	50.026	-1.564
30	145	52.636	50.834	-1.802
30	146	51.206	49.921	-1.286
30	147	50.363	49.019	-1.344
30	132	52.177	51.032	-1.145
30	133	51.919	50.756	-1.164
30	135	51.113	50.277	-0.836
30	245	50.609	49.316	-1.293
30	246	49.649	48.628	-1.021
50	67	51.815	49.646	-2.169
50	68	51.222	49.810	-1.412
50	69	51.327	48.812	-2.516
50	71	51.742	48.992	-2.750
50	72	50.011	47.380	-2.632
50	172	50.192	47.954	-2.237
50	173	51.429	49.602	-1.826
50	174	51.306	48.953	-2.354
50	183	51.080	48.936	-2.145
50	186	52.033	49.739	-2.294
100	95	50.134	45.619	-4.515
100	102	51.335	47.345	-3.990
100	104	51.165	47.296	-3.869
100	105	52.843	48.575	-4.268
100	106	51.646	47.985	-3.661
100	178	50.941	47.649	-3.292
100	179	51.218	47.876	-3.343
100	180	51.613	47.975	-3.638
100	181	51.120	47.200	-3.920
100	182	50.951	47.480	-3.471
Max		52.843	52.104	0.828
Average		51.094	49.410	-1.684
Min		49.384	45.619	-4.515
Std Dev		0.885	1.377	1.286

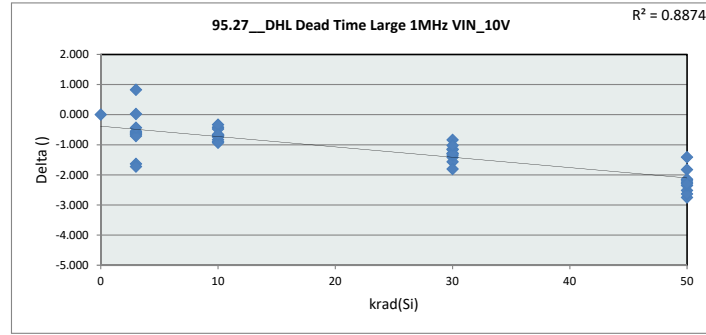

95.27 DHL Dead Time Large 1MHz VIN_10V						
Test Site	DAL-FL					
Tester	ETS364					
Test Number	EB672302					
Max Limit	61					
Min Limit	44					
krad(Si)	0	3	10	30	50	100
LL	44.000	44.000	44.000	44.000	44.000	44.000
Min	51.524	49.097	49.464	48.105	47.380	45.619
Average	51.524	50.083	50.481	49.791	48.982	47.500
Max	51.524	52.104	51.727	51.032	49.810	48.575
UL	61.000	61.000	61.000	61.000	61.000	61.000

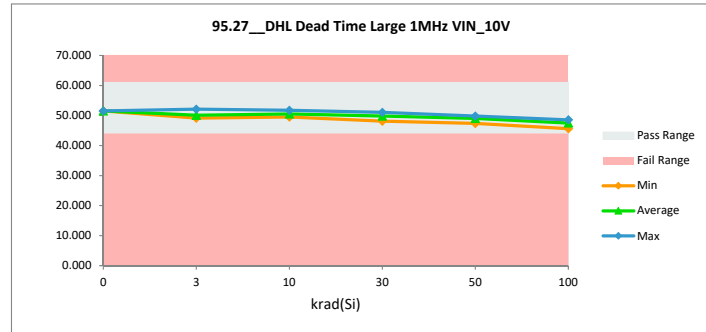

TID HDR Report
TPS7H6003-SP (5962R2220101VXC)

95.28 DHL Dead Time Max 1MHz		
Test Site	DAL-FL	DAL-FL
Tester	ETS364	ETS364
Test Number	EB672302	EB672302
Unit	nsec	
Max Limit	125	
Min Limit	86	

krad(Si)	Serial #	pre_short (rtp)	(2)'ST_Combo (rpt)	Delta
0	Ctrl	101.243	101.243	0.000
3	58	99.916	99.104	-0.812
3	59	96.606	96.020	-0.587
3	60	97.348	96.887	-0.461
3	61	102.127	101.306	-0.821
3	62	104.441	103.573	-0.868
3	134	100.854	97.910	-2.944
3	137	97.769	97.942	0.172
3	138	101.608	97.923	-3.685
3	139	98.632	98.078	-0.553
3	236	96.929	98.799	1.869
10	63	102.547	101.329	-1.218
10	64	102.673	101.821	-0.852
10	65	98.408	97.195	-1.212
10	66	101.501	100.206	-1.295
10	150	96.934	96.365	-0.569
10	237	100.507	98.823	-1.684
10	241	98.189	97.991	-0.198
10	242	100.953	99.856	-1.097
10	243	102.901	102.036	-0.865
10	244	99.947	98.711	-1.236
30	141	97.563	94.833	-2.729
30	144	101.831	98.782	-3.049
30	145	104.042	101.012	-3.030
30	146	100.921	98.358	-2.562
30	147	98.717	96.080	-2.637
30	132	103.042	101.006	-2.036
30	133	102.427	100.119	-2.308
30	135	100.000	99.988	-0.012
30	245	99.587	97.242	-2.345
30	246	97.417	95.348	-2.069
50	67	101.357	97.072	-4.286
50	68	100.957	99.176	-1.781
50	69	100.281	95.220	-5.061
50	71	102.329	97.619	-4.710
50	72	97.903	92.499	-5.404
50	172	98.354	93.805	-4.549
50	173	101.341	97.520	-3.822
50	174	101.132	96.202	-4.930
50	183	100.254	95.310	-4.944
50	186	103.579	98.940	-4.639
100	95	98.161	89.048	-9.113
100	102	100.974	92.603	-8.371
100	104	100.099	92.387	-7.713
100	105	104.574	96.376	-8.198
100	106	101.847	93.823	-8.024
100	178	100.231	92.764	-7.468
100	179	100.743	93.478	-7.265
100	180	101.529	93.601	-7.928
100	181	100.521	92.041	-8.480
100	182	100.695	93.113	-7.582
Max		104.574	103.573	1.869
Average		100.479	97.225	-3.254
Min		96.606	89.048	-9.113
Std Dev		2.033	3.128	2.858

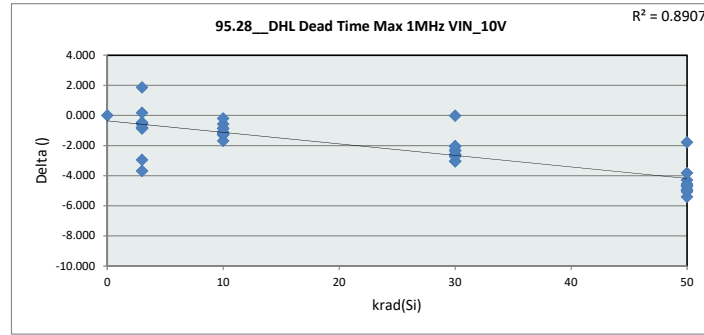

95.28 DHL Dead Time

Test Site	DAL-FL
Tester	ETS364
Test Number	EB672302
Max Limit	125
Min Limit	86

krad(Si)	0	3	10	30	50	100
LL	86.000	86.000	86.000	86.000	86.000	86.000
Min	101.243	96.020	96.365	94.833	92.499	89.048
Average	101.243	98.754	99.433	98.277	96.336	92.923
Max	101.243	103.573	102.036	101.012	99.176	96.376
UL	125.000	125.000	125.000	125.000	125.000	125.000

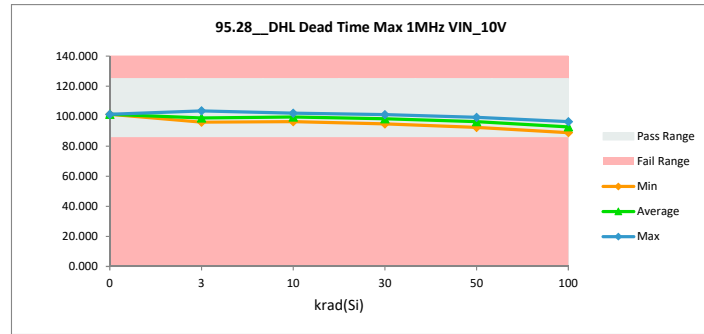

TID HDR Report
TPS7H6003-SP (5962R2220101VXC)

95.29 DHL Dead Time Min 2MHz		
Test Site	DAL-FL	DAL-FL
Tester	ETS364	ETS364
Test Number	EB672302	EB672302
Unit	nsec	
Max Limit	10	10
Min Limit	0	0

krad(Si)	Serial #	pre_short (rtp)	(2)ST_Combo (rpt)	Delta
0	Ctrl	4.389	4.389	0.000
3	58	4.994	4.329	-0.665
3	59	5.156	4.702	-0.454
3	60	5.006	4.688	-0.318
3	61	4.391	3.835	-0.556
3	62	4.412	3.764	-0.648
3	134	4.823	4.735	-0.089
3	137	4.731	4.564	-0.166
3	138	4.514	4.488	-0.025
3	139	4.974	4.540	-0.434
3	236	4.461	4.717	0.256
10	63	5.330	4.832	-0.498
10	64	4.603	4.319	-0.284
10	65	4.950	4.476	-0.474
10	66	4.035	3.590	-0.444
10	150	5.291	5.326	0.035
10	237	5.046	4.733	-0.313
10	241	5.018	4.555	-0.464
10	242	4.916	4.490	-0.426
10	243	4.025	3.850	-0.175
10	244	4.637	4.371	-0.266
30	141	4.642	4.634	-0.008
30	144	4.537	4.661	0.124
30	145	4.426	4.016	-0.410
30	146	4.444	4.382	-0.062
30	147	5.029	5.021	-0.008
30	132	4.247	4.210	-0.036
30	133	4.977	5.044	0.067
30	135	5.051	3.772	-1.279
30	245	4.284	4.240	-0.044
30	246	4.922	4.936	0.014
50	67	5.136	4.782	-0.354
50	68	4.336	4.218	-0.119
50	69	4.978	4.707	-0.271
50	71	3.941	3.247	-0.695
50	72	5.045	4.477	-0.568
50	172	4.688	4.381	-0.307
50	173	4.466	4.679	0.213
50	174	4.746	4.389	-0.358
50	183	4.865	4.931	0.066
50	186	3.970	3.906	-0.064
100	95	5.134	4.866	-0.267
100	102	4.730	4.593	-0.137
100	104	5.181	4.982	-0.199
100	105	4.679	3.942	-0.737
100	106	4.505	4.478	-0.027
100	178	4.872	5.096	0.224
100	179	4.396	4.715	0.319
100	180	4.767	5.119	0.352
100	181	4.756	4.524	-0.232
100	182	3.980	4.169	0.189
Max		5.330	5.326	0.352
Average		4.695	4.479	-0.216
Min		3.941	3.247	-1.279
Std Dev		0.362	0.425	0.313

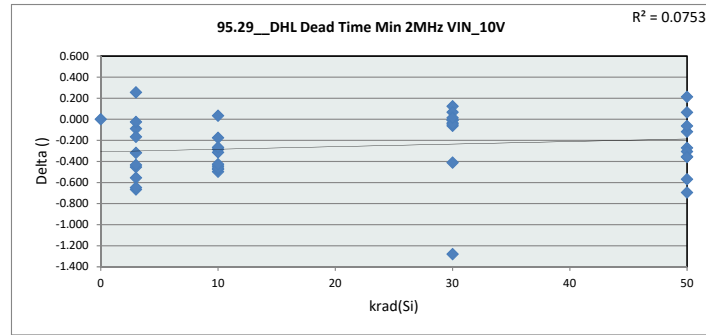

95.29 DHL Dead Time	
Test Site	DAL-FL
Tester	ETS364
Test Number	EB672302
Max Limit	10
Min Limit	0

krad(Si)	0	3	10	30	50	100
LL	0.000	0.000	0.000	0.000	0.000	0.000
Min	4.389	3.764	3.590	3.772	3.247	3.942
Average	4.389	4.436	4.454	4.492	4.372	4.649
Max	4.389	4.735	5.326	5.044	4.931	5.119
UL	10.000	10.000	10.000	10.000	10.000	10.000

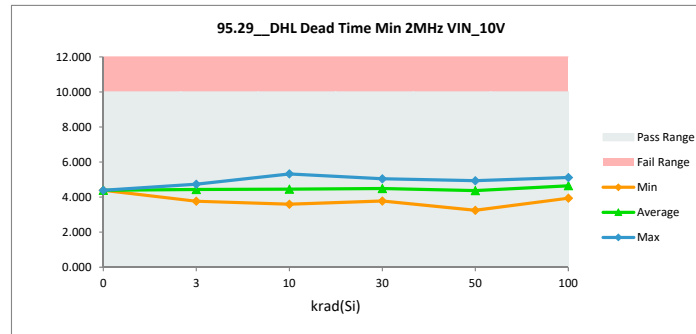

TID HDR Report

TPS7H6003-SP (5962R2220101VXC)

95.30 DHL Dead Time Small 2MHz		
Test Site	DAL-FL	DAL-FL
Tester	ETS364	ETS364
Test Number	EB672302	EB672302
Unit	nsec	
Max Limit	15	15
Min Limit	6	6

krad(Si)	Serial #	pre_short (rtp) (2)	ST_Combo (rpt) (Delta
0	Ctrl	9.911	9.911	0.000
3	58	10.488	9.941	-0.547
3	59	10.537	10.157	-0.380
3	60	10.174	9.851	-0.323
3	61	9.933	9.509	-0.423
3	62	10.105	9.641	-0.464
3	134	10.182	10.012	-0.170
3	137	9.952	9.919	-0.033
3	138	9.970	9.850	-0.120
3	139	10.042	9.928	-0.114
3	236	9.783	10.297	0.514
10	63	10.861	10.449	-0.412
10	64	10.283	10.039	-0.244
10	65	10.172	9.739	-0.433
10	66	9.663	9.366	-0.297
10	150	10.398	10.557	0.158
10	237	10.599	10.192	-0.407
10	241	10.159	9.832	-0.328
10	242	10.333	10.051	-0.282
10	243	9.618	9.429	-0.188
10	244	9.964	9.678	-0.285
30	141	9.744	9.503	-0.240
30	144	10.063	9.892	-0.171
30	145	10.011	9.317	-0.694
30	146	10.053	9.697	-0.355
30	147	10.481	10.106	-0.374
30	132	9.932	9.809	-0.123
30	133	10.390	10.245	-0.145
30	135	10.414	9.484	-0.929
30	245	9.792	9.503	-0.289
30	246	10.012	9.967	-0.046
50	67	10.706	10.194	-0.512
50	68	9.825	9.638	-0.186
50	69	10.504	9.800	-0.704
50	71	9.574	8.638	-0.936
50	72	10.264	9.612	-0.653
50	172	9.991	9.356	-0.636
50	173	10.096	9.826	-0.270
50	174	10.224	9.649	-0.575
50	183	10.306	10.205	-0.101
50	186	9.727	9.320	-0.406
100	95	10.458	9.368	-1.089
100	102	10.274	9.611	-0.663
100	104	10.640	9.737	-0.903
100	105	10.309	9.097	-1.212
100	106	10.060	9.666	-0.394
100	178	10.269	10.067	-0.202
100	179	10.087	9.726	-0.360
100	180	10.302	10.004	-0.298
100	181	10.164	9.577	-0.587
100	182	9.565	9.065	-0.500
	Max	10.861	10.557	0.514
	Average	10.144	9.765	-0.379
	Min	9.565	8.638	-1.212
	Std Dev	0.300	0.364	0.308

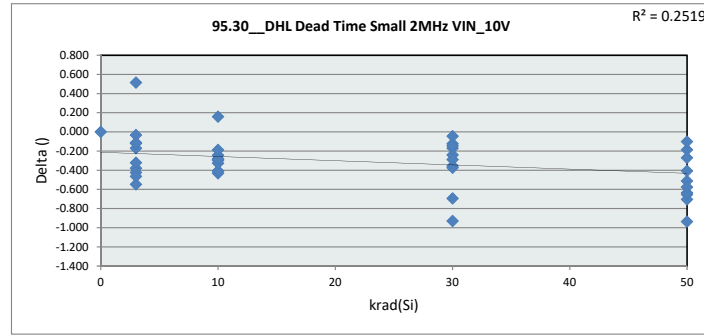

95.30 DHL Dead Time Small 2MHz VIN_10V						
Test Site	DAL-FL					
Tester	ETS364					
Test Number	EB672302					
Max Limit	15					
Min Limit	6					
krad(Si)	0	3	10	30	50	100
LL	6.000	6.000	6.000	6.000	6.000	6.000
Min	9.911	9.509	9.366	9.317	8.638	9.065
Average	9.911	9.911	9.933	9.752	9.624	9.592
Max	9.911	10.297	10.557	10.245	10.205	10.067
UL	15.000	15.000	15.000	15.000	15.000	15.000

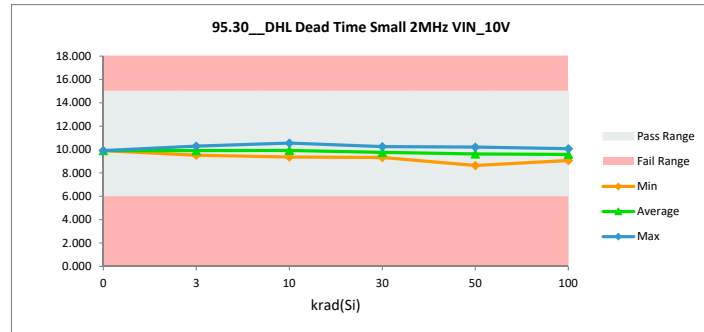

TID HDR Report
TPS7H6003-SP (5962R2220101VXC)

95.31 DHL Dead Time Mid 2MH		
Test Site	DAL-FL	DAL-FL
Tester	ETS364	ETS364
Test Number	EB672302	EB672302
Unit	nsec	
Max Limit	24.5	24.5
Min Limit	16	16

krad(Si)	Serial #	pre_short (rtp) (2)	ST_Combo (rpt) (Delta
0	Ctrl	20.153	20.153	0.000
3	58	20.552	20.197	-0.356
3	59	20.198	19.749	-0.449
3	60	20.021	19.501	-0.520
3	61	20.315	19.674	-0.641
3	62	20.645	20.103	-0.542
3	134	20.391	19.774	-0.618
3	137	19.723	19.844	0.121
3	138	20.185	19.875	-0.310
3	139	19.972	19.633	-0.339
3	236	19.542	20.112	0.570
10	63	21.087	20.689	-0.398
10	64	20.589	20.066	-0.523
10	65	20.040	19.496	-0.545
10	66	19.981	19.474	-0.507
10	150	20.262	20.264	0.002
10	237	20.595	20.101	-0.494
10	241	20.031	19.571	-0.460
10	242	20.519	20.230	-0.289
10	243	19.966	19.777	-0.189
10	244	20.046	19.595	-0.451
30	141	19.692	19.108	-0.584
30	144	20.399	19.792	-0.608
30	145	20.530	19.708	-0.823
30	146	20.164	19.495	-0.669
30	147	20.267	19.718	-0.548
30	132	20.390	20.077	-0.313
30	133	20.594	20.145	-0.449
30	135	20.582	19.499	-1.083
30	245	19.995	19.270	-0.725
30	246	19.804	19.497	-0.307
50	67	20.878	20.080	-0.799
50	68	19.997	19.680	-0.317
50	69	20.567	19.661	-0.906
50	71	19.931	18.590	-1.341
50	72	20.104	19.069	-1.035
50	172	19.859	18.789	-1.070
50	173	20.276	19.782	-0.494
50	174	20.457	19.459	-0.997
50	183	20.323	19.968	-0.355
50	186	20.197	19.403	-0.795
100	95	20.276	18.562	-1.714
100	102	20.338	19.095	-1.243
100	104	20.652	19.074	-1.578
100	105	20.720	18.929	-1.791
100	106	20.313	19.142	-1.172
100	178	20.392	19.386	-1.006
100	179	20.202	19.344	-0.859
100	180	20.477	19.298	-1.179
100	181	20.262	18.793	-1.469
100	182	19.806	18.752	-1.055
Max		21.087	20.689	0.570
Average		20.260	19.589	-0.671
Min		19.542	18.562	-1.791
Std Dev		0.315	0.473	0.465

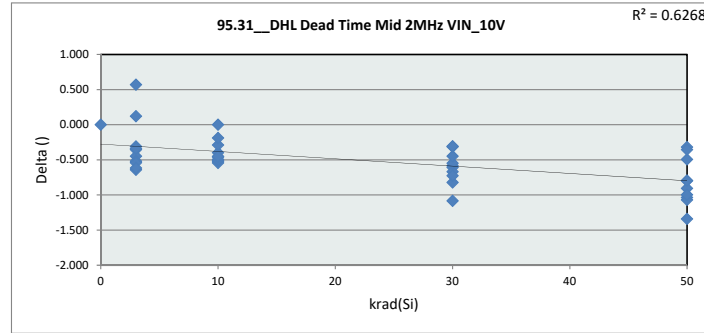

95.31 DHL Dead Time		
Test Site	DAL-FL	
Tester	ETS364	
Test Number	EB672302	
Max Limit	24.5	
Min Limit	16	

krad(Si)	0	3	10	30	50	100
LL	16.000	16.000	16.000	16.000	16.000	16.000
Min	20.153	19.501	19.474	19.108	18.590	18.562
Average	20.153	19.846	19.926	19.631	19.448	19.037
Max	20.153	20.197	20.689	20.145	20.080	19.386
UL	24.500	24.500	24.500	24.500	24.500	24.500

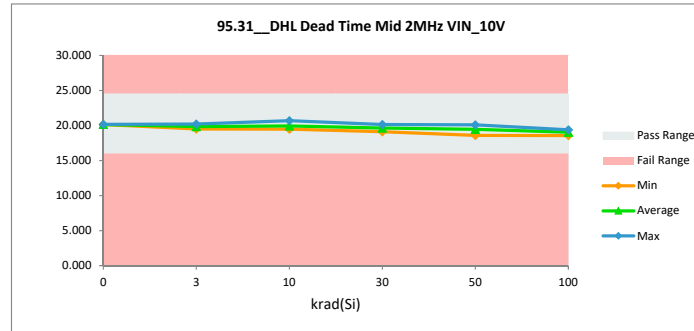

TID HDR Report
TPS7H6003-SP (5962R2220101VXC)

95.32 DHL Dead Time Large 2MHz		
Test Site	DAL-FL	DAL-FL
Tester	ETS364	ETS364
Test Number	EB672302	EB672302
Unit	nsec	
Max Limit	61	61
Min Limit	44	44

krad(Si)	Serial #	pre_short (rtp)	(2)'ST_Combo (rpt)	Delta
0	Ctrl	52.014	52.014	0.000
3	58	51.758	51.286	-0.472
3	59	50.274	49.766	-0.508
3	60	50.271	49.651	-0.620
3	61	52.474	51.666	-0.808
3	62	53.563	52.934	-0.629
3	134	51.938	50.338	-1.600
3	137	50.177	50.247	0.069
3	138	51.967	50.280	-1.687
3	139	50.625	50.189	-0.436
3	236	49.996	50.840	0.843
10	63	53.128	52.472	-0.656
10	64	52.653	51.895	-0.758
10	65	50.596	49.956	-0.640
10	66	52.031	51.240	-0.792
10	150	50.572	50.252	-0.320
10	237	51.858	50.770	-1.088
10	241	50.705	50.089	-0.616
10	242	52.159	51.465	-0.694
10	243	52.536	51.993	-0.542
10	244	51.307	50.584	-0.723
30	141	50.104	48.855	-1.249
30	144	52.269	50.694	-1.575
30	145	53.391	51.655	-1.736
30	146	51.749	50.487	-1.262
30	147	50.915	49.654	-1.261
30	132	52.879	51.724	-1.155
30	133	52.465	51.313	-1.152
30	135	51.711	50.815	-0.896
30	245	51.200	50.022	-1.177
30	246	50.091	48.953	-1.138
50	67	52.254	50.175	-2.079
50	68	51.806	50.476	-1.330
50	69	51.814	49.498	-2.316
50	71	52.394	49.640	-2.754
50	72	50.536	48.006	-2.530
50	172	50.666	48.513	-2.152
50	173	52.074	50.332	-1.742
50	174	51.907	49.635	-2.272
50	183	51.566	49.525	-2.042
50	186	52.759	50.587	-2.172
100	95	50.721	46.193	-4.528
100	102	51.894	47.980	-3.913
100	104	51.755	47.943	-3.812
100	105	53.406	49.079	-4.327
100	106	52.348	48.517	-3.831
100	178	51.529	48.203	-3.326
100	179	51.814	48.500	-3.315
100	180	52.295	48.606	-3.689
100	181	51.733	47.864	-3.869
100	182	51.586	48.021	-3.565
	Max	53.563	52.934	0.843
	Average	51.691	50.027	-1.664
	Min	49.996	46.193	-4.528
	Std Dev	0.926	1.395	1.286

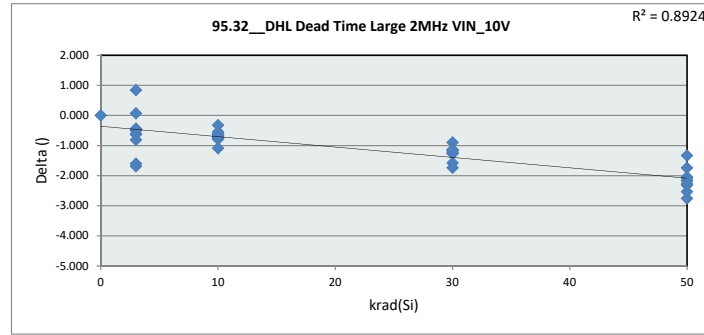

95.32 DHL Dead Time Large 2MHz VIN_10V						
Test Site	DAL-FL					
Tester	ETS364					
Test Number	EB672302					
Max Limit	61					
Min Limit	44					
krad(Si)	0	3	10	30	50	100
LL	44.000	44.000	44.000	44.000	44.000	44.000
Min	52.014	49.651	49.956	48.855	48.006	46.193
Average	52.014	50.720	51.072	50.417	49.639	48.091
Max	52.014	52.934	52.472	51.724	50.587	49.079
UL	61.000	61.000	61.000	61.000	61.000	61.000

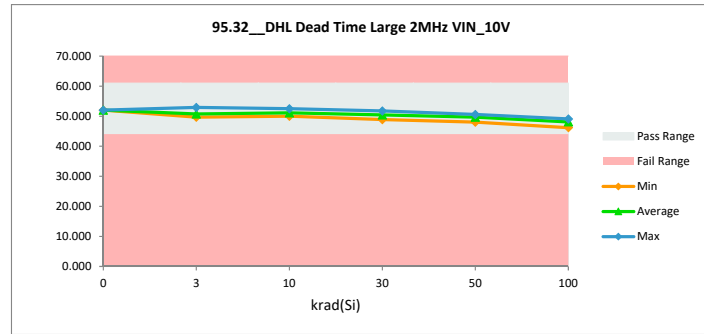

TID HDR Report
TPS7H6003-SP (5962R2220101VXC)

95.33 DHL Dead Time Max 2MHz		
Test Site	DAL-FL	DAL-FL
Tester	ETS364	ETS364
Test Number	EB672302	EB672302
Unit	nsec	
Max Limit	125	
Min Limit	86	

krad(Si)	Serial #	pre_short (rtp)	(2)'ST_Combo (rpt)	Delta
0	Ctrl	104.419	104.419	0.000
3	58	103.058	102.288	-0.770
3	59	99.519	99.119	-0.400
3	60	100.379	99.839	-0.541
3	61	105.547	104.737	-0.810
3	62	107.948	107.019	-0.929
3	134	104.127	100.883	-3.243
3	137	100.869	100.949	0.080
3	138	104.723	100.900	-3.823
3	139	101.609	101.043	-0.566
3	236	99.957	101.789	1.833
10	63	105.734	104.572	-1.162
10	64	106.128	104.922	-1.207
10	65	101.342	100.278	-1.064
10	66	104.765	103.557	-1.209
10	150	99.873	99.177	-0.695
10	237	103.680	101.879	-1.801
10	241	101.057	101.064	0.007
10	242	104.285	103.099	-1.185
10	243	106.340	105.472	-0.867
10	244	103.017	102.037	-0.980
30	141	100.508	97.863	-2.645
30	144	104.993	101.881	-3.112
30	145	107.370	104.037	-3.333
30	146	104.104	101.811	-2.293
30	147	101.690	99.149	-2.541
30	132	106.357	104.209	-2.148
30	133	105.725	103.432	-2.293
30	135	103.004	103.195	0.191
30	245	102.661	100.156	-2.505
30	246	100.397	98.314	-2.083
50	67	104.368	100.273	-4.095
50	68	104.135	102.264	-1.871
50	69	103.220	98.323	-4.897
50	71	105.671	100.625	-5.047
50	72	100.897	95.724	-5.173
50	172	101.236	96.787	-4.449
50	173	104.466	100.678	-3.788
50	174	104.185	99.197	-4.988
50	183	103.253	98.394	-4.859
50	186	107.066	102.023	-5.043
100	95	101.154	91.942	-9.213
100	102	103.999	95.849	-8.150
100	104	103.145	95.473	-7.671
100	105	107.917	99.464	-8.452
100	106	105.257	97.211	-8.045
100	178	103.201	95.719	-7.482
100	179	103.896	96.820	-7.076
100	180	104.839	96.467	-8.372
100	181	103.543	95.023	-8.520
100	182	103.870	96.074	-7.796
Max		107.948	107.019	1.833
Average		103.618	100.342	-3.276
Min		99.519	91.942	-9.213
Std Dev		2.178	3.202	2.887

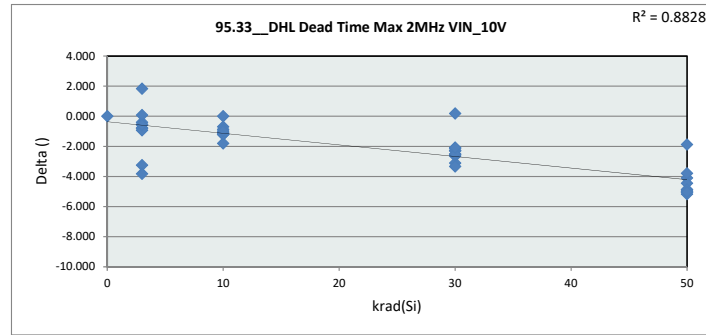

95.33 DHL Dead Time Max 2MHz VIN_10V						
Test Site	DAL-FL					
Tester	ETS364					
Test Number	EB672302					
Max Limit	125					
Min Limit	86					
krad(Si)	0	3	10	30	50	100
LL	86.000	86.000	86.000	86.000	86.000	86.000
Min	104.419	99.119	99.177	97.863	95.724	91.942
Average	104.419	101.857	102.606	101.405	99.429	96.004
Max	104.419	107.019	105.472	104.209	102.264	99.464
UL	125.000	125.000	125.000	125.000	125.000	125.000

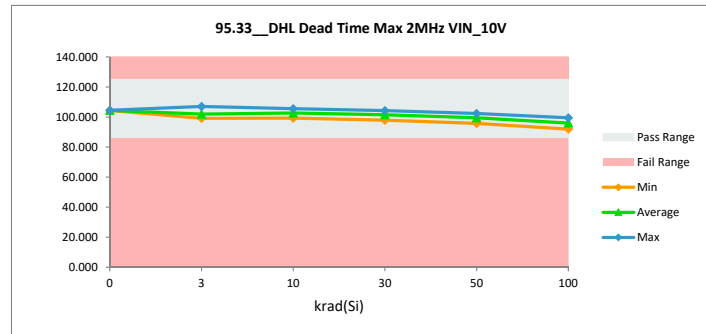

TID HDR Report
TPS7H6003-SP (5962R2220101VXC)

96.0 DLH Dead Time Min 500k		
Test Site	DAL-FL	DAL-FL
Tester	ETS364	ETS364
Test Number	EB672302	EB672302
Unit	nsec	
Max Limit	10	10
Min Limit	0	0

krad(Si)	Serial #	pre_short (rtp)	(2)'ST_Combo (rpt)	Delta
0	Ctrl	3.435	3.435	0.000
3	58	3.517	4.397	0.880
3	59	3.137	3.864	0.727
3	60	2.773	3.685	0.913
3	61	3.672	4.478	0.805
3	62	3.290	4.116	0.826
3	134	3.046	4.763	1.716
3	137	3.671	4.780	1.109
3	138	3.812	4.646	0.834
3	139	3.898	4.320	0.422
3	236	2.847	4.414	1.566
10	63	3.509	4.277	0.769
10	64	3.330	3.999	0.669
10	65	3.522	3.936	0.414
10	66	3.677	4.327	0.650
10	150	3.228	3.758	0.529
10	237	3.672	4.310	0.638
10	241	3.459	4.725	1.267
10	242	3.095	3.503	0.408
10	243	3.828	4.203	0.374
10	244	4.052	4.518	0.466
30	141	3.131	3.759	0.628
30	144	3.909	4.571	0.663
30	145	4.148	4.691	0.543
30	146	3.566	4.190	0.624
30	147	3.386	3.771	0.385
30	132	3.917	4.637	0.719
30	133	3.629	4.149	0.520
30	135	3.664	4.831	1.167
30	245	3.650	4.170	0.521
30	246	2.921	3.605	0.683
50	67	3.531	4.208	0.678
50	68	2.966	4.705	1.740
50	69	3.325	4.293	0.968
50	71	3.665	4.599	0.935
50	72	3.078	4.064	0.986
50	172	4.479	4.954	0.475
50	173	3.799	4.178	0.378
50	174	2.866	4.016	1.150
50	183	2.967	3.372	0.405
50	186	4.113	4.809	0.696
100	95	3.721	4.942	1.221
100	102	3.128	4.203	1.075
100	104	3.347	4.697	1.350
100	105	3.206	4.286	1.080
100	106	3.654	4.673	1.019
100	178	3.563	4.333	0.770
100	179	3.575	4.180	0.605
100	180	3.427	4.399	0.971
100	181	3.461	4.170	0.709
100	182	3.378	4.174	0.796
	Max	4.479	4.954	1.740
	Average	3.483	4.276	0.793
	Min	2.773	3.372	0.000
	Std Dev	0.366	0.395	0.353

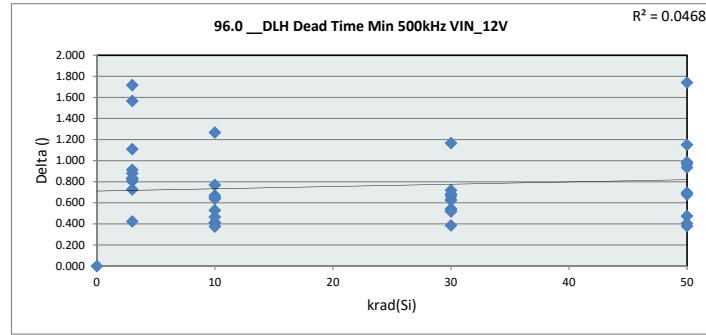

96.0 DLH Dead Time

Test Site	DAL-FL
Tester	ETS364
Test Number	EB672302
Max Limit	10
Min Limit	0

krad(Si)	0	3	10	30	50	100
LL	0.000	0.000	0.000	0.000	0.000	0.000
Min	3.435	3.685	3.504	3.605	3.372	4.170
Average	3.435	4.346	4.156	4.238	4.320	4.406
Max	3.435	4.780	4.725	4.831	4.954	4.942
UL	10.000	10.000	10.000	10.000	10.000	10.000

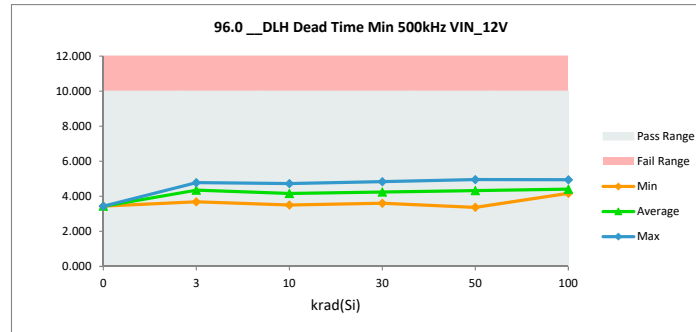

TID HDR Report
TPS7H6003-SP (5962R2220101VXC)

96.1 DLH Dead Time Small 500		
Test Site	DAL-FL	DAL-FL
Tester	ETS364	ETS364
Test Number	EB672302	EB672302
Unit	nsec	
Max Limit	15.5	15.5
Min Limit	8	8

krad(Si)	Serial #	pre_short (rtp)	(2)ST_Combo (rpt)	Delta
0	Ctrl	11.028	11.028	0.000
3	58	11.011	11.578	0.567
3	59	10.066	10.885	0.819
3	60	10.133	10.909	0.776
3	61	10.641	11.377	0.736
3	62	10.143	10.962	0.818
3	134	10.568	11.486	0.918
3	137	10.512	11.404	0.892
3	138	10.550	11.515	0.965
3	139	11.133	11.499	0.366
3	236	10.475	11.818	1.344
10	63	10.952	11.436	0.484
10	64	10.847	11.232	0.384
10	65	10.932	11.369	0.437
10	66	10.531	11.118	0.587
10	150	10.572	11.015	0.443
10	237	10.513	11.744	1.231
10	241	10.789	11.355	0.567
10	242	10.498	10.887	0.389
10	243	11.143	11.659	0.516
10	244	11.489	11.647	0.158
30	141	10.425	10.800	0.375
30	144	11.183	11.359	0.176
30	145	11.061	11.232	0.172
30	146	10.904	11.047	0.143
30	147	10.616	10.701	0.085
30	132	11.152	11.623	0.470
30	133	10.967	11.234	0.267
30	135	10.540	11.474	0.933
30	245	11.100	11.084	-0.017
30	246	10.288	10.436	0.148
50	67	10.484	10.555	0.072
50	68	10.342	11.625	1.284
50	69	10.675	10.949	0.274
50	71	10.407	10.676	0.269
50	72	10.326	10.752	0.426
50	172	11.459	11.561	0.102
50	173	11.184	11.005	-0.179
50	174	10.263	10.938	0.675
50	183	10.278	10.119	-0.158
50	186	10.957	11.042	0.085
100	95	11.081	11.171	0.090
100	102	10.534	10.399	-0.135
100	104	10.784	10.952	0.167
100	105	10.640	10.665	0.025
100	106	11.027	10.809	-0.218
100	178	10.807	10.757	-0.050
100	179	10.870	10.467	-0.403
100	180	10.816	10.877	0.061
100	181	10.840	10.466	-0.374
100	182	10.610	10.384	-0.227
	Max	11.489	11.818	1.344
	Average	10.728	11.080	0.352
	Min	10.066	10.119	-0.403
	Std Dev	0.339	0.410	0.419

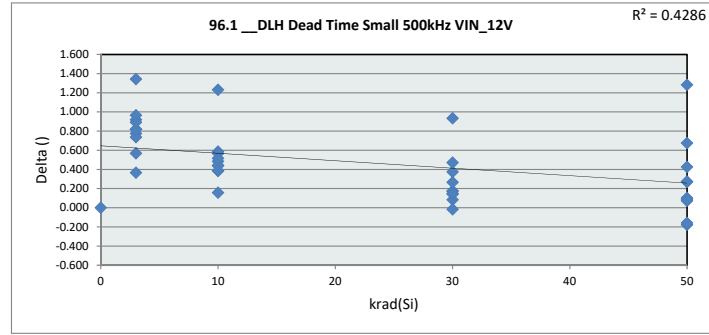

96.1 DLH Dead Time

Test Site	DAL-FL
Tester	ETS364
Test Number	EB672302
Max Limit	15.5
Min Limit	8

krad(Si)	0	3	10	30	50	100
LL	8.000	8.000	8.000	8.000	8.000	8.000
Min	11.028	10.885	10.887	10.436	10.119	10.384
Average	11.028	11.343	11.346	11.099	10.922	10.695
Max	11.028	11.818	11.744	11.623	11.626	11.171
UL	15.500	15.500	15.500	15.500	15.500	15.500

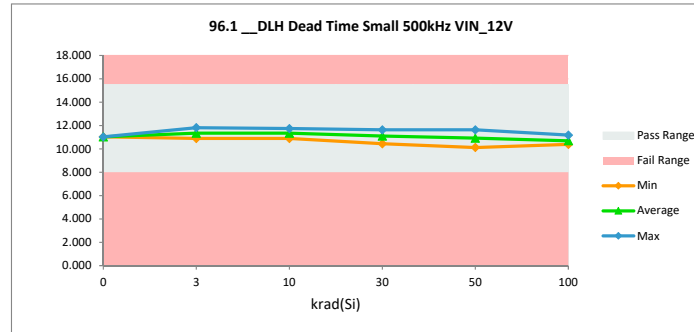

TID HDR Report
TPS7H6003-SP (5962R2220101VXC)

96.2 DLH Dead Time Mid 500k		
Test Site	DAL-FL	DAL-FL
Tester	ETS364	ETS364
Test Number	EB672302	EB672302
Unit	nsec	
Max Limit	24	
Min Limit	15.5	

krad(Si)	Serial #	pre_short (rtp)	(2)ST_Combo (rpt)	Delta
0	Ctrl	20.012	20.012	0.000
3	58	19.620	20.337	0.718
3	59	18.400	19.044	0.644
3	60	18.840	19.440	0.599
3	61	18.805	19.421	0.616
3	62	18.425	19.224	0.799
3	134	19.558	19.278	-0.279
3	137	18.683	19.258	0.575
3	138	18.744	19.361	0.617
3	139	19.756	20.092	0.336
3	236	19.559	20.200	0.641
10	63	19.697	20.032	0.335
10	64	19.728	20.011	0.283
10	65	19.705	20.124	0.419
10	66	18.818	19.423	0.606
10	150	19.247	19.574	0.327
10	237	18.610	20.066	1.456
10	241	19.368	19.451	0.083
10	242	19.354	19.830	0.476
10	243	19.673	19.925	0.252
10	244	19.912	20.084	0.171
30	141	19.219	19.227	0.008
30	144	19.730	19.915	0.185
30	145	19.310	19.247	-0.063
30	146	19.561	19.642	0.081
30	147	19.347	19.132	-0.215
30	132	19.928	19.974	0.046
30	133	19.536	19.605	0.069
30	135	18.675	19.421	0.746
30	245	19.771	19.601	-0.171
30	246	19.139	18.955	-0.184
50	67	18.643	18.320	-0.323
50	68	19.080	19.783	0.703
50	69	19.432	19.489	0.057
50	71	18.633	18.467	-0.165
50	72	18.915	19.080	0.165
50	172	19.596	19.293	-0.302
50	173	20.003	19.500	-0.504
50	174	19.302	19.579	0.277
50	183	18.966	18.540	-0.426
50	186	19.110	18.989	-0.121
100	95	19.742	19.218	-0.524
100	102	19.150	18.183	-0.967
100	104	19.482	18.823	-0.659
100	105	19.487	18.568	-0.919
100	106	19.629	18.687	-0.942
100	178	19.348	18.621	-0.727
100	179	19.655	18.593	-1.061
100	180	19.795	18.783	-1.011
100	181	19.477	18.403	-1.074
100	182	19.214	18.507	-0.707
	Max	20.012	20.337	1.456
	Average	19.321	19.340	0.019
	Min	18.400	18.183	-1.074
	Std Dev	0.433	0.564	0.576

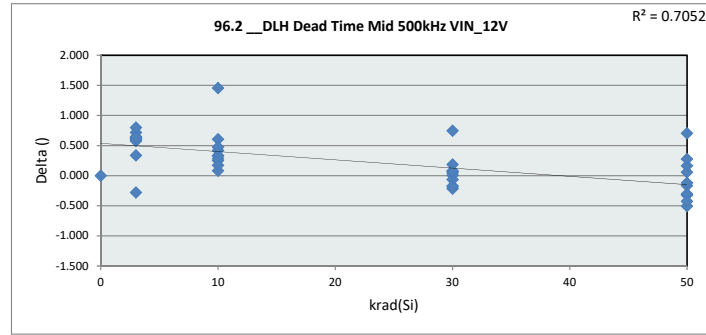

96.2 DLH Dead Time	
Test Site	DAL-FL
Tester	ETS364
Test Number	EB672302
Max Limit	24
Min Limit	15.5

krad(Si)	0	3	10	30	50	100
LL	15.500	15.500	15.500	15.500	15.500	15.500
Min	20.012	19.044	19.423	18.955	18.321	18.183
Average	20.012	19.566	19.852	19.472	19.104	18.639
Max	20.012	20.337	20.124	19.974	19.783	19.218
UL	24.000	24.000	24.000	24.000	24.000	24.000

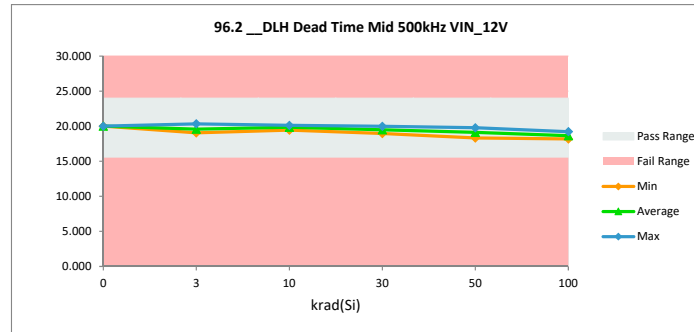

TID HDR Report
TPS7H6003-SP (5962R2220101VXC)

96.3 DLH Dead Time Large 500kHz VIN_12V		
Test Site	DAL-FL	DAL-FL
Tester	ETS364	ETS364
Test Number	EB672302	EB672302
Unit	nsec	
Max Limit	59	59
Min Limit	36	36

krad(Si)	Serial #	pre_short (rtp) (2)	ST_Combo (rpt) (Delta
0	Ctrl	49.349	49.349	0.000
3	58	48.183	48.724	0.541
3	59	45.807	46.241	0.434
3	60	47.139	47.581	0.442
3	61	45.765	46.280	0.516
3	62	45.497	46.039	0.542
3	134	48.783	45.802	-2.982
3	137	46.193	45.766	-0.427
3	138	45.581	45.872	0.291
3	139	47.932	48.066	0.134
3	236	49.216	48.312	-0.904
10	63	48.740	48.948	0.208
10	64	48.959	48.955	-0.004
10	65	48.976	48.995	0.019
10	66	45.796	46.140	0.343
10	150	48.376	48.482	0.106
10	237	45.434	48.111	2.677
10	241	48.023	45.728	-2.295
10	242	48.493	48.584	0.091
10	243	48.039	47.955	-0.084
10	244	48.267	48.281	0.014
30	141	47.936	47.387	-0.549
30	144	48.352	47.549	-0.804
30	145	46.383	45.632	-0.752
30	146	48.133	47.344	-0.788
30	147	47.826	47.002	-0.824
30	132	48.727	48.085	-0.643
30	133	48.127	47.276	-0.851
30	135	45.621	45.757	0.137
30	245	48.514	47.527	-0.987
30	246	48.326	47.207	-1.119
50	67	45.601	44.041	-1.560
50	68	48.172	47.240	-0.931
50	69	48.213	47.062	-1.151
50	71	45.427	44.164	-1.264
50	72	46.993	46.073	-0.920
50	172	46.385	45.258	-1.126
50	173	48.571	47.195	-1.376
50	174	48.528	47.679	-0.849
50	183	47.741	46.207	-1.534
50	186	45.999	44.729	-1.269
100	95	48.457	45.847	-2.610
100	102	47.612	44.408	-3.204
100	104	47.956	45.059	-2.896
100	105	47.970	44.833	-3.137
100	106	48.245	44.822	-3.423
100	178	47.401	44.633	-2.767
100	179	48.262	45.085	-3.176
100	180	48.797	45.661	-3.136
100	181	48.158	44.796	-3.363
100	182	47.316	44.523	-2.793
Max		49.349	49.349	2.677
Average		47.614	46.633	-0.980
Min		45.427	44.041	-3.423
Std Dev		1.172	1.479	1.339

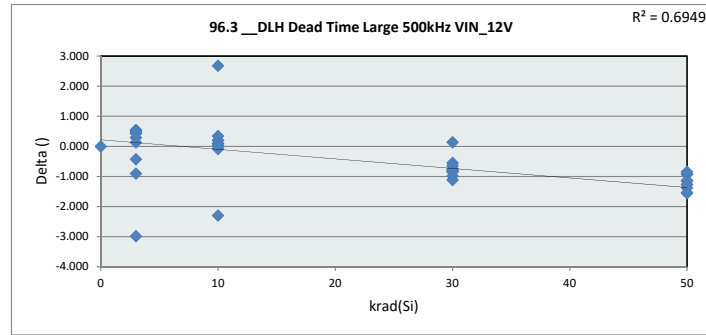

96.3 DLH Dead Time Large 500kHz VIN_12V						
Test Site	DAL-FL					
Tester	ETS364					
Test Number	EB672302					
Max Limit	59					
Min Limit	36					
krad(Si)	0	3	10	30	50	100
LL	36.000	36.000	36.000	36.000	36.000	36.000
Min	49.349	45.766	45.728	45.632	44.041	44.408
Average	49.349	46.868	48.018	47.077	45.965	44.967
Max	49.349	48.724	48.995	48.085	47.679	45.847
UL	59.000	59.000	59.000	59.000	59.000	59.000

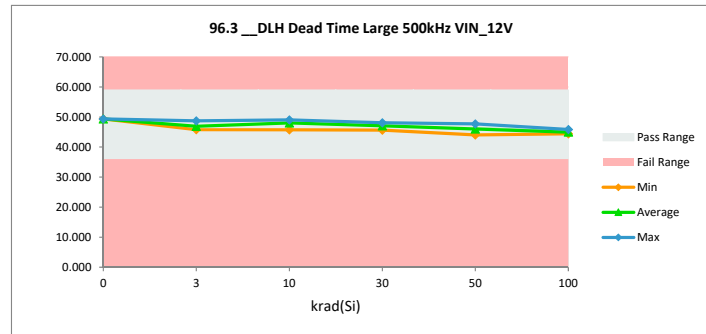

TID HDR Report
TPS7H6003-SP (5962R2220101VXC)

96.4 __DLH Dead Time Max 500kHz		
Test Site	DAL-FL	DAL-FL
Tester	ETS364	ETS364
Test Number	EB672302	EB672302
Unit	nsec	
Max Limit	113.5	113.5
Min Limit	74	74

krad(Si)	Serial #	pre_short (rtp)	(2)'ST_Combo (rpt)	Delta
0	Ctrl	95.992	95.992	0.000
3	58	93.518	93.766	0.248
3	59	89.299	89.842	0.542
3	60	92.059	92.333	0.274
3	61	88.611	89.214	0.603
3	62	88.499	88.568	0.069
3	134	95.785	87.930	-7.854
3	137	89.438	87.933	-1.506
3	138	88.125	87.955	-0.170
3	139	92.441	92.420	-0.021
3	236	96.964	93.495	-3.469
10	63	95.533	95.339	-0.194
10	64	96.278	95.853	-0.425
10	65	95.508	95.157	-0.351
10	66	88.296	87.931	-0.365
10	150	95.300	94.849	-0.451
10	237	87.746	93.484	5.739
10	241	94.404	87.924	-6.480
10	242	94.809	94.400	-0.409
10	243	92.990	92.396	-0.593
10	244	93.903	93.315	-0.588
30	141	94.273	92.205	-2.068
30	144	94.247	92.080	-2.167
30	145	89.263	86.788	-2.476
30	146	94.225	91.890	-2.335
30	147	93.533	91.496	-2.037
30	132	94.775	92.554	-2.221
30	133	93.704	91.259	-2.445
30	135	87.947	87.220	-0.727
30	245	94.937	92.248	-2.689
30	246	94.675	92.019	-2.657
50	67	87.531	84.165	-3.366
50	68	94.147	91.039	-3.108
50	69	94.148	91.024	-3.124
50	71	87.828	84.436	-3.392
50	72	91.886	88.640	-3.246
50	172	88.695	85.888	-2.806
50	173	94.084	90.944	-3.139
50	174	95.409	92.607	-2.802
50	183	93.854	90.605	-3.249
50	186	88.240	85.227	-3.013
100	95	94.418	87.726	-6.692
100	102	92.834	85.574	-7.260
100	104	93.491	86.585	-6.906
100	105	93.249	85.743	-7.506
100	106	93.982	85.998	-7.984
100	178	91.462	85.242	-6.221
100	179	94.025	87.426	-6.599
100	180	94.950	88.038	-6.912
100	181	93.543	86.408	-7.136
100	182	91.984	85.776	-6.208
Max		96.964	95.992	5.739
Average		92.683	89.979	-2.704
Min		87.531	84.165	-7.984
Std Dev		2.753	3.347	2.876

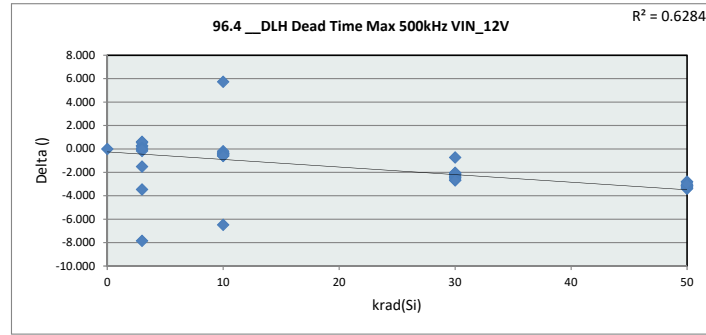

96.4 __DLH Dead Time Max 500kHz VIN_12V						
Test Site	DAL-FL					
Tester	ETS364					
Test Number	EB672302					
Max Limit	113.5					
Min Limit	74					
krad(Si)	0	3	10	30	50	100
LL	74.000	74.000	74.000	74.000	74.000	74.000
Min	95.992	87.930	87.924	86.788	84.165	85.242
Average	95.992	90.346	93.065	90.976	88.458	86.451
Max	95.992	93.766	95.853	92.554	92.607	88.038
UL	113.500	113.500	113.500	113.500	113.500	113.500

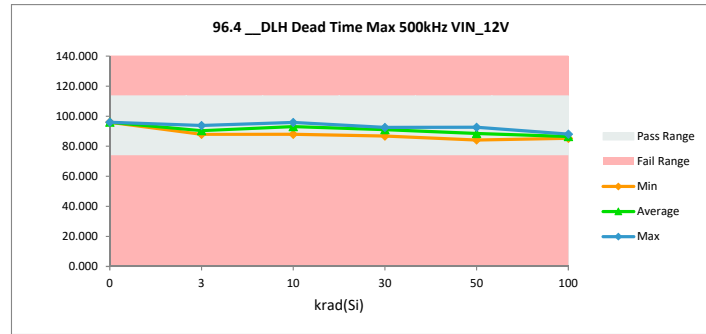

TID HDR Report
TPS7H6003-SP (5962R2220101VXC)

96.5_DLH Dead Time Min 1MHz		
Test Site	DAL-FL	DAL-FL
Tester	ETS364	ETS364
Test Number	EB672302	EB672302
Unit	nsec	
Max Limit	10	10
Min Limit	0	0

krad(Si)	Serial #	pre_short (rtp)	(2)'ST_Combo (rpt)	Delta
0	Ctrl	3.585	3.585	0.000
3	58	3.731	4.526	0.795
3	59	3.284	4.055	0.771
3	60	2.996	3.751	0.755
3	61	3.782	4.573	0.792
3	62	3.363	4.119	0.756
3	134	3.210	4.837	1.628
3	137	3.827	4.769	0.942
3	138	3.913	4.792	0.878
3	139	4.006	4.315	0.309
3	236	2.974	4.674	1.699
10	63	3.639	4.360	0.721
10	64	3.444	4.021	0.577
10	65	3.530	4.229	0.699
10	66	3.660	4.333	0.673
10	150	3.361	3.654	0.293
10	237	3.790	4.582	0.791
10	241	3.594	4.755	1.161
10	242	3.204	3.814	0.610
10	243	3.887	4.475	0.588
10	244	4.187	4.656	0.469
30	141	3.271	3.731	0.460
30	144	3.922	4.559	0.637
30	145	4.272	4.772	0.500
30	146	3.763	4.149	0.386
30	147	3.552	3.919	0.366
30	132	4.012	4.573	0.561
30	133	3.710	4.346	0.635
30	135	3.786	5.064	1.278
30	245	3.780	4.376	0.596
30	246	3.103	3.651	0.548
50	67	3.695	4.446	0.750
50	68	3.052	4.864	1.811
50	69	3.458	4.400	0.943
50	71	3.770	4.512	0.742
50	72	3.052	4.113	1.060
50	172	4.627	4.970	0.343
50	173	3.875	4.353	0.478
50	174	2.970	4.317	1.347
50	183	3.146	3.526	0.381
50	186	4.317	5.034	0.717
100	95	3.803	4.972	1.169
100	102	3.298	4.200	0.902
100	104	3.473	4.595	1.122
100	105	3.332	4.402	1.071
100	106	3.671	4.784	1.113
100	178	3.754	4.479	0.725
100	179	3.641	4.269	0.628
100	180	3.468	4.672	1.205
100	181	3.618	4.403	0.785
100	182	3.441	4.321	0.879
Max		4.627	5.064	1.811
Average		3.600	4.385	0.785
Min		2.970	3.526	0.000
Std Dev		0.361	0.390	0.363

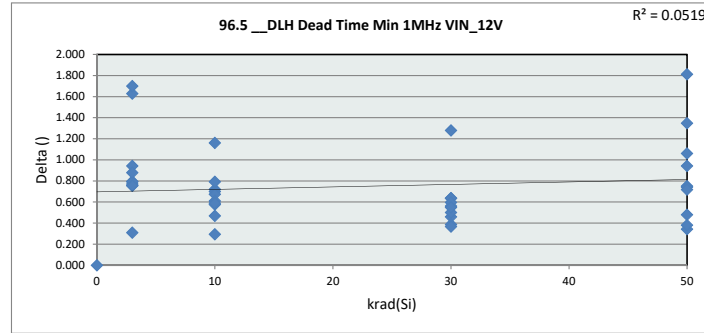

96.5_DLH Dead Time

Test Site	DAL-FL
Tester	ETS364
Test Number	EB672302
Max Limit	10
Min Limit	0

krad(Si)	0	3	10	30	50	100
LL	0.000	0.000	0.000	0.000	0.000	0.000
Min	3.585	3.751	3.654	3.651	3.527	4.200
Average	3.585	4.441	4.288	4.314	4.454	4.510
Max	3.585	4.837	4.755	5.064	5.034	4.972
UL	10.000	10.000	10.000	10.000	10.000	10.000

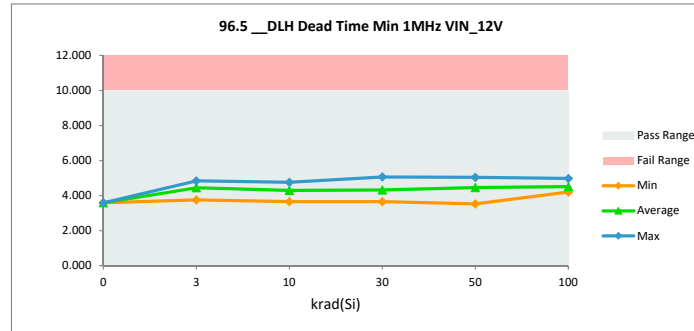

TID HDR Report
TPS7H6003-SP (5962R2220101VXC)

96.6 DLH Dead Time Small 1M		
Test Site	DAL-FL	DAL-FL
Tester	ETS364	ETS364
Test Number	EB672302	EB672302
Unit	nsec	
Max Limit	15.5	15.5
Min Limit	8	8

krad(Si)	Serial #	pre_short (rtp)	(2)'ST_Combo (rpt)	Delta
0	Ctrl	11.109	11.109	0.000
3	58	10.919	11.485	0.566
3	59	9.983	10.764	0.781
3	60	10.070	10.656	0.586
3	61	10.497	11.110	0.613
3	62	10.116	10.797	0.681
3	134	10.510	11.371	0.861
3	137	10.382	11.191	0.809
3	138	10.419	11.327	0.908
3	139	11.005	11.403	0.398
3	236	10.328	11.564	1.236
10	63	10.779	11.305	0.526
10	64	10.706	11.087	0.381
10	65	10.822	11.318	0.495
10	66	10.441	11.022	0.581
10	150	10.486	10.777	0.291
10	237	10.410	11.496	1.086
10	241	10.675	11.220	0.545
10	242	10.403	10.823	0.420
10	243	11.074	11.450	0.376
10	244	11.341	11.632	0.291
30	141	10.314	10.540	0.226
30	144	11.024	11.254	0.230
30	145	10.953	11.221	0.268
30	146	10.813	10.894	0.082
30	147	10.539	10.679	0.140
30	132	11.007	11.313	0.306
30	133	10.847	11.069	0.222
30	135	10.405	11.312	0.908
30	245	10.883	11.129	0.246
30	246	10.248	10.408	0.159
50	67	10.385	10.479	0.095
50	68	10.264	11.432	1.168
50	69	10.588	10.939	0.351
50	71	10.287	10.520	0.233
50	72	10.167	10.648	0.481
50	172	11.325	11.315	-0.010
50	173	11.089	11.107	0.018
50	174	10.211	10.968	0.757
50	183	10.205	10.080	-0.125
50	186	10.925	11.059	0.135
100	95	10.960	10.946	-0.014
100	102	10.392	10.155	-0.236
100	104	10.685	10.707	0.022
100	105	10.507	10.471	-0.035
100	106	10.897	10.688	-0.209
100	178	10.785	10.782	-0.002
100	179	10.775	10.414	-0.361
100	180	10.773	10.838	0.065
100	181	10.729	10.492	-0.237
100	182	10.480	10.369	-0.111
	Max	11.341	11.632	1.236
	Average	10.626	10.963	0.337
	Min	9.983	10.080	-0.361
	Std Dev	0.331	0.384	0.378

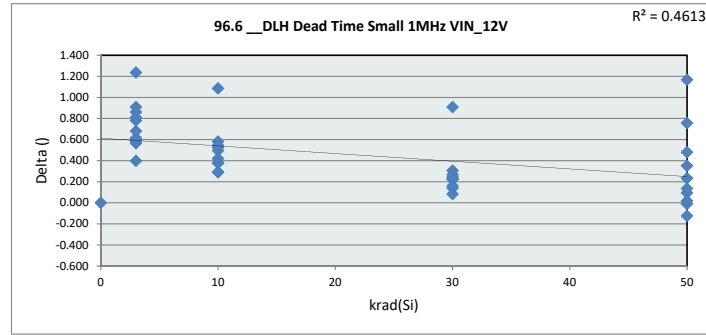

96.6 DLH Dead Time

Test Site	DAL-FL
Tester	ETS364
Test Number	EB672302
Max Limit	15.5
Min Limit	8

krad(Si)	0	3	10	30	50	100
LL	8.000	8.000	8.000	8.000	8.000	8.000
Min	11.109	10.656	10.777	10.408	10.080	10.155
Average	11.109	11.167	11.213	10.982	10.855	10.586
Max	11.109	11.564	11.632	11.313	11.432	10.946
UL	15.500	15.500	15.500	15.500	15.500	15.500

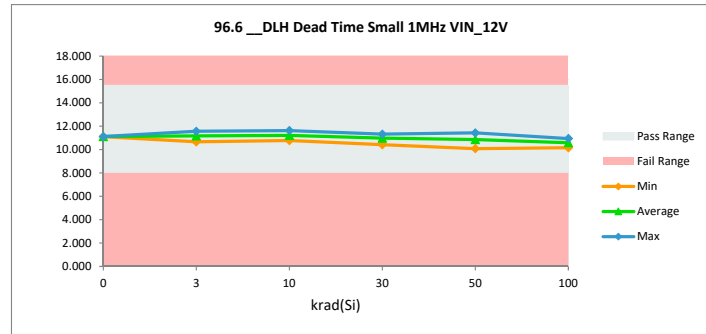

TID HDR Report
TPS7H6003-SP (5962R2220101VXC)

96.7 DLH Dead Time Mid 1MHz		
Test Site	DAL-FL	DAL-FL
Tester	ETS364	ETS364
Test Number	EB672302	EB672302
Unit	nsec	
Max Limit	24	
Min Limit	15.5	

krad(Si)	Serial #	pre_short (rtp)	(2)ST_Combo (rpt)	Delta
0	Ctrl	19.671	19.671	0.000
3	58	19.206	19.922	0.716
3	59	17.967	18.733	0.766
3	60	18.406	19.112	0.707
3	61	18.395	19.007	0.612
3	62	18.025	18.733	0.708
3	134	19.050	18.949	-0.100
3	137	18.318	19.006	0.688
3	138	18.230	18.700	0.470
3	139	19.340	19.584	0.244
3	236	19.096	19.786	0.690
10	63	19.235	19.825	0.590
10	64	19.262	19.607	0.345
10	65	19.372	19.632	0.261
10	66	18.418	19.019	0.601
10	150	18.871	19.242	0.372
10	237	18.241	19.823	1.582
10	241	18.997	18.860	-0.138
10	242	19.042	19.299	0.258
10	243	19.315	19.608	0.293
10	244	19.549	19.731	0.182
30	141	18.738	18.734	-0.004
30	144	19.359	19.350	-0.010
30	145	18.838	18.918	0.080
30	146	19.200	19.197	-0.003
30	147	18.855	18.845	-0.010
30	132	19.474	19.556	0.082
30	133	19.163	19.088	-0.075
30	135	18.309	19.142	0.834
30	245	19.252	19.189	-0.063
30	246	18.744	18.501	-0.243
50	67	18.274	18.102	-0.172
50	68	18.682	19.403	0.721
50	69	19.003	18.976	-0.027
50	71	18.229	17.991	-0.238
50	72	18.529	18.587	0.058
50	172	19.066	18.894	-0.172
50	173	19.576	19.155	-0.422
50	174	18.912	19.175	0.263
50	183	18.596	18.084	-0.512
50	186	18.843	18.552	-0.291
100	95	19.369	18.786	-0.583
100	102	18.799	17.735	-1.063
100	104	19.152	18.389	-0.762
100	105	19.073	18.301	-0.772
100	106	19.304	18.437	-0.867
100	178	19.005	18.223	-0.781
100	179	19.166	18.229	-0.937
100	180	19.334	18.449	-0.885
100	181	19.150	18.221	-0.929
100	182	18.772	17.988	-0.784
	Max	19.671	19.922	1.582
	Average	18.917	18.942	0.025
	Min	17.967	17.735	-1.063
	Std Dev	0.431	0.559	0.576

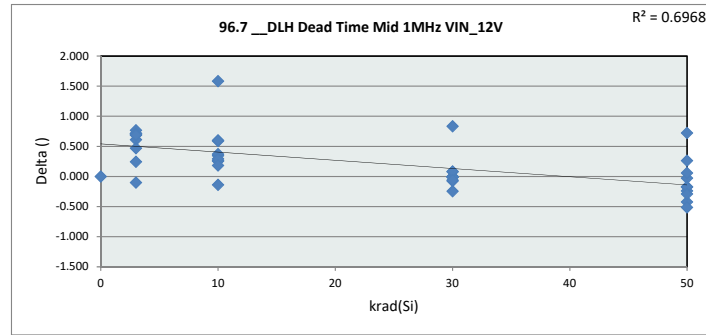

96.7 DLH Dead Time		
Test Site	DAL-FL	
Tester	ETS364	
Test Number	EB672302	
Max Limit	24	
Min Limit	15.5	

krad(Si)	0	3	10	30	50	100
LL	15.500	15.500	15.500	15.500	15.500	15.500
Min	19.672	18.700	18.860	18.501	17.991	17.735
Average	19.672	19.153	19.465	19.052	18.692	18.276
Max	19.672	19.922	19.825	19.556	19.403	18.786
UL	24.000	24.000	24.000	24.000	24.000	24.000

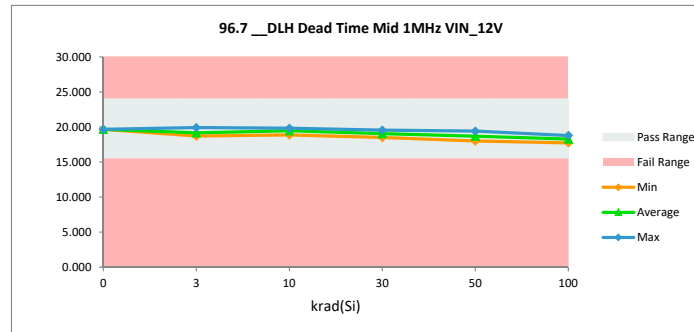

TID HDR Report
TPS7H6003-SP (5962R2220101VXC)

96.8 DLH Dead Time Large 1M		
Test Site	DAL-FL	DAL-FL
Tester	ETS364	ETS364
Test Number	EB672302	EB672302
Unit	nsec	
Max Limit	59	59
Min Limit	36	36

krad(Si)	Serial #	pre_short (rtp)	(2)ST_Combo (rpt)	Delta
0	Ctrl	47.636	47.636	0.000
3	58	46.371	46.884	0.513
3	59	44.002	44.696	0.693
3	60	45.349	45.884	0.535
3	61	44.110	44.616	0.506
3	62	43.846	44.368	0.522
3	134	46.951	44.193	-2.758
3	137	44.351	44.269	-0.083
3	138	44.012	44.239	0.227
3	139	46.084	46.250	0.166
3	236	47.388	46.419	-0.970
10	63	46.806	47.099	0.294
10	64	47.057	47.180	0.123
10	65	47.189	47.517	0.328
10	66	44.096	44.365	0.269
10	150	46.595	46.805	0.210
10	237	43.625	46.454	2.829
10	241	46.321	44.320	-2.001
10	242	46.611	46.797	0.185
10	243	46.257	46.291	0.034
10	244	46.586	46.472	-0.113
30	141	46.229	45.579	-0.650
30	144	46.600	45.853	-0.747
30	145	44.750	44.024	-0.726
30	146	46.437	45.533	-0.904
30	147	46.053	45.368	-0.685
30	132	46.845	46.196	-0.649
30	133	46.398	45.452	-0.946
30	135	43.765	44.249	0.484
30	245	46.629	45.676	-0.953
30	246	46.417	45.301	-1.116
50	67	43.932	42.629	-1.303
50	68	46.366	45.577	-0.789
50	69	46.411	45.173	-1.238
50	71	43.938	43.038	-0.899
50	72	45.345	44.461	-0.883
50	172	44.580	43.743	-0.837
50	173	46.862	45.388	-1.474
50	174	46.758	45.938	-0.820
50	183	45.964	44.488	-1.476
50	186	44.483	43.388	-1.095
100	95	46.663	44.215	-2.449
100	102	45.868	42.945	-2.922
100	104	46.310	43.537	-2.773
100	105	46.267	43.059	-3.207
100	106	46.530	43.395	-3.135
100	178	45.552	43.111	-2.441
100	179	46.426	43.622	-2.805
100	180	47.001	44.137	-2.864
100	181	46.487	43.222	-3.265
100	182	45.465	43.009	-2.456
	Max	47.636	47.636	2.829
	Average	45.854	44.982	-0.873
	Min	43.625	42.629	-3.265
	Std Dev	1.130	1.367	1.293

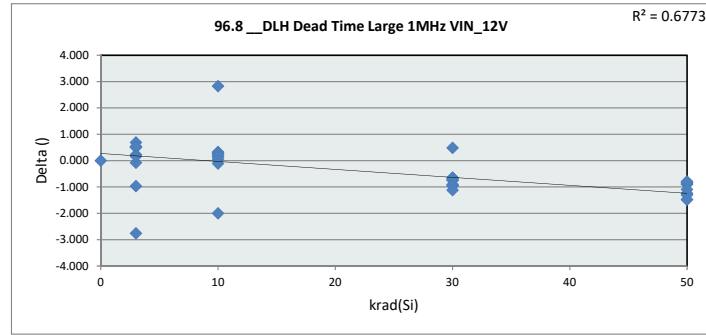

96.8 DLH Dead Time Large 1M						
Test Site	DAL-FL					
Tester	ETS364					
Test Number	EB672302					
Max Limit	59					
Min Limit	36					
krad(Si)	0	3	10	30	50	100
LL	36.000	36.000	36.000	36.000	36.000	36.000
Min	47.636	44.193	44.320	44.024	42.629	42.945
Average	47.636	45.182	46.330	45.323	44.382	43.425
Max	47.636	46.885	47.517	46.196	45.938	44.215
UL	59.000	59.000	59.000	59.000	59.000	59.000

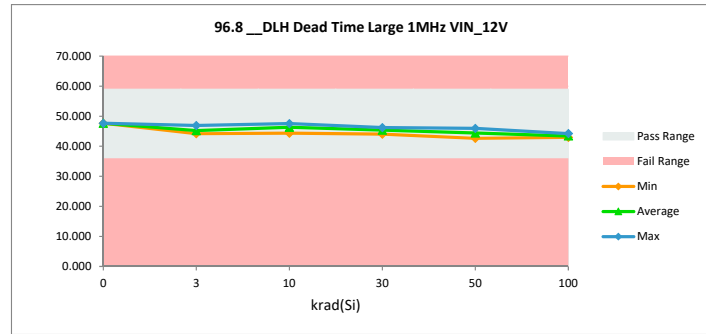

TID HDR Report

TPS7H6003-SP (5962R2220101VXC)

96.9 DLH Dead Time Max 1MHz		
Test Site	DAL-FL	DAL-FL
Tester	ETS364	ETS364
Test Number	EB672302	EB672302
Unit	nsec	
Max Limit	113.5	113.5
Min Limit	74	74

krad(Si)	Serial #	pre_short (rtp) (2)	ST_Combo (rpt) (Delta
0	Ctrl	91.542	91.542	0.000
3	58	88.871	89.134	0.263
3	59	84.859	85.528	0.669
3	60	87.528	87.744	0.216
3	61	84.262	84.933	0.671
3	62	84.053	84.292	0.240
3	134	91.156	83.790	-7.366
3	137	85.193	83.842	-1.351
3	138	83.764	83.718	-0.047
3	139	87.763	87.856	0.093
3	236	92.420	89.137	-3.284
10	63	90.823	90.755	-0.069
10	64	91.418	91.344	-0.074
10	65	90.889	90.680	-0.209
10	66	84.039	83.961	-0.078
10	150	90.526	90.462	-0.064
10	237	83.452	89.123	5.671
10	241	89.704	83.816	-5.888
10	242	90.117	90.101	-0.016
10	243	88.375	87.930	-0.445
10	244	89.238	88.787	-0.451
30	141	89.612	87.909	-1.703
30	144	89.483	87.754	-1.729
30	145	84.911	82.772	-2.138
30	146	89.653	87.545	-2.108
30	147	88.915	87.043	-1.873
30	132	89.998	88.224	-1.774
30	133	88.992	86.975	-2.016
30	135	83.685	83.086	-0.600
30	245	90.159	87.675	-2.484
30	246	89.947	87.513	-2.434
50	67	83.359	80.422	-2.937
50	68	89.595	86.762	-2.833
50	69	89.482	86.798	-2.684
50	71	83.544	80.800	-2.745
50	72	87.368	84.587	-2.781
50	172	84.395	82.078	-2.317
50	173	89.402	86.564	-2.838
50	174	90.753	88.074	-2.679
50	183	89.262	86.343	-2.919
50	186	83.915	81.534	-2.381
100	95	89.702	83.774	-5.928
100	102	88.314	81.573	-6.741
100	104	89.027	82.773	-6.254
100	105	88.617	81.843	-6.774
100	106	89.365	82.150	-7.215
100	178	86.846	81.499	-5.347
100	179	89.348	83.385	-5.963
100	180	90.223	84.237	-5.986
100	181	89.027	82.501	-6.526
100	182	87.409	82.003	-5.405
Max		92.420	91.542	5.671
Average		88.124	85.778	-2.346
Min		83.359	80.422	-7.366
Std Dev		2.609	3.100	2.668

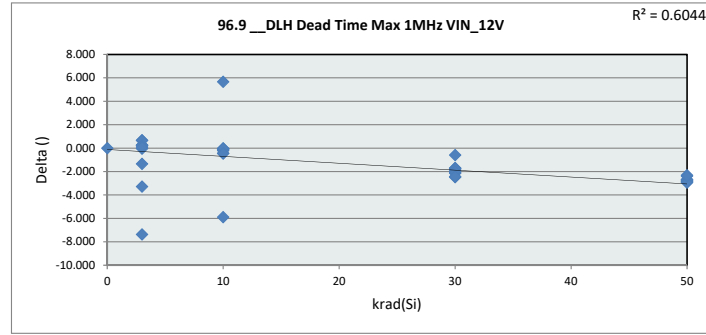

96.9 DLH Dead Time						
Test Site	DAL-FL					
Tester	ETS364					
Test Number	EB672302					
Max Limit	113.5					
Min Limit	74					
krad(Si)	0	3	10	30	50	100
LL	74.000	74.000	74.000	74.000	74.000	74.000
Min	91.542	83.718	83.816	82.772	80.422	81.499
Average	91.542	85.997	88.696	86.650	84.396	82.574
Max	91.542	89.137	91.344	88.224	88.074	84.237
UL	113.500	113.500	113.500	113.500	113.500	113.500

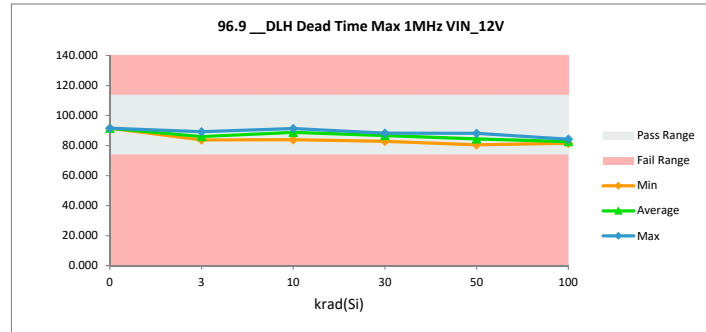

TID HDR Report
TPS7H6003-SP (5962R2220101VXC)

96.10_DLH Dead Time Min 2MHz		
Test Site	DAL-FL	DAL-FL
Tester	ETS364	ETS364
Test Number	EB672302	EB672302
Unit	nsec	
Max Limit	10	10
Min Limit	0	0

krad(Si)	Serial #	pre_short (rtp)	(2)'ST_Combo (rpt)	Delta
0	Ctrl	3.553	3.553	0.000
3	58	3.824	4.697	0.873
3	59	3.358	4.324	0.966
3	60	3.058	3.916	0.859
3	61	3.933	4.516	0.584
3	62	3.395	4.326	0.932
3	134	3.332	4.713	1.380
3	137	3.849	4.706	0.857
3	138	4.013	4.824	0.811
3	139	4.077	4.383	0.306
3	236	2.924	4.595	1.671
10	63	3.756	4.368	0.612
10	64	3.516	4.330	0.814
10	65	3.550	4.319	0.769
10	66	3.777	4.621	0.844
10	150	3.394	3.793	0.399
10	237	3.934	4.559	0.626
10	241	3.591	4.978	1.387
10	242	3.161	3.663	0.502
10	243	3.946	4.546	0.600
10	244	4.338	4.779	0.441
30	141	3.335	4.098	0.762
30	144	4.023	4.798	0.775
30	145	4.391	5.081	0.689
30	146	3.844	4.507	0.663
30	147	3.605	4.145	0.541
30	132	4.029	4.826	0.797
30	133	3.922	4.221	0.299
30	135	3.933	5.148	1.215
30	245	3.946	4.402	0.455
30	246	3.141	3.583	0.442
50	67	3.886	4.371	0.485
50	68	3.254	4.810	1.556
50	69	3.643	4.403	0.760
50	71	3.868	4.616	0.748
50	72	3.154	4.352	1.199
50	172	4.698	5.117	0.419
50	173	3.969	4.318	0.349
50	174	3.095	4.430	1.335
50	183	3.247	3.549	0.302
50	186	4.444	4.968	0.524
100	95	3.776	5.155	1.379
100	102	3.404	4.254	0.851
100	104	3.585	4.710	1.125
100	105	3.441	4.458	1.016
100	106	3.866	4.892	1.026
100	178	3.825	4.366	0.541
100	179	3.878	4.404	0.527
100	180	3.678	4.648	0.969
100	181	3.649	4.488	0.838
100	182	3.512	4.189	0.677
Max		4.698	5.155	1.671
Average		3.692	4.467	0.774
Min		2.924	3.549	0.000
Std Dev		0.376	0.395	0.351

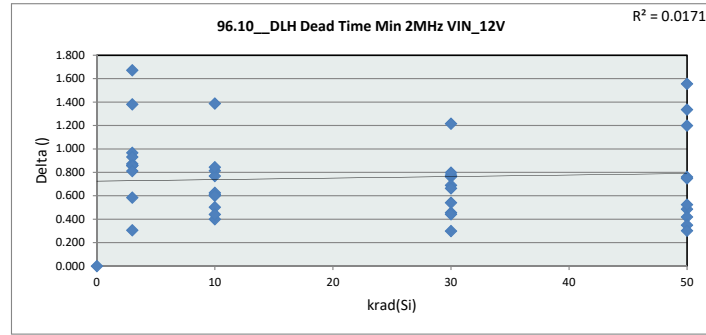

96.10_DLH Dead Time

Test Site	DAL-FL
Tester	ETS364
Test Number	EB672302
Max Limit	10
Min Limit	0

krad(Si)	0	3	10	30	50	100
LL	0.000	0.000	0.000	0.000	0.000	0.000
Min	3.553	3.916	3.663	3.583	3.549	4.189
Average	3.553	4.500	4.396	4.481	4.493	4.556
Max	3.553	4.824	4.978	5.148	5.117	5.155
UL	10.000	10.000	10.000	10.000	10.000	10.000

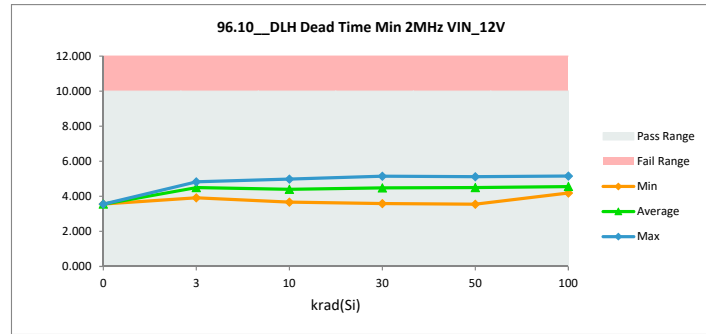

TID HDR Report
TPS7H6003-SP (5962R2220101VXC)

96.11_DLH Dead Time Small 2M		
Test Site	DAL-FL	DAL-FL
Tester	ETS364	ETS364
Test Number	EB672302	EB672302
Unit	nsec	
Max Limit	15.5	15.5
Min Limit	8	8

krad(Si)	Serial #	pre_short (rtp)	(2)ST_Combo (rpt)	Delta
0	Ctrl	10.793	10.793	0.000
3	58	10.852	11.574	0.722
3	59	10.006	10.918	0.912
3	60	10.089	10.829	0.741
3	61	10.506	11.093	0.587
3	62	10.014	10.720	0.706
3	134	10.463	11.095	0.632
3	137	10.321	11.289	0.968
3	138	10.356	11.207	0.851
3	139	10.938	11.143	0.205
3	236	10.274	11.423	1.149
10	63	10.755	11.246	0.491
10	64	10.677	11.269	0.591
10	65	10.657	11.264	0.606
10	66	10.422	11.103	0.681
10	150	10.393	10.852	0.459
10	237	10.368	11.572	1.204
10	241	10.599	11.373	0.774
10	242	10.366	10.962	0.595
10	243	10.961	11.418	0.457
10	244	11.328	11.636	0.308
30	141	10.248	10.598	0.350
30	144	11.008	11.373	0.365
30	145	10.920	11.288	0.368
30	146	10.806	11.066	0.260
30	147	10.520	10.662	0.142
30	132	11.015	11.377	0.362
30	133	10.816	10.815	-0.001
30	135	10.327	11.372	1.045
30	245	10.851	10.894	0.043
30	246	10.137	10.333	0.196
50	67	10.404	10.408	0.004
50	68	10.268	11.321	1.053
50	69	10.536	10.827	0.291
50	71	10.234	10.499	0.265
50	72	10.082	10.709	0.627
50	172	11.256	11.411	0.155
50	173	11.039	11.017	-0.022
50	174	10.185	10.941	0.756
50	183	10.173	10.088	-0.084
50	186	10.916	10.975	0.060
100	95	10.902	11.141	0.239
100	102	10.413	10.171	-0.242
100	104	10.666	10.801	0.135
100	105	10.455	10.448	-0.007
100	106	10.866	10.693	-0.173
100	178	10.697	10.481	-0.216
100	179	10.791	10.467	-0.324
100	180	10.704	10.842	0.138
100	181	10.637	10.439	-0.197
100	182	10.413	10.369	-0.044
	Max	11.328	11.636	1.204
	Average	10.577	10.953	0.376
	Min	10.006	10.088	-0.324
	Std Dev	0.324	0.388	0.392

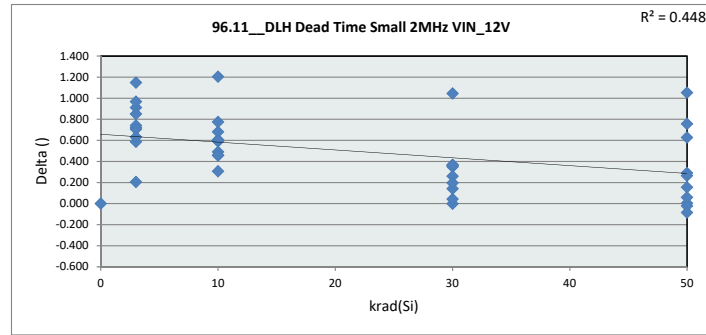

96.11_DLH Dead Time Small 2MHz VIN_12V						
Test Site	DAL-FL					
Tester	ETS364					
Test Number	EB672302					
Max Limit	15.5					
Min Limit	8					
krad(Si)	0	3	10	30	50	100
LL	8.000	8.000	8.000	8.000	8.000	8.000
Min	10.794	10.720	10.852	10.333	10.088	10.171
Average	10.794	11.129	11.269	10.978	10.820	10.585
Max	10.794	11.574	11.636	11.377	11.411	11.141
UL	15.500	15.500	15.500	15.500	15.500	15.500

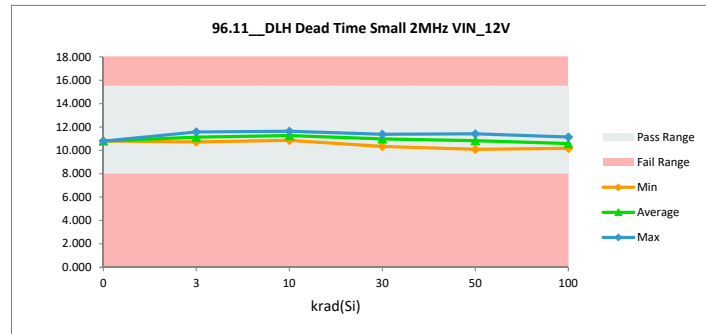

TID HDR Report
TPS7H6003-SP (5962R2220101VXC)

96.12_DLH Dead Time Mid 2MH		
Test Site	DAL-FL	DAL-FL
Tester	ETS364	ETS364
Test Number	EB672302	EB672302
Unit	nsec	
Max Limit	24	
Min Limit	15.5	

krad(Si)	Serial #	pre_short (rtp) (2)	ST_Combo (rpt) (Delta
0	Ctrl	19.433	19.433	0.000
3	58	19.038	19.640	0.602
3	59	17.788	18.465	0.677
3	60	18.309	18.860	0.551
3	61	18.306	18.883	0.577
3	62	17.857	18.490	0.633
3	134	18.804	18.663	-0.141
3	137	18.054	18.622	0.568
3	138	18.006	18.863	0.857
3	139	19.029	19.268	0.240
3	236	18.917	19.709	0.792
10	63	19.175	19.653	0.478
10	64	19.135	19.396	0.261
10	65	19.043	19.422	0.379
10	66	18.222	18.753	0.531
10	150	18.766	19.129	0.363
10	237	18.104	19.666	1.561
10	241	18.890	18.751	-0.139
10	242	18.920	19.133	0.213
10	243	19.198	19.557	0.359
10	244	19.351	19.574	0.223
30	141	18.536	18.608	0.072
30	144	19.279	19.212	-0.067
30	145	18.753	18.492	-0.261
30	146	18.999	18.913	-0.086
30	147	18.687	18.633	-0.054
30	132	19.383	19.526	0.144
30	133	18.921	18.941	0.020
30	135	18.012	18.847	0.835
30	245	19.168	18.928	-0.239
30	246	18.497	18.377	-0.120
50	67	18.048	17.753	-0.296
50	68	18.509	19.321	0.812
50	69	18.852	18.965	0.113
50	71	18.105	17.953	-0.152
50	72	18.322	18.509	0.187
50	172	18.915	18.834	-0.081
50	173	19.437	18.894	-0.542
50	174	18.743	19.017	0.274
50	183	18.522	17.861	-0.661
50	186	18.576	18.547	-0.029
100	95	19.236	18.621	-0.616
100	102	18.670	17.753	-0.916
100	104	18.954	18.501	-0.453
100	105	18.798	17.959	-0.838
100	106	19.045	18.187	-0.858
100	178	18.878	18.179	-0.699
100	179	19.078	18.125	-0.953
100	180	19.121	18.532	-0.589
100	181	18.921	18.074	-0.847
100	182	18.567	17.830	-0.737
	Max	19.437	19.709	1.561
	Average	18.743	18.781	0.038
	Min	17.788	17.753	-0.953
	Std Dev	0.438	0.548	0.556

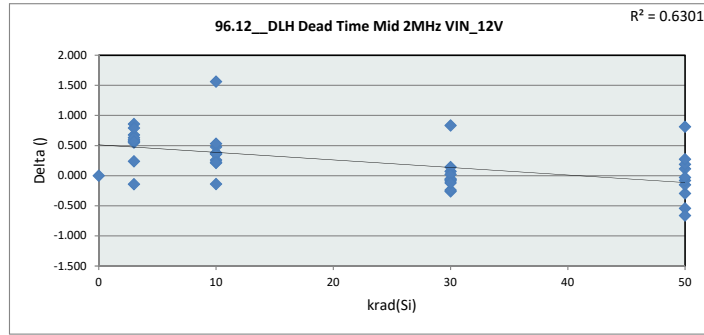

96.12_DLH Dead Time	
Test Site	DAL-FL
Tester	ETS364
Test Number	EB672302
Max Limit	24
Min Limit	15.5

krad(Si)	0	3	10	30	50	100
LL	15.500	15.500	15.500	15.500	15.500	15.500
Min	19.433	18.465	18.751	18.377	17.753	17.753
Average	19.433	18.946	19.304	18.848	18.565	18.176
Max	19.433	19.709	19.666	19.526	19.321	18.621
UL	24.000	24.000	24.000	24.000	24.000	24.000

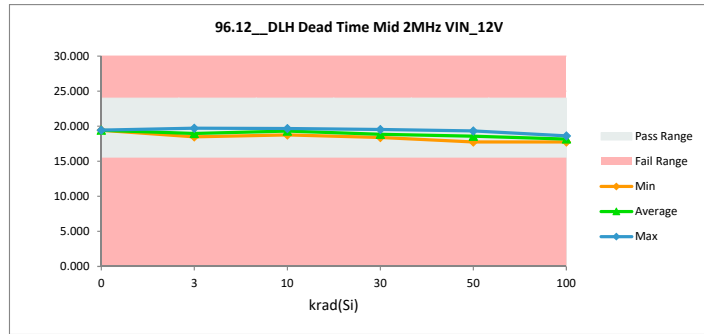

TID HDR Report
TPS7H6003-SP (5962R2220101VXC)

96.13 DLH Dead Time Large 2MHz		
Test Site	DAL-FL	DAL-FL
Tester	ETS364	ETS364
Test Number	EB672302	EB672302
Unit	nsec	
Max Limit	59	59
Min Limit	36	36

krad(Si)	Serial #	pre_short (rtp)	(2)'ST_Combo (rpt)	Delta
0	Ctrl	47.406	47.406	0.000
3	58	46.011	46.474	0.463
3	59	43.622	44.283	0.661
3	60	45.056	45.573	0.517
3	61	43.826	44.380	0.554
3	62	43.575	44.300	0.725
3	134	46.695	44.029	-2.665
3	137	44.060	43.905	-0.155
3	138	43.610	43.868	0.257
3	139	45.699	45.832	0.133
3	236	47.132	46.224	-0.907
10	63	46.525	46.848	0.323
10	64	46.650	46.921	0.272
10	65	46.665	46.966	0.301
10	66	43.747	44.113	0.367
10	150	46.092	46.526	0.434
10	237	43.417	46.158	2.740
10	241	45.782	43.870	-1.912
10	242	46.372	46.478	0.106
10	243	45.945	46.075	0.130
10	244	46.283	46.131	-0.152
30	141	45.811	45.068	-0.743
30	144	46.221	45.409	-0.813
30	145	44.390	43.855	-0.535
30	146	46.097	45.217	-0.880
30	147	45.654	45.065	-0.589
30	132	46.442	45.884	-0.559
30	133	45.994	45.294	-0.699
30	135	43.506	43.919	0.413
30	245	46.205	45.525	-0.680
30	246	46.089	44.907	-1.182
50	67	43.567	42.450	-1.117
50	68	46.006	45.245	-0.761
50	69	46.031	44.674	-1.357
50	71	43.722	42.527	-1.194
50	72	44.912	44.058	-0.854
50	172	44.253	43.542	-0.711
50	173	46.515	45.075	-1.441
50	174	46.481	45.771	-0.710
50	183	45.643	44.210	-1.433
50	186	44.099	43.053	-1.046
100	95	46.365	43.920	-2.445
100	102	45.674	42.767	-2.906
100	104	45.946	43.156	-2.791
100	105	45.799	42.857	-2.942
100	106	46.082	43.156	-2.926
100	178	45.179	42.897	-2.282
100	179	46.026	43.415	-2.611
100	180	46.536	43.966	-2.569
100	181	46.048	42.751	-3.298
100	182	45.230	42.859	-2.371
	Max	47.406	47.406	2.740
	Average	45.504	44.683	-0.820
	Min	43.417	42.450	-3.298
	Std Dev	1.111	1.352	1.260

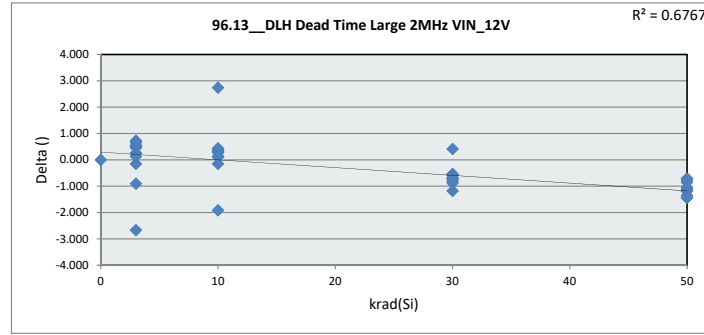

96.13 DLH Dead Time Large 2MHz VIN_12V						
Test Site	DAL-FL					
Tester	ETS364					
Test Number	EB672302					
Max Limit	59					
Min Limit	36					
krad(Si)	0	3	10	30	50	100
LL	36.000	36.000	36.000	36.000	36.000	36.000
Min	47.406	43.868	43.870	43.855	42.450	42.751
Average	47.406	44.887	46.009	45.014	44.060	43.174
Max	47.406	46.474	46.966	45.884	45.771	43.966
UL	59.000	59.000	59.000	59.000	59.000	59.000

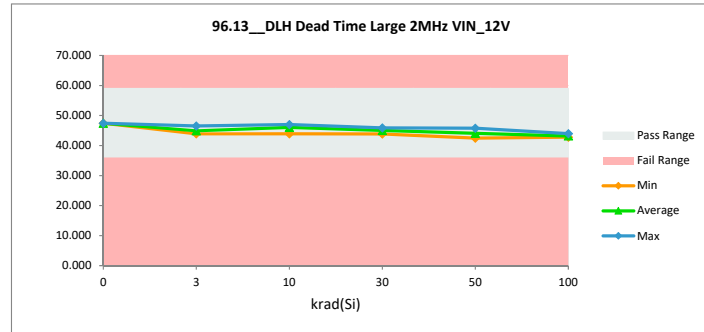

TID HDR Report
TPS7H6003-SP (5962R2220101VXC)

96.14 DLH Dead Time Max 2MHz		
Test Site	DAL-FL	DAL-FL
Tester	ETS364	ETS364
Test Number	EB672302	EB672302
Unit	nsec	
Max Limit	113.5	113.5
Min Limit	74	74

krad(Si)	Serial #	pre_short (rtp)	(2)'ST_Combo (rpt)	Delta
0	Ctrl	92.506	92.506	0.000
3	58	89.515	90.011	0.496
3	59	85.363	86.224	0.861
3	60	88.189	88.700	0.511
3	61	84.976	85.465	0.489
3	62	84.570	85.019	0.448
3	134	92.039	84.208	-7.831
3	137	85.698	84.149	-1.549
3	138	84.190	84.186	-0.005
3	139	88.313	88.574	0.261
3	236	93.335	89.480	-3.855
10	63	91.567	91.415	-0.152
10	64	92.248	91.842	-0.406
10	65	91.657	91.413	-0.245
10	66	84.663	84.563	-0.101
10	150	91.191	91.084	-0.107
10	237	83.835	89.701	5.866
10	241	90.382	84.408	-5.974
10	242	91.004	90.792	-0.212
10	243	89.032	88.726	-0.305
10	244	89.820	89.578	-0.242
30	141	90.198	88.510	-1.688
30	144	90.163	88.451	-1.712
30	145	85.441	83.206	-2.235
30	146	90.451	88.231	-2.219
30	147	89.583	87.741	-1.842
30	132	90.724	88.993	-1.732
30	133	89.718	87.674	-2.043
30	135	84.082	83.628	-0.453
30	245	90.691	88.427	-2.264
30	246	90.556	88.376	-2.180
50	67	83.770	80.995	-2.775
50	68	90.273	87.253	-3.020
50	69	90.137	87.219	-2.919
50	71	84.098	81.216	-2.882
50	72	88.031	85.318	-2.713
50	172	84.932	82.482	-2.450
50	173	90.130	87.353	-2.777
50	174	91.559	88.954	-2.605
50	183	89.948	87.085	-2.863
50	186	84.462	81.961	-2.502
100	95	90.381	84.508	-5.873
100	102	89.112	82.366	-6.746
100	104	89.797	83.619	-6.178
100	105	89.356	82.422	-6.934
100	106	90.126	83.047	-7.079
100	178	87.481	82.146	-5.335
100	179	89.951	83.968	-5.982
100	180	90.836	84.743	-6.093
100	181	89.708	83.207	-6.501
100	182	88.131	82.604	-5.527
	Max	93.335	92.506	5.866
	Average	88.783	86.426	-2.356
	Min	83.770	80.995	-7.831
	Std Dev	2.710	3.156	2.722

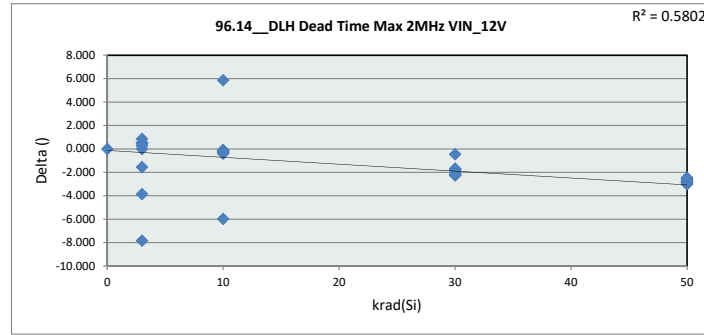

96.14 DLH Dead Time						
Test Site	DAL-FL					
Tester	ETS364					
Test Number	EB672302					
Max Limit	113.5					
Min Limit	74					
krad(Si)	0	3	10	30	50	100
LL	74.000	74.000	74.000	74.000	74.000	74.000
Min	92.506	84.149	84.408	83.206	80.995	82.146
Average	92.506	86.602	89.352	87.324	84.984	83.263
Max	92.506	90.011	91.842	88.993	88.954	84.743
UL	113.500	113.500	113.500	113.500	113.500	113.500

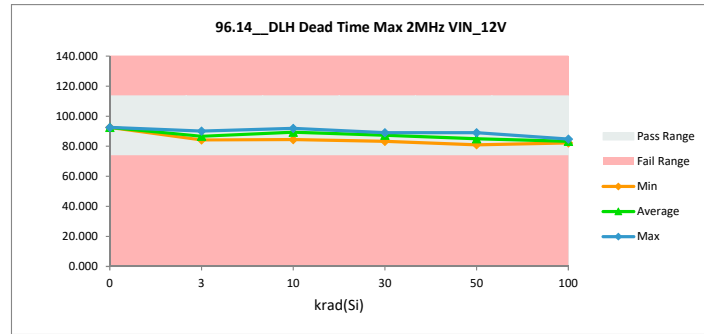

TID HDR Report
TPS7H6003-SP (5962R2220101VXC)

96.19 DHL Dead Time Min 500kHz		
Test Site	DAL-FL	DAL-FL
Tester	ETS364	ETS364
Test Number	EB672302	EB672302
Unit	nsec	
Max Limit	10	10
Min Limit	0	0

krad(Si)	Serial #	pre_short (rtp)	(2)ST_Combo (rpt)	Delta
0	Ctrl	3.801	3.801	0.000
3	58	4.574	3.949	-0.625
3	59	4.790	4.286	-0.503
3	60	4.735	4.266	-0.468
3	61	3.926	3.401	-0.525
3	62	4.072	3.334	-0.738
3	134	4.408	4.364	-0.044
3	137	4.345	4.175	-0.170
3	138	4.034	4.086	0.052
3	139	4.499	4.218	-0.281
3	236	4.212	4.300	0.088
10	63	4.775	4.356	-0.420
10	64	4.295	3.968	-0.326
10	65	4.445	4.067	-0.378
10	66	3.593	3.340	-0.254
10	150	4.841	4.760	-0.082
10	237	4.586	4.377	-0.209
10	241	4.512	4.096	-0.415
10	242	4.367	4.101	-0.267
10	243	3.452	3.523	0.071
10	244	4.087	3.908	-0.179
30	141	4.184	4.240	0.056
30	144	4.071	4.033	-0.038
30	145	3.985	3.487	-0.499
30	146	4.068	3.964	-0.104
30	147	4.792	4.536	-0.255
30	132	3.785	3.926	0.141
30	133	4.547	4.478	-0.068
30	135	4.629	3.165	-1.464
30	245	4.013	3.786	-0.227
30	246	4.409	4.385	-0.024
50	67	4.774	4.503	-0.271
50	68	3.876	4.000	0.124
50	69	4.715	4.403	-0.312
50	71	3.450	2.943	-0.507
50	72	4.547	4.200	-0.346
50	172	4.214	3.965	-0.249
50	173	4.167	4.225	0.058
50	174	4.264	3.962	-0.302
50	183	4.609	4.636	0.027
50	186	3.515	3.536	0.022
100	95	4.789	4.514	-0.275
100	102	4.305	4.282	-0.023
100	104	4.738	4.512	-0.226
100	105	4.073	3.662	-0.411
100	106	4.112	4.169	0.057
100	178	4.433	4.473	0.040
100	179	4.009	4.460	0.451
100	180	4.440	4.597	0.158
100	181	4.363	4.344	-0.019
100	182	3.621	3.695	0.074
Max		4.841	4.760	0.451
Average		4.271	4.074	-0.198
Min		3.450	2.943	-1.464
Std Dev		0.378	0.408	0.298

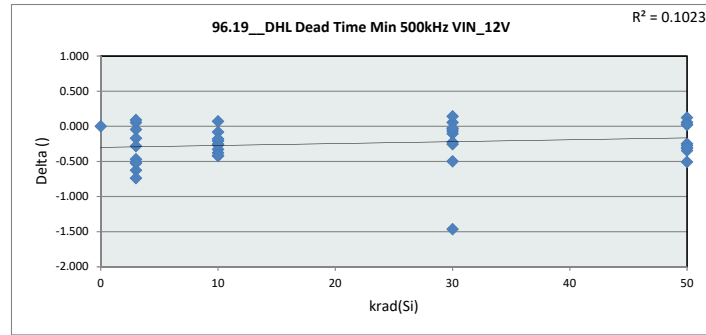

96.19 DHL Dead Time Min 500kHz		
Test Site	DAL-FL	DAL-FL
Tester	ETS364	ETS364
Test Number	EB672302	EB672302
Max Limit	10	10
Min Limit	0	0

krad(Si)	0	3	10	30	50	100
LL	0.000	0.000	0.000	0.000	0.000	0.000
Min	3.801	3.334	3.340	3.165	2.943	3.662
Average	3.801	4.038	4.050	4.000	4.037	4.271
Max	3.801	4.364	4.760	4.536	4.636	4.597
UL	10.000	10.000	10.000	10.000	10.000	10.000

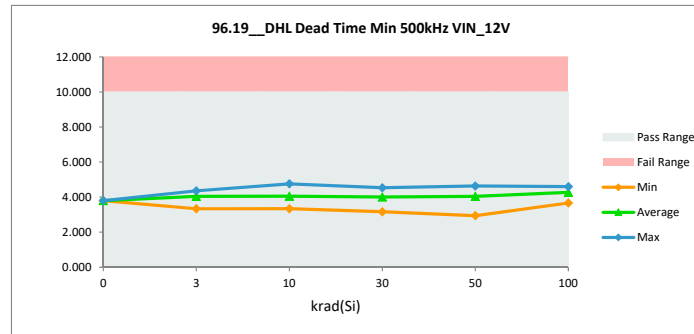

TID HDR Report
TPS7H6003-SP (5962R2220101VXC)

96.20 DHL Dead Time Small 50		
Test Site	DAL-FL	DAL-FL
Tester	ETS364	ETS364
Test Number	EB672302	EB672302
Unit	nsec	
Max Limit	15	15
Min Limit	6	6

krad(Si)	Serial #	pre_short (rtp) (2)	ST_Combo (rpt) (Delta
0	Ctrl	9.540	9.540	0.000
3	58	10.166	9.600	-0.566
3	59	10.165	9.755	-0.410
3	60	10.010	9.602	-0.408
3	61	9.526	9.172	-0.354
3	62	9.762	9.233	-0.529
3	134	9.853	9.618	-0.235
3	137	9.625	9.532	-0.093
3	138	9.559	9.548	-0.011
3	139	9.796	9.511	-0.284
3	236	9.454	9.910	0.456
10	63	10.443	10.012	-0.431
10	64	9.965	9.529	-0.436
10	65	9.853	9.466	-0.387
10	66	9.323	8.874	-0.449
10	150	10.114	10.098	-0.016
10	237	10.109	9.904	-0.205
10	241	9.977	9.577	-0.400
10	242	10.009	9.632	-0.376
10	243	9.292	9.046	-0.245
10	244	9.642	9.506	-0.136
30	141	9.512	9.266	-0.246
30	144	9.821	9.284	-0.537
30	145	9.702	9.161	-0.541
30	146	9.592	9.530	-0.062
30	147	10.134	9.733	-0.402
30	132	9.648	9.506	-0.142
30	133	10.117	9.991	-0.126
30	135	10.202	8.807	-1.395
30	245	9.537	9.141	-0.396
30	246	9.816	9.572	-0.244
50	67	10.413	9.808	-0.605
50	68	9.502	9.212	-0.289
50	69	10.208	9.508	-0.701
50	71	9.184	8.201	-0.982
50	72	9.802	9.201	-0.601
50	172	9.645	9.065	-0.580
50	173	9.730	9.451	-0.279
50	174	9.869	9.374	-0.494
50	183	9.993	9.941	-0.052
50	186	9.254	8.985	-0.269
100	95	10.089	9.314	-0.775
100	102	9.879	9.376	-0.503
100	104	10.282	9.487	-0.795
100	105	9.854	8.770	-1.084
100	106	9.746	9.256	-0.490
100	178	9.933	9.603	-0.330
100	179	9.657	9.493	-0.164
100	180	9.986	9.740	-0.246
100	181	9.907	9.365	-0.542
100	182	9.196	8.875	-0.322
Max		10.443	10.098	0.456
Average		9.812	9.425	-0.386
Min		9.184	8.201	-1.395
Std Dev		0.305	0.359	0.298

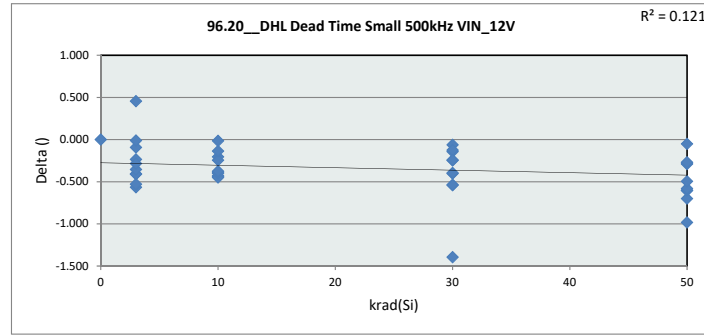

96.20 DHL Dead Time Small 500kHz VIN_12V						
Test Site	DAL-FL					
Tester	ETS364					
Test Number	EB672302					
Max Limit	15					
Min Limit	6					
krad(Si)	0	3	10	30	50	100
LL	6.000	6.000	6.000	6.000	6.000	6.000
Min	9.540	9.172	8.874	8.807	8.201	8.770
Average	9.540	9.548	9.564	9.399	9.275	9.328
Max	9.540	9.910	10.098	9.991	9.941	9.740
UL	15.000	15.000	15.000	15.000	15.000	15.000

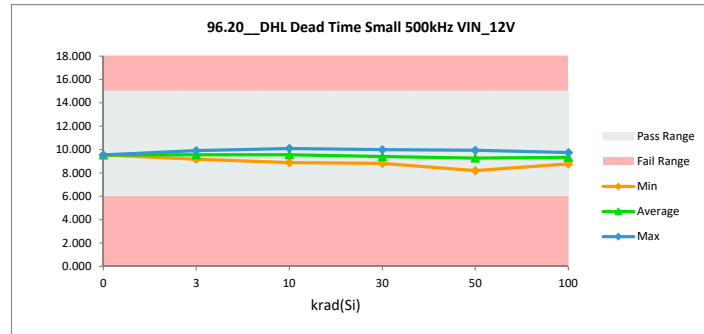

TID HDR Report
TPS7H6003-SP (5962R2220101VXC)

96.21 DHL Dead Time Mid 500kHz		
Test Site	DAL-FL	DAL-FL
Tester	ETS364	ETS364
Test Number	EB672302	EB672302
Unit	nsec	
Max Limit	24.5	24.5
Min Limit	16	16

krad(Si)	Serial #	pre_short (rtp)	(2)ST_Combo (rpt)	Delta
0	Ctrl	19.822	19.822	0.000
3	58	20.115	19.636	-0.479
3	59	19.778	19.360	-0.418
3	60	19.592	19.296	-0.296
3	61	19.791	19.232	-0.559
3	62	20.157	19.492	-0.666
3	134	19.920	19.349	-0.572
3	137	19.350	19.369	0.019
3	138	19.723	19.318	-0.406
3	139	19.603	19.266	-0.337
3	236	19.185	19.760	0.575
10	63	20.677	20.125	-0.551
10	64	20.061	19.659	-0.402
10	65	19.653	19.112	-0.542
10	66	19.622	18.975	-0.646
10	150	19.866	19.824	-0.042
10	237	20.123	19.673	-0.450
10	241	19.645	19.226	-0.418
10	242	20.125	19.694	-0.431
10	243	19.604	19.466	-0.138
10	244	19.633	19.199	-0.434
30	141	19.255	18.833	-0.422
30	144	19.977	19.272	-0.705
30	145	20.125	19.300	-0.825
30	146	19.713	19.191	-0.522
30	147	19.878	19.331	-0.548
30	132	19.926	19.632	-0.294
30	133	20.275	19.900	-0.376
30	135	20.187	18.843	-1.344
30	245	19.537	19.004	-0.532
30	246	19.459	18.993	-0.465
50	67	20.512	19.538	-0.974
50	68	19.667	19.164	-0.503
50	69	20.260	19.102	-1.159
50	71	19.434	18.386	-1.047
50	72	19.686	18.544	-1.142
50	172	19.490	18.422	-1.069
50	173	19.813	19.513	-0.300
50	174	19.975	19.075	-0.899
50	183	19.952	19.482	-0.470
50	186	19.676	19.097	-0.579
100	95	19.890	18.200	-1.690
100	102	19.917	18.591	-1.327
100	104	20.236	18.822	-1.414
100	105	20.322	18.419	-1.903
100	106	19.868	18.672	-1.196
100	178	20.003	18.961	-1.042
100	179	19.753	18.972	-0.782
100	180	20.027	19.117	-0.909
100	181	19.987	18.619	-1.368
100	182	19.358	18.337	-1.021
	Max	20.677	20.125	0.575
	Average	19.847	19.180	-0.667
	Min	19.185	18.200	-1.903
	Std Dev	0.312	0.443	0.459

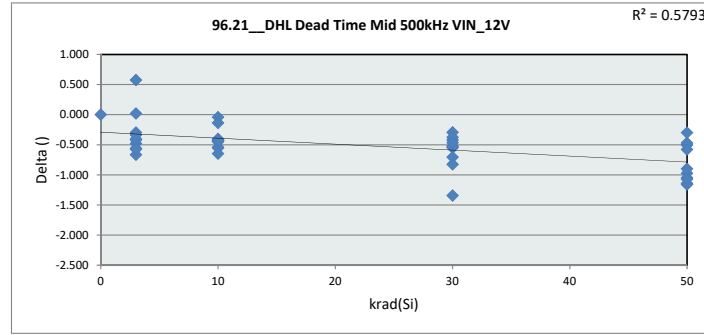

96.21 DHL Dead Time		
Test Site	DAL-FL	
Tester	ETS364	
Test Number	EB672302	
Max Limit	24.5	
Min Limit	16	

krad(Si)	0	3	10	30	50	100
LL	16.000	16.000	16.000	16.000	16.000	16.000
Min	19.822	19.232	18.975	18.833	18.386	18.200
Average	19.822	19.408	19.495	19.230	19.032	18.671
Max	19.822	19.760	20.125	19.900	19.538	19.117
UL	24.500	24.500	24.500	24.500	24.500	24.500

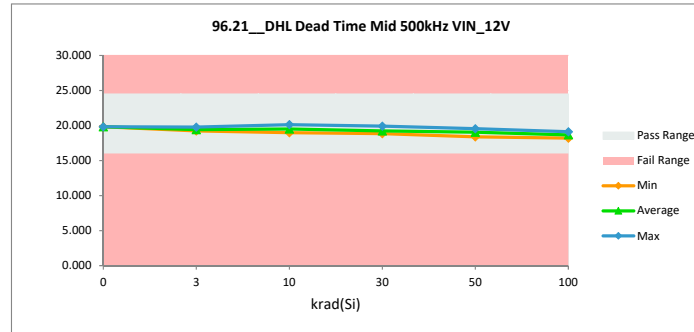

TID HDR Report
TPS7H6003-SP (5962R2220101VXC)

96.22 DHL Dead Time Large 50		
Test Site	DAL-FL	DAL-FL
Tester	ETS364	ETS364
Test Number	EB672302	EB672302
Unit	nsec	
Max Limit	61	61
Min Limit	44	44

krad(Si)	Serial #	pre_short (rtp) (2)	ST_Combo (rpt) (Delta
0	Ctrl	50.895	50.895	0.000
3	58	50.597	50.019	-0.578
3	59	49.011	48.591	-0.420
3	60	49.064	48.635	-0.429
3	61	51.093	50.471	-0.622
3	62	52.201	51.524	-0.677
3	134	50.613	49.127	-1.485
3	137	48.994	49.123	0.128
3	138	50.657	49.149	-1.508
3	139	49.464	48.986	-0.478
3	236	48.750	49.738	0.987
10	63	51.882	51.033	-0.849
10	64	51.258	50.662	-0.596
10	65	49.603	48.957	-0.645
10	66	50.893	50.038	-0.855
10	150	49.386	49.069	-0.317
10	237	50.674	49.730	-0.944
10	241	49.459	49.179	-0.280
10	242	50.974	50.245	-0.729
10	243	51.287	50.911	-0.375
10	244	50.088	49.559	-0.529
30	141	48.924	47.678	-1.246
30	144	50.884	49.611	-1.274
30	145	51.848	50.280	-1.568
30	146	50.532	49.436	-1.096
30	147	49.848	48.449	-1.399
30	132	51.546	50.551	-0.995
30	133	51.317	50.182	-1.135
30	135	50.549	49.759	-0.790
30	245	49.984	48.805	-1.179
30	246	49.090	48.047	-1.043
50	67	51.085	49.048	-2.036
50	68	50.546	49.417	-1.129
50	69	50.693	48.332	-2.361
50	71	51.002	48.557	-2.445
50	72	49.521	46.889	-2.633
50	172	49.490	47.357	-2.133
50	173	50.836	49.211	-1.625
50	174	50.792	48.491	-2.301
50	183	50.419	48.516	-1.904
50	186	51.511	49.408	-2.103
100	95	49.585	45.374	-4.211
100	102	50.720	46.995	-3.725
100	104	50.667	47.041	-3.626
100	105	52.145	48.013	-4.132
100	106	51.048	47.636	-3.412
100	178	50.464	47.304	-3.160
100	179	50.549	47.352	-3.198
100	180	50.946	47.554	-3.391
100	181	50.519	46.779	-3.741
100	182	50.268	47.067	-3.201
Max		52.201	51.524	0.987
Average		50.474	48.917	-1.557
Min		48.750	45.374	-4.211
Std Dev		0.870	1.313	1.232

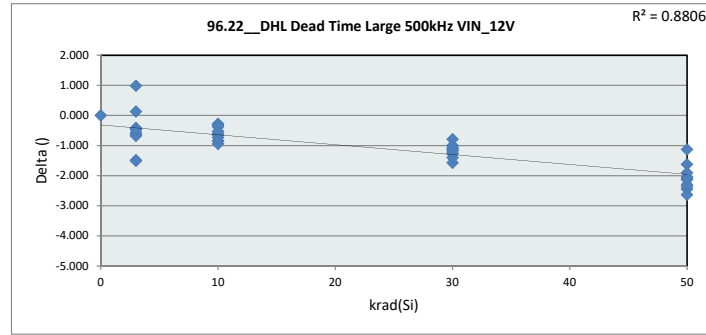

96.22 DHL Dead Time Large 500kHz VIN_12V						
Test Site	DAL-FL					
Tester	ETS364					
Test Number	EB672302					
Max Limit	61					
Min Limit	44					
krad(Si)	0	3	10	30	50	100
LL	44.000	44.000	44.000	44.000	44.000	44.000
Min	50.895	48.591	48.957	47.678	46.889	45.374
Average	50.895	49.536	49.938	49.280	48.523	47.111
Max	50.895	51.524	51.033	50.551	49.417	48.013
UL	61.000	61.000	61.000	61.000	61.000	61.000

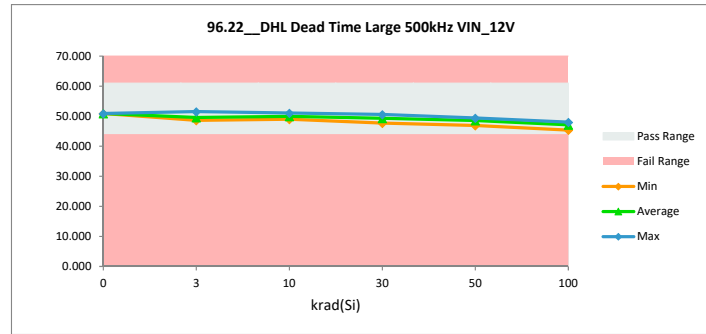

TID HDR Report
TPS7H6003-SP (5962R2220101VXC)

96.23 DHL Dead Time Max 500		
Test Site	DAL-FL	DAL-FL
Tester	ETS364	ETS364
Test Number	EB672302	EB672302
Unit	nsec	
Max Limit	125	125
Min Limit	86	86

krad(Si)	Serial #	pre_short (rtp) (2)	ST_Combo (rpt) (Delta
0	Ctrl	99.657	99.657	0.000
3	58	98.401	97.738	-0.663
3	59	95.055	94.544	-0.510
3	60	95.782	95.403	-0.380
3	61	100.536	99.812	-0.725
3	62	102.587	101.957	-0.630
3	134	99.327	96.490	-2.837
3	137	96.190	96.581	0.392
3	138	99.890	96.508	-3.382
3	139	97.042	96.622	-0.420
3	236	95.333	97.291	1.959
10	63	100.965	100.067	-0.898
10	64	100.964	100.062	-0.902
10	65	96.843	95.788	-1.055
10	66	99.881	98.800	-1.081
10	150	95.492	95.022	-0.470
10	237	98.853	97.201	-1.652
10	241	96.580	96.504	-0.076
10	242	99.392	98.323	-1.069
10	243	101.231	100.434	-0.798
10	244	98.270	97.341	-0.928
30	141	95.885	93.386	-2.499
30	144	100.028	97.438	-2.590
30	145	102.256	99.418	-2.838
30	146	99.287	96.969	-2.318
30	147	97.237	94.875	-2.362
30	132	101.305	99.670	-1.635
30	133	100.753	98.786	-1.967
30	135	98.393	98.543	0.151
30	245	97.858	95.833	-2.025
30	246	95.775	93.874	-1.901
50	67	99.670	95.897	-3.773
50	68	99.186	97.815	-1.371
50	69	98.669	93.890	-4.778
50	71	100.498	96.146	-4.353
50	72	96.346	91.635	-4.711
50	172	96.766	92.497	-4.269
50	173	99.833	96.360	-3.473
50	174	99.492	94.873	-4.618
50	183	98.606	94.275	-4.331
50	186	101.876	97.417	-4.460
100	95	96.660	88.289	-8.371
100	102	99.237	91.656	-7.581
100	104	98.650	91.303	-7.347
100	105	102.809	95.310	-7.499
100	106	100.270	92.920	-7.350
100	178	98.598	91.679	-6.919
100	179	99.113	92.432	-6.680
100	180	99.875	92.638	-7.237
100	181	98.870	91.081	-7.789
100	182	99.037	92.014	-7.023
Max		102.809	101.957	1.959
Average		98.845	95.903	-2.942
Min		95.055	88.289	-8.371
Std Dev		1.979	2.951	2.671

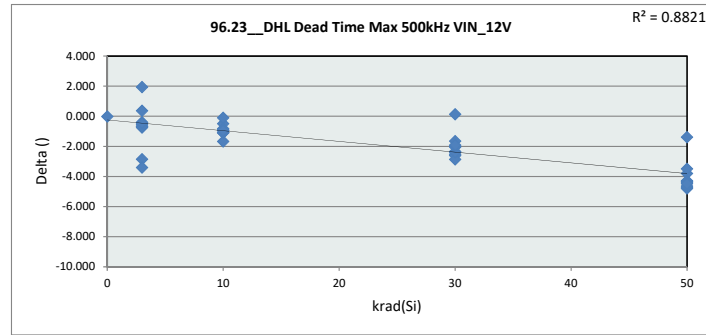

96.23 DHL Dead Time Max 500kHz VIN_12V						
Test Site	DAL-FL					
Tester	ETS364					
Test Number	EB672302					
Max Limit	125					
Min Limit	86					
krad(Si)	0	3	10	30	50	100
LL	86.000	86.000	86.000	86.000	86.000	86.000
Min	99.657	94.544	95.022	93.387	91.636	88.289
Average	99.657	97.295	97.954	96.879	95.081	91.932
Max	99.657	101.957	100.434	99.670	97.815	95.310
UL	125.000	125.000	125.000	125.000	125.000	125.000

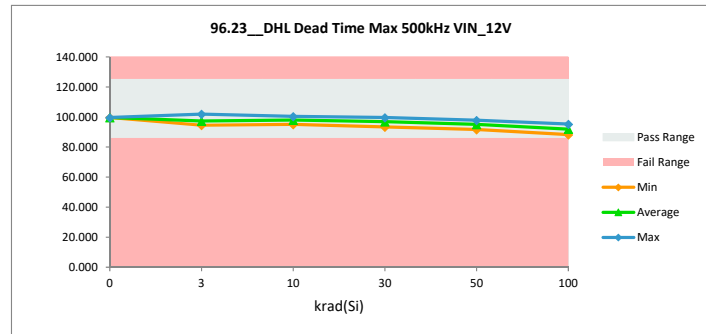

TID HDR Report
TPS7H6003-SP (5962R2220101VXC)

96.24 DHL Dead Time Min 1MHz		
Test Site	DAL-FL	DAL-FL
Tester	ETS364	ETS364
Test Number	EB672302	EB672302
Unit	nsec	
Max Limit	10	10
Min Limit	0	0

krad(Si)	Serial #	pre_short (rtp) (2)	ST_Combo (rpt) (Delta
0	Ctrl	4.289	4.289	0.000
3	58	4.756	4.329	-0.427
3	59	5.183	4.696	-0.487
3	60	4.938	4.708	-0.229
3	61	4.112	3.703	-0.410
3	62	4.288	3.793	-0.496
3	134	4.581	4.360	-0.221
3	137	4.560	4.316	-0.244
3	138	4.147	4.541	0.394
3	139	4.839	4.631	-0.208
3	236	4.297	4.548	0.251
10	63	5.085	4.730	-0.355
10	64	4.493	4.144	-0.349
10	65	4.714	4.356	-0.358
10	66	3.883	3.390	-0.492
10	150	5.058	5.151	0.093
10	237	4.899	4.666	-0.234
10	241	4.791	4.291	-0.500
10	242	4.751	4.407	-0.344
10	243	3.740	3.616	-0.124
10	244	4.356	4.184	-0.172
30	141	4.574	4.205	-0.369
30	144	4.433	4.164	-0.268
30	145	4.239	3.622	-0.617
30	146	4.413	4.220	-0.193
30	147	5.020	4.592	-0.427
30	132	4.075	4.071	-0.003
30	133	4.834	4.708	-0.127
30	135	4.886	3.533	-1.353
30	245	4.266	4.035	-0.231
30	246	4.761	4.525	-0.236
50	67	5.047	4.875	-0.172
50	68	4.137	4.235	0.098
50	69	4.886	4.395	-0.491
50	71	3.739	3.104	-0.635
50	72	4.894	4.532	-0.362
50	172	4.372	4.246	-0.126
50	173	4.394	4.571	0.177
50	174	4.586	4.185	-0.402
50	183	4.860	4.882	0.021
50	186	3.846	3.693	-0.153
100	95	5.060	4.649	-0.411
100	102	4.513	4.430	-0.082
100	104	5.067	4.839	-0.229
100	105	4.498	3.815	-0.683
100	106	4.379	4.521	0.141
100	178	4.630	4.765	0.135
100	179	4.311	4.621	0.311
100	180	4.718	4.714	-0.004
100	181	4.626	4.669	0.044
100	182	3.862	4.006	0.144
	Max	5.183	5.151	0.394
	Average	4.543	4.319	-0.224
	Min	3.739	3.104	-1.353
	Std Dev	0.378	0.427	0.299

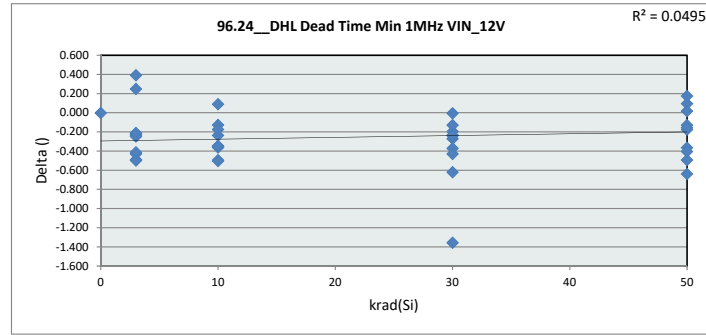

96.24 DHL Dead Time	
Test Site	DAL-FL
Tester	ETS364
Test Number	EB672302
Max Limit	10
Min Limit	0

krad(Si)	0	3	10	30	50	100
LL	0.000	0.000	0.000	0.000	0.000	0.000
Min	4.289	3.703	3.390	3.533	3.104	3.815
Average	4.289	4.362	4.294	4.168	4.272	4.503
Max	4.289	4.708	5.151	4.708	4.882	4.839
UL	10.000	10.000	10.000	10.000	10.000	10.000

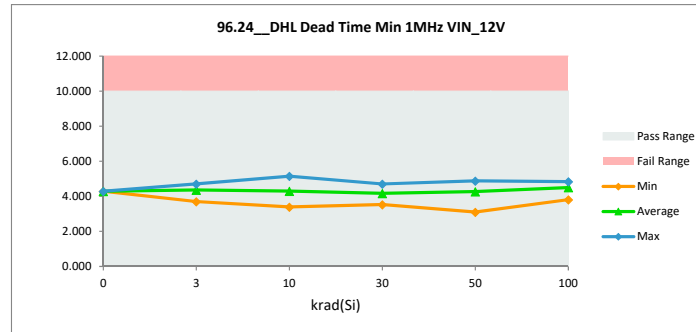

TID HDR Report

TPS7H6003-SP (5962R2220101VXC)

96.25 DHL Dead Time Small 1MHz		
Test Site	DAL-FL	DAL-FL
Tester	ETS364	ETS364
Test Number	EB672302	EB672302
Unit	nsec	
Max Limit	15	15
Min Limit	6	6

krad(Si)	Serial #	pre_short (rtp) (2)	ST_Combo (rpt) (Delta
0	Ctrl	9.807	9.807	0.000
3	58	10.324	9.662	-0.662
3	59	10.444	9.911	-0.534
3	60	10.202	9.802	-0.400
3	61	9.749	9.444	-0.305
3	62	10.033	9.408	-0.626
3	134	10.160	9.796	-0.364
3	137	9.877	9.711	-0.167
3	138	9.831	9.777	-0.054
3	139	10.030	9.823	-0.206
3	236	9.672	10.017	0.344
10	63	10.731	10.379	-0.352
10	64	10.186	9.796	-0.391
10	65	10.164	9.640	-0.524
10	66	9.613	9.074	-0.539
10	150	10.391	10.312	-0.080
10	237	10.476	10.125	-0.351
10	241	10.220	9.764	-0.456
10	242	10.168	9.873	-0.295
10	243	9.566	9.401	-0.164
10	244	9.911	9.591	-0.320
30	141	9.688	9.428	-0.260
30	144	10.082	9.735	-0.347
30	145	9.956	9.365	-0.592
30	146	9.909	9.669	-0.240
30	147	10.419	10.000	-0.419
30	132	9.923	9.691	-0.233
30	133	10.401	10.120	-0.281
30	135	10.469	9.047	-1.422
30	245	9.821	9.418	-0.403
30	246	9.974	9.779	-0.195
50	67	10.630	10.207	-0.424
50	68	9.748	9.573	-0.176
50	69	10.399	9.825	-0.574
50	71	9.478	8.666	-0.811
50	72	10.204	9.488	-0.716
50	172	9.897	9.333	-0.564
50	173	10.016	9.874	-0.142
50	174	10.188	9.599	-0.589
50	183	10.325	10.105	-0.220
50	186	9.533	9.306	-0.227
100	95	10.380	9.349	-1.031
100	102	10.076	9.481	-0.595
100	104	10.566	9.713	-0.852
100	105	10.186	9.106	-1.081
100	106	10.071	9.601	-0.470
100	178	10.218	9.845	-0.373
100	179	10.009	9.537	-0.472
100	180	10.258	9.895	-0.362
100	181	10.160	9.552	-0.609
100	182	9.366	9.073	-0.293
	Max	10.731	10.379	0.344
	Average	10.077	9.657	-0.420
	Min	9.366	8.666	-1.422
	Std Dev	0.309	0.338	0.290

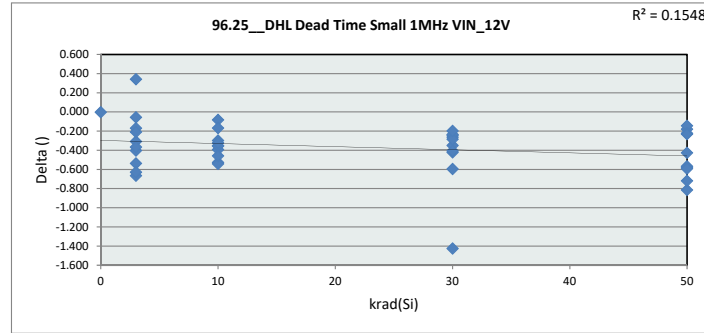

96.25 DHL Dead Time Small 1MHz VIN_12V

96.25 DHL Dead Time Small 1MHz VIN_12V	
Test Site	DAL-FL
Tester	ETS364
Test Number	EB672302
Max Limit	15
Min Limit	6

krad(Si)	0	3	10	30	50	100
LL	6.000	6.000	6.000	6.000	6.000	6.000
Min	9.807	9.408	9.074	9.047	8.666	9.073
Average	9.807	9.735	9.796	9.625	9.597	9.515
Max	9.807	10.017	10.379	10.120	10.207	9.895
UL	15.000	15.000	15.000	15.000	15.000	15.000

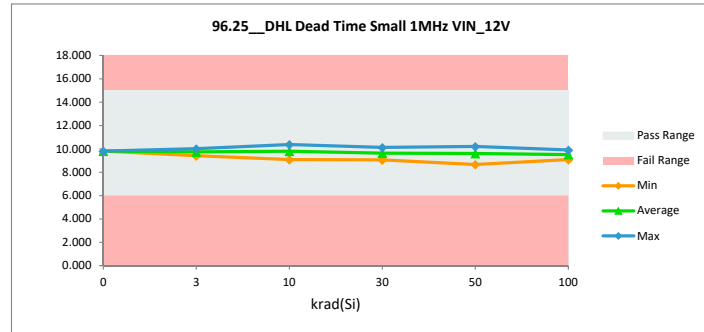

TID HDR Report
TPS7H6003-SP (5962R2220101VXC)

96.26 DHL Dead Time Mid 1MHz		
Test Site	DAL-FL	DAL-FL
Tester	ETS364	ETS364
Test Number	EB672302	EB672302
Unit	nsec	
Max Limit	24.5	24.5
Min Limit	16	16

krad(Si)	Serial #	pre_short (rtp) (2)	ST_Combo (rpt) (Delta
0	Ctrl	20.113	20.113	0.000
3	58	20.504	19.917	-0.587
3	59	20.103	19.750	-0.353
3	60	19.972	19.465	-0.507
3	61	20.213	19.663	-0.550
3	62	20.515	19.856	-0.659
3	134	20.275	19.538	-0.737
3	137	19.594	19.386	-0.208
3	138	20.017	19.633	-0.383
3	139	19.883	19.673	-0.209
3	236	19.433	19.863	0.430
10	63	21.029	20.546	-0.483
10	64	20.408	19.910	-0.499
10	65	19.958	19.529	-0.430
10	66	20.007	19.283	-0.724
10	150	20.198	20.170	-0.028
10	237	20.471	20.022	-0.448
10	241	20.014	19.597	-0.417
10	242	20.424	19.994	-0.429
10	243	19.972	19.705	-0.267
10	244	19.910	19.646	-0.264
30	141	19.527	18.833	-0.694
30	144	20.260	19.618	-0.643
30	145	20.431	19.460	-0.972
30	146	20.062	19.523	-0.539
30	147	20.170	19.687	-0.483
30	132	20.288	19.814	-0.474
30	133	20.576	20.003	-0.573
30	135	20.448	19.271	-1.177
30	245	19.803	19.314	-0.489
30	246	19.746	19.447	-0.299
50	67	20.808	19.920	-0.889
50	68	19.952	19.548	-0.404
50	69	20.559	19.366	-1.193
50	71	19.822	18.468	-1.354
50	72	19.948	18.928	-1.021
50	172	19.834	18.909	-0.925
50	173	20.178	19.744	-0.433
50	174	20.304	19.306	-0.998
50	183	20.363	19.749	-0.614
50	186	19.985	19.203	-0.782
100	95	20.169	18.501	-1.668
100	102	20.175	18.872	-1.303
100	104	20.591	19.023	-1.568
100	105	20.643	18.696	-1.947
100	106	20.332	19.184	-1.148
100	178	20.254	19.244	-1.010
100	179	20.138	19.115	-1.023
100	180	20.411	19.238	-1.173
100	181	20.259	18.992	-1.266
100	182	19.653	18.603	-1.050
	Max	21.029	20.546	0.430
	Average	20.171	19.467	-0.703
	Min	19.433	18.468	-1.947
	Std Dev	0.324	0.449	0.452

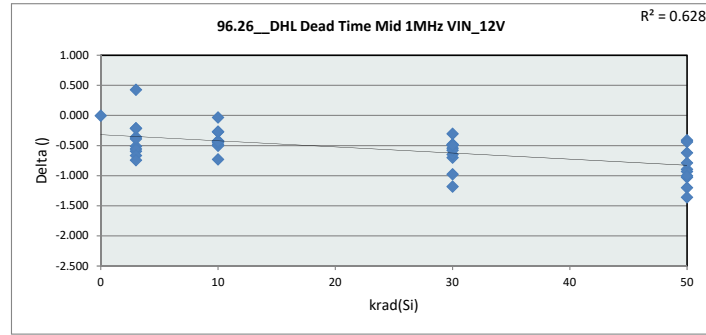

96.26 DHL Dead Time	
Test Site	DAL-FL
Tester	ETS364
Test Number	EB672302
Max Limit	24.5
Min Limit	16

krad(Si)	0	3	10	30	50	100
LL	16.000	16.000	16.000	16.000	16.000	16.000
Min	20.113	19.386	19.283	18.834	18.468	18.501
Average	20.113	19.674	19.840	19.497	19.314	18.947
Max	20.113	19.917	20.546	20.003	19.920	19.244
UL	24.500	24.500	24.500	24.500	24.500	24.500

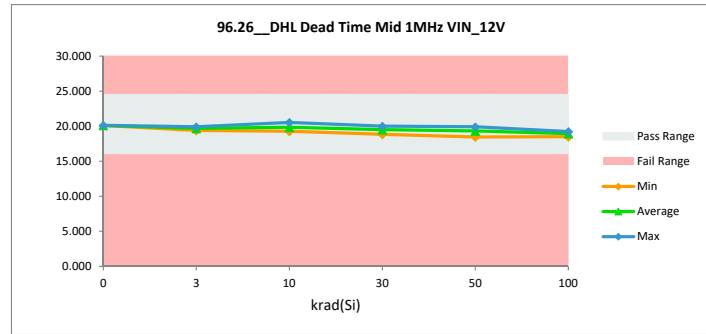

TID HDR Report
TPS7H6003-SP (5962R2220101VXC)

96.27 DHL Dead Time Large 1MHz		
Test Site	DAL-FL	DAL-FL
Tester	ETS364	ETS364
Test Number	EB672302	EB672302
Unit	nsec	
Max Limit	61	61
Min Limit	44	44

krad(Si)	Serial #	pre_short (rtp)	(2)'ST_Combo (rpt)	Delta
0	Ctrl	51.396	51.396	0.000
3	58	51.245	50.458	-0.788
3	59	49.660	49.265	-0.395
3	60	49.747	49.124	-0.622
3	61	51.876	51.012	-0.864
3	62	52.956	52.024	-0.931
3	134	51.295	49.641	-1.654
3	137	49.676	49.633	-0.043
3	138	51.335	49.740	-1.595
3	139	50.085	49.631	-0.455
3	236	49.367	50.223	0.856
10	63	52.533	51.774	-0.759
10	64	51.939	51.221	-0.719
10	65	50.095	49.405	-0.690
10	66	51.447	50.626	-0.821
10	150	49.994	49.718	-0.277
10	237	51.301	50.236	-1.065
10	241	50.067	49.559	-0.508
10	242	51.525	50.707	-0.818
10	243	51.928	51.251	-0.676
10	244	50.669	50.042	-0.627
30	141	49.624	48.251	-1.373
30	144	51.570	50.026	-1.544
30	145	52.707	50.915	-1.792
30	146	51.127	49.826	-1.301
30	147	50.326	48.957	-1.369
30	132	52.184	50.974	-1.209
30	133	51.898	50.692	-1.206
30	135	51.126	50.218	-0.908
30	245	50.668	49.281	-1.388
30	246	49.681	48.609	-1.073
50	67	51.798	49.619	-2.179
50	68	51.158	49.827	-1.331
50	69	51.265	48.869	-2.396
50	71	51.767	49.091	-2.676
50	72	49.983	47.507	-2.476
50	172	50.159	47.781	-2.377
50	173	51.430	49.699	-1.731
50	174	51.315	48.974	-2.341
50	183	51.061	48.950	-2.111
50	186	51.995	49.891	-2.104
100	95	50.143	45.777	-4.366
100	102	51.335	47.434	-3.902
100	104	51.278	47.292	-3.986
100	105	52.874	48.408	-4.466
100	106	51.673	48.052	-3.621
100	178	51.069	47.593	-3.476
100	179	51.188	48.011	-3.178
100	180	51.571	47.913	-3.658
100	181	51.173	47.273	-3.900
100	182	50.825	47.489	-3.335
	Max	52.956	52.024	0.856
	Average	51.100	49.410	-1.691
	Min	49.367	45.777	-4.466
	Std Dev	0.893	1.339	1.265

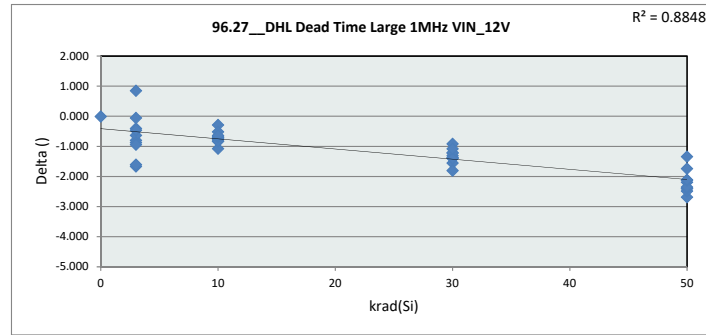

96.27 DHL Dead Time Large 1MHz VIN_12V						
Test Site	DAL-FL					
Tester	ETS364					
Test Number	EB672302					
Max Limit	61					
Min Limit	44					
krad(Si)	0	3	10	30	50	100
LL	44.000	44.000	44.000	44.000	44.000	44.000
Min	51.396	49.124	49.405	48.251	47.507	45.777
Average	51.396	50.075	50.454	49.775	49.021	47.524
Max	51.396	52.024	51.774	50.974	49.891	48.408
UL	61.000	61.000	61.000	61.000	61.000	61.000

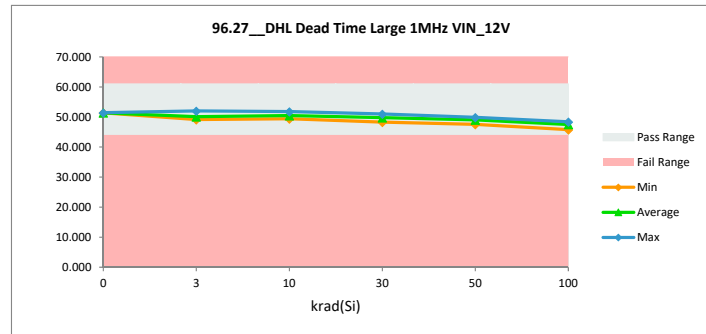

TID HDR Report
TPS7H6003-SP (5962R2220101VXC)

96.28 DHL Dead Time Max 1MHz		
Test Site	DAL-FL	DAL-FL
Tester	ETS364	ETS364
Test Number	EB672302	EB672302
Unit	nsec	
Max Limit	125	
Min Limit	86	

krad(Si)	Serial #	pre_short (rtp)	(2)'ST_Combo (rpt)	Delta
0	Ctrl	101.124	101.124	0.000
3	58	100.063	99.151	-0.912
3	59	96.569	96.044	-0.525
3	60	97.383	96.680	-0.703
3	61	102.227	101.262	-0.964
3	62	104.550	103.544	-1.007
3	134	100.966	97.904	-3.062
3	137	97.805	97.881	0.076
3	138	101.652	97.915	-3.737
3	139	98.627	97.935	-0.692
3	236	96.967	98.756	1.789
10	63	102.661	101.316	-1.345
10	64	102.785	101.870	-0.916
10	65	98.366	97.282	-1.085
10	66	101.483	100.267	-1.216
10	150	96.927	96.317	-0.610
10	237	100.559	98.775	-1.784
10	241	98.177	97.961	-0.216
10	242	101.051	99.681	-1.370
10	243	102.925	101.926	-0.999
10	244	99.913	98.752	-1.161
30	141	97.443	94.886	-2.557
30	144	101.731	98.746	-2.985
30	145	103.996	100.943	-3.053
30	146	100.927	98.366	-2.562
30	147	98.813	96.043	-2.769
30	132	103.064	101.211	-1.853
30	133	102.518	100.284	-2.234
30	135	100.043	100.046	0.003
30	245	99.582	97.146	-2.437
30	246	97.318	95.390	-1.927
50	67	101.335	97.065	-4.270
50	68	100.868	99.053	-1.815
50	69	100.154	95.246	-4.908
50	71	102.280	97.435	-4.845
50	72	97.899	92.767	-5.132
50	172	98.298	93.635	-4.663
50	173	101.427	97.441	-3.986
50	174	101.145	96.130	-5.015
50	183	100.259	95.431	-4.828
50	186	103.646	98.788	-4.858
100	95	98.239	89.103	-9.136
100	102	100.909	92.730	-8.178
100	104	100.138	92.390	-7.748
100	105	104.515	96.333	-8.182
100	106	101.900	94.005	-7.895
100	178	100.252	92.737	-7.515
100	179	100.730	93.574	-7.156
100	180	101.623	93.401	-8.223
100	181	100.606	91.994	-8.612
100	182	100.602	93.075	-7.527
	Max	104.550	103.544	1.789
	Average	100.491	97.210	-3.281
	Min	96.569	89.103	-9.136
	Std Dev	2.049	3.112	2.838

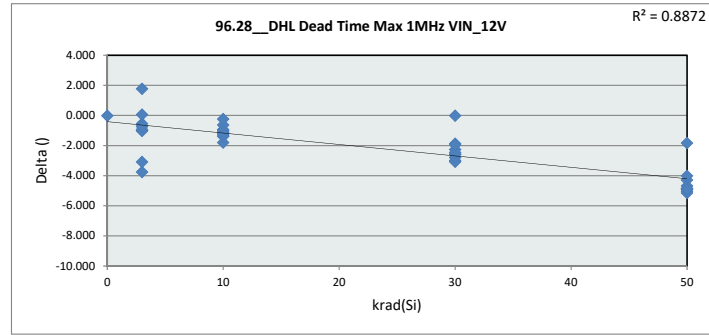

96.28 DHL Dead Time Max 1MHz VIN_12V						
Test Site	DAL-FL					
Tester	ETS364					
Test Number	EB672302					
Max Limit	125					
Min Limit	86					
krad(Si)	0	3	10	30	50	100
LL	86.000	86.000	86.000	86.000	86.000	86.000
Min	101.124	96.044	96.317	94.887	92.767	89.103
Average	101.124	98.707	99.415	98.306	96.299	92.934
Max	101.124	103.544	101.926	101.211	99.053	96.333
UL	125.000	125.000	125.000	125.000	125.000	125.000

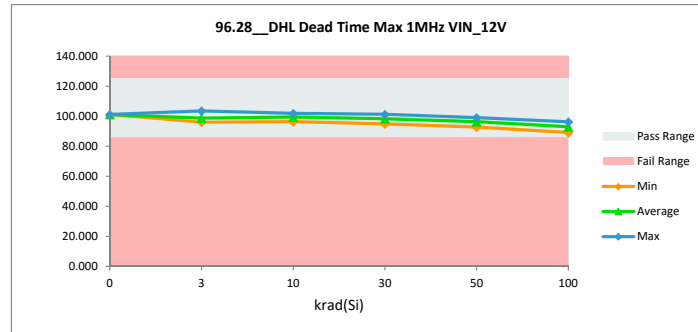

TID HDR Report

TPS7H6003-SP (5962R2220101VXC)

96.29 DHL Dead Time Min 2MH		
Test Site	DAL-FL	DAL-FL
Tester	ETS364	ETS364
Test Number	EB672302	EB672302
Unit	nsec	
Max Limit	10	10
Min Limit	0	0

krad(Si)	Serial #	pre_short (rtp)	(2)ST_Combo (rpt)	Delta
0	Ctrl	4.257	4.257	0.000
3	58	5.023	4.414	-0.609
3	59	5.310	4.797	-0.513
3	60	5.060	4.536	-0.524
3	61	4.367	4.051	-0.316
3	62	4.262	3.765	-0.497
3	134	4.694	4.513	-0.181
3	137	4.658	4.494	-0.164
3	138	4.391	4.431	0.040
3	139	4.961	4.530	-0.431
3	236	4.462	4.832	0.371
10	63	5.177	4.730	-0.447
10	64	4.682	4.328	-0.354
10	65	4.921	4.509	-0.412
10	66	4.127	3.670	-0.458
10	150	5.183	5.391	0.207
10	237	5.012	4.955	-0.057
10	241	4.891	4.778	-0.113
10	242	4.815	4.454	-0.361
10	243	3.992	3.939	-0.053
10	244	4.480	4.331	-0.148
30	141	4.643	4.440	-0.203
30	144	4.571	4.310	-0.261
30	145	4.467	3.928	-0.539
30	146	4.412	4.588	0.176
30	147	5.030	4.886	-0.145
30	132	4.262	4.359	0.097
30	133	4.959	4.840	-0.119
30	135	5.087	3.683	-1.404
30	245	4.338	4.181	-0.157
30	246	4.899	4.738	-0.161
50	67	5.140	4.783	-0.357
50	68	4.153	4.202	0.049
50	69	5.104	4.550	-0.555
50	71	3.913	3.333	-0.580
50	72	4.897	4.700	-0.197
50	172	4.586	4.227	-0.359
50	173	4.429	4.574	0.145
50	174	4.629	4.517	-0.112
50	183	5.056	4.920	-0.136
50	186	4.051	3.942	-0.109
100	95	5.111	4.870	-0.242
100	102	4.692	4.659	-0.032
100	104	5.194	4.988	-0.206
100	105	4.622	3.987	-0.635
100	106	4.482	4.532	0.050
100	178	4.926	4.851	-0.075
100	179	4.469	4.761	0.293
100	180	4.843	5.039	0.196
100	181	4.755	4.764	0.008
100	182	3.984	4.185	0.201
	Max	5.310	5.391	0.371
	Average	4.675	4.471	-0.204
	Min	3.913	3.333	-1.404
	Std Dev	0.367	0.403	0.304

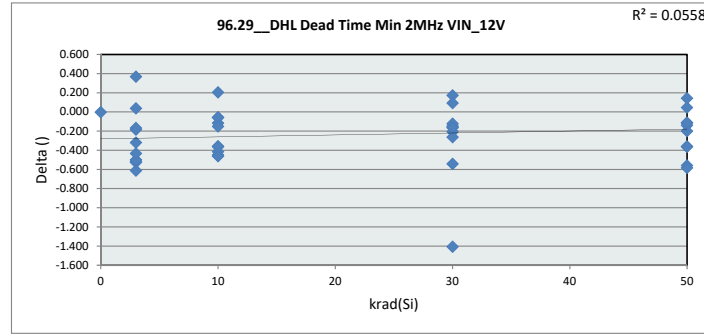

96.29 DHL Dead Time

Test Site	DAL-FL
Tester	ETS364
Test Number	EB672302
Max Limit	10
Min Limit	0

krad(Si)	0	3	10	30	50	100
LL	0.000	0.000	0.000	0.000	0.000	0.000
Min	4.257	3.765	3.670	3.683	3.333	3.988
Average	4.257	4.436	4.508	4.395	4.375	4.664
Max	4.257	4.832	5.391	4.886	4.920	5.039
UL	10.000	10.000	10.000	10.000	10.000	10.000

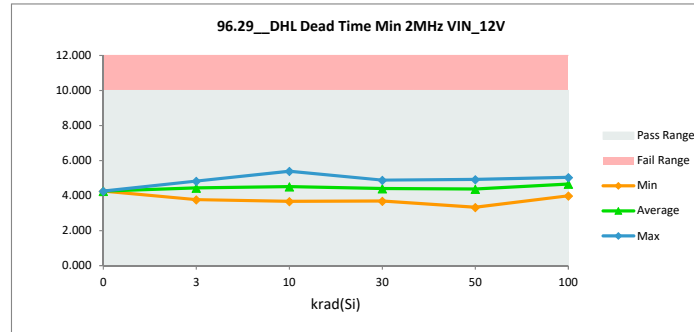

TID HDR Report
TPS7H6003-SP (5962R2220101VXC)

96.30 DHL Dead Time Small 2M		
Test Site	DAL-FL	DAL-FL
Tester	ETS364	ETS364
Test Number	EB672302	EB672302
Unit	nsec	
Max Limit	15	15
Min Limit	6	6

krad(Si)	Serial #	pre_short (rtp) (2)'ST	Combo (rpt) (Delta
0	Ctrl	10.006	10.006	0.000
3	58	10.493	9.883	-0.610
3	59	10.463	10.108	-0.354
3	60	10.206	9.866	-0.340
3	61	9.947	9.538	-0.409
3	62	10.024	9.667	-0.357
3	134	10.197	9.838	-0.359
3	137	9.876	9.903	0.026
3	138	9.952	9.889	-0.063
3	139	10.165	9.962	-0.203
3	236	9.710	10.226	0.516
10	63	10.769	10.366	-0.402
10	64	10.259	10.088	-0.172
10	65	10.149	9.757	-0.392
10	66	9.767	9.243	-0.524
10	150	10.504	10.564	0.060
10	237	10.440	10.140	-0.301
10	241	10.275	9.937	-0.338
10	242	10.335	9.929	-0.406
10	243	9.604	9.339	-0.265
10	244	10.047	9.856	-0.191
30	141	9.866	9.453	-0.412
30	144	10.082	9.679	-0.403
30	145	10.065	9.250	-0.815
30	146	10.021	9.845	-0.177
30	147	10.428	10.004	-0.424
30	132	9.995	9.793	-0.202
30	133	10.483	10.316	-0.167
30	135	10.435	9.245	-1.191
30	245	9.702	9.574	-0.128
30	246	10.035	10.008	-0.026
50	67	10.717	10.186	-0.532
50	68	9.806	9.579	-0.226
50	69	10.550	9.920	-0.630
50	71	9.531	8.778	-0.753
50	72	10.170	9.585	-0.584
50	172	10.008	9.351	-0.656
50	173	10.131	9.862	-0.269
50	174	10.237	9.502	-0.735
50	183	10.361	10.127	-0.234
50	186	9.753	9.337	-0.417
100	95	10.437	9.590	-0.848
100	102	10.253	9.696	-0.557
100	104	10.691	9.831	-0.861
100	105	10.298	9.051	-1.247
100	106	10.087	9.704	-0.383
100	178	10.361	9.834	-0.527
100	179	9.998	9.696	-0.302
100	180	10.367	9.953	-0.414
100	181	10.267	9.732	-0.535
100	182	9.442	9.286	-0.156
	Max	10.769	10.564	0.516
	Average	10.152	9.762	-0.390
	Min	9.442	8.778	-1.247
	Std Dev	0.303	0.348	0.304

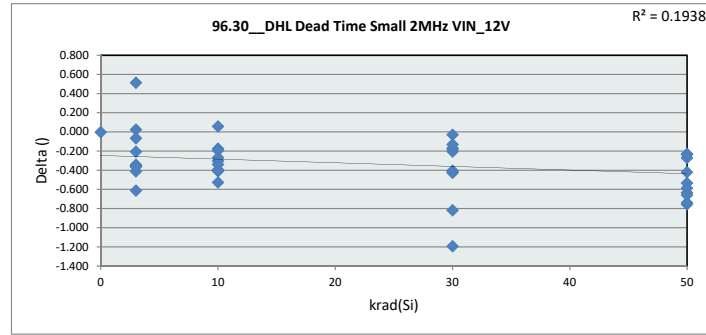

96.30 DHL Dead Time Small 2MHz VIN_12V						
Test Site	DAL-FL					
Tester	ETS364					
Test Number	EB672302					
Max Limit	15					
Min Limit	6					
krad(Si)	0	3	10	30	50	100
LL	6.000	6.000	6.000	6.000	6.000	6.000
Min	10.006	9.538	9.243	9.245	8.778	9.051
Average	10.006	9.888	9.922	9.717	9.623	9.637
Max	10.006	10.226	10.565	10.316	10.186	9.953
UL	15.000	15.000	15.000	15.000	15.000	15.000

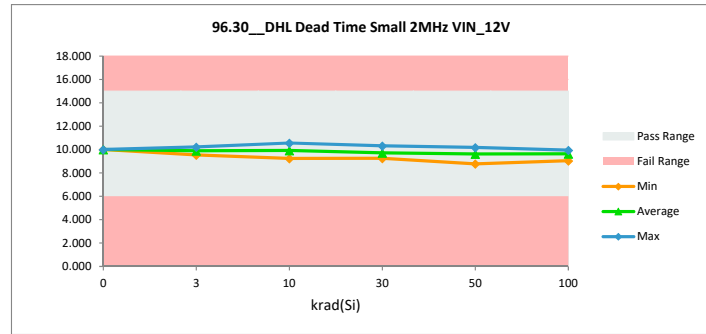

TID HDR Report
TPS7H6003-SP (5962R2220101VXC)

96.31 DHL Dead Time Mid 2MHz		
Test Site	DAL-FL	DAL-FL
Tester	ETS364	ETS364
Test Number	EB672302	EB672302
Unit	nsec	
Max Limit	24.5	24.5
Min Limit	16	16

krad(Si)	Serial #	pre_short (rtp)	(2)ST_Combo (rpt)	Delta
0	Ctrl	20.226	20.226	0.000
3	58	20.547	20.108	-0.440
3	59	20.163	19.804	-0.358
3	60	19.973	19.711	-0.261
3	61	20.247	19.779	-0.468
3	62	20.548	20.119	-0.429
3	134	20.475	19.776	-0.699
3	137	19.811	19.611	-0.200
3	138	20.140	19.774	-0.366
3	139	20.021	19.832	-0.189
3	236	19.579	20.064	0.486
10	63	21.042	20.524	-0.518
10	64	20.537	20.106	-0.431
10	65	20.072	19.458	-0.614
10	66	20.056	19.599	-0.456
10	150	20.267	20.209	-0.058
10	237	20.575	20.097	-0.478
10	241	19.985	19.708	-0.277
10	242	20.563	20.231	-0.332
10	243	20.018	19.942	-0.076
10	244	20.060	19.685	-0.374
30	141	19.591	18.982	-0.610
30	144	20.353	19.661	-0.693
30	145	20.505	19.769	-0.737
30	146	20.126	19.663	-0.463
30	147	20.350	19.790	-0.559
30	132	20.410	20.081	-0.329
30	133	20.661	20.251	-0.411
30	135	20.469	19.293	-1.177
30	245	19.919	19.606	-0.313
30	246	19.813	19.459	-0.354
50	67	20.877	19.999	-0.878
50	68	20.062	19.642	-0.420
50	69	20.656	19.762	-0.895
50	71	19.948	18.721	-1.226
50	72	20.107	19.110	-0.997
50	172	19.896	18.897	-1.000
50	173	20.352	19.872	-0.481
50	174	20.373	19.498	-0.875
50	183	20.416	19.663	-0.753
50	186	20.212	19.229	-0.982
100	95	20.321	18.635	-1.686
100	102	20.365	19.185	-1.179
100	104	20.667	19.156	-1.510
100	105	20.788	18.706	-2.082
100	106	20.321	19.173	-1.148
100	178	20.341	19.138	-1.203
100	179	20.203	19.356	-0.847
100	180	20.452	19.583	-0.869
100	181	20.341	18.975	-1.366
100	182	19.722	18.688	-1.034
	Max	21.042	20.524	0.486
	Average	20.265	19.606	-0.659
	Min	19.579	18.635	-2.082
	Std Dev	0.314	0.459	0.464

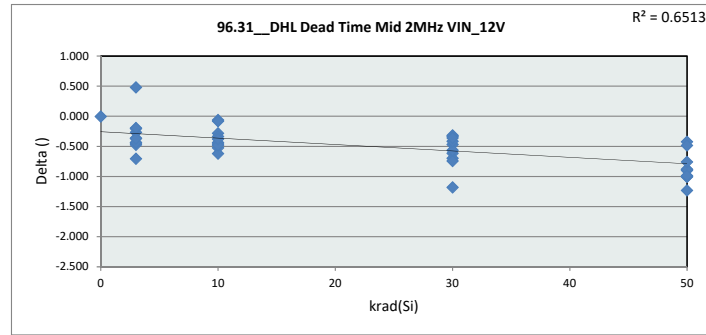

96.31 DHL Dead Time	
Test Site	DAL-FL
Tester	ETS364
Test Number	EB672302
Max Limit	24.5
Min Limit	16

krad(Si)	0	3	10	30	50	100
LL	16.000	16.000	16.000	16.000	16.000	16.000
Min	20.226	19.611	19.458	18.982	18.721	18.635
Average	20.226	19.858	19.956	19.655	19.439	19.060
Max	20.226	20.119	20.524	20.251	19.999	19.583
UL	24.500	24.500	24.500	24.500	24.500	24.500

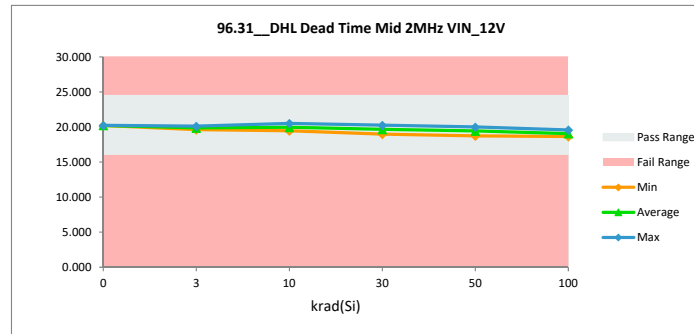

TID HDR Report
TPS7H6003-SP (5962R2220101VXC)

96.32 DHL Dead Time Large 2MHz		
Test Site	DAL-FL	DAL-FL
Tester	ETS364	ETS364
Test Number	EB672302	EB672302
Unit	nsec	
Max Limit	61	61
Min Limit	44	44

krad(Si)	Serial #	pre_short (rtp) (2)	ST_Combo (rpt) (Delta
0	Ctrl	52.178	52.178	0.000
3	58	51.777	51.437	-0.340
3	59	50.151	49.747	-0.404
3	60	50.116	49.810	-0.306
3	61	52.413	51.729	-0.685
3	62	53.509	52.939	-0.570
3	134	51.925	50.252	-1.673
3	137	50.286	50.228	-0.057
3	138	52.033	50.259	-1.774
3	139	50.563	50.154	-0.409
3	236	49.977	50.635	0.658
10	63	53.060	52.322	-0.738
10	64	52.521	51.922	-0.599
10	65	50.656	49.887	-0.768
10	66	52.117	51.577	-0.540
10	150	50.518	50.267	-0.251
10	237	51.867	50.863	-1.004
10	241	50.590	50.244	-0.346
10	242	52.159	51.541	-0.618
10	243	52.534	52.154	-0.379
10	244	51.212	50.638	-0.574
30	141	50.093	48.668	-1.425
30	144	52.289	50.737	-1.553
30	145	53.239	51.712	-1.527
30	146	51.755	50.476	-1.278
30	147	50.854	49.791	-1.064
30	132	52.756	51.895	-0.861
30	133	52.486	51.480	-1.005
30	135	51.697	51.005	-0.692
30	245	51.141	49.997	-1.144
30	246	50.109	49.094	-1.014
50	67	52.338	50.087	-2.250
50	68	51.838	50.449	-1.389
50	69	51.843	49.439	-2.404
50	71	52.459	49.665	-2.794
50	72	50.610	48.061	-2.550
50	172	50.745	48.443	-2.302
50	173	52.033	50.466	-1.567
50	174	52.022	49.677	-2.345
50	183	51.640	49.588	-2.053
50	186	52.692	50.532	-2.160
100	95	50.721	46.318	-4.403
100	102	51.999	48.194	-3.805
100	104	51.802	48.034	-3.768
100	105	53.481	49.009	-4.472
100	106	52.315	48.627	-3.688
100	178	51.563	48.203	-3.360
100	179	51.849	48.677	-3.171
100	180	52.215	48.725	-3.490
100	181	51.717	47.660	-4.057
100	182	51.484	48.033	-3.451
	Max	53.509	52.939	0.658
	Average	51.685	50.069	-1.616
	Min	49.977	46.318	-4.472
	Std Dev	0.925	1.407	1.306

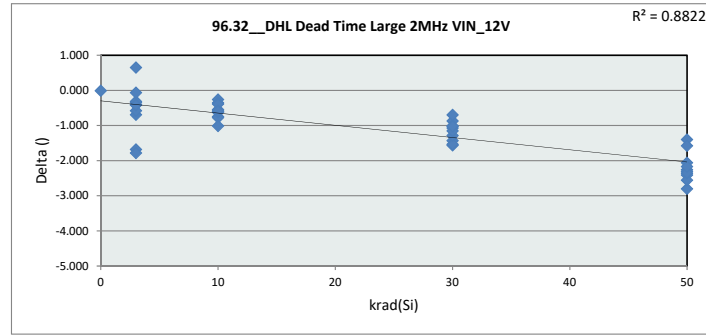

96.32 DHL Dead Ti

Test Site	DAL-FL
Tester	ETS364
Test Number	EB672302
Max Limit	61
Min Limit	44

krad(Si)	0	3	10	30	50	100
LL	44.000	44.000	44.000	44.000	44.000	44.000
Min	52.178	49.747	49.887	48.668	48.061	46.318
Average	52.178	50.719	51.142	50.486	49.641	48.148
Max	52.178	52.939	52.322	51.895	50.532	49.009
UL	61.000	61.000	61.000	61.000	61.000	61.000

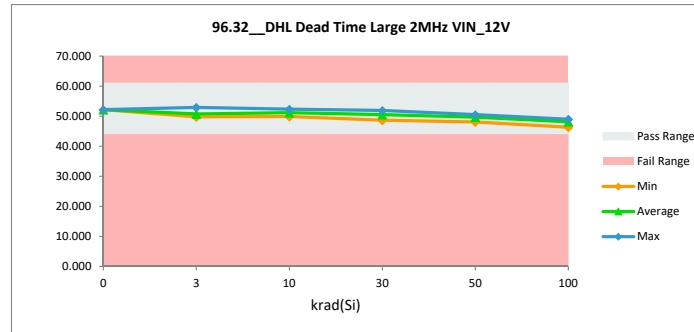

TID HDR Report
TPS7H6003-SP (5962R2220101VXC)

96.33 DHL Dead Time Max 2MHz		
Test Site	DAL-FL	DAL-FL
Tester	ETS364	ETS364
Test Number	EB672302	EB672302
Unit	nsec	
Max Limit	125	
Min Limit	86	

krad(Si)	Serial #	pre_short (rtp)	(2)'ST_Combo (rpt)	Delta
0	Ctrl	104.329	104.329	0.000
3	58	102.990	102.396	-0.594
3	59	99.573	99.089	-0.484
3	60	100.381	99.865	-0.517
3	61	105.418	104.559	-0.860
3	62	107.804	106.890	-0.914
3	134	103.943	100.926	-3.018
3	137	100.801	101.044	0.243
3	138	104.887	100.971	-3.916
3	139	101.566	101.016	-0.550
3	236	99.899	101.777	1.878
10	63	105.745	104.811	-0.934
10	64	106.049	104.950	-1.099
10	65	101.323	100.246	-1.077
10	66	104.820	103.609	-1.211
10	150	99.782	99.255	-0.527
10	237	103.652	101.829	-1.823
10	241	101.158	100.907	-0.251
10	242	104.166	102.990	-1.176
10	243	106.395	105.275	-1.121
10	244	103.065	101.927	-1.139
30	141	100.520	97.883	-2.637
30	144	104.983	102.092	-2.891
30	145	107.446	104.082	-3.364
30	146	104.096	101.437	-2.659
30	147	101.679	99.211	-2.468
30	132	106.425	104.289	-2.136
30	133	105.668	103.195	-2.473
30	135	103.096	103.368	0.271
30	245	102.519	100.177	-2.342
30	246	100.400	98.183	-2.217
50	67	104.502	100.183	-4.320
50	68	104.176	102.480	-1.696
50	69	103.226	98.359	-4.866
50	71	105.707	100.546	-5.161
50	72	101.035	95.614	-5.421
50	172	101.263	96.877	-4.387
50	173	104.525	100.644	-3.882
50	174	104.152	99.056	-5.096
50	183	103.252	98.514	-4.738
50	186	107.048	102.017	-5.031
100	95	101.183	91.851	-9.332
100	102	104.177	95.785	-8.392
100	104	103.183	95.428	-7.754
100	105	108.002	99.627	-8.375
100	106	105.269	97.204	-8.064
100	178	103.175	95.741	-7.433
100	179	103.853	96.760	-7.094
100	180	104.782	96.702	-8.080
100	181	103.585	94.933	-8.652
100	182	103.742	96.025	-7.717
	Max	108.002	106.890	1.878
	Average	103.616	100.332	-3.284
	Min	99.573	91.851	-9.332
	Std Dev	2.178	3.201	2.903

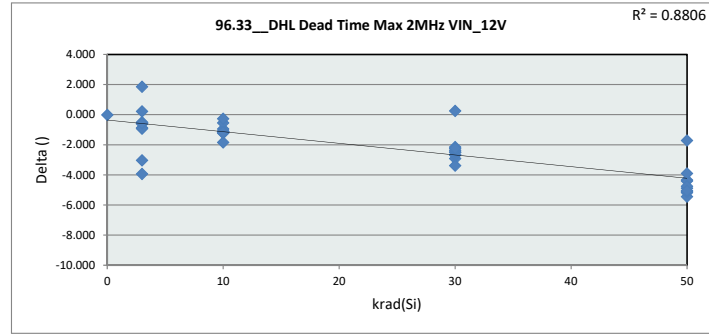

96.33 DHL Dead Time Max 2MHz VIN_12V						
Test Site	DAL-FL					
Tester	ETS364					
Test Number	EB672302					
Max Limit	125					
Min Limit	86					
krad(Si)	0	3	10	30	50	100
LL	86.000	86.000	86.000	86.000	86.000	86.000
Min	104.329	99.089	99.255	97.883	95.614	91.851
Average	104.329	101.853	102.580	101.392	99.429	96.006
Max	104.329	106.890	105.275	104.289	102.480	99.627
UL	125.000	125.000	125.000	125.000	125.000	125.000

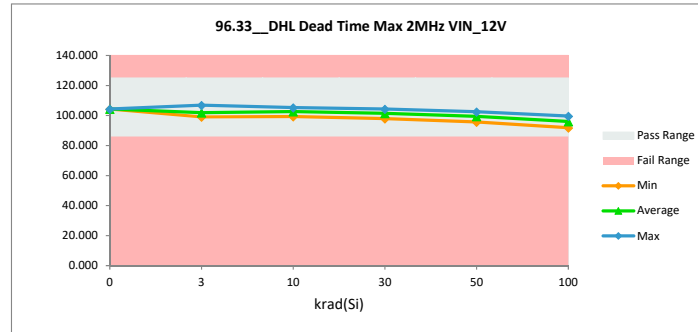

TID HDR Report
TPS7H6003-SP (5962R2220101VXC)

97.0 __DLH Dead Time Min 500k		
Test Site	DAL-FL	DAL-FL
Tester	ETS364	ETS364
Test Number	EB672302	EB672302
Unit	nsec	
Max Limit	10	10
Min Limit	0	0

krad(Si)	Serial #	pre_short (rtp)	(2)'ST_Combo (rpt)	Delta
0	Ctrl	3.563	3.563	0.000
3	58	3.606	4.389	0.782
3	59	3.206	4.031	0.825
3	60	2.785	3.454	0.670
3	61	3.685	4.378	0.693
3	62	3.324	4.153	0.829
3	134	3.023	4.720	1.697
3	137	3.635	4.721	1.086
3	138	3.851	4.763	0.912
3	139	3.896	4.163	0.267
3	236	2.779	4.514	1.735
10	63	3.495	4.175	0.680
10	64	3.369	3.986	0.617
10	65	3.472	4.130	0.658
10	66	3.541	4.219	0.678
10	150	3.226	3.810	0.584
10	237	3.745	4.553	0.809
10	241	3.413	4.757	1.345
10	242	2.981	3.476	0.495
10	243	3.785	4.214	0.429
10	244	4.079	4.305	0.226
30	141	3.151	3.839	0.689
30	144	3.795	4.377	0.582
30	145	4.209	4.649	0.440
30	146	3.624	4.193	0.569
30	147	3.356	3.747	0.392
30	132	3.868	4.472	0.603
30	133	3.628	4.095	0.467
30	135	3.729	4.790	1.061
30	245	3.666	4.109	0.443
30	246	2.951	3.616	0.665
50	67	3.671	4.221	0.551
50	68	3.011	4.567	1.556
50	69	3.362	4.234	0.872
50	71	3.698	4.489	0.791
50	72	3.007	4.098	1.092
50	172	4.499	4.945	0.446
50	173	3.784	4.151	0.367
50	174	2.852	4.231	1.379
50	183	3.047	3.290	0.243
50	186	4.239	4.661	0.423
100	95	3.631	4.895	1.264
100	102	3.247	4.058	0.812
100	104	3.388	4.659	1.271
100	105	3.241	4.228	0.987
100	106	3.616	4.685	1.069
100	178	3.607	4.253	0.647
100	179	3.514	4.338	0.824
100	180	3.403	4.627	1.223
100	181	3.518	4.426	0.908
100	182	3.398	4.057	0.659
	Max	4.499	4.945	1.735
	Average	3.493	4.264	0.771
	Min	2.779	3.290	0.000
	Std Dev	0.371	0.384	0.375

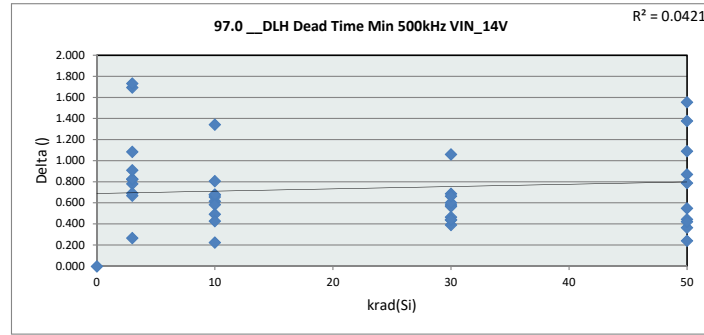

97.0 __DLH Dead Time

Test Site	DAL-FL
Tester	ETS364
Test Number	EB672302
Max Limit	10
Min Limit	0

krad(Si)	0	3	10	30	50	100
LL	0.000	0.000	0.000	0.000	0.000	0.000
Min	3.564	3.455	3.476	3.616	3.290	4.057
Average	3.564	4.329	4.163	4.189	4.289	4.423
Max	3.564	4.763	4.757	4.790	4.945	4.895
UL	10.000	10.000	10.000	10.000	10.000	10.000

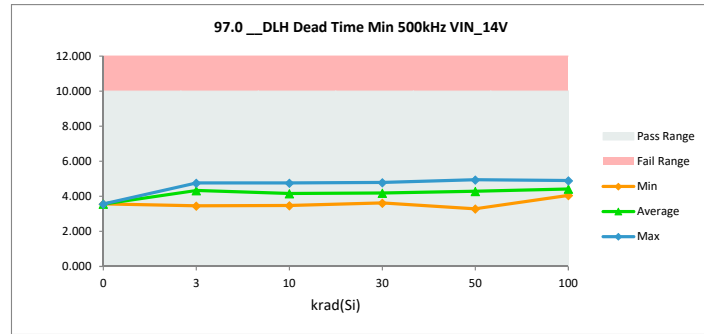

TID HDR Report
TPS7H6003-SP (5962R2220101VXC)

97.1 DLH Dead Time Small 500		
Test Site	DAL-FL	DAL-FL
Tester	ETS364	ETS364
Test Number	EB672302	EB672302
Unit	nsec	
Max Limit	15.5	15.5
Min Limit	8	8

krad(Si)	Serial #	pre_short (rtp)	(2)ST_Combo (rpt)	Delta
0	Ctrl	11.013	11.013	0.000
3	58	11.007	11.589	0.582
3	59	10.000	11.022	1.022
3	60	10.200	10.765	0.565
3	61	10.612	11.350	0.738
3	62	10.163	10.875	0.712
3	134	10.544	11.307	0.763
3	137	10.480	11.376	0.896
3	138	10.514	11.421	0.907
3	139	11.117	11.394	0.277
3	236	10.431	11.740	1.310
10	63	10.886	11.595	0.708
10	64	10.811	11.272	0.460
10	65	10.941	11.387	0.446
10	66	10.601	11.103	0.502
10	150	10.525	10.913	0.388
10	237	10.527	11.810	1.283
10	241	10.755	11.396	0.641
10	242	10.485	10.909	0.424
10	243	11.117	11.427	0.311
10	244	11.439	11.719	0.281
30	141	10.416	10.667	0.251
30	144	11.107	11.288	0.180
30	145	11.068	11.339	0.271
30	146	10.927	11.178	0.252
30	147	10.648	10.644	-0.004
30	132	11.171	11.449	0.278
30	133	10.962	11.113	0.151
30	135	10.567	11.481	0.914
30	245	11.069	11.217	0.148
30	246	10.339	10.450	0.111
50	67	10.471	10.535	0.065
50	68	10.359	11.430	1.071
50	69	10.732	11.108	0.375
50	71	10.483	10.582	0.099
50	72	10.343	10.801	0.457
50	172	11.429	11.574	0.146
50	173	11.203	11.027	-0.176
50	174	10.255	11.122	0.867
50	183	10.251	10.149	-0.102
50	186	10.974	10.985	0.010
100	95	11.111	11.322	0.211
100	102	10.556	10.382	-0.174
100	104	10.742	10.779	0.037
100	105	10.655	10.474	-0.181
100	106	11.030	10.841	-0.189
100	178	10.847	10.649	-0.198
100	179	10.854	10.557	-0.296
100	180	10.915	10.911	-0.004
100	181	10.840	10.570	-0.269
100	182	10.582	10.409	-0.173
	Max	11.439	11.810	1.310
	Average	10.727	11.067	0.340
	Min	10.000	10.149	-0.296
	Std Dev	0.333	0.405	0.412

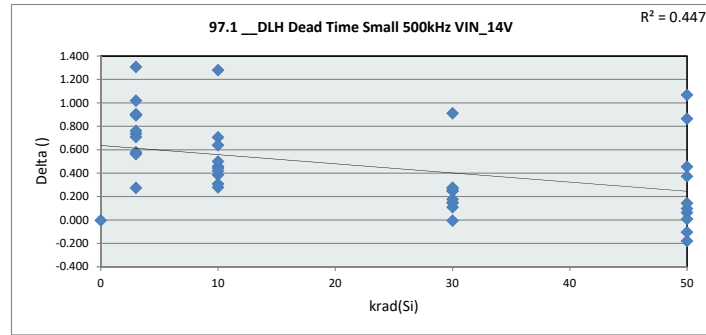

97.1 DLH Dead Time		
Test Site	DAL-FL	
Tester	ETS364	
Test Number	EB672302	
Max Limit	15.5	
Min Limit	8	

krad(Si)	0	3	10	30	50	100
LL	8.000	8.000	8.000	8.000	8.000	8.000
Min	11.013	10.765	10.909	10.450	10.149	10.382
Average	11.013	11.284	11.353	11.083	10.931	10.689
Max	11.013	11.740	11.810	11.481	11.574	11.322
UL	15.500	15.500	15.500	15.500	15.500	15.500

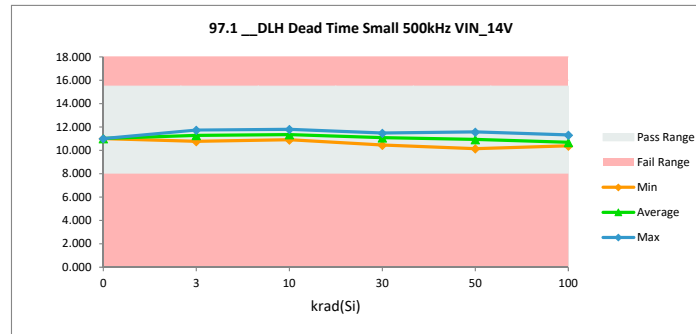

TID HDR Report
TPS7H6003-SP (5962R2220101VXC)

97.2 DLH Dead Time Mid 500k		
Test Site	DAL-FL	DAL-FL
Tester	ETS364	ETS364
Test Number	EB672302	EB672302
Unit	nsec	
Max Limit	24	
Min Limit	15.5	

krad(Si)	Serial #	pre_short (rtp) (2)	ST_Combo (rpt) (Delta
0	Ctrl	20.163	20.163	0.000
3	58	19.529	20.341	0.812
3	59	18.320	19.188	0.868
3	60	18.877	19.420	0.543
3	61	18.756	19.438	0.683
3	62	18.395	19.042	0.647
3	134	19.490	19.392	-0.098
3	137	18.833	19.273	0.440
3	138	18.720	19.282	0.562
3	139	19.658	19.971	0.313
3	236	19.477	20.102	0.625
10	63	19.657	20.171	0.514
10	64	19.633	20.054	0.421
10	65	19.678	20.016	0.339
10	66	18.884	19.252	0.368
10	150	19.299	19.564	0.264
10	237	18.624	20.122	1.497
10	241	19.508	19.262	-0.247
10	242	19.443	19.798	0.355
10	243	19.717	19.980	0.264
10	244	20.021	20.064	0.043
30	141	19.208	19.334	0.126
30	144	19.819	19.751	-0.068
30	145	19.372	19.262	-0.110
30	146	19.588	19.489	-0.099
30	147	19.337	19.172	-0.164
30	132	19.911	20.056	0.145
30	133	19.645	19.612	-0.033
30	135	18.682	19.390	0.708
30	245	19.784	19.576	-0.208
30	246	19.132	18.961	-0.171
50	67	18.652	18.329	-0.323
50	68	19.263	19.808	0.544
50	69	19.433	19.461	0.028
50	71	18.638	18.535	-0.103
50	72	18.971	19.149	0.179
50	172	19.578	19.316	-0.263
50	173	19.981	19.521	-0.459
50	174	19.256	19.557	0.301
50	183	18.979	18.644	-0.335
50	186	19.174	18.866	-0.307
100	95	19.893	19.254	-0.640
100	102	19.274	18.121	-1.153
100	104	19.397	18.819	-0.578
100	105	19.422	18.510	-0.911
100	106	19.728	18.728	-1.000
100	178	19.464	18.587	-0.877
100	179	19.621	18.573	-1.048
100	180	19.753	19.012	-0.742
100	181	19.516	18.467	-1.050
100	182	19.225	18.367	-0.859
Max		20.163	20.341	1.497
Average		19.341	19.336	-0.005
Min		18.320	18.121	-1.153
Std Dev		0.438	0.562	0.578

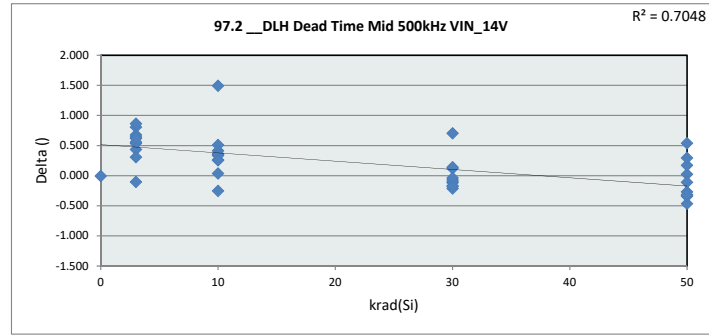

97.2 DLH Dead Time	
Test Site	DAL-FL
Tester	ETS364
Test Number	EB672302
Max Limit	24
Min Limit	15.5

krad(Si)	0	3	10	30	50	100
LL	15.500	15.500	15.500	15.500	15.500	15.500
Min	20.163	19.042	19.252	18.961	18.329	18.121
Average	20.163	19.545	19.828	19.460	19.119	18.644
Max	20.163	20.341	20.171	20.056	19.808	19.254
UL	24.000	24.000	24.000	24.000	24.000	24.000

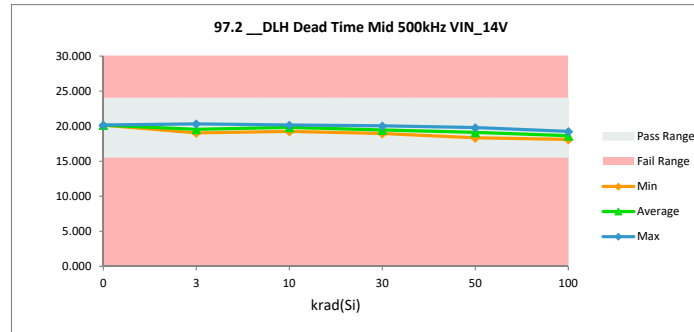

TID HDR Report
TPS7H6003-SP (5962R2220101VXC)

97.3 DLH Dead Time Large 500kHz VIN_14V		
Test Site	DAL-FL	DAL-FL
Tester	ETS364	ETS364
Test Number	EB672302	EB672302
Unit	nsec	
Max Limit	59	59
Min Limit	36	36

krad(Si)	Serial #	pre_short (rtp) (2)	ST_Combo (rpt) (Delta
0	Ctrl	49.452	49.452	0.000
3	58	48.065	48.543	0.478
3	59	45.740	46.368	0.628
3	60	47.218	47.566	0.348
3	61	45.775	46.372	0.597
3	62	45.431	46.104	0.673
3	134	48.786	45.749	-3.037
3	137	46.177	45.969	-0.208
3	138	45.620	45.768	0.148
3	139	47.875	47.967	0.092
3	236	49.174	48.159	-1.015
10	63	48.683	48.810	0.128
10	64	48.894	49.026	0.132
10	65	48.960	49.163	0.204
10	66	45.928	46.060	0.132
10	150	48.379	48.520	0.140
10	237	45.341	48.180	2.839
10	241	48.021	45.801	-2.220
10	242	48.467	48.551	0.085
10	243	48.051	48.044	-0.007
10	244	48.237	48.105	-0.132
30	141	47.900	47.309	-0.591
30	144	48.477	47.580	-0.897
30	145	46.449	45.455	-0.994
30	146	48.190	47.230	-0.961
30	147	47.853	47.121	-0.731
30	132	48.686	47.936	-0.750
30	133	48.132	47.322	-0.809
30	135	45.528	45.587	0.060
30	245	48.476	47.383	-1.093
30	246	48.297	47.219	-1.077
50	67	45.712	44.028	-1.684
50	68	48.141	47.335	-0.806
50	69	48.147	46.999	-1.148
50	71	45.484	44.282	-1.202
50	72	47.100	46.049	-1.051
50	172	46.341	45.290	-1.052
50	173	48.536	47.272	-1.264
50	174	48.555	47.651	-0.904
50	183	47.748	46.370	-1.377
50	186	45.939	44.855	-1.084
100	95	48.534	45.914	-2.620
100	102	47.653	44.435	-3.218
100	104	47.944	44.979	-2.965
100	105	48.002	44.847	-3.156
100	106	48.205	44.832	-3.373
100	178	47.411	44.644	-2.767
100	179	48.294	45.045	-3.249
100	180	48.733	45.713	-3.020
100	181	48.298	44.731	-3.568
100	182	47.384	44.540	-2.844
	Max	49.452	49.452	2.839
	Average	47.616	46.632	-0.984
	Min	45.341	44.028	-3.568
	Std Dev	1.170	1.468	1.358

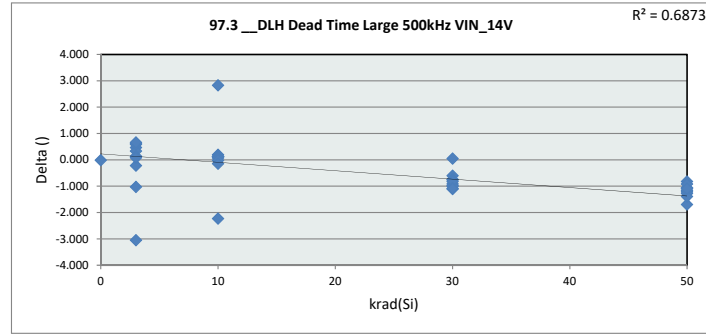

97.3 DLH Dead Time Large 500kHz VIN_14V

97.3 DLH Dead Time Large 500kHz VIN_14V	
Test Site	DAL-FL
Tester	ETS364
Test Number	EB672302
Max Limit	59
Min Limit	36

krad(Si)	0	3	10	30	50	100
LL	36.000	36.000	36.000	36.000	36.000	36.000
Min	49.452	45.749	45.801	45.455	44.028	44.435
Average	49.452	46.856	48.026	47.014	46.013	44.968
Max	49.452	48.543	49.163	47.936	47.651	45.914
UL	59.000	59.000	59.000	59.000	59.000	59.000

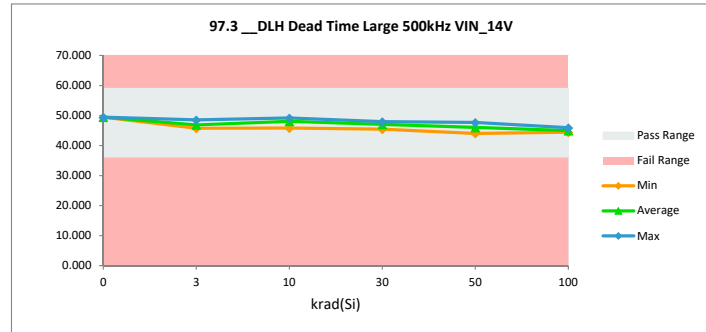

TID HDR Report
TPS7H6003-SP (5962R2220101VXC)

97.4 __DLH Dead Time Max 500kHz		
Test Site	DAL-FL	DAL-FL
Tester	ETS364	ETS364
Test Number	EB672302	EB672302
Unit	nsec	
Max Limit	113.5	113.5
Min Limit	74	74

krad(Si)	Serial #	pre_short (rtp) (2)'ST	Combo (rpt) (Delta
0	Ctrl	95.998	95.998	0.000
3	58	93.537	93.742	0.204
3	59	89.340	89.912	0.572
3	60	92.102	92.363	0.261
3	61	88.601	89.083	0.483
3	62	88.487	88.623	0.136
3	134	95.857	87.891	-7.967
3	137	89.433	87.969	-1.464
3	138	88.148	87.923	-0.226
3	139	92.466	92.457	-0.009
3	236	96.983	93.418	-3.565
10	63	95.599	95.351	-0.248
10	64	96.163	95.941	-0.222
10	65	95.544	95.200	-0.343
10	66	88.303	88.073	-0.229
10	150	95.242	94.934	-0.308
10	237	87.680	93.481	5.801
10	241	94.336	87.902	-6.434
10	242	94.762	94.417	-0.346
10	243	92.999	92.561	-0.438
10	244	93.833	93.350	-0.483
30	141	94.298	92.285	-2.013
30	144	94.221	92.202	-2.019
30	145	89.277	86.703	-2.574
30	146	94.226	91.841	-2.385
30	147	93.590	91.442	-2.148
30	132	94.746	92.631	-2.115
30	133	93.662	91.409	-2.253
30	135	88.080	87.155	-0.925
30	245	94.885	92.221	-2.664
30	246	94.668	92.118	-2.550
50	67	87.518	84.118	-3.400
50	68	94.122	91.237	-2.885
50	69	94.141	90.909	-3.232
50	71	87.772	84.469	-3.303
50	72	91.934	88.713	-3.221
50	172	88.681	85.916	-2.764
50	173	94.087	91.033	-3.054
50	174	95.513	92.397	-3.116
50	183	93.896	90.657	-3.239
50	186	88.212	85.346	-2.866
100	95	94.367	87.819	-6.548
100	102	92.813	85.378	-7.435
100	104	93.500	86.653	-6.847
100	105	93.270	85.832	-7.438
100	106	93.963	86.024	-7.939
100	178	91.428	85.383	-6.045
100	179	94.088	87.262	-6.826
100	180	94.878	87.951	-6.927
100	181	93.629	86.297	-7.332
100	182	92.024	85.824	-6.201
	Max	96.983	95.998	5.801
	Average	92.684	89.996	-2.688
	Min	87.518	84.118	-7.967
	Std Dev	2.751	3.359	2.896

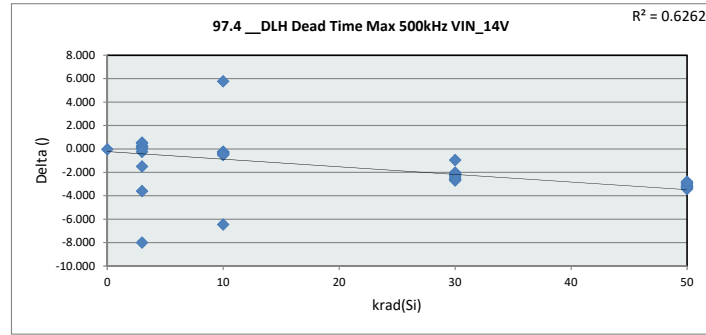

97.4 __DLH Dead Time Max 500kHz VIN_14V						
Test Site	DAL-FL					
Tester	ETS364					
Test Number	EB672302					
Max Limit	113.5					
Min Limit	74					
krad(Si)	0	3	10	30	50	100
LL	74.000	74.000	74.000	74.000	74.000	74.000
Min	95.998	87.891	87.903	86.703	84.118	85.378
Average	95.998	90.338	93.121	91.001	88.480	86.442
Max	95.998	93.742	95.941	92.631	92.397	87.951
UL	113.500	113.500	113.500	113.500	113.500	113.500

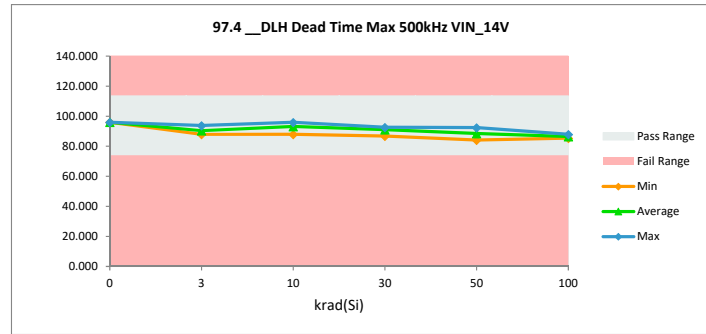

TID HDR Report
TPS7H6003-SP (5962R2220101VXC)

97.5 DLH Dead Time Min 1MHz		
Test Site	DAL-FL	DAL-FL
Tester	ETS364	ETS364
Test Number	EB672302	EB672302
Unit	nsec	
Max Limit	10	10
Min Limit	0	0

krad(Si)	Serial #	pre_short (rtp)	(2)'ST_Combo (rpt)	Delta
0	Ctrl	3.523	3.523	0.000
3	58	3.754	4.493	0.740
3	59	3.264	4.062	0.798
3	60	2.895	3.550	0.654
3	61	3.806	4.398	0.592
3	62	3.486	4.177	0.691
3	134	3.228	4.696	1.468
3	137	3.787	4.629	0.841
3	138	3.942	4.771	0.828
3	139	4.092	4.461	0.369
3	236	3.021	4.495	1.473
10	63	3.628	4.306	0.678
10	64	3.508	4.237	0.729
10	65	3.569	4.105	0.536
10	66	3.786	4.323	0.537
10	150	3.351	3.717	0.366
10	237	3.781	4.603	0.822
10	241	3.630	4.640	1.010
10	242	3.171	3.845	0.675
10	243	3.952	4.221	0.269
10	244	4.227	4.422	0.195
30	141	3.301	3.822	0.521
30	144	4.020	4.651	0.631
30	145	4.308	4.866	0.558
30	146	3.790	4.298	0.508
30	147	3.543	4.008	0.465
30	132	3.959	4.718	0.759
30	133	3.693	4.329	0.636
30	135	3.810	5.079	1.270
30	245	3.771	4.361	0.590
30	246	3.089	3.542	0.453
50	67	3.754	4.543	0.788
50	68	3.225	4.619	1.394
50	69	3.510	4.339	0.829
50	71	3.843	4.591	0.748
50	72	3.133	4.169	1.036
50	172	4.600	4.980	0.380
50	173	3.857	4.405	0.548
50	174	3.043	4.271	1.228
50	183	3.125	3.546	0.421
50	186	4.347	4.962	0.615
100	95	3.809	5.159	1.351
100	102	3.295	4.241	0.946
100	104	3.432	4.663	1.231
100	105	3.334	4.499	1.165
100	106	3.780	4.806	1.026
100	178	3.737	4.475	0.739
100	179	3.735	4.428	0.693
100	180	3.500	4.482	0.982
100	181	3.704	4.452	0.748
100	182	3.543	4.299	0.756
Max		4.600	5.159	1.473
Average		3.627	4.378	0.751
Min		2.895	3.523	0.000
Std Dev		0.363	0.387	0.325

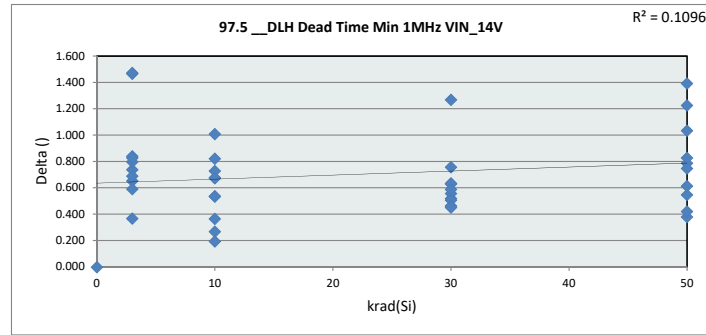

97.5 DLH Dead Time

Test Site	DAL-FL
Tester	ETS364
Test Number	EB672302
Max Limit	10
Min Limit	0

krad(Si)	0	3	10	30	50	100
LL	0.000	0.000	0.000	0.000	0.000	0.000
Min	3.523	3.550	3.717	3.542	3.546	4.241
Average	3.523	4.373	4.242	4.367	4.442	4.550
Max	3.523	4.771	4.640	5.079	4.980	5.159
UL	10.000	10.000	10.000	10.000	10.000	10.000

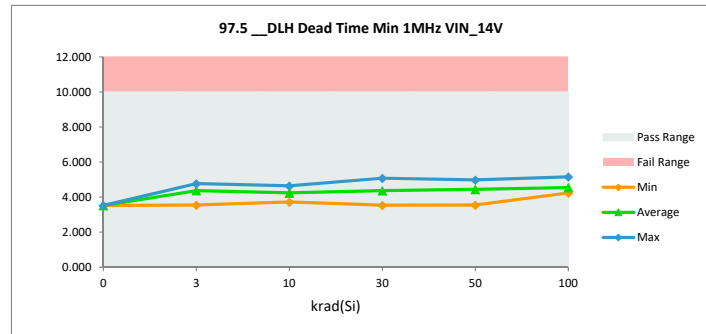

TID HDR Report
TPS7H6003-SP (5962R2220101VXC)

97.6 DLH Dead Time Small 1M		
Test Site	DAL-FL	DAL-FL
Tester	ETS364	ETS364
Test Number	EB672302	EB672302
Unit	nsec	
Max Limit	15.5	15.5
Min Limit	8	8

krad(Si)	Serial #	pre_short (rtp)	(2)ST_Combos (rpt)	Delta
0	Ctrl	11.092	11.092	0.000
3	58	10.921	11.505	0.584
3	59	9.960	10.770	0.810
3	60	10.145	10.632	0.488
3	61	10.494	11.119	0.625
3	62	10.050	10.731	0.682
3	134	10.533	11.218	0.686
3	137	10.410	11.213	0.803
3	138	10.416	11.222	0.806
3	139	11.073	11.359	0.286
3	236	10.370	11.645	1.275
10	63	10.842	11.287	0.445
10	64	10.758	11.194	0.436
10	65	10.766	11.212	0.446
10	66	10.502	11.139	0.638
10	150	10.446	10.787	0.341
10	237	10.404	11.531	1.127
10	241	10.739	11.317	0.578
10	242	10.425	10.941	0.516
10	243	11.008	11.474	0.466
10	244	11.345	11.429	0.085
30	141	10.304	10.681	0.378
30	144	11.092	11.246	0.154
30	145	10.952	11.223	0.270
30	146	10.820	10.935	0.114
30	147	10.551	10.672	0.121
30	132	11.019	11.351	0.332
30	133	10.846	11.020	0.175
30	135	10.434	11.430	0.996
30	245	10.934	11.165	0.231
30	246	10.235	10.253	0.018
50	67	10.339	10.523	0.184
50	68	10.258	11.410	1.152
50	69	10.618	10.988	0.370
50	71	10.281	10.533	0.252
50	72	10.222	10.818	0.596
50	172	11.300	11.243	-0.057
50	173	11.112	11.019	-0.093
50	174	10.238	11.087	0.850
50	183	10.240	10.234	-0.007
50	186	10.870	10.988	0.118
100	95	10.990	11.066	0.075
100	102	10.432	10.135	-0.297
100	104	10.613	10.699	0.086
100	105	10.532	10.512	-0.020
100	106	10.933	10.963	0.030
100	178	10.737	10.807	0.070
100	179	10.847	10.419	-0.428
100	180	10.722	10.702	-0.021
100	181	10.751	10.459	-0.292
100	182	10.533	10.399	-0.133
	Max	11.345	11.645	1.275
	Average	10.636	10.976	0.340
	Min	9.960	10.135	-0.428
	Std Dev	0.330	0.373	0.384

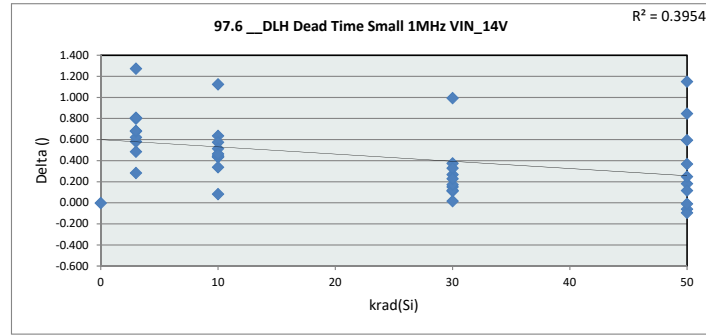

97.6 DLH Dead Time						
Test Site	DAL-FL					
Tester	ETS364					
Test Number	EB672302					
Max Limit	15.5					
Min Limit	8					
krad(Si)	0	3	10	30	50	100
LL	8.000	8.000	8.000	8.000	8.000	8.000
Min	11.092	10.632	10.787	10.253	10.234	10.136
Average	11.092	11.142	11.231	10.998	10.884	10.616
Max	11.092	11.645	11.531	11.430	11.410	11.066
UL	15.500	15.500	15.500	15.500	15.500	15.500

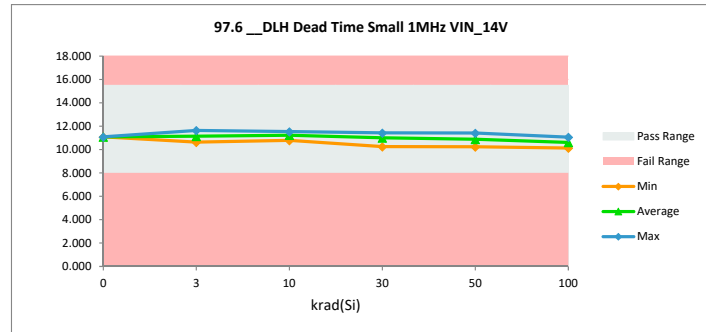

TID HDR Report
TPS7H6003-SP (5962R2220101VXC)

97.7_DLH Dead Time Mid 1MHz		
Test Site	DAL-FL	DAL-FL
Tester	ETS364	ETS364
Test Number	EB672302	EB672302
Unit	nsec	
Max Limit	24	
Min Limit	15.5	

krad(Si)	Serial #	pre_short (rtp)	(2)ST_Combo (rpt)	Delta
0	Ctrl	19.673	19.673	0.000
3	58	19.220	19.941	0.720
3	59	17.971	18.903	0.933
3	60	18.515	19.003	0.488
3	61	18.369	19.047	0.678
3	62	18.044	18.844	0.800
3	134	19.057	18.914	-0.143
3	137	18.441	19.009	0.568
3	138	18.286	18.998	0.712
3	139	19.220	19.513	0.292
3	236	19.158	19.779	0.621
10	63	19.327	19.793	0.466
10	64	19.268	19.783	0.515
10	65	19.247	19.698	0.451
10	66	18.461	18.940	0.478
10	150	18.860	19.319	0.458
10	237	18.198	19.863	1.664
10	241	18.978	18.883	-0.095
10	242	18.956	19.354	0.398
10	243	19.274	19.524	0.250
10	244	19.597	19.715	0.119
30	141	18.733	18.712	-0.021
30	144	19.367	19.535	0.168
30	145	18.868	18.875	0.006
30	146	19.147	19.218	0.071
30	147	18.914	18.769	-0.145
30	132	19.480	19.739	0.259
30	133	19.250	19.271	0.021
30	135	18.261	18.852	0.591
30	245	19.254	19.177	-0.077
30	246	18.729	18.497	-0.232
50	67	18.232	17.880	-0.352
50	68	18.699	19.276	0.576
50	69	19.152	19.027	-0.125
50	71	18.276	18.178	-0.097
50	72	18.493	18.618	0.125
50	172	19.200	18.877	-0.323
50	173	19.530	19.140	-0.390
50	174	18.916	19.305	0.389
50	183	18.617	18.228	-0.389
50	186	18.881	18.529	-0.352
100	95	19.359	18.968	-0.391
100	102	18.791	17.791	-1.001
100	104	19.072	18.400	-0.673
100	105	19.011	18.163	-0.849
100	106	19.213	18.476	-0.736
100	178	19.020	18.343	-0.677
100	179	19.232	18.219	-1.014
100	180	19.317	18.625	-0.692
100	181	19.128	18.142	-0.987
100	182	18.796	17.841	-0.955
	Max	19.673	19.941	1.664
	Average	18.923	18.964	0.041
	Min	17.971	17.791	-1.014
	Std Dev	0.424	0.570	0.575

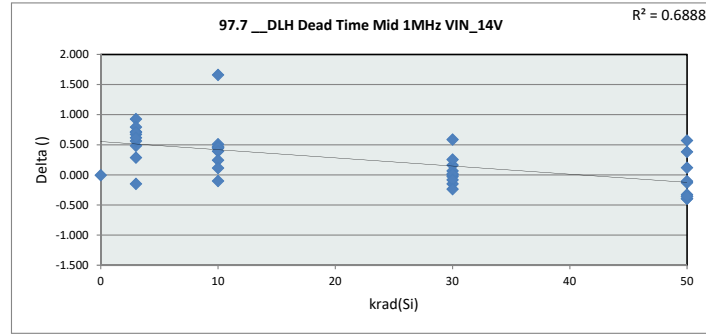

97.7_DLH Dead Time	
Test Site	DAL-FL
Tester	ETS364
Test Number	EB672302
Max Limit	24
Min Limit	15.5

krad(Si)	0	3	10	30	50	100
LL	15.500	15.500	15.500	15.500	15.500	15.500
Min	19.673	18.844	18.883	18.497	17.880	17.791
Average	19.673	19.195	19.487	19.064	18.706	18.297
Max	19.673	19.941	19.863	19.739	19.305	18.968
UL	24.000	24.000	24.000	24.000	24.000	24.000

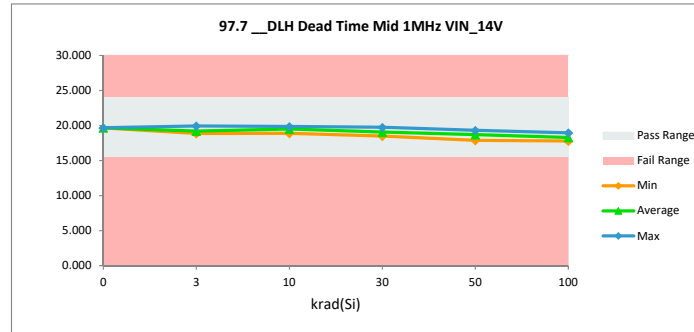

TID HDR Report
TPS7H6003-SP (5962R2220101VXC)

97.8 DLH Dead Time Large 1M		
Test Site	DAL-FL	DAL-FL
Tester	ETS364	ETS364
Test Number	EB672302	EB672302
Unit	nsec	
Max Limit	59	59
Min Limit	36	36

krad(Si)	Serial #	pre_short (rtp)	(2)ST_Combo (rpt)	Delta
0	Ctrl	47.515	47.515	0.000
3	58	46.377	46.902	0.525
3	59	43.971	44.699	0.728
3	60	45.462	45.910	0.448
3	61	44.084	44.630	0.546
3	62	43.880	44.296	0.417
3	134	46.900	44.260	-2.640
3	137	44.420	44.344	-0.077
3	138	44.049	44.302	0.252
3	139	46.116	46.351	0.236
3	236	47.423	46.519	-0.904
10	63	46.915	46.997	0.082
10	64	47.136	47.199	0.062
10	65	47.155	47.449	0.293
10	66	44.093	44.345	0.252
10	150	46.647	46.800	0.153
10	237	43.663	46.441	2.778
10	241	46.335	44.257	-2.078
10	242	46.652	46.802	0.150
10	243	46.247	46.252	0.005
10	244	46.465	46.555	0.090
30	141	46.200	45.489	-0.710
30	144	46.566	45.860	-0.706
30	145	44.765	44.175	-0.590
30	146	46.359	45.545	-0.814
30	147	46.047	45.296	-0.751
30	132	46.952	46.210	-0.742
30	133	46.270	45.579	-0.691
30	135	43.884	44.241	0.357
30	245	46.629	45.740	-0.890
30	246	46.494	45.279	-1.214
50	67	43.833	42.681	-1.152
50	68	46.321	45.521	-0.800
50	69	46.513	45.402	-1.111
50	71	44.038	43.058	-0.980
50	72	45.274	44.263	-1.011
50	172	44.714	43.809	-0.905
50	173	46.733	45.583	-1.150
50	174	46.737	45.907	-0.830
50	183	45.943	44.560	-1.383
50	186	44.441	43.600	-0.841
100	95	46.658	44.020	-2.638
100	102	45.915	42.981	-2.934
100	104	46.270	43.410	-2.860
100	105	46.266	43.115	-3.151
100	106	46.438	43.377	-3.061
100	178	45.578	43.055	-2.523
100	179	46.411	43.678	-2.734
100	180	47.025	44.279	-2.746
100	181	46.458	43.290	-3.168
100	182	45.530	43.092	-2.438
Max		47.515	47.515	2.778
Average		45.858	44.998	-0.860
Min		43.663	42.681	-3.168
Std Dev		1.116	1.354	1.273

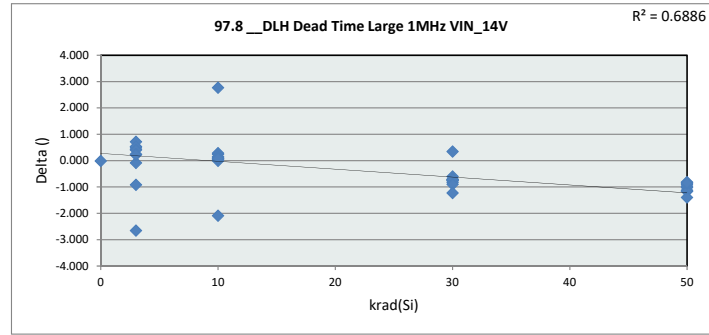

97.8 DLH Dead Time						
Test Site	DAL-FL					
Tester	ETS364					
Test Number	EB672302					
Max Limit	59					
Min Limit	36					
krad(Si)	0	3	10	30	50	100
LL	36.000	36.000	36.000	36.000	36.000	36.000
Min	47.515	44.260	44.257	44.175	42.681	42.981
Average	47.515	45.221	46.310	45.341	44.438	43.430
Max	47.515	46.902	47.449	46.210	45.907	44.279
UL	59.000	59.000	59.000	59.000	59.000	59.000

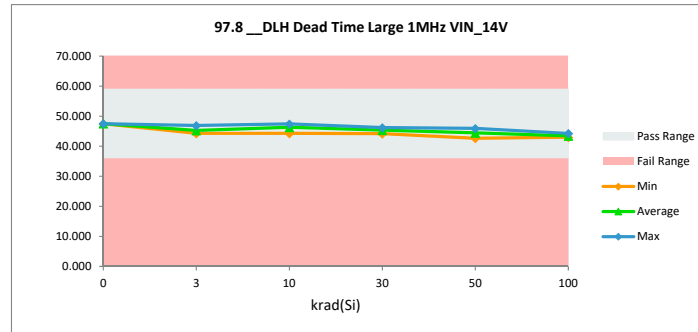

TID HDR Report
TPS7H6003-SP (5962R2220101VXC)

97.9 DLH Dead Time Max 1MHz		
Test Site	DAL-FL	DAL-FL
Tester	ETS364	ETS364
Test Number	EB672302	EB672302
Unit	nsec	
Max Limit	113.5	113.5
Min Limit	74	74

krad(Si)	Serial #	pre_short (rtp)	(2)'ST_Combo (rpt)	Delta
0	Ctrl	91.510	91.510	0.000
3	58	88.896	89.282	0.386
3	59	84.894	85.577	0.683
3	60	87.504	87.957	0.454
3	61	84.314	84.833	0.519
3	62	84.023	84.338	0.315
3	134	91.084	83.864	-7.220
3	137	85.172	83.874	-1.298
3	138	83.804	83.832	0.028
3	139	87.791	87.951	0.160
3	236	92.398	89.059	-3.339
10	63	90.872	90.750	-0.122
10	64	91.493	91.214	-0.279
10	65	90.965	90.757	-0.207
10	66	84.060	83.874	-0.186
10	150	90.535	90.436	-0.099
10	237	83.428	89.101	5.674
10	241	89.718	83.773	-5.945
10	242	90.230	89.943	-0.287
10	243	88.350	88.144	-0.206
10	244	89.229	89.001	-0.227
30	141	89.606	87.936	-1.670
30	144	89.563	87.618	-1.945
30	145	84.908	82.766	-2.141
30	146	89.605	87.361	-2.244
30	147	88.862	86.962	-1.899
30	132	89.999	88.099	-1.900
30	133	88.935	86.943	-1.992
30	135	83.669	83.072	-0.597
30	245	90.130	87.660	-2.469
30	246	89.984	87.574	-2.410
50	67	83.297	80.629	-2.668
50	68	89.500	86.866	-2.634
50	69	89.495	86.681	-2.814
50	71	83.632	80.720	-2.912
50	72	87.282	84.685	-2.597
50	172	84.372	82.079	-2.293
50	173	89.495	86.578	-2.917
50	174	90.744	88.043	-2.701
50	183	89.128	86.174	-2.954
50	186	83.944	81.463	-2.481
100	95	89.746	83.751	-5.995
100	102	88.325	81.636	-6.688
100	104	89.045	82.844	-6.200
100	105	88.576	81.755	-6.822
100	106	89.290	82.177	-7.113
100	178	86.894	81.503	-5.391
100	179	89.244	83.396	-5.848
100	180	90.217	84.116	-6.101
100	181	89.006	82.582	-6.423
100	182	87.417	81.968	-5.449
Max		92.398	91.510	5.674
Average		88.121	85.779	-2.343
Min		83.297	80.629	-7.220
Std Dev		2.607	3.092	2.663

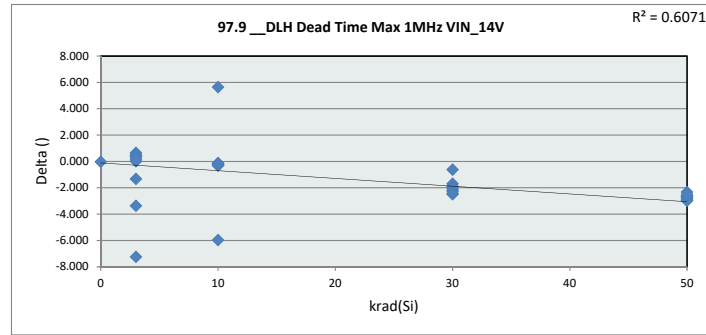

97.9 DLH Dead Time						
Test Site	DAL-FL					
Tester	ETS364					
Test Number	EB672302					
Max Limit	113.5					
Min Limit	74					
krad(Si)	0	3	10	30	50	100
LL	74.000	74.000	74.000	74.000	74.000	74.000
Min	91.510	83.832	83.773	82.766	80.629	81.503
Average	91.510	86.057	88.699	86.599	84.392	82.573
Max	91.510	89.282	91.214	88.099	88.043	84.116
UL	113.500	113.500	113.500	113.500	113.500	113.500

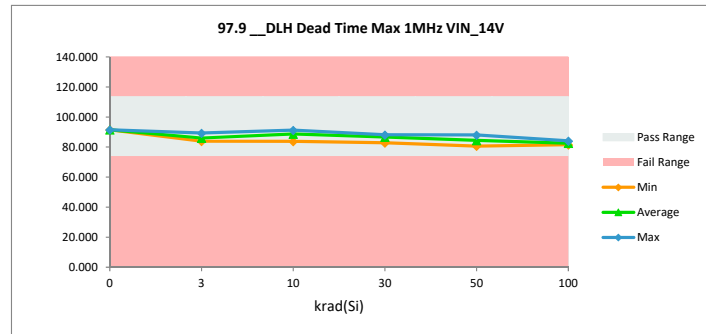

TID HDR Report
TPS7H6003-SP (5962R2220101VXC)

97.10_DLH Dead Time Min 2MHz		
Test Site	DAL-FL	DAL-FL
Tester	ETS364	ETS364
Test Number	EB672302	EB672302
Unit	nsec	
Max Limit	10	
Min Limit	0	

krad(Si)	Serial #	pre_short (rtp)	(2)'ST_Combo (rpt)	Delta
0	Ctrl	3.835	3.835	0.000
3	58	3.761	4.540	0.779
3	59	3.379	4.427	1.048
3	60	3.010	3.724	0.714
3	61	3.950	4.735	0.785
3	62	3.565	4.292	0.726
3	134	3.261	4.942	1.681
3	137	3.891	4.777	0.886
3	138	4.063	4.869	0.806
3	139	4.144	4.309	0.165
3	236	3.087	4.752	1.666
10	63	3.773	4.517	0.744
10	64	3.527	4.143	0.616
10	65	3.609	4.195	0.586
10	66	3.849	4.416	0.568
10	150	3.417	3.845	0.428
10	237	3.952	4.762	0.810
10	241	3.644	4.859	1.215
10	242	3.306	3.773	0.467
10	243	4.071	4.395	0.325
10	244	4.273	4.670	0.397
30	141	3.307	3.829	0.522
30	144	4.103	4.786	0.683
30	145	4.361	4.990	0.629
30	146	3.889	4.326	0.437
30	147	3.537	3.985	0.448
30	132	4.075	4.690	0.615
30	133	3.871	4.374	0.502
30	135	3.957	5.207	1.250
30	245	3.794	4.528	0.733
30	246	3.266	3.719	0.453
50	67	3.862	4.451	0.590
50	68	3.179	4.692	1.513
50	69	3.581	4.392	0.811
50	71	3.868	4.556	0.688
50	72	3.159	4.377	1.218
50	172	4.683	5.058	0.376
50	173	3.993	4.268	0.276
50	174	3.078	4.216	1.138
50	183	3.236	3.579	0.343
50	186	4.395	5.025	0.630
100	95	3.799	5.041	1.241
100	102	3.411	4.429	1.018
100	104	3.472	4.681	1.209
100	105	3.546	4.548	1.002
100	106	3.838	4.778	0.940
100	178	3.869	4.445	0.576
100	179	3.796	4.612	0.816
100	180	3.681	4.872	1.191
100	181	3.653	4.344	0.691
100	182	3.587	4.400	0.813
Max		4.683	5.207	1.681
Average		3.710	4.470	0.760
Min		3.010	3.579	0.000
Std Dev		0.366	0.387	0.363

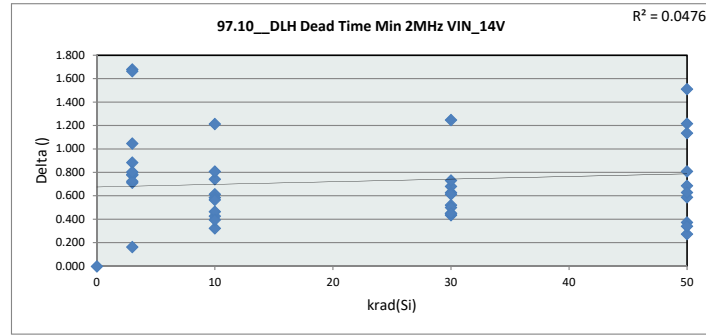

97.10_DLH Dead Time

Test Site	DAL-FL
Tester	ETS364
Test Number	EB672302
Max Limit	10
Min Limit	0

krad(Si)	0	3	10	30	50	100
LL	0.000	0.000	0.000	0.000	0.000	0.000
Min	3.835	3.724	3.773	3.719	3.579	4.344
Average	3.835	4.537	4.358	4.443	4.462	4.615
Max	3.835	4.942	4.859	5.207	5.058	5.041
UL	10.000	10.000	10.000	10.000	10.000	10.000

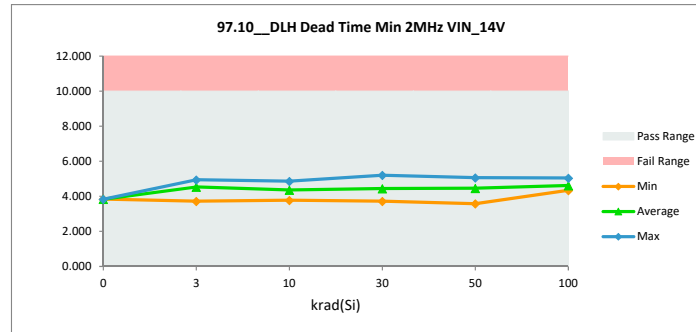

TID HDR Report
TPS7H6003-SP (5962R2220101VXC)

97.11_DLH Dead Time Small 2M		
Test Site	DAL-FL	DAL-FL
Tester	ETS364	ETS364
Test Number	EB672302	EB672302
Unit	nsec	
Max Limit	15.5	15.5
Min Limit	8	8

krad(Si)	Serial #	pre_short (rtp)	(2)ST_Combo (rpt)	Delta
0	Ctrl	10.910	10.910	0.000
3	58	10.833	11.585	0.752
3	59	9.989	10.876	0.887
3	60	10.034	10.752	0.718
3	61	10.472	11.239	0.767
3	62	10.069	10.701	0.632
3	134	10.487	11.228	0.741
3	137	10.382	11.140	0.758
3	138	10.375	11.206	0.831
3	139	10.932	11.316	0.383
3	236	10.312	11.486	1.174
10	63	10.782	11.251	0.469
10	64	10.656	11.270	0.614
10	65	10.745	11.097	0.352
10	66	10.421	10.993	0.572
10	150	10.421	10.866	0.445
10	237	10.429	11.645	1.216
10	241	10.669	11.231	0.562
10	242	10.407	10.847	0.439
10	243	10.975	11.424	0.448
10	244	11.310	11.505	0.195
30	141	10.260	10.656	0.397
30	144	11.024	11.381	0.356
30	145	10.889	11.136	0.247
30	146	10.833	11.071	0.238
30	147	10.461	10.701	0.240
30	132	11.018	11.264	0.246
30	133	10.845	11.021	0.176
30	135	10.358	11.320	0.962
30	245	10.850	11.058	0.208
30	246	10.179	10.313	0.134
50	67	10.391	10.572	0.181
50	68	10.284	11.234	0.950
50	69	10.558	10.909	0.351
50	71	10.303	10.423	0.120
50	72	10.095	10.975	0.880
50	172	11.249	11.278	0.029
50	173	11.089	10.895	-0.194
50	174	10.198	10.896	0.698
50	183	10.233	10.193	-0.041
50	186	10.850	10.925	0.075
100	95	10.886	11.223	0.337
100	102	10.431	10.307	-0.125
100	104	10.613	10.611	-0.002
100	105	10.447	10.439	-0.008
100	106	10.826	10.711	-0.114
100	178	10.704	10.442	-0.262
100	179	10.764	10.454	-0.310
100	180	10.741	10.790	0.049
100	181	10.671	10.397	-0.274
100	182	10.432	10.328	-0.104
	Max	11.310	11.645	1.216
	Average	10.590	10.951	0.361
	Min	9.989	10.193	-0.310
	Std Dev	0.318	0.371	0.383

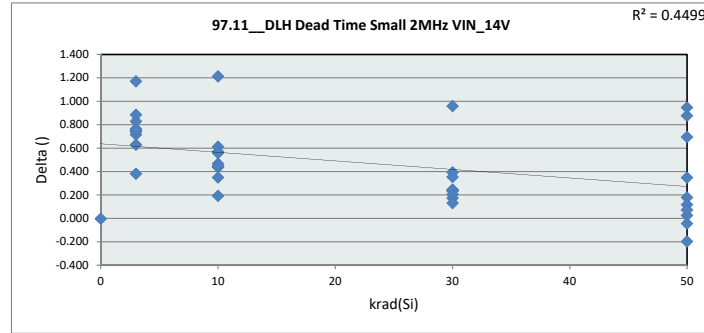

97.11_DLH Dead Time Small 2MHz VIN_14V						
Test Site	DAL-FL					
Tester	ETS364					
Test Number	EB672302					
Max Limit	15.5					
Min Limit	8					
krad(Si)	0	3	10	30	50	100
LL	8.000	8.000	8.000	8.000	8.000	8.000
Min	10.910	10.701	10.847	10.313	10.193	10.307
Average	10.910	11.153	11.213	10.992	10.830	10.570
Max	10.910	11.585	11.645	11.381	11.278	11.223
UL	15.500	15.500	15.500	15.500	15.500	15.500

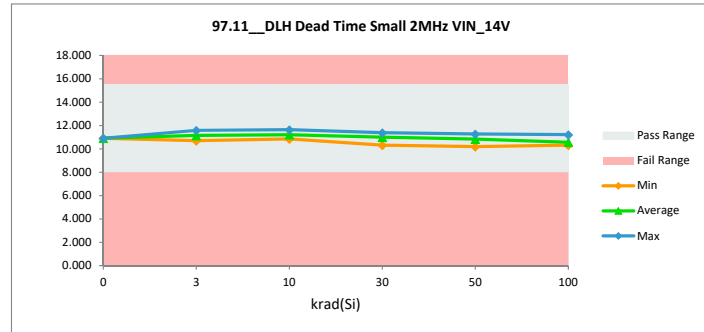

TID HDR Report
TPS7H6003-SP (5962R2220101VXC)

97.12_DLH Dead Time Mid 2MH		
Test Site	DAL-FL	DAL-FL
Tester	ETS364	ETS364
Test Number	EB672302	EB672302
Unit	nsec	
Max Limit	24	
Min Limit	15.5	

krad(Si)	Serial #	pre_short (rtp) (2)	ST_Combo (rpt) (Delta
0	Ctrl	19.403	19.403	0.000
3	58	19.096	19.733	0.638
3	59	17.868	18.546	0.678
3	60	18.304	18.969	0.665
3	61	18.228	18.872	0.643
3	62	17.854	18.519	0.666
3	134	18.974	18.834	-0.140
3	137	18.074	18.726	0.652
3	138	18.082	18.868	0.786
3	139	19.044	19.403	0.359
3	236	18.948	19.501	0.553
10	63	19.105	19.435	0.330
10	64	19.094	19.557	0.463
10	65	19.141	19.430	0.289
10	66	18.231	18.764	0.534
10	150	18.681	19.105	0.425
10	237	18.135	19.552	1.417
10	241	18.925	18.934	0.009
10	242	18.790	19.270	0.480
10	243	19.129	19.535	0.405
10	244	19.515	19.730	0.215
30	141	18.632	18.481	-0.151
30	144	19.327	19.185	-0.142
30	145	18.769	18.851	0.083
30	146	19.060	18.926	-0.134
30	147	18.817	18.560	-0.257
30	132	19.373	19.415	0.042
30	133	19.091	19.093	0.001
30	135	18.046	18.837	0.791
30	245	19.041	18.982	-0.059
30	246	18.482	18.473	-0.008
50	67	18.171	17.759	-0.412
50	68	18.611	19.184	0.572
50	69	18.947	18.862	-0.085
50	71	17.974	17.831	-0.143
50	72	18.329	18.712	0.383
50	172	18.886	18.757	-0.129
50	173	19.435	18.957	-0.479
50	174	18.730	19.044	0.313
50	183	18.511	18.069	-0.442
50	186	18.594	18.365	-0.229
100	95	19.191	18.715	-0.476
100	102	18.683	17.658	-1.025
100	104	18.966	18.371	-0.596
100	105	18.780	18.084	-0.696
100	106	19.112	18.330	-0.782
100	178	18.750	18.012	-0.737
100	179	19.039	18.182	-0.857
100	180	19.082	18.468	-0.614
100	181	18.857	17.993	-0.865
100	182	18.622	17.983	-0.639
	Max	19.515	19.733	1.417
	Average	18.755	18.800	0.045
	Min	17.854	17.658	-1.025
	Std Dev	0.434	0.539	0.537

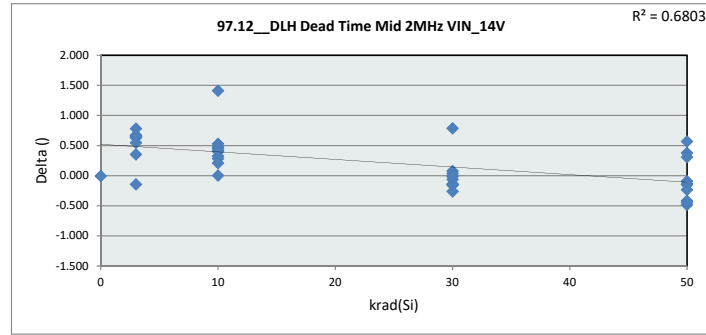

97.12_DLH Dead Time

Test Site	DAL-FL
Tester	ETS364
Test Number	EB672302
Max Limit	24
Min Limit	15.5

krad(Si)	0	3	10	30	50	100
LL	15.500	15.500	15.500	15.500	15.500	15.500
Min	19.403	18.519	18.764	18.473	17.759	17.658
Average	19.403	18.997	19.331	18.880	18.554	18.180
Max	19.403	19.734	19.730	19.415	19.184	18.715
UL	24.000	24.000	24.000	24.000	24.000	24.000

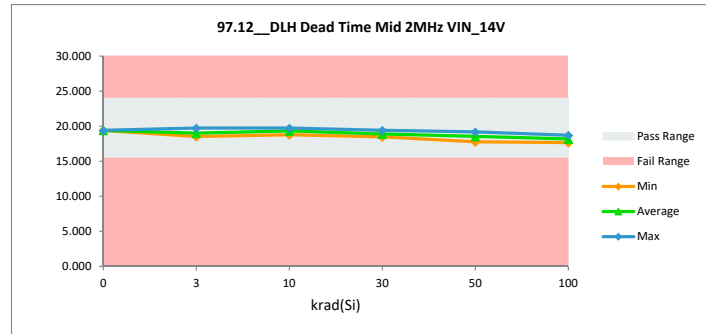

TID HDR Report
TPS7H6003-SP (5962R2220101VXC)

97.13 DLH Dead Time Large 2MHz		
Test Site	DAL-FL	DAL-FL
Tester	ETS364	ETS364
Test Number	EB672302	EB672302
Unit	nsec	
Max Limit	59	59
Min Limit	36	36

krad(Si)	Serial #	pre_short (rtp)	(2)'ST_Combo (rpt)	Delta
0	Ctrl	47.272	47.272	0.000
3	58	46.090	46.634	0.544
3	59	43.691	44.341	0.650
3	60	45.137	45.603	0.467
3	61	43.808	44.345	0.536
3	62	43.616	44.183	0.567
3	134	46.622	43.966	-2.655
3	137	44.055	43.994	-0.061
3	138	43.660	43.683	0.023
3	139	45.684	45.927	0.243
3	236	47.015	46.161	-0.854
10	63	46.563	46.763	0.200
10	64	46.665	46.965	0.300
10	65	46.791	47.060	0.269
10	66	43.753	44.128	0.375
10	150	46.220	46.364	0.144
10	237	43.379	46.094	2.715
10	241	45.781	43.661	-2.119
10	242	46.447	46.412	-0.035
10	243	45.925	46.153	0.228
10	244	46.180	46.167	-0.013
30	141	45.737	45.120	-0.617
30	144	46.192	45.411	-0.781
30	145	44.457	43.622	-0.835
30	146	46.208	45.190	-1.018
30	147	45.630	44.982	-0.648
30	132	46.437	45.984	-0.453
30	133	45.925	45.125	-0.800
30	135	43.497	43.928	0.431
30	245	46.325	45.366	-0.959
30	246	45.996	45.063	-0.933
50	67	43.636	42.408	-1.228
50	68	46.124	45.345	-0.779
50	69	46.119	44.913	-1.206
50	71	43.661	42.863	-0.798
50	72	44.956	43.964	-0.992
50	172	44.305	43.496	-0.809
50	173	46.512	45.192	-1.319
50	174	46.455	45.703	-0.752
50	183	45.674	44.261	-1.413
50	186	44.183	43.187	-0.996
100	95	46.447	43.958	-2.489
100	102	45.654	42.641	-3.013
100	104	46.052	43.308	-2.744
100	105	45.754	42.584	-3.170
100	106	46.154	43.273	-2.882
100	178	45.132	42.989	-2.143
100	179	46.147	43.419	-2.728
100	180	46.603	43.940	-2.663
100	181	46.017	43.171	-2.847
100	182	45.184	42.618	-2.566
Max		47.272	47.272	2.715
Average		45.520	44.684	-0.836
Min		43.379	42.408	-3.170
Std Dev		1.107	1.347	1.250

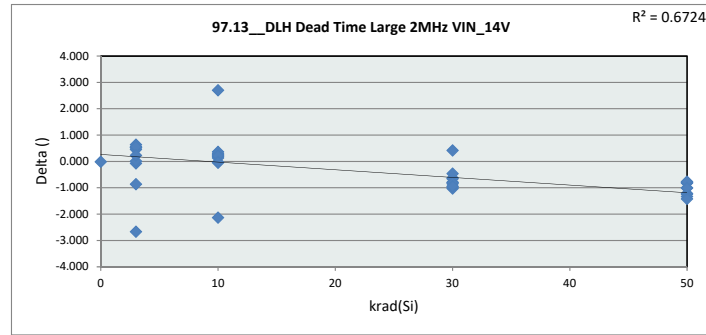

97.13 DLH Dead Time Large 2MHz VIN_14V						
Test Site	DAL-FL					
Tester	ETS364					
Test Number	EB672302					
Max Limit	59					
Min Limit	36					
krad(Si)	0	3	10	30	50	100
LL	36.000	36.000	36.000	36.000	36.000	36.000
Min	47.272	43.683	43.661	43.622	42.408	42.584
Average	47.272	44.884	45.977	44.979	44.133	43.190
Max	47.272	46.634	47.060	45.984	45.703	43.958
UL	59.000	59.000	59.000	59.000	59.000	59.000

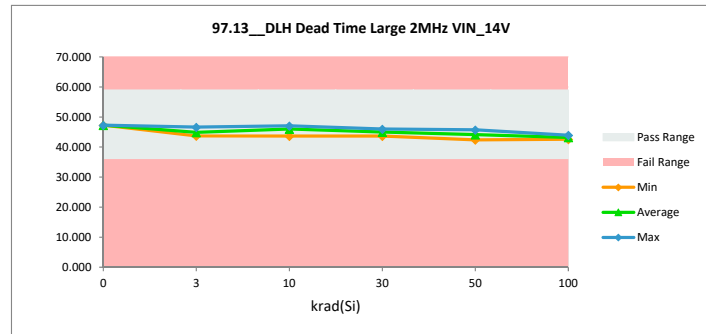

TID HDR Report
TPS7H6003-SP (5962R2220101VXC)

97.14 DLH Dead Time Max 2MHz		
Test Site	DAL-FL	DAL-FL
Tester	ETS364	ETS364
Test Number	EB672302	EB672302
Unit	nsec	
Max Limit	113.5	113.5
Min Limit	74	74

krad(Si)	Serial #	pre_short (rtp) (2)	ST_Combo (rpt) (Delta
0	Ctrl	92.547	92.547	0.000
3	58	89.541	90.070	0.529
3	59	85.351	86.088	0.737
3	60	88.229	88.504	0.275
3	61	84.927	85.723	0.796
3	62	84.602	85.025	0.423
3	134	91.862	84.125	-7.737
3	137	85.667	84.228	-1.439
3	138	84.179	84.192	0.012
3	139	88.316	88.434	0.118
3	236	93.268	89.674	-3.594
10	63	91.581	91.484	-0.097
10	64	92.232	91.920	-0.312
10	65	91.594	91.571	-0.023
10	66	84.642	84.667	0.025
10	150	91.167	91.183	0.016
10	237	83.871	89.727	5.855
10	241	90.383	84.173	-6.210
10	242	91.068	90.827	-0.241
10	243	89.061	88.884	-0.176
10	244	89.874	89.526	-0.348
30	141	90.164	88.610	-1.553
30	144	90.186	88.273	-1.913
30	145	85.384	83.269	-2.115
30	146	90.457	88.378	-2.079
30	147	89.470	87.738	-1.732
30	132	90.740	88.968	-1.772
30	133	89.684	87.640	-2.044
30	135	84.093	83.648	-0.445
30	245	90.752	88.390	-2.362
30	246	90.580	88.156	-2.424
50	67	83.780	80.929	-2.851
50	68	90.314	87.392	-2.922
50	69	90.162	87.195	-2.967
50	71	84.034	81.269	-2.765
50	72	87.986	85.187	-2.798
50	172	84.855	82.496	-2.359
50	173	90.131	87.417	-2.714
50	174	91.499	88.995	-2.504
50	183	89.930	87.009	-2.921
50	186	84.527	82.026	-2.501
100	95	90.425	84.467	-5.958
100	102	89.093	82.263	-6.829
100	104	89.800	83.618	-6.181
100	105	89.294	82.443	-6.851
100	106	90.186	82.895	-7.291
100	178	87.494	82.224	-5.270
100	179	90.068	84.091	-5.977
100	180	90.849	84.784	-6.065
100	181	89.698	83.318	-6.380
100	182	88.091	82.609	-5.483
Max		93.268	92.547	5.855
Average		88.778	86.437	-2.342
Min		83.780	80.929	-7.737
Std Dev		2.711	3.170	2.733

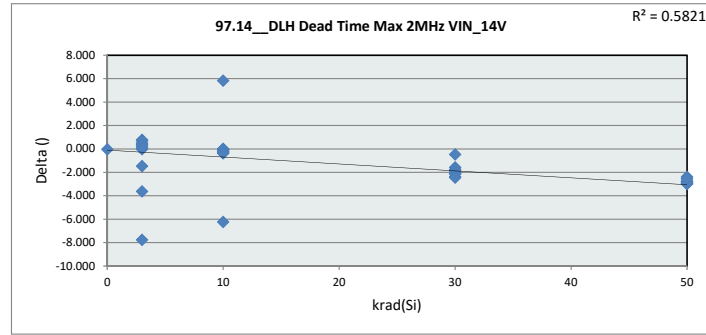

97.14 DLH Dead Time Max 2MHz VIN_14V						
Test Site	DAL-FL					
Tester	ETS364					
Test Number	EB672302					
Max Limit	113.5					
Min Limit	74					
krad(Si)	0	3	10	30	50	100
LL	74.000	74.000	74.000	74.000	74.000	74.000
Min	92.547	84.125	84.173	83.269	80.929	82.224
Average	92.547	86.606	89.396	87.307	84.992	83.271
Max	92.547	90.070	91.920	88.968	88.995	84.784
UL	113.500	113.500	113.500	113.500	113.500	113.500

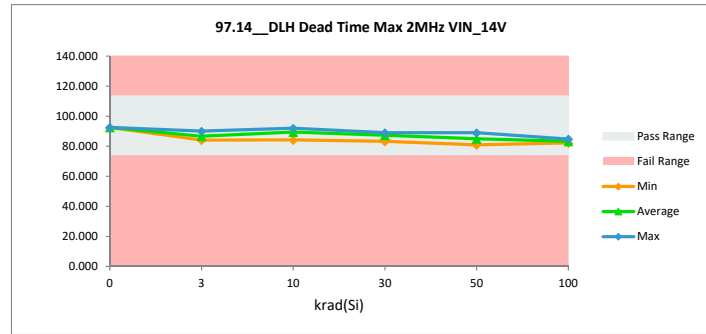

TID HDR Report
TPS7H6003-SP (5962R2220101VXC)

97.19 DHL Dead Time Min 500kHz		
Test Site	DAL-FL	DAL-FL
Tester	ETS364	ETS364
Test Number	EB672302	EB672302
Unit	nsec	
Max Limit	10	10
Min Limit	0	0

krad(Si)	Serial #	pre_short (rtp)	(2)ST_Combo (rpt)	Delta
0	Ctrl	3.850	3.850	0.000
3	58	4.497	3.933	-0.564
3	59	4.829	4.345	-0.484
3	60	4.650	4.438	-0.212
3	61	3.965	3.307	-0.658
3	62	3.999	3.378	-0.621
3	134	4.313	4.291	-0.021
3	137	4.258	4.155	-0.103
3	138	3.996	4.176	0.180
3	139	4.599	4.194	-0.405
3	236	4.175	4.557	0.382
10	63	4.783	4.363	-0.420
10	64	4.304	4.011	-0.293
10	65	4.534	4.103	-0.431
10	66	3.551	3.239	-0.311
10	150	4.850	4.880	0.030
10	237	4.588	4.377	-0.211
10	241	4.593	4.276	-0.317
10	242	4.482	4.022	-0.460
10	243	3.586	3.572	-0.014
10	244	4.146	3.877	-0.269
30	141	4.267	4.311	0.043
30	144	4.063	3.984	-0.079
30	145	3.949	3.564	-0.386
30	146	4.038	4.031	-0.007
30	147	4.745	4.722	-0.022
30	132	3.828	3.815	-0.014
30	133	4.511	4.451	-0.060
30	135	4.666	3.307	-1.359
30	245	3.900	3.816	-0.084
30	246	4.408	4.347	-0.061
50	67	4.836	4.382	-0.454
50	68	3.714	3.866	0.152
50	69	4.708	4.305	-0.402
50	71	3.335	2.892	-0.443
50	72	4.657	4.377	-0.280
50	172	4.205	3.886	-0.319
50	173	4.079	4.089	0.011
50	174	4.340	4.084	-0.256
50	183	4.602	4.654	0.053
50	186	3.527	3.741	0.214
100	95	4.876	4.407	-0.469
100	102	4.226	4.173	-0.053
100	104	4.887	4.435	-0.453
100	105	4.211	3.742	-0.469
100	106	4.163	4.105	-0.058
100	178	4.507	4.699	0.191
100	179	4.022	4.365	0.343
100	180	4.316	4.664	0.348
100	181	4.304	4.547	0.243
100	182	3.586	3.725	0.140
Max		4.887	4.880	0.382
Average		4.275	4.095	-0.180
Min		3.335	2.892	-1.359
Std Dev		0.397	0.421	0.316

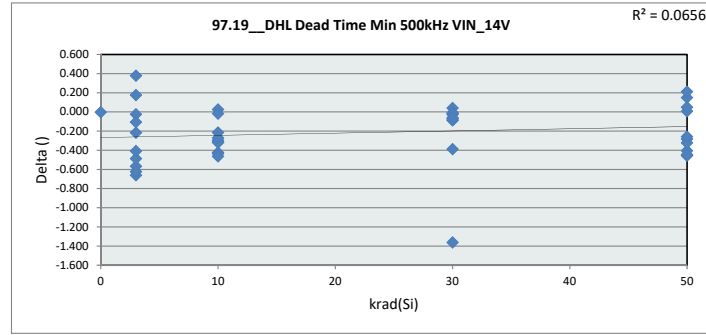

97.19 DHL Dead Time Min 500kHz VIN_14V

97.19 DHL Dead Time Min 500kHz VIN_14V	
Test Site	DAL-FL
Tester	ETS364
Test Number	EB672302
Max Limit	10
Min Limit	0

krad(Si)	0	3	10	30	50	100
LL	0.000	0.000	0.000	0.000	0.000	0.000
Min	3.850	3.307	3.239	3.307	2.892	3.725
Average	3.850	4.078	4.072	4.035	4.028	4.286
Max	3.850	4.557	4.880	4.722	4.654	4.699
UL	10.000	10.000	10.000	10.000	10.000	10.000

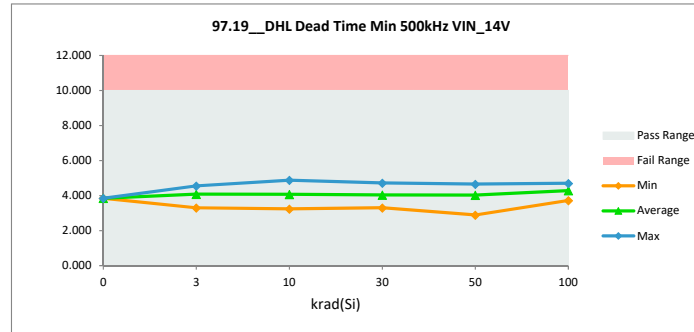

TID HDR Report

TPS7H6003-SP (5962R2220101VXC)

97.20 DHL Dead Time Small 50		
Test Site	DAL-FL	DAL-FL
Tester	ETS364	ETS364
Test Number	EB672302	EB672302
Unit	nsec	
Max Limit	15	15
Min Limit	6	6

krad(Si)	Serial #	pre_short (rtp)	(2)'ST_Combo (rpt)	Delta
0	Ctrl	9.561	9.561	0.000
3	58	10.069	9.559	-0.510
3	59	10.118	9.628	-0.490
3	60	9.940	9.552	-0.388
3	61	9.667	9.144	-0.522
3	62	9.810	9.165	-0.645
3	134	9.894	9.449	-0.445
3	137	9.628	9.611	-0.017
3	138	9.543	9.525	-0.018
3	139	9.777	9.611	-0.167
3	236	9.463	9.863	0.400
10	63	10.424	10.095	-0.329
10	64	9.939	9.557	-0.382
10	65	9.865	9.467	-0.397
10	66	9.295	8.852	-0.443
10	150	10.106	10.123	0.018
10	237	10.173	9.807	-0.366
10	241	9.898	9.442	-0.455
10	242	10.005	9.623	-0.381
10	243	9.182	9.195	0.013
10	244	9.517	9.479	-0.037
30	141	9.514	9.302	-0.213
30	144	9.701	9.454	-0.248
30	145	9.764	8.995	-0.769
30	146	9.657	9.435	-0.222
30	147	10.169	9.818	-0.351
30	132	9.629	9.554	-0.075
30	133	10.151	9.936	-0.215
30	135	10.207	8.760	-1.447
30	245	9.410	9.281	-0.129
30	246	9.794	9.624	-0.170
50	67	10.496	9.937	-0.559
50	68	9.445	9.233	-0.212
50	69	10.250	9.591	-0.659
50	71	9.059	8.332	-0.727
50	72	9.904	9.263	-0.641
50	172	9.645	9.157	-0.488
50	173	9.796	9.574	-0.222
50	174	9.820	9.326	-0.494
50	183	10.088	9.814	-0.274
50	186	9.314	9.083	-0.231
100	95	10.173	9.225	-0.948
100	102	9.805	9.332	-0.473
100	104	10.345	9.603	-0.742
100	105	9.903	8.741	-1.162
100	106	9.783	9.404	-0.379
100	178	9.952	9.693	-0.259
100	179	9.720	9.445	-0.275
100	180	9.985	9.751	-0.234
100	181	9.849	9.434	-0.415
100	182	9.216	8.902	-0.314
Max		10.496	10.123	0.400
Average		9.812	9.437	-0.375
Min		9.059	8.332	-1.447
Std Dev		0.322	0.349	0.308

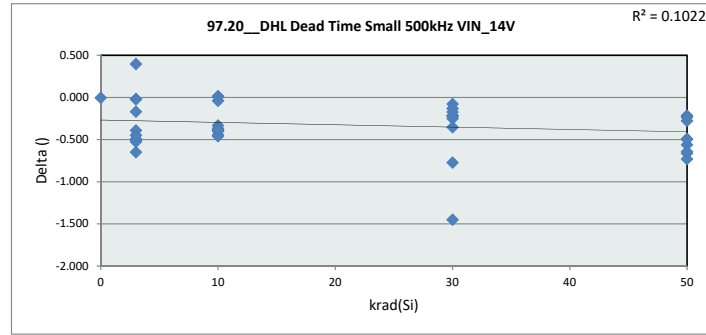

97.20 DHL Dead Time

Test Site	DAL-FL
Tester	ETS364
Test Number	EB672302
Max Limit	15
Min Limit	6

krad(Si)	0	3	10	30	50	100
LL	6.000	6.000	6.000	6.000	6.000	6.000
Min	9.561	9.144	8.852	8.760	8.332	8.741
Average	9.561	9.511	9.564	9.416	9.331	9.353
Max	9.561	9.863	10.124	9.936	9.937	9.751
UL	15.000	15.000	15.000	15.000	15.000	15.000

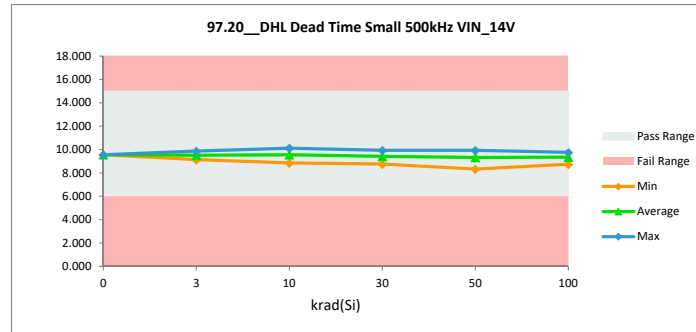

TID HDR Report
TPS7H6003-SP (5962R2220101VXC)

97.21 DHL Dead Time Mid 500kHz		
Test Site	DAL-FL	DAL-FL
Tester	ETS364	ETS364
Test Number	EB672302	EB672302
Unit	nsec	
Max Limit	24.5	24.5
Min Limit	16	16

krad(Si)	Serial #	pre_short (rtp)	(2)ST_Combo (rpt)	Delta
0	Ctrl	19.788	19.788	0.000
3	58	20.119	19.601	-0.518
3	59	19.780	19.125	-0.655
3	60	19.673	19.109	-0.565
3	61	19.836	19.267	-0.569
3	62	20.198	19.451	-0.747
3	134	19.978	19.375	-0.603
3	137	19.366	19.387	0.021
3	138	19.691	19.210	-0.481
3	139	19.551	19.292	-0.260
3	236	19.164	19.733	0.569
10	63	20.631	20.125	-0.506
10	64	20.065	19.679	-0.386
10	65	19.670	19.268	-0.402
10	66	19.644	19.094	-0.549
10	150	19.852	19.826	-0.026
10	237	20.137	19.705	-0.432
10	241	19.644	19.308	-0.337
10	242	20.038	19.766	-0.272
10	243	19.564	19.516	-0.048
10	244	19.629	19.179	-0.450
30	141	19.237	18.826	-0.410
30	144	19.941	19.346	-0.596
30	145	20.141	19.345	-0.797
30	146	19.650	19.172	-0.478
30	147	19.980	19.414	-0.566
30	132	19.962	19.572	-0.390
30	133	20.249	19.908	-0.340
30	135	20.148	18.865	-1.283
30	245	19.511	19.051	-0.460
30	246	19.490	19.238	-0.252
50	67	20.459	19.463	-0.995
50	68	19.658	19.049	-0.609
50	69	20.224	19.285	-0.939
50	71	19.420	18.294	-1.126
50	72	19.678	18.572	-1.106
50	172	19.470	18.652	-0.818
50	173	19.942	19.346	-0.596
50	174	20.009	19.098	-0.911
50	183	19.997	19.301	-0.696
50	186	19.707	19.090	-0.617
100	95	19.826	18.250	-1.576
100	102	19.866	18.488	-1.378
100	104	20.213	18.823	-1.390
100	105	20.235	18.486	-1.749
100	106	19.910	18.831	-1.079
100	178	19.949	19.055	-0.894
100	179	19.805	18.937	-0.868
100	180	20.068	19.179	-0.889
100	181	19.930	18.695	-1.236
100	182	19.364	18.371	-0.993
Max		20.631	20.125	0.569
Average		19.844	19.192	-0.652
Min		19.164	18.250	-1.749
Std Dev		0.306	0.425	0.433

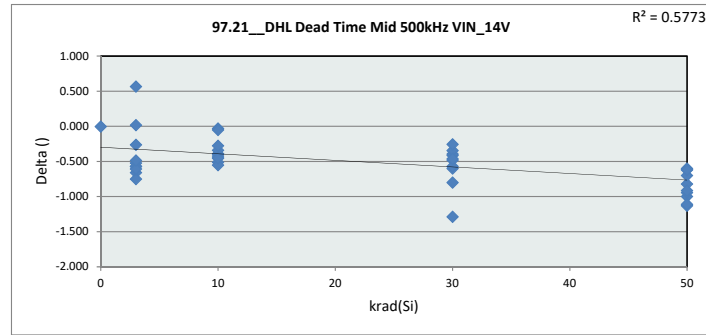

97.21 DHL Dead Time		
Test Site	DAL-FL	
Tester	ETS364	
Test Number	EB672302	
Max Limit	24.5	
Min Limit	16	

krad(Si)	0	3	10	30	50	100
LL	16.000	16.000	16.000	16.000	16.000	16.000
Min	19.788	19.109	19.094	18.826	18.294	18.250
Average	19.788	19.355	19.547	19.274	19.015	18.712
Max	19.788	19.733	20.125	19.908	19.463	19.179
UL	24.500	24.500	24.500	24.500	24.500	24.500

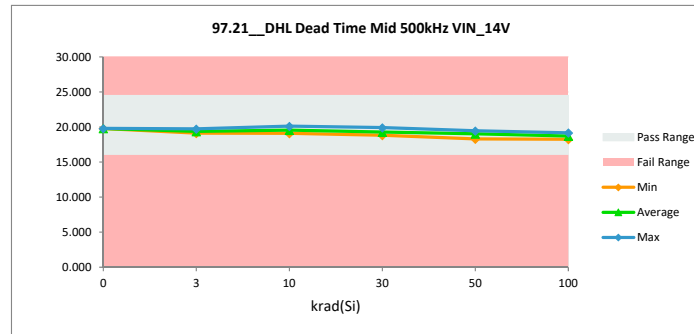

TID HDR Report
TPS7H6003-SP (5962R2220101VXC)

97.22 DHL Dead Time Large 50		
Test Site	DAL-FL	DAL-FL
Tester	ETS364	ETS364
Test Number	EB672302	EB672302
Unit	nsec	
Max Limit	61	61
Min Limit	44	44

krad(Si)	Serial #	pre_short (rtp) (2)	ST_Combo (rpt) (Delta
0	Ctrl	50.846	50.846	0.000
3	58	50.650	50.109	-0.541
3	59	49.081	48.516	-0.565
3	60	49.112	48.633	-0.479
3	61	51.105	50.508	-0.597
3	62	52.283	51.440	-0.843
3	134	50.680	48.977	-1.702
3	137	48.996	49.131	0.135
3	138	50.661	49.006	-1.655
3	139	49.417	49.113	-0.303
3	236	48.737	49.770	1.033
10	63	51.814	51.154	-0.660
10	64	51.286	50.757	-0.529
10	65	49.522	48.896	-0.626
10	66	50.823	50.200	-0.622
10	150	49.332	49.185	-0.147
10	237	50.595	49.728	-0.867
10	241	49.515	49.212	-0.303
10	242	50.914	50.285	-0.629
10	243	51.231	50.829	-0.401
10	244	50.118	49.542	-0.576
30	141	48.835	47.724	-1.111
30	144	50.958	49.527	-1.431
30	145	51.907	50.393	-1.514
30	146	50.485	49.256	-1.229
30	147	49.672	48.476	-1.195
30	132	51.452	50.524	-0.928
30	133	51.358	50.300	-1.058
30	135	50.578	49.681	-0.897
30	245	49.925	48.825	-1.100
30	246	49.040	48.142	-0.898
50	67	51.073	49.146	-1.927
50	68	50.631	49.243	-1.388
50	69	50.725	48.375	-2.350
50	71	50.995	48.545	-2.451
50	72	49.418	46.961	-2.456
50	172	49.478	47.423	-2.055
50	173	50.819	49.226	-1.593
50	174	50.785	48.510	-2.275
50	183	50.518	48.370	-2.149
50	186	51.399	49.376	-2.023
100	95	49.488	45.382	-4.106
100	102	50.620	46.984	-3.636
100	104	50.624	46.985	-3.639
100	105	52.042	48.202	-3.840
100	106	50.906	47.641	-3.265
100	178	50.382	47.049	-3.334
100	179	50.502	47.638	-2.864
100	180	51.058	47.629	-3.430
100	181	50.577	46.819	-3.758
100	182	50.316	47.075	-3.241
	Max	52.283	51.440	1.033
	Average	50.457	48.927	-1.530
	Min	48.737	45.382	-4.106
	Std Dev	0.875	1.311	1.218

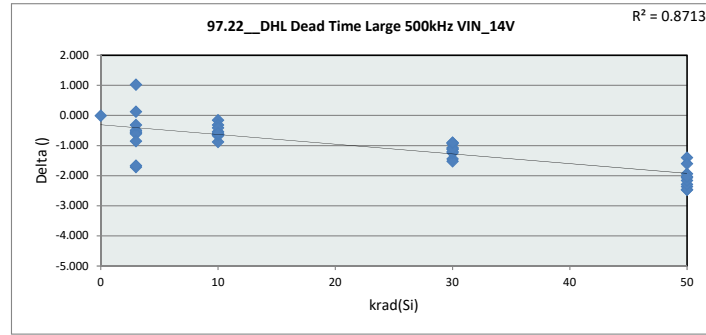

97.22 DHL Dead Time Large 500kHz VIN_14V						
Test Site	DAL-FL					
Tester	ETS364					
Test Number	EB672302					
Max Limit	61					
Min Limit	44					
krad(Si)	0	3	10	30	50	100
LL	44.000	44.000	44.000	44.000	44.000	44.000
Min	50.846	48.516	48.896	47.725	46.962	45.382
Average	50.846	49.520	49.979	49.285	48.517	47.140
Max	50.846	51.440	51.155	50.524	49.376	48.202
UL	61.000	61.000	61.000	61.000	61.000	61.000

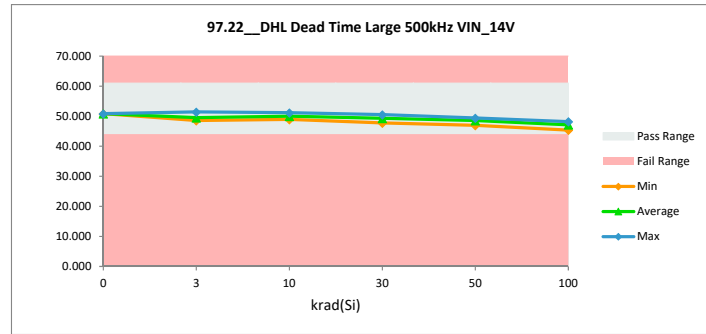

TID HDR Report
TPS7H6003-SP (5962R2220101VXC)

97.23 DHL Dead Time Max 500		
Test Site	DAL-FL	DAL-FL
Tester	ETS364	ETS364
Test Number	EB672302	EB672302
Unit	nsec	
Max Limit	125	
Min Limit	86	

krad(Si)	Serial #	pre_short (rtp) (2)	ST_Combo (rpt) (Delta
0	Ctrl	99.641	99.641	0.000
3	58	98.427	97.799	-0.628
3	59	95.016	94.457	-0.558
3	60	95.778	95.406	-0.372
3	61	100.436	99.854	-0.582
3	62	102.665	102.081	-0.584
3	134	99.168	96.530	-2.638
3	137	96.226	96.531	0.305
3	138	99.858	96.566	-3.292
3	139	96.966	96.371	-0.595
3	236	95.367	97.340	1.972
10	63	100.987	99.984	-1.003
10	64	100.946	100.135	-0.811
10	65	96.757	95.842	-0.914
10	66	99.881	98.937	-0.944
10	150	95.433	95.007	-0.426
10	237	98.882	97.416	-1.466
10	241	96.574	96.577	0.003
10	242	99.431	98.204	-1.227
10	243	101.228	100.351	-0.877
10	244	98.231	97.287	-0.945
30	141	95.874	93.491	-2.384
30	144	99.987	97.488	-2.500
30	145	102.228	99.363	-2.865
30	146	99.252	97.039	-2.213
30	147	97.221	94.817	-2.404
30	132	101.363	99.576	-1.787
30	133	100.756	98.734	-2.023
30	135	98.428	98.609	0.181
30	245	97.864	95.623	-2.241
30	246	95.757	94.152	-1.605
50	67	99.655	95.913	-3.742
50	68	99.241	97.871	-1.371
50	69	98.611	94.026	-4.585
50	71	100.594	95.928	-4.666
50	72	96.316	91.625	-4.690
50	172	96.755	92.719	-4.036
50	173	99.725	96.263	-3.462
50	174	99.467	94.952	-4.515
50	183	98.629	94.147	-4.481
50	186	101.796	97.342	-4.455
100	95	96.670	88.233	-8.437
100	102	99.347	91.692	-7.654
100	104	98.467	91.367	-7.101
100	105	102.712	95.211	-7.501
100	106	100.171	92.902	-7.269
100	178	98.520	91.558	-6.962
100	179	98.935	92.494	-6.441
100	180	99.914	92.545	-7.370
100	181	98.826	91.159	-7.667
100	182	98.999	92.134	-6.866
Max		102.712	102.081	1.972
Average		98.823	95.908	-2.916
Min		95.016	88.233	-8.437
Std Dev		1.980	2.944	2.659

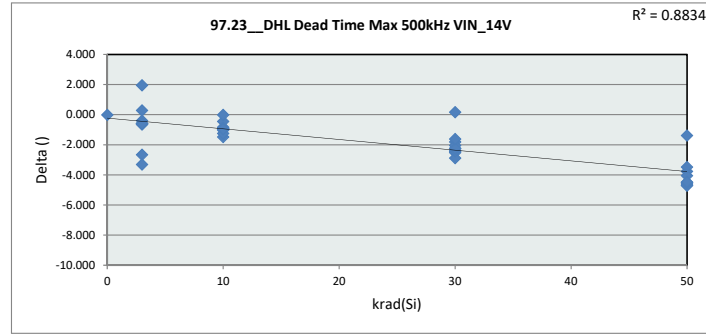

97.23 DHL Dead Time						
Test Site	DAL-FL					
Tester	ETS364					
Test Number	EB672302					
Max Limit	125					
Min Limit	86					
krad(Si)	0	3	10	30	50	100
LL	86.000	86.000	86.000	86.000	86.000	86.000
Min	99.641	94.457	95.007	93.491	91.625	88.233
Average	99.641	97.293	97.974	96.889	95.079	91.929
Max	99.641	102.081	100.351	99.576	97.871	95.211
UL	125.000	125.000	125.000	125.000	125.000	125.000

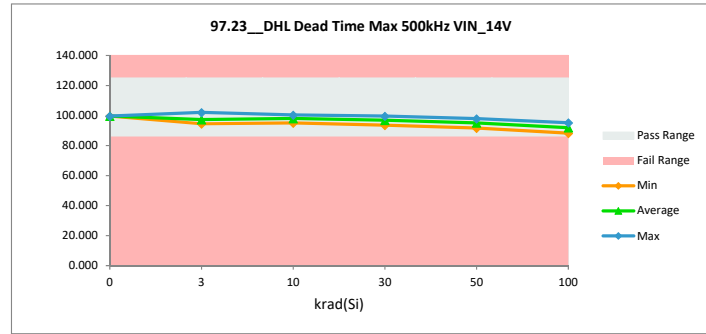

TID HDR Report
TPS7H6003-SP (5962R2220101VXC)

97.24 DHL Dead Time Min 1MHz		
Test Site	DAL-FL	DAL-FL
Tester	ETS364	ETS364
Test Number	EB672302	EB672302
Unit	nsec	
Max Limit	10	10
Min Limit	0	0

krad(Si)	Serial #	pre_short (rtp)	(2)ST_Combo (rpt)	Delta
0	Ctrl	4.228	4.228	0.000
3	58	4.830	4.189	-0.641
3	59	5.097	4.543	-0.554
3	60	4.932	4.566	-0.366
3	61	4.214	3.557	-0.657
3	62	4.172	3.755	-0.417
3	134	4.550	4.491	-0.058
3	137	4.569	4.325	-0.244
3	138	4.281	4.483	0.203
3	139	4.762	4.456	-0.307
3	236	4.384	4.667	0.283
10	63	5.115	4.752	-0.363
10	64	4.587	4.133	-0.454
10	65	4.690	4.392	-0.298
10	66	3.863	3.480	-0.383
10	150	5.096	5.089	-0.007
10	237	4.956	4.614	-0.342
10	241	4.790	4.389	-0.401
10	242	4.721	4.248	-0.473
10	243	3.692	3.774	0.082
10	244	4.314	4.063	-0.250
30	141	4.556	4.266	-0.291
30	144	4.431	4.047	-0.384
30	145	4.181	3.677	-0.503
30	146	4.311	4.269	-0.041
30	147	5.030	4.715	-0.315
30	132	4.103	4.204	0.101
30	133	4.759	4.600	-0.159
30	135	4.944	3.632	-1.312
30	245	4.225	4.038	-0.187
30	246	4.695	4.616	-0.079
50	67	5.064	4.904	-0.160
50	68	4.081	4.192	0.111
50	69	4.983	4.390	-0.593
50	71	3.712	3.116	-0.595
50	72	4.843	4.420	-0.423
50	172	4.405	4.170	-0.235
50	173	4.288	4.310	0.022
50	174	4.651	4.369	-0.283
50	183	4.800	4.838	0.038
50	186	3.827	3.775	-0.052
100	95	5.020	4.574	-0.446
100	102	4.505	4.524	0.020
100	104	5.043	4.609	-0.434
100	105	4.436	3.968	-0.467
100	106	4.394	4.465	0.071
100	178	4.694	4.778	0.083
100	179	4.413	4.473	0.060
100	180	4.597	4.764	0.167
100	181	4.662	4.533	-0.128
100	182	3.811	3.893	0.082
Max		5.115	5.089	0.283
Average		4.535	4.300	-0.235
Min		3.692	3.116	-1.312
Std Dev		0.384	0.399	0.289

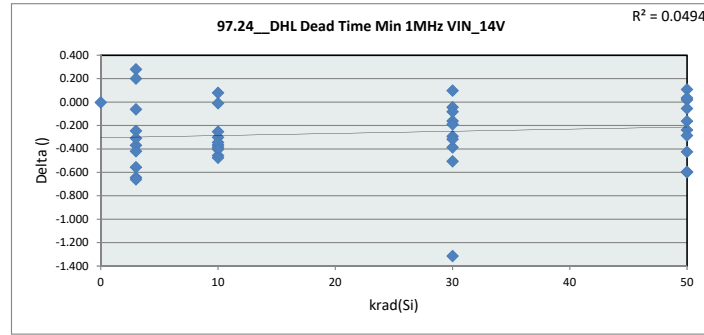

97.24 DHL Dead Time

Test Site	DAL-FL
Tester	ETS364
Test Number	EB672302
Max Limit	10
Min Limit	0

krad(Si)	0	3	10	30	50	100
LL	0.000	0.000	0.000	0.000	0.000	0.000
Min	4.228	3.557	3.481	3.632	3.117	3.893
Average	4.228	4.303	4.293	4.206	4.248	4.458
Max	4.228	4.667	5.089	4.715	4.904	4.778
UL	10.000	10.000	10.000	10.000	10.000	10.000

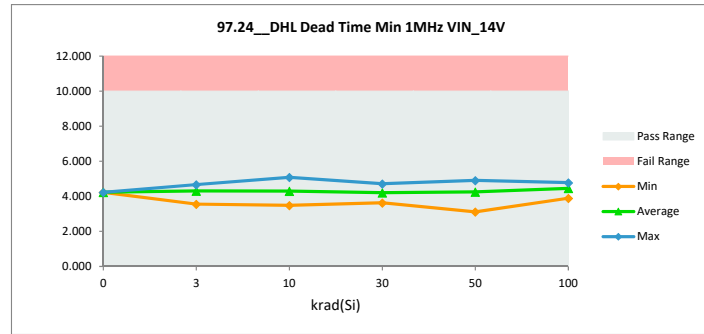

TID HDR Report
TPS7H6003-SP (5962R2220101VXC)

97.25 DHL Dead Time Small 1MHz		
Test Site	DAL-FL	DAL-FL
Tester	ETS364	ETS364
Test Number	EB672302	EB672302
Unit	nsec	
Max Limit	15	15
Min Limit	6	6

krad(Si)	Serial #	pre_short (rtp)	(2)ST_Combo (rpt)	Delta
0	Ctrl	9.657	9.657	0.000
3	58	10.406	9.717	-0.689
3	59	10.447	9.862	-0.584
3	60	10.136	9.699	-0.437
3	61	9.889	9.384	-0.505
3	62	9.945	9.441	-0.504
3	134	10.178	9.736	-0.442
3	137	9.872	9.773	-0.099
3	138	9.872	9.677	-0.195
3	139	10.102	9.782	-0.319
3	236	9.710	9.987	0.277
10	63	10.807	10.326	-0.481
10	64	10.242	9.864	-0.378
10	65	10.040	9.696	-0.344
10	66	9.591	9.213	-0.378
10	150	10.389	10.320	-0.069
10	237	10.466	10.072	-0.395
10	241	10.157	9.741	-0.416
10	242	10.157	9.934	-0.223
10	243	9.546	9.257	-0.288
10	244	9.947	9.618	-0.329
30	141	9.743	9.372	-0.371
30	144	10.083	9.582	-0.501
30	145	9.968	9.375	-0.592
30	146	9.932	9.720	-0.212
30	147	10.378	9.942	-0.436
30	132	9.897	9.718	-0.179
30	133	10.408	10.133	-0.275
30	135	10.400	9.118	-1.283
30	245	9.745	9.414	-0.331
30	246	10.047	9.812	-0.235
50	67	10.653	10.168	-0.485
50	68	9.739	9.333	-0.406
50	69	10.453	9.719	-0.734
50	71	9.409	8.353	-1.056
50	72	10.193	9.524	-0.669
50	172	9.831	9.283	-0.548
50	173	9.976	9.843	-0.133
50	174	10.131	9.463	-0.669
50	183	10.354	10.196	-0.159
50	186	9.574	9.368	-0.207
100	95	10.328	9.385	-0.943
100	102	10.090	9.513	-0.577
100	104	10.589	9.706	-0.883
100	105	10.228	9.107	-1.121
100	106	10.083	9.538	-0.545
100	178	10.254	9.803	-0.451
100	179	9.973	9.538	-0.435
100	180	10.341	9.868	-0.473
100	181	10.147	9.571	-0.575
100	182	9.458	9.093	-0.365
Max		10.807	10.326	0.277
Average		10.078	9.634	-0.444
Min		9.409	8.353	-1.283
Std Dev		0.315	0.352	0.281

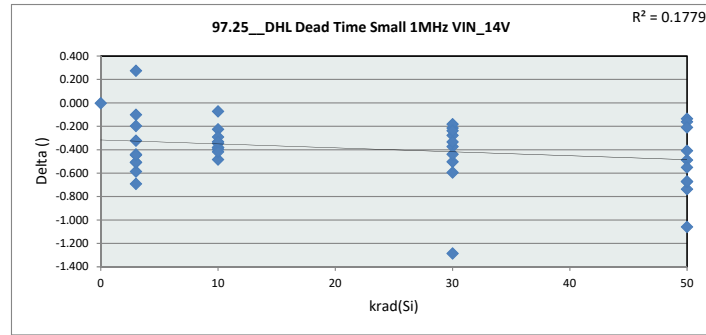

97.25 DHL Dead Time Small 1MHz VIN_14V

97.25 DHL Dead Time Small 1MHz VIN_14V	
Test Site	DAL-FL
Tester	ETS364
Test Number	EB672302
Max Limit	15
Min Limit	6

krad(Si)	0	3	10	30	50	100
LL	6.000	6.000	6.000	6.000	6.000	6.000
Min	9.657	9.384	9.213	9.118	8.353	9.093
Average	9.657	9.706	9.804	9.619	9.525	9.512
Max	9.657	9.987	10.327	10.133	10.196	9.868
UL	15.000	15.000	15.000	15.000	15.000	15.000

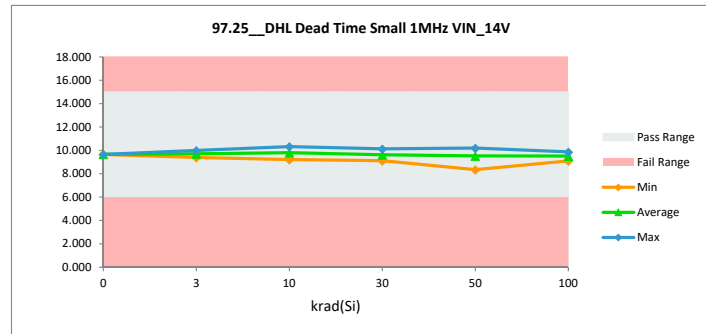

TID HDR Report
TPS7H6003-SP (5962R2220101VXC)

97.26 DHL Dead Time Mid 1MHz		
Test Site	DAL-FL	DAL-FL
Tester	ETS364	ETS364
Test Number	EB672302	EB672302
Unit	nsec	
Max Limit	24.5	24.5
Min Limit	16	16

krad(Si)	Serial #	pre_short (rtp) (2)	ST_Combo (rpt) (Delta
0	Ctrl	20.004	20.004	0.000
3	58	20.463	19.764	-0.699
3	59	20.135	19.553	-0.583
3	60	19.910	19.448	-0.462
3	61	20.146	19.660	-0.486
3	62	20.538	19.877	-0.661
3	134	20.335	19.669	-0.666
3	137	19.608	19.527	-0.081
3	138	20.079	19.623	-0.456
3	139	20.004	19.413	-0.591
3	236	19.528	19.968	0.440
10	63	20.999	20.537	-0.462
10	64	20.451	20.010	-0.441
10	65	19.884	19.573	-0.311
10	66	19.864	19.213	-0.650
10	150	20.161	20.161	0.000
10	237	20.530	19.966	-0.564
10	241	19.993	19.539	-0.454
10	242	20.455	19.964	-0.491
10	243	19.946	19.690	-0.257
10	244	19.936	19.636	-0.299
30	141	19.533	18.919	-0.614
30	144	20.263	19.660	-0.603
30	145	20.416	19.426	-0.989
30	146	19.983	19.532	-0.451
30	147	20.218	19.643	-0.575
30	132	20.225	19.868	-0.357
30	133	20.590	20.062	-0.528
30	135	20.434	19.301	-1.134
30	245	19.822	19.116	-0.706
30	246	19.819	19.485	-0.334
50	67	20.737	19.885	-0.851
50	68	19.915	19.449	-0.466
50	69	20.518	19.498	-1.020
50	71	19.750	18.673	-1.078
50	72	19.975	18.850	-1.125
50	172	19.803	18.900	-0.903
50	173	20.146	19.662	-0.485
50	174	20.278	19.281	-0.996
50	183	20.292	19.756	-0.537
50	186	20.034	19.263	-0.771
100	95	20.201	18.435	-1.766
100	102	20.229	18.982	-1.247
100	104	20.557	18.966	-1.591
100	105	20.610	18.785	-1.824
100	106	20.242	19.098	-1.144
100	178	20.290	19.246	-1.044
100	179	20.102	19.131	-0.971
100	180	20.485	19.304	-1.181
100	181	20.224	18.862	-1.362
100	182	19.678	18.649	-1.028
	Max	20.999	20.537	0.440
	Average	20.163	19.460	-0.703
	Min	19.528	18.435	-1.824
	Std Dev	0.317	0.438	0.439

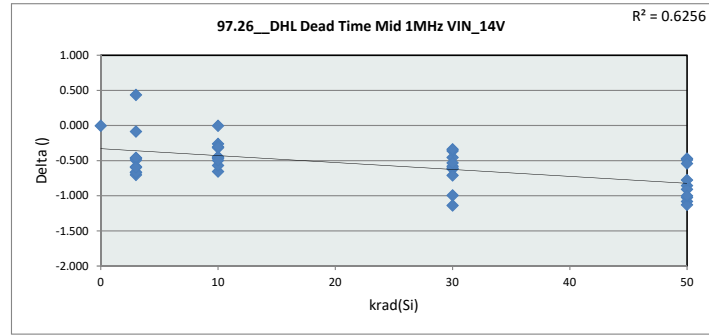

97.26 DHL Dead Time Mid 1MHz VIN_14V						
Test Site	DAL-FL					
Tester	ETS364					
Test Number	EB672302					
Max Limit	24.5					
Min Limit	16					
krad(Si)	0	3	10	30	50	100
LL	16.000	16.000	16.000	16.000	16.000	16.000
Min	20.004	19.413	19.213	18.919	18.673	18.435
Average	20.004	19.650	19.829	19.501	19.322	18.946
Max	20.004	19.968	20.537	20.062	19.886	19.304
UL	24.500	24.500	24.500	24.500	24.500	24.500

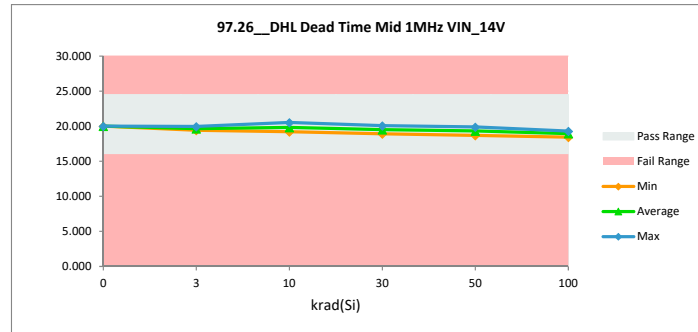

TID HDR Report
TPS7H6003-SP (5962R2220101VXC)

97.27 DHL Dead Time Large 1MHz		
Test Site	DAL-FL	DAL-FL
Tester	ETS364	ETS364
Test Number	EB672302	EB672302
Unit	nsec	
Max Limit	61	61
Min Limit	44	44

krad(Si)	Serial #	pre_short (rtp) (2)	ST_Combo (rpt) (Delta
0	Ctrl	51.534	51.534	0.000
3	58	51.188	50.455	-0.733
3	59	49.669	49.039	-0.631
3	60	49.745	49.203	-0.542
3	61	51.849	51.126	-0.723
3	62	52.911	52.031	-0.880
3	134	51.319	49.771	-1.549
3	137	49.674	49.652	-0.021
3	138	51.298	49.762	-1.536
3	139	49.988	49.575	-0.413
3	236	49.291	50.401	1.110
10	63	52.483	51.707	-0.776
10	64	52.064	51.195	-0.869
10	65	50.111	49.502	-0.610
10	66	51.397	50.557	-0.840
10	150	49.926	49.718	-0.208
10	237	51.305	50.100	-1.204
10	241	50.011	49.525	-0.486
10	242	51.573	50.779	-0.794
10	243	51.891	51.489	-0.402
10	244	50.599	50.011	-0.588
30	141	49.507	48.148	-1.359
30	144	51.573	50.082	-1.492
30	145	52.715	50.874	-1.841
30	146	51.081	49.787	-1.294
30	147	50.361	48.937	-1.425
30	132	52.170	51.232	-0.938
30	133	51.946	50.613	-1.333
30	135	51.143	50.293	-0.849
30	245	50.582	49.275	-1.306
30	246	49.645	48.593	-1.052
50	67	51.761	49.559	-2.202
50	68	51.166	49.819	-1.348
50	69	51.291	48.882	-2.409
50	71	51.721	48.982	-2.739
50	72	49.955	47.322	-2.633
50	172	50.127	48.011	-2.116
50	173	51.522	49.509	-2.014
50	174	51.357	49.029	-2.328
50	183	51.027	48.878	-2.149
50	186	52.130	49.784	-2.346
100	95	50.180	45.610	-4.569
100	102	51.259	47.430	-3.828
100	104	51.188	47.286	-3.902
100	105	52.740	48.479	-4.260
100	106	51.568	48.001	-3.567
100	178	51.004	47.628	-3.376
100	179	51.104	47.884	-3.220
100	180	51.587	47.960	-3.627
100	181	51.168	47.166	-4.003
100	182	50.826	47.474	-3.353
	Max	52.911	52.031	1.110
	Average	51.083	49.405	-1.678
	Min	49.291	45.610	-4.569
	Std Dev	0.904	1.373	1.285

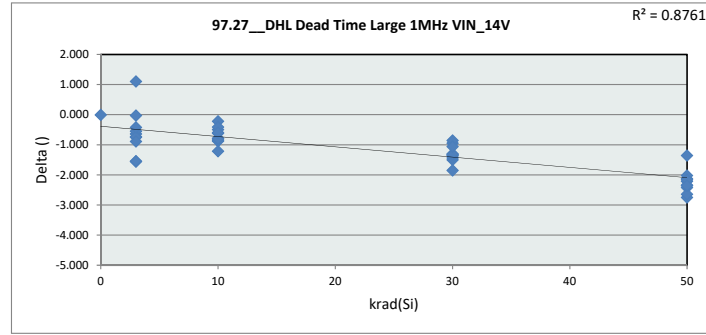

97.27 DHL Dead Time Large 1MHz VIN_14V						
Test Site	DAL-FL					
Tester	ETS364					
Test Number	EB672302					
Max Limit	61					
Min Limit	44					
krad(Si)	0	3	10	30	50	100
LL	44.000	44.000	44.000	44.000	44.000	44.000
Min	51.534	49.039	49.502	48.148	47.322	45.610
Average	51.534	50.102	50.458	49.783	48.977	47.492
Max	51.534	52.031	51.707	51.232	49.819	48.479
UL	61.000	61.000	61.000	61.000	61.000	61.000

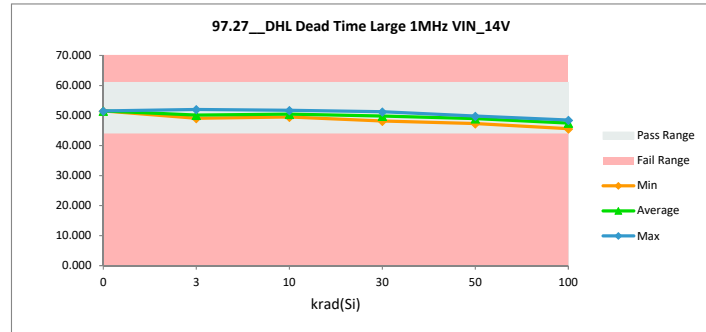

TID HDR Report
TPS7H6003-SP (5962R2220101VXC)

97.28 DHL Dead Time Max 1MHz		
Test Site	DAL-FL	DAL-FL
Tester	ETS364	ETS364
Test Number	EB672302	EB672302
Unit	nsec	
Max Limit	125	
Min Limit	86	

krad(Si)	Serial #	pre_short (rtp) (2)	ST_Combo (rpt) (Delta
0	Ctrl	101.248	101.248	0.000
3	58	99.908	99.259	-0.649
3	59	96.545	96.070	-0.475
3	60	97.389	96.768	-0.620
3	61	102.174	101.381	-0.792
3	62	104.520	103.492	-1.027
3	134	100.850	97.917	-2.933
3	137	97.719	97.737	0.018
3	138	101.541	97.972	-3.569
3	139	98.582	97.868	-0.714
3	236	96.864	98.815	1.951
10	63	102.573	101.363	-1.210
10	64	102.744	101.668	-1.076
10	65	98.417	97.192	-1.225
10	66	101.469	100.080	-1.389
10	150	96.978	96.316	-0.661
10	237	100.504	98.731	-1.773
10	241	98.126	97.975	-0.152
10	242	100.965	99.728	-1.237
10	243	102.918	101.981	-0.937
10	244	99.943	98.787	-1.156
30	141	97.517	94.823	-2.695
30	144	101.688	98.831	-2.857
30	145	103.928	100.913	-3.015
30	146	100.852	98.381	-2.471
30	147	98.667	96.158	-2.509
30	132	103.030	101.044	-1.986
30	133	102.398	100.190	-2.208
30	135	99.920	99.918	-0.002
30	245	99.514	96.950	-2.564
30	246	97.309	95.434	-1.875
50	67	101.294	97.017	-4.277
50	68	100.943	99.074	-1.869
50	69	100.177	95.361	-4.817
50	71	102.315	97.487	-4.829
50	72	97.894	92.660	-5.235
50	172	98.373	93.801	-4.572
50	173	101.416	97.467	-3.949
50	174	101.052	96.092	-4.959
50	183	100.237	95.292	-4.945
50	186	103.521	98.755	-4.766
100	95	98.247	89.108	-9.139
100	102	100.908	92.549	-8.358
100	104	100.072	92.256	-7.816
100	105	104.445	96.265	-8.180
100	106	101.970	94.033	-7.937
100	178	100.058	92.631	-7.428
100	179	100.651	93.587	-7.064
100	180	101.541	93.607	-7.934
100	181	100.469	91.887	-8.582
100	182	100.565	93.141	-7.424
Max		104.520	103.492	1.951
Average		100.450	97.197	-3.253
Min		96.545	89.108	-9.139
Std Dev		2.036	3.112	2.840

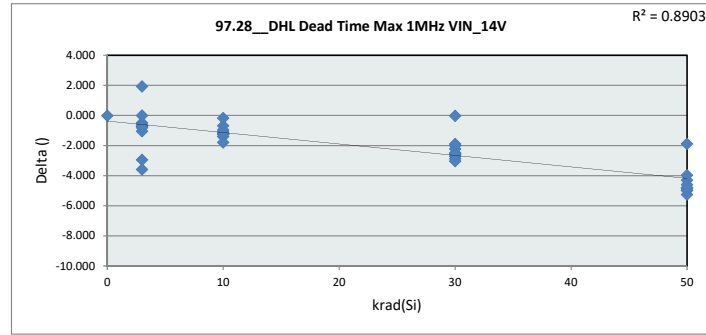

97.28 DHL Dead Time						
Test Site	DAL-FL					
Tester	ETS364					
Test Number	EB672302					
Max Limit	125					
Min Limit	86					
krad(Si)	0	3	10	30	50	100
LL	86.000	86.000	86.000	86.000	86.000	86.000
Min	101.248	96.070	96.316	94.823	92.660	89.108
Average	101.248	98.728	99.382	98.264	96.300	92.906
Max	101.248	103.492	101.982	101.044	99.074	96.265
UL	125.000	125.000	125.000	125.000	125.000	125.000

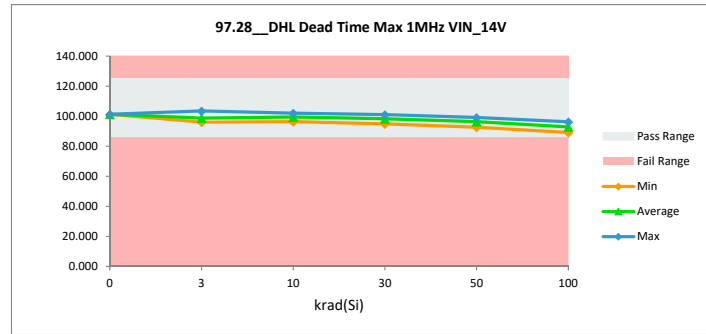

TID HDR Report
TPS7H6003-SP (5962R2220101VXC)

97.29 DHL Dead Time Min 2MHz		
Test Site	DAL-FL	DAL-FL
Tester	ETS364	ETS364
Test Number	EB672302	EB672302
Unit	nsec	
Max Limit	10	10
Min Limit	0	0

krad(Si)	Serial #	pre_short (rtp)	(2)ST_Combo (rpt)	Delta
0	Ctrl	4.306	4.306	0.000
3	58	4.843	4.328	-0.514
3	59	5.175	4.698	-0.477
3	60	5.129	4.705	-0.424
3	61	4.363	3.835	-0.528
3	62	4.268	3.657	-0.612
3	134	4.848	4.608	-0.240
3	137	4.575	4.655	0.080
3	138	4.383	4.551	0.168
3	139	4.885	4.772	-0.113
3	236	4.497	4.654	0.157
10	63	5.295	4.745	-0.550
10	64	4.599	4.269	-0.330
10	65	4.747	4.539	-0.208
10	66	4.047	3.766	-0.281
10	150	5.161	5.223	0.062
10	237	5.009	4.632	-0.377
10	241	5.009	4.649	-0.360
10	242	4.878	4.378	-0.500
10	243	4.001	3.897	-0.104
10	244	4.547	4.285	-0.262
30	141	4.666	4.434	-0.232
30	144	4.597	4.575	-0.022
30	145	4.289	3.912	-0.378
30	146	4.573	4.383	-0.190
30	147	5.032	4.996	-0.037
30	132	4.307	4.232	-0.076
30	133	4.932	4.873	-0.059
30	135	5.051	3.680	-1.371
30	245	4.394	4.242	-0.151
30	246	4.879	4.828	-0.051
50	67	5.288	4.855	-0.433
50	68	4.146	4.205	0.058
50	69	5.052	4.733	-0.319
50	71	3.761	3.519	-0.243
50	72	5.088	4.879	-0.209
50	172	4.517	4.353	-0.165
50	173	4.586	4.560	-0.026
50	174	4.776	4.423	-0.353
50	183	4.910	5.136	0.226
50	186	3.946	4.009	0.063
100	95	5.084	4.739	-0.345
100	102	4.557	4.701	0.144
100	104	5.184	4.907	-0.278
100	105	4.502	4.114	-0.388
100	106	4.469	4.596	0.127
100	178	4.861	4.817	-0.043
100	179	4.477	4.677	0.200
100	180	4.703	4.984	0.282
100	181	4.731	4.650	-0.081
100	182	3.922	4.047	0.125
Max		5.295	5.223	0.282
Average		4.664	4.475	-0.189
Min		3.761	3.519	-1.371
Std Dev		0.379	0.395	0.285

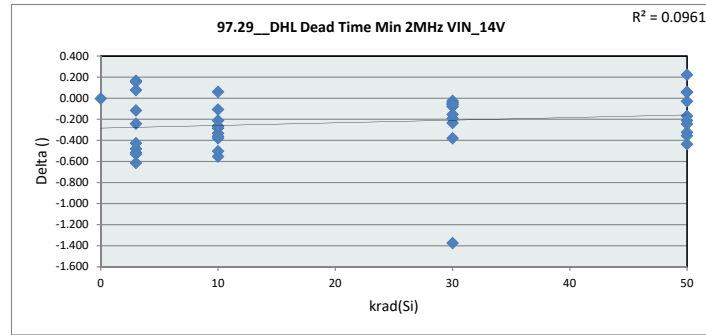

97.29 DHL Dead Time	
Test Site	DAL-FL
Tester	ETS364
Test Number	EB672302
Max Limit	10
Min Limit	0

krad(Si)	0	3	10	30	50	100
LL	0.000	0.000	0.000	0.000	0.000	0.000
Min	4.306	3.657	3.766	3.680	3.519	4.047
Average	4.306	4.446	4.438	4.415	4.467	4.623
Max	4.306	4.772	5.223	4.996	5.136	4.984
UL	10.000	10.000	10.000	10.000	10.000	10.000

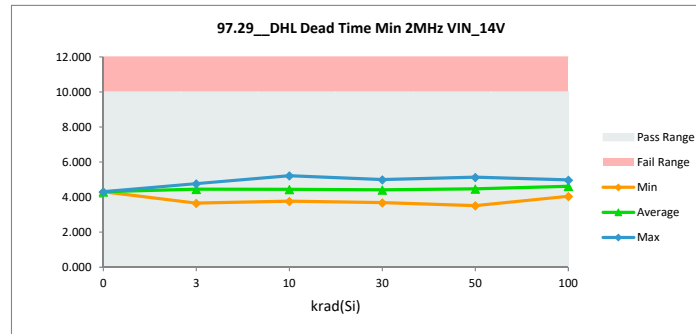

TID HDR Report
TPS7H6003-SP (5962R2220101VXC)

97.30 DHL Dead Time Small 2MHz		
Test Site	DAL-FL	DAL-FL
Tester	ETS364	ETS364
Test Number	EB672302	EB672302
Unit	nsec	
Max Limit	15	15
Min Limit	6	6

krad(Si)	Serial #	pre_short (rtp) (2)	ST_Combo (rpt) (Delta
0	Ctrl	10.011	10.011	0.000
3	58	10.411	9.935	-0.476
3	59	10.412	10.054	-0.358
3	60	10.336	10.004	-0.332
3	61	10.058	9.426	-0.632
3	62	9.986	9.507	-0.479
3	134	10.258	9.886	-0.372
3	137	9.939	9.887	-0.052
3	138	9.858	9.849	-0.009
3	139	10.217	9.939	-0.278
3	236	9.817	10.245	0.427
10	63	10.875	10.449	-0.426
10	64	10.214	9.982	-0.233
10	65	10.015	9.763	-0.252
10	66	9.697	9.241	-0.456
10	150	10.505	10.481	-0.024
10	237	10.577	10.225	-0.352
10	241	10.130	9.882	-0.248
10	242	10.344	9.921	-0.423
10	243	9.587	9.372	-0.215
10	244	10.021	9.765	-0.255
30	141	9.764	9.444	-0.320
30	144	10.000	9.862	-0.137
30	145	10.100	9.379	-0.721
30	146	10.086	9.716	-0.370
30	147	10.443	10.152	-0.290
30	132	9.909	9.761	-0.148
30	133	10.373	10.142	-0.231
30	135	10.471	9.370	-1.100
30	245	9.772	9.544	-0.228
30	246	10.006	9.891	-0.115
50	67	10.791	10.203	-0.588
50	68	9.794	9.681	-0.113
50	69	10.539	9.832	-0.708
50	71	9.422	8.765	-0.658
50	72	10.266	9.603	-0.663
50	172	9.942	9.594	-0.348
50	173	10.044	9.952	-0.092
50	174	10.252	9.541	-0.711
50	183	10.417	10.210	-0.207
50	186	9.701	9.392	-0.310
100	95	10.394	9.520	-0.874
100	102	10.161	9.541	-0.619
100	104	10.620	9.881	-0.739
100	105	10.192	8.869	-1.323
100	106	10.120	9.787	-0.334
100	178	10.252	9.767	-0.485
100	179	9.988	9.750	-0.238
100	180	10.380	10.113	-0.267
100	181	10.302	9.746	-0.556
100	182	9.558	9.149	-0.410
	Max	10.875	10.481	0.427
	Average	10.144	9.764	-0.379
	Min	9.422	8.765	-1.323
	Std Dev	0.312	0.355	0.292

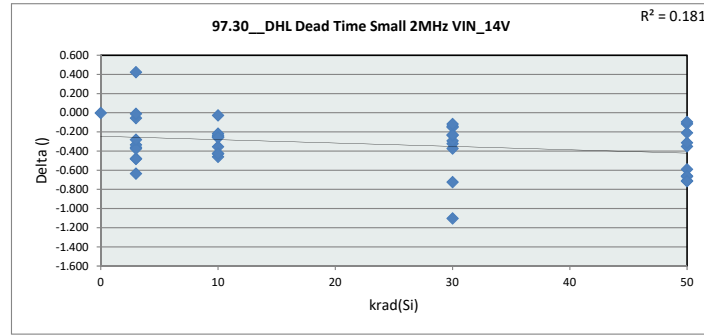

97.30 DHL Dead Time

Test Site	DAL-FL
Tester	ETS364
Test Number	EB672302
Max Limit	15
Min Limit	6

krad(Si)	0	3	10	30	50	100
LL	6.000	6.000	6.000	6.000	6.000	6.000
Min	10.011	9.426	9.241	9.371	8.765	8.869
Average	10.011	9.873	9.908	9.726	9.677	9.612
Max	10.011	10.245	10.481	10.152	10.210	10.113
UL	15.000	15.000	15.000	15.000	15.000	15.000

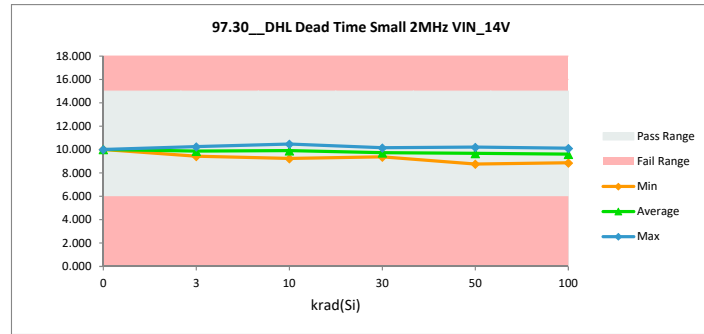

TID HDR Report
TPS7H6003-SP (5962R2220101VXC)

97.31 DHL Dead Time Mid 2MH		
Test Site	DAL-FL	DAL-FL
Tester	ETS364	ETS364
Test Number	EB672302	EB672302
Unit	nsec	
Max Limit	24.5	24.5
Min Limit	16	16

krad(Si)	Serial #	pre_short (rtp)	(2)ST_Combo (rpt)	Delta
0	Ctrl	20.169	20.169	0.000
3	58	20.604	20.000	-0.604
3	59	20.206	19.839	-0.367
3	60	19.981	19.678	-0.302
3	61	20.355	19.667	-0.689
3	62	20.539	19.979	-0.560
3	134	20.414	19.608	-0.807
3	137	19.743	19.777	0.034
3	138	20.157	19.661	-0.496
3	139	19.976	19.727	-0.249
3	236	19.514	20.250	0.736
10	63	21.065	20.742	-0.324
10	64	20.542	20.042	-0.499
10	65	20.054	19.691	-0.363
10	66	20.044	19.578	-0.466
10	150	20.281	20.295	0.014
10	237	20.573	20.229	-0.344
10	241	20.028	19.774	-0.254
10	242	20.518	20.222	-0.296
10	243	19.995	19.892	-0.104
10	244	20.059	19.801	-0.258
30	141	19.609	19.187	-0.422
30	144	20.323	19.799	-0.524
30	145	20.580	19.718	-0.863
30	146	20.133	19.508	-0.625
30	147	20.343	19.731	-0.611
30	132	20.368	19.799	-0.569
30	133	20.664	20.270	-0.394
30	135	20.528	19.465	-1.062
30	245	19.868	19.334	-0.535
30	246	19.872	19.622	-0.250
50	67	20.903	20.008	-0.895
50	68	20.113	19.520	-0.593
50	69	20.647	19.680	-0.967
50	71	19.925	18.708	-1.217
50	72	20.087	18.917	-1.170
50	172	19.924	19.035	-0.889
50	173	20.196	19.794	-0.401
50	174	20.407	19.254	-1.153
50	183	20.392	19.841	-0.551
50	186	20.157	19.272	-0.885
100	95	20.332	18.546	-1.787
100	102	20.385	19.126	-1.259
100	104	20.581	19.111	-1.471
100	105	20.697	18.837	-1.860
100	106	20.421	19.218	-1.203
100	178	20.306	19.182	-1.123
100	179	20.269	19.299	-0.971
100	180	20.501	19.467	-1.034
100	181	20.323	18.902	-1.420
100	182	19.786	18.797	-0.989
	Max	21.065	20.742	0.736
	Average	20.264	19.599	-0.665
	Min	19.514	18.546	-1.860
	Std Dev	0.316	0.463	0.485

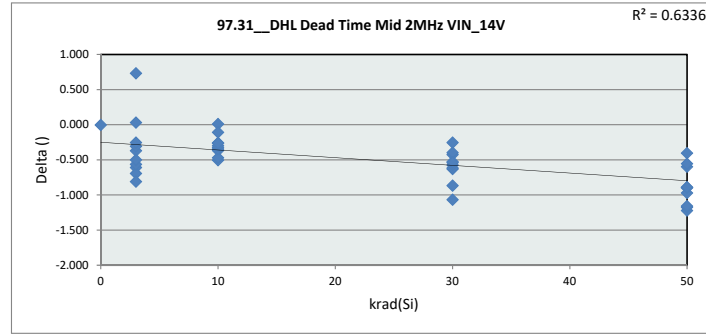

97.31 DHL Dead Time		
Test Site	DAL-FL	
Tester	ETS364	
Test Number	EB672302	
Max Limit	24.5	
Min Limit	16	

krad(Si)	0	3	10	30	50	100
LL	16.000	16.000	16.000	16.000	16.000	16.000
Min	20.169	19.608	19.578	19.187	18.708	18.546
Average	20.169	19.818	20.027	19.643	19.403	19.048
Max	20.169	20.250	20.742	20.270	20.008	19.467
UL	24.500	24.500	24.500	24.500	24.500	24.500

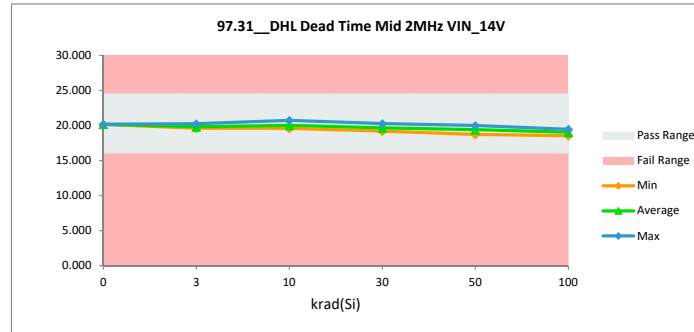

TID HDR Report
TPS7H6003-SP (5962R2220101VXC)

97.32 DHL Dead Time Large 2M		
Test Site	DAL-FL	DAL-FL
Tester	ETS364	ETS364
Test Number	EB672302	EB672302
Unit	nsec	
Max Limit	61	61
Min Limit	44	44

krad(Si)	Serial #	pre_short (rtp)	(2)'ST_Combo (rpt)	Delta
0	Ctrl	51.859	51.859	0.000
3	58	51.865	51.208	-0.656
3	59	50.320	49.786	-0.534
3	60	50.200	49.716	-0.484
3	61	52.411	51.717	-0.695
3	62	53.459	52.811	-0.649
3	134	51.848	50.130	-1.718
3	137	50.293	50.420	0.126
3	138	51.881	50.163	-1.718
3	139	50.498	50.273	-0.225
3	236	49.926	50.843	0.917
10	63	53.040	52.333	-0.707
10	64	52.591	51.840	-0.751
10	65	50.728	50.219	-0.508
10	66	52.158	51.173	-0.985
10	150	50.482	50.246	-0.236
10	237	51.912	50.820	-1.092
10	241	50.673	50.412	-0.261
10	242	52.193	51.481	-0.712
10	243	52.579	52.244	-0.334
10	244	51.238	50.616	-0.622
30	141	50.142	48.718	-1.424
30	144	52.233	50.745	-1.488
30	145	53.318	51.573	-1.745
30	146	51.789	50.383	-1.406
30	147	50.810	49.599	-1.211
30	132	52.857	51.727	-1.130
30	133	52.545	51.542	-1.003
30	135	51.693	50.903	-0.791
30	245	51.131	49.925	-1.206
30	246	50.157	49.220	-0.937
50	67	52.400	50.200	-2.200
50	68	51.901	50.340	-1.561
50	69	51.810	49.530	-2.279
50	71	52.333	49.749	-2.584
50	72	50.549	47.923	-2.626
50	172	50.753	48.397	-2.356
50	173	52.002	50.346	-1.657
50	174	51.905	49.513	-2.391
50	183	51.645	49.297	-2.348
50	186	52.821	50.405	-2.416
100	95	50.701	46.306	-4.395
100	102	51.944	48.109	-3.835
100	104	51.790	47.831	-3.960
100	105	53.467	48.914	-4.554
100	106	52.366	48.547	-3.818
100	178	51.539	48.155	-3.383
100	179	51.832	48.426	-3.406
100	180	52.291	48.515	-3.776
100	181	51.762	47.786	-3.976
100	182	51.561	48.004	-3.556
	Max	53.467	52.811	0.917
	Average	51.690	50.018	-1.672
	Min	49.926	46.306	-4.554
	Std Dev	0.922	1.400	1.333

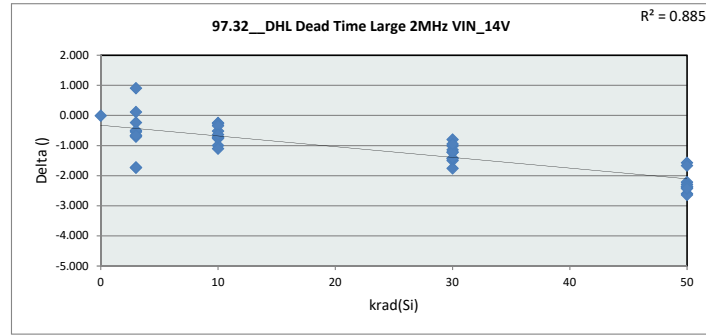

97.32 DHL Dead Time Large 2MHz VIN_14V

97.32 DHL Dead Time Large 2MHz VIN_14V	
Test Site	DAL-FL
Tester	ETS364
Test Number	EB672302
Max Limit	61
Min Limit	44

krad(Si)	0	3	10	30	50	100
LL	44.000	44.000	44.000	44.000	44.000	44.000
Min	51.859	49.716	50.219	48.718	47.923	46.306
Average	51.859	50.707	51.138	50.434	49.570	48.059
Max	51.859	52.811	52.333	51.727	50.405	48.914
UL	61.000	61.000	61.000	61.000	61.000	61.000

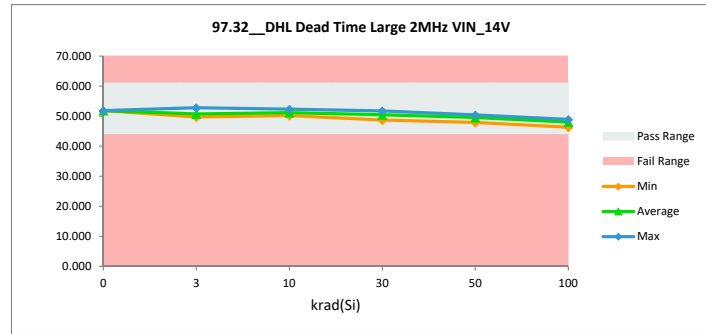

TID HDR Report
TPS7H6003-SP (5962R2220101VXC)

97.33 DHL Dead Time Max 2MHz		
Test Site	DAL-FL	DAL-FL
Tester	ETS364	ETS364
Test Number	EB672302	EB672302
Unit	nsec	
Max Limit	125	125
Min Limit	86	86

krad(Si)	Serial #	pre_short (rtp)	(2)'ST_Combo (rpt)	Delta
0	Ctrl	104.282	104.282	0.000
3	58	103.152	102.294	-0.857
3	59	99.519	99.119	-0.400
3	60	100.210	99.788	-0.422
3	61	105.445	104.766	-0.679
3	62	107.861	107.006	-0.855
3	134	104.029	100.972	-3.056
3	137	100.778	100.957	0.178
3	138	104.824	101.015	-3.809
3	139	101.498	100.876	-0.623
3	236	99.836	101.870	2.034
10	63	105.733	104.629	-1.105
10	64	106.129	104.955	-1.174
10	65	101.399	100.218	-1.180
10	66	104.826	103.404	-1.423
10	150	99.759	99.374	-0.385
10	237	103.638	101.846	-1.792
10	241	101.048	100.906	-0.142
10	242	104.205	103.125	-1.080
10	243	106.377	105.247	-1.130
10	244	102.904	101.944	-0.961
30	141	100.412	97.898	-2.514
30	144	104.966	101.894	-3.073
30	145	107.254	104.078	-3.177
30	146	104.073	101.651	-2.422
30	147	101.661	99.016	-2.645
30	132	106.285	104.510	-1.775
30	133	105.641	103.361	-2.280
30	135	103.094	103.217	0.123
30	245	102.549	100.224	-2.326
30	246	100.363	98.340	-2.022
50	67	104.478	100.165	-4.312
50	68	104.077	102.267	-1.810
50	69	103.179	98.407	-4.772
50	71	105.639	100.519	-5.120
50	72	100.850	95.619	-5.231
50	172	101.369	96.799	-4.570
50	173	104.466	100.557	-3.910
50	174	104.251	99.369	-4.882
50	183	103.325	98.398	-4.927
50	186	107.070	102.161	-4.909
100	95	101.285	92.084	-9.201
100	102	104.102	95.715	-8.387
100	104	103.103	95.331	-7.771
100	105	107.936	99.448	-8.488
100	106	105.172	97.165	-8.007
100	178	103.232	95.808	-7.423
100	179	103.893	96.715	-7.178
100	180	104.817	96.484	-8.333
100	181	103.645	95.003	-8.642
100	182	103.881	96.260	-7.621
Max		107.936	107.006	2.034
Average		103.598	100.334	-3.264
Min		99.519	92.084	-9.201
Std Dev		2.184	3.195	2.911

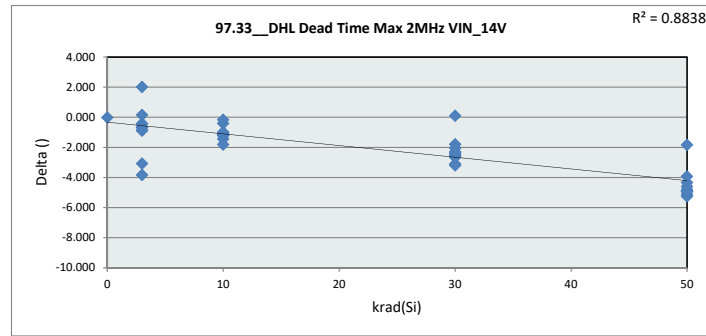

97.33 DHL Dead Time Max 2MHz VIN_14V						
Test Site	DAL-FL					
Tester	ETS364					
Test Number	EB672302					
Max Limit	125					
Min Limit	86					
krad(Si)	0	3	10	30	50	100
LL	86.000	86.000	86.000	86.000	86.000	86.000
Min	104.282	99.119	99.374	97.899	95.619	92.084
Average	104.282	101.866	102.565	101.419	99.426	96.001
Max	104.282	107.006	105.247	104.510	102.267	99.448
UL	125.000	125.000	125.000	125.000	125.000	125.000

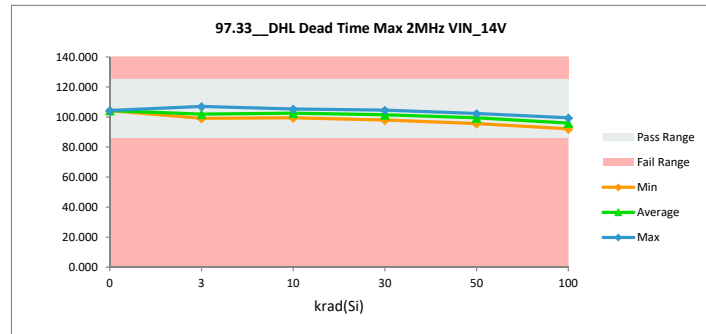

TID HDR Report
TPS7H6003-SP (5962R2220101VXC)

100.1 Bootstrap Diode Switch		
Test Site	DAL-FL	DAL-FL
Tester	ETS364	ETS364
Test Number	EB672302	EB672302
Unit	kOhms	KOHMS
Max Limit	1.2	1.2
Min Limit	0.8	0.8

krad(Si)	Serial #	pre_short (rtp) (2)	ST_Combo (rpt) (Delta
0	Ctrl	0.997	0.997	0.000
3	58	0.987	0.987	0.000
3	59	0.975	0.976	0.000
3	60	0.994	0.994	0.000
3	61	0.990	0.990	0.000
3	62	0.987	0.988	0.001
3	134	0.989	0.973	-0.016
3	137	0.985	0.973	-0.012
3	138	0.975	0.973	-0.002
3	139	0.972	0.972	0.001
3	236	0.997	0.960	-0.038
10	63	0.979	0.980	0.000
10	64	0.975	0.975	0.001
10	65	0.973	0.974	0.001
10	66	1.000	1.000	0.001
10	150	0.975	0.976	0.001
10	237	0.973	0.960	-0.013
10	241	0.965	0.973	0.008
10	242	0.994	0.994	0.001
10	243	0.998	0.999	0.001
10	244	0.966	0.967	0.001
30	141	0.975	0.975	0.001
30	144	0.987	0.988	0.001
30	145	0.973	0.974	0.001
30	146	0.995	0.996	0.001
30	147	0.971	0.972	0.001
30	132	0.979	0.980	0.001
30	133	0.974	0.975	0.001
30	135	0.962	0.984	0.022
30	245	0.974	0.974	0.001
30	246	0.971	0.972	0.001
50	67	0.963	0.964	0.000
50	68	0.997	0.978	-0.018
50	69	0.977	0.978	0.001
50	71	0.991	0.992	0.001
50	72	0.994	0.995	0.001
50	172	0.980	0.981	0.001
50	173	0.966	0.967	0.001
50	174	0.981	0.981	0.001
50	183	0.992	0.993	0.001
50	186	0.980	0.981	0.001
100	95	0.976	0.977	0.001
100	102	0.995	0.996	0.001
100	104	1.002	1.003	0.001
100	105	0.980	0.981	0.001
100	106	0.996	0.997	0.001
100	178	0.961	0.962	0.001
100	179	0.990	0.991	0.001
100	180	0.977	0.978	0.001
100	181	0.994	0.995	0.001
100	182	0.995	0.995	0.001
Max		1.002	1.003	0.022
Average		0.982	0.981	-0.001
Min		0.961	0.960	-0.038
Std Dev		0.011	0.011	0.008

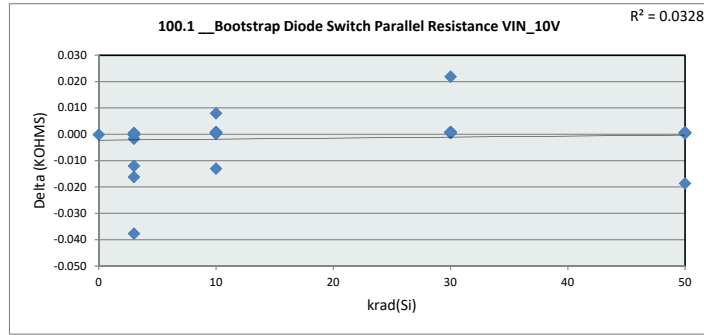

100.1 Bootstrap D		
Test Site	DAL-FL	
Tester	ETS364	
Test Number	EB672302	
Max Limit	1.2 KOHMS	
Min Limit	0.8 KOHMS	

krad(Si)	0	3	10	30	50	100
LL	0.800	0.800	0.800	0.800	0.800	0.800
Min	0.997	0.960	0.960	0.972	0.964	0.962
Average	0.997	0.979	0.980	0.979	0.981	0.988
Max	0.997	0.994	1.000	0.996	0.995	1.003
UL	1.200	1.200	1.200	1.200	1.200	1.200

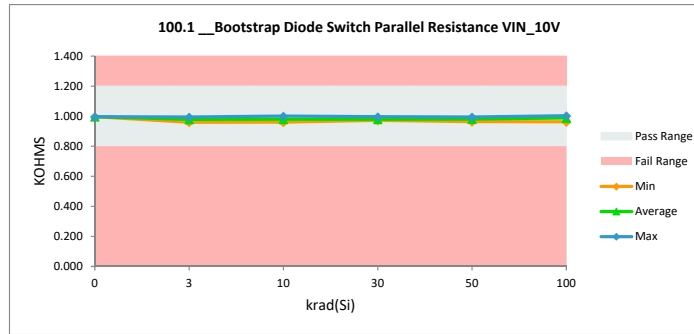

TID HDR Report

TPS7H6003-SP (5962R2220101VXC)

101.1 Bootstrap Diode Switch		
Test Site	DAL-FL	DAL-FL
Tester	ETS364	ETS364
Test Number	EB672302	EB672302
Unit	kOhms	KOHMS
Max Limit	1.2	1.2
Min Limit	0.8	0.8

krad(Si)	Serial #	pre_short (rtp) (2)	ST_Comb (rpt) (Delta
0	Ctrl	0.997	0.997	0.000
3	58	0.987	0.987	0.000
3	59	0.975	0.976	0.000
3	60	0.994	0.994	0.000
3	61	0.990	0.990	0.000
3	62	0.987	0.988	0.000
3	134	0.990	0.974	-0.016
3	137	0.985	0.974	-0.012
3	138	0.975	0.974	-0.002
3	139	0.972	0.972	0.001
3	236	0.998	0.960	-0.038
10	63	0.979	0.980	0.000
10	64	0.975	0.975	0.001
10	65	0.974	0.974	0.000
10	66	1.000	1.000	0.001
10	150	0.975	0.976	0.001
10	237	0.973	0.960	-0.013
10	241	0.965	0.974	0.008
10	242	0.994	0.994	0.001
10	243	0.998	0.999	0.001
10	244	0.966	0.967	0.001
30	141	0.975	0.976	0.001
30	144	0.987	0.988	0.001
30	145	0.973	0.974	0.001
30	146	0.996	0.997	0.001
30	147	0.971	0.973	0.001
30	132	0.979	0.980	0.001
30	133	0.974	0.975	0.001
30	135	0.962	0.984	0.022
30	245	0.974	0.975	0.001
30	246	0.972	0.972	0.001
50	67	0.963	0.964	0.001
50	68	0.997	0.978	-0.018
50	69	0.977	0.978	0.001
50	71	0.991	0.992	0.001
50	72	0.994	0.995	0.001
50	172	0.980	0.981	0.001
50	173	0.966	0.967	0.001
50	174	0.981	0.982	0.001
50	183	0.992	0.993	0.001
50	186	0.981	0.982	0.001
100	95	976.600	0.977	-975.623
100	102	995.400	0.997	-994.403
100	104	1001.900	1.003	-1000.897
100	105	980.300	0.981	-979.319
100	106	996.100	0.997	-995.103
100	178	0.961	0.962	0.001
100	179	0.990	0.991	0.001
100	180	0.977	0.978	0.001
100	181	0.994	0.995	0.001
100	182	0.995	0.996	0.001
Max	1001.900	1.003	0.022	
Average	97.950	0.982	-96.968	
Min	0.961	0.960	-1000.897	
Std Dev	297.063	0.011	297.060	

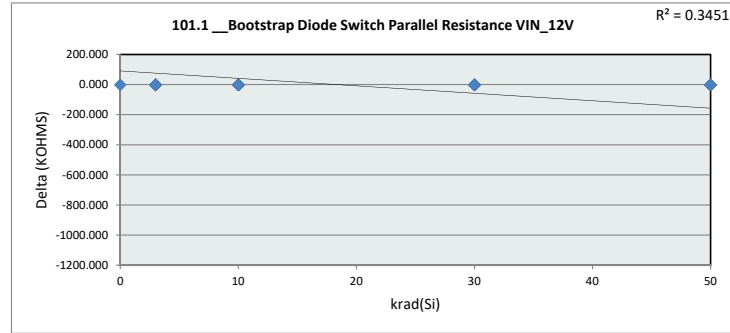

101.1 Bootstrap D		
Test Site	DAL-FL	
Tester	ETS364	
Test Number	EB672302	
Max Limit	1.2	KOHMS
Min Limit	0.8	KOHMS

krad(Si)	0	3	10	30	50	100
LL	0.800	0.800	0.800	0.800	0.800	0.800
Min	0.997	0.960	0.960	0.972	0.964	0.962
Average	0.997	0.979	0.980	0.979	0.981	0.988
Max	0.997	0.995	1.000	0.997	0.995	1.003
UL	1.200	1.200	1.200	1.200	1.200	1.200

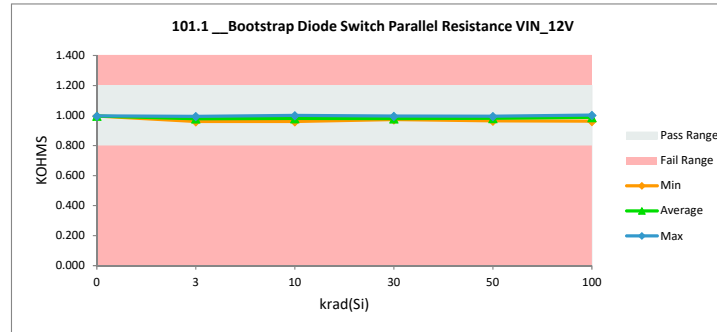

TID HDR Report
TPS7H6003-SP (5962R2220101VXC)

102.1 Bootstrap Diode Switch		
Test Site	DAL-FL	DAL-FL
Tester	ETS364	ETS364
Test Number	EB672302	EB672302
Unit	kOhms	KOHMS
Max Limit	1.2	1.2
Min Limit	0.8	0.8

krad(Si)	Serial #	pre_short (rtp) (2)	ST_Combo (rpt) (Delta
0	Ctrl	0.997	0.997	0.000
3	58	0.987	0.987	0.000
3	59	0.976	0.976	0.000
3	60	0.995	0.995	0.000
3	61	0.990	0.990	0.000
3	62	0.987	0.988	0.000
3	134	0.990	0.974	-0.016
3	137	0.985	0.974	-0.012
3	138	0.975	0.974	-0.002
3	139	0.972	0.973	0.001
3	236	0.998	0.960	-0.038
10	63	0.979	0.980	0.000
10	64	0.975	0.976	0.001
10	65	0.974	0.974	0.001
10	66	1.000	1.000	0.001
10	150	0.975	0.976	0.001
10	237	0.973	0.960	-0.013
10	241	0.966	0.974	0.008
10	242	0.994	0.995	0.001
10	243	0.998	0.999	0.001
10	244	0.966	0.967	0.001
30	141	0.975	0.976	0.001
30	144	0.987	0.988	0.001
30	145	0.974	0.974	0.001
30	146	0.996	0.997	0.001
30	147	0.972	0.973	0.001
30	132	0.980	0.980	0.001
30	133	0.974	0.975	0.001
30	135	0.962	0.984	0.022
30	245	0.974	0.975	0.001
30	246	0.972	0.973	0.001
50	67	0.963	0.964	0.001
50	68	0.997	0.979	-0.018
50	69	0.977	0.978	0.001
50	71	0.991	0.992	0.001
50	72	0.994	0.995	0.001
50	172	0.980	0.981	0.001
50	173	0.966	0.967	0.001
50	174	0.981	0.982	0.001
50	183	0.993	0.993	0.001
50	186	0.981	0.982	0.001
100	95	976.800	0.978	-975.822
100	102	995.500	0.997	-994.503
100	104	1002.100	1.003	-1001.097
100	105	980.500	0.981	-979.519
100	106	996.200	0.997	-995.203
100	178	0.961	0.962	0.001
100	179	0.990	0.992	0.001
100	180	0.977	0.978	0.001
100	181	0.994	0.995	0.001
100	182	0.995	0.996	0.001
Max	1002.100	1.003	0.022	
Average	97.966	0.982	-96.984	
Min	0.961	0.960	-1001.097	
Std Dev	297.111	0.011	297.108	

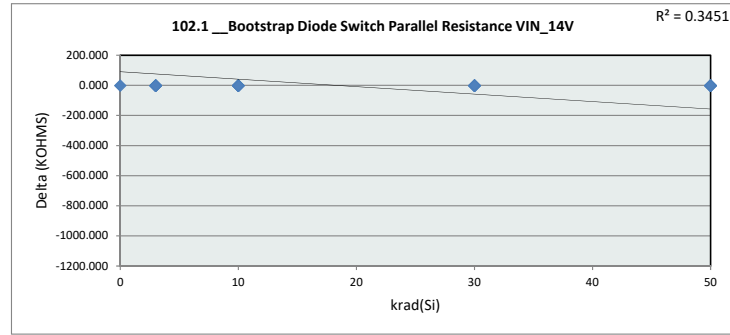

102.1 Bootstrap D		
Test Site	DAL-FL	
Tester	ETS364	
Test Number	EB672302	
Max Limit	1.2	KOHMS
Min Limit	0.8	KOHMS

krad(Si)	0	3	10	30	50	100
LL	0.800	0.800	0.800	0.800	0.800	0.800
Min	0.997	0.960	0.960	0.973	0.964	0.962
Average	0.997	0.979	0.980	0.979	0.981	0.988
Max	0.997	0.995	1.001	0.997	0.995	1.003
UL	1.200	1.200	1.200	1.200	1.200	1.200

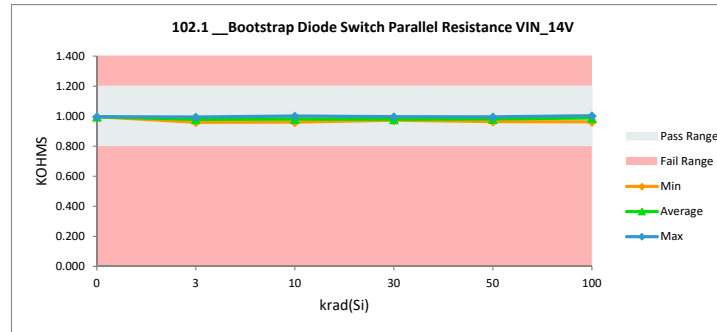

TID HDR Report
TPS7H6003-SP (5962R2220101VXC)

105.0_PGOOD Logic Low Output		
Test Site	DAL-FL	DAL-FL
Tester	ETS364	ETS364
Test Number	EB672302	EB672302
Unit	V	V
Max Limit	0.4	0.4
Min Limit	0	0

krad(Si)	Serial #	pre_short (rtp)	(2)'ST_Combio (rpt)	Delta
0	Ctrl	0.196	0.196	0.000
3	58	0.195	0.194	0.000
3	59	0.202	0.199	-0.002
3	60	0.200	0.200	-0.001
3	61	0.197	0.196	-0.001
3	62	0.197	0.195	-0.003
3	134	0.198	0.202	0.004
3	137	0.200	0.202	0.002
3	138	0.204	0.202	-0.003
3	139	0.204	0.201	-0.004
3	236	0.201	0.198	-0.002
10	63	0.202	0.198	-0.003
10	64	0.201	0.196	-0.005
10	65	0.200	0.196	-0.004
10	66	0.199	0.195	-0.004
10	150	0.203	0.196	-0.006
10	237	0.201	0.198	-0.003
10	241	0.204	0.202	-0.002
10	242	0.202	0.198	-0.005
10	243	0.198	0.193	-0.005
10	244	0.204	0.199	-0.006
30	141	0.201	0.194	-0.007
30	144	0.199	0.192	-0.007
30	145	0.205	0.199	-0.007
30	146	0.201	0.195	-0.007
30	147	0.203	0.196	-0.007
30	132	0.200	0.194	-0.006
30	133	0.206	0.199	-0.006
30	135	0.201	0.192	-0.009
30	245	0.203	0.197	-0.006
30	246	0.202	0.195	-0.006
50	67	0.201	0.195	-0.006
50	68	0.197	0.196	-0.001
50	69	0.199	0.193	-0.006
50	71	0.196	0.191	-0.005
50	72	0.201	0.195	-0.006
50	172	0.204	0.196	-0.008
50	173	0.200	0.195	-0.005
50	174	0.197	0.191	-0.006
50	183	0.199	0.193	-0.006
50	186	0.199	0.193	-0.007
100	95	0.204	0.196	-0.008
100	102	0.198	0.189	-0.009
100	104	0.201	0.192	-0.008
100	105	0.200	0.191	-0.009
100	106	0.196	0.190	-0.006
100	178	0.201	0.194	-0.007
100	179	0.197	0.191	-0.007
100	180	0.201	0.196	-0.005
100	181	0.199	0.192	-0.007
100	182	0.199	0.192	-0.007
Max		0.206	0.202	0.004
Average		0.200	0.196	-0.005
Min		0.195	0.189	-0.009
Std Dev		0.003	0.003	0.003

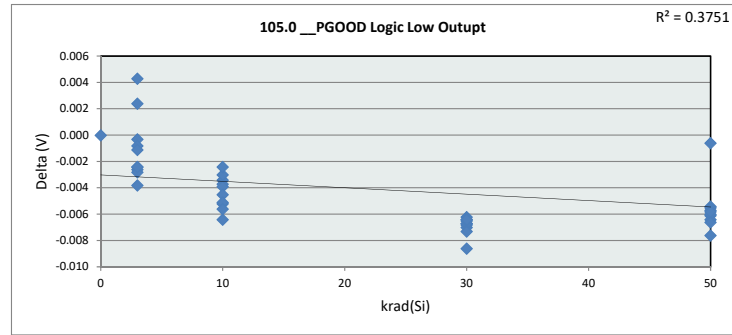

105.0_PGOOD Log		
Test Site	DAL-FL	
Tester	ETS364	
Test Number	EB672302	
Max Limit	0.4	V
Min Limit	0	V

krad(Si)	0	3	10	30	50	100
LL	0.000	0.000	0.000	0.000	0.000	0.000
Min	0.196	0.195	0.193	0.192	0.191	0.189
Average	0.196	0.199	0.197	0.195	0.194	0.192
Max	0.196	0.202	0.202	0.199	0.196	0.196
UL	0.400	0.400	0.400	0.400	0.400	0.400

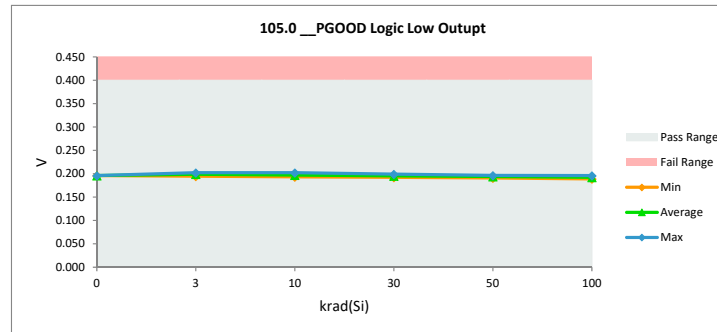

TID HDR Report
TPS7H6003-SP (5962R2220101VXC)

105.1 Min BP5L for Valid PGOOD		
Test Site	DAL-FL	DAL-FL
Tester	ETS364	ETS364
Test Number	EB672302	EB672302
Unit	V	V
Max Limit	2.45	2.45
Min Limit	0.1	0.1

krad(Si)	Serial #	pre_short (rtp)	(2)ST_Combo (rpt)	Delta
0	Ctrl	2.043	2.043	0.000
3	58	2.027	2.023	-0.004
3	59	2.062	2.058	-0.004
3	60	2.038	2.028	-0.009
3	61	1.993	1.989	-0.004
3	62	2.070	2.066	-0.004
3	134	1.976	2.056	0.080
3	137	2.066	2.056	-0.011
3	138	2.113	2.056	-0.057
3	139	1.976	1.974	-0.003
3	236	2.055	2.022	-0.033
10	63	2.111	2.094	-0.017
10	64	2.177	2.160	-0.017
10	65	2.136	2.119	-0.017
10	66	2.014	1.996	-0.018
10	150	2.027	2.016	-0.012
10	237	2.016	2.022	0.006
10	241	2.044	2.056	0.012
10	242	2.041	2.024	-0.017
10	243	2.060	2.047	-0.013
10	244	1.995	1.978	-0.017
30	141	2.064	2.013	-0.051
30	144	2.094	2.035	-0.059
30	145	2.054	2.001	-0.054
30	146	2.007	1.954	-0.054
30	147	2.005	1.957	-0.049
30	132	2.099	2.045	-0.054
30	133	2.086	2.032	-0.054
30	135	2.019	1.978	-0.041
30	245	2.121	2.071	-0.050
30	246	1.949	1.901	-0.048
50	67	2.097	2.005	-0.091
50	68	2.042	2.104	0.062
50	69	2.069	1.978	-0.091
50	71	1.931	1.835	-0.095
50	72	2.075	1.988	-0.086
50	172	2.139	2.057	-0.082
50	173	2.030	1.952	-0.078
50	174	1.975	1.888	-0.088
50	183	1.979	1.892	-0.087
50	186	2.059	1.972	-0.087
100	95	2.164	1.980	-0.184
100	102	1.979	1.807	-0.172
100	104	2.003	1.835	-0.169
100	105	2.093	1.919	-0.174
100	106	2.020	1.848	-0.172
100	178	2.069	1.902	-0.166
100	179	2.031	1.870	-0.160
100	180	2.145	1.973	-0.171
100	181	1.994	1.818	-0.176
100	182	2.041	1.876	-0.165
	Max	2.177	2.160	0.080
	Average	2.048	1.988	-0.061
	Min	1.931	1.807	-0.184
	Std Dev	0.055	0.082	0.066

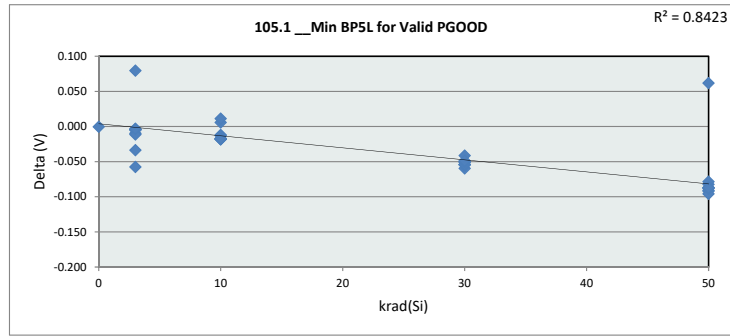

105.1 Min BP5L for Valid PGOOD		
Test Site	DAL-FL	
Tester	ETS364	
Test Number	EB672302	
Max Limit	2.45	V
Min Limit	0.1	V

krad(Si)	0	3	10	30	50	100
LL	0.100	0.100	0.100	0.100	0.100	0.100
Min	2.043	1.974	1.978	1.901	1.835	1.807
Average	2.043	2.033	2.051	1.999	1.967	1.883
Max	2.043	2.066	2.160	2.071	2.104	1.981
UL	2.450	2.450	2.450	2.450	2.450	2.450

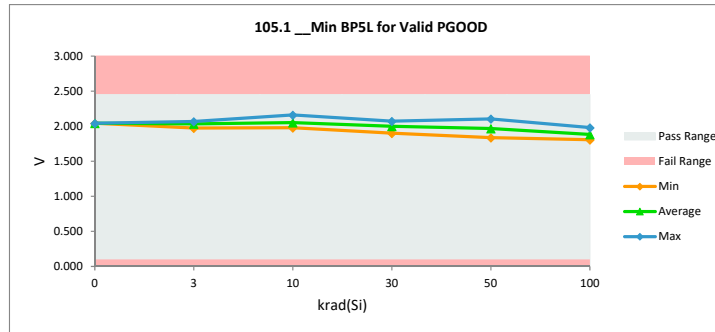

TID HDR Report
TPS7H6003-SP (5962R2220101VXC)

105.2_PGOOD Internal Resistance		
Test Site	DAL-FL	DAL-FL
Tester	ETS364	ETS364
Test Number	EB672302	EB672302
Unit	MOhms	MOHMS
Max Limit	1.9	1.9
Min Limit	0.7	0.7

krad(Si)	Serial #	pre_short (rtp)	(2)'ST_Combo (rpt)	Delta
0	Ctrl	1.078	1.078	0.000
3	58	1.058	1.047	-0.011
3	59	1.039	1.036	-0.003
3	60	1.085	1.075	-0.009
3	61	1.056	1.049	-0.007
3	62	1.056	1.059	0.004
3	134	1.047	1.024	-0.022
3	137	1.040	1.022	-0.018
3	138	1.023	1.028	0.005
3	139	1.027	1.030	0.003
3	236	1.085	1.038	-0.048
10	63	1.040	1.035	-0.006
10	64	1.032	1.048	0.017
10	65	1.042	1.046	0.003
10	66	1.083	1.089	0.005
10	150	1.021	1.033	0.011
10	237	1.037	1.036	-0.001
10	241	1.048	1.027	-0.020
10	242	1.072	1.076	0.003
10	243	1.084	1.085	0.001
10	244	1.048	1.051	0.003
30	141	1.030	1.036	0.006
30	144	1.037	1.046	0.008
30	145	1.026	1.034	0.008
30	146	1.072	1.080	0.008
30	147	1.068	1.073	0.005
30	132	1.036	1.039	0.003
30	133	1.035	1.039	0.003
30	135	1.046	1.047	0.001
30	245	1.040	1.050	0.010
30	246	1.046	1.048	0.002
50	67	1.041	1.047	0.005
50	68	1.082	1.033	-0.049
50	69	1.033	1.038	0.005
50	71	1.054	1.058	0.003
50	72	1.067	1.076	0.009
50	172	1.026	1.033	0.006
50	173	1.052	1.058	0.006
50	174	1.033	1.036	0.004
50	183	1.048	1.052	0.003
50	186	1.040	1.041	0.001
100	95	1.025	1.034	0.009
100	102	1.079	1.096	0.017
100	104	1.085	1.099	0.014
100	105	1.041	1.047	0.006
100	106	1.065	1.076	0.011
100	178	1.045	1.044	-0.001
100	179	1.049	1.053	0.004
100	180	1.037	1.040	0.003
100	181	1.058	1.061	0.003
100	182	1.074	1.077	0.002
	Max	1.085	1.099	0.017
	Average	1.050	1.051	0.001
	Min	1.021	1.022	-0.049
	Std Dev	0.019	0.020	0.013

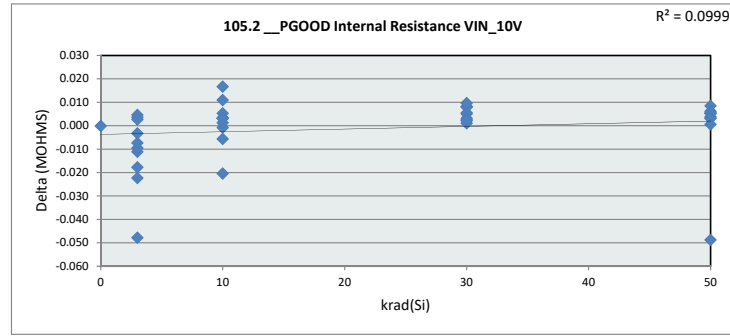

105.2_PGOOD Internal Resistance

Test Site	DAL-FL
Tester	ETS364
Test Number	EB672302
Max Limit	1.9 MOHMS
Min Limit	0.7 MOHMS

krad(Si)	0	3	10	30	50	100
LL	0.700	0.700	0.700	0.700	0.700	0.700
Min	1.078	1.022	1.027	1.034	1.033	1.034
Average	1.078	1.041	1.053	1.049	1.047	1.063
Max	1.078	1.075	1.089	1.080	1.076	1.099
UL	1.900	1.900	1.900	1.900	1.900	1.900

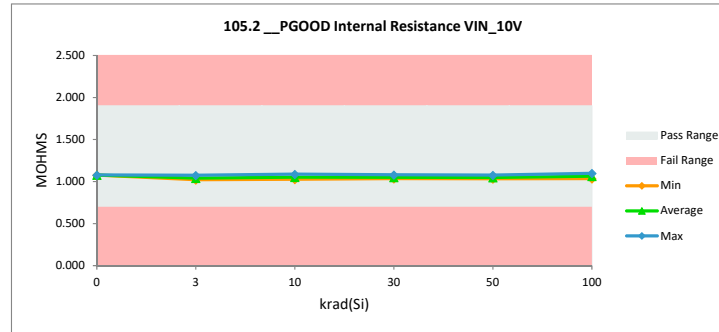

TID HDR Report
TPS7H6003-SP (5962R2220101VXC)

106.0_PGOOD Logic Low Output		
Test Site	DAL-FL	DAL-FL
Tester	ETS364	ETS364
Test Number	EB672302	EB672302
Unit	V	V
Max Limit	0.4	0.4
Min Limit	0	0

krad(Si)	Serial #	pre_short (rtp)	(2)'ST_Combo (rpt)	Delta
0	Ctrl	0.196	0.196	0.000
3	58	0.195	0.194	-0.001
3	59	0.201	0.199	-0.003
3	60	0.200	0.199	-0.001
3	61	0.197	0.196	-0.001
3	62	0.197	0.194	-0.003
3	134	0.198	0.202	0.004
3	137	0.200	0.202	0.002
3	138	0.204	0.201	-0.003
3	139	0.204	0.200	-0.004
3	236	0.201	0.198	-0.002
10	63	0.202	0.198	-0.004
10	64	0.201	0.195	-0.006
10	65	0.199	0.196	-0.004
10	66	0.199	0.195	-0.004
10	150	0.202	0.196	-0.007
10	237	0.201	0.198	-0.003
10	241	0.204	0.202	-0.003
10	242	0.202	0.198	-0.005
10	243	0.198	0.193	-0.005
10	244	0.204	0.199	-0.006
30	141	0.201	0.194	-0.007
30	144	0.199	0.192	-0.007
30	145	0.205	0.198	-0.007
30	146	0.201	0.194	-0.007
30	147	0.203	0.196	-0.007
30	132	0.200	0.194	-0.006
30	133	0.206	0.199	-0.007
30	135	0.201	0.192	-0.009
30	245	0.203	0.196	-0.007
30	246	0.202	0.195	-0.007
50	67	0.201	0.195	-0.006
50	68	0.197	0.196	-0.001
50	69	0.199	0.193	-0.007
50	71	0.196	0.190	-0.006
50	72	0.200	0.194	-0.006
50	172	0.204	0.196	-0.008
50	173	0.200	0.195	-0.006
50	174	0.197	0.191	-0.006
50	183	0.199	0.193	-0.006
50	186	0.199	0.193	-0.007
100	95	0.204	0.196	-0.008
100	102	0.198	0.189	-0.009
100	104	0.201	0.192	-0.008
100	105	0.200	0.191	-0.009
100	106	0.196	0.189	-0.006
100	178	0.201	0.194	-0.007
100	179	0.197	0.191	-0.007
100	180	0.201	0.195	-0.005
100	181	0.199	0.192	-0.007
100	182	0.199	0.192	-0.007
	Max	0.206	0.202	0.004
	Average	0.200	0.195	-0.005
	Min	0.195	0.189	-0.009
	Std Dev	0.003	0.003	0.003

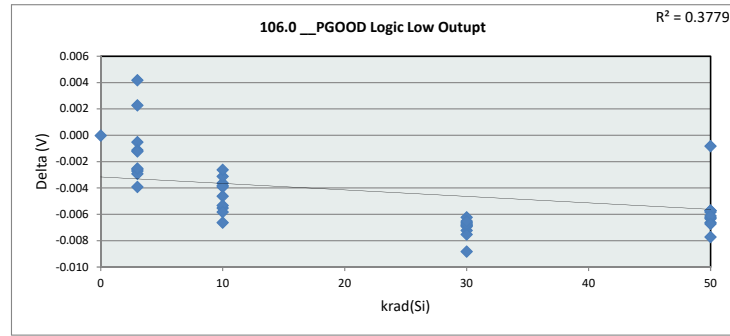

106.0_PGOOD Log		
Test Site	DAL-FL	
Tester	ETS364	
Test Number	EB672302	
Max Limit	0.4	V
Min Limit	0	V

krad(Si)	0	3	10	30	50	100
LL	0.000	0.000	0.000	0.000	0.000	0.000
Min	0.196	0.194	0.193	0.192	0.190	0.189
Average	0.196	0.199	0.197	0.195	0.194	0.192
Max	0.196	0.202	0.202	0.199	0.196	0.196
UL	0.400	0.400	0.400	0.400	0.400	0.400

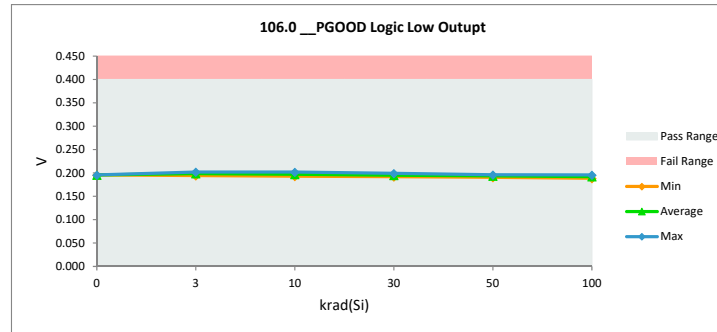

TID HDR Report
TPS7H6003-SP (5962R2220101VXC)

106.1 Min BP5L for Valid PGOOD		
Test Site	DAL-FL	DAL-FL
Tester	ETS364	ETS364
Test Number	EB672302	EB672302
Unit	V	V
Max Limit	2.4	2.4
Min Limit	0.1	0.1

krad(Si)	Serial #	pre_short (rtp)	(2)ST_Combo (rpt)	Delta
0	Ctrl	2.043	2.043	0.000
3	58	2.027	2.023	-0.004
3	59	2.062	2.058	-0.004
3	60	2.038	2.029	-0.009
3	61	1.993	1.989	-0.004
3	62	2.070	2.066	-0.003
3	134	1.976	2.056	0.080
3	137	2.067	2.056	-0.011
3	138	2.109	2.056	-0.053
3	139	1.977	1.974	-0.003
3	236	2.055	2.022	-0.033
10	63	2.111	2.089	-0.022
10	64	2.177	2.156	-0.021
10	65	2.136	2.118	-0.017
10	66	2.014	1.996	-0.018
10	150	2.027	2.016	-0.012
10	237	2.016	2.022	0.006
10	241	2.044	2.056	0.012
10	242	2.041	2.024	-0.017
10	243	2.060	2.047	-0.013
10	244	1.995	1.979	-0.017
30	141	2.064	2.014	-0.050
30	144	2.094	2.035	-0.059
30	145	2.054	2.001	-0.053
30	146	2.002	1.954	-0.049
30	147	2.005	1.957	-0.049
30	132	2.094	2.045	-0.049
30	133	2.086	2.032	-0.054
30	135	2.020	1.978	-0.041
30	245	2.120	2.071	-0.049
30	246	1.949	1.900	-0.049
50	67	2.097	2.006	-0.091
50	68	2.037	2.104	0.067
50	69	2.069	1.978	-0.091
50	71	1.931	1.835	-0.096
50	72	2.074	1.988	-0.086
50	172	2.139	2.057	-0.082
50	173	2.030	1.952	-0.078
50	174	1.975	1.888	-0.087
50	183	1.979	1.892	-0.087
50	186	2.059	1.972	-0.087
100	95	2.164	1.981	-0.184
100	102	1.974	1.807	-0.168
100	104	2.003	1.835	-0.169
100	105	2.093	1.919	-0.175
100	106	2.020	1.848	-0.172
100	178	2.069	1.902	-0.167
100	179	2.031	1.865	-0.165
100	180	2.145	1.974	-0.171
100	181	1.993	1.818	-0.175
100	182	2.041	1.875	-0.166
	Max	2.177	2.156	0.080
	Average	2.048	1.987	-0.061
	Min	1.931	1.807	-0.184
	Std Dev	0.055	0.081	0.066

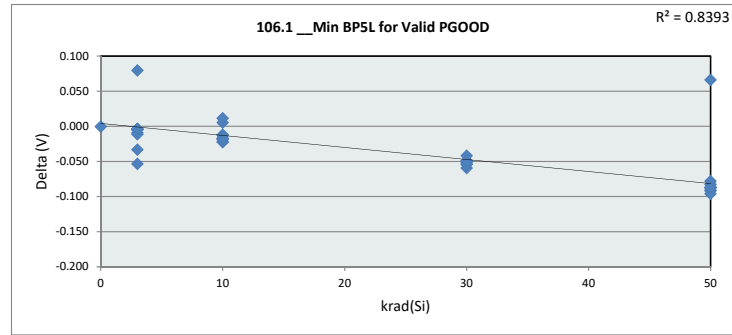

106.1 Min BP5L for Valid PGOOD						
Test Site	DAL-FL					
Tester	ETS364					
Test Number	EB672302					
Max Limit	2.4		V			
Min Limit	0.1		V			
krad(Si)	0	3	10	30	50	100
LL	0.100	0.100	0.100	0.100	0.100	0.100
Min	2.043	1.974	1.979	1.900	1.835	1.807
Average	2.043	2.033	2.050	1.999	1.967	1.882
Max	2.043	2.066	2.156	2.071	2.104	1.981
UL	2.400	2.400	2.400	2.400	2.400	2.400

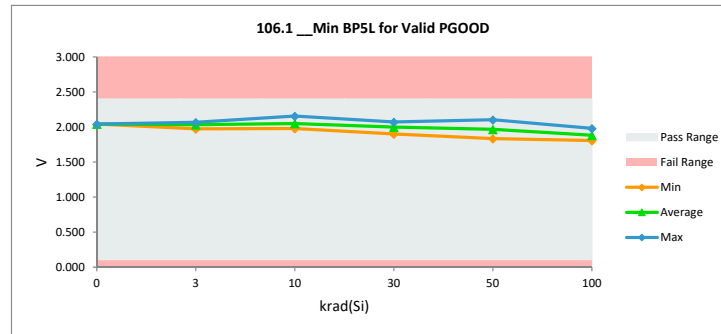

TID HDR Report
TPS7H6003-SP (5962R2220101VXC)

106.2_PGOOD Internal Resistance		
Test Site	DAL-FL	DAL-FL
Tester	ETS364	ETS364
Test Number	EB672302	EB672302
Unit	MOhms	MOHMS
Max Limit	1.9	1.9
Min Limit	0.7	0.7

krad(Si)	Serial #	pre_short (rtp)	(2)'ST_Combo (rpt)	Delta
0	Ctrl	1.076	1.076	0.000
3	58	1.057	1.047	-0.010
3	59	1.042	1.043	0.002
3	60	1.084	1.076	-0.008
3	61	1.055	1.054	-0.001
3	62	1.054	1.058	0.004
3	134	1.044	1.027	-0.018
3	137	1.039	1.026	-0.014
3	138	1.027	1.027	0.000
3	139	1.030	1.033	0.004
3	236	1.084	1.038	-0.046
10	63	1.035	1.038	0.003
10	64	1.038	1.047	0.009
10	65	1.048	1.050	0.002
10	66	1.084	1.092	0.007
10	150	1.023	1.035	0.012
10	237	1.039	1.039	0.001
10	241	1.047	1.025	-0.022
10	242	1.077	1.082	0.005
10	243	1.078	1.088	0.010
10	244	1.046	1.055	0.008
30	141	1.033	1.037	0.004
30	144	1.040	1.049	0.009
30	145	1.027	1.034	0.007
30	146	1.069	1.081	0.012
30	147	1.065	1.075	0.010
30	132	1.037	1.041	0.004
30	133	1.033	1.043	0.011
30	135	1.047	1.046	-0.001
30	245	1.037	1.050	0.013
30	246	1.044	1.053	0.009
50	67	1.043	1.045	0.001
50	68	1.082	1.039	-0.043
50	69	1.036	1.042	0.006
50	71	1.058	1.062	0.004
50	72	1.074	1.077	0.004
50	172	1.029	1.029	0.001
50	173	1.058	1.060	0.002
50	174	1.032	1.036	0.004
50	183	1.043	1.051	0.007
50	186	1.037	1.043	0.007
100	95	1.032	1.036	0.004
100	102	1.081	1.095	0.014
100	104	1.089	1.099	0.011
100	105	1.047	1.054	0.007
100	106	1.075	1.079	0.004
100	178	1.045	1.049	0.004
100	179	1.048	1.056	0.008
100	180	1.036	1.041	0.005
100	181	1.058	1.061	0.003
100	182	1.073	1.076	0.003
Max		1.089	1.099	0.014
Average		1.051	1.053	0.002
Min		1.023	1.025	-0.046
Std Dev		0.019	0.019	0.012

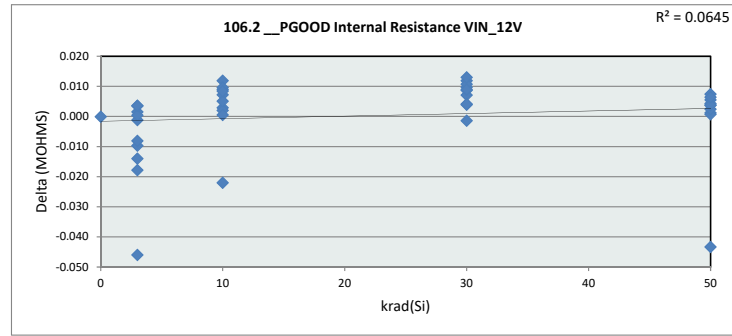

106.2_PGOOD Internal Resistance		
Test Site	DAL-FL	DAL-FL
Tester	ETS364	ETS364
Test Number	EB672302	EB672302
Max Limit	1.9	MOHMS
Min Limit	0.7	MOHMS

krad(Si)	0	3	10	30	50	100
LL	0.700	0.700	0.700	0.700	0.700	0.700
Min	1.076	1.026	1.025	1.034	1.029	1.036
Average	1.076	1.043	1.055	1.051	1.049	1.065
Max	1.076	1.076	1.092	1.081	1.078	1.099
UL	1.900	1.900	1.900	1.900	1.900	1.900

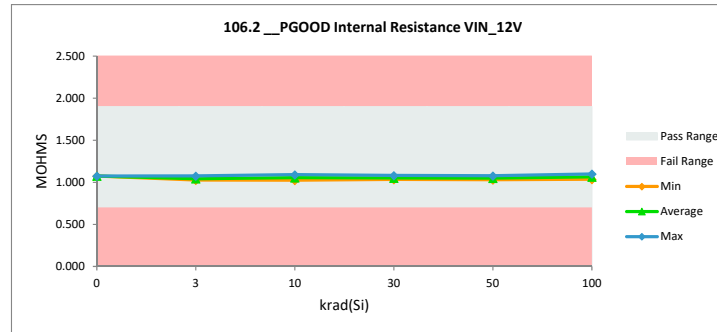

TID HDR Report
TPS7H6003-SP (5962R2220101VXC)

107.0_PGOOD Logic Low Output		
Test Site	DAL-FL	DAL-FL
Tester	ETS364	ETS364
Test Number	EB672302	EB672302
Unit	V	V
Max Limit	0.4	0.4
Min Limit	0	0

krad(Si)	Serial #	pre_short (rtp)	(2)'ST_Comb (rpt)	Delta
0	Ctrl	0.196	0.196	0.000
3	58	0.195	0.194	0.000
3	59	0.201	0.199	-0.003
3	60	0.200	0.199	-0.001
3	61	0.197	0.196	-0.001
3	62	0.197	0.194	-0.003
3	134	0.198	0.202	0.004
3	137	0.200	0.202	0.002
3	138	0.204	0.201	-0.003
3	139	0.204	0.200	-0.004
3	236	0.201	0.198	-0.003
10	63	0.201	0.198	-0.004
10	64	0.201	0.195	-0.005
10	65	0.199	0.196	-0.004
10	66	0.199	0.195	-0.004
10	150	0.202	0.196	-0.007
10	237	0.201	0.198	-0.003
10	241	0.204	0.202	-0.002
10	242	0.202	0.198	-0.005
10	243	0.198	0.193	-0.005
10	244	0.204	0.199	-0.006
30	141	0.201	0.194	-0.007
30	144	0.199	0.192	-0.007
30	145	0.205	0.198	-0.007
30	146	0.201	0.194	-0.007
30	147	0.203	0.196	-0.007
30	132	0.200	0.194	-0.006
30	133	0.206	0.199	-0.007
30	135	0.201	0.192	-0.009
30	245	0.203	0.196	-0.007
30	246	0.201	0.195	-0.006
50	67	0.201	0.195	-0.006
50	68	0.197	0.196	-0.001
50	69	0.199	0.193	-0.006
50	71	0.196	0.190	-0.006
50	72	0.200	0.194	-0.006
50	172	0.204	0.196	-0.008
50	173	0.200	0.194	-0.006
50	174	0.197	0.191	-0.006
50	183	0.199	0.193	-0.006
50	186	0.199	0.193	-0.007
100	95	0.204	0.196	-0.008
100	102	0.198	0.189	-0.009
100	104	0.201	0.192	-0.008
100	105	0.199	0.191	-0.009
100	106	0.196	0.189	-0.006
100	178	0.201	0.194	-0.007
100	179	0.197	0.191	-0.007
100	180	0.201	0.195	-0.005
100	181	0.199	0.192	-0.007
100	182	0.199	0.192	-0.007
Max		0.206	0.202	0.004
Average		0.200	0.195	-0.005
Min		0.195	0.189	-0.009
Std Dev		0.003	0.003	0.003

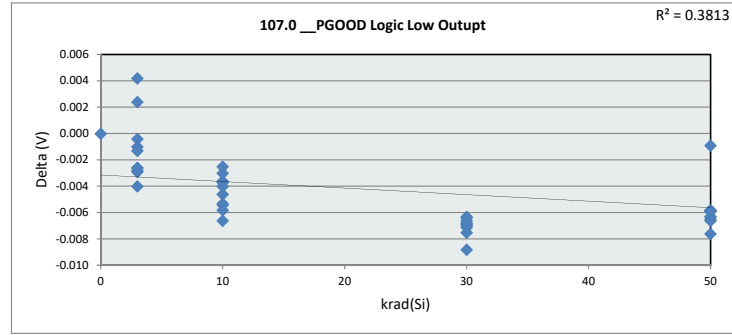

107.0_PGOOD Log		
Test Site	DAL-FL	
Tester	ETS364	
Test Number	EB672302	
Max Limit	0.4	V
Min Limit	0	V

krad(Si)	0	3	10	30	50	100
LL	0.000	0.000	0.000	0.000	0.000	0.000
Min	0.196	0.194	0.193	0.192	0.190	0.189
Average	0.196	0.199	0.197	0.195	0.193	0.192
Max	0.196	0.202	0.202	0.199	0.196	0.196
UL	0.400	0.400	0.400	0.400	0.400	0.400

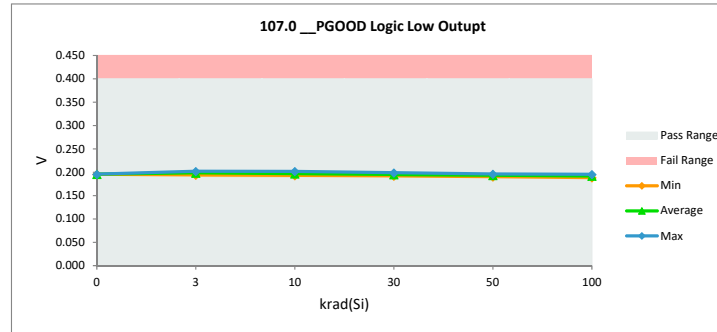

TID HDR Report
TPS7H6003-SP (5962R2220101VXC)

107.1 Min BP5L for Valid PGOOD		
Test Site	DAL-FL	DAL-FL
Tester	ETS364	ETS364
Test Number	EB672302	EB672302
Unit	V	V
Max Limit	2.4	2.4
Min Limit	0.1	0.1

krad(Si)	Serial #	pre_short (rtp)	(2)ST_Combo (rpt)	Delta
0	Ctrl	2.043	2.043	0.000
3	58	2.027	2.023	-0.005
3	59	2.062	2.053	-0.009
3	60	2.038	2.028	-0.009
3	61	1.993	1.989	-0.004
3	62	2.070	2.066	-0.004
3	134	1.976	2.056	0.080
3	137	2.066	2.056	-0.010
3	138	2.114	2.056	-0.057
3	139	1.977	1.974	-0.003
3	236	2.055	2.022	-0.033
10	63	2.111	2.089	-0.022
10	64	2.177	2.160	-0.017
10	65	2.136	2.118	-0.018
10	66	2.014	1.996	-0.018
10	150	2.027	2.015	-0.011
10	237	2.016	2.022	0.006
10	241	2.044	2.056	0.012
10	242	2.041	2.024	-0.017
10	243	2.060	2.047	-0.012
10	244	1.995	1.979	-0.016
30	141	2.064	2.014	-0.051
30	144	2.094	2.035	-0.059
30	145	2.054	2.001	-0.053
30	146	2.002	1.954	-0.049
30	147	2.005	1.957	-0.049
30	132	2.094	2.045	-0.050
30	133	2.086	2.032	-0.054
30	135	2.020	1.978	-0.041
30	245	2.121	2.071	-0.050
30	246	1.950	1.900	-0.049
50	67	2.097	2.006	-0.091
50	68	2.038	2.105	0.067
50	69	2.069	1.979	-0.090
50	71	1.931	1.835	-0.096
50	72	2.075	1.988	-0.087
50	172	2.139	2.057	-0.082
50	173	2.030	1.952	-0.079
50	174	1.975	1.888	-0.087
50	183	1.979	1.892	-0.087
50	186	2.059	1.972	-0.087
100	95	2.164	1.980	-0.184
100	102	1.974	1.807	-0.168
100	104	2.004	1.835	-0.169
100	105	2.094	1.919	-0.175
100	106	2.020	1.847	-0.173
100	178	2.069	1.903	-0.166
100	179	2.031	1.870	-0.161
100	180	2.145	1.974	-0.171
100	181	1.993	1.818	-0.175
100	182	2.041	1.875	-0.165
	Max	2.177	2.160	0.080
	Average	2.048	1.987	-0.061
	Min	1.931	1.807	-0.184
	Std Dev	0.055	0.081	0.066

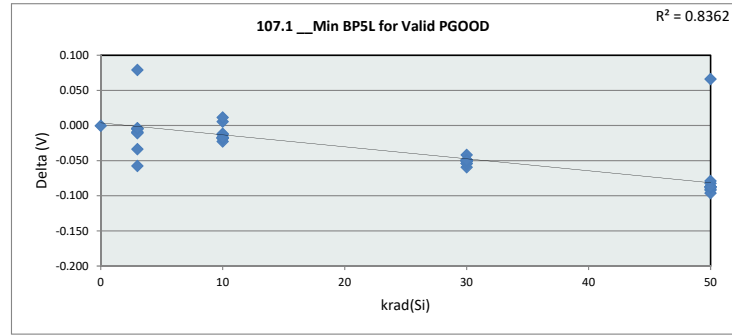

107.1 Min BP5L for Valid PGOOD		
Test Site	DAL-FL	
Tester	ETS364	
Test Number	EB672302	
Max Limit	2.4	V
Min Limit	0.1	V

krad(Si)	0	3	10	30	50	100
LL	0.100	0.100	0.100	0.100	0.100	0.100
Min	2.043	1.974	1.979	1.900	1.835	1.807
Average	2.043	2.032	2.051	1.999	1.967	1.883
Max	2.043	2.066	2.160	2.071	2.105	1.981
UL	2.400	2.400	2.400	2.400	2.400	2.400

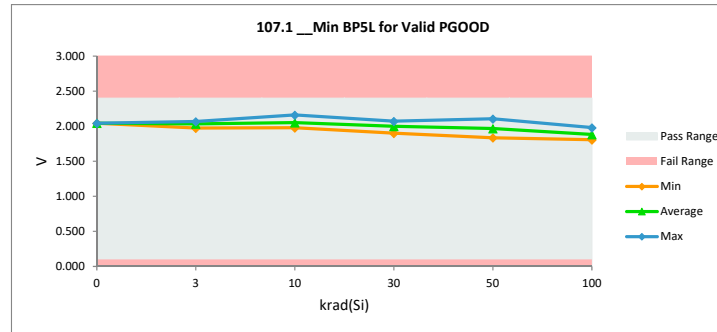

TID HDR Report
TPS7H6003-SP (5962R2220101VXC)

107.2_PGOOD Internal Resistance		
Test Site	DAL-FL	DAL-FL
Tester	ETS364	ETS364
Test Number	EB672302	EB672302
Unit	MOhms	MOHMS
Max Limit	1.9	1.9
Min Limit	0.7	0.7

krad(Si)	Serial #	pre_short (rtp)	(2)'ST_Combo (rpt)	Delta
0	Ctrl	1.077	1.077	0.000
3	58	1.056	1.047	-0.009
3	59	1.037	1.038	0.001
3	60	1.085	1.078	-0.007
3	61	1.058	1.048	-0.010
3	62	1.056	1.060	0.004
3	134	1.049	1.027	-0.022
3	137	1.039	1.023	-0.016
3	138	1.027	1.028	0.001
3	139	1.026	1.031	0.005
3	236	1.088	1.038	-0.049
10	63	1.036	1.039	0.003
10	64	1.038	1.050	0.012
10	65	1.049	1.049	0.000
10	66	1.088	1.091	0.003
10	150	1.021	1.035	0.014
10	237	1.036	1.038	0.003
10	241	1.049	1.029	-0.020
10	242	1.073	1.078	0.004
10	243	1.082	1.087	0.005
10	244	1.047	1.053	0.006
30	141	1.032	1.038	0.006
30	144	1.037	1.047	0.011
30	145	1.024	1.036	0.012
30	146	1.074	1.085	0.011
30	147	1.066	1.075	0.009
30	132	1.035	1.041	0.005
30	133	1.035	1.040	0.005
30	135	1.045	1.049	0.004
30	245	1.043	1.051	0.009
30	246	1.045	1.051	0.005
50	67	1.046	1.047	0.002
50	68	1.085	1.034	-0.051
50	69	1.034	1.041	0.006
50	71	1.061	1.060	-0.001
50	72	1.075	1.079	0.004
50	172	1.029	1.033	0.004
50	173	1.053	1.062	0.009
50	174	1.032	1.038	0.006
50	183	1.047	1.051	0.005
50	186	1.038	1.047	0.008
100	95	1.028	1.038	0.010
100	102	1.087	1.098	0.010
100	104	1.089	1.098	0.009
100	105	1.047	1.051	0.003
100	106	1.072	1.079	0.007
100	178	1.046	1.045	-0.001
100	179	1.049	1.056	0.006
100	180	1.039	1.044	0.005
100	181	1.056	1.062	0.006
100	182	1.073	1.078	0.005
Max		1.089	1.098	0.014
Average		1.052	1.053	0.001
Min		1.021	1.023	-0.051
Std Dev		0.020	0.020	0.013

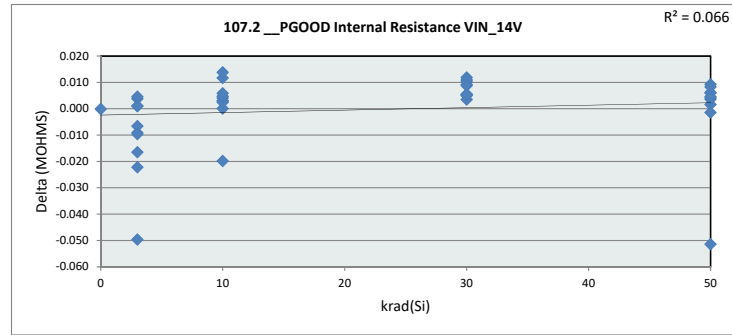

107.2_PGOOD Internal Resistance		
Test Site	DAL-FL	
Tester	ETS364	
Test Number	EB672302	
Max Limit	1.9	MOHMS
Min Limit	0.7	MOHMS

krad(Si)	0	3	10	30	50	100
LL	0.700	0.700	0.700	0.700	0.700	0.700
Min	1.077	1.023	1.029	1.036	1.033	1.038
Average	1.077	1.042	1.055	1.051	1.049	1.065
Max	1.077	1.078	1.091	1.085	1.079	1.098
UL	1.900	1.900	1.900	1.900	1.900	1.900

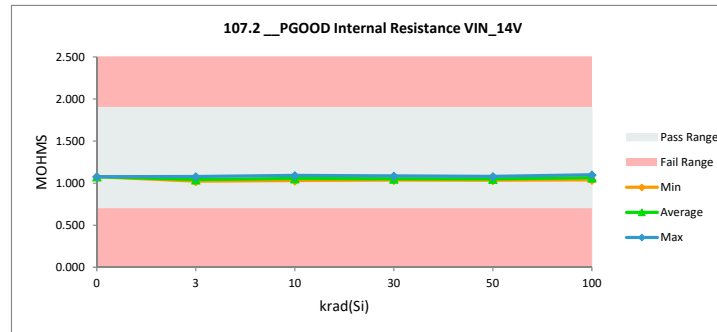

TID HDR Report

TPS7H6003-SP (5962R2220101VXC)

110.0 Prop Delay LO Off PWM		
Test Site	DAL-FL	DAL-FL
Tester	ETS364	ETS364
Test Number	EB672302	EB672302
Unit	nsec	
Max Limit	48	
Min Limit	1	

krad(Si)	Serial #	pre_short (rtp) (2)	ST_Combo (rpt) (Delta
0	Ctrl	30.887	30.887	0.000
3	58	30.404	30.359	-0.045
3	59	30.535	30.410	-0.126
3	60	30.393	30.316	-0.077
3	61	30.460	30.414	-0.046
3	62	30.692	30.563	-0.129
3	134	31.076	30.215	-0.861
3	137	30.647	30.258	-0.389
3	138	30.789	30.183	-0.606
3	139	30.430	30.213	-0.217
3	236	30.697	29.924	-0.772
10	63	30.526	30.374	-0.152
10	64	30.825	30.556	-0.268
10	65	30.435	30.216	-0.219
10	66	30.266	29.975	-0.291
10	150	30.826	30.493	-0.333
10	237	30.432	29.912	-0.520
10	241	30.267	30.264	-0.003
10	242	30.669	30.384	-0.285
10	243	30.434	30.161	-0.272
10	244	30.256	30.027	-0.229
30	141	30.770	30.338	-0.431
30	144	30.893	30.369	-0.524
30	145	30.747	30.293	-0.454
30	146	30.498	30.092	-0.406
30	147	30.439	29.964	-0.475
30	132	31.061	30.645	-0.417
30	133	30.546	30.031	-0.515
30	135	30.165	30.181	0.016
30	245	30.670	30.274	-0.396
30	246	30.798	30.461	-0.337
50	67	30.338	29.917	-0.421
50	68	30.665	30.067	-0.598
50	69	30.798	30.192	-0.606
50	71	30.822	30.299	-0.522
50	72	30.336	29.690	-0.646
50	172	30.313	29.792	-0.521
50	173	30.498	30.051	-0.447
50	174	31.028	30.271	-0.757
50	183	30.915	30.452	-0.463
50	186	30.757	30.192	-0.565
100	95	30.581	29.646	-0.935
100	102	30.442	29.680	-0.762
100	104	30.321	29.399	-0.922
100	105	30.583	29.798	-0.785
100	106	30.644	29.981	-0.663
100	178	30.556	29.754	-0.802
100	179	30.880	30.126	-0.754
100	180	31.007	30.188	-0.819
100	181	30.635	29.861	-0.774
100	182	30.744	29.891	-0.853
Max		31.076	30.887	0.016
Average		30.616	30.157	-0.459
Min		30.165	29.399	-0.935
Std Dev		0.230	0.285	0.266

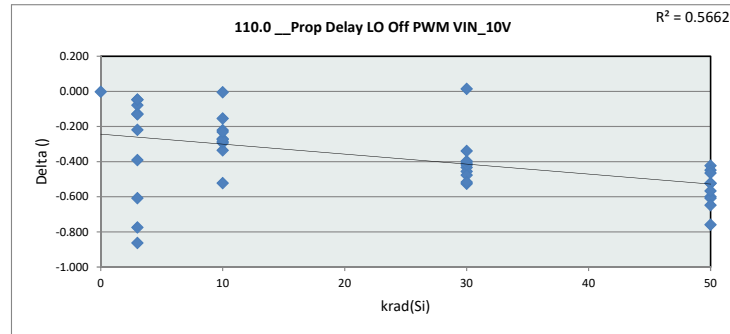

110.0 Prop Delay	
Test Site	DAL-FL
Tester	ETS364
Test Number	EB672302
Max Limit	48
Min Limit	1

krad(Si)	0	3	10	30	50	100
LL	1.000	1.000	1.000	1.000	1.000	1.000
Min	30.887	29.924	29.912	29.964	29.690	29.399
Average	30.887	30.286	30.236	30.265	30.092	29.832
Max	30.887	30.563	30.556	30.645	30.452	30.188
UL	48.000	48.000	48.000	48.000	48.000	48.000

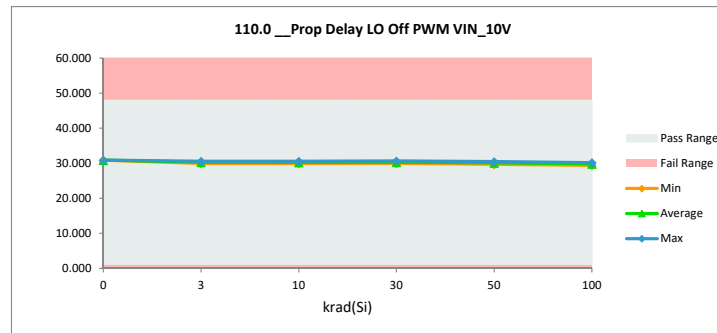

TID HDR Report
TPS7H6003-SP (5962R2220101VXC)

110.1 Prop Delay HO Off PWM		
Test Site	DAL-FL	DAL-FL
Tester	ETS364	ETS364
Test Number	EB672302	EB672302
Unit	nsec	
Max Limit	50	
Min Limit	1	

krad(Si)	Serial #	pre_short (rtp)	(2)'ST_Combo (rpt)	Delta
0	Ctrl	33.548	33.548	0.000
3	58	33.034	33.351	0.317
3	59	32.985	32.975	-0.010
3	60	32.695	32.841	0.146
3	61	33.553	33.694	0.141
3	62	33.707	33.778	0.071
3	134	33.365	33.124	-0.242
3	137	33.317	33.161	-0.156
3	138	33.591	33.066	-0.525
3	139	32.974	32.962	-0.012
3	236	33.053	32.758	-0.295
10	63	33.209	33.277	0.068
10	64	33.594	33.448	-0.146
10	65	32.998	32.946	-0.053
10	66	33.359	33.486	0.127
10	150	33.139	32.918	-0.221
10	237	33.023	32.703	-0.320
10	241	32.686	33.067	0.382
10	242	33.152	33.193	0.041
10	243	33.545	33.362	-0.183
10	244	33.106	33.156	0.049
30	141	33.092	32.889	-0.203
30	144	33.644	33.298	-0.346
30	145	33.600	33.619	0.019
30	146	33.250	33.042	-0.208
30	147	32.757	32.546	-0.211
30	132	33.904	33.660	-0.244
30	133	33.043	32.817	-0.226
30	135	32.761	33.783	1.022
30	245	33.457	33.241	-0.216
30	246	32.934	32.784	-0.150
50	67	32.908	32.685	-0.223
50	68	33.408	33.278	-0.130
50	69	33.134	32.899	-0.235
50	71	33.987	33.857	-0.130
50	72	32.775	32.523	-0.252
50	172	33.243	32.884	-0.359
50	173	33.402	33.044	-0.358
50	174	33.328	32.956	-0.371
50	183	33.255	32.869	-0.385
50	186	33.928	33.555	-0.372
100	95	33.008	32.482	-0.525
100	102	33.222	32.472	-0.750
100	104	33.023	32.403	-0.619
100	105	33.400	32.923	-0.477
100	106	33.429	32.968	-0.461
100	178	32.972	32.443	-0.529
100	179	33.577	32.976	-0.600
100	180	33.417	32.873	-0.544
100	181	33.278	32.693	-0.585
100	182	33.645	32.839	-0.806
	Max	33.987	33.857	1.022
	Average	33.263	33.061	-0.202
	Min	32.686	32.403	-0.806
	Std Dev	0.319	0.374	0.311

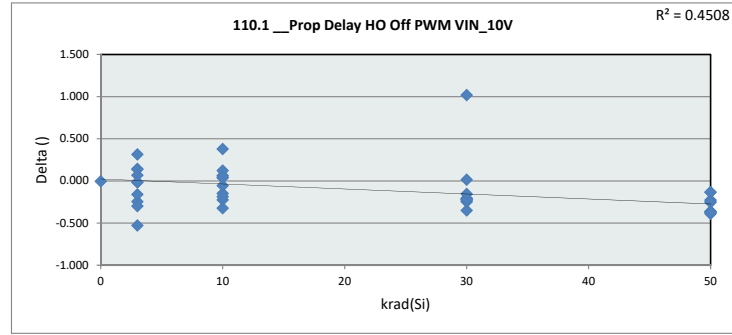

110.1 Prop Delay						
Test Site	DAL-FL					
Tester	ETS364					
Test Number	EB672302					
Max Limit	50					
Min Limit	1					
krad(Si)	0	3	10	30	50	100
LL	1.000	1.000	1.000	1.000	1.000	1.000
Min	33.548	32.758	32.703	32.546	32.523	32.404
Average	33.548	33.171	33.156	33.168	33.055	32.707
Max	33.548	33.778	33.486	33.783	33.857	32.976
UL	50.000	50.000	50.000	50.000	50.000	50.000

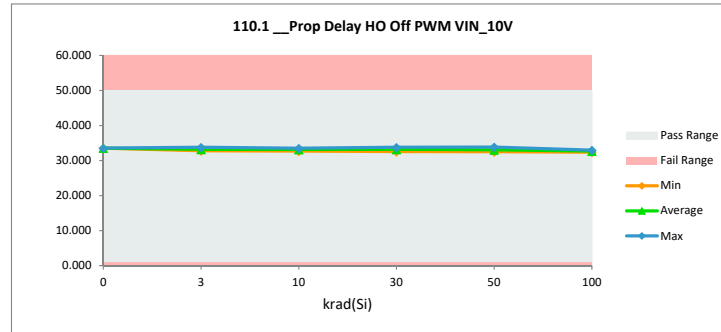

TID HDR Report
TPS7H6003-SP (5962R2220101VXC)

110.2 Prop Delay LO On IIM Interlock VIN_10V		
Test Site	DAL-FL	DAL-FL
Tester	ETS364	ETS364
Test Number	EB672302	EB672302
Unit	nsec	
Max Limit	38	
Min Limit	1	

krad(Si)	Serial #	pre_short (rtp) (2)	ST_Combo (rpt) (Delta
0	Ctrl	23.269	23.269	0.000
3	58	23.265	23.203	-0.062
3	59	23.483	23.400	-0.083
3	60	23.221	23.167	-0.055
3	61	23.265	23.260	-0.005
3	62	23.302	23.235	-0.067
3	134	23.489	23.232	-0.257
3	137	23.530	23.263	-0.267
3	138	23.436	23.255	-0.181
3	139	23.369	23.186	-0.183
3	236	23.267	22.946	-0.321
10	63	23.381	23.298	-0.083
10	64	23.463	23.297	-0.166
10	65	23.283	23.131	-0.153
10	66	23.051	22.915	-0.136
10	150	23.643	23.391	-0.252
10	237	23.367	22.959	-0.408
10	241	23.261	23.230	-0.031
10	242	23.270	23.154	-0.115
10	243	23.122	22.954	-0.169
10	244	23.197	23.065	-0.132
30	141	23.368	23.149	-0.219
30	144	23.520	23.201	-0.319
30	145	23.357	23.083	-0.274
30	146	23.271	23.012	-0.259
30	147	23.305	23.010	-0.295
30	132	23.565	23.408	-0.157
30	133	23.256	22.964	-0.293
30	135	23.158	23.185	0.026
30	245	23.444	23.251	-0.193
30	246	23.360	23.107	-0.253
50	67	23.252	23.005	-0.247
50	68	23.180	23.141	-0.039
50	69	23.337	23.018	-0.319
50	71	23.382	23.144	-0.238
50	72	23.153	22.856	-0.297
50	172	23.392	23.036	-0.356
50	173	23.415	23.225	-0.190
50	174	23.426	23.132	-0.294
50	183	23.520	23.243	-0.277
50	186	23.427	23.179	-0.248
100	95	23.458	23.053	-0.404
100	102	23.235	22.761	-0.473
100	104	23.323	22.864	-0.459
100	105	23.188	22.755	-0.433
100	106	23.313	22.999	-0.314
100	178	23.264	22.913	-0.352
100	179	23.515	23.140	-0.375
100	180	23.471	23.204	-0.267
100	181	23.418	23.004	-0.414
100	182	23.297	22.796	-0.501
Max		23.643	23.408	0.026
Average		23.343	23.111	-0.233
Min		23.051	22.755	-0.501
Std Dev		0.125	0.160	0.131

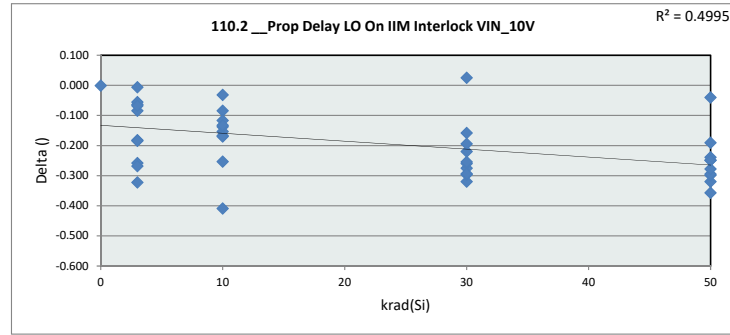

110.2 Prop Delay	
Test Site	DAL-FL
Tester	ETS364
Test Number	EB672302
Max Limit	38
Min Limit	1

krad(Si)	0	3	10	30	50	100
LL	1.000	1.000	1.000	1.000	1.000	1.000
Min	23.269	22.946	22.915	22.964	22.856	22.755
Average	23.269	23.215	23.139	23.137	23.098	22.949
Max	23.269	23.400	23.391	23.408	23.243	23.204
UL	38.000	38.000	38.000	38.000	38.000	38.000

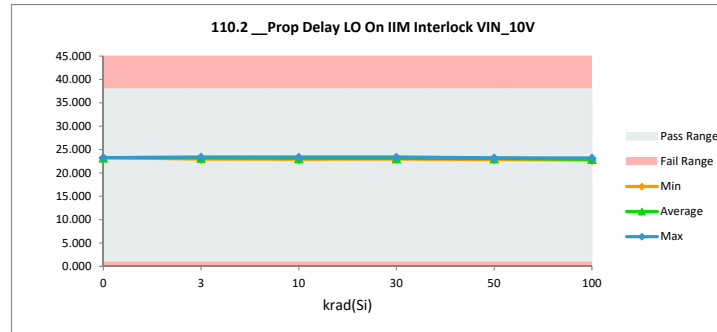

TID HDR Report
TPS7H6003-SP (5962R2220101VXC)

110.3 Prop Delay LO Off IIM Interlock VIN_10V		
Test Site	DAL-FL	DAL-FL
Tester	ETS364	ETS364
Test Number	EB672302	EB672302
Unit	nsec	
Max Limit	38	
Min Limit	1	

krad(Si)	Serial #	pre_short (rtp)	(2)ST_Combo (rpt)	Delta
0	Ctrl	27.573	27.573	0.000
3	58	27.338	27.484	0.147
3	59	27.592	27.518	-0.074
3	60	27.262	27.251	-0.011
3	61	27.421	27.433	0.012
3	62	27.387	27.433	0.045
3	134	27.794	27.388	-0.406
3	137	27.616	27.432	-0.184
3	138	27.568	27.449	-0.119
3	139	27.313	27.322	0.009
3	236	27.454	27.045	-0.409
10	63	27.382	27.330	-0.052
10	64	27.552	27.448	-0.104
10	65	27.268	27.208	-0.060
10	66	27.210	27.097	-0.113
10	150	27.707	27.606	-0.101
10	237	27.451	27.141	-0.310
10	241	27.250	27.385	0.135
10	242	27.454	27.345	-0.109
10	243	27.203	27.107	-0.096
10	244	27.212	27.190	-0.022
30	141	27.489	27.255	-0.234
30	144	27.702	27.499	-0.203
30	145	27.537	27.371	-0.166
30	146	27.413	27.343	-0.070
30	147	27.298	27.015	-0.283
30	132	27.793	27.538	-0.255
30	133	27.406	27.158	-0.248
30	135	27.114	27.468	0.354
30	245	27.410	27.374	-0.036
30	246	27.558	27.383	-0.175
50	67	27.291	27.201	-0.090
50	68	27.365	27.259	-0.107
50	69	27.483	27.304	-0.179
50	71	27.466	27.250	-0.215
50	72	27.300	27.080	-0.220
50	172	27.327	27.106	-0.221
50	173	27.315	27.141	-0.174
50	174	27.704	27.365	-0.339
50	183	27.728	27.459	-0.268
50	186	27.547	27.295	-0.252
100	95	27.505	27.125	-0.380
100	102	27.376	27.126	-0.250
100	104	27.252	26.839	-0.414
100	105	27.288	26.941	-0.347
100	106	27.464	27.322	-0.143
100	178	27.473	27.024	-0.449
100	179	27.761	27.464	-0.297
100	180	27.769	27.508	-0.261
100	181	27.507	27.144	-0.363
100	182	27.460	26.941	-0.519
	Max	27.794	27.606	0.354
	Average	27.453	27.284	-0.169
	Min	27.114	26.839	-0.519
	Std Dev	0.171	0.182	0.166

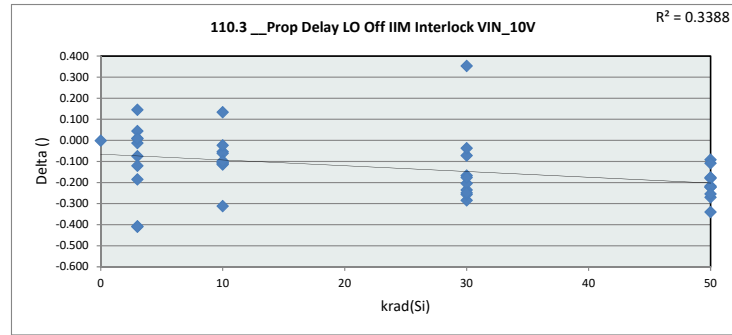

110.3 Prop Delay						
Test Site	DAL-FL					
Tester	ETS364					
Test Number	EB672302					
Max Limit	38					
Min Limit	1					
krad(Si)	0	3	10	30	50	100
LL	1.000	1.000	1.000	1.000	1.000	1.000
Min	27.573	27.045	27.097	27.015	27.080	26.839
Average	27.573	27.375	27.286	27.340	27.246	27.143
Max	27.573	27.518	27.606	27.538	27.459	27.508
UL	38.000	38.000	38.000	38.000	38.000	38.000

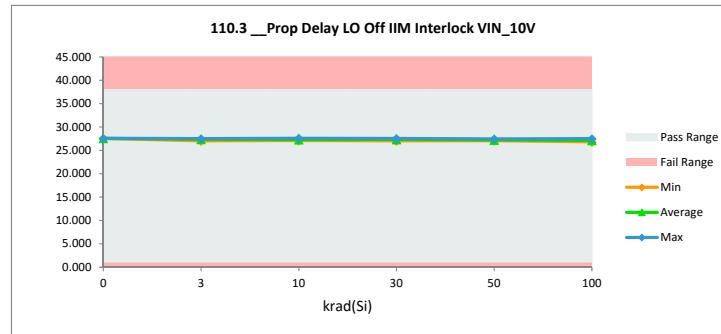

TID HDR Report
TPS7H6003-SP (5962R2220101VXC)

110.4 Prop Delay HO On IIM I		
Test Site	DAL-FL	DAL-FL
Tester	ETS364	ETS364
Test Number	EB672302	EB672302
Unit	nsec	
Max Limit	40	
Min Limit	1	

krad(Si)	Serial #	pre_short (rtp) (2)	ST_Combo (rpt) (Delta
0	Ctrl	26.267	26.267	0.000
3	58	26.383	26.337	-0.046
3	59	26.458	26.233	-0.225
3	60	25.994	25.759	-0.235
3	61	26.620	26.537	-0.084
3	62	26.622	26.499	-0.123
3	134	26.433	26.517	0.084
3	137	26.542	26.516	-0.026
3	138	26.861	26.473	-0.388
3	139	26.436	26.106	-0.330
3	236	26.024	26.038	0.014
10	63	26.365	26.107	-0.258
10	64	26.548	26.163	-0.385
10	65	26.341	25.976	-0.366
10	66	26.434	26.218	-0.216
10	150	26.322	25.927	-0.395
10	237	26.529	26.022	-0.507
10	241	26.069	26.500	0.432
10	242	26.063	25.793	-0.269
10	243	26.361	25.953	-0.408
10	244	26.357	26.044	-0.313
30	141	26.251	25.865	-0.386
30	144	26.758	26.314	-0.444
30	145	26.931	26.588	-0.342
30	146	26.289	25.794	-0.496
30	147	26.179	25.693	-0.486
30	132	26.933	26.516	-0.417
30	133	26.414	26.001	-0.414
30	135	26.298	26.576	0.279
30	245	26.500	26.110	-0.391
30	246	26.281	25.830	-0.451
50	67	26.518	26.012	-0.506
50	68	26.123	26.128	0.006
50	69	26.580	26.054	-0.526
50	71	26.923	26.422	-0.501
50	72	25.982	25.566	-0.416
50	172	26.741	26.232	-0.509
50	173	26.484	25.965	-0.519
50	174	26.328	26.056	-0.272
50	183	26.403	25.893	-0.510
50	186	26.989	26.510	-0.479
100	95	26.506	25.799	-0.707
100	102	26.223	25.396	-0.827
100	104	26.201	25.495	-0.705
100	105	26.282	25.628	-0.654
100	106	26.573	25.880	-0.693
100	178	26.484	25.830	-0.654
100	179	26.672	25.894	-0.778
100	180	26.660	26.051	-0.609
100	181	26.418	25.775	-0.643
100	182	26.510	25.705	-0.806
	Max	26.989	26.588	0.432
	Average	26.440	26.070	-0.371
	Min	25.982	25.396	-0.827
	Std Dev	0.245	0.306	0.267

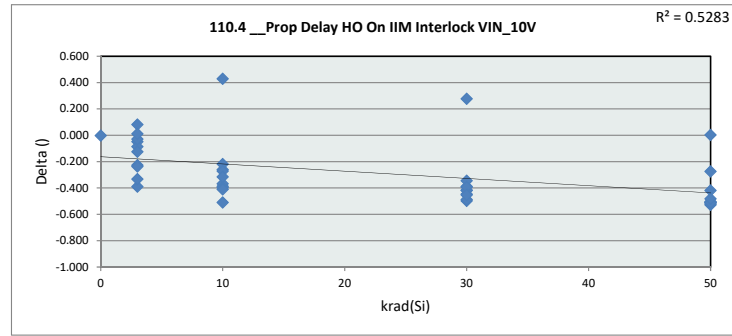

110.4 Prop Delay						
Test Site	DAL-FL					
Tester	ETS364					
Test Number	EB672302					
Max Limit	40					
Min Limit	1					
krad(Si)	0	3	10	30	50	100
LL	1.000	1.000	1.000	1.000	1.000	1.000
Min	26.267	25.759	25.793	25.693	25.566	25.397
Average	26.267	26.301	26.070	26.129	26.084	25.745
Max	26.267	26.537	26.500	26.589	26.510	26.051
UL	40.000	40.000	40.000	40.000	40.000	40.000

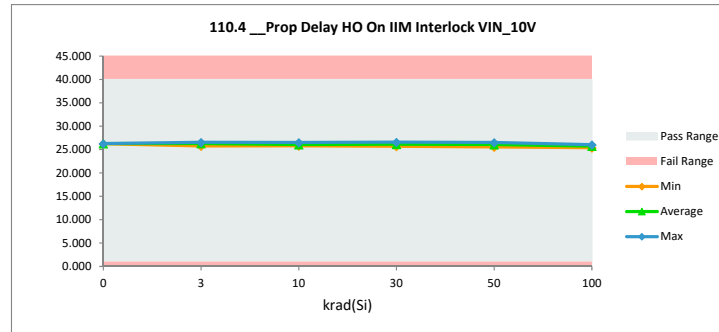

TID HDR Report
TPS7H6003-SP (5962R2220101VXC)

110.5 Prop Delay HO Off IIM I		
Test Site	DAL-FL	DAL-FL
Tester	ETS364	ETS364
Test Number	EB672302	EB672302
Unit	nsec	
Max Limit	40	40
Min Limit	1	1

krad(Si)	Serial #	pre_short (rtp) (2)	ST_Combo (rpt) (Delta
0	Ctrl	28.327	28.327	0.000
3	58	28.370	28.539	0.169
3	59	28.395	28.235	-0.160
3	60	27.896	27.863	-0.033
3	61	28.789	28.756	-0.033
3	62	28.710	28.722	0.012
3	134	28.507	28.386	-0.121
3	137	28.635	28.423	-0.212
3	138	28.781	28.410	-0.371
3	139	28.209	28.125	-0.084
3	236	28.140	27.918	-0.222
10	63	28.275	28.182	-0.093
10	64	28.698	28.461	-0.237
10	65	28.150	27.940	-0.210
10	66	28.687	28.633	-0.053
10	150	28.395	28.104	-0.290
10	237	28.426	27.910	-0.515
10	241	28.045	28.417	0.372
10	242	28.278	28.145	-0.133
10	243	28.644	28.431	-0.213
10	244	28.433	28.263	-0.170
30	141	28.198	27.992	-0.206
30	144	28.823	28.448	-0.376
30	145	28.767	28.663	-0.104
30	146	28.480	28.176	-0.304
30	147	27.956	27.721	-0.235
30	132	28.958	28.632	-0.325
30	133	28.278	27.955	-0.323
30	135	28.060	28.916	0.855
30	245	28.551	28.346	-0.205
30	246	28.081	27.822	-0.260
50	67	28.231	28.018	-0.213
50	68	28.450	28.352	-0.098
50	69	28.282	27.919	-0.363
50	71	29.013	28.870	-0.143
50	72	28.048	27.698	-0.351
50	172	28.547	28.182	-0.365
50	173	28.488	28.139	-0.349
50	174	28.306	28.115	-0.191
50	183	28.408	28.010	-0.398
50	186	29.049	28.749	-0.300
100	95	28.300	27.867	-0.434
100	102	28.440	27.817	-0.623
100	104	28.244	27.762	-0.482
100	105	28.497	28.079	-0.417
100	106	28.642	28.325	-0.317
100	178	28.340	27.832	-0.508
100	179	28.759	28.232	-0.527
100	180	28.524	28.147	-0.377
100	181	28.354	28.026	-0.328
100	182	28.668	28.017	-0.652
	Max	29.049	28.916	0.855
	Average	28.442	28.216	-0.226
	Min	27.896	27.698	-0.652
	Std Dev	0.270	0.313	0.243

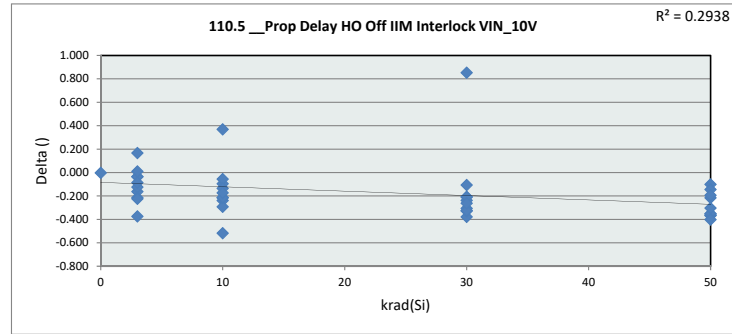

110.5 Prop Delay	
Test Site	DAL-FL
Tester	ETS364
Test Number	EB672302
Max Limit	40
Min Limit	1

krad(Si)	0	3	10	30	50	100
LL	1.000	1.000	1.000	1.000	1.000	1.000
Min	28.327	27.863	27.911	27.721	27.698	27.762
Average	28.327	28.338	28.249	28.267	28.205	28.010
Max	28.327	28.756	28.634	28.916	28.870	28.325
UL	40.000	40.000	40.000	40.000	40.000	40.000

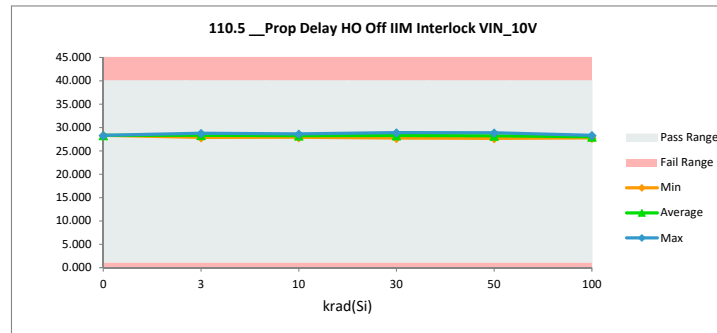

TID HDR Report
TPS7H6003-SP (5962R2220101VXC)

110.6 Prop Delay LO On IIM Tr		
Test Site	DAL-FL	DAL-FL
Tester	ETS364	ETS364
Test Number	EB672302	EB672302
Unit	nsec	
Max Limit	38	
Min Limit	1	

krad(Si)	Serial #	pre_short (rtp) (2)	ST_Combo (rpt) (Delta
0	Ctrl	23.249	23.249	0.000
3	58	23.206	23.203	-0.003
3	59	23.437	23.386	-0.050
3	60	23.208	23.254	0.046
3	61	23.223	23.168	-0.056
3	62	23.285	23.188	-0.096
3	134	23.447	23.285	-0.161
3	137	23.510	23.250	-0.259
3	138	23.414	23.194	-0.220
3	139	23.310	23.152	-0.159
3	236	23.216	22.973	-0.243
10	63	23.350	23.354	0.004
10	64	23.417	23.311	-0.106
10	65	23.273	23.187	-0.086
10	66	22.986	22.874	-0.112
10	150	23.607	23.457	-0.151
10	237	23.353	22.956	-0.397
10	241	23.211	23.233	0.022
10	242	23.273	23.045	-0.228
10	243	23.107	22.971	-0.136
10	244	23.150	23.019	-0.131
30	141	23.362	23.167	-0.194
30	144	23.489	23.186	-0.304
30	145	23.341	23.115	-0.226
30	146	23.238	23.077	-0.161
30	147	23.303	23.075	-0.228
30	132	23.539	23.375	-0.164
30	133	23.236	23.035	-0.201
30	135	23.144	23.180	0.035
30	245	23.408	23.158	-0.250
30	246	23.332	23.090	-0.242
50	67	23.213	23.062	-0.151
50	68	23.167	23.156	-0.011
50	69	23.299	22.968	-0.331
50	71	23.365	23.053	-0.312
50	72	23.134	22.898	-0.236
50	172	23.362	23.037	-0.325
50	173	23.364	23.186	-0.178
50	174	23.427	23.121	-0.306
50	183	23.503	23.260	-0.244
50	186	23.418	23.148	-0.270
100	95	23.421	22.977	-0.444
100	102	23.200	22.830	-0.370
100	104	23.305	22.794	-0.511
100	105	23.138	22.789	-0.349
100	106	23.247	23.052	-0.194
100	178	23.229	22.896	-0.332
100	179	23.475	23.108	-0.367
100	180	23.444	23.096	-0.347
100	181	23.394	22.934	-0.460
100	182	23.263	22.802	-0.461
Max		23.607	23.457	0.046
Average		23.314	23.105	-0.209
Min		22.986	22.789	-0.511
Std Dev		0.127	0.157	0.138

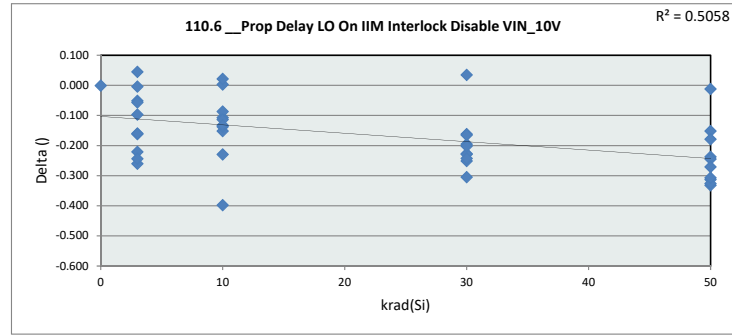

110.6 Prop Delay	
Test Site	DAL-FL
Tester	ETS364
Test Number	EB672302
Max Limit	38
Min Limit	1

krad(Si)	0	3	10	30	50	100
LL	1.000	1.000	1.000	1.000	1.000	1.000
Min	23.249	22.973	22.874	23.035	22.898	22.789
Average	23.249	23.205	23.141	23.146	23.089	22.928
Max	23.249	23.386	23.457	23.375	23.260	23.108
UL	38.000	38.000	38.000	38.000	38.000	38.000

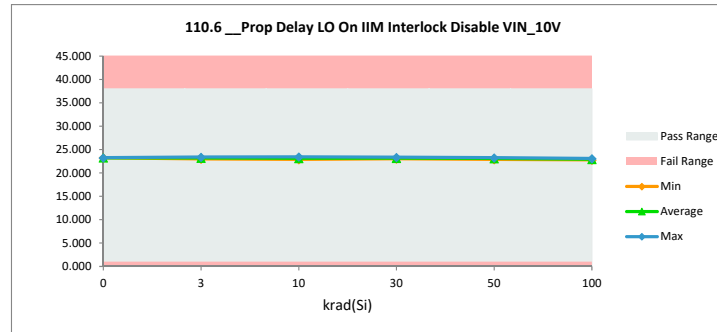

TID HDR Report
TPS7H6003-SP (5962R2220101VXC)

110.7 Prop Delay LO Off IIM I		
Test Site	DAL-FL	DAL-FL
Tester	ETS364	ETS364
Test Number	EB672302	EB672302
Unit	nsec	
Max Limit	38	
Min Limit	1	

krad(Si)	Serial #	pre_short (rtp)	(2)ST_Combo (rpt)	Delta
0	Ctrl	27.478	27.478	0.000
3	58	27.238	27.341	0.103
3	59	27.468	27.498	0.030
3	60	27.159	27.105	-0.054
3	61	27.284	27.281	-0.003
3	62	27.279	27.236	-0.043
3	134	27.654	27.337	-0.317
3	137	27.523	27.285	-0.237
3	138	27.451	27.281	-0.169
3	139	27.202	27.099	-0.103
3	236	27.378	27.015	-0.363
10	63	27.242	27.275	0.033
10	64	27.433	27.303	-0.130
10	65	27.104	27.121	0.017
10	66	27.067	27.003	-0.064
10	150	27.590	27.441	-0.148
10	237	27.301	26.936	-0.366
10	241	27.095	27.283	0.188
10	242	27.316	27.138	-0.178
10	243	27.105	26.960	-0.144
10	244	27.120	27.103	-0.017
30	141	27.361	27.198	-0.163
30	144	27.586	27.414	-0.172
30	145	27.384	27.216	-0.168
30	146	27.329	27.100	-0.229
30	147	27.143	26.956	-0.187
30	132	27.683	27.463	-0.220
30	133	27.283	27.118	-0.165
30	135	26.990	27.392	0.402
30	245	27.285	27.100	-0.186
30	246	27.404	27.250	-0.154
50	67	27.171	27.111	-0.059
50	68	27.264	27.219	-0.046
50	69	27.389	27.205	-0.184
50	71	27.338	27.193	-0.144
50	72	27.169	26.944	-0.224
50	172	27.186	26.987	-0.200
50	173	27.160	27.057	-0.104
50	174	27.566	27.319	-0.247
50	183	27.607	27.366	-0.241
50	186	27.423	27.195	-0.228
100	95	27.361	26.957	-0.404
100	102	27.242	26.967	-0.275
100	104	27.126	26.806	-0.320
100	105	27.164	26.816	-0.348
100	106	27.339	27.264	-0.076
100	178	27.353	27.036	-0.317
100	179	27.630	27.319	-0.312
100	180	27.638	27.470	-0.168
100	181	27.360	27.161	-0.199
100	182	27.309	26.884	-0.425
	Max	27.683	27.498	0.402
	Average	27.328	27.176	-0.151
	Min	26.990	26.806	-0.425
	Std Dev	0.172	0.178	0.152

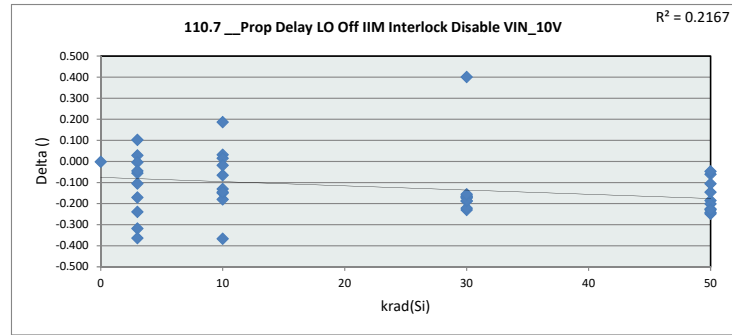

110.7 Prop Delay	
Test Site	DAL-FL
Tester	ETS364
Test Number	EB672302
Max Limit	38
Min Limit	1

krad(Si)	0	3	10	30	50	100
LL	1.000	1.000	1.000	1.000	1.000	1.000
Min	27.478	27.015	26.936	26.956	26.944	26.806
Average	27.478	27.248	27.156	27.221	27.160	27.068
Max	27.478	27.498	27.441	27.463	27.366	27.470
UL	38.000	38.000	38.000	38.000	38.000	38.000

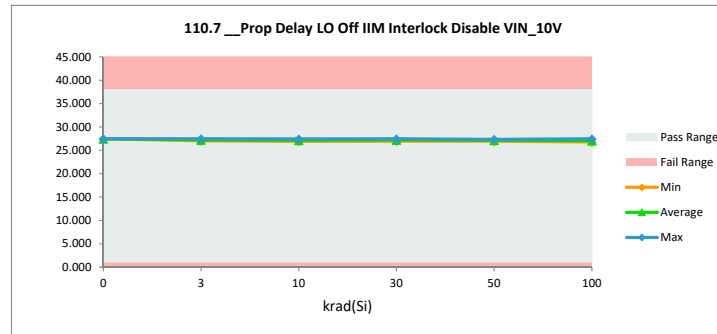

TID HDR Report
TPS7H6003-SP (5962R2220101VXC)

110.8 Prop Delay HO On IIM I		
Test Site	DAL-FL	DAL-FL
Tester	ETS364	ETS364
Test Number	EB672302	EB672302
Unit	nsec	
Max Limit	40	40
Min Limit	1	1

krad(Si)	Serial #	pre_short (rtp)	(2)ST_Combo (rpt)	Delta
0	Ctrl	26.076	26.076	0.000
3	58	26.303	26.129	-0.174
3	59	26.316	26.070	-0.246
3	60	25.893	25.743	-0.150
3	61	26.467	26.305	-0.162
3	62	26.551	26.367	-0.184
3	134	26.353	26.287	-0.066
3	137	26.467	26.351	-0.116
3	138	26.702	26.364	-0.339
3	139	26.325	26.053	-0.272
3	236	25.955	25.918	-0.037
10	63	26.232	26.001	-0.231
10	64	26.434	26.076	-0.359
10	65	26.185	25.832	-0.353
10	66	26.305	26.076	-0.229
10	150	26.178	25.850	-0.329
10	237	26.419	25.866	-0.554
10	241	25.981	26.327	0.347
10	242	25.955	25.717	-0.237
10	243	26.230	25.840	-0.391
10	244	26.270	25.989	-0.281
30	141	26.159	25.673	-0.485
30	144	26.637	26.152	-0.485
30	145	26.827	26.478	-0.350
30	146	26.191	25.661	-0.530
30	147	26.084	25.598	-0.486
30	132	26.790	26.410	-0.379
30	133	26.294	25.877	-0.417
30	135	26.180	26.523	0.343
30	245	26.388	26.055	-0.333
30	246	26.137	25.784	-0.353
50	67	26.368	25.834	-0.533
50	68	25.997	25.992	-0.005
50	69	26.430	25.917	-0.513
50	71	26.834	26.292	-0.542
50	72	25.891	25.386	-0.505
50	172	26.552	26.076	-0.477
50	173	26.354	25.919	-0.435
50	174	26.197	25.927	-0.270
50	183	26.252	25.747	-0.505
50	186	26.862	26.401	-0.461
100	95	26.391	25.703	-0.688
100	102	26.069	25.278	-0.791
100	104	26.073	25.358	-0.716
100	105	26.169	25.591	-0.578
100	106	26.456	25.674	-0.782
100	178	26.346	25.686	-0.660
100	179	26.531	25.853	-0.677
100	180	26.548	25.925	-0.623
100	181	26.312	25.628	-0.684
100	182	26.420	25.518	-0.901
	Max	26.862	26.523	0.347
	Average	26.320	25.944	-0.376
	Min	25.891	25.278	-0.901
	Std Dev	0.241	0.299	0.257

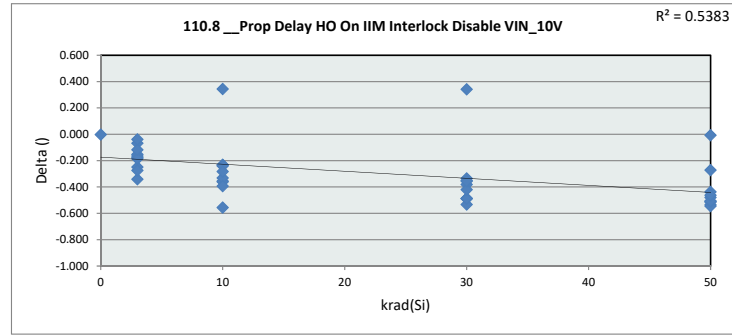

110.8 Prop Delay

Test Site	DAL-FL
Tester	ETS364
Test Number	EB672302
Max Limit	40
Min Limit	1

krad(Si)	0	3	10	30	50	100
LL	1.000	1.000	1.000	1.000	1.000	1.000
Min	26.076	25.744	25.717	25.598	25.386	25.278
Average	26.076	26.159	25.957	26.021	25.949	25.621
Max	26.076	26.367	26.327	26.523	26.401	25.925
UL	40.000	40.000	40.000	40.000	40.000	40.000

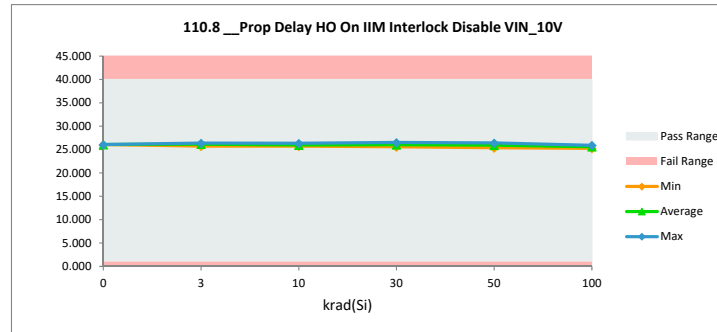

TID HDR Report
TPS7H6003-SP (5962R2220101VXC)

110.9 Prop Delay HO Off IIM I		
Test Site	DAL-FL	DAL-FL
Tester	ETS364	ETS364
Test Number	EB672302	EB672302
Unit	nsec	
Max Limit	40	40
Min Limit	1	1

krad(Si)	Serial #	pre_short (rtp)	(2)ST_Combo (rpt)	Delta
0	Ctrl	28.874	28.874	0.000
3	58	28.919	28.911	-0.008
3	59	28.886	28.723	-0.163
3	60	28.443	28.390	-0.053
3	61	29.291	29.364	0.073
3	62	29.243	29.297	0.054
3	134	29.001	28.865	-0.137
3	137	29.144	28.970	-0.173
3	138	29.281	28.875	-0.406
3	139	28.721	28.621	-0.100
3	236	28.661	28.521	-0.140
10	63	28.851	28.719	-0.132
10	64	29.224	28.954	-0.271
10	65	28.672	28.466	-0.206
10	66	29.182	29.108	-0.075
10	150	28.902	28.617	-0.284
10	237	28.965	28.461	-0.503
10	241	28.539	28.902	0.363
10	242	28.785	28.648	-0.137
10	243	29.169	28.913	-0.256
10	244	28.967	28.792	-0.175
30	141	28.720	28.484	-0.236
30	144	29.343	28.955	-0.389
30	145	29.290	29.160	-0.130
30	146	29.030	28.713	-0.317
30	147	28.499	28.210	-0.289
30	132	29.476	29.163	-0.313
30	133	28.765	28.411	-0.354
30	135	28.577	29.495	0.919
30	245	29.074	28.820	-0.254
30	246	28.622	28.358	-0.264
50	67	28.720	28.483	-0.237
50	68	28.992	28.897	-0.094
50	69	28.795	28.495	-0.300
50	71	29.546	29.382	-0.165
50	72	28.579	28.245	-0.334
50	172	29.065	28.689	-0.377
50	173	29.044	28.702	-0.342
50	174	28.835	28.599	-0.236
50	183	28.919	28.544	-0.375
50	186	29.557	29.254	-0.303
100	95	28.803	28.332	-0.471
100	102	28.991	28.321	-0.669
100	104	28.749	28.232	-0.517
100	105	29.053	28.565	-0.487
100	106	29.200	28.843	-0.357
100	178	28.799	28.301	-0.498
100	179	29.344	28.836	-0.507
100	180	29.048	28.606	-0.442
100	181	28.909	28.541	-0.368
100	182	29.166	28.497	-0.669
	Max	29.557	29.495	0.919
	Average	28.965	28.728	-0.237
	Min	28.443	28.210	-0.669
	Std Dev	0.271	0.319	0.251

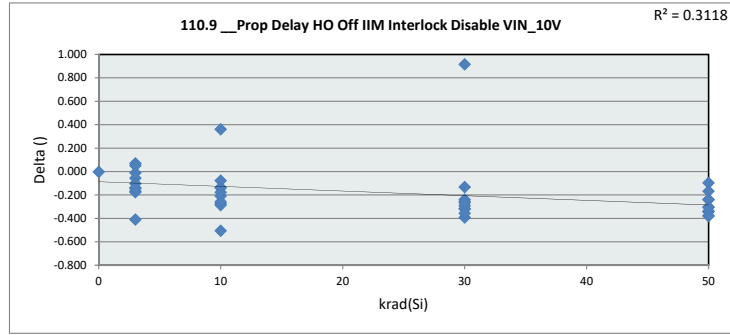

110.9 Prop Delay						
Test Site	DAL-FL					
Tester	ETS364					
Test Number	EB672302					
Max Limit	40					
Min Limit	1					
krad(Si)	0	3	10	30	50	100
LL	1.000	1.000	1.000	1.000	1.000	1.000
Min	28.874	28.390	28.461	28.210	28.245	28.232
Average	28.874	28.854	28.758	28.777	28.729	28.508
Max	28.874	29.364	29.108	29.495	29.382	28.843
UL	40.000	40.000	40.000	40.000	40.000	40.000

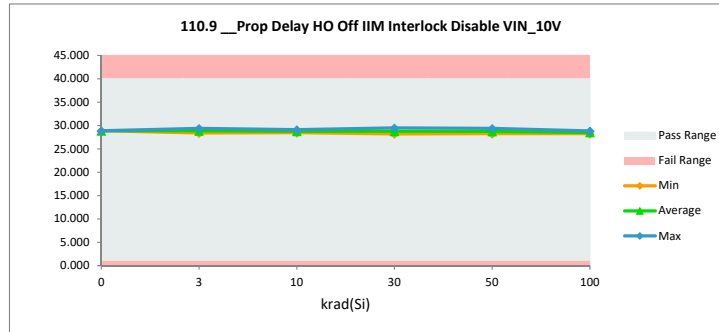

TID HDR Report
TPS7H6003-SP (5962R2220101VXC)

110.10 Delay Match LO On HO		
Test Site	DAL-FL	DAL-FL
Tester	ETS364	ETS364
Test Number	EB672302	EB672302
Unit	nsec	
Max Limit	12	12
Min Limit		

krad(Si)	Serial #	pre_short (rtp)	(2)ST_Combo (rpt)	Delta
0	Ctrl	5.058	5.058	0.000
3	58	5.105	5.337	0.232
3	59	4.911	4.835	-0.077
3	60	4.674	4.696	0.022
3	61	5.524	5.496	-0.027
3	62	5.409	5.487	0.079
3	134	5.018	5.154	0.136
3	137	5.104	5.160	0.055
3	138	5.345	5.154	-0.190
3	139	4.840	4.939	0.099
3	236	4.873	4.972	0.099
10	63	4.894	4.884	-0.010
10	64	5.235	5.164	-0.071
10	65	4.867	4.809	-0.058
10	66	5.636	5.719	0.083
10	150	4.751	4.713	-0.038
10	237	5.059	4.952	-0.107
10	241	4.784	5.187	0.403
10	242	5.008	4.991	-0.017
10	243	5.521	5.477	-0.045
10	244	5.236	5.197	-0.039
30	141	4.829	4.842	0.013
30	144	5.304	5.247	-0.057
30	145	5.410	5.580	0.170
30	146	5.209	5.164	-0.045
30	147	4.651	4.711	0.060
30	132	5.393	5.225	-0.168
30	133	5.021	4.991	-0.030
30	135	4.902	5.731	0.829
30	245	5.106	5.095	-0.012
30	246	4.721	4.715	-0.006
50	67	4.978	5.013	0.035
50	68	5.270	5.211	-0.059
50	69	4.945	4.901	-0.044
50	71	5.631	5.726	0.095
50	72	4.895	4.841	-0.054
50	172	5.155	5.146	-0.009
50	173	5.073	4.914	-0.159
50	174	4.881	4.983	0.102
50	183	4.888	4.767	-0.122
50	186	5.622	5.570	-0.052
100	95	4.843	4.813	-0.029
100	102	5.205	5.055	-0.150
100	104	4.920	4.898	-0.022
100	105	5.308	5.324	0.016
100	106	5.329	5.326	-0.003
100	178	5.076	4.920	-0.156
100	179	5.244	5.092	-0.152
100	180	5.054	4.943	-0.110
100	181	4.937	5.022	0.086
100	182	5.372	5.221	-0.151
	Max	5.636	5.731	0.829
	Average	5.099	5.105	0.007
	Min	4.651	4.696	-0.190
	Std Dev	0.257	0.274	0.160

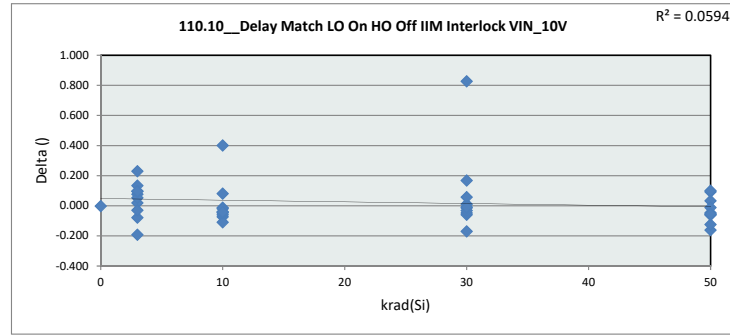

110.10 Delay Match	
Test Site	DAL-FL
Tester	ETS364
Test Number	EB672302
Max Limit	12
Min Limit	

krad(Si)	0	3	10	30	50	100
LL						
Min	5.058	4.696	4.713	4.711	4.767	4.813
Average	5.058	5.123	5.109	5.130	5.107	5.062
Max	5.058	5.496	5.719	5.731	5.726	5.326
UL	12.000	12.000	12.000	12.000	12.000	12.000

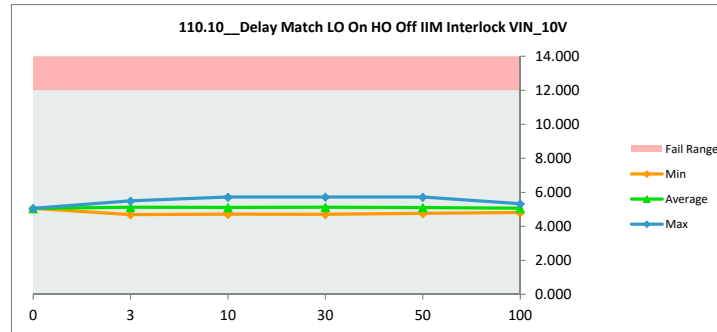

TID HDR Report
TPS7H6003-SP (5962R2220101VXC)

110.11 Delay Match LO Off HO		
Test Site	DAL-FL	DAL-FL
Tester	ETS364	ETS364
Test Number	EB672302	EB672302
Unit	nsec	
Max Limit	4	
Min Limit		

krad(Si)	Serial #	pre_short (rtp)	(2)ST_Combo (rpt)	Delta
0	Ctrl	1.306	1.306	0.000
3	58	0.955	1.148	0.193
3	59	1.133	1.285	0.151
3	60	1.269	1.492	0.223
3	61	0.801	0.896	0.095
3	62	0.765	0.933	0.168
3	134	1.361	0.871	-0.490
3	137	1.074	0.916	-0.158
3	138	0.707	0.976	0.269
3	139	0.877	1.216	0.339
3	236	1.430	1.008	-0.423
10	63	1.017	1.223	0.206
10	64	1.004	1.285	0.281
10	65	0.926	1.232	0.306
10	66	0.776	0.879	0.103
10	150	1.385	1.679	0.294
10	237	0.922	1.119	0.197
10	241	1.181	0.885	-0.296
10	242	1.391	1.552	0.161
10	243	0.842	1.154	0.312
10	244	0.854	1.146	0.291
30	141	1.238	1.390	0.152
30	144	0.944	1.185	0.241
30	145	0.606	0.782	0.176
30	146	1.124	1.549	0.425
30	147	1.119	1.322	0.203
30	132	0.860	1.021	0.161
30	133	0.991	1.157	0.166
30	135	0.816	0.892	0.076
30	245	0.909	1.264	0.355
30	246	1.277	1.553	0.276
50	67	0.773	1.189	0.415
50	68	1.243	1.130	-0.112
50	69	0.903	1.250	0.347
50	71	0.543	0.829	0.285
50	72	1.318	1.513	0.196
50	172	0.586	0.874	0.288
50	173	0.831	1.176	0.344
50	174	1.375	1.309	-0.067
50	183	1.325	1.566	0.242
50	186	0.558	0.785	0.227
100	95	0.999	1.326	0.327
100	102	1.153	1.729	0.577
100	104	1.052	1.344	0.292
100	105	1.006	1.313	0.308
100	106	0.891	1.441	0.551
100	178	0.989	1.194	0.205
100	179	1.089	1.570	0.481
100	180	1.110	1.457	0.348
100	181	1.089	1.368	0.280
100	182	0.950	1.236	0.286
	Max	1.430	1.729	0.577
	Average	1.013	1.214	0.201
	Min	0.543	0.782	-0.490
	Std Dev	0.231	0.245	0.208

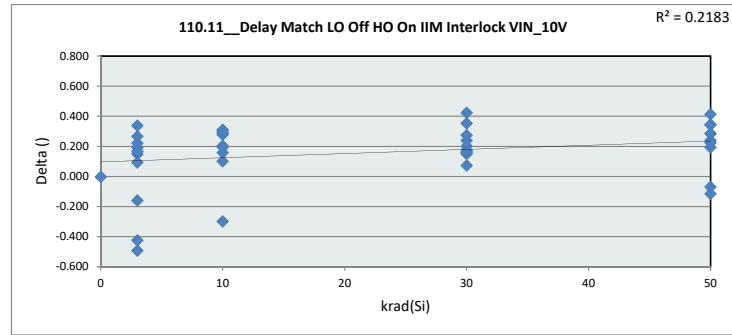

110.11 Delay Match	
Test Site	DAL-FL
Tester	ETS364
Test Number	EB672302
Max Limit	4
Min Limit	

krad(Si)	0	3	10	30	50	100
LL						
Min	1.306	0.871	0.879	0.782	0.785	1.194
Average	1.306	1.074	1.215	1.212	1.162	1.398
Max	1.306	1.492	1.679	1.553	1.566	1.729
UL	4.000	4.000	4.000	4.000	4.000	4.000

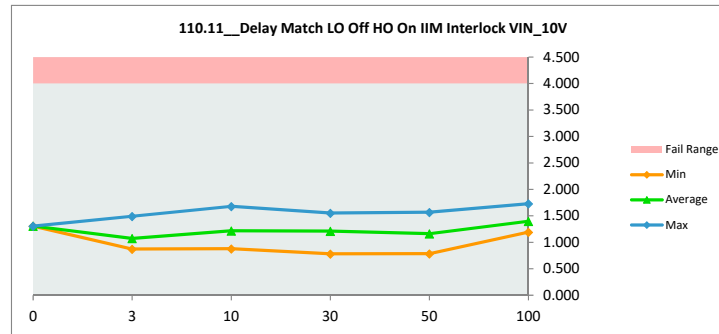

TID HDR Report
TPS7H6003-SP (5962R2220101VXC)

110.12 Delay Match LO On HO		
Test Site	DAL-FL	DAL-FL
Tester	ETS364	ETS364
Test Number	EB672302	EB672302
Unit	nsec	
Max Limit	12	12
Min Limit		

krad(Si)	Serial #	pre_short (rtp)	(2)'ST_Combo (rpt)	Delta
0	Ctrl	5.625	5.625	0.000
3	58	5.714	5.708	-0.005
3	59	5.449	5.337	-0.113
3	60	5.235	5.136	-0.099
3	61	6.068	6.196	0.129
3	62	5.958	6.108	0.150
3	134	5.555	5.579	0.024
3	137	5.634	5.720	0.086
3	138	5.867	5.681	-0.187
3	139	5.411	5.469	0.058
3	236	5.445	5.548	0.103
10	63	5.501	5.365	-0.136
10	64	5.808	5.643	-0.165
10	65	5.399	5.279	-0.120
10	66	6.196	6.234	0.037
10	150	5.295	5.161	-0.134
10	237	5.612	5.505	-0.107
10	241	5.328	5.669	0.340
10	242	5.512	5.604	0.091
10	243	6.061	5.942	-0.119
10	244	5.817	5.773	-0.043
30	141	5.358	5.316	-0.042
30	144	5.854	5.769	-0.085
30	145	5.949	6.045	0.096
30	146	5.792	5.636	-0.156
30	147	5.196	5.135	-0.061
30	132	5.937	5.788	-0.149
30	133	5.530	5.376	-0.153
30	135	5.433	6.316	0.883
30	245	5.666	5.662	-0.004
30	246	5.291	5.268	-0.022
50	67	5.507	5.421	-0.086
50	68	5.825	5.741	-0.084
50	69	5.496	5.527	0.031
50	71	6.181	6.329	0.147
50	72	5.445	5.347	-0.098
50	172	5.703	5.652	-0.052
50	173	5.680	5.516	-0.164
50	174	5.409	5.478	0.070
50	183	5.415	5.284	-0.131
50	186	6.139	6.106	-0.034
100	95	5.382	5.355	-0.026
100	102	5.791	5.491	-0.300
100	104	5.445	5.439	-0.006
100	105	5.915	5.777	-0.138
100	106	5.953	5.790	-0.163
100	178	5.570	5.405	-0.165
100	179	5.869	5.728	-0.141
100	180	5.604	5.510	-0.095
100	181	5.515	5.607	0.092
100	182	5.903	5.695	-0.208
	Max	6.196	6.329	0.883
	Average	5.652	5.623	-0.028
	Min	5.196	5.135	-0.300
	Std Dev	0.261	0.295	0.175

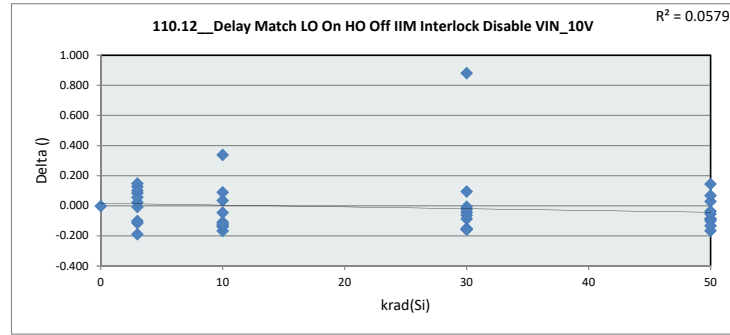

110.12 Delay Match						
Test Site	DAL-FL					
Tester	ETS364					
Test Number	EB672302					
Max Limit	12					
Min Limit						
krad(Si)	0	3	10	30	50	100
LL						
Min	5.625	5.136	5.161	5.135	5.284	5.355
Average	5.625	5.648	5.617	5.631	5.640	5.580
Max	5.625	6.196	6.234	6.316	6.329	5.790
UL	12.000	12.000	12.000	12.000	12.000	12.000

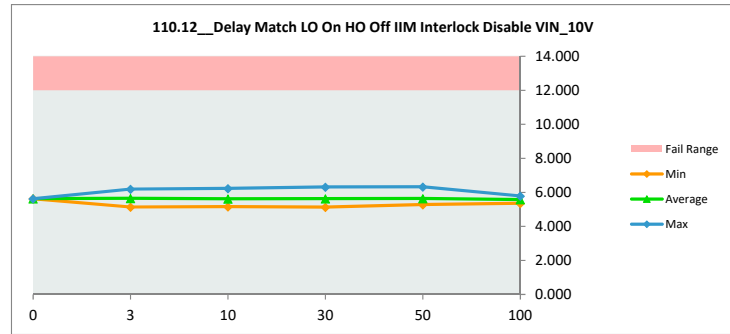

TID HDR Report
TPS7H6003-SP (5962R2220101VXC)

110.13 Delay Match LO Off HO		
Test Site	DAL-FL	DAL-FL
Tester	ETS364	ETS364
Test Number	EB672302	EB672302
Unit	nsec	
Max Limit	4	4
Min Limit		

krad(Si)	Serial #	pre_short (rtp)	(2)ST_Combo (rpt)	Delta
0	Ctrl	1.402	1.402	0.000
3	58	0.935	1.213	0.277
3	59	1.152	1.428	0.276
3	60	1.265	1.361	0.096
3	61	0.816	0.976	0.160
3	62	0.728	0.868	0.140
3	134	1.301	1.050	-0.251
3	137	1.056	0.934	-0.122
3	138	0.749	0.918	0.169
3	139	0.877	1.045	0.168
3	236	1.423	1.097	-0.326
10	63	1.010	1.275	0.264
10	64	0.998	1.227	0.229
10	65	0.919	1.289	0.370
10	66	0.762	0.927	0.165
10	150	1.411	1.592	0.180
10	237	0.882	1.070	0.188
10	241	1.114	0.955	-0.158
10	242	1.361	1.420	0.059
10	243	0.874	1.120	0.246
10	244	0.850	1.114	0.264
30	141	1.202	1.524	0.322
30	144	0.948	1.261	0.313
30	145	0.557	0.738	0.181
30	146	1.138	1.440	0.301
30	147	1.059	1.357	0.298
30	132	0.893	1.052	0.159
30	133	0.989	1.241	0.252
30	135	0.811	0.869	0.059
30	245	0.897	1.045	0.148
30	246	1.267	1.466	0.199
50	67	0.803	1.277	0.474
50	68	1.267	1.227	-0.040
50	69	0.960	1.289	0.329
50	71	0.504	0.902	0.398
50	72	1.278	1.559	0.281
50	172	0.634	0.911	0.277
50	173	0.807	1.137	0.331
50	174	1.369	1.392	0.023
50	183	1.355	1.619	0.263
50	186	0.561	0.794	0.233
100	95	0.970	1.254	0.284
100	102	1.173	1.689	0.516
100	104	1.053	1.449	0.396
100	105	0.995	1.225	0.230
100	106	0.883	1.590	0.707
100	178	1.007	1.350	0.343
100	179	1.100	1.465	0.366
100	180	1.090	1.545	0.455
100	181	1.048	1.533	0.486
100	182	0.889	1.366	0.477
	Max	1.423	1.689	0.707
	Average	1.008	1.232	0.225
	Min	0.504	0.738	-0.326
	Std Dev	0.231	0.243	0.191

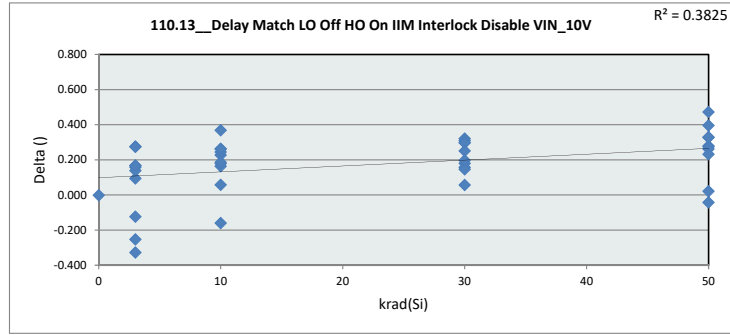

110.13 Delay Match	
Test Site	DAL-FL
Tester	ETS364
Test Number	EB672302
Max Limit	4
Min Limit	

krad(Si)	0	3	10	30	50	100
LL						
Min	1.402	0.868	0.927	0.738	0.794	1.225
Average	1.402	1.089	1.199	1.199	1.211	1.447
Max	1.402	1.428	1.592	1.524	1.619	1.689
UL	4.000	4.000	4.000	4.000	4.000	4.000

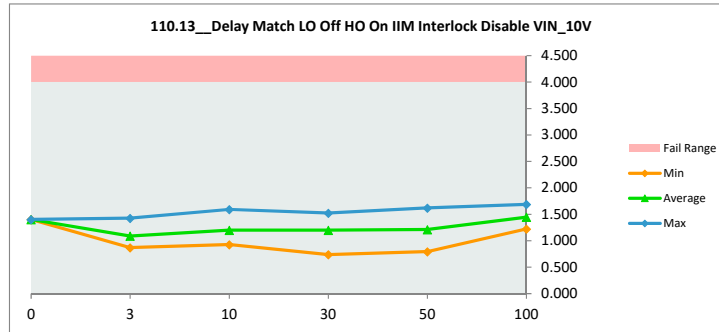

TID HDR Report
TPS7H6003-SP (5962R2220101VXC)

111.0 Prop Delay LO Off PWM		
Test Site	DAL-FL	DAL-FL
Tester	ETS364	ETS364
Test Number	EB672302	EB672302
Unit	nsec	
Max Limit	48	
Min Limit	1	

krad(Si)	Serial #	pre_short (rtp)	(2)'ST_Combo (rpt) (Delta
0	Ctrl	30.854	30.854	0.000
3	58	30.433	30.453	0.020
3	59	30.561	30.319	-0.242
3	60	30.356	30.354	-0.002
3	61	30.451	30.309	-0.143
3	62	30.673	30.610	-0.063
3	134	31.065	30.233	-0.831
3	137	30.641	30.298	-0.343
3	138	30.760	30.226	-0.534
3	139	30.443	30.221	-0.222
3	236	30.753	29.922	-0.830
10	63	30.524	30.440	-0.084
10	64	30.822	30.538	-0.284
10	65	30.408	30.215	-0.193
10	66	30.263	30.058	-0.205
10	150	30.790	30.476	-0.313
10	237	30.410	29.901	-0.509
10	241	30.261	30.214	-0.047
10	242	30.646	30.348	-0.298
10	243	30.435	30.061	-0.375
10	244	30.260	30.052	-0.208
30	141	30.734	30.281	-0.452
30	144	30.896	30.400	-0.496
30	145	30.732	30.302	-0.430
30	146	30.492	30.096	-0.395
30	147	30.417	29.966	-0.452
30	132	31.069	30.599	-0.470
30	133	30.563	30.084	-0.479
30	135	30.149	30.281	0.132
30	245	30.640	30.265	-0.375
30	246	30.802	30.451	-0.350
50	67	30.334	29.899	-0.435
50	68	30.662	30.198	-0.464
50	69	30.781	30.250	-0.531
50	71	30.810	30.307	-0.504
50	72	30.345	29.810	-0.536
50	172	30.327	29.812	-0.515
50	173	30.503	30.061	-0.442
50	174	31.026	30.373	-0.653
50	183	30.912	30.501	-0.412
50	186	30.788	30.205	-0.583
100	95	30.529	29.671	-0.859
100	102	30.431	29.691	-0.740
100	104	30.345	29.453	-0.892
100	105	30.569	29.671	-0.898
100	106	30.639	29.885	-0.754
100	178	30.577	29.805	-0.773
100	179	30.915	30.078	-0.837
100	180	30.988	30.250	-0.738
100	181	30.670	29.890	-0.781
100	182	30.745	29.801	-0.944
	Max	31.069	30.854	0.132
	Average	30.612	30.165	-0.446
	Min	30.149	29.453	-0.944
	Std Dev	0.229	0.282	0.272

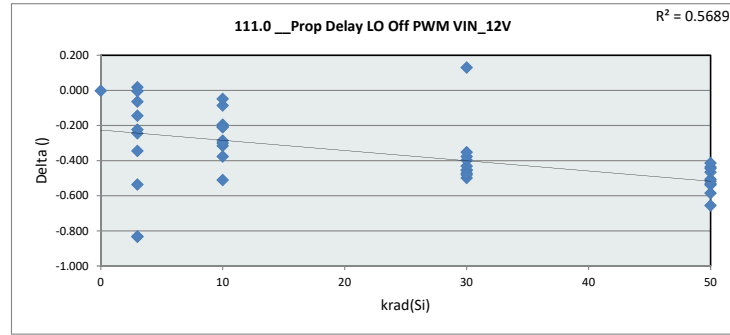

111.0 Prop Delay	
Test Site	DAL-FL
Tester	ETS364
Test Number	EB672302
Max Limit	48
Min Limit	1

krad(Si)	0	3	10	30	50	100
LL	1.000	1.000	1.000	1.000	1.000	1.000
Min	30.854	29.922	29.901	29.966	29.810	29.453
Average	30.854	30.295	30.230	30.273	30.141	29.819
Max	30.854	30.610	30.538	30.599	30.501	30.250
UL	48.000	48.000	48.000	48.000	48.000	48.000

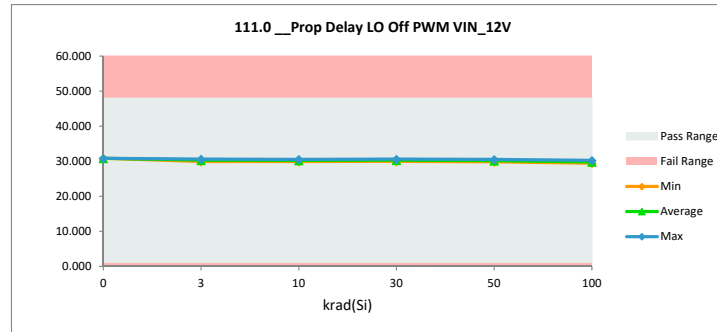

TID HDR Report
TPS7H6003-SP (5962R2220101VXC)

111.1 Prop Delay HO Off PWM		
Test Site	DAL-FL	DAL-FL
Tester	ETS364	ETS364
Test Number	EB672302	EB672302
Unit	nsec	
Max Limit	50	
Min Limit	1	

krad(Si)	Serial #	pre_short (rtp)	(2)'ST_Combo (rpt)	Delta
0	Ctrl	33.495	33.495	0.000
3	58	33.106	33.268	0.161
3	59	32.972	32.995	0.023
3	60	32.723	32.917	0.194
3	61	33.547	33.796	0.250
3	62	33.659	33.886	0.226
3	134	33.409	33.184	-0.225
3	137	33.339	33.149	-0.190
3	138	33.561	33.143	-0.418
3	139	33.000	32.975	-0.025
3	236	33.075	32.739	-0.336
10	63	33.178	33.238	0.060
10	64	33.570	33.547	-0.023
10	65	32.962	32.972	0.009
10	66	33.429	33.504	0.075
10	150	33.128	32.921	-0.208
10	237	33.039	32.776	-0.262
10	241	32.721	33.070	0.349
10	242	33.155	33.146	-0.009
10	243	33.530	33.395	-0.136
10	244	33.131	33.070	-0.061
30	141	33.121	32.875	-0.246
30	144	33.572	33.250	-0.321
30	145	33.625	33.619	-0.007
30	146	33.258	33.091	-0.167
30	147	32.752	32.505	-0.247
30	132	33.925	33.675	-0.251
30	133	33.042	32.804	-0.238
30	135	32.748	33.804	1.056
30	245	33.497	33.360	-0.137
30	246	32.939	32.848	-0.091
50	67	32.887	32.632	-0.255
50	68	33.360	33.209	-0.151
50	69	33.159	32.888	-0.271
50	71	33.948	33.878	-0.070
50	72	32.788	32.508	-0.280
50	172	33.261	32.964	-0.297
50	173	33.420	33.023	-0.397
50	174	33.314	33.105	-0.209
50	183	33.298	32.920	-0.378
50	186	33.922	33.632	-0.290
100	95	33.027	32.541	-0.486
100	102	33.185	32.462	-0.723
100	104	33.031	32.410	-0.621
100	105	33.409	32.933	-0.476
100	106	33.468	33.031	-0.437
100	178	33.012	32.409	-0.602
100	179	33.560	32.934	-0.626
100	180	33.426	32.890	-0.536
100	181	33.306	32.662	-0.644
100	182	33.625	32.793	-0.832
	Max	33.948	33.886	1.056
	Average	33.267	33.075	-0.192
	Min	32.721	32.409	-0.832
	Std Dev	0.311	0.386	0.314

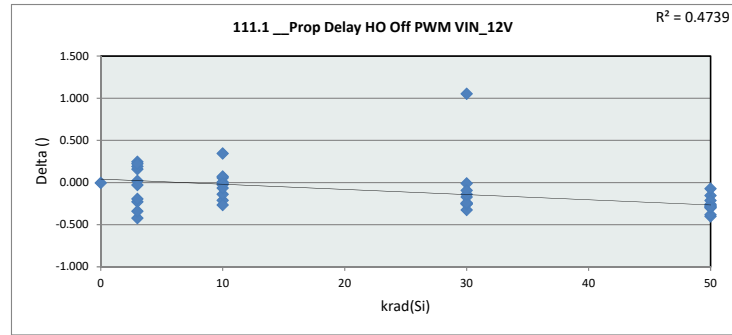

111.1 Prop Delay	
Test Site	DAL-FL
Tester	ETS364
Test Number	EB672302
Max Limit	50
Min Limit	1

krad(Si)	0	3	10	30	50	100
LL	1.000	1.000	1.000	1.000	1.000	1.000
Min	33.496	32.739	32.776	32.505	32.508	32.409
Average	33.496	33.205	33.164	33.183	33.076	32.706
Max	33.496	33.886	33.547	33.804	33.878	33.031
UL	50.000	50.000	50.000	50.000	50.000	50.000

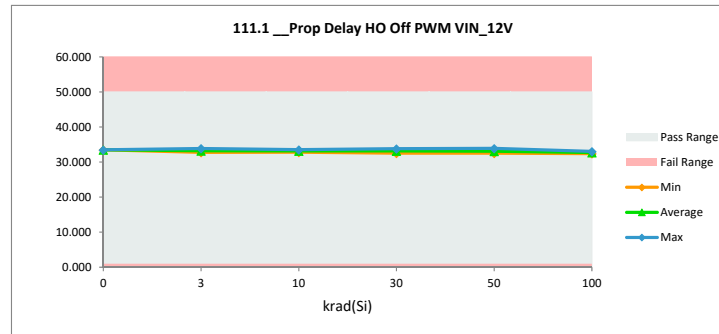

TID HDR Report
TPS7H6003-SP (5962R2220101VXC)

111.2 Prop Delay LO On IIM In		
Test Site	DAL-FL	DAL-FL
Tester	ETS364	ETS364
Test Number	EB672302	EB672302
Unit	nsec	
Max Limit	38	
Min Limit	1	

krad(Si)	Serial #	pre_short (rtp) (2)	ST_Combo (rpt) (Delta
0	Ctrl	23.205	23.205	0.000
3	58	23.258	23.184	-0.074
3	59	23.500	23.344	-0.155
3	60	23.230	23.194	-0.035
3	61	23.260	23.176	-0.083
3	62	23.317	23.196	-0.121
3	134	23.480	23.335	-0.145
3	137	23.544	23.266	-0.277
3	138	23.437	23.284	-0.153
3	139	23.372	23.256	-0.117
3	236	23.278	22.958	-0.320
10	63	23.365	23.269	-0.096
10	64	23.451	23.248	-0.203
10	65	23.297	23.256	-0.042
10	66	23.035	22.988	-0.047
10	150	23.628	23.462	-0.166
10	237	23.382	22.998	-0.384
10	241	23.235	23.287	0.052
10	242	23.313	23.051	-0.262
10	243	23.137	22.941	-0.196
10	244	23.200	23.116	-0.084
30	141	23.395	23.159	-0.236
30	144	23.526	23.193	-0.333
30	145	23.367	23.115	-0.252
30	146	23.276	23.073	-0.203
30	147	23.322	23.077	-0.246
30	132	23.567	23.306	-0.261
30	133	23.242	23.056	-0.186
30	135	23.175	23.223	0.049
30	245	23.448	23.173	-0.275
30	246	23.352	23.196	-0.156
50	67	23.284	23.044	-0.240
50	68	23.189	23.143	-0.046
50	69	23.325	23.021	-0.304
50	71	23.390	23.137	-0.253
50	72	23.170	22.906	-0.264
50	172	23.398	23.082	-0.316
50	173	23.438	23.128	-0.310
50	174	23.438	23.102	-0.336
50	183	23.526	23.183	-0.343
50	186	23.456	23.122	-0.335
100	95	23.440	22.953	-0.486
100	102	23.229	22.817	-0.412
100	104	23.357	22.824	-0.533
100	105	23.180	22.763	-0.418
100	106	23.303	22.972	-0.331
100	178	23.277	22.896	-0.380
100	179	23.499	23.090	-0.410
100	180	23.502	23.147	-0.355
100	181	23.403	23.056	-0.346
100	182	23.274	22.784	-0.489
	Max	23.628	23.462	0.052
	Average	23.346	23.113	-0.234
	Min	23.035	22.763	-0.533
	Std Dev	0.126	0.151	0.140

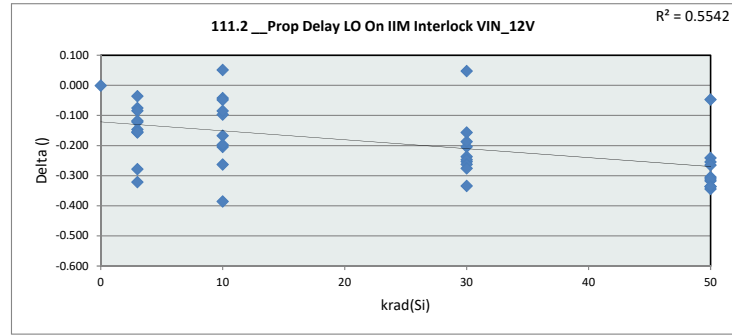

111.2 Prop Delay	
Test Site	DAL-FL
Tester	ETS364
Test Number	EB672302
Max Limit	38
Min Limit	1

krad(Si)	0	3	10	30	50	100
LL	1.000	1.000	1.000	1.000	1.000	1.000
Min	23.205	22.958	22.941	23.056	22.906	22.763
Average	23.205	23.219	23.162	23.157	23.087	22.930
Max	23.205	23.344	23.462	23.306	23.183	23.147
UL	38.000	38.000	38.000	38.000	38.000	38.000

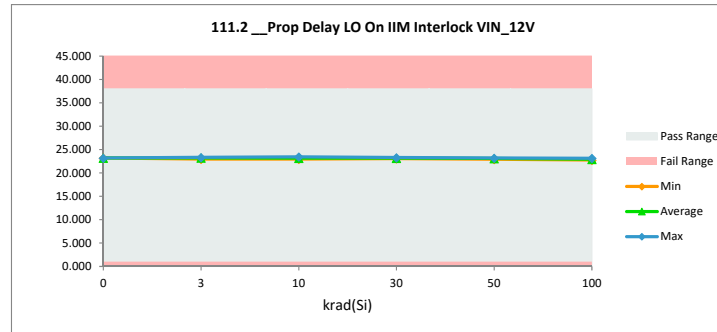

TID HDR Report
TPS7H6003-SP (5962R2220101VXC)

111.3 Prop Delay LO Off IIM I		
Test Site	DAL-FL	DAL-FL
Tester	ETS364	ETS364
Test Number	EB672302	EB672302
Unit	nsec	
Max Limit	38	
Min Limit	1	

krad(Si)	Serial #	pre_short (rtp) (2)	ST_Combo (rpt) (Delta
0	Ctrl	27.681	27.681	0.000
3	58	27.357	27.474	0.117
3	59	27.602	27.553	-0.049
3	60	27.257	27.375	0.118
3	61	27.418	27.425	0.007
3	62	27.376	27.484	0.108
3	134	27.789	27.383	-0.406
3	137	27.616	27.441	-0.175
3	138	27.581	27.410	-0.171
3	139	27.304	27.257	-0.047
3	236	27.490	27.117	-0.372
10	63	27.348	27.407	0.059
10	64	27.533	27.384	-0.150
10	65	27.241	27.259	0.019
10	66	27.217	27.105	-0.112
10	150	27.704	27.599	-0.104
10	237	27.427	27.019	-0.408
10	241	27.243	27.498	0.255
10	242	27.467	27.363	-0.104
10	243	27.187	26.980	-0.207
10	244	27.219	27.184	-0.034
30	141	27.502	27.256	-0.245
30	144	27.727	27.493	-0.234
30	145	27.509	27.372	-0.136
30	146	27.406	27.371	-0.036
30	147	27.291	27.163	-0.128
30	132	27.804	27.551	-0.252
30	133	27.423	27.181	-0.243
30	135	27.114	27.370	0.257
30	245	27.410	27.238	-0.172
30	246	27.518	27.350	-0.168
50	67	27.267	27.126	-0.141
50	68	27.379	27.417	0.038
50	69	27.515	27.348	-0.167
50	71	27.456	27.345	-0.111
50	72	27.292	27.090	-0.202
50	172	27.319	27.080	-0.238
50	173	27.295	27.197	-0.098
50	174	27.734	27.373	-0.361
50	183	27.707	27.549	-0.158
50	186	27.541	27.335	-0.206
100	95	27.469	27.198	-0.271
100	102	27.386	27.133	-0.253
100	104	27.273	26.881	-0.392
100	105	27.290	26.945	-0.345
100	106	27.487	27.344	-0.143
100	178	27.463	27.165	-0.299
100	179	27.731	27.569	-0.162
100	180	27.773	27.522	-0.251
100	181	27.485	27.172	-0.313
100	182	27.472	27.056	-0.415
	Max	27.804	27.681	0.257
	Average	27.453	27.306	-0.147
	Min	27.114	26.881	-0.415
	Std Dev	0.175	0.184	0.160

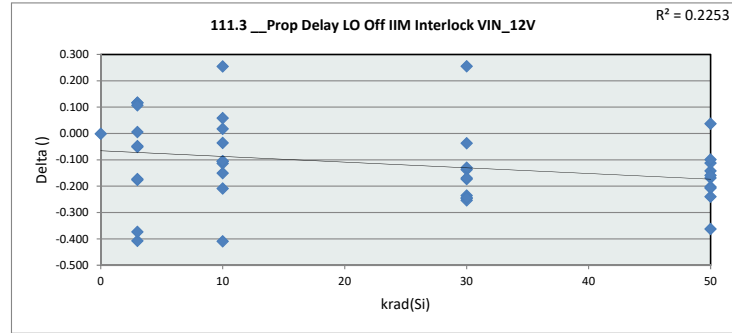

111.3 Prop Delay						
Test Site	DAL-FL					
Tester	ETS364					
Test Number	EB672302					
Max Limit	38					
Min Limit	1					
krad(Si)	0	3	10	30	50	100
LL	1.000	1.000	1.000	1.000	1.000	1.000
Min	27.681	27.117	26.980	27.163	27.080	26.881
Average	27.681	27.392	27.280	27.334	27.286	27.198
Max	27.681	27.553	27.599	27.551	27.549	27.569
UL	38.000	38.000	38.000	38.000	38.000	38.000

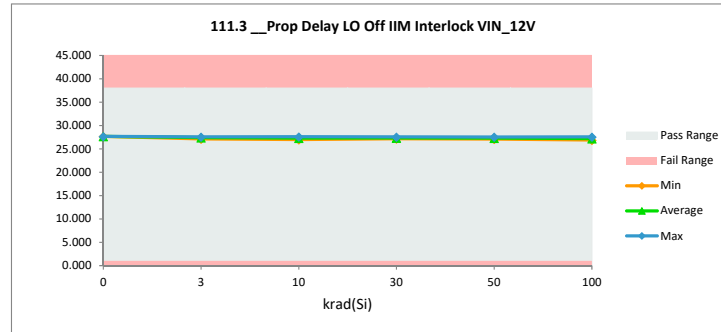

TID HDR Report
TPS7H6003-SP (5962R2220101VXC)

111.4 Prop Delay HO On IIM I		
Test Site	DAL-FL	DAL-FL
Tester	ETS364	ETS364
Test Number	EB672302	EB672302
Unit	nsec	
Max Limit	40	40
Min Limit	1	1

krad(Si)	Serial #	pre_short (rtp)	(2)'ST_Combo (rpt)	Delta
0	Ctrl	26.282	26.282	0.000
3	58	26.374	26.260	-0.115
3	59	26.438	26.189	-0.249
3	60	26.006	25.834	-0.172
3	61	26.612	26.464	-0.148
3	62	26.628	26.581	-0.047
3	134	26.470	26.471	0.001
3	137	26.614	26.483	-0.131
3	138	26.886	26.476	-0.410
3	139	26.427	26.149	-0.279
3	236	26.065	26.071	0.006
10	63	26.372	26.098	-0.274
10	64	26.527	26.182	-0.345
10	65	26.320	26.025	-0.295
10	66	26.401	26.204	-0.197
10	150	26.303	25.986	-0.317
10	237	26.515	26.051	-0.465
10	241	26.105	26.448	0.343
10	242	26.096	25.814	-0.282
10	243	26.362	26.043	-0.319
10	244	26.389	26.100	-0.289
30	141	26.261	25.831	-0.430
30	144	26.745	26.266	-0.479
30	145	26.914	26.598	-0.316
30	146	26.302	25.883	-0.419
30	147	26.167	25.756	-0.411
30	132	26.916	26.587	-0.329
30	133	26.447	26.030	-0.418
30	135	26.287	26.652	0.364
30	245	26.544	26.178	-0.366
30	246	26.298	25.901	-0.397
50	67	26.516	26.040	-0.476
50	68	26.118	26.196	0.078
50	69	26.580	26.087	-0.493
50	71	26.931	26.425	-0.506
50	72	26.017	25.521	-0.497
50	172	26.696	26.212	-0.483
50	173	26.476	25.973	-0.503
50	174	26.334	26.067	-0.266
50	183	26.402	25.851	-0.550
50	186	27.000	26.447	-0.552
100	95	26.483	25.852	-0.632
100	102	26.192	25.468	-0.724
100	104	26.190	25.485	-0.705
100	105	26.291	25.710	-0.581
100	106	26.575	25.921	-0.654
100	178	26.483	25.815	-0.668
100	179	26.656	25.922	-0.734
100	180	26.665	26.084	-0.581
100	181	26.389	25.792	-0.597
100	182	26.508	25.731	-0.777
	Max	27.000	26.652	0.364
	Average	26.443	26.088	-0.355
	Min	26.006	25.468	-0.777
	Std Dev	0.240	0.293	0.252

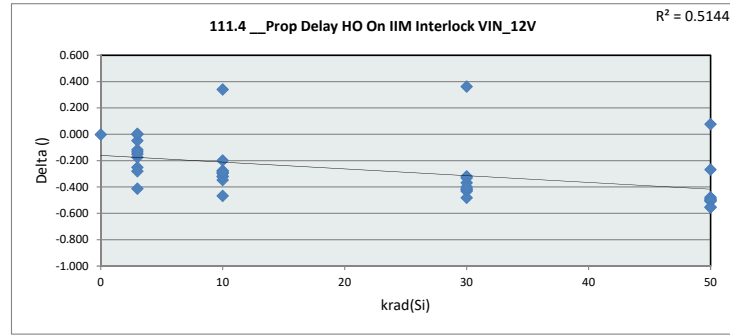

111.4 Prop Delay

Test Site	DAL-FL
Tester	ETS364
Test Number	EB672302
Max Limit	40
Min Limit	1

krad(Si)	0	3	10	30	50	100
LL	1.000	1.000	1.000	1.000	1.000	1.000
Min	26.282	25.834	25.814	25.756	25.521	25.468
Average	26.282	26.298	26.095	26.168	26.082	25.778
Max	26.282	26.581	26.448	26.652	26.447	26.084
UL	40.000	40.000	40.000	40.000	40.000	40.000

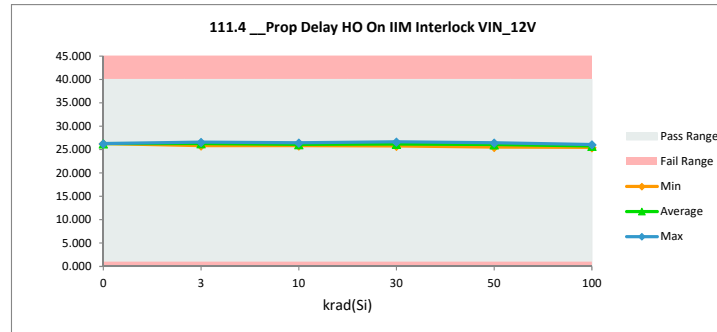

TID HDR Report
TPS7H6003-SP (5962R2220101VXC)

111.5 Prop Delay HO Off IIM I		
Test Site	DAL-FL	DAL-FL
Tester	ETS364	ETS364
Test Number	EB672302	EB672302
Unit	nsec	
Max Limit	40	
Min Limit	1	

krad(Si)	Serial #	pre_short (rtp)	(2)ST_Combo (rpt)	Delta
0	Ctrl	28.361	28.361	0.000
3	58	28.355	28.463	0.108
3	59	28.357	28.283	-0.074
3	60	27.897	27.866	-0.031
3	61	28.762	28.710	-0.052
3	62	28.729	28.708	-0.021
3	134	28.490	28.446	-0.044
3	137	28.593	28.457	-0.136
3	138	28.735	28.371	-0.364
3	139	28.235	28.114	-0.121
3	236	28.128	27.902	-0.226
10	63	28.282	28.194	-0.088
10	64	28.707	28.454	-0.253
10	65	28.134	27.951	-0.183
10	66	28.682	28.575	-0.107
10	150	28.373	28.040	-0.333
10	237	28.383	27.901	-0.482
10	241	28.040	28.417	0.377
10	242	28.258	28.173	-0.085
10	243	28.624	28.406	-0.218
10	244	28.440	28.246	-0.194
30	141	28.231	27.930	-0.301
30	144	28.784	28.419	-0.364
30	145	28.782	28.664	-0.118
30	146	28.512	28.195	-0.316
30	147	28.007	27.673	-0.334
30	132	28.969	28.603	-0.366
30	133	28.284	27.900	-0.384
30	135	28.079	28.996	0.917
30	245	28.547	28.265	-0.282
30	246	28.083	27.792	-0.291
50	67	28.217	27.921	-0.296
50	68	28.480	28.368	-0.111
50	69	28.275	27.984	-0.292
50	71	29.025	28.840	-0.185
50	72	28.060	27.790	-0.270
50	172	28.581	28.215	-0.366
50	173	28.519	28.218	-0.302
50	174	28.338	28.131	-0.207
50	183	28.402	27.993	-0.410
50	186	29.027	28.727	-0.300
100	95	28.298	27.906	-0.392
100	102	28.469	27.770	-0.699
100	104	28.248	27.739	-0.510
100	105	28.482	28.091	-0.391
100	106	28.637	28.326	-0.311
100	178	28.314	27.884	-0.430
100	179	28.745	28.316	-0.429
100	180	28.533	28.165	-0.368
100	181	28.353	27.988	-0.365
100	182	28.674	27.989	-0.684
Max		29.027	28.996	0.917
Average		28.442	28.212	-0.229
Min		27.897	27.673	-0.699
Std Dev		0.265	0.313	0.248

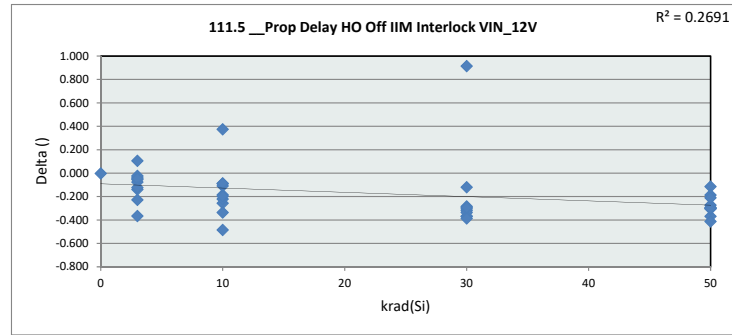

111.5 Prop Delay	
Test Site	DAL-FL
Tester	ETS364
Test Number	EB672302
Max Limit	40
Min Limit	1

krad(Si)	0	3	10	30	50	100
LL	1.000	1.000	1.000	1.000	1.000	1.000
Min	28.361	27.866	27.901	27.673	27.790	27.739
Average	28.361	28.332	28.236	28.244	28.219	28.017
Max	28.361	28.710	28.575	28.996	28.840	28.326
UL	40.000	40.000	40.000	40.000	40.000	40.000

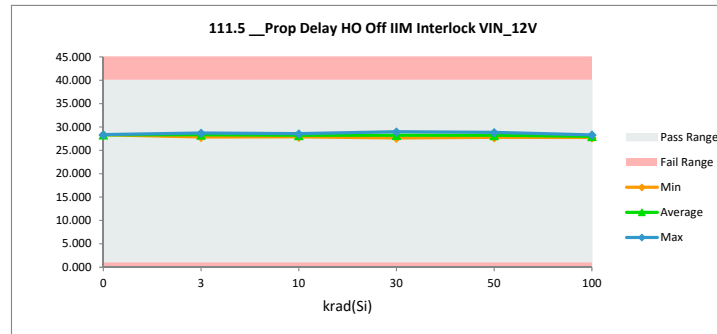

TID HDR Report
TPS7H6003-SP (5962R2220101VXC)

111.6 Prop Delay LO On IIM In		
Test Site	DAL-FL	DAL-FL
Tester	ETS364	ETS364
Test Number	EB672302	EB672302
Unit	nsec	
Max Limit	38	
Min Limit	1	

krad(Si)	Serial #	pre_short (rtp)	(2)'ST_Combo (rpt)	Delta
0	Ctrl	23.277	23.277	0.000
3	58	23.230	23.245	0.014
3	59	23.440	23.350	-0.090
3	60	23.200	23.156	-0.044
3	61	23.235	23.140	-0.095
3	62	23.285	23.259	-0.026
3	134	23.469	23.338	-0.130
3	137	23.490	23.258	-0.232
3	138	23.424	23.297	-0.127
3	139	23.311	23.143	-0.168
3	236	23.237	22.959	-0.278
10	63	23.364	23.202	-0.162
10	64	23.435	23.307	-0.128
10	65	23.279	23.180	-0.100
10	66	23.020	22.906	-0.115
10	150	23.602	23.453	-0.149
10	237	23.348	22.925	-0.423
10	241	23.205	23.319	0.114
10	242	23.265	23.042	-0.223
10	243	23.097	22.982	-0.114
10	244	23.191	23.096	-0.096
30	141	23.348	23.122	-0.226
30	144	23.476	23.247	-0.229
30	145	23.318	23.049	-0.269
30	146	23.214	22.975	-0.239
30	147	23.301	22.991	-0.310
30	132	23.538	23.313	-0.225
30	133	23.237	22.987	-0.250
30	135	23.145	23.163	0.018
30	245	23.417	23.281	-0.135
30	246	23.327	23.116	-0.211
50	67	23.233	22.962	-0.271
50	68	23.174	23.106	-0.068
50	69	23.277	22.974	-0.303
50	71	23.357	23.124	-0.233
50	72	23.113	22.901	-0.212
50	172	23.336	23.029	-0.307
50	173	23.392	23.156	-0.236
50	174	23.394	23.124	-0.270
50	183	23.478	23.204	-0.275
50	186	23.411	23.124	-0.288
100	95	23.402	22.996	-0.405
100	102	23.177	22.751	-0.426
100	104	23.312	22.809	-0.503
100	105	23.142	22.720	-0.422
100	106	23.263	22.994	-0.269
100	178	23.255	22.850	-0.405
100	179	23.478	23.028	-0.451
100	180	23.457	23.207	-0.250
100	181	23.382	23.036	-0.345
100	182	23.267	22.829	-0.439
Max		23.602	23.453	0.114
Average		23.314	23.098	-0.216
Min		23.020	22.720	-0.503
Std Dev		0.123	0.166	0.136

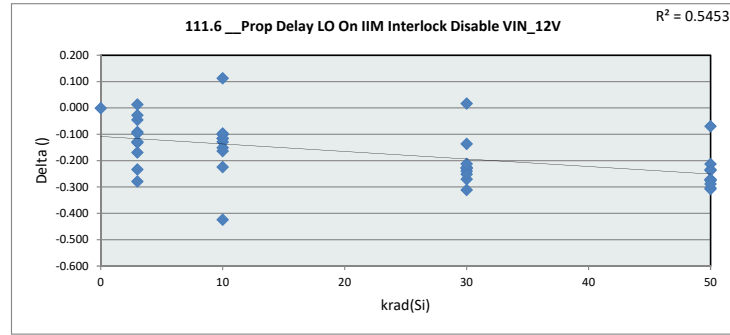

111.6 Prop Delay						
Test Site	DAL-FL					
Tester	ETS364					
Test Number	EB672302					
Max Limit	38					
Min Limit	1					
krad(Si)	0	3	10	30	50	100
LL	1.000	1.000	1.000	1.000	1.000	1.000
Min	23.277	22.959	22.906	22.975	22.901	22.720
Average	23.277	23.214	23.141	23.124	23.070	22.922
Max	23.277	23.350	23.453	23.313	23.204	23.207
UL	38.000	38.000	38.000	38.000	38.000	38.000

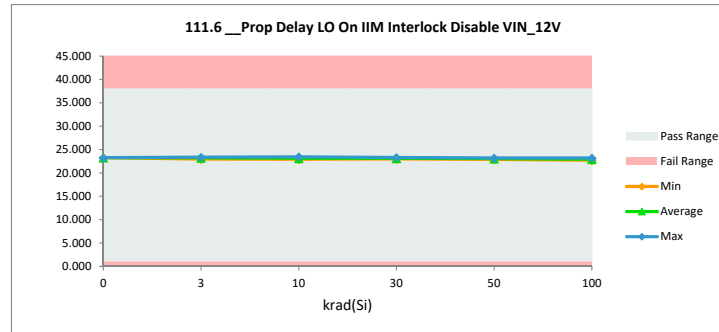

TID HDR Report
TPS7H6003-SP (5962R2220101VXC)

111.7 Prop Delay LO Off IIM I		
Test Site	DAL-FL	DAL-FL
Tester	ETS364	ETS364
Test Number	EB672302	EB672302
Unit	nsec	
Max Limit	38	
Min Limit	1	

krad(Si)	Serial #	pre_short (rtp) (2)	ST_Combo (rpt) (Delta
0	Ctrl	27.412	27.412	0.000
3	58	27.219	27.346	0.128
3	59	27.500	27.420	-0.080
3	60	27.164	27.264	0.100
3	61	27.299	27.365	0.067
3	62	27.266	27.350	0.084
3	134	27.663	27.229	-0.434
3	137	27.485	27.319	-0.166
3	138	27.460	27.256	-0.205
3	139	27.185	27.158	-0.027
3	236	27.369	27.074	-0.295
10	63	27.246	27.247	0.002
10	64	27.423	27.283	-0.139
10	65	27.125	27.015	-0.110
10	66	27.095	26.950	-0.145
10	150	27.599	27.512	-0.087
10	237	27.283	27.033	-0.251
10	241	27.114	27.372	0.257
10	242	27.333	27.229	-0.104
10	243	27.072	26.924	-0.147
10	244	27.084	27.100	0.016
30	141	27.366	27.213	-0.154
30	144	27.600	27.343	-0.256
30	145	27.410	27.221	-0.189
30	146	27.288	27.159	-0.130
30	147	27.174	26.955	-0.219
30	132	27.652	27.496	-0.155
30	133	27.287	27.143	-0.144
30	135	26.973	27.214	0.241
30	245	27.306	27.094	-0.212
30	246	27.426	27.315	-0.111
50	67	27.176	27.131	-0.045
50	68	27.240	27.235	-0.005
50	69	27.406	27.096	-0.310
50	71	27.341	27.101	-0.240
50	72	27.199	27.013	-0.186
50	172	27.192	26.919	-0.273
50	173	27.191	27.076	-0.115
50	174	27.582	27.213	-0.369
50	183	27.589	27.485	-0.104
50	186	27.449	27.277	-0.172
100	95	27.387	26.958	-0.429
100	102	27.239	26.894	-0.345
100	104	27.131	26.745	-0.387
100	105	27.205	26.827	-0.378
100	106	27.367	27.146	-0.221
100	178	27.355	26.951	-0.405
100	179	27.633	27.436	-0.197
100	180	27.636	27.383	-0.253
100	181	27.386	27.041	-0.344
100	182	27.316	26.876	-0.439
	Max	27.663	27.512	0.257
	Average	27.331	27.173	-0.158
	Min	26.973	26.745	-0.439
	Std Dev	0.171	0.186	0.165

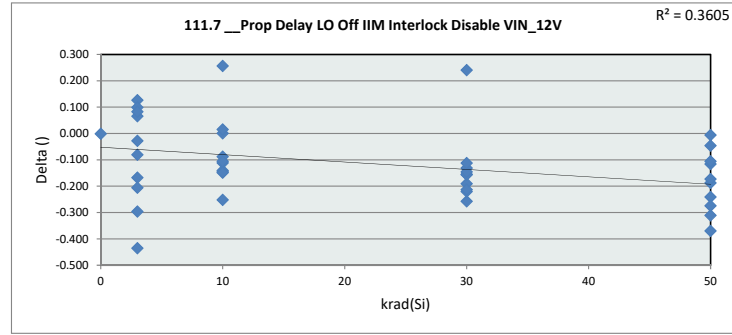

111.7 Prop Delay	
Test Site	DAL-FL
Tester	ETS364
Test Number	EB672302
Max Limit	38
Min Limit	1

krad(Si)	0	3	10	30	50	100
LL	1.000	1.000	1.000	1.000	1.000	1.000
Min	27.412	27.074	26.924	26.955	26.919	26.745
Average	27.412	27.278	27.167	27.215	27.155	27.026
Max	27.412	27.420	27.512	27.496	27.485	27.436
UL	38.000	38.000	38.000	38.000	38.000	38.000

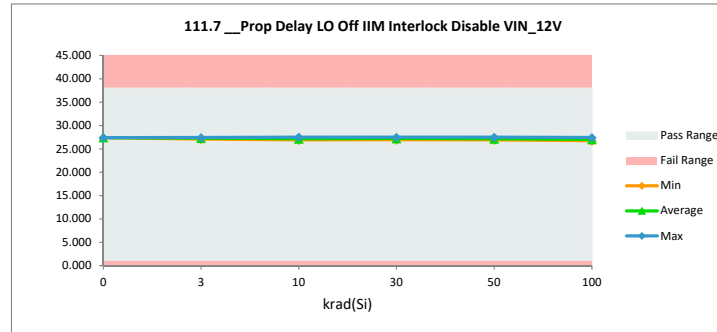

TID HDR Report
TPS7H6003-SP (5962R2220101VXC)

111.8 Prop Delay HO On IIM I		
Test Site	DAL-FL	DAL-FL
Tester	ETS364	ETS364
Test Number	EB672302	EB672302
Unit	nsec	
Max Limit	40	
Min Limit	1	

krad(Si)	Serial #	pre_short (rtp) (2)	ST_Combo (rpt) (Delta
0	Ctrl	26.115	26.115	0.000
3	58	26.280	26.136	-0.144
3	59	26.324	26.140	-0.184
3	60	25.867	25.667	-0.200
3	61	26.500	26.406	-0.094
3	62	26.523	26.350	-0.173
3	134	26.372	26.401	0.029
3	137	26.453	26.358	-0.095
3	138	26.701	26.320	-0.382
3	139	26.267	26.053	-0.214
3	236	25.950	25.949	0.000
10	63	26.249	26.038	-0.211
10	64	26.396	26.104	-0.292
10	65	26.197	25.889	-0.308
10	66	26.316	25.967	-0.350
10	150	26.176	25.803	-0.373
10	237	26.389	25.910	-0.479
10	241	25.978	26.323	0.345
10	242	25.945	25.716	-0.229
10	243	26.235	25.934	-0.301
10	244	26.244	26.005	-0.239
30	141	26.136	25.786	-0.350
30	144	26.658	26.148	-0.510
30	145	26.831	26.467	-0.365
30	146	26.174	25.678	-0.496
30	147	26.049	25.615	-0.434
30	132	26.820	26.403	-0.417
30	133	26.323	25.912	-0.410
30	135	26.157	26.487	0.329
30	245	26.388	25.958	-0.430
30	246	26.197	25.712	-0.485
50	67	26.425	25.953	-0.472
50	68	26.003	26.015	0.012
50	69	26.433	25.938	-0.495
50	71	26.817	26.328	-0.489
50	72	25.903	25.384	-0.519
50	172	26.570	26.124	-0.446
50	173	26.333	25.829	-0.504
50	174	26.242	25.870	-0.371
50	183	26.276	25.720	-0.556
50	186	26.869	26.386	-0.483
100	95	26.359	25.710	-0.650
100	102	26.060	25.340	-0.720
100	104	26.108	25.299	-0.810
100	105	26.197	25.583	-0.614
100	106	26.429	25.733	-0.696
100	178	26.372	25.688	-0.684
100	179	26.561	25.796	-0.765
100	180	26.530	25.852	-0.678
100	181	26.304	25.654	-0.650
100	182	26.396	25.589	-0.807
	Max	26.869	26.487	0.345
	Average	26.322	25.952	-0.370
	Min	25.867	25.299	-0.810
	Std Dev	0.242	0.300	0.260

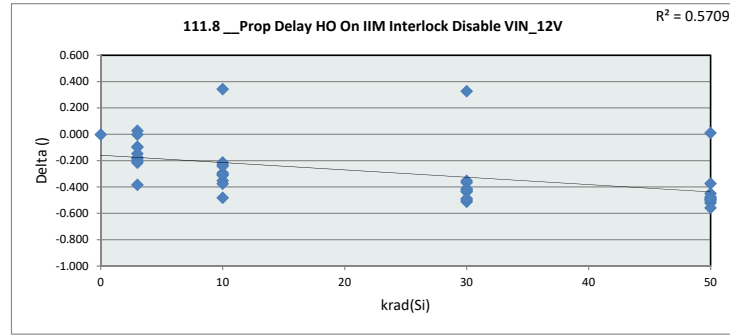

111.8 Prop Delay	
Test Site	DAL-FL
Tester	ETS364
Test Number	EB672302
Max Limit	40
Min Limit	1

krad(Si)	0	3	10	30	50	100
LL	1.000	1.000	1.000	1.000	1.000	1.000
Min	26.115	25.667	25.716	25.615	25.384	25.299
Average	26.115	26.178	25.969	26.017	25.955	25.624
Max	26.115	26.406	26.323	26.487	26.386	25.852
UL	40.000	40.000	40.000	40.000	40.000	40.000

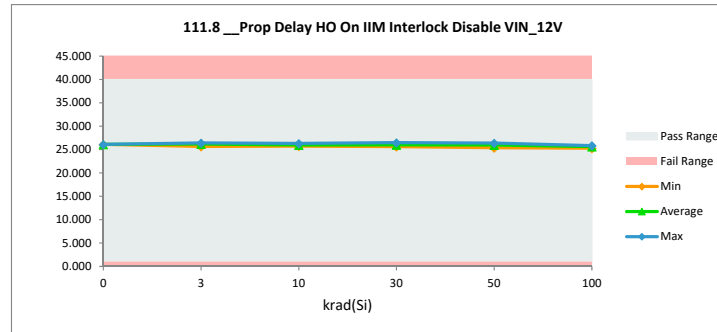

TID HDR Report

TPS7H6003-SP (5962R2220101VXC)

111.9 Prop Delay HO Off IIM I		
Test Site	DAL-FL	DAL-FL
Tester	ETS364	ETS364
Test Number	EB672302	EB672302
Unit	nsec	
Max Limit	40	
Min Limit	1	

krad(Si)	Serial #	pre_short (rtp) (2)	ST_Combo (rpt) (Delta
0	Ctrl	28.854	28.854	0.000
3	58	28.941	29.008	0.067
3	59	28.899	28.827	-0.072
3	60	28.421	28.371	-0.050
3	61	29.302	29.286	-0.016
3	62	29.239	29.208	-0.030
3	134	29.039	28.909	-0.129
3	137	29.116	28.995	-0.122
3	138	29.261	28.999	-0.262
3	139	28.741	28.589	-0.151
3	236	28.662	28.385	-0.278
10	63	28.820	28.740	-0.080
10	64	29.210	28.956	-0.254
10	65	28.660	28.564	-0.096
10	66	29.195	29.119	-0.076
10	150	28.909	28.590	-0.319
10	237	28.959	28.424	-0.535
10	241	28.545	28.913	0.368
10	242	28.792	28.736	-0.056
10	243	29.197	28.880	-0.317
10	244	28.952	28.798	-0.154
30	141	28.758	28.499	-0.259
30	144	29.302	28.910	-0.391
30	145	29.287	29.137	-0.150
30	146	29.006	28.753	-0.253
30	147	28.491	28.194	-0.297
30	132	29.434	29.200	-0.234
30	133	28.790	28.376	-0.414
30	135	28.595	29.544	0.949
30	245	29.082	28.882	-0.200
30	246	28.584	28.346	-0.238
50	67	28.761	28.427	-0.334
50	68	28.985	28.880	-0.105
50	69	28.818	28.462	-0.356
50	71	29.575	29.440	-0.135
50	72	28.584	28.271	-0.313
50	172	29.092	28.786	-0.307
50	173	29.060	28.664	-0.396
50	174	28.851	28.637	-0.214
50	183	28.958	28.563	-0.394
50	186	29.595	29.229	-0.366
100	95	28.832	28.445	-0.387
100	102	28.985	28.309	-0.676
100	104	28.783	28.326	-0.456
100	105	28.983	28.582	-0.401
100	106	29.223	28.806	-0.418
100	178	28.810	28.330	-0.480
100	179	29.327	28.754	-0.573
100	180	29.052	28.697	-0.355
100	181	28.907	28.464	-0.443
100	182	29.212	28.517	-0.694
	Max	29.595	29.544	0.949
	Average	28.969	28.737	-0.232
	Min	28.421	28.194	-0.694
	Std Dev	0.270	0.320	0.256

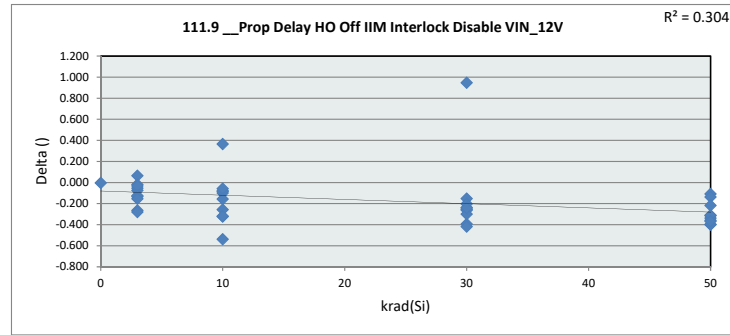

111.9 Prop Delay						
Test Site	DAL-FL					
Tester	ETS364					
Test Number	EB672302					
Max Limit	40					
Min Limit	1					
krad(Si)	0	3	10	30	50	100
LL	1.000	1.000	1.000	1.000	1.000	1.000
Min	28.854	28.371	28.424	28.194	28.271	28.309
Average	28.854	28.858	28.772	28.784	28.736	28.523
Max	28.854	29.286	29.119	29.544	29.440	28.806
UL	40.000	40.000	40.000	40.000	40.000	40.000

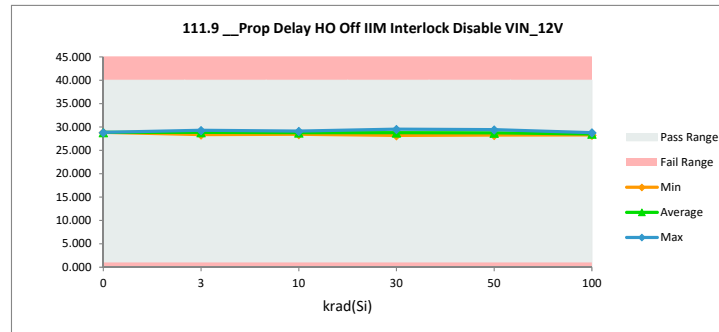

TID HDR Report
TPS7H6003-SP (5962R2220101VXC)

111.10 Delay Match LO On HO		
Test Site	DAL-FL	DAL-FL
Tester	ETS364	ETS364
Test Number	EB672302	EB672302
Unit	nsec	
Max Limit	12	12
Min Limit		

krad(Si)	Serial #	pre_short (rtp)	(2)ST_Combos (rpt)	Delta
0	Ctrl	5.156	5.156	0.000
3	58	5.097	5.279	0.182
3	59	4.857	4.938	0.081
3	60	4.668	4.672	0.004
3	61	5.502	5.534	0.032
3	62	5.413	5.512	0.100
3	134	5.010	5.111	0.101
3	137	5.050	5.191	0.141
3	138	5.298	5.087	-0.211
3	139	4.862	4.858	-0.004
3	236	4.850	4.944	0.094
10	63	4.917	4.925	0.008
10	64	5.256	5.206	-0.050
10	65	4.837	4.695	-0.142
10	66	5.647	5.587	-0.060
10	150	4.745	4.578	-0.167
10	237	5.001	4.903	-0.098
10	241	4.806	5.130	0.325
10	242	4.945	5.122	0.177
10	243	5.486	5.464	-0.022
10	244	5.240	5.129	-0.111
30	141	4.836	4.770	-0.065
30	144	5.258	5.226	-0.031
30	145	5.415	5.549	0.135
30	146	5.235	5.122	-0.113
30	147	4.685	4.597	-0.088
30	132	5.402	5.298	-0.104
30	133	5.043	4.845	-0.198
30	135	4.904	5.772	0.869
30	245	5.099	5.092	-0.007
30	246	4.731	4.596	-0.135
50	67	4.933	4.877	-0.056
50	68	5.290	5.225	-0.065
50	69	4.951	4.963	0.012
50	71	5.635	5.704	0.068
50	72	4.890	4.884	-0.006
50	172	5.183	5.133	-0.050
50	173	5.082	5.089	0.008
50	174	4.901	5.029	0.128
50	183	4.876	4.809	-0.067
50	186	5.571	5.605	0.035
100	95	4.858	4.952	0.094
100	102	5.240	4.952	-0.287
100	104	4.892	4.915	0.023
100	105	5.302	5.328	0.026
100	106	5.334	5.354	0.020
100	178	5.037	4.988	-0.050
100	179	5.246	5.226	-0.020
100	180	5.030	5.018	-0.013
100	181	4.950	4.932	-0.019
100	182	5.400	5.205	-0.195
	Max	5.647	5.772	0.869
	Average	5.095	5.100	0.004
	Min	4.668	4.578	-0.287
	Std Dev	0.256	0.286	0.166

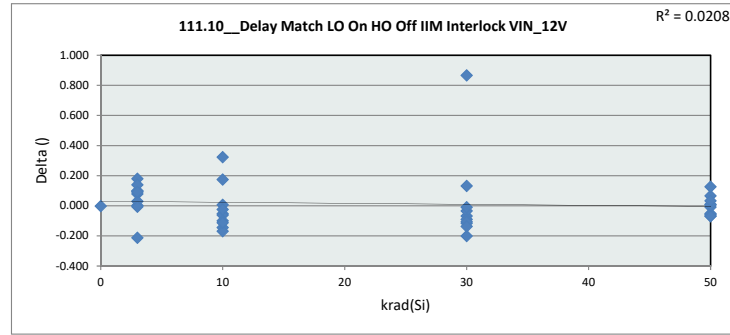

111.10 Delay Match		
Test Site	DAL-FL	
Tester	ETS364	
Test Number	EB672302	
Max Limit	12	
Min Limit		

krad(Si)	0	3	10	30	50	100
LL						
Min	5.156	4.672	4.578	4.596	4.809	4.915
Average	5.156	5.113	5.074	5.087	5.132	5.087
Max	5.156	5.534	5.587	5.772	5.704	5.354
UL	12.000	12.000	12.000	12.000	12.000	12.000

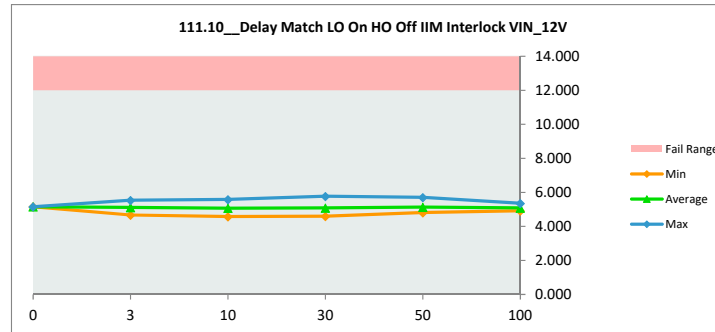

TID HDR Report
TPS7H6003-SP (5962R2220101VXC)

111.11 Delay Match LO Off HO		
Test Site	DAL-FL	DAL-FL
Tester	ETS364	ETS364
Test Number	EB672302	EB672302
Unit	nsec	
Max Limit	4	4
Min Limit		

krad(Si)	Serial #	pre_short (rtp)	(2)ST_Combo (rpt)	Delta
0	Ctrl	1.399	1.399	0.000
3	58	0.983	1.214	0.232
3	59	1.164	1.363	0.199
3	60	1.251	1.541	0.290
3	61	0.807	0.961	0.154
3	62	0.748	0.903	0.155
3	134	1.319	0.911	-0.407
3	137	1.002	0.958	-0.044
3	138	0.695	0.934	0.239
3	139	0.877	1.109	0.232
3	236	1.425	1.047	-0.378
10	63	0.976	1.309	0.333
10	64	1.007	1.202	0.195
10	65	0.920	1.234	0.314
10	66	0.816	0.900	0.084
10	150	1.401	1.613	0.213
10	237	0.911	0.968	0.057
10	241	1.137	1.050	-0.087
10	242	1.371	1.549	0.178
10	243	0.826	0.937	0.111
10	244	0.830	1.084	0.254
30	141	1.241	1.426	0.185
30	144	0.982	1.227	0.245
30	145	0.595	0.775	0.180
30	146	1.104	1.487	0.383
30	147	1.124	1.407	0.283
30	132	0.888	0.965	0.076
30	133	0.976	1.151	0.175
30	135	0.826	0.719	-0.108
30	245	0.866	1.060	0.194
30	246	1.220	1.449	0.229
50	67	0.751	1.087	0.335
50	68	1.262	1.222	-0.040
50	69	0.935	1.260	0.325
50	71	0.526	0.920	0.395
50	72	1.275	1.570	0.295
50	172	0.623	0.868	0.245
50	173	0.819	1.224	0.406
50	174	1.400	1.305	-0.095
50	183	1.305	1.698	0.393
50	186	0.541	0.888	0.347
100	95	0.985	1.346	0.361
100	102	1.194	1.664	0.471
100	104	1.083	1.396	0.313
100	105	0.998	1.235	0.237
100	106	0.913	1.423	0.510
100	178	0.980	1.349	0.369
100	179	1.075	1.647	0.572
100	180	1.108	1.438	0.329
100	181	1.096	1.379	0.283
100	182	0.964	1.325	0.361
	Max	1.425	1.698	0.572
	Average	1.010	1.218	0.207
	Min	0.526	0.719	-0.407
	Std Dev	0.231	0.253	0.194

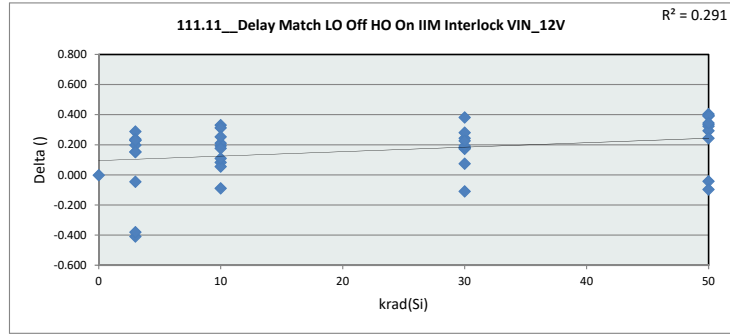

111.11 Delay Match	
Test Site	DAL-FL
Tester	ETS364
Test Number	EB672302
Max Limit	4
Min Limit	

krad(Si)	0	3	10	30	50	100
LL						
Min	1.399	0.903	0.900	0.719	0.868	1.235
Average	1.399	1.094	1.185	1.166	1.204	1.420
Max	1.399	1.541	1.613	1.488	1.698	1.665
UL	4.000	4.000	4.000	4.000	4.000	4.000

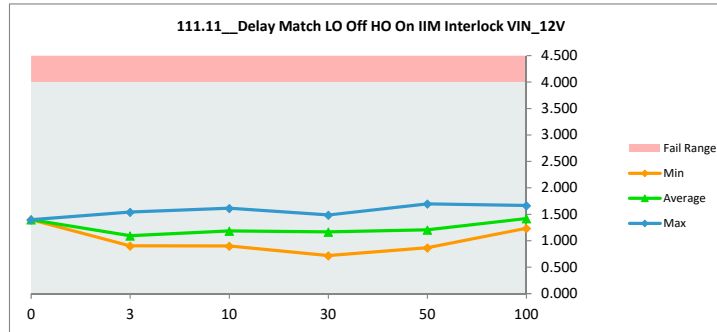

TID HDR Report
TPS7H6003-SP (5962R2220101VXC)

111.12 Delay Match LO On HO		
Test Site	DAL-FL	DAL-FL
Tester	ETS364	ETS364
Test Number	EB672302	EB672302
Unit	nsec	
Max Limit	12	
Min Limit		

krad(Si)	Serial #	pre_short (rtp)	(2)'ST_Combo (rpt)	Delta
0	Ctrl	5.577	5.577	0.000
3	58	5.711	5.764	0.052
3	59	5.459	5.477	0.019
3	60	5.221	5.215	-0.006
3	61	6.067	6.147	0.079
3	62	5.953	5.949	-0.004
3	134	5.570	5.571	0.001
3	137	5.626	5.737	0.111
3	138	5.838	5.702	-0.135
3	139	5.429	5.446	0.017
3	236	5.425	5.425	0.000
10	63	5.457	5.538	0.082
10	64	5.775	5.649	-0.126
10	65	5.380	5.384	0.004
10	66	6.175	6.214	0.038
10	150	5.307	5.137	-0.169
10	237	5.610	5.498	-0.112
10	241	5.340	5.595	0.254
10	242	5.526	5.693	0.167
10	243	6.100	5.898	-0.202
10	244	5.761	5.703	-0.058
30	141	5.409	5.377	-0.032
30	144	5.825	5.663	-0.162
30	145	5.969	6.089	0.119
30	146	5.792	5.778	-0.013
30	147	5.190	5.203	0.013
30	132	5.896	5.886	-0.009
30	133	5.553	5.389	-0.164
30	135	5.450	6.381	0.931
30	245	5.665	5.601	-0.064
30	246	5.257	5.230	-0.027
50	67	5.528	5.465	-0.063
50	68	5.811	5.774	-0.037
50	69	5.542	5.489	-0.053
50	71	6.218	6.316	0.098
50	72	5.471	5.371	-0.101
50	172	5.756	5.756	0.000
50	173	5.668	5.508	-0.160
50	174	5.457	5.513	0.056
50	183	5.479	5.360	-0.119
50	186	6.184	6.106	-0.078
100	95	5.431	5.449	0.018
100	102	5.808	5.558	-0.250
100	104	5.470	5.517	0.047
100	105	5.841	5.862	0.021
100	106	5.960	5.812	-0.149
100	178	5.555	5.480	-0.075
100	179	5.848	5.726	-0.122
100	180	5.595	5.490	-0.105
100	181	5.526	5.428	-0.098
100	182	5.944	5.689	-0.255
	Max	6.218	6.381	0.931
	Average	5.655	5.639	-0.016
	Min	5.190	5.137	-0.255
	Std Dev	0.258	0.281	0.170

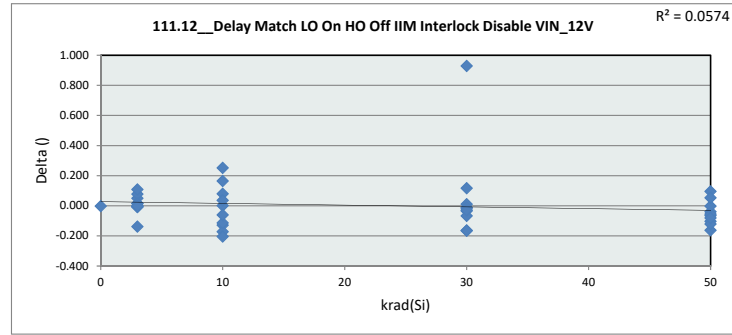

111.12 Delay Match

Test Site	DAL-FL
Tester	ETS364
Test Number	EB672302
Max Limit	12
Min Limit	

krad(Si)	0	3	10	30	50	100
LL						
Min	5.577	5.215	5.137	5.203	5.360	5.428
Average	5.577	5.643	5.631	5.660	5.666	5.601
Max	5.577	6.147	6.214	6.381	6.316	5.862
UL	12.000	12.000	12.000	12.000	12.000	12.000

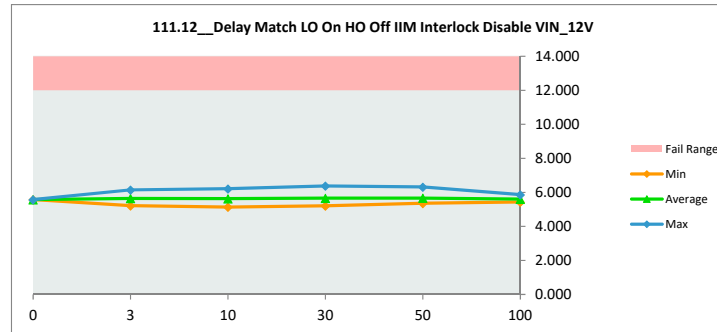

TID HDR Report
TPS7H6003-SP (5962R2220101VXC)

111.13 Delay Match LO Off HO		
Test Site	DAL-FL	DAL-FL
Tester	ETS364	ETS364
Test Number	EB672302	EB672302
Unit	nsec	
Max Limit	4	
Min Limit		

krad(Si)	Serial #	pre_short (rtp)	(2)ST_Combo (rpt)	Delta
0	Ctrl	1.297	1.297	0.000
3	58	0.939	1.211	0.272
3	59	1.176	1.281	0.105
3	60	1.297	1.597	0.300
3	61	0.799	0.959	0.161
3	62	0.742	1.000	0.257
3	134	1.291	0.827	-0.463
3	137	1.032	0.961	-0.072
3	138	0.759	0.936	0.177
3	139	0.917	1.105	0.187
3	236	1.419	1.125	-0.295
10	63	0.997	1.210	0.213
10	64	1.028	1.180	0.152
10	65	0.928	1.126	0.198
10	66	0.778	0.983	0.205
10	150	1.423	1.709	0.286
10	237	0.894	1.123	0.229
10	241	1.136	1.048	-0.087
10	242	1.388	1.513	0.125
10	243	0.837	0.991	0.154
10	244	0.840	1.095	0.255
30	141	1.230	1.427	0.197
30	144	0.941	1.195	0.254
30	145	0.579	0.755	0.175
30	146	1.114	1.481	0.367
30	147	1.125	1.340	0.215
30	132	0.831	1.093	0.262
30	133	0.965	1.231	0.266
30	135	0.815	0.727	-0.088
30	245	0.918	1.135	0.218
30	246	1.229	1.603	0.374
50	67	0.751	1.178	0.427
50	68	1.237	1.220	-0.017
50	69	0.973	1.158	0.185
50	71	0.524	0.773	0.249
50	72	1.296	1.629	0.332
50	172	0.622	0.795	0.173
50	173	0.858	1.247	0.389
50	174	1.340	1.343	0.003
50	183	1.313	1.764	0.451
50	186	0.580	0.891	0.311
100	95	1.028	1.249	0.221
100	102	1.179	1.554	0.375
100	104	1.023	1.446	0.424
100	105	1.008	1.244	0.236
100	106	0.938	1.413	0.475
100	178	0.983	1.263	0.279
100	179	1.072	1.640	0.568
100	180	1.106	1.531	0.425
100	181	1.082	1.387	0.306
100	182	0.920	1.287	0.367
	Max	1.423	1.764	0.568
	Average	1.010	1.221	0.211
	Min	0.524	0.727	-0.463
	Std Dev	0.226	0.258	0.186

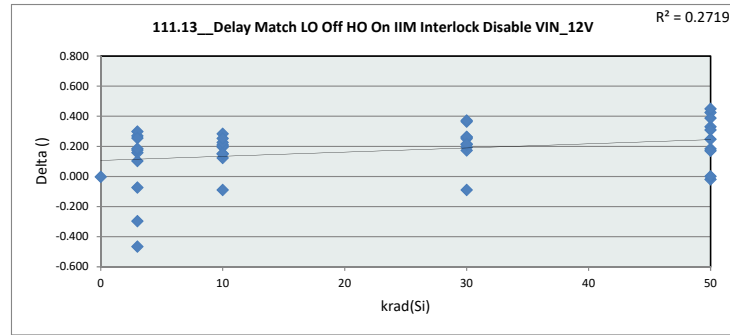

111.13 Delay Match

Test Site	DAL-FL
Tester	ETS364
Test Number	EB672302
Max Limit	4
Min Limit	

krad(Si)	0	3	10	30	50	100
LL						
Min	1.297	0.827	0.983	0.727	0.773	1.244
Average	1.297	1.100	1.198	1.199	1.200	1.401
Max	1.297	1.597	1.709	1.603	1.764	1.640
UL	4.000	4.000	4.000	4.000	4.000	4.000

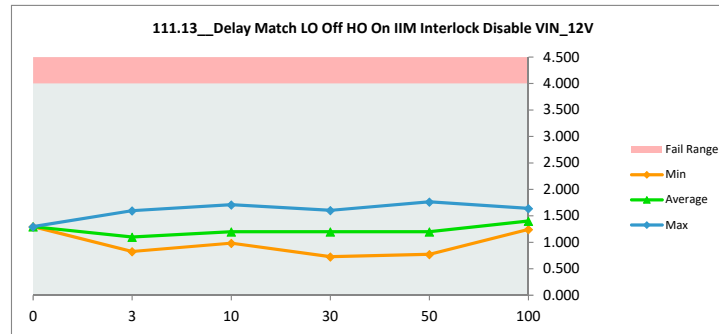

TID HDR Report

TPS7H6003-SP (5962R2220101VXC)

112.0 Prop Delay LO Off PWM		
Test Site	DAL-FL	DAL-FL
Tester	ETS364	ETS364
Test Number	EB672302	EB672302
Unit	nsec	
Max Limit	48	
Min Limit	1	

krad(Si)	Serial #	pre_short (rtp)	(2)ST_Combo (rpt)	Delta
0	Ctrl	30.884	30.884	0.000
3	58	30.450	30.386	-0.064
3	59	30.520	30.351	-0.169
3	60	30.388	30.406	0.018
3	61	30.464	30.321	-0.143
3	62	30.690	30.579	-0.111
3	134	31.053	30.233	-0.820
3	137	30.635	30.218	-0.417
3	138	30.765	30.135	-0.631
3	139	30.417	30.255	-0.162
3	236	30.736	30.079	-0.657
10	63	30.543	30.358	-0.185
10	64	30.789	30.513	-0.276
10	65	30.420	30.250	-0.170
10	66	30.211	30.059	-0.151
10	150	30.810	30.497	-0.314
10	237	30.443	29.951	-0.491
10	241	30.266	30.211	-0.056
10	242	30.657	30.395	-0.262
10	243	30.426	30.184	-0.242
10	244	30.212	30.096	-0.116
30	141	30.758	30.258	-0.500
30	144	30.876	30.365	-0.511
30	145	30.729	30.303	-0.426
30	146	30.488	29.964	-0.524
30	147	30.448	30.069	-0.379
30	132	31.095	30.678	-0.417
30	133	30.528	30.120	-0.408
30	135	30.207	30.267	0.060
30	245	30.644	30.332	-0.312
30	246	30.819	30.456	-0.362
50	67	30.372	29.983	-0.389
50	68	30.641	30.157	-0.484
50	69	30.801	30.211	-0.590
50	71	30.816	30.320	-0.496
50	72	30.353	29.742	-0.611
50	172	30.301	29.779	-0.521
50	173	30.497	30.072	-0.424
50	174	31.014	30.393	-0.621
50	183	30.909	30.510	-0.399
50	186	30.771	30.272	-0.499
100	95	30.549	29.688	-0.861
100	102	30.484	29.691	-0.793
100	104	30.341	29.521	-0.820
100	105	30.563	29.767	-0.796
100	106	30.625	29.911	-0.714
100	178	30.569	29.803	-0.766
100	179	30.883	30.219	-0.664
100	180	30.981	30.226	-0.755
100	181	30.648	29.803	-0.845
100	182	30.713	29.886	-0.826
Max		31.095	30.884	0.060
Average		30.612	30.179	-0.433
Min		30.207	29.521	-0.861
Std Dev		0.227	0.275	0.258

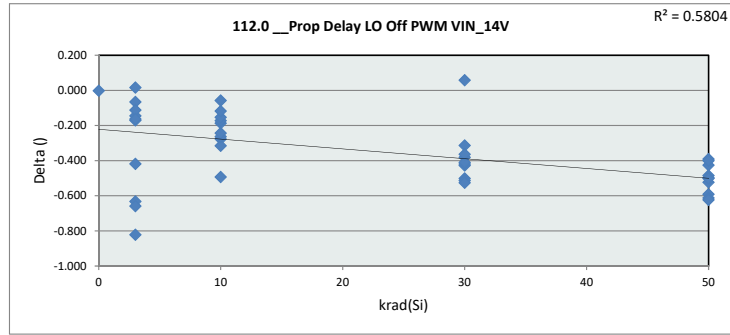

112.0 Prop Delay	
Test Site	DAL-FL
Tester	ETS364
Test Number	EB672302
Max Limit	48
Min Limit	1

krad(Si)	0	3	10	30	50	100
LL	1.000	1.000	1.000	1.000	1.000	1.000
Min	30.884	30.079	29.952	29.964	29.742	29.521
Average	30.884	30.296	30.251	30.281	30.144	29.852
Max	30.884	30.579	30.513	30.678	30.510	30.226
UL	48.000	48.000	48.000	48.000	48.000	48.000

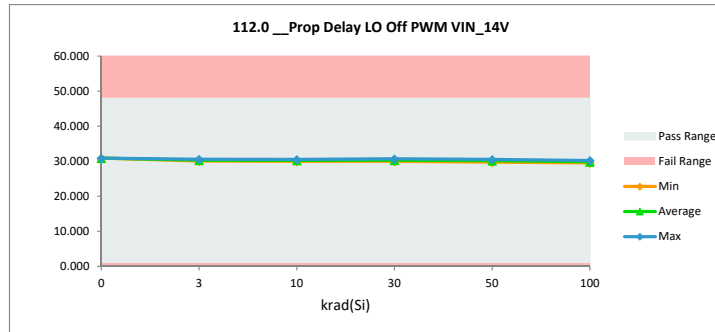

TID HDR Report
TPS7H6003-SP (5962R2220101VXC)

112.1 Prop Delay HO Off PWM		
Test Site	DAL-FL	DAL-FL
Tester	ETS364	ETS364
Test Number	EB672302	EB672302
Unit	nsec	
Max Limit	50	
Min Limit	1	

krad(Si)	Serial #	pre_short (rtp)	(2)'ST_Combo (rpt)	Delta
0	Ctrl	33.505	33.505	0.000
3	58	33.094	33.283	0.189
3	59	32.986	33.043	0.057
3	60	32.721	32.906	0.184
3	61	33.539	33.745	0.206
3	62	33.690	33.843	0.153
3	134	33.403	33.047	-0.356
3	137	33.279	33.115	-0.164
3	138	33.617	33.095	-0.522
3	139	33.000	33.053	0.053
3	236	33.027	32.752	-0.274
10	63	33.193	33.262	0.068
10	64	33.592	33.445	-0.147
10	65	32.936	32.974	0.038
10	66	33.383	33.460	0.077
10	150	33.117	33.030	-0.087
10	237	33.028	32.720	-0.308
10	241	32.722	33.110	0.389
10	242	33.153	33.156	0.004
10	243	33.482	33.361	-0.121
10	244	33.100	33.061	-0.039
30	141	33.102	32.917	-0.185
30	144	33.612	33.334	-0.278
30	145	33.576	33.568	-0.008
30	146	33.245	33.082	-0.164
30	147	32.742	32.542	-0.200
30	132	33.887	33.669	-0.218
30	133	33.063	32.824	-0.239
30	135	32.759	33.718	0.959
30	245	33.425	33.268	-0.157
30	246	32.960	32.774	-0.186
50	67	32.947	32.600	-0.348
50	68	33.364	33.169	-0.195
50	69	33.142	32.898	-0.244
50	71	33.996	33.936	-0.060
50	72	32.771	32.525	-0.247
50	172	33.240	32.957	-0.283
50	173	33.408	33.093	-0.315
50	174	33.347	33.045	-0.301
50	183	33.229	32.834	-0.395
50	186	33.951	33.565	-0.386
100	95	33.010	32.541	-0.469
100	102	33.199	32.459	-0.739
100	104	33.011	32.448	-0.563
100	105	33.412	32.881	-0.531
100	106	33.461	33.030	-0.432
100	178	32.999	32.352	-0.647
100	179	33.592	32.934	-0.658
100	180	33.358	32.915	-0.443
100	181	33.252	32.694	-0.558
100	182	33.610	32.817	-0.793
	Max	33.996	33.936	0.959
	Average	33.260	33.066	-0.194
	Min	32.721	32.352	-0.793
	Std Dev	0.313	0.375	0.306

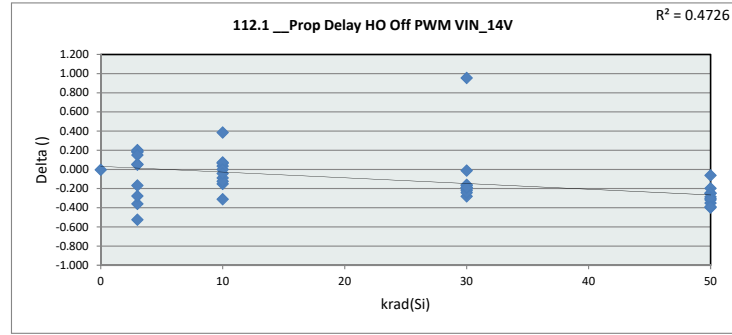

112.1 Prop Delay	
Test Site	DAL-FL
Tester	ETS364
Test Number	EB672302
Max Limit	50
Min Limit	1

krad(Si)	0	3	10	30	50	100
LL	1.000	1.000	1.000	1.000	1.000	1.000
Min	33.505	32.753	32.720	32.542	32.525	32.352
Average	33.505	33.188	33.158	33.169	33.062	32.707
Max	33.505	33.843	33.460	33.718	33.936	33.030
UL	50.000	50.000	50.000	50.000	50.000	50.000

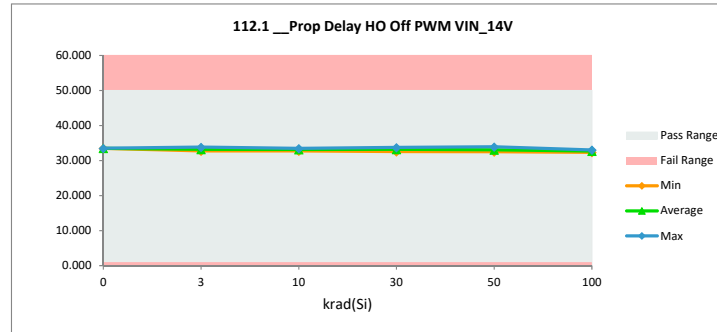

TID HDR Report
TPS7H6003-SP (5962R2220101VXC)

112.2 Prop Delay LO On IIM In		
Test Site	DAL-FL	DAL-FL
Tester	ETS364	ETS364
Test Number	EB672302	EB672302
Unit	nsec	
Max Limit	38	
Min Limit	1	

krad(Si)	Serial #	pre_short (rtp) (2)	ST_Combo (rpt) (Delta
0	Ctrl	23.209	23.209	0.000
3	58	23.271	23.287	0.016
3	59	23.483	23.373	-0.110
3	60	23.227	23.255	0.028
3	61	23.250	23.164	-0.086
3	62	23.316	23.269	-0.047
3	134	23.478	23.324	-0.154
3	137	23.542	23.324	-0.218
3	138	23.444	23.207	-0.237
3	139	23.340	23.186	-0.154
3	236	23.283	22.932	-0.351
10	63	23.384	23.316	-0.068
10	64	23.475	23.265	-0.211
10	65	23.301	23.138	-0.163
10	66	23.055	22.882	-0.172
10	150	23.648	23.439	-0.208
10	237	23.368	22.918	-0.450
10	241	23.231	23.352	0.121
10	242	23.323	23.062	-0.261
10	243	23.111	22.895	-0.216
10	244	23.203	23.061	-0.143
30	141	23.376	23.096	-0.280
30	144	23.538	23.264	-0.274
30	145	23.352	23.079	-0.273
30	146	23.277	23.072	-0.205
30	147	23.334	23.042	-0.292
30	132	23.575	23.304	-0.271
30	133	23.263	23.015	-0.248
30	135	23.189	23.134	-0.055
30	245	23.437	23.292	-0.145
30	246	23.358	23.134	-0.224
50	67	23.264	23.040	-0.224
50	68	23.210	23.154	-0.056
50	69	23.346	23.036	-0.311
50	71	23.397	23.145	-0.253
50	72	23.176	22.879	-0.297
50	172	23.373	23.099	-0.273
50	173	23.416	23.119	-0.297
50	174	23.451	23.130	-0.321
50	183	23.518	23.285	-0.233
50	186	23.445	23.142	-0.302
100	95	23.441	23.020	-0.421
100	102	23.224	22.825	-0.400
100	104	23.329	22.823	-0.506
100	105	23.160	22.764	-0.396
100	106	23.299	23.041	-0.257
100	178	23.278	22.857	-0.421
100	179	23.513	23.155	-0.358
100	180	23.474	23.128	-0.346
100	181	23.422	23.010	-0.412
100	182	23.296	22.804	-0.492
Max		23.648	23.439	0.121
Average		23.346	23.113	-0.234
Min		23.055	22.764	-0.506
Std Dev		0.126	0.164	0.137

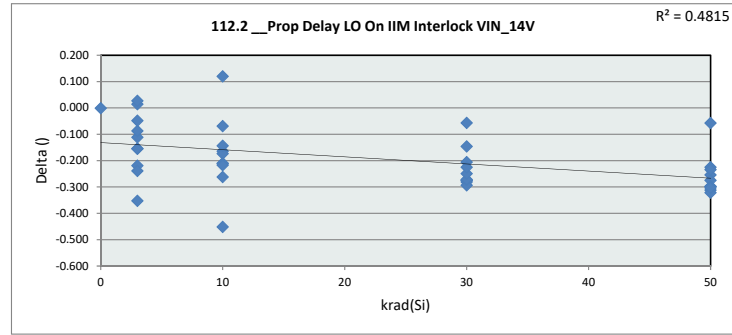

112.2 Prop Delay	
Test Site	DAL-FL
Tester	ETS364
Test Number	EB672302
Max Limit	38
Min Limit	1

krad(Si)	0	3	10	30	50	100
LL	1.000	1.000	1.000	1.000	1.000	1.000
Min	23.209	22.932	22.882	23.015	22.880	22.764
Average	23.209	23.232	23.133	23.143	23.103	22.943
Max	23.209	23.373	23.439	23.304	23.285	23.155
UL	38.000	38.000	38.000	38.000	38.000	38.000

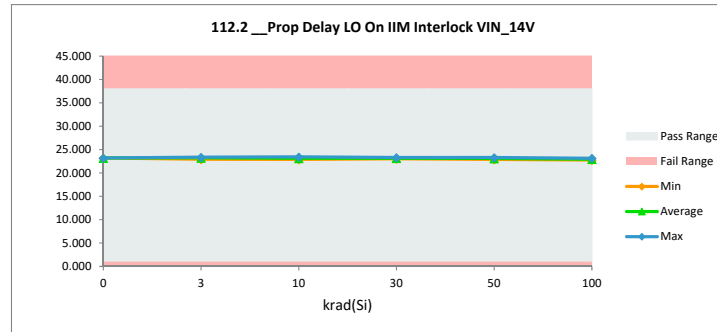

TID HDR Report
TPS7H6003-SP (5962R2220101VXC)

112.3 Prop Delay LO Off IIM Interlock VIN_14V		
Test Site	DAL-FL	DAL-FL
Tester	ETS364	ETS364
Test Number	EB672302	EB672302
Unit	nsec	
Max Limit	38	
Min Limit	1	

krad(Si)	Serial #	pre_short (rtp)	(2)ST_Combo (rpt)	Delta
0	Ctrl	27.631	27.631	0.000
3	58	27.351	27.378	0.026
3	59	27.647	27.504	-0.144
3	60	27.281	27.388	0.107
3	61	27.383	27.419	0.036
3	62	27.405	27.499	0.094
3	134	27.788	27.368	-0.421
3	137	27.628	27.465	-0.164
3	138	27.583	27.438	-0.145
3	139	27.311	27.277	-0.034
3	236	27.492	27.128	-0.364
10	63	27.356	27.255	-0.101
10	64	27.541	27.440	-0.101
10	65	27.244	27.271	0.027
10	66	27.189	27.198	0.009
10	150	27.702	27.562	-0.141
10	237	27.438	27.124	-0.315
10	241	27.235	27.444	0.210
10	242	27.447	27.312	-0.136
10	243	27.207	27.103	-0.104
10	244	27.230	27.224	-0.005
30	141	27.479	27.280	-0.199
30	144	27.711	27.488	-0.223
30	145	27.506	27.349	-0.157
30	146	27.420	27.313	-0.107
30	147	27.280	27.173	-0.108
30	132	27.792	27.599	-0.193
30	133	27.400	27.240	-0.161
30	135	27.133	27.465	0.332
30	245	27.402	27.343	-0.059
30	246	27.531	27.412	-0.119
50	67	27.283	27.243	-0.041
50	68	27.398	27.365	-0.033
50	69	27.534	27.326	-0.208
50	71	27.478	27.280	-0.198
50	72	27.323	27.100	-0.223
50	172	27.339	27.045	-0.294
50	173	27.284	27.150	-0.133
50	174	27.689	27.413	-0.275
50	183	27.737	27.561	-0.176
50	186	27.538	27.260	-0.279
100	95	27.497	27.103	-0.394
100	102	27.354	27.091	-0.263
100	104	27.251	26.936	-0.316
100	105	27.303	26.959	-0.344
100	106	27.497	27.312	-0.184
100	178	27.492	27.114	-0.378
100	179	27.773	27.448	-0.325
100	180	27.768	27.552	-0.215
100	181	27.505	27.086	-0.419
100	182	27.476	26.968	-0.508
	Max	27.792	27.631	0.332
	Average	27.456	27.302	-0.154
	Min	27.133	26.936	-0.508
	Std Dev	0.173	0.174	0.165

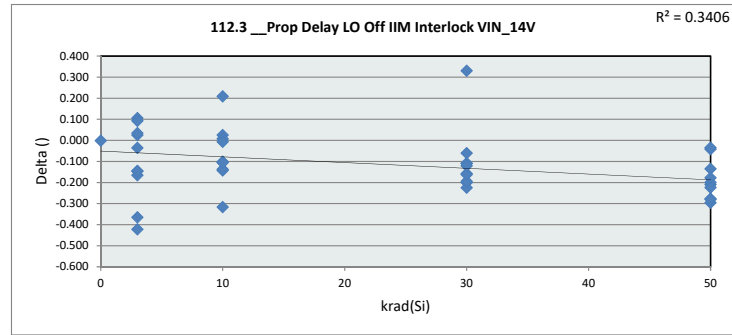

112.3 Prop Delay						
Test Site	DAL-FL					
Tester	ETS364					
Test Number	EB672302					
Max Limit	38					
Min Limit	1					
krad(Si)	0	3	10	30	50	100
LL	1.000	1.000	1.000	1.000	1.000	1.000
Min	27.631	27.129	27.103	27.173	27.045	26.936
Average	27.631	27.386	27.293	27.366	27.274	27.157
Max	27.631	27.504	27.562	27.599	27.561	27.552
UL	38.000	38.000	38.000	38.000	38.000	38.000

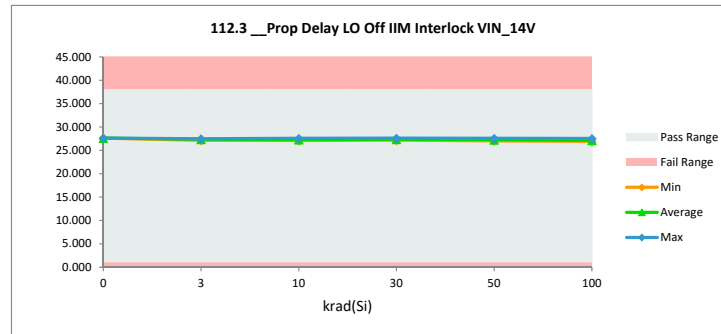

TID HDR Report
TPS7H6003-SP (5962R2220101VXC)

112.4 Prop Delay HO On IIM I		
Test Site	DAL-FL	DAL-FL
Tester	ETS364	ETS364
Test Number	EB672302	EB672302
Unit	nsec	
Max Limit	40	40
Min Limit	1	1

krad(Si)	Serial #	pre_short (rtp)	(2)ST_Combo (rpt)	Delta
0	Ctrl	26.254	26.254	0.000
3	58	26.409	26.337	-0.072
3	59	26.459	26.255	-0.204
3	60	26.006	25.879	-0.127
3	61	26.610	26.501	-0.108
3	62	26.657	26.581	-0.076
3	134	26.451	26.486	0.034
3	137	26.601	26.506	-0.095
3	138	26.813	26.505	-0.308
3	139	26.410	26.159	-0.251
3	236	26.032	26.067	0.035
10	63	26.386	26.182	-0.204
10	64	26.541	26.231	-0.311
10	65	26.298	26.028	-0.270
10	66	26.429	26.195	-0.234
10	150	26.315	26.020	-0.295
10	237	26.514	26.066	-0.448
10	241	26.100	26.449	0.349
10	242	26.044	25.824	-0.220
10	243	26.330	25.997	-0.333
10	244	26.358	26.072	-0.286
30	141	26.258	25.838	-0.420
30	144	26.766	26.262	-0.505
30	145	26.948	26.552	-0.396
30	146	26.299	25.911	-0.388
30	147	26.188	25.712	-0.476
30	132	26.933	26.552	-0.382
30	133	26.449	26.032	-0.417
30	135	26.299	26.690	0.391
30	245	26.531	26.157	-0.373
30	246	26.297	25.848	-0.449
50	67	26.534	26.001	-0.533
50	68	26.133	26.149	0.016
50	69	26.576	26.084	-0.492
50	71	26.948	26.448	-0.500
50	72	26.038	25.537	-0.501
50	172	26.695	26.245	-0.450
50	173	26.476	25.950	-0.526
50	174	26.341	26.065	-0.275
50	183	26.361	25.839	-0.523
50	186	26.999	26.535	-0.464
100	95	26.496	25.830	-0.666
100	102	26.195	25.447	-0.748
100	104	26.205	25.491	-0.714
100	105	26.268	25.667	-0.601
100	106	26.568	25.848	-0.721
100	178	26.500	25.795	-0.705
100	179	26.660	25.882	-0.778
100	180	26.633	26.005	-0.628
100	181	26.403	25.779	-0.624
100	182	26.508	25.687	-0.822
Max		26.999	26.690	0.391
Average		26.442	26.087	-0.355
Min		26.006	25.447	-0.822
Std Dev		0.243	0.306	0.266

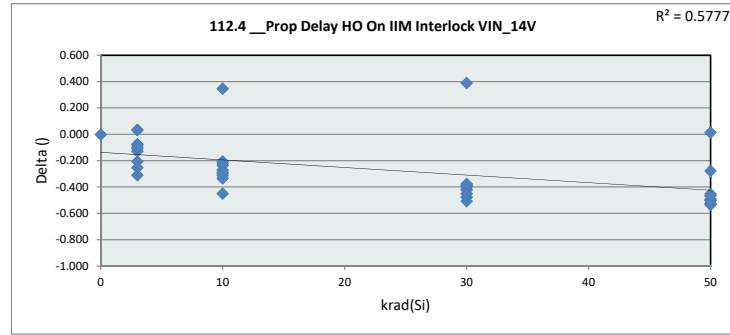

112.4 Prop Delay

112.4 Prop Delay	
Test Site	DAL-FL
Tester	ETS364
Test Number	EB672302
Max Limit	40
Min Limit	1

krad(Si)	0	3	10	30	50	100
LL	1.000	1.000	1.000	1.000	1.000	1.000
Min	26.254	25.879	25.824	25.712	25.537	25.447
Average	26.254	26.327	26.106	26.155	26.085	25.743
Max	26.254	26.581	26.449	26.690	26.535	26.005
UL	40.000	40.000	40.000	40.000	40.000	40.000

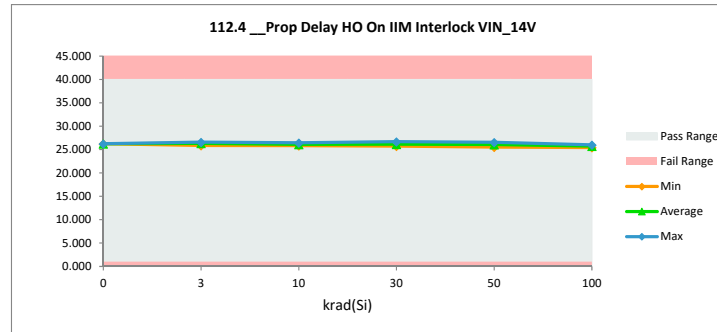

TID HDR Report
TPS7H6003-SP (5962R2220101VXC)

112.5 Prop Delay HO Off IIM I		
Test Site	DAL-FL	DAL-FL
Tester	ETS364	ETS364
Test Number	EB672302	EB672302
Unit	nsec	
Max Limit	40	
Min Limit	1	

krad(Si)	Serial #	pre_short (rtp)	(2)ST_Combo (rpt)	Delta
0	Ctrl	28.296	28.296	0.000
3	58	28.381	28.448	0.067
3	59	28.370	28.267	-0.103
3	60	27.901	27.860	-0.041
3	61	28.813	28.770	-0.043
3	62	28.729	28.774	0.045
3	134	28.540	28.438	-0.102
3	137	28.608	28.416	-0.192
3	138	28.714	28.442	-0.272
3	139	28.180	28.088	-0.092
3	236	28.147	27.883	-0.264
10	63	28.319	28.204	-0.114
10	64	28.667	28.417	-0.250
10	65	28.130	27.988	-0.141
10	66	28.654	28.574	-0.080
10	150	28.353	28.029	-0.324
10	237	28.402	27.885	-0.518
10	241	28.026	28.424	0.398
10	242	28.284	28.165	-0.119
10	243	28.638	28.433	-0.205
10	244	28.397	28.276	-0.121
30	141	28.196	28.000	-0.197
30	144	28.819	28.524	-0.295
30	145	28.772	28.634	-0.138
30	146	28.476	28.233	-0.244
30	147	27.990	27.796	-0.194
30	132	28.971	28.586	-0.386
30	133	28.237	27.941	-0.296
30	135	28.062	28.971	0.909
30	245	28.542	28.329	-0.213
30	246	28.103	27.813	-0.290
50	67	28.238	27.918	-0.319
50	68	28.478	28.373	-0.105
50	69	28.264	27.960	-0.304
50	71	28.998	28.883	-0.115
50	72	28.053	27.671	-0.382
50	172	28.526	28.184	-0.342
50	173	28.538	28.221	-0.317
50	174	28.348	28.055	-0.293
50	183	28.419	27.979	-0.440
50	186	29.021	28.677	-0.343
100	95	28.303	27.868	-0.435
100	102	28.441	27.813	-0.628
100	104	28.222	27.730	-0.493
100	105	28.448	28.080	-0.369
100	106	28.723	28.333	-0.390
100	178	28.291	27.796	-0.495
100	179	28.780	28.305	-0.475
100	180	28.505	28.138	-0.367
100	181	28.391	28.065	-0.326
100	182	28.676	28.002	-0.674
Max		29.021	28.971	0.909
Average		28.439	28.215	-0.224
Min		27.901	27.671	-0.674
Std Dev		0.269	0.317	0.247

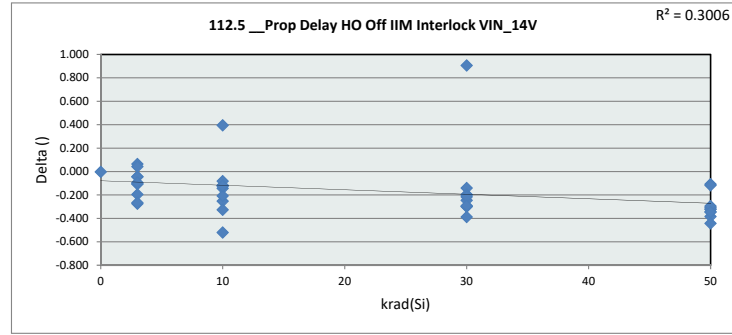

112.5 Prop Delay						
Test Site	DAL-FL					
Tester	ETS364					
Test Number	EB672302					
Max Limit	40					
Min Limit	1					
krad(Si)	0	3	10	30	50	100
LL	1.000	1.000	1.000	1.000	1.000	1.000
Min	28.297	27.860	27.885	27.796	27.671	27.730
Average	28.297	28.339	28.240	28.283	28.192	28.013
Max	28.297	28.774	28.575	28.971	28.883	28.333
UL	40.000	40.000	40.000	40.000	40.000	40.000

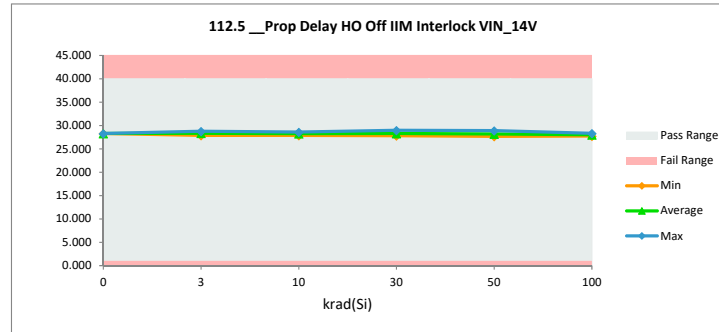

TID HDR Report
TPS7H6003-SP (5962R2220101VXC)

112.6 Prop Delay LO On IIM Tr		
Test Site	DAL-FL	DAL-FL
Tester	ETS364	ETS364
Test Number	EB672302	EB672302
Unit	nsec	
Max Limit	38	
Min Limit	1	

krad(Si)	Serial #	pre_short (rtp) (2)	ST_Combo (rpt) (Delta
0	Ctrl	23.203	23.203	0.000
3	58	23.211	23.243	0.032
3	59	23.452	23.318	-0.135
3	60	23.209	23.185	-0.024
3	61	23.211	23.124	-0.087
3	62	23.292	23.288	-0.004
3	134	23.456	23.285	-0.172
3	137	23.509	23.271	-0.238
3	138	23.433	23.229	-0.204
3	139	23.324	23.201	-0.123
3	236	23.226	22.930	-0.295
10	63	23.340	23.267	-0.073
10	64	23.428	23.290	-0.137
10	65	23.261	23.181	-0.081
10	66	23.012	22.879	-0.132
10	150	23.608	23.414	-0.194
10	237	23.352	22.937	-0.415
10	241	23.219	23.194	-0.024
10	242	23.265	23.044	-0.221
10	243	23.114	22.927	-0.187
10	244	23.196	22.975	-0.221
30	141	23.347	23.090	-0.257
30	144	23.501	23.192	-0.309
30	145	23.336	23.096	-0.240
30	146	23.244	23.001	-0.243
30	147	23.287	23.002	-0.285
30	132	23.553	23.290	-0.264
30	133	23.214	23.033	-0.182
30	135	23.170	23.241	0.072
30	245	23.422	23.191	-0.231
30	246	23.343	23.198	-0.145
50	67	23.213	22.939	-0.274
50	68	23.177	23.179	0.002
50	69	23.289	23.077	-0.212
50	71	23.369	23.063	-0.306
50	72	23.141	22.897	-0.244
50	172	23.370	23.101	-0.270
50	173	23.383	23.149	-0.235
50	174	23.421	23.093	-0.328
50	183	23.518	23.223	-0.295
50	186	23.403	23.086	-0.317
100	95	23.408	22.975	-0.433
100	102	23.180	22.802	-0.377
100	104	23.320	22.863	-0.457
100	105	23.135	22.713	-0.421
100	106	23.241	23.031	-0.210
100	178	23.257	22.882	-0.375
100	179	23.462	23.102	-0.361
100	180	23.459	23.145	-0.314
100	181	23.391	22.931	-0.460
100	182	23.261	22.818	-0.443
Max		23.608	23.414	0.072
Average		23.316	23.094	-0.223
Min		23.012	22.713	-0.460
Std Dev		0.126	0.156	0.134

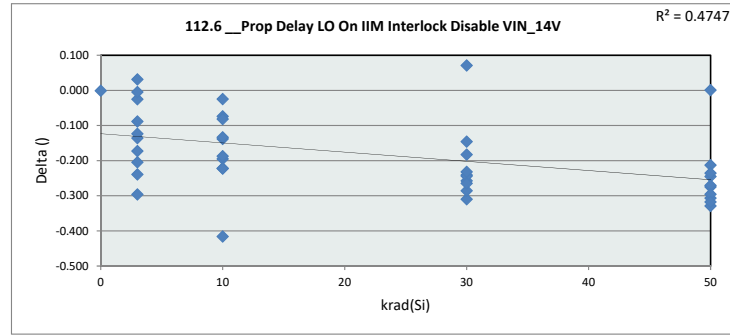

112.6 Prop Delay		
Test Site	DAL-FL	
Tester	ETS364	
Test Number	EB672302	
Max Limit	38	
Min Limit	1	

krad(Si)	0	3	10	30	50	100
LL	1.000	1.000	1.000	1.000	1.000	1.000
Min	23.203	22.930	22.879	23.001	22.897	22.713
Average	23.203	23.207	23.111	23.133	23.081	22.926
Max	23.203	23.318	23.414	23.290	23.223	23.145
UL	38.000	38.000	38.000	38.000	38.000	38.000

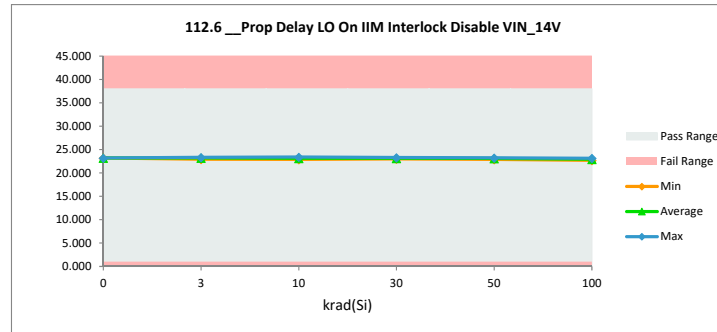

TID HDR Report
TPS7H6003-SP (5962R2220101VXC)

112.7 Prop Delay LO Off IIM I		
Test Site	DAL-FL	DAL-FL
Tester	ETS364	ETS364
Test Number	EB672302	EB672302
Unit	nsec	
Max Limit	38	
Min Limit	1	

krad(Si)	Serial #	pre_short (rtp) (2)	ST_Combo (rpt) (Delta
0	Ctrl	27.442	27.442	0.000
3	58	27.227	27.288	0.061
3	59	27.489	27.487	-0.002
3	60	27.205	27.184	-0.021
3	61	27.289	27.277	-0.012
3	62	27.276	27.273	-0.003
3	134	27.670	27.332	-0.338
3	137	27.506	27.361	-0.145
3	138	27.479	27.331	-0.149
3	139	27.159	27.160	0.001
3	236	27.345	27.020	-0.325
10	63	27.239	27.225	-0.014
10	64	27.437	27.299	-0.138
10	65	27.134	27.133	-0.002
10	66	27.064	27.090	0.026
10	150	27.617	27.517	-0.100
10	237	27.295	27.001	-0.294
10	241	27.106	27.308	0.203
10	242	27.324	27.244	-0.080
10	243	27.088	26.957	-0.131
10	244	27.094	27.100	0.006
30	141	27.335	27.210	-0.125
30	144	27.592	27.353	-0.239
30	145	27.402	27.302	-0.100
30	146	27.311	27.168	-0.143
30	147	27.159	26.980	-0.179
30	132	27.684	27.447	-0.237
30	133	27.322	27.100	-0.222
30	135	27.004	27.257	0.254
30	245	27.297	27.182	-0.115
30	246	27.421	27.276	-0.144
50	67	27.164	27.164	0.001
50	68	27.266	27.162	-0.104
50	69	27.396	27.159	-0.237
50	71	27.330	27.201	-0.129
50	72	27.166	27.027	-0.140
50	172	27.195	26.919	-0.277
50	173	27.188	27.109	-0.079
50	174	27.560	27.280	-0.280
50	183	27.583	27.462	-0.120
50	186	27.408	27.243	-0.165
100	95	27.386	27.116	-0.270
100	102	27.224	26.924	-0.300
100	104	27.150	26.756	-0.394
100	105	27.170	26.848	-0.322
100	106	27.378	27.253	-0.125
100	178	27.347	27.075	-0.273
100	179	27.643	27.301	-0.342
100	180	27.642	27.413	-0.229
100	181	27.357	27.051	-0.306
100	182	27.311	26.895	-0.416
	Max	27.684	27.517	0.254
	Average	27.331	27.189	-0.141
	Min	27.004	26.756	-0.416
	Std Dev	0.172	0.171	0.143

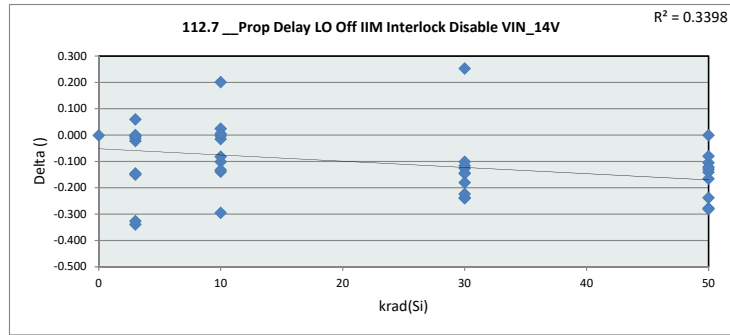

112.7 Prop Delay	
Test Site	DAL-FL
Tester	ETS364
Test Number	EB672302
Max Limit	38
Min Limit	1

krad(Si)	0	3	10	30	50	100
LL	1.000	1.000	1.000	1.000	1.000	1.000
Min	27.442	27.020	26.957	26.980	26.919	26.756
Average	27.442	27.271	27.187	27.228	27.173	27.063
Max	27.442	27.487	27.517	27.447	27.462	27.413
UL	38.000	38.000	38.000	38.000	38.000	38.000

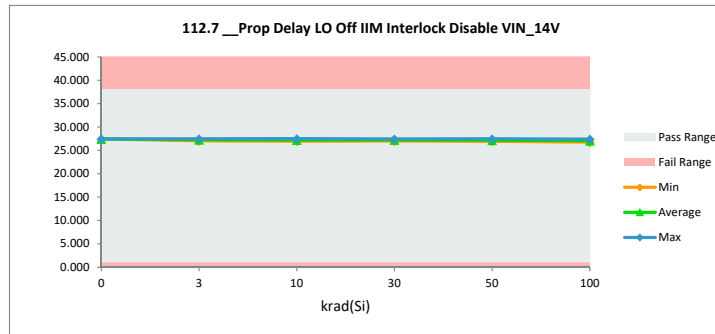

TID HDR Report
TPS7H6003-SP (5962R2220101VXC)

112.8 Prop Delay HO On IIM I		
Test Site	DAL-FL	DAL-FL
Tester	ETS364	ETS364
Test Number	EB672302	EB672302
Unit	nsec	
Max Limit	40	40
Min Limit	1	1

krad(Si)	Serial #	pre_short (rtp)	(2)ST_Combo (rpt)	Delta
0	Ctrl	26.135	26.135	0.000
3	58	26.260	26.211	-0.049
3	59	26.328	26.150	-0.177
3	60	25.864	25.742	-0.122
3	61	26.496	26.269	-0.227
3	62	26.535	26.400	-0.135
3	134	26.369	26.346	-0.024
3	137	26.462	26.366	-0.096
3	138	26.696	26.354	-0.341
3	139	26.299	26.068	-0.231
3	236	25.940	25.920	-0.020
10	63	26.278	26.046	-0.233
10	64	26.417	26.072	-0.345
10	65	26.185	25.824	-0.361
10	66	26.290	26.064	-0.226
10	150	26.177	25.920	-0.257
10	237	26.400	25.933	-0.468
10	241	25.977	26.371	0.394
10	242	25.989	25.749	-0.240
10	243	26.241	25.913	-0.328
10	244	26.272	25.930	-0.342
30	141	26.176	25.741	-0.435
30	144	26.649	26.128	-0.520
30	145	26.846	26.451	-0.395
30	146	26.190	25.709	-0.481
30	147	26.061	25.630	-0.430
30	132	26.836	26.479	-0.357
30	133	26.324	25.884	-0.441
30	135	26.132	26.499	0.368
30	245	26.398	26.022	-0.376
30	246	26.181	25.677	-0.505
50	67	26.394	25.878	-0.515
50	68	26.007	26.016	0.009
50	69	26.426	25.911	-0.516
50	71	26.792	26.298	-0.494
50	72	25.878	25.412	-0.466
50	172	26.581	26.065	-0.517
50	173	26.362	25.890	-0.472
50	174	26.218	25.876	-0.342
50	183	26.275	25.678	-0.597
50	186	26.890	26.393	-0.496
100	95	26.392	25.750	-0.643
100	102	26.070	25.376	-0.694
100	104	26.098	25.399	-0.700
100	105	26.189	25.587	-0.602
100	106	26.448	25.692	-0.755
100	178	26.374	25.686	-0.687
100	179	26.549	25.854	-0.695
100	180	26.563	25.879	-0.684
100	181	26.307	25.674	-0.632
100	182	26.377	25.520	-0.857
	Max	26.890	26.499	0.394
	Average	26.325	25.958	-0.368
	Min	25.864	25.376	-0.857
	Std Dev	0.243	0.295	0.262

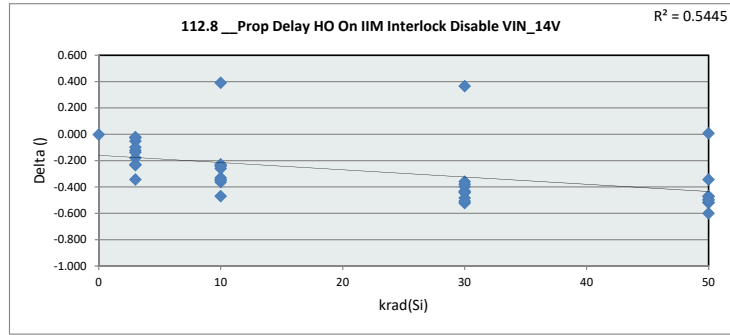

112.8 Prop Delay

Test Site	DAL-FL
Tester	ETS364
Test Number	EB672302
Max Limit	40
Min Limit	1

krad(Si)	0	3	10	30	50	100
LL	1.000	1.000	1.000	1.000	1.000	1.000
Min	26.135	25.742	25.749	25.630	25.412	25.376
Average	26.135	26.183	25.982	26.022	25.942	25.642
Max	26.135	26.400	26.371	26.499	26.394	25.879
UL	40.000	40.000	40.000	40.000	40.000	40.000

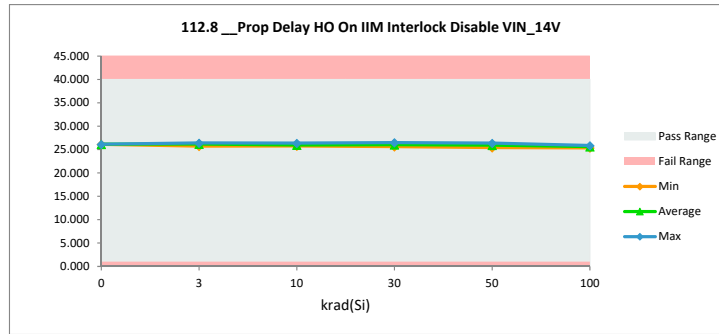

TID HDR Report
TPS7H6003-SP (5962R2220101VXC)

112.9 Prop Delay HO Off IIM I		
Test Site	DAL-FL	DAL-FL
Tester	ETS364	ETS364
Test Number	EB672302	EB672302
Unit	nsec	
Max Limit	40	40
Min Limit	1	1

krad(Si)	Serial #	pre_short (rtp) (2)	ST_Combo (rpt) (Delta
0	Ctrl	28.819	28.819	0.000
3	58	28.907	28.959	0.051
3	59	28.886	28.847	-0.039
3	60	28.427	28.392	-0.035
3	61	29.275	29.298	0.024
3	62	29.230	29.239	0.009
3	134	29.042	28.989	-0.052
3	137	29.132	29.009	-0.124
3	138	29.273	28.910	-0.363
3	139	28.744	28.525	-0.219
3	236	28.652	28.463	-0.189
10	63	28.809	28.769	-0.041
10	64	29.179	28.957	-0.222
10	65	28.646	28.488	-0.157
10	66	29.230	29.076	-0.154
10	150	28.876	28.592	-0.284
10	237	28.944	28.438	-0.506
10	241	28.565	28.996	0.430
10	242	28.812	28.623	-0.188
10	243	29.157	28.951	-0.207
10	244	28.970	28.816	-0.154
30	141	28.748	28.435	-0.313
30	144	29.323	28.907	-0.416
30	145	29.336	29.129	-0.207
30	146	28.980	28.762	-0.219
30	147	28.498	28.164	-0.333
30	132	29.445	29.093	-0.353
30	133	28.817	28.404	-0.413
30	135	28.580	29.611	1.030
30	245	29.083	28.869	-0.215
30	246	28.592	28.362	-0.230
50	67	28.745	28.470	-0.275
50	68	28.963	28.882	-0.080
50	69	28.772	28.482	-0.290
50	71	29.558	29.386	-0.172
50	72	28.584	28.257	-0.327
50	172	29.108	28.776	-0.332
50	173	29.038	28.799	-0.239
50	174	28.862	28.570	-0.292
50	183	28.944	28.626	-0.318
50	186	29.583	29.252	-0.332
100	95	28.806	28.416	-0.390
100	102	29.017	28.330	-0.687
100	104	28.768	28.239	-0.529
100	105	28.978	28.610	-0.369
100	106	29.199	28.768	-0.431
100	178	28.868	28.331	-0.536
100	179	29.285	28.785	-0.499
100	180	29.044	28.738	-0.306
100	181	28.940	28.498	-0.442
100	182	29.207	28.563	-0.644
	Max	29.583	29.611	1.030
	Average	28.966	28.739	-0.227
	Min	28.427	28.164	-0.687
	Std Dev	0.269	0.322	0.264

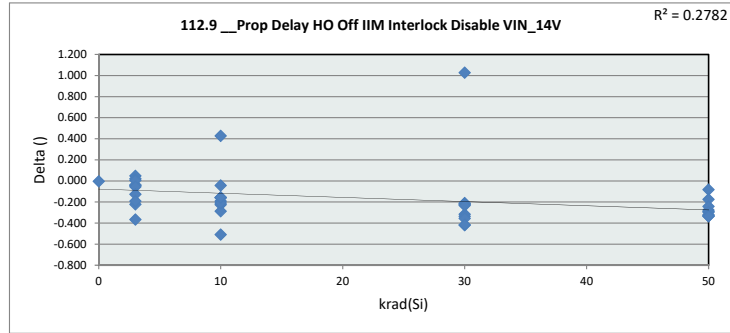

112.9 Prop Delay						
Test Site	DAL-FL					
Tester	ETS364					
Test Number	EB672302					
Max Limit	40					
Min Limit	1					
krad(Si)	0	3	10	30	50	100
LL	1.000	1.000	1.000	1.000	1.000	1.000
Min	28.819	28.392	28.438	28.164	28.257	28.239
Average	28.819	28.863	28.770	28.774	28.750	28.528
Max	28.819	29.298	29.076	29.611	29.386	28.786
UL	40.000	40.000	40.000	40.000	40.000	40.000

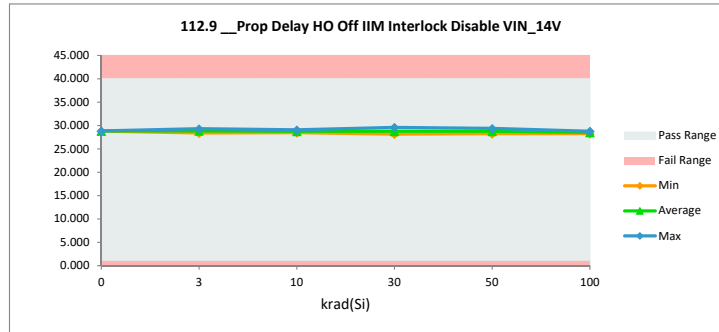

TID HDR Report
TPS7H6003-SP (5962R2220101VXC)

112.10 Delay Match LO On HO		
Test Site	DAL-FL	DAL-FL
Tester	ETS364	ETS364
Test Number	EB672302	EB672302
Unit	nsec	
Max Limit	12	
Min Limit		

krad(Si)	Serial #	pre_short (rtp)	(2)'ST_Combo (rpt)	Delta
0	Ctrl	5.088	5.088	0.000
3	58	5.110	5.161	0.052
3	59	4.887	4.894	0.007
3	60	4.674	4.605	-0.069
3	61	5.563	5.606	0.043
3	62	5.414	5.505	0.092
3	134	5.063	5.114	0.051
3	137	5.066	5.092	0.026
3	138	5.270	5.235	-0.035
3	139	4.841	4.902	0.062
3	236	4.864	4.951	0.087
10	63	4.935	4.888	-0.047
10	64	5.192	5.153	-0.039
10	65	4.829	4.851	0.022
10	66	5.600	5.692	0.093
10	150	4.706	4.590	-0.115
10	237	5.034	4.966	-0.068
10	241	4.795	5.072	0.277
10	242	4.961	5.103	0.142
10	243	5.527	5.537	0.010
10	244	5.194	5.215	0.022
30	141	4.820	4.903	0.083
30	144	5.281	5.260	-0.021
30	145	5.420	5.555	0.134
30	146	5.200	5.161	-0.039
30	147	4.656	4.754	0.098
30	132	5.396	5.281	-0.115
30	133	4.974	4.926	-0.048
30	135	4.873	5.837	0.964
30	245	5.106	5.037	-0.069
30	246	4.745	4.679	-0.066
50	67	4.974	4.878	-0.095
50	68	5.268	5.219	-0.049
50	69	4.918	4.925	0.007
50	71	5.601	5.739	0.138
50	72	4.876	4.792	-0.085
50	172	5.153	5.084	-0.069
50	173	5.123	5.102	-0.021
50	174	4.898	4.925	0.028
50	183	4.902	4.694	-0.207
50	186	5.576	5.535	-0.041
100	95	4.862	4.848	-0.014
100	102	5.216	4.988	-0.228
100	104	4.893	4.907	0.013
100	105	5.289	5.316	0.027
100	106	5.425	5.292	-0.133
100	178	5.014	4.939	-0.074
100	179	5.267	5.150	-0.117
100	180	5.030	5.010	-0.021
100	181	4.969	5.054	0.086
100	182	5.380	5.198	-0.181
	Max	5.601	5.837	0.964
	Average	5.092	5.102	0.010
	Min	4.656	4.590	-0.228
	Std Dev	0.257	0.288	0.165

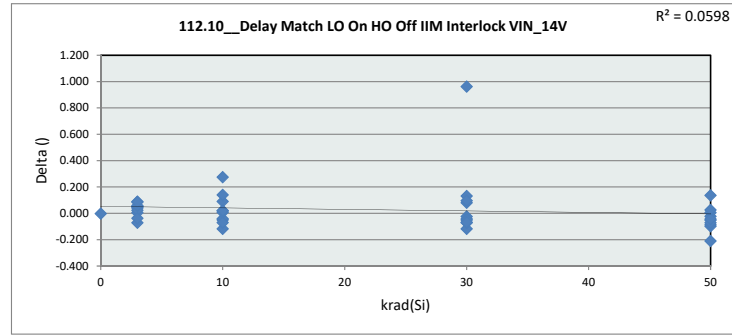

112.10 Delay Match	
Test Site	DAL-FL
Tester	ETS364
Test Number	EB672302
Max Limit	12
Min Limit	

krad(Si)	0	3	10	30	50	100
LL						
Min	5.088	4.605	4.590	4.679	4.694	4.848
Average	5.088	5.106	5.107	5.139	5.089	5.070
Max	5.088	5.606	5.692	5.837	5.739	5.316
UL	12.000	12.000	12.000	12.000	12.000	12.000

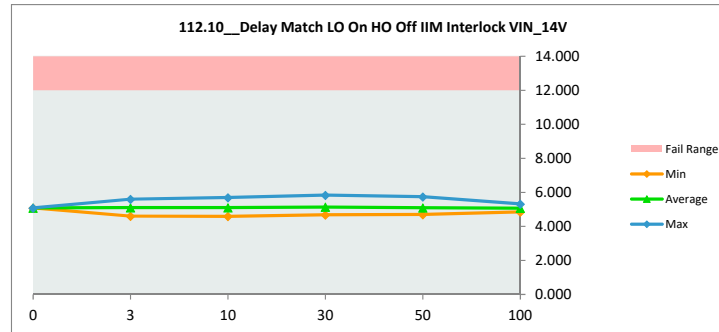

TID HDR Report
TPS7H6003-SP (5962R2220101VXC)

112.11 Delay Match LO Off HO		
Test Site	DAL-FL	DAL-FL
Tester	ETS364	ETS364
Test Number	EB672302	EB672302
Unit	nsec	
Max Limit	4	4
Min Limit		

krad(Si)	Serial #	pre_short (rtp)	(2)'ST_Combo (rpt)	Delta
0	Ctrl	1.377	1.377	0.000
3	58	0.942	1.041	0.099
3	59	1.189	1.249	0.061
3	60	1.275	1.509	0.234
3	61	0.773	0.918	0.144
3	62	0.748	0.918	0.170
3	134	1.337	0.882	-0.455
3	137	1.027	0.959	-0.068
3	138	0.770	0.933	0.163
3	139	0.901	1.118	0.217
3	236	1.460	1.062	-0.398
10	63	0.969	1.073	0.104
10	64	0.999	1.209	0.210
10	65	0.946	1.243	0.296
10	66	0.760	1.003	0.243
10	150	1.388	1.541	0.154
10	237	0.924	1.057	0.133
10	241	1.135	0.996	-0.139
10	242	1.403	1.487	0.084
10	243	0.878	1.106	0.229
10	244	0.871	1.152	0.281
30	141	1.221	1.442	0.221
30	144	0.945	1.227	0.281
30	145	0.558	0.797	0.239
30	146	1.121	1.402	0.281
30	147	1.092	1.461	0.369
30	132	0.859	1.048	0.189
30	133	0.951	1.207	0.256
30	135	0.834	0.775	-0.059
30	245	0.871	1.185	0.314
30	246	1.234	1.564	0.330
50	67	0.749	1.242	0.493
50	68	1.265	1.216	-0.049
50	69	0.959	1.242	0.284
50	71	0.530	0.832	0.302
50	72	1.284	1.563	0.278
50	172	0.644	0.800	0.156
50	173	0.808	1.201	0.392
50	174	1.348	1.348	0.000
50	183	1.376	1.722	0.347
50	186	0.539	0.725	0.185
100	95	1.001	1.273	0.272
100	102	1.159	1.644	0.485
100	104	1.047	1.445	0.398
100	105	1.035	1.292	0.258
100	106	0.928	1.464	0.536
100	178	0.992	1.319	0.326
100	179	1.113	1.566	0.453
100	180	1.135	1.547	0.412
100	181	1.102	1.306	0.205
100	182	0.967	1.281	0.314
	Max	1.460	1.722	0.536
	Average	1.014	1.215	0.201
	Min	0.530	0.725	-0.455
	Std Dev	0.233	0.250	0.195

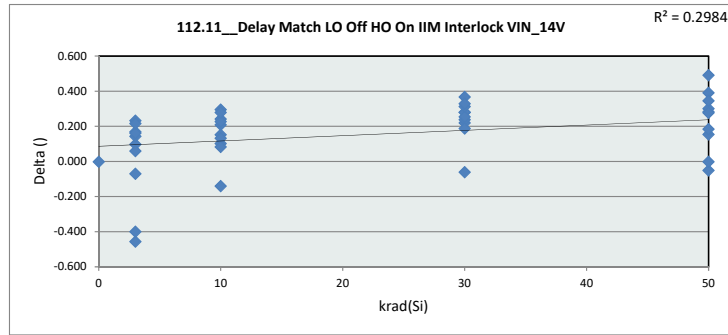

112.11 Delay Match	
Test Site	DAL-FL
Tester	ETS364
Test Number	EB672302
Max Limit	4
Min Limit	

krad(Si)	0	3	10	30	50	100
LL						
Min	1.377	0.882	0.996	0.775	0.725	1.273
Average	1.377	1.059	1.187	1.211	1.189	1.414
Max	1.377	1.509	1.541	1.564	1.722	1.644
UL	4.000	4.000	4.000	4.000	4.000	4.000

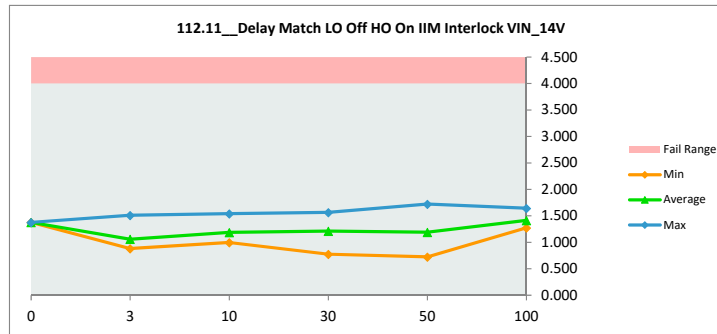

TID HDR Report
TPS7H6003-SP (5962R2220101VXC)

112.12 Delay Match LO On HO		
Test Site	DAL-FL	DAL-FL
Tester	ETS364	ETS364
Test Number	EB672302	EB672302
Unit	nsec	
Max Limit	12	12
Min Limit		

krad(Si)	Serial #	pre_short (rtp)	(2)'ST_Combo (rpt)	Delta
0	Ctrl	5.616	5.616	0.000
3	58	5.696	5.715	0.019
3	59	5.433	5.529	0.096
3	60	5.217	5.207	-0.011
3	61	6.063	6.174	0.111
3	62	5.938	5.951	0.012
3	134	5.585	5.705	0.120
3	137	5.623	5.738	0.115
3	138	5.841	5.681	-0.160
3	139	5.420	5.324	-0.096
3	236	5.426	5.533	0.107
10	63	5.470	5.502	0.032
10	64	5.752	5.667	-0.085
10	65	5.384	5.308	-0.076
10	66	6.218	6.197	-0.021
10	150	5.268	5.178	-0.090
10	237	5.592	5.501	-0.091
10	241	5.347	5.801	0.454
10	242	5.546	5.579	0.033
10	243	6.044	6.024	-0.020
10	244	5.774	5.841	0.067
30	141	5.401	5.345	-0.056
30	144	5.822	5.715	-0.107
30	145	6.000	6.033	0.033
30	146	5.736	5.760	0.024
30	147	5.211	5.162	-0.049
30	132	5.892	5.803	-0.089
30	133	5.602	5.371	-0.231
30	135	5.410	6.369	0.959
30	245	5.661	5.678	0.016
30	246	5.250	5.165	-0.085
50	67	5.531	5.531	-0.001
50	68	5.786	5.704	-0.082
50	69	5.483	5.405	-0.078
50	71	6.189	6.323	0.134
50	72	5.443	5.360	-0.083
50	172	5.738	5.675	-0.063
50	173	5.654	5.650	-0.004
50	174	5.441	5.477	0.036
50	183	5.426	5.403	-0.023
50	186	6.180	6.165	-0.015
100	95	5.398	5.441	0.043
100	102	5.837	5.528	-0.310
100	104	5.448	5.376	-0.072
100	105	5.844	5.896	0.052
100	106	5.958	5.737	-0.221
100	178	5.610	5.449	-0.162
100	179	5.823	5.684	-0.139
100	180	5.585	5.593	0.008
100	181	5.549	5.568	0.018
100	182	5.946	5.746	-0.201
	Max	6.218	6.369	0.959
	Average	5.649	5.645	-0.005
	Min	5.211	5.162	-0.310
	Std Dev	0.260	0.289	0.180

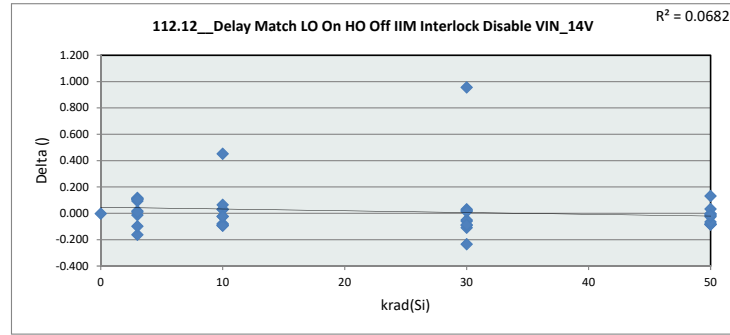

112.12 Delay Match

Test Site	DAL-FL
Tester	ETS364
Test Number	EB672302
Max Limit	12
Min Limit	

krad(Si)	0	3	10	30	50	100
LL						
Min	5.616	5.207	5.178	5.162	5.360	5.376
Average	5.616	5.656	5.660	5.640	5.669	5.602
Max	5.616	6.174	6.197	6.369	6.323	5.896
UL	12.000	12.000	12.000	12.000	12.000	12.000

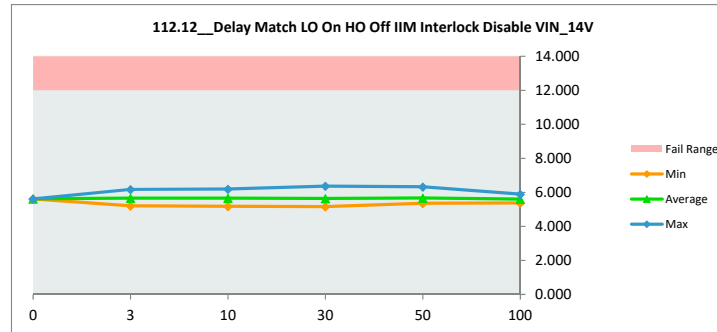

TID HDR Report
TPS7H6003-SP (5962R2220101VXC)

112.13 Delay Match LO Off HO		
Test Site	DAL-FL	DAL-FL
Tester	ETS364	ETS364
Test Number	EB672302	EB672302
Unit	nsec	
Max Limit	4	4
Min Limit		

krad(Si)	Serial #	pre_short (rtp)	(2)'ST_Combo (rpt)	Delta
0	Ctrl	1.307	1.307	0.000
3	58	0.967	1.077	0.110
3	59	1.162	1.337	0.175
3	60	1.341	1.442	0.100
3	61	0.793	1.008	0.216
3	62	0.740	0.873	0.132
3	134	1.300	0.986	-0.314
3	137	1.044	0.996	-0.049
3	138	0.784	0.976	0.192
3	139	0.860	1.093	0.233
3	236	1.405	1.099	-0.306
10	63	0.960	1.179	0.219
10	64	1.020	1.227	0.207
10	65	0.949	1.309	0.359
10	66	0.774	1.026	0.252
10	150	1.440	1.597	0.157
10	237	0.895	1.068	0.174
10	241	1.128	0.937	-0.191
10	242	1.335	1.495	0.160
10	243	0.848	1.045	0.197
10	244	0.823	1.171	0.348
30	141	1.159	1.469	0.310
30	144	0.943	1.225	0.281
30	145	0.556	0.851	0.295
30	146	1.121	1.459	0.337
30	147	1.098	1.350	0.251
30	132	0.848	0.968	0.120
30	133	0.998	1.216	0.218
30	135	0.872	0.758	-0.114
30	245	0.899	1.160	0.261
30	246	1.239	1.600	0.360
50	67	0.770	1.286	0.516
50	68	1.259	1.146	-0.113
50	69	0.970	1.249	0.279
50	71	0.538	0.903	0.365
50	72	1.289	1.615	0.326
50	172	0.614	0.854	0.240
50	173	0.825	1.219	0.393
50	174	1.342	1.404	0.062
50	183	1.308	1.785	0.477
50	186	0.518	0.849	0.331
100	95	0.993	1.366	0.373
100	102	1.154	1.548	0.394
100	104	1.051	1.357	0.306
100	105	0.981	1.261	0.280
100	106	0.931	1.561	0.630
100	178	0.974	1.388	0.414
100	179	1.094	1.447	0.353
100	180	1.079	1.534	0.455
100	181	1.050	1.377	0.327
100	182	0.934	1.375	0.441
	Max	1.440	1.785	0.630
	Average	1.006	1.232	0.226
	Min	0.518	0.758	-0.314
	Std Dev	0.227	0.242	0.194

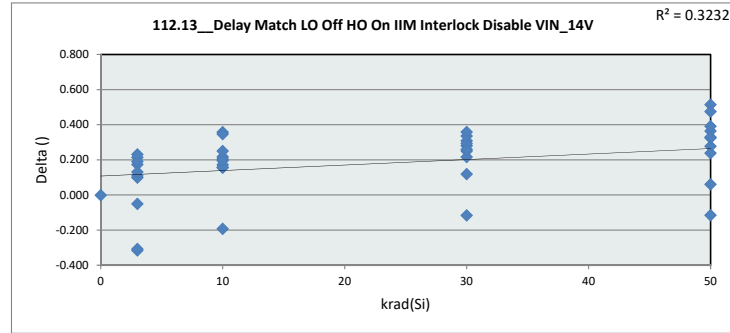

112.13 Delay Match	
Test Site	DAL-FL
Tester	ETS364
Test Number	EB672302
Max Limit	4
Min Limit	

krad(Si)	0	3	10	30	50	100
LL						
Min	1.307	0.873	0.937	0.758	0.849	1.261
Average	1.307	1.089	1.205	1.205	1.231	1.421
Max	1.307	1.442	1.598	1.600	1.785	1.561
UL	4.000	4.000	4.000	4.000	4.000	4.000

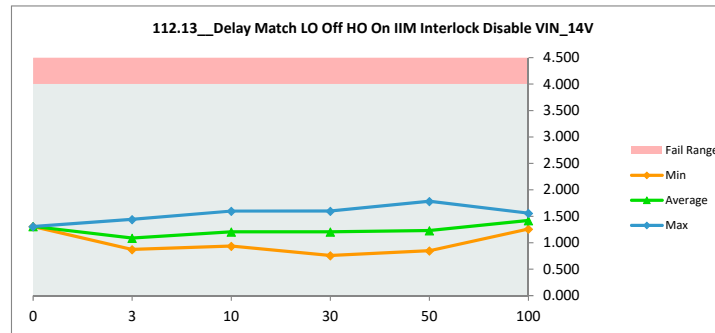

TID HDR Report
TPS7H6003-SP (5962R2220101VXC)

115.0 Rise Time HO VIN_10V		
Test Site	DAL-FL	DAL-FL
Tester	ETS364	ETS364
Test Number	EB672302	EB672302
Unit	nsec	
Max Limit	7.5	7.5
Min Limit	1	1

krad(Si)	Serial #	pre_short (rtp)	(2)ST_Combo (rpt)	Delta
0	Ctrl	3.677	3.677	0.000
3	58	3.570	3.630	0.060
3	59	3.569	3.681	0.112
3	60	3.560	3.675	0.114
3	61	3.577	3.628	0.051
3	62	3.575	3.680	0.105
3	134	3.580	3.641	0.060
3	137	3.566	3.638	0.072
3	138	3.574	3.645	0.072
3	139	3.566	3.624	0.058
3	236	3.569	3.621	0.052
10	63	3.577	3.672	0.095
10	64	3.566	3.631	0.064
10	65	3.554	3.671	0.117
10	66	3.571	3.614	0.043
10	150	3.575	3.670	0.095
10	237	3.577	3.620	0.043
10	241	3.570	3.641	0.072
10	242	3.576	3.677	0.101
10	243	3.567	3.668	0.100
10	244	3.559	3.608	0.050
30	141	3.569	3.674	0.104
30	144	3.581	3.682	0.102
30	145	3.576	3.619	0.043
30	146	3.574	3.676	0.102
30	147	3.569	3.628	0.059
30	132	3.566	3.621	0.055
30	133	3.582	3.629	0.047
30	135	3.577	3.624	0.048
30	245	3.563	3.627	0.064
30	246	3.579	3.685	0.106
50	67	3.568	3.621	0.053
50	68	3.572	3.616	0.044
50	69	3.574	3.670	0.096
50	71	3.577	3.625	0.048
50	72	3.560	3.674	0.114
50	172	3.579	3.622	0.043
50	173	3.568	3.626	0.058
50	174	3.579	3.667	0.089
50	183	3.576	3.632	0.056
50	186	3.588	3.620	0.032
100	95	3.571	3.634	0.063
100	102	3.571	3.672	0.101
100	104	3.576	3.657	0.081
100	105	3.575	3.615	0.039
100	106	3.574	3.622	0.048
100	178	3.575	3.627	0.053
100	179	3.565	3.604	0.039
100	180	3.568	3.666	0.098
100	181	3.562	3.619	0.056
100	182	3.571	3.612	0.041
	Max	3.677	3.685	0.117
	Average	3.574	3.643	0.069
	Min	3.554	3.604	0.000
	Std Dev	0.016	0.025	0.027

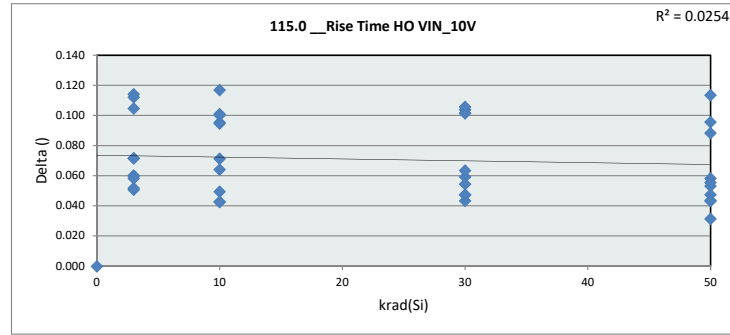

115.0 Rise Time H						
Test Site	DAL-FL					
Tester	ETS364					
Test Number	EB672302					
Max Limit	7.5					
Min Limit	1					
krad(Si)	0	3	10	30	50	100
LL	1.000	1.000	1.000	1.000	1.000	1.000
Min	3.677	3.621	3.608	3.619	3.616	3.604
Average	3.677	3.646	3.647	3.647	3.637	3.633
Max	3.677	3.681	3.677	3.685	3.674	3.672
UL	7.500	7.500	7.500	7.500	7.500	7.500

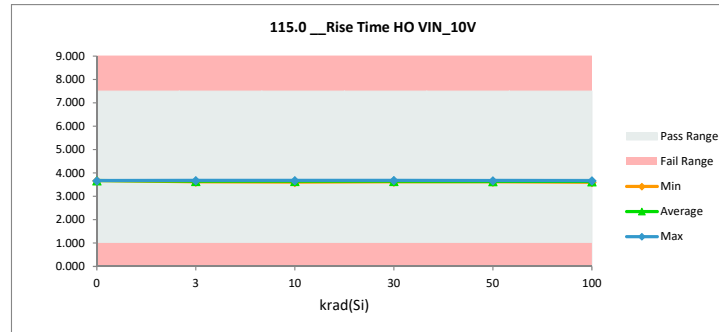

TID HDR Report
TPS7H6003-SP (5962R2220101VXC)

115.1 Fall Time HO VIN_10V		
Test Site	DAL-FL	DAL-FL
Tester	ETS364	ETS364
Test Number	EB672302	EB672302
Unit	nsec	
Max Limit	5.5	5.5
Min Limit	1	1

krad(Si)	Serial #	pre_short (rtp)	(2)'ST_Combo (rpt)	Delta
0	Ctrl	3.758	3.758	0.000
3	58	3.844	3.747	-0.096
3	59	3.842	3.753	-0.088
3	60	3.850	3.757	-0.093
3	61	3.863	3.757	-0.106
3	62	3.862	3.778	-0.084
3	134	3.875	3.753	-0.122
3	137	3.851	3.760	-0.091
3	138	3.859	3.759	-0.100
3	139	3.870	3.744	-0.125
3	236	3.851	3.725	-0.126
10	63	3.867	3.777	-0.091
10	64	3.852	3.745	-0.107
10	65	3.837	3.757	-0.080
10	66	3.851	3.743	-0.108
10	150	3.855	3.770	-0.085
10	237	3.878	3.731	-0.146
10	241	3.854	3.751	-0.103
10	242	3.854	3.742	-0.112
10	243	3.857	3.758	-0.099
10	244	3.850	3.748	-0.102
30	141	3.848	3.760	-0.087
30	144	3.869	3.787	-0.082
30	145	3.856	3.742	-0.114
30	146	3.863	3.794	-0.069
30	147	3.842	3.755	-0.086
30	132	3.855	3.760	-0.095
30	133	3.869	3.751	-0.118
30	135	3.857	3.748	-0.109
30	245	3.857	3.741	-0.116
30	246	3.850	3.768	-0.082
50	67	3.854	3.750	-0.104
50	68	3.853	3.740	-0.113
50	69	3.867	3.763	-0.103
50	71	3.873	3.756	-0.117
50	72	3.858	3.784	-0.074
50	172	3.854	3.779	-0.075
50	173	3.855	3.754	-0.100
50	174	3.862	3.785	-0.077
50	183	3.877	3.756	-0.121
50	186	3.863	3.773	-0.091
100	95	3.855	3.779	-0.076
100	102	3.864	3.789	-0.076
100	104	3.847	3.763	-0.085
100	105	3.850	3.744	-0.106
100	106	3.852	3.803	-0.049
100	178	3.869	3.751	-0.119
100	179	3.853	3.751	-0.102
100	180	3.855	3.795	-0.060
100	181	3.845	3.761	-0.084
100	182	3.844	3.739	-0.106
Max		3.878	3.803	0.000
Average		3.855	3.760	-0.095
Min		3.758	3.725	-0.146
Std Dev		0.017	0.017	0.023

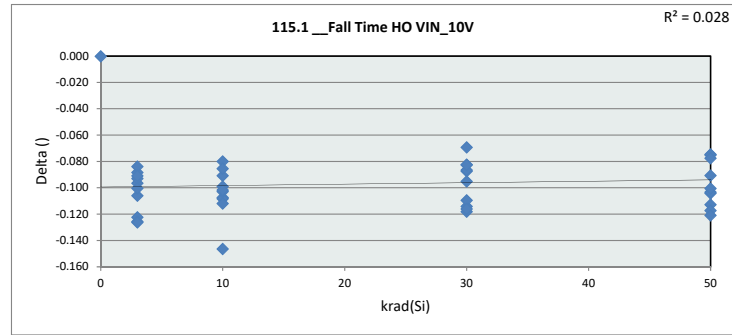

115.1 Fall Time H	
Test Site	DAL-FL
Tester	ETS364
Test Number	EB672302
Max Limit	5.5
Min Limit	1

krad(Si)	0	3	10	30	50	100
LL	1.000	1.000	1.000	1.000	1.000	1.000
Min	3.758	3.725	3.731	3.741	3.740	3.739
Average	3.758	3.754	3.752	3.761	3.764	3.767
Max	3.758	3.778	3.777	3.794	3.785	3.803
UL	5.500	5.500	5.500	5.500	5.500	5.500

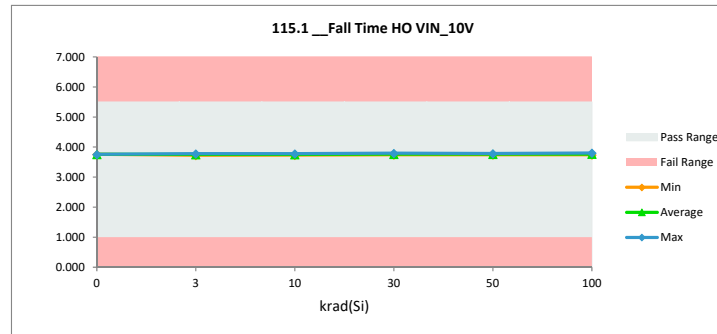

TID HDR Report
TPS7H6003-SP (5962R2220101VXC)

115.2 Rise Time LO VIN_10V		
Test Site	DAL-FL	DAL-FL
Tester	ETS364	ETS364
Test Number	EB672302	EB672302
Unit	nsec	
Max Limit	7.5	7.5
Min Limit	1	1

krad(Si)	Serial #	pre_short (rtp)	(2)'ST_Combo (rpt)	Delta
0	Ctrl	2.997	2.997	0.000
3	58	2.956	3.006	0.050
3	59	2.965	3.010	0.045
3	60	2.952	3.005	0.053
3	61	2.964	3.009	0.045
3	62	2.955	3.014	0.059
3	134	2.980	3.018	0.038
3	137	2.962	3.016	0.054
3	138	2.966	3.021	0.054
3	139	2.966	3.009	0.042
3	236	2.960	3.008	0.047
10	63	2.958	3.019	0.061
10	64	2.959	3.013	0.054
10	65	2.941	3.002	0.061
10	66	2.943	3.002	0.059
10	150	2.975	3.028	0.053
10	237	2.965	3.000	0.034
10	241	2.970	3.022	0.052
10	242	2.981	3.016	0.035
10	243	2.958	3.013	0.055
10	244	2.949	2.999	0.050
30	141	2.967	3.006	0.039
30	144	2.963	2.990	0.028
30	145	2.966	3.008	0.042
30	146	2.956	3.007	0.051
30	147	2.949	2.990	0.041
30	132	2.968	3.016	0.048
30	133	2.974	3.003	0.030
30	135	2.955	3.013	0.058
30	245	2.946	3.009	0.064
30	246	2.948	2.988	0.041
50	67	2.960	3.006	0.046
50	68	2.966	2.987	0.021
50	69	2.964	3.007	0.042
50	71	2.964	3.020	0.056
50	72	2.942	2.996	0.053
50	172	2.973	2.976	0.002
50	173	2.973	3.014	0.041
50	174	2.967	3.010	0.043
50	183	2.972	3.008	0.036
50	186	2.961	3.019	0.057
100	95	2.956	3.013	0.057
100	102	2.958	3.010	0.052
100	104	2.954	3.014	0.060
100	105	2.963	2.980	0.018
100	106	2.948	3.033	0.085
100	178	2.962	3.005	0.043
100	179	2.951	3.012	0.060
100	180	2.954	3.012	0.058
100	181	2.967	3.015	0.049
100	182	2.958	2.996	0.038
Max		2.997	3.033	0.085
Average		2.961	3.008	0.046
Min		2.941	2.976	0.000
Std Dev		0.011	0.011	0.015

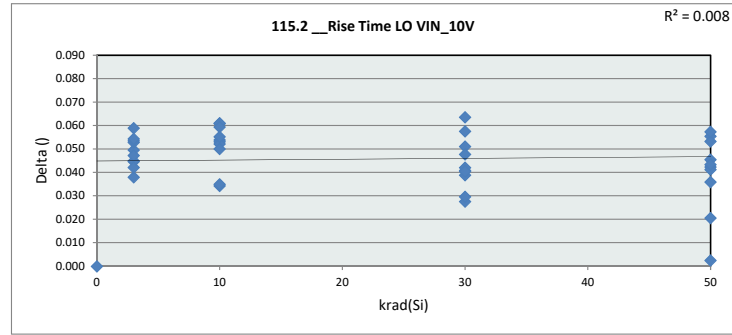

115.2 Rise Time L	
Test Site	DAL-FL
Tester	ETS364
Test Number	EB672302
Max Limit	7.5
Min Limit	1

krad(Si)	0	3	10	30	50	100
LL	1.000	1.000	1.000	1.000	1.000	1.000
Min	2.997	3.005	2.999	2.988	2.976	2.980
Average	2.997	3.011	3.011	3.003	3.004	3.009
Max	2.997	3.021	3.028	3.016	3.020	3.033
UL	7.500	7.500	7.500	7.500	7.500	7.500

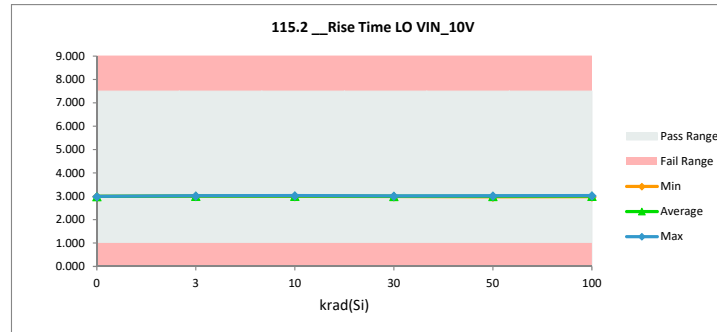

TID HDR Report

TPS7H6003-SP (5962R2220101VXC)

115.3 Fall Time LO VIN_10V		
Test Site	DAL-FL	DAL-FL
Tester	ETS364	ETS364
Test Number	EB672302	EB672302
Unit	nsec	
Max Limit	5.5	5.5
Min Limit	1	1

krad(Si)	Serial #	pre_short (rtp)	(2)ST_Combo (rpt)	Delta
0	Ctrl	3.197	3.197	0.000
3	58	3.284	3.199	-0.086
3	59	3.301	3.194	-0.107
3	60	3.301	3.197	-0.104
3	61	3.314	3.196	-0.118
3	62	3.315	3.188	-0.127
3	134	3.331	3.205	-0.125
3	137	3.321	3.209	-0.112
3	138	3.307	3.210	-0.097
3	139	3.304	3.239	-0.065
3	236	3.319	3.166	-0.153
10	63	3.306	3.191	-0.115
10	64	3.302	3.192	-0.110
10	65	3.265	3.163	-0.101
10	66	3.293	3.174	-0.119
10	150	3.312	3.209	-0.103
10	237	3.313	3.178	-0.135
10	241	3.313	3.210	-0.103
10	242	3.326	3.201	-0.125
10	243	3.306	3.195	-0.111
10	244	3.293	3.187	-0.106
30	141	3.317	3.189	-0.129
30	144	3.300	3.176	-0.125
30	145	3.311	3.181	-0.130
30	146	3.294	3.186	-0.108
30	147	3.282	3.173	-0.109
30	132	3.316	3.207	-0.109
30	133	3.325	3.198	-0.127
30	135	3.312	3.195	-0.117
30	245	3.295	3.176	-0.119
30	246	3.286	3.171	-0.115
50	67	3.310	3.198	-0.112
50	68	3.323	3.177	-0.146
50	69	3.319	3.165	-0.154
50	71	3.311	3.198	-0.113
50	72	3.288	3.174	-0.113
50	172	3.314	3.187	-0.127
50	173	3.310	3.195	-0.115
50	174	3.311	3.179	-0.132
50	183	3.316	3.192	-0.124
50	186	3.307	3.185	-0.123
100	95	3.289	3.204	-0.085
100	102	3.309	3.202	-0.107
100	104	3.310	3.197	-0.113
100	105	3.307	3.178	-0.129
100	106	3.302	3.221	-0.081
100	178	3.319	3.181	-0.138
100	179	3.293	3.194	-0.098
100	180	3.311	3.218	-0.093
100	181	3.320	3.185	-0.135
100	182	3.303	3.187	-0.117
	Max	3.331	3.239	0.000
	Average	3.305	3.192	-0.113
	Min	3.197	3.163	-0.154
	Std Dev	0.020	0.015	0.024

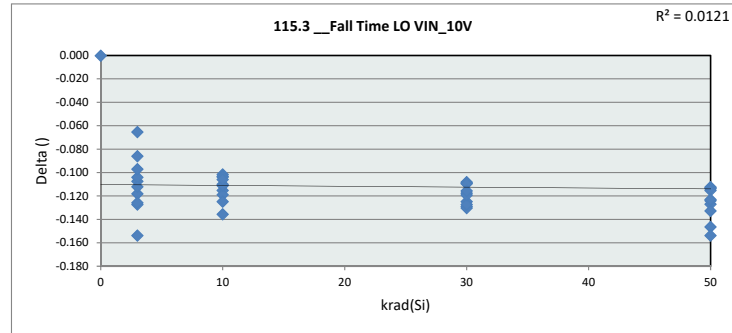

115.3 Fall Time LO						
Test Site	DAL-FL					
Tester	ETS364					
Test Number	EB672302					
Max Limit	5.5					
Min Limit	1					
krad(Si)	0	3	10	30	50	100
LL	1.000	1.000	1.000	1.000	1.000	1.000
Min	3.197	3.166	3.163	3.171	3.165	3.178
Average	3.197	3.200	3.190	3.185	3.185	3.197
Max	3.197	3.239	3.210	3.207	3.199	3.222
UL	5.500	5.500	5.500	5.500	5.500	5.500

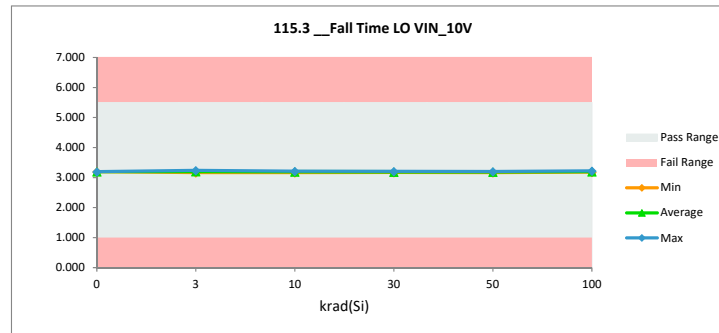

TID HDR Report

TPS7H6003-SP (5962R2220101VXC)

116.0 Rise Time HO VIN_12V		
Test Site	DAL-FL	DAL-FL
Tester	ETS364	ETS364
Test Number	EB672302	EB672302
Unit	nsec	
Max Limit	7.5	7.5
Min Limit	1	1

krad(Si)	Serial #	pre_short (rtp)	(2)'ST_Combo (rpt)	Delta
0	Ctrl	3.675	3.675	0.000
3	58	3.569	3.616	0.047
3	59	3.565	3.676	0.111
3	60	3.566	3.665	0.099
3	61	3.577	3.626	0.049
3	62	3.579	3.669	0.089
3	134	3.585	3.634	0.049
3	137	3.572	3.631	0.059
3	138	3.578	3.638	0.059
3	139	3.572	3.626	0.054
3	236	3.573	3.618	0.045
10	63	3.581	3.682	0.102
10	64	3.566	3.630	0.064
10	65	3.549	3.667	0.118
10	66	3.571	3.619	0.048
10	150	3.577	3.678	0.100
10	237	3.579	3.614	0.035
10	241	3.576	3.639	0.063
10	242	3.577	3.680	0.102
10	243	3.572	3.660	0.088
10	244	3.560	3.615	0.055
30	141	3.573	3.673	0.099
30	144	3.583	3.683	0.100
30	145	3.576	3.632	0.056
30	146	3.576	3.683	0.107
30	147	3.568	3.624	0.056
30	132	3.569	3.632	0.063
30	133	3.581	3.624	0.044
30	135	3.580	3.628	0.047
30	245	3.561	3.626	0.065
30	246	3.579	3.682	0.103
50	67	3.567	3.615	0.048
50	68	3.574	3.618	0.044
50	69	3.580	3.675	0.095
50	71	3.581	3.617	0.036
50	72	3.564	3.675	0.110
50	172	3.578	3.635	0.057
50	173	3.563	3.628	0.066
50	174	3.574	3.677	0.103
50	183	3.579	3.639	0.060
50	186	3.580	3.635	0.055
100	95	3.569	3.626	0.057
100	102	3.580	3.678	0.098
100	104	3.574	3.660	0.087
100	105	3.572	3.599	0.027
100	106	3.575	3.627	0.052
100	178	3.583	3.639	0.056
100	179	3.556	3.619	0.062
100	180	3.567	3.673	0.106
100	181	3.561	3.629	0.068
100	182	3.567	3.617	0.050
	Max	3.675	3.683	0.118
	Average	3.575	3.644	0.069
	Min	3.549	3.599	0.000
	Std Dev	0.016	0.025	0.027

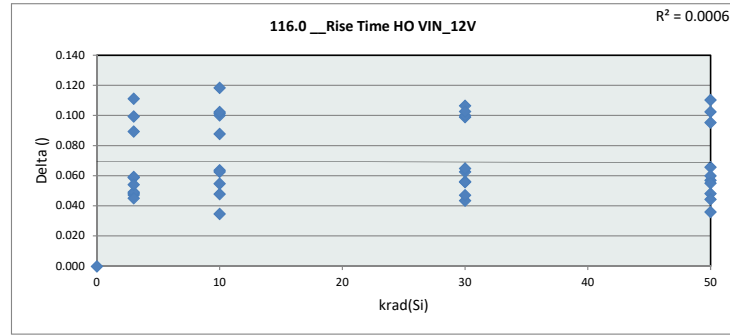

116.0 Rise Time H

Test Site	DAL-FL
Tester	ETS364
Test Number	EB672302
Max Limit	7.5
Min Limit	1

krad(Si)	0	3	10	30	50	100
LL	1.000	1.000	1.000	1.000	1.000	1.000
Min	3.675	3.616	3.614	3.624	3.616	3.599
Average	3.675	3.640	3.648	3.649	3.641	3.637
Max	3.675	3.676	3.682	3.683	3.677	3.678
UL	7.500	7.500	7.500	7.500	7.500	7.500

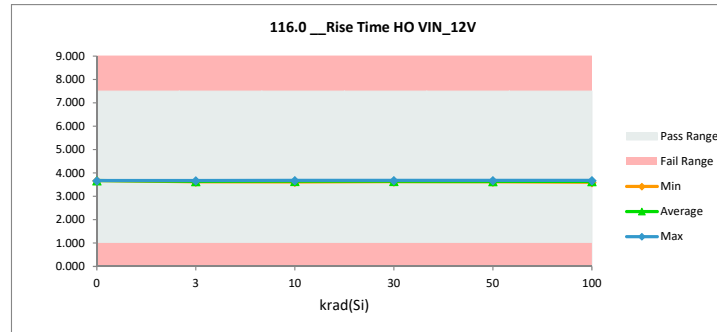

TID HDR Report
TPS7H6003-SP (5962R2220101VXC)

116.1 Fall Time HO VIN_12V		
Test Site	DAL-FL	DAL-FL
Tester	ETS364	ETS364
Test Number	EB672302	EB672302
Unit	nsec	
Max Limit	5.5	5.5
Min Limit	1	1

krad(Si)	Serial #	pre_short (rtp)	(2)ST_Combo (rpt)	Delta
0	Ctrl	3.758	3.758	0.000
3	58	3.838	3.756	-0.082
3	59	3.846	3.774	-0.072
3	60	3.852	3.764	-0.088
3	61	3.853	3.761	-0.092
3	62	3.857	3.764	-0.094
3	134	3.863	3.756	-0.107
3	137	3.845	3.751	-0.094
3	138	3.861	3.755	-0.105
3	139	3.853	3.756	-0.097
3	236	3.842	3.731	-0.111
10	63	3.853	3.779	-0.074
10	64	3.846	3.741	-0.105
10	65	3.834	3.739	-0.095
10	66	3.845	3.739	-0.106
10	150	3.854	3.750	-0.104
10	237	3.853	3.731	-0.123
10	241	3.859	3.755	-0.104
10	242	3.849	3.756	-0.093
10	243	3.843	3.756	-0.088
10	244	3.853	3.742	-0.110
30	141	3.853	3.759	-0.095
30	144	3.862	3.769	-0.093
30	145	3.853	3.747	-0.105
30	146	3.853	3.778	-0.075
30	147	3.846	3.747	-0.099
30	132	3.861	3.753	-0.108
30	133	3.861	3.738	-0.123
30	135	3.849	3.751	-0.098
30	245	3.850	3.750	-0.100
30	246	3.851	3.764	-0.087
50	67	3.840	3.744	-0.096
50	68	3.859	3.751	-0.108
50	69	3.863	3.769	-0.094
50	71	3.852	3.756	-0.097
50	72	3.855	3.760	-0.095
50	172	3.862	3.753	-0.110
50	173	3.856	3.746	-0.111
50	174	3.857	3.748	-0.109
50	183	3.875	3.767	-0.109
50	186	3.868	3.755	-0.113
100	95	3.849	3.753	-0.096
100	102	3.853	3.779	-0.074
100	104	3.853	3.770	-0.082
100	105	3.857	3.752	-0.105
100	106	3.855	3.788	-0.067
100	178	3.854	3.744	-0.110
100	179	3.843	3.766	-0.077
100	180	3.849	3.763	-0.086
100	181	3.842	3.749	-0.093
100	182	3.848	3.744	-0.104
	Max	3.875	3.788	0.000
	Average	3.851	3.755	-0.095
	Min	3.758	3.731	-0.123
	Std Dev	0.015	0.012	0.019

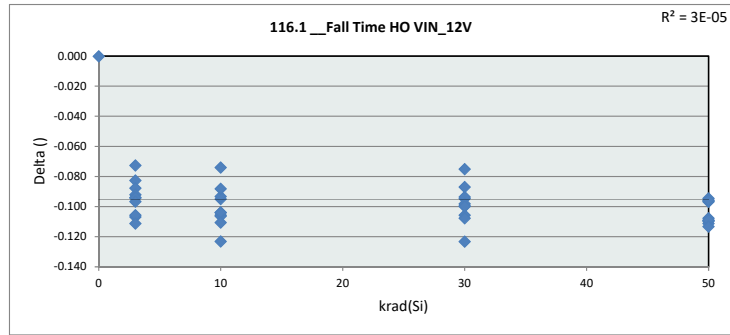

116.1 Fall Time HO VIN_12V

Test Site	DAL-FL
Tester	ETS364
Test Number	EB672302
Max Limit	5.5
Min Limit	1

krad(Si)	0	3	10	30	50	100
LL	1.000	1.000	1.000	1.000	1.000	1.000
Min	3.758	3.731	3.731	3.738	3.744	3.744
Average	3.758	3.757	3.749	3.756	3.755	3.761
Max	3.758	3.774	3.779	3.778	3.769	3.788
UL	5.500	5.500	5.500	5.500	5.500	5.500

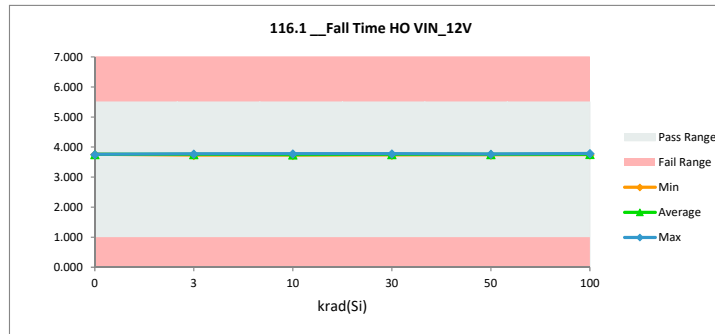

TID HDR Report
TPS7H6003-SP (5962R2220101VXC)

116.2 Rise Time LO VIN_12V		
Test Site	DAL-FL	DAL-FL
Tester	ETS364	ETS364
Test Number	EB672302	EB672302
Unit	nsec	
Max Limit	7.5	7.5
Min Limit	1	1

krad(Si)	Serial #	pre_short (rtp)	(2)ST_Combo (rpt)	Delta
0	Ctrl	3.007	3.007	0.000
3	58	2.953	3.015	0.062
3	59	2.958	3.019	0.061
3	60	2.942	3.015	0.073
3	61	2.965	3.013	0.048
3	62	2.957	3.003	0.047
3	134	2.982	3.030	0.048
3	137	2.962	3.029	0.067
3	138	2.961	3.032	0.071
3	139	2.967	3.011	0.044
3	236	2.964	3.012	0.048
10	63	2.951	3.005	0.054
10	64	2.957	3.006	0.048
10	65	2.939	2.994	0.054
10	66	2.941	3.005	0.064
10	150	2.973	3.015	0.042
10	237	2.962	3.005	0.043
10	241	2.972	3.030	0.059
10	242	2.983	3.028	0.045
10	243	2.955	3.009	0.054
10	244	2.950	2.999	0.049
30	141	2.967	3.013	0.046
30	144	2.961	2.993	0.032
30	145	2.967	3.008	0.041
30	146	2.955	3.012	0.057
30	147	2.947	3.000	0.054
30	132	2.965	3.004	0.039
30	133	2.974	3.014	0.040
30	135	2.954	2.999	0.045
30	245	2.952	3.006	0.054
30	246	2.949	2.997	0.048
50	67	2.952	3.012	0.060
50	68	2.971	2.994	0.022
50	69	2.960	2.992	0.032
50	71	2.959	3.008	0.049
50	72	2.949	2.993	0.044
50	172	2.965	2.982	0.017
50	173	2.967	3.022	0.056
50	174	2.959	2.995	0.036
50	183	2.972	3.016	0.044
50	186	2.966	3.023	0.057
100	95	2.948	3.003	0.055
100	102	2.948	2.998	0.050
100	104	2.960	2.999	0.039
100	105	2.967	2.971	0.004
100	106	2.949	3.032	0.083
100	178	2.964	3.009	0.045
100	179	2.949	3.008	0.059
100	180	2.954	3.022	0.067
100	181	2.970	3.003	0.033
100	182	2.955	2.984	0.029
Max		3.007	3.032	0.083
Average		2.960	3.008	0.047
Min		2.939	2.971	0.000
Std Dev		0.012	0.013	0.016

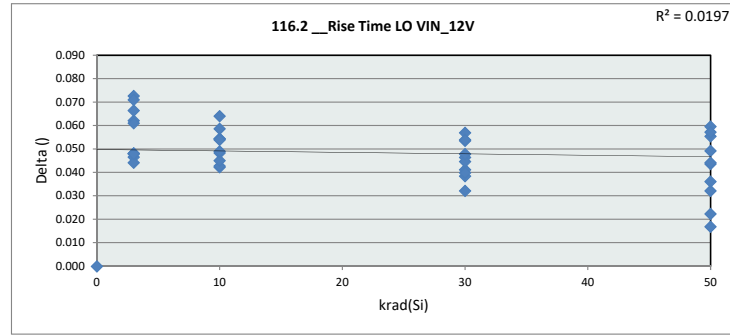

116.2 Rise Time L	
Test Site	DAL-FL
Tester	ETS364
Test Number	EB672302
Max Limit	7.5
Min Limit	1

krad(Si)	0	3	10	30	50	100
LL	1.000	1.000	1.000	1.000	1.000	1.000
Min	3.007	3.003	2.994	2.993	2.982	2.971
Average	3.007	3.018	3.010	3.005	3.004	3.003
Max	3.007	3.032	3.031	3.014	3.023	3.032
UL	7.500	7.500	7.500	7.500	7.500	7.500

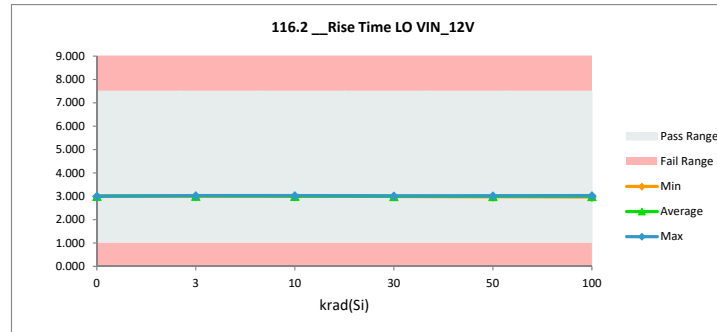

TID HDR Report
TPS7H6003-SP (5962R2220101VXC)

116.3 Fall Time LO VIN_12V		
Test Site	DAL-FL	DAL-FL
Tester	ETS364	ETS364
Test Number	EB672302	EB672302
Unit	nsec	
Max Limit	5.5	5.5
Min Limit	1	1

krad(Si)	Serial #	pre_short (rtp)	(2)ST_Combo (rpt)	Delta
0	Ctrl	3.184	3.184	0.000
3	58	3.295	3.194	-0.102
3	59	3.306	3.193	-0.114
3	60	3.303	3.190	-0.113
3	61	3.319	3.191	-0.128
3	62	3.315	3.183	-0.132
3	134	3.336	3.196	-0.140
3	137	3.312	3.205	-0.107
3	138	3.300	3.205	-0.095
3	139	3.297	3.237	-0.060
3	236	3.311	3.171	-0.139
10	63	3.306	3.199	-0.107
10	64	3.304	3.184	-0.120
10	65	3.272	3.174	-0.099
10	66	3.283	3.175	-0.109
10	150	3.311	3.213	-0.098
10	237	3.307	3.164	-0.143
10	241	3.313	3.200	-0.113
10	242	3.326	3.190	-0.136
10	243	3.298	3.187	-0.112
10	244	3.295	3.181	-0.113
30	141	3.315	3.181	-0.134
30	144	3.306	3.170	-0.136
30	145	3.310	3.185	-0.125
30	146	3.294	3.183	-0.110
30	147	3.282	3.166	-0.117
30	132	3.315	3.212	-0.103
30	133	3.326	3.185	-0.141
30	135	3.312	3.197	-0.115
30	245	3.299	3.173	-0.125
30	246	3.292	3.165	-0.127
50	67	3.309	3.190	-0.118
50	68	3.331	3.171	-0.160
50	69	3.314	3.175	-0.139
50	71	3.307	3.202	-0.105
50	72	3.279	3.171	-0.108
50	172	3.318	3.190	-0.128
50	173	3.311	3.191	-0.120
50	174	3.312	3.181	-0.132
50	183	3.314	3.192	-0.122
50	186	3.315	3.191	-0.125
100	95	3.297	3.192	-0.104
100	102	3.305	3.202	-0.103
100	104	3.310	3.201	-0.110
100	105	3.315	3.178	-0.138
100	106	3.298	3.220	-0.078
100	178	3.314	3.187	-0.127
100	179	3.299	3.200	-0.099
100	180	3.316	3.222	-0.094
100	181	3.324	3.196	-0.128
100	182	3.309	3.187	-0.121
	Max	3.336	3.237	0.000
	Average	3.305	3.190	-0.115
	Min	3.184	3.164	-0.160
	Std Dev	0.021	0.015	0.024

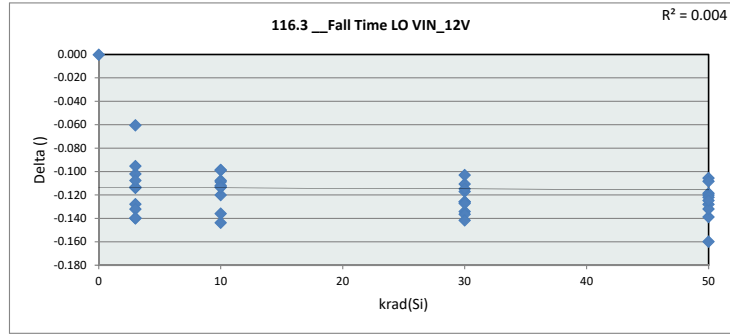

116.3 Fall Time LO

Test Site	DAL-FL
Tester	ETS364
Test Number	EB672302
Max Limit	5.5
Min Limit	1

krad(Si)	0	3	10	30	50	100
LL	1.000	1.000	1.000	1.000	1.000	1.000
Min	3.184	3.172	3.164	3.165	3.171	3.178
Average	3.184	3.196	3.187	3.182	3.185	3.198
Max	3.184	3.237	3.213	3.212	3.202	3.222
UL	5.500	5.500	5.500	5.500	5.500	5.500

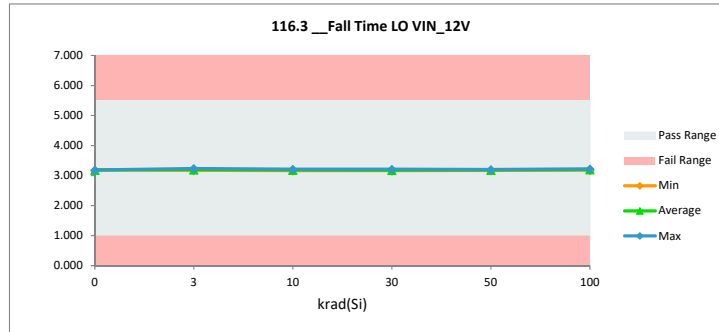

TID HDR Report

TPS7H6003-SP (5962R2220101VXC)

117.0 Rise Time HO VIN_14V		
Test Site	DAL-FL	DAL-FL
Tester	ETS364	ETS364
Test Number	EB672302	EB672302
Unit	nsec	
Max Limit	7.5	7.5
Min Limit	1	1

krad(Si)	Serial #	pre_short (rtp)	(2)ST_Combo (rpt)	Delta
0	Ctrl	3.675	3.675	0.000
3	58	3.571	3.630	0.059
3	59	3.563	3.685	0.121
3	60	3.564	3.676	0.112
3	61	3.582	3.629	0.047
3	62	3.578	3.684	0.106
3	134	3.579	3.646	0.067
3	137	3.568	3.647	0.079
3	138	3.579	3.646	0.067
3	139	3.574	3.614	0.039
3	236	3.570	3.624	0.054
10	63	3.578	3.682	0.104
10	64	3.572	3.627	0.055
10	65	3.558	3.674	0.116
10	66	3.573	3.613	0.040
10	150	3.579	3.675	0.096
10	237	3.585	3.623	0.038
10	241	3.578	3.647	0.069
10	242	3.579	3.681	0.101
10	243	3.575	3.676	0.101
10	244	3.560	3.609	0.049
30	141	3.575	3.674	0.100
30	144	3.580	3.682	0.102
30	145	3.574	3.624	0.050
30	146	3.578	3.676	0.098
30	147	3.566	3.634	0.068
30	132	3.571	3.623	0.052
30	133	3.576	3.634	0.057
30	135	3.580	3.621	0.040
30	245	3.569	3.621	0.052
30	246	3.580	3.682	0.102
50	67	3.570	3.625	0.056
50	68	3.573	3.609	0.036
50	69	3.584	3.677	0.093
50	71	3.579	3.626	0.046
50	72	3.566	3.682	0.116
50	172	3.582	3.621	0.039
50	173	3.570	3.623	0.053
50	174	3.578	3.681	0.103
50	183	3.581	3.627	0.046
50	186	3.589	3.632	0.042
100	95	3.572	3.634	0.062
100	102	3.577	3.676	0.100
100	104	3.575	3.661	0.086
100	105	3.578	3.614	0.036
100	106	3.574	3.632	0.057
100	178	3.578	3.641	0.062
100	179	3.566	3.612	0.046
100	180	3.571	3.677	0.105
100	181	3.569	3.633	0.065
100	182	3.566	3.615	0.049
	Max	3.675	3.685	0.121
	Average	3.576	3.646	0.069
	Min	3.558	3.609	0.000
	Std Dev	0.016	0.027	0.028

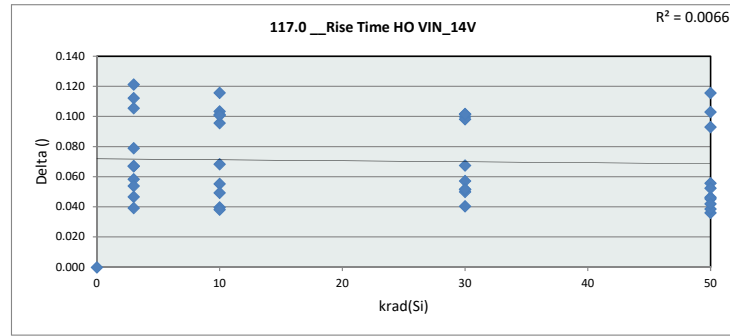

117.0 Rise Time H	
Test Site	DAL-FL
Tester	ETS364
Test Number	EB672302
Max Limit	7.5
Min Limit	1

krad(Si)	0	3	10	30	50	100
LL	1.000	1.000	1.000	1.000	1.000	1.000
Min	3.676	3.614	3.610	3.621	3.609	3.612
Average	3.676	3.648	3.651	3.647	3.640	3.640
Max	3.676	3.685	3.682	3.682	3.682	3.677
UL	7.500	7.500	7.500	7.500	7.500	7.500

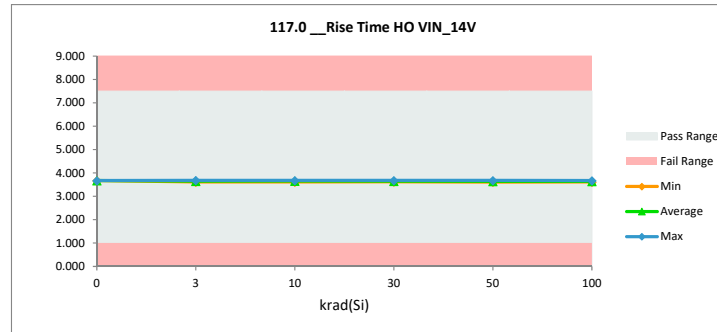

TID HDR Report
TPS7H6003-SP (5962R2220101VXC)

117.1 Fall Time HO VIN_14V		
Test Site	DAL-FL	DAL-FL
Tester	ETS364	ETS364
Test Number	EB672302	EB672302
Unit	nsec	
Max Limit	5.5	5.5
Min Limit	1	1

krad(Si)	Serial #	pre_short (rtp)	(2)'ST_Combo (rpt)	Delta
0	Ctrl	3.755	3.755	0.000
3	58	3.841	3.743	-0.098
3	59	3.843	3.754	-0.089
3	60	3.851	3.755	-0.096
3	61	3.850	3.748	-0.102
3	62	3.849	3.776	-0.073
3	134	3.872	3.757	-0.115
3	137	3.845	3.757	-0.089
3	138	3.861	3.759	-0.102
3	139	3.851	3.750	-0.101
3	236	3.855	3.729	-0.126
10	63	3.864	3.774	-0.090
10	64	3.846	3.749	-0.097
10	65	3.833	3.755	-0.078
10	66	3.848	3.744	-0.104
10	150	3.854	3.768	-0.086
10	237	3.862	3.726	-0.136
10	241	3.855	3.747	-0.108
10	242	3.847	3.741	-0.106
10	243	3.843	3.753	-0.090
10	244	3.849	3.743	-0.106
30	141	3.848	3.756	-0.092
30	144	3.866	3.782	-0.084
30	145	3.853	3.744	-0.109
30	146	3.858	3.787	-0.071
30	147	3.844	3.757	-0.087
30	132	3.856	3.753	-0.103
30	133	3.859	3.747	-0.112
30	135	3.848	3.743	-0.105
30	245	3.851	3.742	-0.108
30	246	3.852	3.774	-0.077
50	67	3.842	3.747	-0.095
50	68	3.855	3.741	-0.115
50	69	3.854	3.757	-0.096
50	71	3.853	3.753	-0.100
50	72	3.840	3.771	-0.070
50	172	3.855	3.764	-0.090
50	173	3.857	3.760	-0.098
50	174	3.852	3.767	-0.085
50	183	3.861	3.756	-0.106
50	186	3.867	3.765	-0.102
100	95	3.862	3.760	-0.102
100	102	3.854	3.786	-0.068
100	104	3.845	3.749	-0.096
100	105	3.844	3.733	-0.111
100	106	3.846	3.799	-0.048
100	178	3.864	3.739	-0.125
100	179	3.842	3.752	-0.090
100	180	3.855	3.782	-0.073
100	181	3.844	3.753	-0.091
100	182	3.848	3.737	-0.111
Max		3.872	3.799	0.000
Average		3.850	3.756	-0.094
Min		3.755	3.726	-0.136
Std Dev		0.016	0.015	0.021

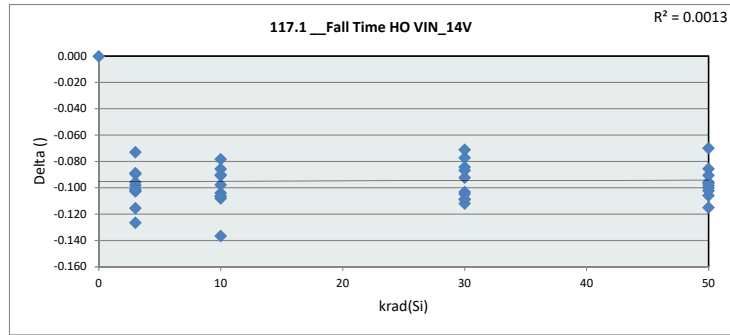

117.1 Fall Time H	
Test Site	DAL-FL
Tester	ETS364
Test Number	EB672302
Max Limit	5.5
Min Limit	1

krad(Si)	0	3	10	30	50	100
LL	1.000	1.000	1.000	1.000	1.000	1.000
Min	3.755	3.729	3.726	3.742	3.741	3.733
Average	3.755	3.753	3.750	3.759	3.758	3.759
Max	3.755	3.776	3.774	3.788	3.771	3.799
UL	5.500	5.500	5.500	5.500	5.500	5.500

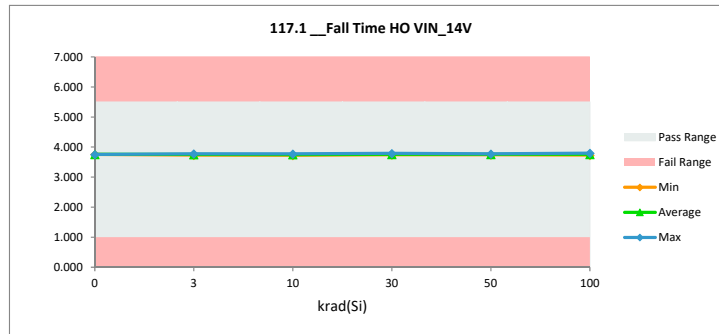

TID HDR Report
TPS7H6003-SP (5962R2220101VXC)

117.2 Rise Time LO VIN_14V		
Test Site	DAL-FL	DAL-FL
Tester	ETS364	ETS364
Test Number	EB672302	EB672302
Unit	nsec	
Max Limit	7.5	7.5
Min Limit	1	1

krad(Si)	Serial #	pre_short (rtp)	(2)ST_Combo (rpt)	Delta
0	Ctrl	3.009	3.009	0.000
3	58	2.956	3.006	0.050
3	59	2.966	3.019	0.053
3	60	2.950	3.005	0.054
3	61	2.959	3.019	0.060
3	62	2.949	3.009	0.060
3	134	2.981	3.019	0.038
3	137	2.964	3.021	0.057
3	138	2.961	3.029	0.067
3	139	2.969	3.012	0.043
3	236	2.961	3.005	0.044
10	63	2.957	3.016	0.059
10	64	2.950	3.012	0.062
10	65	2.940	3.001	0.061
10	66	2.944	2.999	0.055
10	150	2.971	3.026	0.056
10	237	2.956	2.998	0.042
10	241	2.971	3.024	0.053
10	242	2.984	3.028	0.044
10	243	2.958	3.013	0.055
10	244	2.952	3.003	0.050
30	141	2.967	3.002	0.035
30	144	2.963	2.996	0.033
30	145	2.963	3.000	0.037
30	146	2.955	3.002	0.047
30	147	2.944	2.994	0.051
30	132	2.961	3.016	0.055
30	133	2.975	3.012	0.037
30	135	2.954	3.010	0.056
30	245	2.948	3.010	0.062
30	246	2.949	2.991	0.042
50	67	2.955	3.002	0.047
50	68	2.964	2.999	0.035
50	69	2.964	3.000	0.036
50	71	2.959	3.017	0.058
50	72	2.941	2.995	0.053
50	172	2.970	2.974	0.004
50	173	2.971	3.023	0.052
50	174	2.959	3.004	0.046
50	183	2.970	3.010	0.040
50	186	2.958	3.009	0.051
100	95	2.955	3.013	0.057
100	102	2.953	3.008	0.054
100	104	2.951	3.008	0.056
100	105	2.961	2.977	0.016
100	106	2.942	3.032	0.090
100	178	2.957	3.012	0.055
100	179	2.946	3.012	0.066
100	180	2.954	3.014	0.060
100	181	2.972	3.009	0.037
100	182	2.961	2.990	0.029
	Max	3.009	3.032	0.090
	Average	2.960	3.008	0.048
	Min	2.940	2.974	0.000
	Std Dev	0.012	0.012	0.015

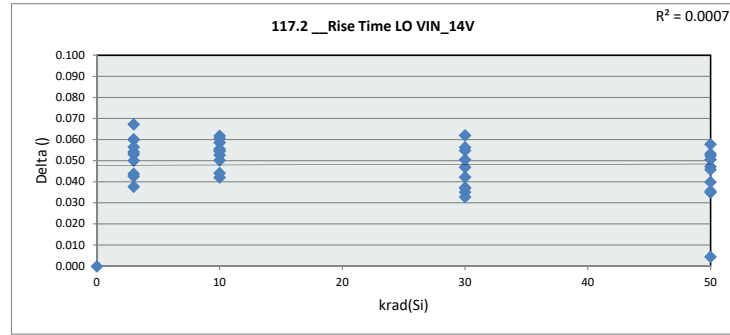

117.2 Rise Time L	
Test Site	DAL-FL
Tester	ETS364
Test Number	EB672302
Max Limit	7.5
Min Limit	1

krad(Si)	0	3	10	30	50	100
LL	1.000	1.000	1.000	1.000	1.000	1.000
Min	3.009	3.005	2.998	2.992	2.975	2.978
Average	3.009	3.014	3.012	3.003	3.003	3.007
Max	3.009	3.029	3.028	3.016	3.023	3.032
UL	7.500	7.500	7.500	7.500	7.500	7.500

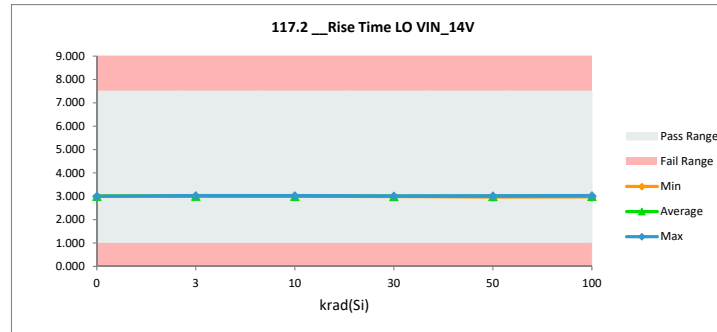

TID HDR Report
TPS7H6003-SP (5962R2220101VXC)

117.3 Fall Time LO VIN_14V		
Test Site	DAL-FL	DAL-FL
Tester	ETS364	ETS364
Test Number	EB672302	EB672302
Unit	nsec	
Max Limit	5.5	5.5
Min Limit	1	1

krad(Si)	Serial #	pre_short (rtp)	(2)ST_Combo (rpt)	Delta
0	Ctrl	3.193	3.193	0.000
3	58	3.289	3.198	-0.090
3	59	3.303	3.193	-0.109
3	60	3.295	3.197	-0.098
3	61	3.317	3.198	-0.118
3	62	3.307	3.190	-0.118
3	134	3.336	3.208	-0.128
3	137	3.317	3.211	-0.106
3	138	3.306	3.212	-0.094
3	139	3.299	3.235	-0.064
3	236	3.316	3.175	-0.141
10	63	3.307	3.183	-0.123
10	64	3.297	3.192	-0.105
10	65	3.266	3.166	-0.100
10	66	3.291	3.176	-0.115
10	150	3.313	3.207	-0.106
10	237	3.312	3.173	-0.139
10	241	3.312	3.209	-0.103
10	242	3.332	3.201	-0.131
10	243	3.306	3.191	-0.115
10	244	3.294	3.185	-0.109
30	141	3.311	3.186	-0.124
30	144	3.306	3.175	-0.131
30	145	3.311	3.182	-0.128
30	146	3.291	3.188	-0.104
30	147	3.283	3.174	-0.109
30	132	3.311	3.203	-0.108
30	133	3.330	3.196	-0.134
30	135	3.313	3.186	-0.127
30	245	3.293	3.174	-0.119
30	246	3.293	3.172	-0.122
50	67	3.303	3.194	-0.109
50	68	3.329	3.172	-0.157
50	69	3.312	3.168	-0.144
50	71	3.303	3.201	-0.102
50	72	3.288	3.176	-0.112
50	172	3.311	3.182	-0.129
50	173	3.306	3.193	-0.113
50	174	3.306	3.179	-0.126
50	183	3.312	3.191	-0.121
50	186	3.308	3.192	-0.116
100	95	3.289	3.204	-0.086
100	102	3.302	3.202	-0.100
100	104	3.309	3.203	-0.106
100	105	3.309	3.180	-0.129
100	106	3.300	3.222	-0.078
100	178	3.321	3.182	-0.139
100	179	3.291	3.194	-0.097
100	180	3.306	3.216	-0.091
100	181	3.321	3.194	-0.127
100	182	3.311	3.190	-0.122
Max		3.336	3.235	0.000
Average		3.304	3.192	-0.112
Min		3.193	3.166	-0.157
Std Dev		0.020	0.015	0.024

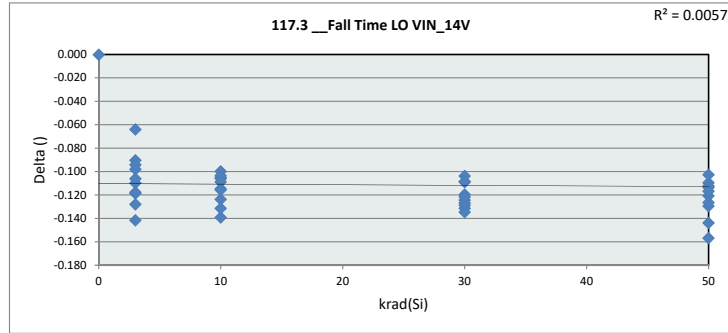

117.3 Fall Time LO						
Test Site	DAL-FL					
Tester	ETS364					
Test Number	EB672302					
Max Limit	5.5					
Min Limit	1					
krad(Si)	0	3	10	30	50	100
LL	1.000	1.000	1.000	1.000	1.000	1.000
Min	3.193	3.175	3.166	3.172	3.168	3.180
Average	3.193	3.202	3.188	3.184	3.185	3.199
Max	3.193	3.235	3.209	3.203	3.201	3.222
UL	5.500	5.500	5.500	5.500	5.500	5.500

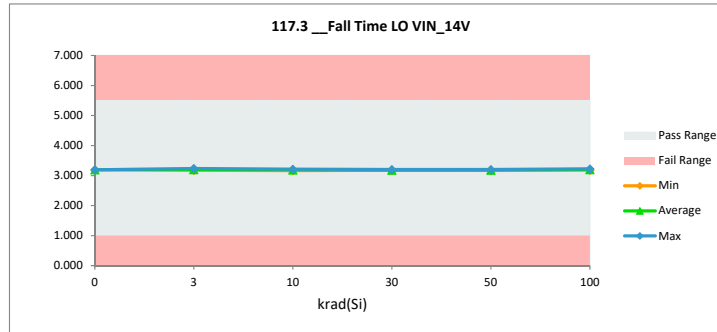

TID HDR Report
TPS7H6003-SP (5962R2220101VXC)

120.0 Min Input PW Static HS		
Test Site	DAL-FL	DAL-FL
Tester	ETS364	ETS364
Test Number	EB672302	EB672302
Unit	nsec	
Max Limit	8	8
Min Limit	0	0

krad(Si)	Serial #	pre_short (rtp) (2)	ST_Combo (rpt) (Delta
0	Ctrl	5.000	5.000	0.000
3	58	4.000	4.000	0.000
3	59	4.000	4.000	0.000
3	60	4.000	4.000	0.000
3	61	4.000	4.000	0.000
3	62	4.000	5.000	1.000
3	134	4.000	4.000	0.000
3	137	4.000	4.000	0.000
3	138	4.000	5.000	1.000
3	139	4.000	4.000	0.000
3	236	4.000	4.000	0.000
10	63	4.000	4.000	0.000
10	64	4.000	4.000	0.000
10	65	4.000	4.000	0.000
10	66	4.000	4.000	0.000
10	150	4.000	4.000	0.000
10	237	4.000	4.000	0.000
10	241	4.000	4.000	0.000
10	242	4.000	4.000	0.000
10	243	4.000	5.000	1.000
10	244	4.000	4.000	0.000
30	141	4.000	4.000	0.000
30	144	5.000	4.000	-1.000
30	145	4.000	4.000	0.000
30	146	4.000	4.000	0.000
30	147	4.000	4.000	0.000
30	132	5.000	5.000	0.000
30	133	4.000	4.000	0.000
30	135	4.000	5.000	1.000
30	245	4.000	4.000	0.000
30	246	4.000	4.000	0.000
50	67	4.000	4.000	0.000
50	68	4.000	4.000	0.000
50	69	5.000	4.000	-1.000
50	71	5.000	5.000	0.000
50	72	4.000	4.000	0.000
50	172	4.000	4.000	0.000
50	173	4.000	4.000	0.000
50	174	4.000	4.000	0.000
50	183	4.000	4.000	0.000
50	186	5.000	4.000	-1.000
100	95	4.000	4.000	0.000
100	102	4.000	4.000	0.000
100	104	4.000	4.000	0.000
100	105	4.000	4.000	0.000
100	106	4.000	4.000	0.000
100	178	4.000	4.000	0.000
100	179	4.000	4.000	0.000
100	180	5.000	4.000	-1.000
100	181	4.000	4.000	0.000
100	182	4.000	4.000	0.000
Max		5.000	5.000	1.000
Average		4.137	4.137	0.000
Min		4.000	4.000	-1.000
Std Dev		0.348	0.348	0.400

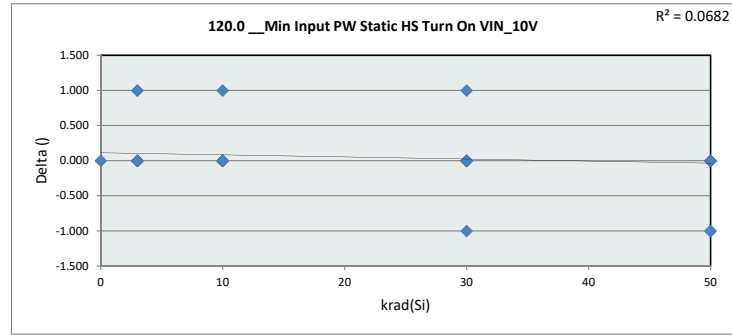

120.0 Min Input P	
Test Site	DAL-FL
Tester	ETS364
Test Number	EB672302
Max Limit	8
Min Limit	0

krad(Si)	0	3	10	30	50	100
LL	0.000	0.000	0.000	0.000	0.000	0.000
Min	5.000	4.000	4.000	4.000	4.000	4.000
Average	5.000	4.200	4.100	4.200	4.100	4.000
Max	5.000	5.000	5.000	5.000	5.000	4.000
UL	8.000	8.000	8.000	8.000	8.000	8.000

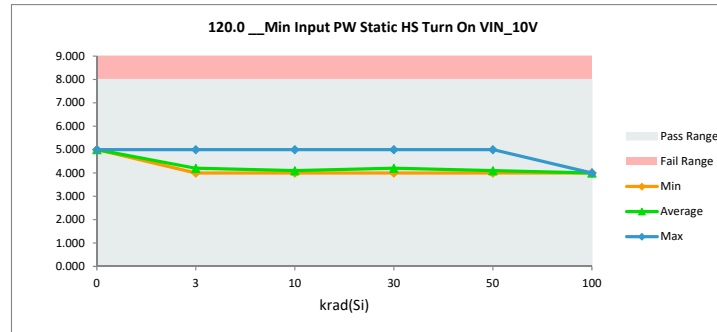

TID HDR Report
TPS7H6003-SP (5962R2220101VXC)

120.1 Min Input PW Static HS		
Test Site	DAL-FL	DAL-FL
Tester	ETS364	ETS364
Test Number	EB672302	EB672302
Unit	nsec	
Max Limit	12	12
Min Limit	0	0

krad(Si)	Serial #	pre_short (rtp) (2)	ST_Combo (rpt) (Delta
0	Ctrl	7.000	7.000	0.000
3	58	7.000	7.000	0.000
3	59	7.000	7.000	0.000
3	60	6.000	7.000	1.000
3	61	7.000	7.000	0.000
3	62	7.000	7.000	0.000
3	134	7.000	7.000	0.000
3	137	7.000	7.000	0.000
3	138	7.000	7.000	0.000
3	139	6.000	6.000	0.000
3	236	7.000	6.000	-1.000
10	63	7.000	7.000	0.000
10	64	7.000	7.000	0.000
10	65	6.000	6.000	0.000
10	66	7.000	7.000	0.000
10	150	7.000	7.000	0.000
10	237	7.000	6.000	-1.000
10	241	6.000	7.000	1.000
10	242	7.000	7.000	0.000
10	243	7.000	7.000	0.000
10	244	7.000	7.000	0.000
30	141	7.000	7.000	0.000
30	144	7.000	7.000	0.000
30	145	7.000	7.000	0.000
30	146	7.000	7.000	0.000
30	147	6.000	6.000	0.000
30	132	7.000	7.000	0.000
30	133	6.000	6.000	0.000
30	135	6.000	8.000	2.000
30	245	7.000	7.000	0.000
30	246	6.000	6.000	0.000
50	67	7.000	7.000	0.000
50	68	7.000	7.000	0.000
50	69	7.000	7.000	0.000
50	71	7.000	8.000	1.000
50	72	6.000	7.000	1.000
50	172	7.000	7.000	0.000
50	173	6.000	7.000	1.000
50	174	7.000	7.000	0.000
50	183	6.000	7.000	1.000
50	186	8.000	8.000	0.000
100	95	7.000	7.000	0.000
100	102	7.000	7.000	0.000
100	104	6.000	6.000	0.000
100	105	7.000	7.000	0.000
100	106	7.000	7.000	0.000
100	178	7.000	7.000	0.000
100	179	7.000	7.000	0.000
100	180	7.000	7.000	0.000
100	181	7.000	7.000	0.000
100	182	7.000	7.000	0.000
Max		8.000	8.000	2.000
Average		6.784	6.902	0.118
Min		6.000	6.000	-1.000
Std Dev		0.461	0.458	0.475

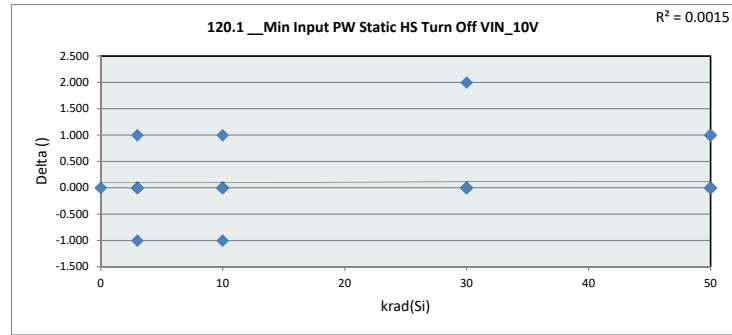

120.1 Min Input P						
Test Site	DAL-FL					
Tester	ETS364					
Test Number	EB672302					
Max Limit	12					
Min Limit	0					
krad(Si)	0	3	10	30	50	100
LL	0.000	0.000	0.000	0.000	0.000	0.000
Min	7.000	6.000	6.000	6.000	7.000	6.000
Average	7.000	6.800	6.800	6.800	7.200	6.900
Max	7.000	7.000	7.000	8.000	8.000	7.000
UL	12.000	12.000	12.000	12.000	12.000	12.000

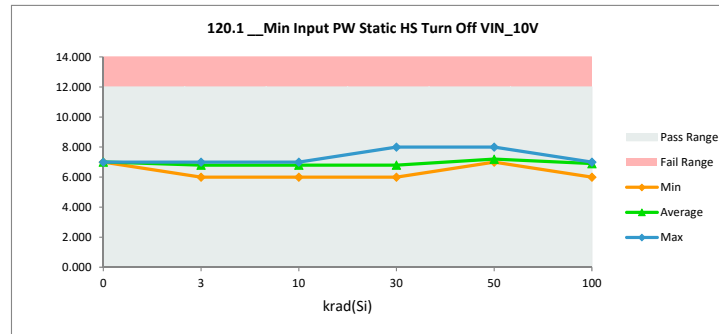

TID HDR Report
TPS7H6003-SP (5962R2220101VXC)

120.2 Min Input PW Static LS		
Test Site	DAL-FL	DAL-FL
Tester	ETS364	ETS364
Test Number	EB672302	EB672302
Unit	nsec	
Max Limit	8	8
Min Limit	0	0

krad(Si)	Serial #	pre_short (rtp) (2)	ST_Combo (rpt) (Delta
0	Ctrl	4.000	4.000	0.000
3	58	4.000	4.000	0.000
3	59	4.000	4.000	0.000
3	60	4.000	4.000	0.000
3	61	4.000	4.000	0.000
3	62	4.000	4.000	0.000
3	134	4.000	4.000	0.000
3	137	4.000	4.000	0.000
3	138	4.000	4.000	0.000
3	139	4.000	4.000	0.000
3	236	4.000	4.000	0.000
10	63	4.000	4.000	0.000
10	64	4.000	4.000	0.000
10	65	4.000	4.000	0.000
10	66	4.000	4.000	0.000
10	150	4.000	4.000	0.000
10	237	4.000	4.000	0.000
10	241	4.000	4.000	0.000
10	242	4.000	4.000	0.000
10	243	4.000	4.000	0.000
10	244	4.000	4.000	0.000
30	141	4.000	4.000	0.000
30	144	4.000	4.000	0.000
30	145	4.000	4.000	0.000
30	146	4.000	4.000	0.000
30	147	4.000	4.000	0.000
30	132	4.000	4.000	0.000
30	133	4.000	4.000	0.000
30	135	4.000	4.000	0.000
30	245	4.000	4.000	0.000
30	246	4.000	4.000	0.000
50	67	4.000	4.000	0.000
50	68	4.000	4.000	0.000
50	69	4.000	4.000	0.000
50	71	4.000	4.000	0.000
50	72	4.000	4.000	0.000
50	172	4.000	4.000	0.000
50	173	4.000	4.000	0.000
50	174	4.000	4.000	0.000
50	183	4.000	4.000	0.000
50	186	4.000	4.000	0.000
100	95	4.000	4.000	0.000
100	102	4.000	4.000	0.000
100	104	4.000	4.000	0.000
100	105	4.000	4.000	0.000
100	106	4.000	4.000	0.000
100	178	4.000	4.000	0.000
100	179	4.000	4.000	0.000
100	180	4.000	4.000	0.000
100	181	4.000	4.000	0.000
100	182	4.000	4.000	0.000
Max		4.000	4.000	0.000
Average		4.000	4.000	0.000
Min		4.000	4.000	0.000
Std Dev		0.000	0.000	0.000

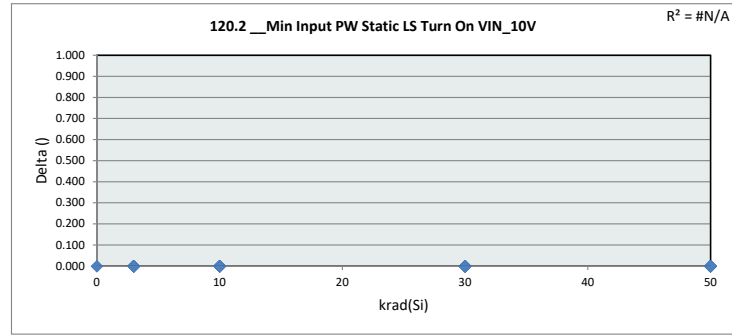

120.2 Min Input P						
Test Site	DAL-FL					
Tester	ETS364					
Test Number	EB672302					
Max Limit	8					
Min Limit	0					
krad(Si)	0	3	10	30	50	100
LL	0.000	0.000	0.000	0.000	0.000	0.000
Min	4.000	4.000	4.000	4.000	4.000	4.000
Average	4.000	4.000	4.000	4.000	4.000	4.000
Max	4.000	4.000	4.000	4.000	4.000	4.000
UL	8.000	8.000	8.000	8.000	8.000	8.000

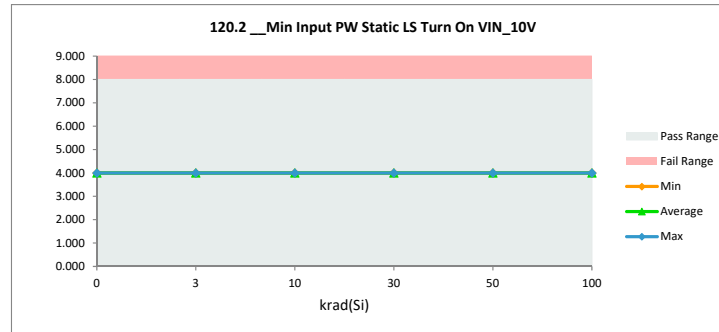

TID HDR Report
TPS7H6003-SP (5962R2220101VXC)

120.3 Min Input PW Static LS		
Test Site	DAL-FL	DAL-FL
Tester	ETS364	ETS364
Test Number	EB672302	EB672302
Unit	nsec	
Max Limit	12	12
Min Limit	0	0

krad(Si)	Serial #	pre_short (rtp) (2)	ST_Combo (rpt) (Delta
0	Ctrl	6.000	6.000	0.000
3	58	5.000	6.000	1.000
3	59	6.000	6.000	0.000
3	60	6.000	6.000	0.000
3	61	6.000	6.000	0.000
3	62	5.000	6.000	1.000
3	134	5.000	6.000	1.000
3	137	6.000	6.000	0.000
3	138	6.000	6.000	0.000
3	139	5.000	5.000	0.000
3	236	5.000	5.000	0.000
10	63	5.000	6.000	1.000
10	64	6.000	6.000	0.000
10	65	5.000	6.000	1.000
10	66	5.000	6.000	1.000
10	150	5.000	6.000	1.000
10	237	5.000	5.000	0.000
10	241	5.000	6.000	1.000
10	242	5.000	6.000	1.000
10	243	5.000	6.000	1.000
10	244	5.000	6.000	1.000
30	141	5.000	5.000	0.000
30	144	6.000	6.000	0.000
30	145	5.000	5.000	0.000
30	146	5.000	6.000	1.000
30	147	5.000	5.000	0.000
30	132	6.000	6.000	0.000
30	133	5.000	5.000	0.000
30	135	5.000	6.000	1.000
30	245	6.000	6.000	0.000
30	246	5.000	6.000	1.000
50	67	5.000	6.000	1.000
50	68	5.000	6.000	1.000
50	69	6.000	6.000	0.000
50	71	5.000	5.000	0.000
50	72	5.000	6.000	1.000
50	172	5.000	5.000	0.000
50	173	6.000	6.000	0.000
50	174	6.000	6.000	0.000
50	183	5.000	6.000	1.000
50	186	6.000	6.000	0.000
100	95	5.000	6.000	1.000
100	102	5.000	5.000	0.000
100	104	6.000	6.000	0.000
100	105	5.000	6.000	1.000
100	106	6.000	6.000	0.000
100	178	6.000	5.000	-1.000
100	179	6.000	6.000	0.000
100	180	6.000	6.000	0.000
100	181	6.000	6.000	0.000
100	182	5.000	6.000	1.000
Max		6.000	6.000	1.000
Average		5.392	5.784	0.392
Min		5.000	5.000	-1.000
Std Dev		0.493	0.415	0.532

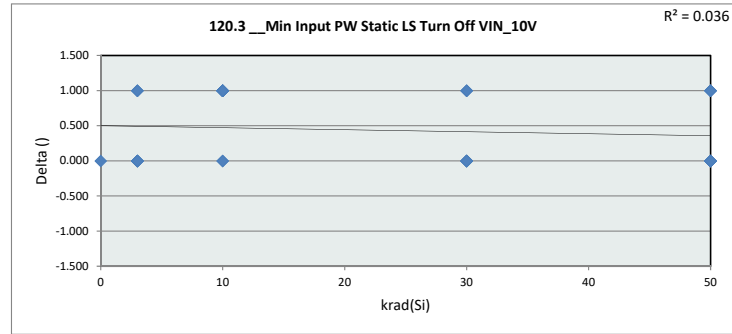

120.3 Min Input P	
Test Site	DAL-FL
Tester	ETS364
Test Number	EB672302
Max Limit	12
Min Limit	0

krad(Si)	0	3	10	30	50	100
LL	0.000	0.000	0.000	0.000	0.000	0.000
Min	6.000	5.000	5.000	5.000	5.000	5.000
Average	6.000	5.800	5.900	5.600	5.800	5.800
Max	6.000	6.000	6.000	6.000	6.000	6.000
UL	12.000	12.000	12.000	12.000	12.000	12.000

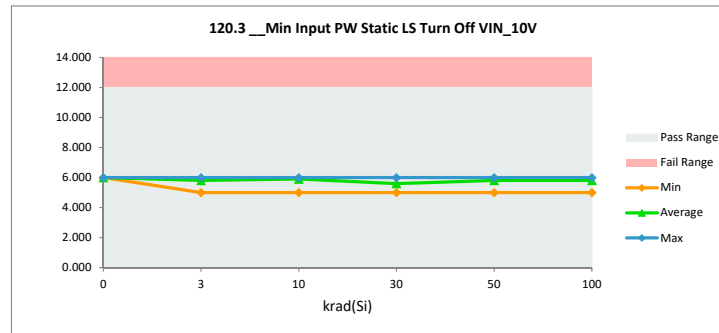

TID HDR Report
TPS7H6003-SP (5962R2220101VXC)

120.4 Min Input PW Static HS		
Test Site	DAL-FL	DAL-FL
Tester	ETS364	ETS364
Test Number	EB672302	EB672302
Unit	nsec	
Max Limit	8	8
Min Limit	0	0

krad(Si)	Serial #	pre_short (rtp) (2)	ST_Combo (rpt) (Delta
0	Ctrl	5.000	5.000	0.000
3	58	4.000	4.000	0.000
3	59	4.000	4.000	0.000
3	60	4.000	4.000	0.000
3	61	4.000	4.000	0.000
3	62	4.000	5.000	1.000
3	134	4.000	4.000	0.000
3	137	4.000	4.000	0.000
3	138	4.000	4.000	0.000
3	139	4.000	4.000	0.000
3	236	4.000	4.000	0.000
10	63	4.000	4.000	0.000
10	64	4.000	4.000	0.000
10	65	4.000	4.000	0.000
10	66	4.000	4.000	0.000
10	150	4.000	4.000	0.000
10	237	4.000	4.000	0.000
10	241	4.000	5.000	1.000
10	242	4.000	4.000	0.000
10	243	5.000	5.000	0.000
10	244	4.000	4.000	0.000
30	141	4.000	4.000	0.000
30	144	5.000	4.000	-1.000
30	145	4.000	4.000	0.000
30	146	4.000	4.000	0.000
30	147	4.000	4.000	0.000
30	132	5.000	5.000	0.000
30	133	4.000	4.000	0.000
30	135	4.000	5.000	1.000
30	245	4.000	4.000	0.000
30	246	4.000	4.000	0.000
50	67	5.000	4.000	-1.000
50	68	4.000	4.000	0.000
50	69	4.000	4.000	0.000
50	71	5.000	4.000	-1.000
50	72	4.000	4.000	0.000
50	172	4.000	4.000	0.000
50	173	4.000	4.000	0.000
50	174	4.000	4.000	0.000
50	183	4.000	4.000	0.000
50	186	5.000	4.000	-1.000
100	95	4.000	4.000	0.000
100	102	4.000	4.000	0.000
100	104	4.000	4.000	0.000
100	105	4.000	4.000	0.000
100	106	4.000	4.000	0.000
100	178	4.000	4.000	0.000
100	179	4.000	4.000	0.000
100	180	5.000	4.000	-1.000
100	181	4.000	4.000	0.000
100	182	4.000	4.000	0.000
Max		5.000	5.000	1.000
Average		4.157	4.118	-0.039
Min		4.000	4.000	-1.000
Std Dev		0.367	0.325	0.398

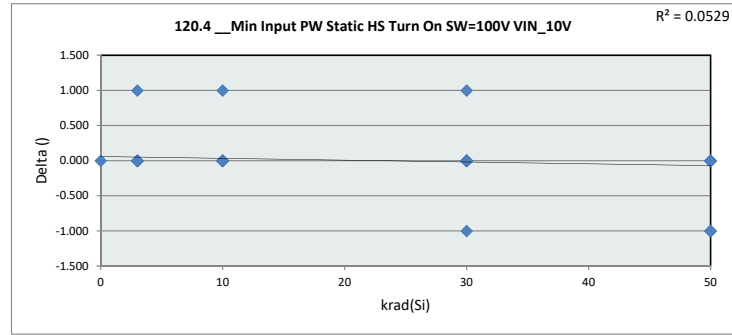

120.4 Min Input P						
Test Site	DAL-FL					
Tester	ETS364					
Test Number	EB672302					
Max Limit	8					
Min Limit	0					
krad(Si)	0	3	10	30	50	100
LL	0.000	0.000	0.000	0.000	0.000	0.000
Min	5.000	4.000	4.000	4.000	4.000	4.000
Average	5.000	4.100	4.200	4.200	4.000	4.000
Max	5.000	5.000	5.000	5.000	4.000	4.000
UL	8.000	8.000	8.000	8.000	8.000	8.000

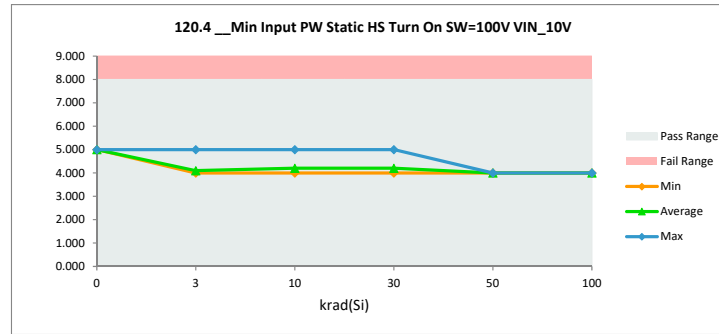

TID HDR Report
TPS7H6003-SP (5962R2220101VXC)

120.5 Min Input PW Static HS		
Test Site	DAL-FL	DAL-FL
Tester	ETS364	ETS364
Test Number	EB672302	EB672302
Unit	nsec	
Max Limit	12	12
Min Limit	0	0

krad(Si)	Serial #	pre_short (rtp) (2)	ST_Combo (rpt) (Delta
0	Ctrl	7.000	7.000	0.000
3	58	7.000	7.000	0.000
3	59	7.000	7.000	0.000
3	60	6.000	7.000	1.000
3	61	7.000	7.000	0.000
3	62	7.000	7.000	0.000
3	134	7.000	7.000	0.000
3	137	7.000	7.000	0.000
3	138	7.000	7.000	0.000
3	139	6.000	6.000	0.000
3	236	7.000	6.000	-1.000
10	63	7.000	7.000	0.000
10	64	7.000	7.000	0.000
10	65	6.000	6.000	0.000
10	66	7.000	7.000	0.000
10	150	7.000	7.000	0.000
10	237	7.000	6.000	-1.000
10	241	6.000	7.000	1.000
10	242	7.000	7.000	0.000
10	243	7.000	7.000	0.000
10	244	7.000	7.000	0.000
30	141	7.000	7.000	0.000
30	144	7.000	7.000	0.000
30	145	7.000	7.000	0.000
30	146	6.000	7.000	1.000
30	147	6.000	6.000	0.000
30	132	7.000	7.000	0.000
30	133	6.000	6.000	0.000
30	135	6.000	8.000	2.000
30	245	7.000	7.000	0.000
30	246	6.000	6.000	0.000
50	67	7.000	7.000	0.000
50	68	7.000	7.000	0.000
50	69	7.000	7.000	0.000
50	71	7.000	8.000	1.000
50	72	6.000	7.000	1.000
50	172	7.000	7.000	0.000
50	173	6.000	7.000	1.000
50	174	7.000	7.000	0.000
50	183	7.000	6.000	-1.000
50	186	8.000	8.000	0.000
100	95	7.000	7.000	0.000
100	102	7.000	7.000	0.000
100	104	6.000	6.000	0.000
100	105	7.000	7.000	0.000
100	106	7.000	7.000	0.000
100	178	7.000	7.000	0.000
100	179	7.000	7.000	0.000
100	180	7.000	7.000	0.000
100	181	7.000	7.000	0.000
100	182	7.000	7.000	0.000
Max		8.000	8.000	2.000
Average		6.784	6.882	0.098
Min		6.000	6.000	-1.000
Std Dev		0.461	0.475	0.500

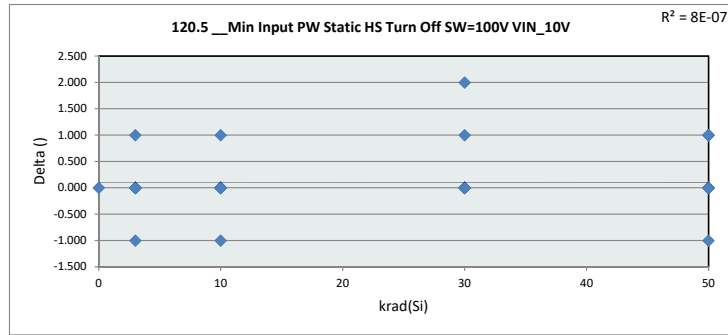

120.5 Min Input P						
Test Site	DAL-FL					
Tester	ETS364					
Test Number	EB672302					
Max Limit	12					
Min Limit	0					
krad(Si)	0	3	10	30	50	100
LL	0.000	0.000	0.000	0.000	0.000	0.000
Min	7.000	6.000	6.000	6.000	6.000	6.000
Average	7.000	6.800	6.800	6.800	7.100	6.900
Max	7.000	7.000	7.000	8.000	8.000	7.000
UL	12.000	12.000	12.000	12.000	12.000	12.000

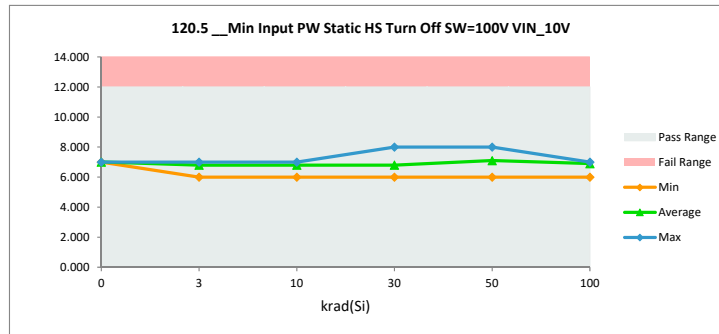

TID HDR Report
TPS7H6003-SP (5962R2220101VXC)

121.0 Min Input PW Static HS		
Test Site	DAL-FL	DAL-FL
Tester	ETS364	ETS364
Test Number	EB672302	EB672302
Unit	nsec	
Max Limit	8	8
Min Limit	0	0

krad(Si)	Serial #	pre_short (rtp) (2)	ST_Combo (rpt) (Delta
0	Ctrl	5.000	5.000	0.000
3	58	4.000	4.000	0.000
3	59	4.000	4.000	0.000
3	60	4.000	4.000	0.000
3	61	4.000	4.000	0.000
3	62	4.000	5.000	1.000
3	134	4.000	4.000	0.000
3	137	4.000	4.000	0.000
3	138	4.000	5.000	1.000
3	139	4.000	4.000	0.000
3	236	4.000	4.000	0.000
10	63	4.000	4.000	0.000
10	64	4.000	4.000	0.000
10	65	4.000	4.000	0.000
10	66	4.000	4.000	0.000
10	150	4.000	4.000	0.000
10	237	4.000	4.000	0.000
10	241	4.000	4.000	0.000
10	242	4.000	4.000	0.000
10	243	5.000	5.000	0.000
10	244	4.000	4.000	0.000
30	141	4.000	4.000	0.000
30	144	5.000	4.000	-1.000
30	145	4.000	4.000	0.000
30	146	4.000	4.000	0.000
30	147	4.000	4.000	0.000
30	132	5.000	5.000	0.000
30	133	4.000	4.000	0.000
30	135	4.000	5.000	1.000
30	245	4.000	4.000	0.000
30	246	4.000	4.000	0.000
50	67	5.000	4.000	-1.000
50	68	4.000	4.000	0.000
50	69	4.000	4.000	0.000
50	71	5.000	4.000	-1.000
50	72	4.000	4.000	0.000
50	172	4.000	4.000	0.000
50	173	4.000	4.000	0.000
50	174	4.000	4.000	0.000
50	183	4.000	4.000	0.000
50	186	5.000	4.000	-1.000
100	95	4.000	4.000	0.000
100	102	4.000	4.000	0.000
100	104	4.000	4.000	0.000
100	105	4.000	4.000	0.000
100	106	4.000	4.000	0.000
100	178	4.000	4.000	0.000
100	179	4.000	4.000	0.000
100	180	5.000	4.000	-1.000
100	181	4.000	4.000	0.000
100	182	4.000	4.000	0.000
Max		5.000	5.000	1.000
Average		4.157	4.118	-0.039
Min		4.000	4.000	-1.000
Std Dev		0.367	0.325	0.398

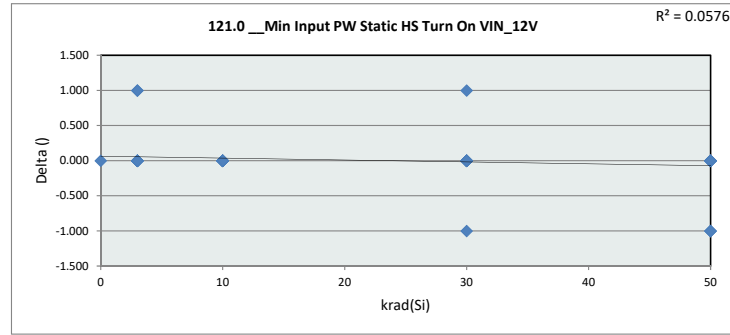

121.0 Min Input P						
Test Site	DAL-FL					
Tester	ETS364					
Test Number	EB672302					
Max Limit	8					
Min Limit	0					
krad(Si)	0	3	10	30	50	100
LL	0.000	0.000	0.000	0.000	0.000	0.000
Min	5.000	4.000	4.000	4.000	4.000	4.000
Average	5.000	4.200	4.100	4.200	4.000	4.000
Max	5.000	5.000	5.000	5.000	4.000	4.000
UL	8.000	8.000	8.000	8.000	8.000	8.000

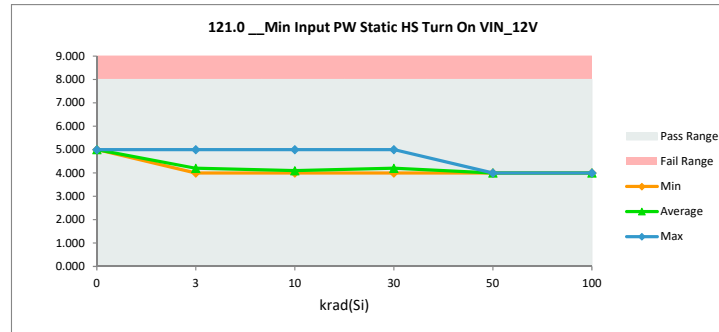

TID HDR Report
TPS7H6003-SP (5962R2220101VXC)

121.1 Min Input PW Static HS		
Test Site	DAL-FL	DAL-FL
Tester	ETS364	ETS364
Test Number	EB672302	EB672302
Unit	nsec	
Max Limit	12	12
Min Limit	0	0

krad(Si)	Serial #	pre_short (rtp) (2)	ST_Combo (rpt) (Delta
0	Ctrl	7.000	7.000	0.000
3	58	7.000	7.000	0.000
3	59	7.000	7.000	0.000
3	60	6.000	7.000	1.000
3	61	7.000	7.000	0.000
3	62	7.000	7.000	0.000
3	134	7.000	7.000	0.000
3	137	7.000	7.000	0.000
3	138	7.000	7.000	0.000
3	139	6.000	6.000	0.000
3	236	7.000	6.000	-1.000
10	63	7.000	7.000	0.000
10	64	7.000	7.000	0.000
10	65	6.000	6.000	0.000
10	66	7.000	7.000	0.000
10	150	7.000	7.000	0.000
10	237	7.000	6.000	-1.000
10	241	6.000	7.000	1.000
10	242	7.000	7.000	0.000
10	243	7.000	7.000	0.000
10	244	7.000	7.000	0.000
30	141	7.000	7.000	0.000
30	144	7.000	7.000	0.000
30	145	7.000	7.000	0.000
30	146	6.000	7.000	1.000
30	147	6.000	6.000	0.000
30	132	7.000	7.000	0.000
30	133	6.000	6.000	0.000
30	135	6.000	8.000	2.000
30	245	7.000	7.000	0.000
30	246	6.000	6.000	0.000
50	67	7.000	7.000	0.000
50	68	7.000	7.000	0.000
50	69	7.000	7.000	0.000
50	71	8.000	8.000	0.000
50	72	6.000	7.000	1.000
50	172	7.000	7.000	0.000
50	173	6.000	7.000	1.000
50	174	7.000	7.000	0.000
50	183	6.000	7.000	1.000
50	186	8.000	8.000	0.000
100	95	7.000	7.000	0.000
100	102	7.000	7.000	0.000
100	104	6.000	6.000	0.000
100	105	7.000	7.000	0.000
100	106	7.000	7.000	0.000
100	178	7.000	7.000	0.000
100	179	7.000	7.000	0.000
100	180	7.000	7.000	0.000
100	181	7.000	7.000	0.000
100	182	7.000	7.000	0.000
Max		8.000	8.000	2.000
Average		6.784	6.902	0.118
Min		6.000	6.000	-1.000
Std Dev		0.503	0.458	0.475

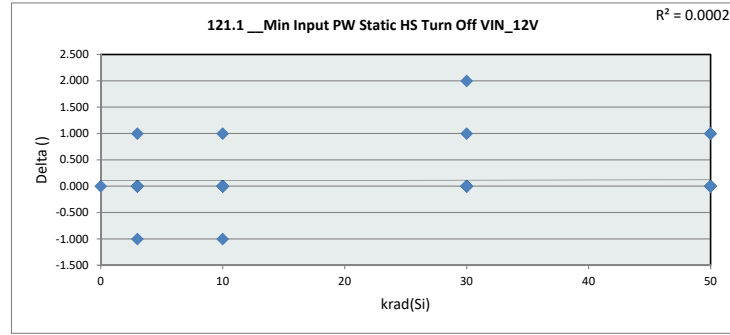

121.1 Min Input P						
Test Site	DAL-FL					
Tester	ETS364					
Test Number	EB672302					
Max Limit	12					
Min Limit	0					
krad(Si)	0	3	10	30	50	100
LL	0.000	0.000	0.000	0.000	0.000	0.000
Min	7.000	6.000	6.000	6.000	7.000	6.000
Average	7.000	6.800	6.800	6.800	7.200	6.900
Max	7.000	7.000	7.000	8.000	8.000	7.000
UL	12.000	12.000	12.000	12.000	12.000	12.000

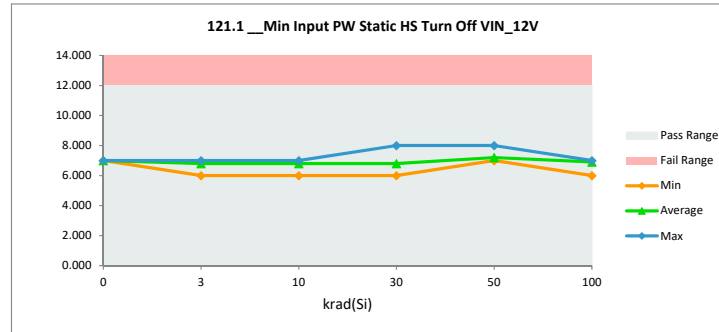

TID HDR Report
TPS7H6003-SP (5962R2220101VXC)

121.2 Min Input PW Static LS		
Test Site	DAL-FL	DAL-FL
Tester	ETS364	ETS364
Test Number	EB672302	EB672302
Unit	nsec	
Max Limit	8	8
Min Limit	0	0

krad(Si)	Serial #	pre_short (rtp) (2)	ST_Combo (rpt) (Delta
0	Ctrl	4.000	4.000	0.000
3	58	4.000	4.000	0.000
3	59	4.000	4.000	0.000
3	60	4.000	4.000	0.000
3	61	4.000	4.000	0.000
3	62	4.000	4.000	0.000
3	134	4.000	4.000	0.000
3	137	4.000	4.000	0.000
3	138	4.000	4.000	0.000
3	139	4.000	4.000	0.000
3	236	4.000	4.000	0.000
10	63	4.000	4.000	0.000
10	64	4.000	4.000	0.000
10	65	4.000	4.000	0.000
10	66	4.000	4.000	0.000
10	150	4.000	4.000	0.000
10	237	4.000	4.000	0.000
10	241	4.000	4.000	0.000
10	242	4.000	4.000	0.000
10	243	4.000	4.000	0.000
10	244	4.000	4.000	0.000
30	141	4.000	4.000	0.000
30	144	4.000	4.000	0.000
30	145	4.000	4.000	0.000
30	146	4.000	4.000	0.000
30	147	4.000	4.000	0.000
30	132	4.000	4.000	0.000
30	133	4.000	4.000	0.000
30	135	4.000	4.000	0.000
30	245	4.000	4.000	0.000
30	246	4.000	4.000	0.000
50	67	4.000	4.000	0.000
50	68	4.000	4.000	0.000
50	69	4.000	4.000	0.000
50	71	4.000	4.000	0.000
50	72	4.000	4.000	0.000
50	172	4.000	4.000	0.000
50	173	4.000	4.000	0.000
50	174	4.000	4.000	0.000
50	183	4.000	4.000	0.000
50	186	4.000	4.000	0.000
100	95	4.000	4.000	0.000
100	102	4.000	4.000	0.000
100	104	4.000	4.000	0.000
100	105	4.000	4.000	0.000
100	106	4.000	4.000	0.000
100	178	4.000	4.000	0.000
100	179	4.000	4.000	0.000
100	180	4.000	4.000	0.000
100	181	4.000	4.000	0.000
100	182	4.000	4.000	0.000
Max		4.000	4.000	0.000
Average		4.000	4.000	0.000
Min		4.000	4.000	0.000
Std Dev		0.000	0.000	0.000

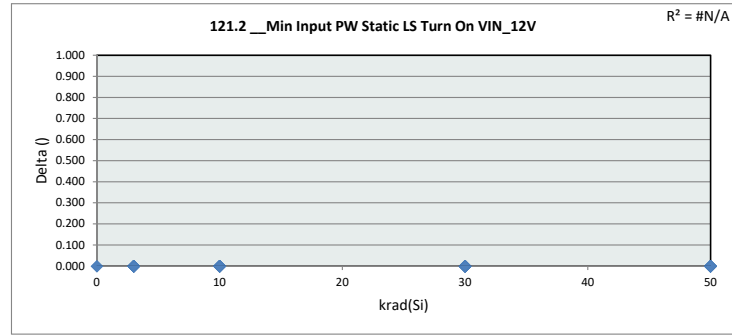

121.2 Min Input P						
Test Site	DAL-FL					
Tester	ETS364					
Test Number	EB672302					
Max Limit	8					
Min Limit	0					
krad(Si)	0	3	10	30	50	100
LL	0.000	0.000	0.000	0.000	0.000	0.000
Min	4.000	4.000	4.000	4.000	4.000	4.000
Average	4.000	4.000	4.000	4.000	4.000	4.000
Max	4.000	4.000	4.000	4.000	4.000	4.000
UL	8.000	8.000	8.000	8.000	8.000	8.000

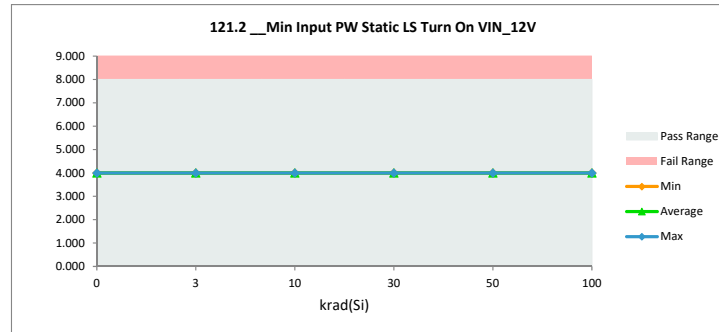

TID HDR Report
TPS7H6003-SP (5962R2220101VXC)

121.3 Min Input PW Static LS		
Test Site	DAL-FL	DAL-FL
Tester	ETS364	ETS364
Test Number	EB672302	EB672302
Unit	nsec	
Max Limit	12	12
Min Limit	0	0

krad(Si)	Serial #	pre_short (rtp) (2)	ST_Combo (rpt) (Delta
0	Ctrl	6.000	6.000	0.000
3	58	5.000	6.000	1.000
3	59	6.000	6.000	0.000
3	60	6.000	6.000	0.000
3	61	6.000	6.000	0.000
3	62	6.000	6.000	0.000
3	134	6.000	6.000	0.000
3	137	6.000	6.000	0.000
3	138	6.000	6.000	0.000
3	139	5.000	5.000	0.000
3	236	5.000	5.000	0.000
10	63	5.000	6.000	1.000
10	64	6.000	6.000	0.000
10	65	5.000	6.000	1.000
10	66	5.000	6.000	1.000
10	150	5.000	6.000	1.000
10	237	5.000	5.000	0.000
10	241	5.000	6.000	1.000
10	242	5.000	6.000	1.000
10	243	5.000	6.000	1.000
10	244	5.000	6.000	1.000
30	141	5.000	5.000	0.000
30	144	6.000	6.000	0.000
30	145	5.000	5.000	0.000
30	146	5.000	6.000	1.000
30	147	5.000	5.000	0.000
30	132	6.000	6.000	0.000
30	133	5.000	5.000	0.000
30	135	5.000	6.000	1.000
30	245	6.000	6.000	0.000
30	246	5.000	6.000	1.000
50	67	5.000	6.000	1.000
50	68	5.000	6.000	1.000
50	69	5.000	6.000	1.000
50	71	5.000	5.000	0.000
50	72	5.000	6.000	1.000
50	172	5.000	5.000	0.000
50	173	6.000	6.000	0.000
50	174	6.000	6.000	0.000
50	183	5.000	6.000	1.000
50	186	6.000	6.000	0.000
100	95	5.000	6.000	1.000
100	102	5.000	5.000	0.000
100	104	6.000	6.000	0.000
100	105	5.000	6.000	1.000
100	106	6.000	6.000	0.000
100	178	6.000	6.000	0.000
100	179	6.000	6.000	0.000
100	180	6.000	6.000	0.000
100	181	6.000	6.000	0.000
100	182	5.000	6.000	1.000
Max		6.000	6.000	1.000
Average		5.412	5.804	0.392
Min		5.000	5.000	0.000
Std Dev		0.497	0.401	0.493

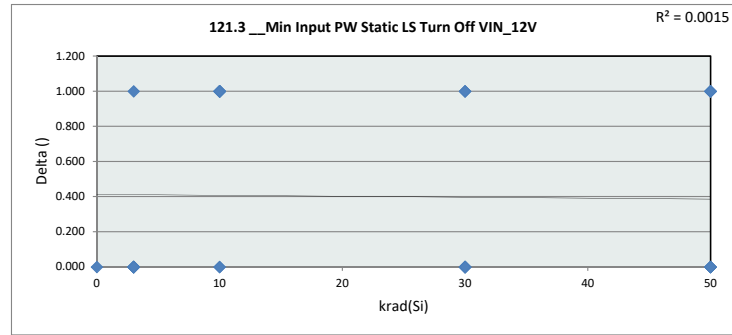

121.3 Min Input P	
Test Site	DAL-FL
Tester	ETS364
Test Number	EB672302
Max Limit	12
Min Limit	0

krad(Si)	0	3	10	30	50	100
LL	0.000	0.000	0.000	0.000	0.000	0.000
Min	6.000	5.000	5.000	5.000	5.000	5.000
Average	6.000	5.800	5.900	5.600	5.800	5.900
Max	6.000	6.000	6.000	6.000	6.000	6.000
UL	12.000	12.000	12.000	12.000	12.000	12.000

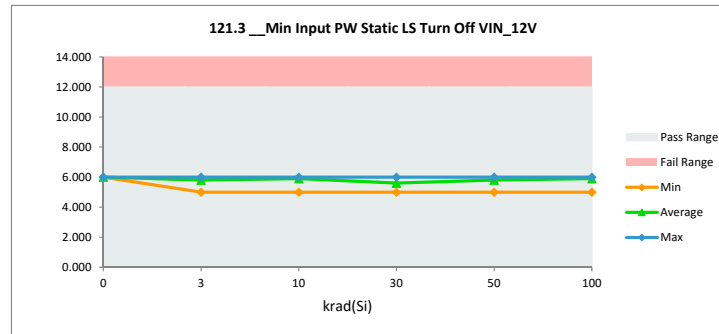

TID HDR Report
TPS7H6003-SP (5962R2220101VXC)

121.4 Min Input PW Static HS		
Test Site	DAL-FL	DAL-FL
Tester	ETS364	ETS364
Test Number	EB672302	EB672302
Unit	nsec	
Max Limit	8	8
Min Limit	0	0

krad(Si)	Serial #	pre_short (rtp) (2)	ST_Combo (rpt) (Delta
0	Ctrl	5.000	5.000	0.000
3	58	4.000	4.000	0.000
3	59	4.000	4.000	0.000
3	60	4.000	4.000	0.000
3	61	4.000	4.000	0.000
3	62	4.000	5.000	1.000
3	134	4.000	5.000	1.000
3	137	4.000	5.000	1.000
3	138	4.000	4.000	0.000
3	139	4.000	4.000	0.000
3	236	4.000	4.000	0.000
10	63	4.000	4.000	0.000
10	64	4.000	4.000	0.000
10	65	4.000	4.000	0.000
10	66	4.000	4.000	0.000
10	150	4.000	4.000	0.000
10	237	4.000	4.000	0.000
10	241	4.000	4.000	0.000
10	242	4.000	4.000	0.000
10	243	4.000	5.000	1.000
10	244	4.000	4.000	0.000
30	141	4.000	4.000	0.000
30	144	5.000	4.000	-1.000
30	145	4.000	4.000	0.000
30	146	4.000	4.000	0.000
30	147	4.000	4.000	0.000
30	132	5.000	5.000	0.000
30	133	4.000	4.000	0.000
30	135	4.000	5.000	1.000
30	245	4.000	4.000	0.000
30	246	4.000	4.000	0.000
50	67	5.000	4.000	-1.000
50	68	4.000	4.000	0.000
50	69	4.000	4.000	0.000
50	71	5.000	4.000	-1.000
50	72	4.000	4.000	0.000
50	172	4.000	4.000	0.000
50	173	4.000	4.000	0.000
50	174	4.000	4.000	0.000
50	183	4.000	4.000	0.000
50	186	5.000	4.000	-1.000
100	95	4.000	4.000	0.000
100	102	4.000	4.000	0.000
100	104	4.000	4.000	0.000
100	105	4.000	4.000	0.000
100	106	4.000	4.000	0.000
100	178	4.000	4.000	0.000
100	179	4.000	4.000	0.000
100	180	5.000	4.000	-1.000
100	181	4.000	4.000	0.000
100	182	4.000	4.000	0.000
Max		5.000	5.000	1.000
Average		4.137	4.137	0.000
Min		4.000	4.000	-1.000
Std Dev		0.348	0.348	0.447

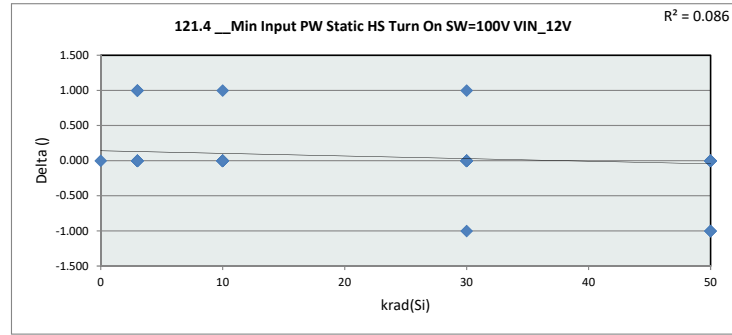

121.4 Min Input P						
Test Site	DAL-FL					
Tester	ETS364					
Test Number	EB672302					
Max Limit	8					
Min Limit	0					
krad(Si)	0	3	10	30	50	100
LL	0.000	0.000	0.000	0.000	0.000	0.000
Min	5.000	4.000	4.000	4.000	4.000	4.000
Average	5.000	4.300	4.100	4.200	4.000	4.000
Max	5.000	5.000	5.000	5.000	4.000	4.000
UL	8.000	8.000	8.000	8.000	8.000	8.000

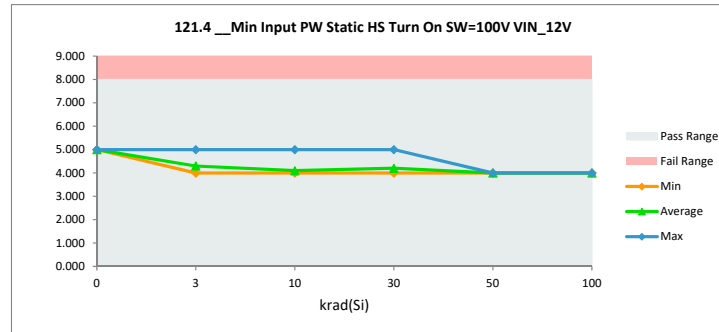

TID HDR Report
TPS7H6003-SP (5962R2220101VXC)

121.5 Min Input PW Static HS		
Test Site	DAL-FL	DAL-FL
Tester	ETS364	ETS364
Test Number	EB672302	EB672302
Unit	nsec	
Max Limit	12	12
Min Limit	0	0

krad(Si)	Serial #	pre_short (rtp) (2)	ST_Combo (rpt) (Delta
0	Ctrl	7.000	7.000	0.000
3	58	7.000	7.000	0.000
3	59	7.000	7.000	0.000
3	60	6.000	7.000	1.000
3	61	7.000	7.000	0.000
3	62	7.000	7.000	0.000
3	134	7.000	7.000	0.000
3	137	7.000	7.000	0.000
3	138	7.000	7.000	0.000
3	139	6.000	6.000	0.000
3	236	7.000	6.000	-1.000
10	63	7.000	7.000	0.000
10	64	7.000	7.000	0.000
10	65	6.000	6.000	0.000
10	66	7.000	7.000	0.000
10	150	7.000	7.000	0.000
10	237	7.000	6.000	-1.000
10	241	6.000	7.000	1.000
10	242	7.000	7.000	0.000
10	243	7.000	7.000	0.000
10	244	7.000	7.000	0.000
30	141	6.000	7.000	1.000
30	144	7.000	7.000	0.000
30	145	7.000	7.000	0.000
30	146	7.000	7.000	0.000
30	147	6.000	6.000	0.000
30	132	7.000	7.000	0.000
30	133	6.000	6.000	0.000
30	135	6.000	8.000	2.000
30	245	7.000	7.000	0.000
30	246	6.000	6.000	0.000
50	67	7.000	7.000	0.000
50	68	7.000	7.000	0.000
50	69	7.000	7.000	0.000
50	71	7.000	8.000	1.000
50	72	6.000	7.000	1.000
50	172	7.000	7.000	0.000
50	173	6.000	7.000	1.000
50	174	7.000	7.000	0.000
50	183	6.000	7.000	1.000
50	186	8.000	8.000	0.000
100	95	7.000	7.000	0.000
100	102	7.000	7.000	0.000
100	104	6.000	6.000	0.000
100	105	7.000	7.000	0.000
100	106	7.000	7.000	0.000
100	178	7.000	7.000	0.000
100	179	7.000	7.000	0.000
100	180	7.000	7.000	0.000
100	181	7.000	7.000	0.000
100	182	7.000	7.000	0.000
Max		8.000	8.000	2.000
Average		6.765	6.902	0.137
Min		6.000	6.000	-1.000
Std Dev		0.473	0.458	0.491

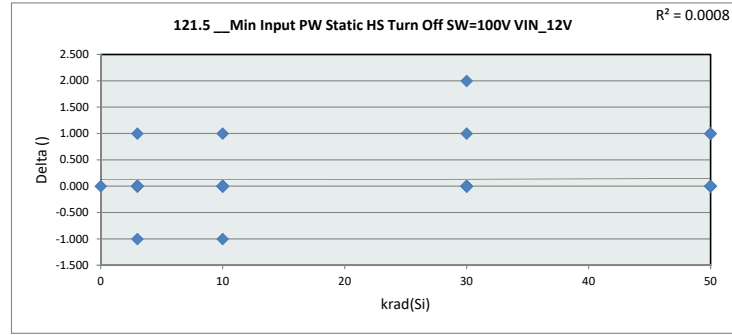

121.5 Min Input P						
Test Site	DAL-FL					
Tester	ETS364					
Test Number	EB672302					
Max Limit	12					
Min Limit	0					
krad(Si)	0	3	10	30	50	100
LL	0.000	0.000	0.000	0.000	0.000	0.000
Min	7.000	6.000	6.000	6.000	7.000	6.000
Average	7.000	6.800	6.800	6.800	7.200	6.900
Max	7.000	7.000	7.000	8.000	8.000	7.000
UL	12.000	12.000	12.000	12.000	12.000	12.000

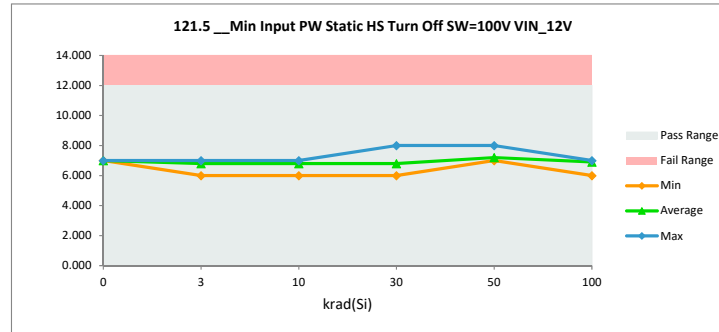

TID HDR Report
TPS7H6003-SP (5962R2220101VXC)

122.0 Min Input PW Static HS		
Test Site	DAL-FL	DAL-FL
Tester	ETS364	ETS364
Test Number	EB672302	EB672302
Unit	nsec	
Max Limit	8	8
Min Limit	0	0

krad(Si)	Serial #	pre_short (rtp) (2)	ST_Combo (rpt) (Delta
0	Ctrl	5.000	5.000	0.000
3	58	4.000	4.000	0.000
3	59	4.000	4.000	0.000
3	60	4.000	4.000	0.000
3	61	4.000	4.000	0.000
3	62	4.000	5.000	1.000
3	134	4.000	4.000	0.000
3	137	4.000	5.000	1.000
3	138	4.000	4.000	0.000
3	139	4.000	4.000	0.000
3	236	4.000	4.000	0.000
10	63	4.000	4.000	0.000
10	64	4.000	4.000	0.000
10	65	4.000	4.000	0.000
10	66	4.000	4.000	0.000
10	150	4.000	4.000	0.000
10	237	4.000	4.000	0.000
10	241	4.000	4.000	0.000
10	242	4.000	4.000	0.000
10	243	4.000	5.000	1.000
10	244	4.000	4.000	0.000
30	141	4.000	4.000	0.000
30	144	5.000	4.000	-1.000
30	145	4.000	4.000	0.000
30	146	4.000	4.000	0.000
30	147	4.000	4.000	0.000
30	132	5.000	5.000	0.000
30	133	4.000	4.000	0.000
30	135	4.000	5.000	1.000
30	245	4.000	4.000	0.000
30	246	4.000	4.000	0.000
50	67	5.000	4.000	-1.000
50	68	4.000	4.000	0.000
50	69	4.000	4.000	0.000
50	71	5.000	4.000	-1.000
50	72	4.000	4.000	0.000
50	172	4.000	4.000	0.000
50	173	4.000	4.000	0.000
50	174	4.000	4.000	0.000
50	183	4.000	4.000	0.000
50	186	4.000	4.000	0.000
100	95	4.000	4.000	0.000
100	102	4.000	4.000	0.000
100	104	4.000	4.000	0.000
100	105	4.000	4.000	0.000
100	106	4.000	4.000	0.000
100	178	4.000	4.000	0.000
100	179	4.000	4.000	0.000
100	180	5.000	4.000	-1.000
100	181	4.000	4.000	0.000
100	182	4.000	4.000	0.000
Max		5.000	5.000	1.000
Average		4.118	4.118	0.000
Min		4.000	4.000	-1.000
Std Dev		0.325	0.325	0.400

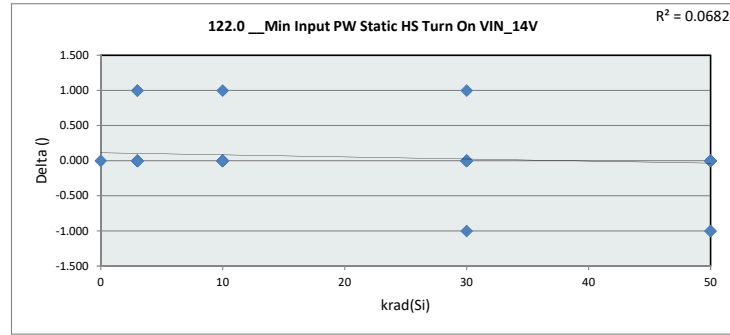

122.0 Min Input P	
Test Site	DAL-FL
Tester	ETS364
Test Number	EB672302
Max Limit	8
Min Limit	0

krad(Si)	0	3	10	30	50	100
LL	0.000	0.000	0.000	0.000	0.000	0.000
Min	5.000	4.000	4.000	4.000	4.000	4.000
Average	5.000	4.200	4.100	4.200	4.000	4.000
Max	5.000	5.000	5.000	5.000	4.000	4.000
UL	8.000	8.000	8.000	8.000	8.000	8.000

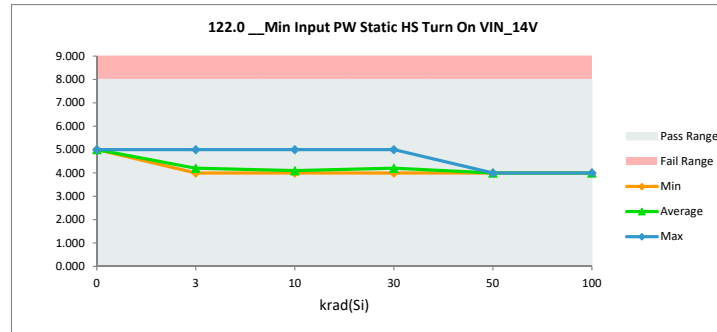

TID HDR Report
TPS7H6003-SP (5962R2220101VXC)

122.1 Min Input PW Static HS		
Test Site	DAL-FL	DAL-FL
Tester	ETS364	ETS364
Test Number	EB672302	EB672302
Unit	nsec	
Max Limit	12	12
Min Limit	0	0

krad(Si)	Serial #	pre_short (rtp) (2)	ST_Combo (rpt) (Delta
0	Ctrl	7.000	7.000	0.000
3	58	7.000	7.000	0.000
3	59	7.000	7.000	0.000
3	60	6.000	7.000	1.000
3	61	7.000	7.000	0.000
3	62	7.000	7.000	0.000
3	134	7.000	7.000	0.000
3	137	7.000	7.000	0.000
3	138	7.000	7.000	0.000
3	139	6.000	6.000	0.000
3	236	7.000	6.000	-1.000
10	63	7.000	7.000	0.000
10	64	7.000	7.000	0.000
10	65	6.000	6.000	0.000
10	66	7.000	7.000	0.000
10	150	7.000	7.000	0.000
10	237	7.000	6.000	-1.000
10	241	6.000	7.000	1.000
10	242	7.000	7.000	0.000
10	243	7.000	7.000	0.000
10	244	7.000	7.000	0.000
30	141	7.000	7.000	0.000
30	144	7.000	7.000	0.000
30	145	7.000	7.000	0.000
30	146	6.000	7.000	1.000
30	147	6.000	6.000	0.000
30	132	7.000	7.000	0.000
30	133	6.000	6.000	0.000
30	135	6.000	8.000	2.000
30	245	7.000	7.000	0.000
30	246	6.000	6.000	0.000
50	67	7.000	7.000	0.000
50	68	7.000	7.000	0.000
50	69	6.000	7.000	1.000
50	71	7.000	8.000	1.000
50	72	6.000	7.000	1.000
50	172	7.000	7.000	0.000
50	173	6.000	6.000	0.000
50	174	7.000	7.000	0.000
50	183	6.000	6.000	0.000
50	186	8.000	8.000	0.000
100	95	7.000	7.000	0.000
100	102	7.000	7.000	0.000
100	104	6.000	6.000	0.000
100	105	7.000	7.000	0.000
100	106	7.000	7.000	0.000
100	178	7.000	7.000	0.000
100	179	7.000	7.000	0.000
100	180	7.000	7.000	0.000
100	181	7.000	7.000	0.000
100	182	7.000	7.000	0.000
Max		8.000	8.000	2.000
Average		6.745	6.863	0.118
Min		6.000	6.000	-1.000
Std Dev		0.483	0.491	0.475

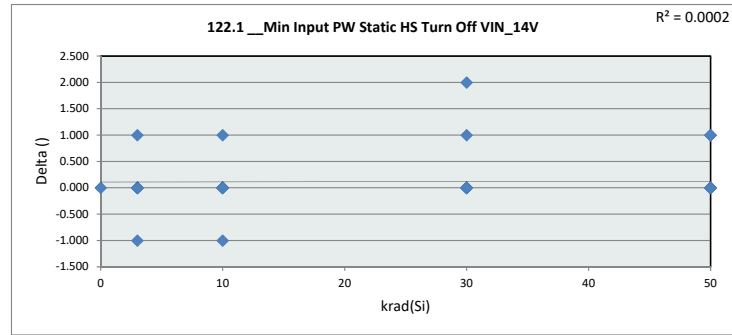

122.1 Min Input P	
Test Site	DAL-FL
Tester	ETS364
Test Number	EB672302
Max Limit	12
Min Limit	0

krad(Si)	0	3	10	30	50	100
LL	0.000	0.000	0.000	0.000	0.000	0.000
Min	7.000	6.000	6.000	6.000	6.000	6.000
Average	7.000	6.800	6.800	6.800	7.000	6.900
Max	7.000	7.000	7.000	8.000	8.000	7.000
UL	12.000	12.000	12.000	12.000	12.000	12.000

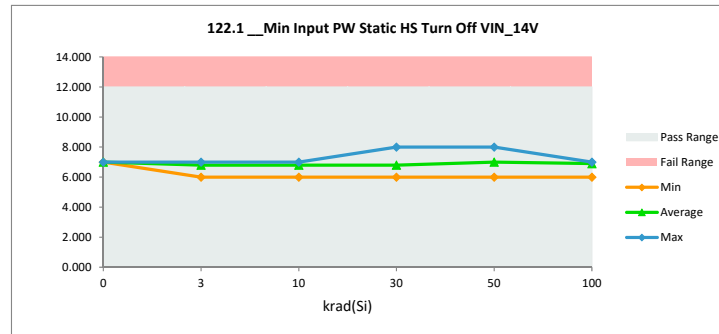

TID HDR Report
TPS7H6003-SP (5962R2220101VXC)

122.2 Min Input PW Static LS		
Test Site	DAL-FL	DAL-FL
Tester	ETS364	ETS364
Test Number	EB672302	EB672302
Unit	nsec	
Max Limit	8	8
Min Limit	0	0

krad(Si)	Serial #	pre_short (rtp) (2)	ST_Combo (rpt) (Delta
0	Ctrl	4.000	4.000	0.000
3	58	4.000	4.000	0.000
3	59	4.000	4.000	0.000
3	60	4.000	4.000	0.000
3	61	4.000	4.000	0.000
3	62	4.000	4.000	0.000
3	134	4.000	4.000	0.000
3	137	4.000	4.000	0.000
3	138	4.000	4.000	0.000
3	139	4.000	4.000	0.000
3	236	4.000	4.000	0.000
10	63	4.000	4.000	0.000
10	64	4.000	4.000	0.000
10	65	4.000	4.000	0.000
10	66	4.000	4.000	0.000
10	150	4.000	4.000	0.000
10	237	4.000	4.000	0.000
10	241	4.000	4.000	0.000
10	242	4.000	4.000	0.000
10	243	4.000	4.000	0.000
10	244	4.000	4.000	0.000
30	141	4.000	4.000	0.000
30	144	4.000	4.000	0.000
30	145	4.000	4.000	0.000
30	146	4.000	4.000	0.000
30	147	4.000	4.000	0.000
30	132	4.000	4.000	0.000
30	133	4.000	4.000	0.000
30	135	4.000	4.000	0.000
30	245	4.000	4.000	0.000
30	246	4.000	4.000	0.000
50	67	4.000	4.000	0.000
50	68	4.000	4.000	0.000
50	69	4.000	4.000	0.000
50	71	4.000	4.000	0.000
50	72	4.000	4.000	0.000
50	172	4.000	4.000	0.000
50	173	4.000	4.000	0.000
50	174	4.000	4.000	0.000
50	183	4.000	4.000	0.000
50	186	4.000	4.000	0.000
100	95	4.000	4.000	0.000
100	102	4.000	4.000	0.000
100	104	4.000	4.000	0.000
100	105	4.000	4.000	0.000
100	106	4.000	4.000	0.000
100	178	4.000	4.000	0.000
100	179	4.000	4.000	0.000
100	180	4.000	4.000	0.000
100	181	4.000	4.000	0.000
100	182	4.000	4.000	0.000
Max		4.000	4.000	0.000
Average		4.000	4.000	0.000
Min		4.000	4.000	0.000
Std Dev		0.000	0.000	0.000

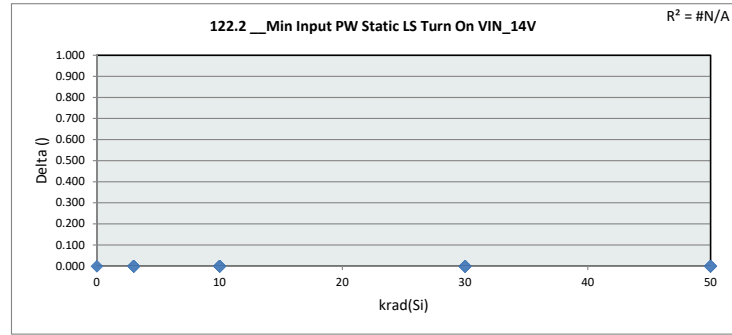

122.2 Min Input P						
Test Site	DAL-FL					
Tester	ETS364					
Test Number	EB672302					
Max Limit	8					
Min Limit	0					
krad(Si)	0	3	10	30	50	100
LL	0.000	0.000	0.000	0.000	0.000	0.000
Min	4.000	4.000	4.000	4.000	4.000	4.000
Average	4.000	4.000	4.000	4.000	4.000	4.000
Max	4.000	4.000	4.000	4.000	4.000	4.000
UL	8.000	8.000	8.000	8.000	8.000	8.000

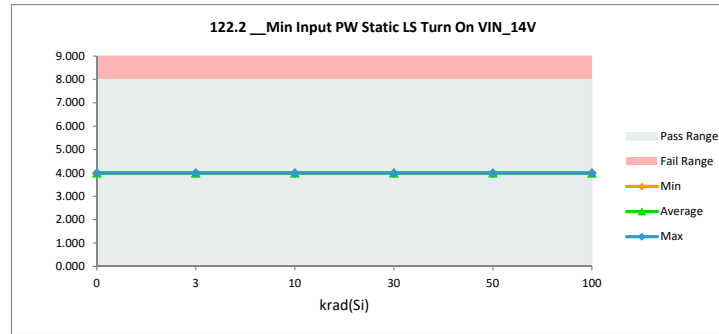

TID HDR Report
TPS7H6003-SP (5962R2220101VXC)

122.3 Min Input PW Static LS		
Test Site	DAL-FL	DAL-FL
Tester	ETS364	ETS364
Test Number	EB672302	EB672302
Unit	nsec	
Max Limit	12	12
Min Limit	0	0

krad(Si)	Serial #	pre_short (rtp) (2)	ST_Combo (rpt) (Delta
0	Ctrl	6.000	6.000	0.000
3	58	5.000	6.000	1.000
3	59	6.000	6.000	0.000
3	60	6.000	6.000	0.000
3	61	6.000	6.000	0.000
3	62	6.000	6.000	0.000
3	134	5.000	6.000	1.000
3	137	6.000	6.000	0.000
3	138	6.000	6.000	0.000
3	139	5.000	5.000	0.000
3	236	6.000	5.000	-1.000
10	63	5.000	6.000	1.000
10	64	6.000	6.000	0.000
10	65	5.000	6.000	1.000
10	66	5.000	6.000	1.000
10	150	5.000	6.000	1.000
10	237	5.000	5.000	0.000
10	241	5.000	6.000	1.000
10	242	5.000	6.000	1.000
10	243	5.000	6.000	1.000
10	244	5.000	6.000	1.000
30	141	5.000	5.000	0.000
30	144	6.000	6.000	0.000
30	145	5.000	5.000	0.000
30	146	5.000	6.000	1.000
30	147	5.000	5.000	0.000
30	132	6.000	6.000	0.000
30	133	5.000	5.000	0.000
30	135	5.000	6.000	1.000
30	245	6.000	6.000	0.000
30	246	5.000	6.000	1.000
50	67	5.000	6.000	1.000
50	68	5.000	6.000	1.000
50	69	6.000	6.000	0.000
50	71	5.000	5.000	0.000
50	72	5.000	6.000	1.000
50	172	5.000	5.000	0.000
50	173	6.000	6.000	0.000
50	174	6.000	6.000	0.000
50	183	5.000	6.000	1.000
50	186	6.000	6.000	0.000
100	95	5.000	6.000	1.000
100	102	5.000	5.000	0.000
100	104	6.000	6.000	0.000
100	105	5.000	6.000	1.000
100	106	6.000	6.000	0.000
100	178	5.000	6.000	1.000
100	179	6.000	6.000	0.000
100	180	6.000	6.000	0.000
100	181	6.000	6.000	0.000
100	182	5.000	6.000	1.000
Max		6.000	6.000	1.000
Average		5.412	5.804	0.392
Min		5.000	5.000	-1.000
Std Dev		0.497	0.401	0.532

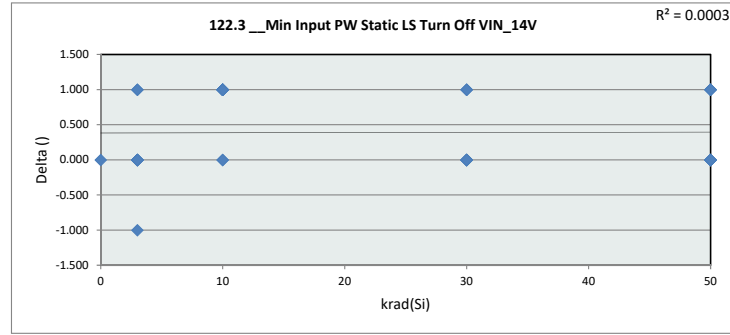

122.3 Min Input P	
Test Site	DAL-FL
Tester	ETS364
Test Number	EB672302
Max Limit	12
Min Limit	0

krad(Si)	0	3	10	30	50	100
LL	0.000	0.000	0.000	0.000	0.000	0.000
Min	6.000	5.000	5.000	5.000	5.000	5.000
Average	6.000	5.800	5.900	5.600	5.800	5.900
Max	6.000	6.000	6.000	6.000	6.000	6.000
UL	12.000	12.000	12.000	12.000	12.000	12.000

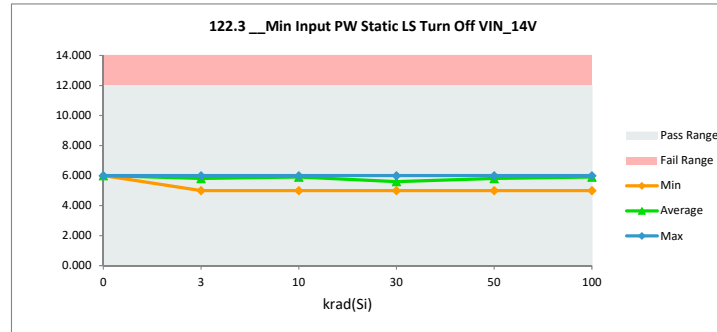

TID HDR Report
TPS7H6003-SP (5962R2220101VXC)

122.4 Min Input PW Static HS		
Test Site	DAL-FL	DAL-FL
Tester	ETS364	ETS364
Test Number	EB672302	EB672302
Unit	nsec	
Max Limit	8	8
Min Limit	0	0

krad(Si)	Serial #	pre_short (rtp) (2)	ST_Combo (rpt) (Delta
0	Ctrl	5.000	5.000	0.000
3	58	4.000	4.000	0.000
3	59	4.000	4.000	0.000
3	60	4.000	4.000	0.000
3	61	4.000	4.000	0.000
3	62	4.000	5.000	1.000
3	134	4.000	4.000	0.000
3	137	4.000	5.000	1.000
3	138	4.000	4.000	0.000
3	139	4.000	4.000	0.000
3	236	4.000	4.000	0.000
10	63	4.000	4.000	0.000
10	64	4.000	4.000	0.000
10	65	4.000	4.000	0.000
10	66	4.000	4.000	0.000
10	150	4.000	4.000	0.000
10	237	4.000	4.000	0.000
10	241	4.000	5.000	1.000
10	242	4.000	4.000	0.000
10	243	5.000	5.000	0.000
10	244	4.000	4.000	0.000
30	141	4.000	4.000	0.000
30	144	5.000	4.000	-1.000
30	145	4.000	4.000	0.000
30	146	4.000	4.000	0.000
30	147	4.000	4.000	0.000
30	132	5.000	5.000	0.000
30	133	4.000	4.000	0.000
30	135	4.000	5.000	1.000
30	245	4.000	4.000	0.000
30	246	4.000	4.000	0.000
50	67	5.000	4.000	-1.000
50	68	4.000	4.000	0.000
50	69	4.000	4.000	0.000
50	71	5.000	4.000	-1.000
50	72	4.000	4.000	0.000
50	172	4.000	4.000	0.000
50	173	4.000	4.000	0.000
50	174	4.000	4.000	0.000
50	183	4.000	4.000	0.000
50	186	5.000	4.000	-1.000
100	95	4.000	4.000	0.000
100	102	4.000	4.000	0.000
100	104	4.000	4.000	0.000
100	105	4.000	4.000	0.000
100	106	4.000	4.000	0.000
100	178	4.000	4.000	0.000
100	179	4.000	4.000	0.000
100	180	5.000	4.000	-1.000
100	181	4.000	4.000	0.000
100	182	4.000	4.000	0.000
Max		5.000	5.000	1.000
Average		4.157	4.137	-0.020
Min		4.000	4.000	-1.000
Std Dev		0.367	0.348	0.424

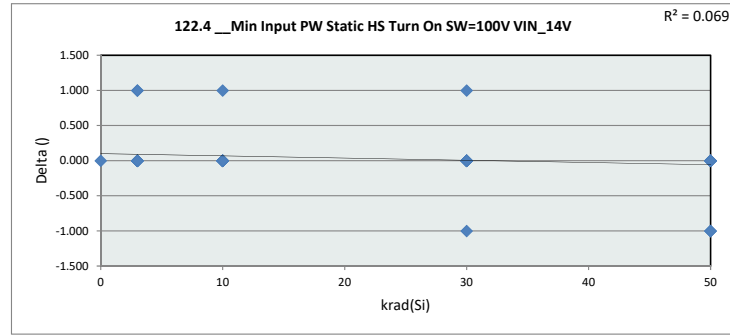

122.4 Min Input P	
Test Site	DAL-FL
Tester	ETS364
Test Number	EB672302
Max Limit	8
Min Limit	0

krad(Si)	0	3	10	30	50	100
LL	0.000	0.000	0.000	0.000	0.000	0.000
Min	5.000	4.000	4.000	4.000	4.000	4.000
Average	5.000	4.200	4.200	4.200	4.000	4.000
Max	5.000	5.000	5.000	5.000	4.000	4.000
UL	8.000	8.000	8.000	8.000	8.000	8.000

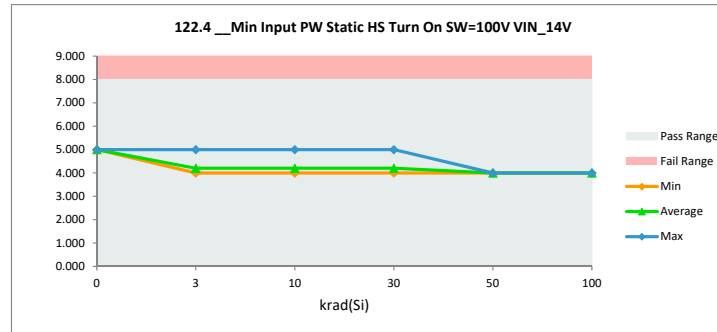

TID HDR Report
TPS7H6003-SP (5962R2220101VXC)

122.5 Min Input PW Static HS		
Test Site	DAL-FL	DAL-FL
Tester	ETS364	ETS364
Test Number	EB672302	EB672302
Unit	nsec	
Max Limit	12	12
Min Limit	0	0

krad(Si)	Serial #	pre_short (rtp) (2)	ST_Combo (rpt) (Delta
0	Ctrl	7.000	7.000	0.000
3	58	7.000	7.000	0.000
3	59	7.000	7.000	0.000
3	60	6.000	7.000	1.000
3	61	7.000	7.000	0.000
3	62	7.000	7.000	0.000
3	134	7.000	7.000	0.000
3	137	7.000	7.000	0.000
3	138	7.000	7.000	0.000
3	139	6.000	6.000	0.000
3	236	7.000	6.000	-1.000
10	63	7.000	7.000	0.000
10	64	7.000	7.000	0.000
10	65	6.000	6.000	0.000
10	66	7.000	7.000	0.000
10	150	7.000	7.000	0.000
10	237	7.000	6.000	-1.000
10	241	6.000	7.000	1.000
10	242	7.000	7.000	0.000
10	243	7.000	7.000	0.000
10	244	7.000	7.000	0.000
30	141	7.000	7.000	0.000
30	144	7.000	7.000	0.000
30	145	7.000	7.000	0.000
30	146	6.000	7.000	1.000
30	147	6.000	6.000	0.000
30	132	7.000	7.000	0.000
30	133	6.000	6.000	0.000
30	135	6.000	8.000	2.000
30	245	7.000	7.000	0.000
30	246	6.000	6.000	0.000
50	67	7.000	7.000	0.000
50	68	6.000	7.000	1.000
50	69	7.000	7.000	0.000
50	71	7.000	8.000	1.000
50	72	6.000	7.000	1.000
50	172	7.000	7.000	0.000
50	173	6.000	7.000	1.000
50	174	7.000	7.000	0.000
50	183	6.000	7.000	1.000
50	186	8.000	8.000	0.000
100	95	7.000	7.000	0.000
100	102	7.000	7.000	0.000
100	104	6.000	6.000	0.000
100	105	7.000	7.000	0.000
100	106	7.000	7.000	0.000
100	178	7.000	7.000	0.000
100	179	7.000	7.000	0.000
100	180	7.000	7.000	0.000
100	181	7.000	7.000	0.000
100	182	7.000	7.000	0.000
Max		8.000	8.000	2.000
Average		6.745	6.902	0.157
Min		6.000	6.000	-1.000
Std Dev		0.483	0.458	0.505

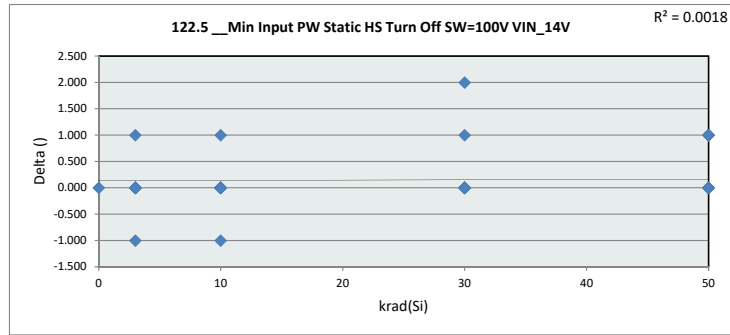

122.5 Min Input P						
Test Site	DAL-FL					
Tester	ETS364					
Test Number	EB672302					
Max Limit	12					
Min Limit	0					
krad(Si)	0	3	10	30	50	100
LL	0.000	0.000	0.000	0.000	0.000	0.000
Min	7.000	6.000	6.000	6.000	7.000	6.000
Average	7.000	6.800	6.800	6.800	7.200	6.900
Max	7.000	7.000	7.000	8.000	8.000	7.000
UL	12.000	12.000	12.000	12.000	12.000	12.000

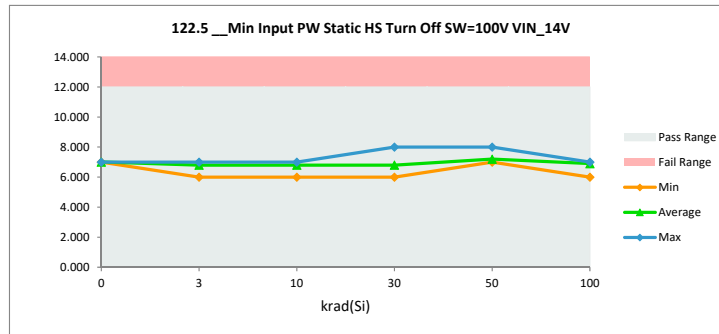

IMPORTANT NOTICE AND DISCLAIMER

TI PROVIDES TECHNICAL AND RELIABILITY DATA (INCLUDING DATA SHEETS), DESIGN RESOURCES (INCLUDING REFERENCE DESIGNS), APPLICATION OR OTHER DESIGN ADVICE, WEB TOOLS, SAFETY INFORMATION, AND OTHER RESOURCES "AS IS" AND WITH ALL FAULTS, AND DISCLAIMS ALL WARRANTIES, EXPRESS AND IMPLIED, INCLUDING WITHOUT LIMITATION ANY IMPLIED WARRANTIES OF MERCHANTABILITY, FITNESS FOR A PARTICULAR PURPOSE OR NON-INFRINGEMENT OF THIRD PARTY INTELLECTUAL PROPERTY RIGHTS.

These resources are intended for skilled developers designing with TI products. You are solely responsible for (1) selecting the appropriate TI products for your application, (2) designing, validating and testing your application, and (3) ensuring your application meets applicable standards, and any other safety, security, regulatory or other requirements.

These resources are subject to change without notice. TI grants you permission to use these resources only for development of an application that uses the TI products described in the resource. Other reproduction and display of these resources is prohibited. No license is granted to any other TI intellectual property right or to any third party intellectual property right. TI disclaims responsibility for, and you will fully indemnify TI and its representatives against, any claims, damages, costs, losses, and liabilities arising out of your use of these resources.

TI's products are provided subject to [TI's Terms of Sale](#) or other applicable terms available either on [ti.com](https://www.ti.com) or provided in conjunction with such TI products. TI's provision of these resources does not expand or otherwise alter TI's applicable warranties or warranty disclaimers for TI products.

TI objects to and rejects any additional or different terms you may have proposed.

Mailing Address: Texas Instruments, Post Office Box 655303, Dallas, Texas 75265
Copyright © 2023, Texas Instruments Incorporated