

HDC2022EVM

User's Guide



Literature Number: SNIU039
December 2019

1	Trademarks	4
2	Quick Start	5
3	EVM GUI	6
	3.1 Software Setup	6
4	GUI Operation	7
	4.1 Home Tab	7
	4.2 Data Capture Tab	8
	4.3 EVM Settings Tab	9
	4.4 Device Configuration	10
	4.5 Registers Tab	11
	4.6 Collateral Tab	12
5	EVM Hardware	13
	5.1 Input/Output Connector Description	13
	5.2 EVM Operating Conditions	13
	5.3 Device Address Configuration	14
	5.4 Reducing the Sensor's Thermal Mass	15
6	Updating Firmware on HDC2022EVM	17
7	Board Layout	19
8	Schematic	20
9	HDC2022EVM Bill of Materials	21

List of Figures

1	HDC2022DEB with ePTFE Filter	4
2	HDC2022EVM GUI on first startup	5
3	Download Pop-Up	6
4	Home Tab of HDC2022EVM GUI	7
5	Data Capture Tab of HDC2022EVM GUI.....	8
6	EVM Setup Tab of HDC2022EVM GUI	9
7	Device Configuration Tab of HDC2022EVM GUI	10
8	Register Tab of HDC2022EVM GUI	11
9	Collateral Tab of HDC2022EVM GUI.....	12
10	HDC2022EVM	13
11	HDC2022EVM : Sensor Module.....	14
12	HDC2022EVM: Layout Resistors for I2C Address Setting - Top	14
13	HDC2022EVM: PC Interface and Sensor Module	15
14	HDC2022EVM: PC Interface and Smaller Sensor Module	15
15	HDC2022EVM: Pads for I2C and Supply of the Smaller Sensor Module	16
16	HDC2022EVM Spy-Bi-Wire programming connections	17
17	UniFlash Launch Screen, MSP430F5528 device selected.	18
18	Top Layer Routing	19
19	Bottom Layer Routing.....	19
20	HDC2022EVM Schematic.....	20

List of Tables

1	Device and Package Configurations	4
2	EVM Temperature Range	13
3	I2C Address	14

HDC2022EVM User's Guide

The Texas Instruments HDC2022EVM evaluation module (EVM) enables designers to evaluate the operation and performance of the HDC2022 Relative Humidity and Temperature Sensor.

The EVM contains one HDC2022 (see [Table 1](#)).

Table 1. Device and Package Configurations

DEVICE	IC	PACKAGE
U1	HDC2022DEB	WSON (6-pin) DEB

The EVM hosts an MSP430F5528 microcontroller (μ C) as well as the HDC2022. The μ C is used to control the HDC2022 and communicate with a host PC through a USB port. The EVM is designed to be broken into two sections if desired. The sensor section can be separated from the μ C section of the board to reduce thermal mass surrounding the HDC2022.

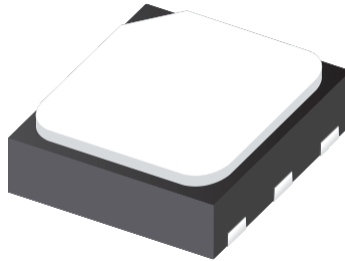

Figure 1. HDC2022DEB with ePTFE Filter

1 Trademarks

All trademarks are the property of their respective owners.

2 Quick Start

1. Click [here](#) in Safari, Firefox, or Chrome and select the HDC202xEVM GUI from the gallery to access the cloud-based GUI. The browser window should appear as in [Figure 2](#). Follow the onscreen instruction to complete setup.

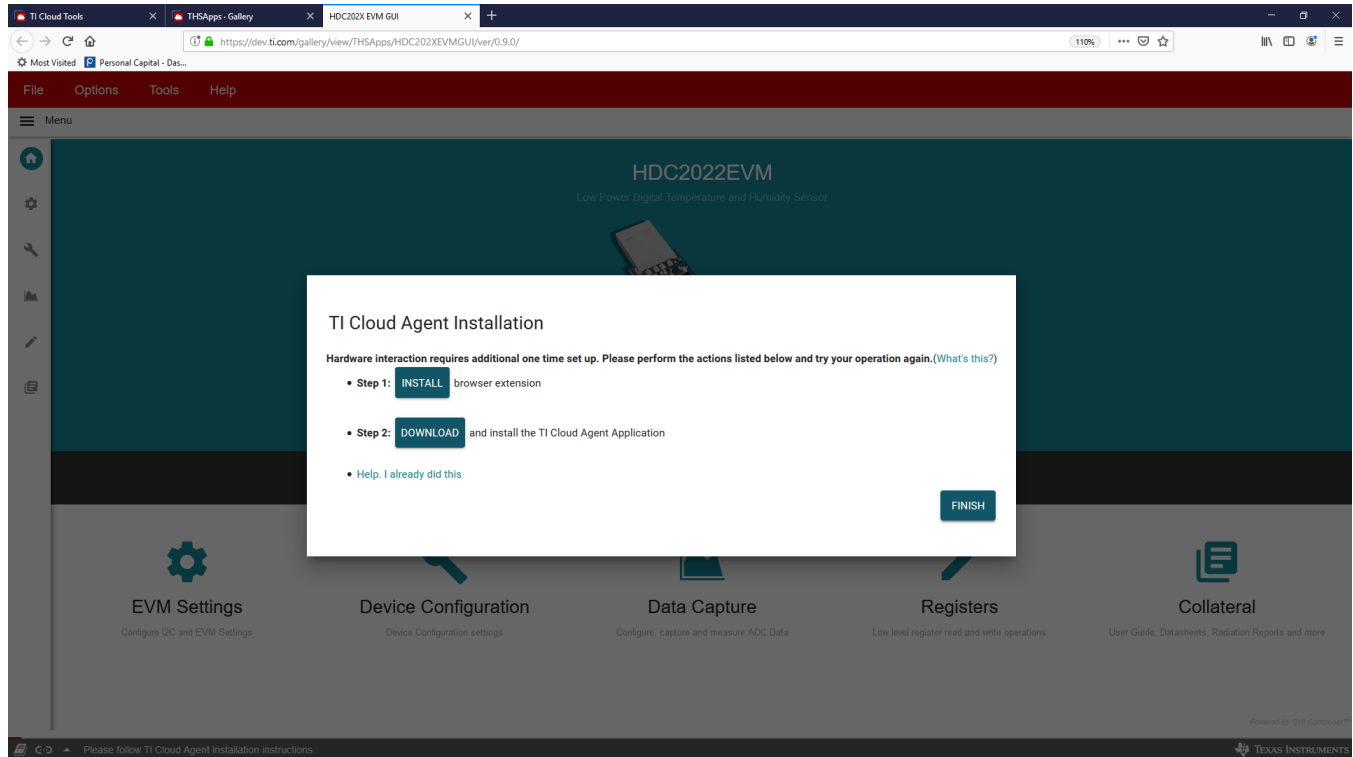





Figure 2. HDC2022EVM GUI on first startup

2. Reload the browser window after installation to access the home screen of the HDC2022EVM GUI.
 3. Connect the HDC2022EVM to the USB port of your computer via USB. Drivers for the device will install automatically and the GUI will connect to the EVM.
 4. Temperature and humidity data can be recorded and logged on the data capture tab. Select the  icon to navigate to this page. You can enable register auto-read from this page, and initiate a one-shot to take sample data.
 5. Configure device settings from the device configuration tab .
 6. Register, bit-field, and bit level configuration can be performed from the register tab .
- See [Section 4](#) for more information on GUI tabs, operation, and installation of the local version of the HDC2022EVM GUI.

3 EVM GUI

3.1 Software Setup

The PC GUI software for the HDC2022EVM runs on TI's GUI composer framework. The software is available as a live version which runs in your browser, and is available as a download for offline use. The software is compatible with Windows, Mac, and Linux Operating systems.

3.1.1 Live Software on dev.ti.com

The live software currently works within Chrome, Firefox and Safari browsers. Internet Explorer and Edge browsers are not supported. User can access the live version through one of the following actions:

- Go to the [HDC2022EVM Tool page](#) on TI.com and click on the View Button
- Go to [dev.ti.com/gallery](#) and search for the HDC2022EVM. Click on the application icon within the gallery to launch the software. Follow the prompts onscreen to install the TI Cloud Agent Bridge browser plugin.

3.1.2 Offline Software

3.1.2.1 Download GUI from dev.ti.com

Users can access the latest version of the offline software by navigating to the live version as noted above. Look for the download icon  and download both the application and runtime for the operating system as shown in the download pop-up. After download, unzip and run the downloaded executable file. Follow the onscreen instructions to install the local version of the GUI.

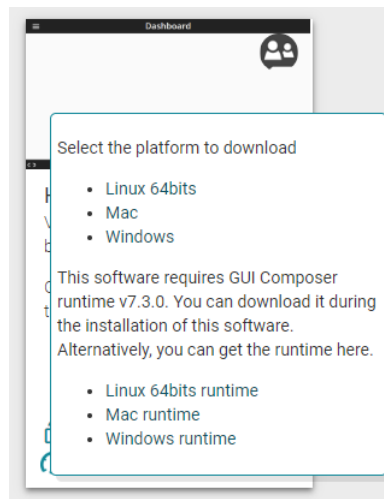

Figure 3. Download Pop-Up

4 GUI Operation

The section describes how to use the HDC2022EVM GUI

4.1 Home Tab

The Home Tab is shown at software launch. The Learn More link displays the key features and a functional diagram for the HDC2022 device. The icons on the left side of the screen are shortcuts which can be used for navigation to other tabs within the GUI.

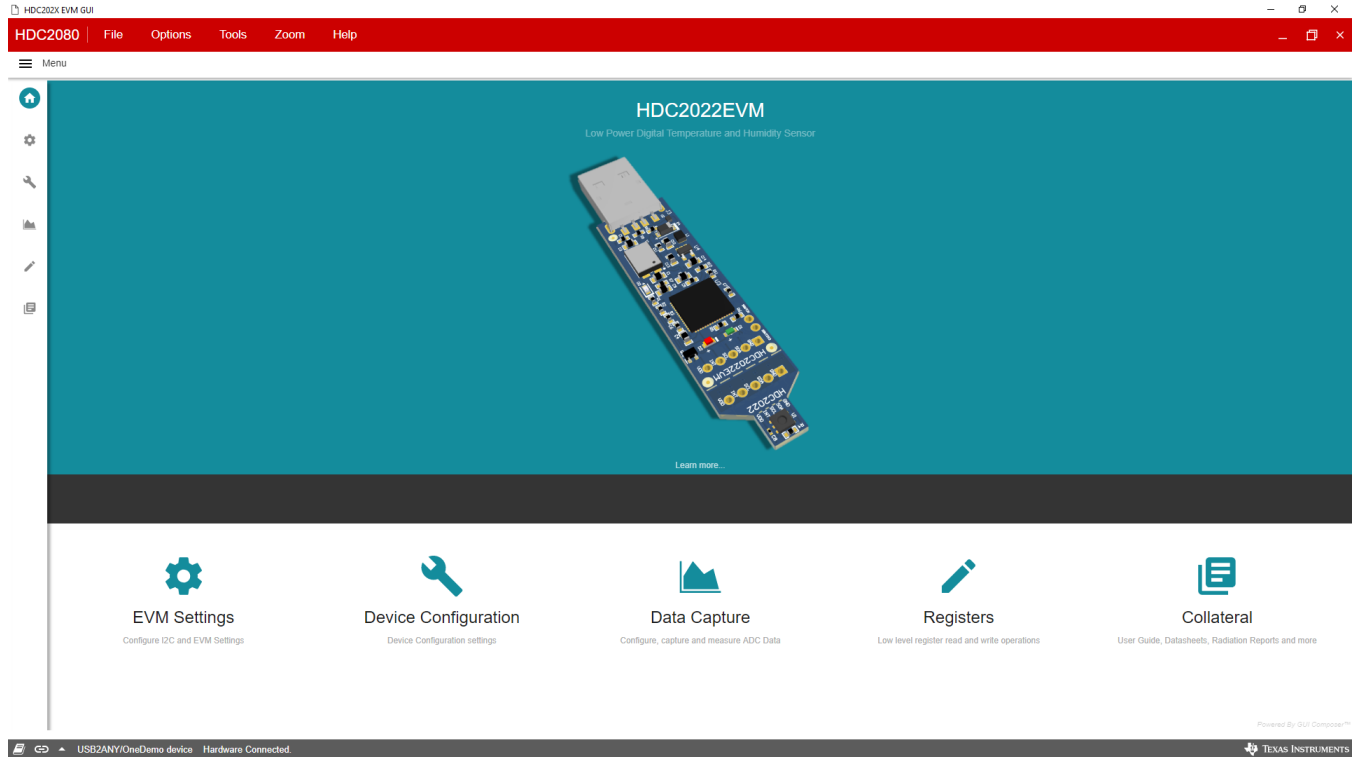

Figure 4. Home Tab of HDC2022EVM GUI

4.2 Data Capture Tab

The Data Capture tab reports the temperature and humidity from the HDC2022 device included on the HDC2022EVM. To enable data capture, ensure that an auto-read delay from the drop down menu at the top of the page is selected.

Each selection option/button on this tab has a specific function as described below:

- **Register Auto Read Delay:** Changes the delay between register reads
- **Measurement Configuration:** Configures the HDC2022 to return temperature, humidity, or both.
- **Humidity/Temperature Resolution:** Change the number of measurement bits for humidity/temperature measurements.
- **Auto Measurement Mode:** Set the auto-measurement frequency of the HDC2022.
- **Start Measurement/One-Shot Button:** In shutdown mode, this button triggers a measurement. When an auto-measurement frequency is selected, this button begins measuring from the HDC2022.
- **Celsius/Fahrenheit Select:** Sets the GUI to display in Celsius or Fahrenheit. This does not change settings for the HDC2022 or EVM.
- **Activate Soft Reset Button:** Triggers a soft reset of the HDC2022.
- **Activate Heater Button:** Enables the heater on the HDC2022.

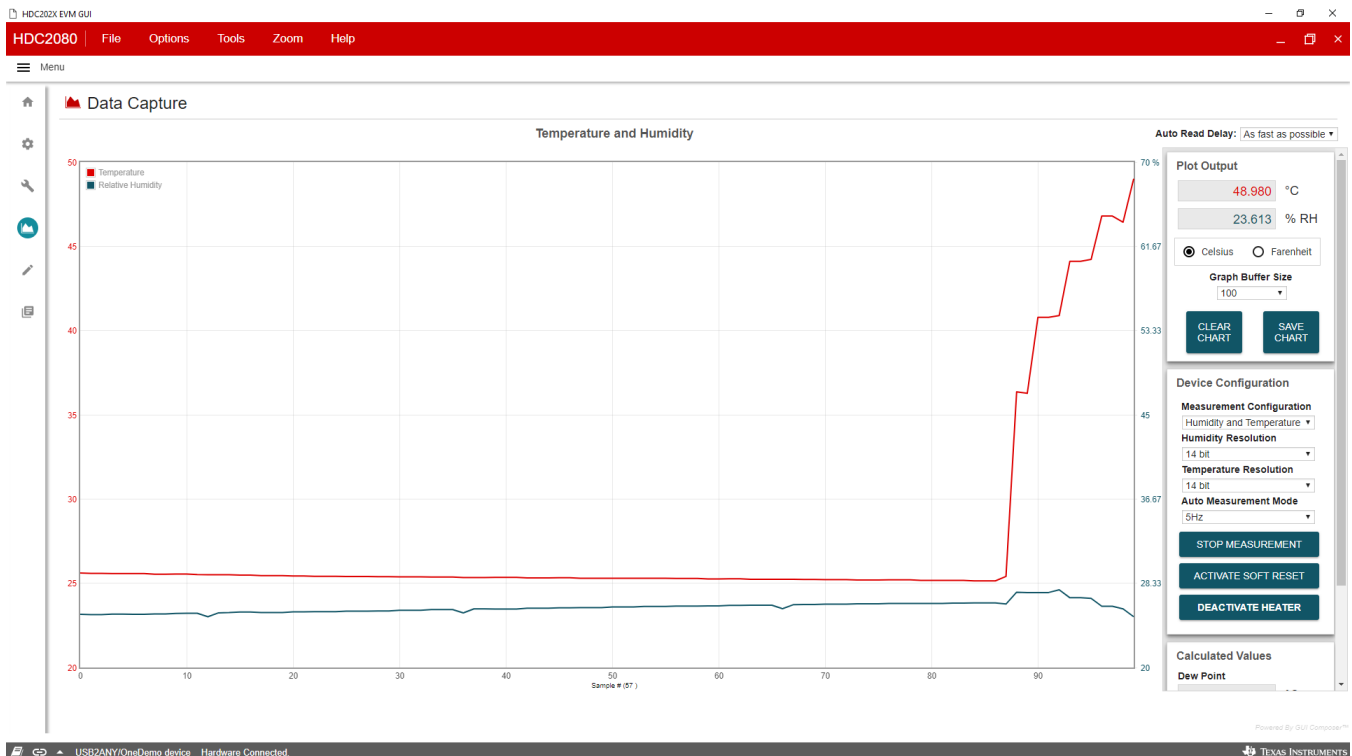

Figure 5. Data Capture Tab of HDC2022EVM GUI

4.3 EVM Settings Tab

The EVM Settings tab allows for setup of features for the USB to I2C bridge and EVM GUI. Selecting an alternate I2C address will disconnect the GUI from the USB device. The EVM must be modified as discussed in [Section 5.3](#) to use the alternate address.

Each selection option/button on this tab has a specific function as described below:

- **I2C Frequency:** Change the communication frequency between the control board and HDC2022EVM.
- **I2C Address:** Selects the address option of the HDC2022.
- **Firmware Read Button:** Reads the current version of the EVM firmware.
- **ID Registers Indicators:** Returns the value of the HDC2022 ID registers.
- **Scaling Mode:** Set to Fixed/Auto to control the scaling of the graph on the Data Capture Tab.
- **Scaling Min/Max Temp/Humidity:** Set the min and max values for the temperature and humidity graph on the Data Capture Tab.

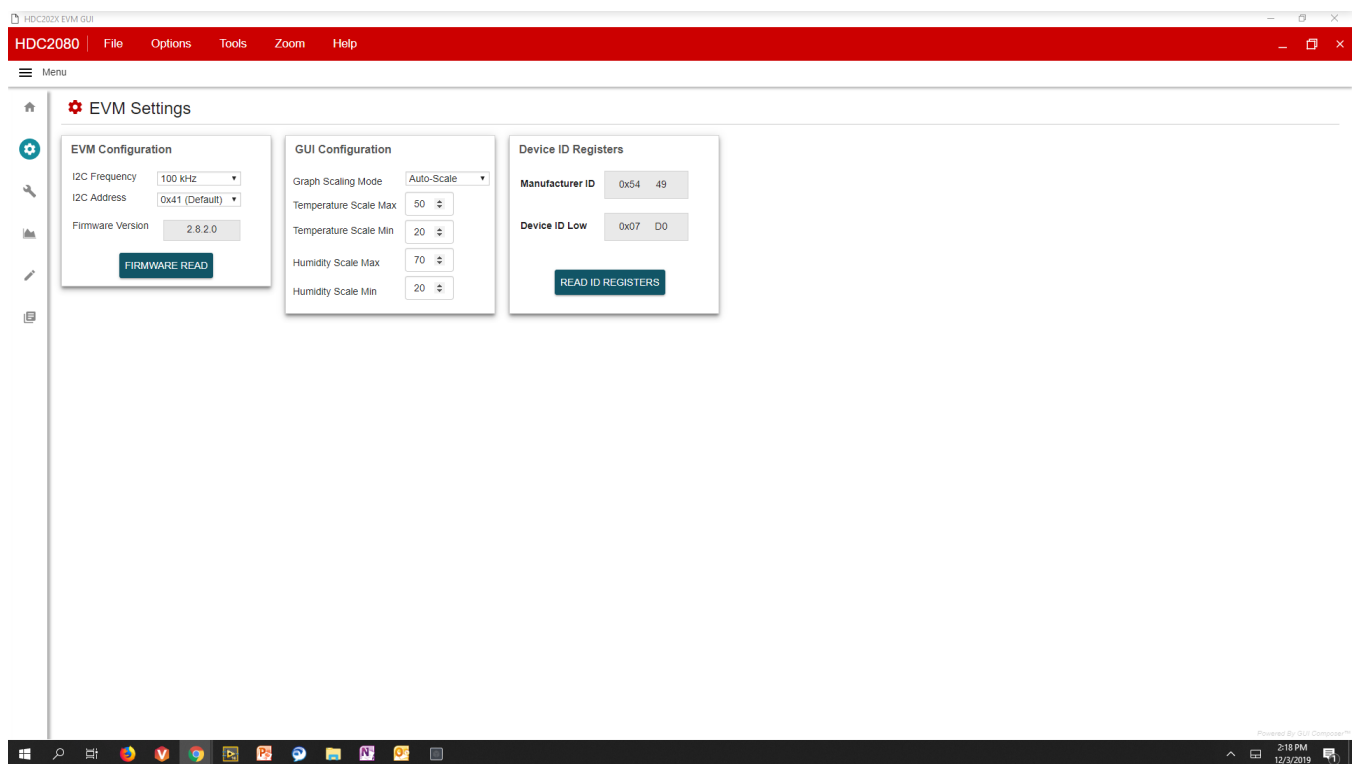

Figure 6. EVM Setup Tab of HDC2022EVM GUI

4.4 Device Configuration

The Device Configuration tab allows for easy configuration and setup of the HDC2022 device included on the HDC2022EVM. If immediate write mode is selected on the [Section 4.5](#), then changes made in the selection boxes will be written to the HDC2022 device as soon as possible.

The Auto Measurement Mode, Temperature/Humidity Resolution, Measurement Configuration, activate Soft Reset, and Activate Heater widgets perform the same functions as on the Data Capture tab (refer to [Section 4.2.](#)) The other widgets are described below:

- **DRDY/INT_EN Pin Configuration:** Selects the output for the HDC2022 interrupt pin
- **Interrupt Polarity:** Selects the active/inactive state of the HDC2022 interrupt pin
- **Interrupt Mode:** Sets the behavior of the HDC2022 interrupt pin.
- **Humidity/Temperature Offset:** Sets the value of respective offset register within the HDC2022.
- **Humidity/Temperature Threshold:** Sets the value of the threshold registers within the HDC2022.
- **HDC2022 Interrupt/DRDY Configuration Enable Bits:** Selects the source of the HDC2022 Interrupt.

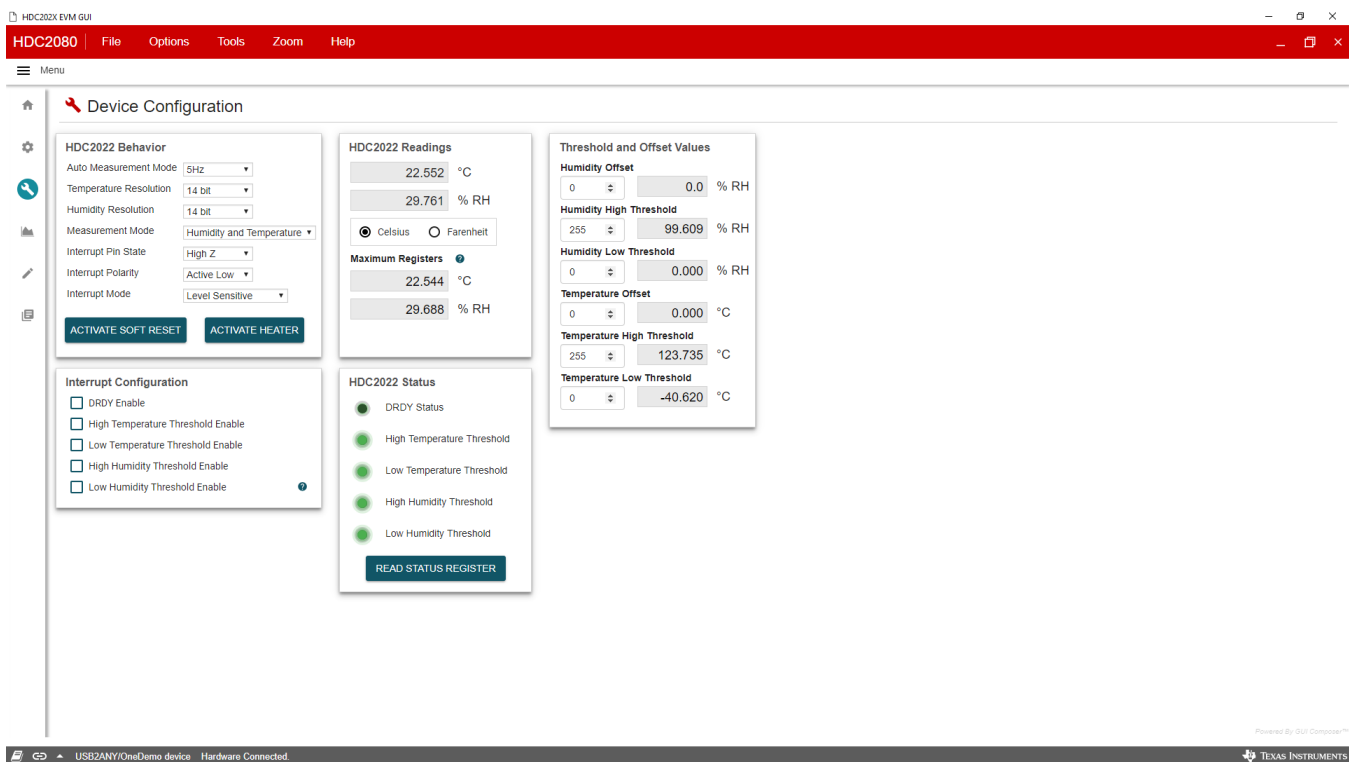

Figure 7. Device Configuration Tab of HDC2022EVM GUI

4.5 Registers Tab

The Registers tab allows for user interaction with the HDC2022 device onboard the EVM at the register, bit, and bitfield level.

The Auto read drop-down box configures the rate of polling the register contents. When Auto-Read is off, it is necessary to click Read Register to fetch the contents of the current register. Read All Registers can be used to fetch the contents of all registers at once.

The Write Register buttons are disabled when the drop-down next to these buttons is set to immediate mode. Immediate mode will trigger a write operation each time a register is modified. When deferred mode is selected, the write register button is enabled, and write operations will be performed only when the write register button is clicked. These settings give the user control over I2C bus activity, and enable individual transactions which can be easily observed via oscilloscope, logic analyzer, or bus-sniffing device.

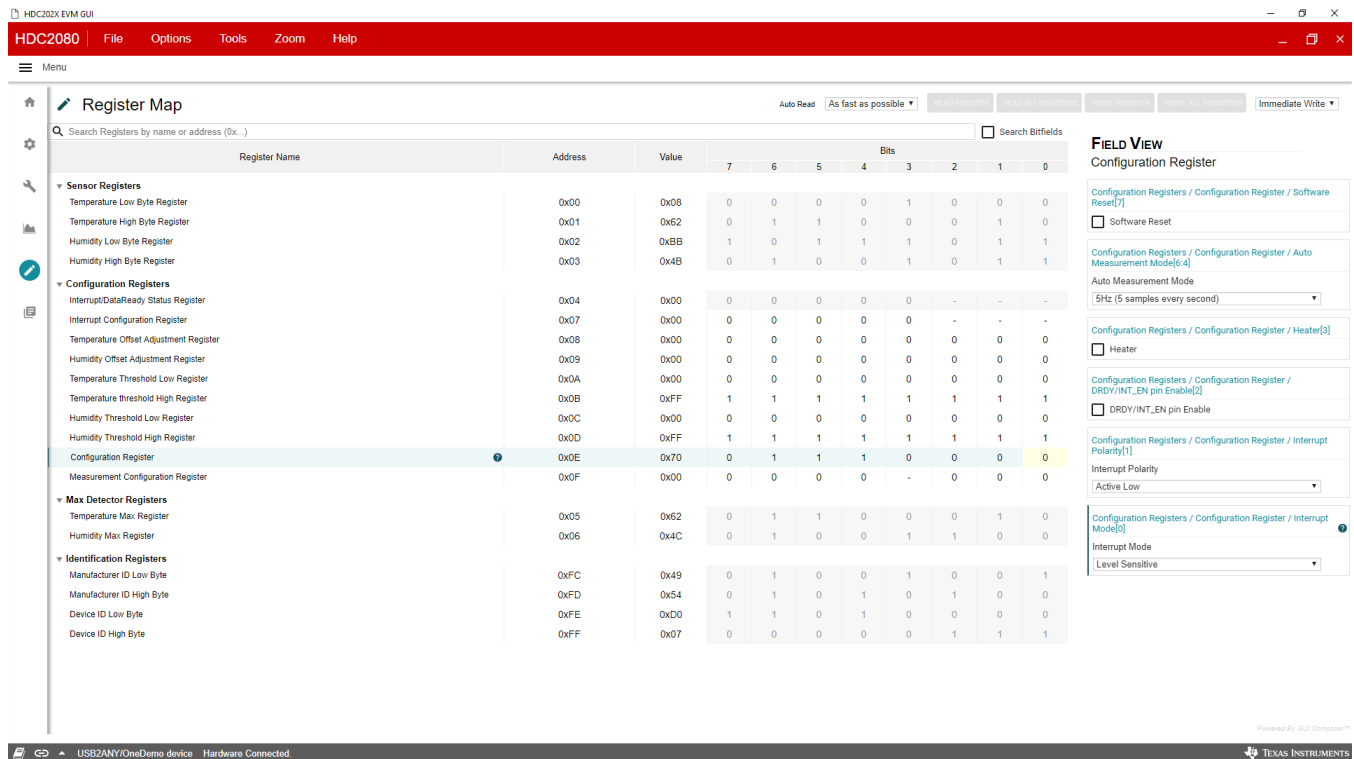

Figure 8. Register Tab of HDC2022EVM GUI

4.6 Collateral Tab

The Collateral tab contains links to articles, guides, reports, and videos which are relevant to the HDC2022 device. This includes the device datasheet and EVM User's Guide.

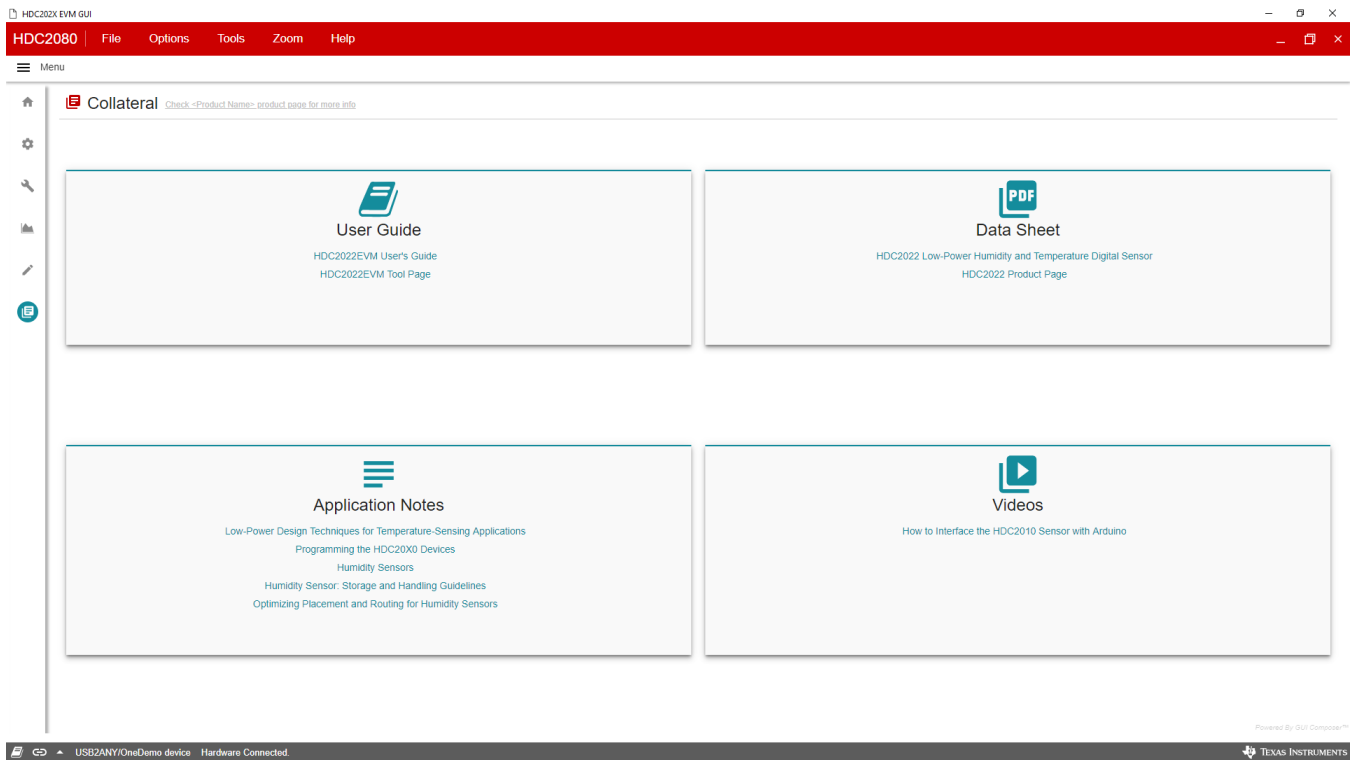

Figure 9. Collateral Tab of HDC2022EVM GUI

5 EVM Hardware

This section describes the connectors on the EVM and how to properly connect, setup and use the HDC2022EVM.

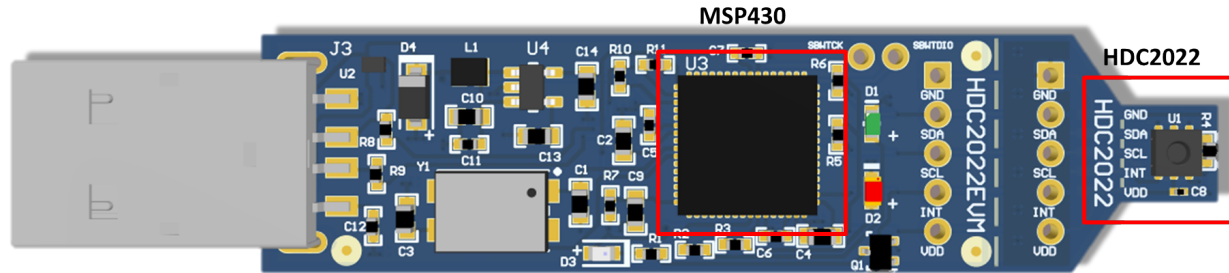

Figure 10. HDC2022EVM

5.1 Input/Output Connector Description

5.1.1 J1 & J2 – 5x1 Headers

These headers are not populated and can be installed if the EVM is broken in two sections: PC interface and Sensor. J1 and J2 allow for communication of the two sections using a 5-wire cable. The plated through-holes may also be used as a point to probe these signals during EVM operation.

Jx.1	GND
Jx.2	SDA
Jx.3	SCL
Jx.4	INT
Jx.5	VDD

5.1.2 USB Type A Connector

This connector is used for communications with the PC and provides power for the EVM.

5.2 EVM Operating Conditions

The HDC2022EVM power is supplied via the USB connector. The LDO (U4) converts the 5V from the USB to 3.3V used by the HDC2022 and the MSP430. The EVM may be directly inserted into a USB port on a PC or laptop, or may be connected to the latter using the appropriate USB cable.

The controller and device sides of the EVM have different temperature limits as shown in [Table 2](#). These are set by the onboard MSP430F5528 and the HDC2022 ICs on the controller and breakout portions respectively.

Table 2. EVM Temperature Range

Board Section	Conditions	Temperature Range
Controller board	Recommended Operating T_j Range	-40 °C to 85 °C
	Absolute Maximum T_{stg}	-55 °C to 150 °C
HDC2022 breakout	Recommended Operating T_j Range	-20 °C to 70 °C
	Absolute Maximum T_{stg}	-65 °C to 150 °C

5.3 Device Address Configuration

The onboard HDC2022's I2C address is set to 1000001xb on the EVM. This is done by setting the ADDR pin to VDD via a 0 ohm resistor (R4) (refer to Figure 11).

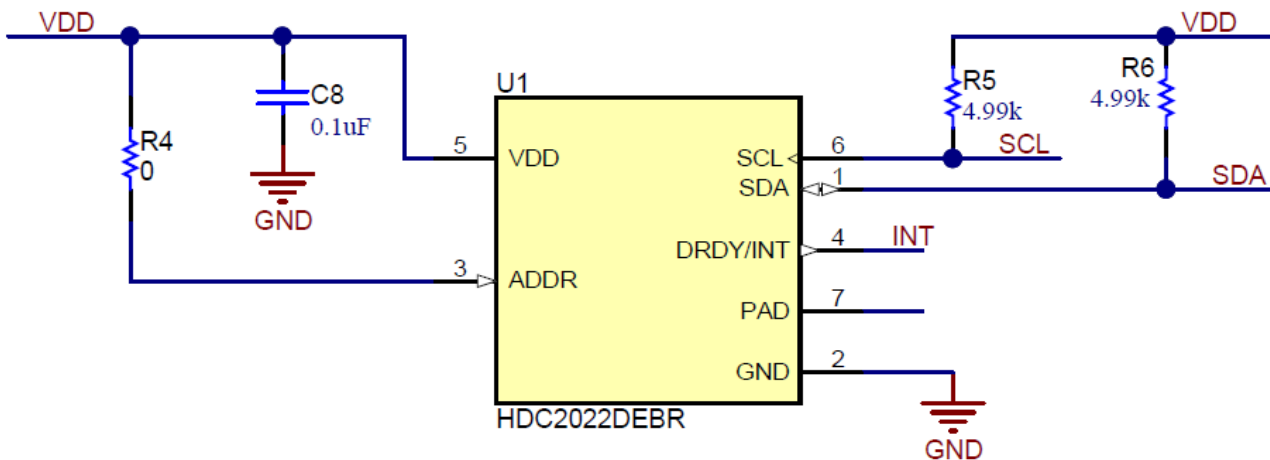

Figure 11. HDC2022EVM : Sensor Module

To change the I2C address to 0x40, remove 0 Ω resistor R4 (refer to Figure 12).

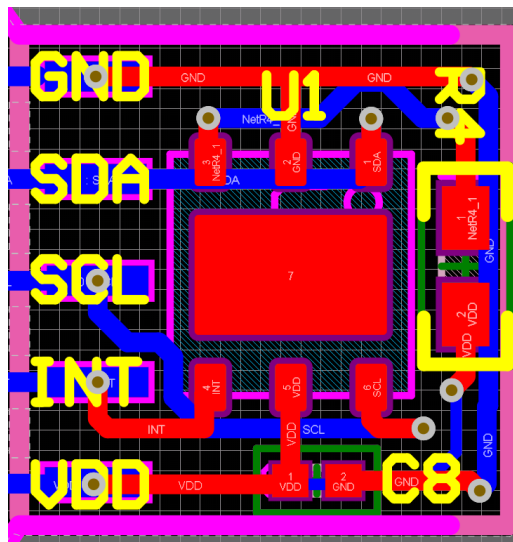

Figure 12. HDC2022EVM: Layout Resistors for I2C Address Setting - Top

Table 3. I2C Address

ADDR	R4	HDC2022 ADDRESS
VDD	Populated	1000001
Float	Removed	1000000

In Table 3, the EVM default configuration is in **bold**.

5.4 Reducing the Sensor's Thermal Mass

The HDC2022EVM can be broken into 2 sections to isolate the thermal mass of the μC from the HDC2022. [Figure 13](#) shows the board perforations that allow the two sections to be broken apart.

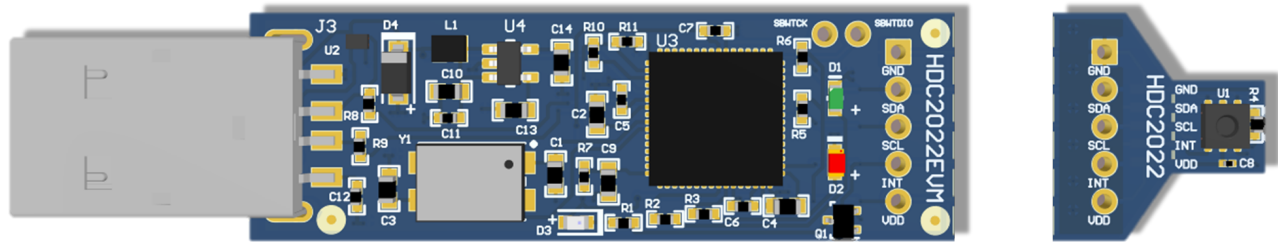

Figure 13. HDC2022EVM: PC Interface and Sensor Module

The communication between the two modules is ensured through the connector J1 and J2 and a 5-wire cable. In this configuration the thermal mass of the EVM is dramatically reduced, improving the temperature measurements performances of the HDC2022. The cable connecting J1 to J2 must conform to I2C cable length constraints. When used in this configuration, the GUI can still be used to communicate with the EVM and collect data.

If the thermal mass of the sensor section is still excessive, the sensor section can be reduced by breaking it at the perforation shown in [Figure 14](#). The PCB segment that hosts the HDC2022 is 5.5mm x 5mm.

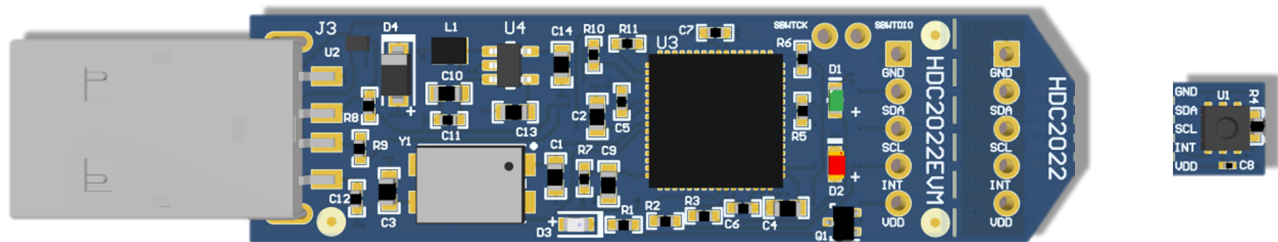

Figure 14. HDC2022EVM: PC Interface and Smaller Sensor Module

Also in the case where the EVM is broken into two sections it is still possible to use the GUI (ensuring the connections between the modules) or alternatively it is possible to connect the sensor module to a custom micro-controller. (Refer to [Figure 15](#)).

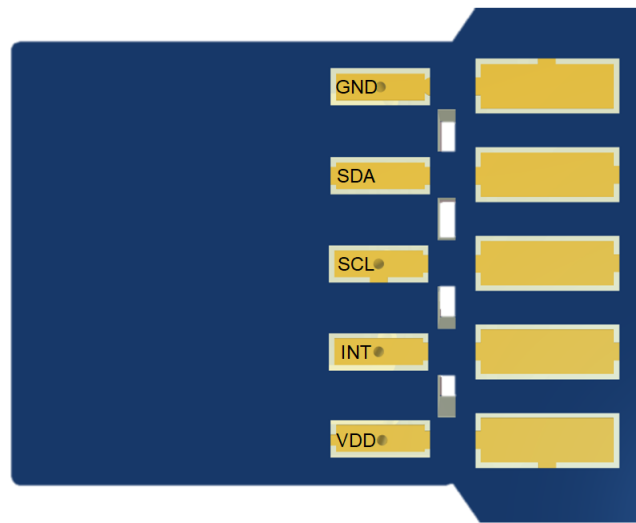

Figure 15. HDC2022EVM: Pads for I2C and Supply of the Smaller Sensor Module

6 Updating Firmware on HDC2022EVM

By default the HDC2022EVM will come programmed with the correct firmware for operation, the instructions in this section provide guidance on how to reflash the firmware in the event an upgrade is required, or if the board firmware has become corrupted because of misuse.

The primary method for flashing the HDC2022EVM is Spy-Bi-Wire. In order to reflash the firmware you will need the following:

- PC
- HDC2022EVM to be flashed
- [MSP-EXP430F5529LP](#) and included USB connection cable
- 3 x Male to Female Jumper Cables
- UniFlash (Offline or Cloud Version)
 - Install Offline version from: <http://www.ti.com/tool/UNIFLASH>
 - Cloud version is accessible here: <http://dev.ti.com/gallery/>

To update the firmware on the HDC2022EVM complete the procedure below:

1. Plug in the HDC2022EVM to the PC via USB Connector to provide power to the EVM.
2. Connect another USB cable to the MSP-EXP430F5529LP
3. Remove the SBW RST and SBW TST Jumpers on the MSP-EXP430F5529LP board
4. Create a wiring harness by connecting jumpers to SBW RST, SBW TST, and GND on the MSP-EXP430F5529LP.
5. Insert the male end of the jumpers through the SBWTCK, SBWTDIO, and GND through holes on the HDC2022EVM. These are shown in [Figure 16](#). Make these connections as follows:
 - SBW RST ↔ SBWTDIO
 - SBW TST ↔ SBWTCK
 - GND ↔ GND

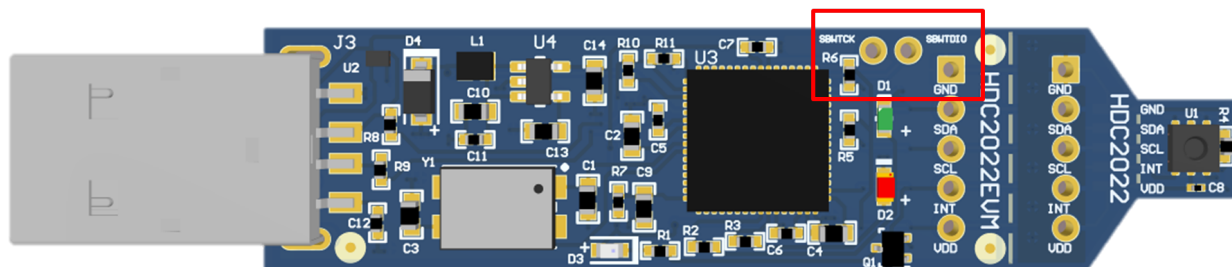

Figure 16. HDC2022EVM Spy-Bi-Wire programming connections

6. Open UniFlash.
7. Select MSP430F5528 as the target, select your connection and click *Start*

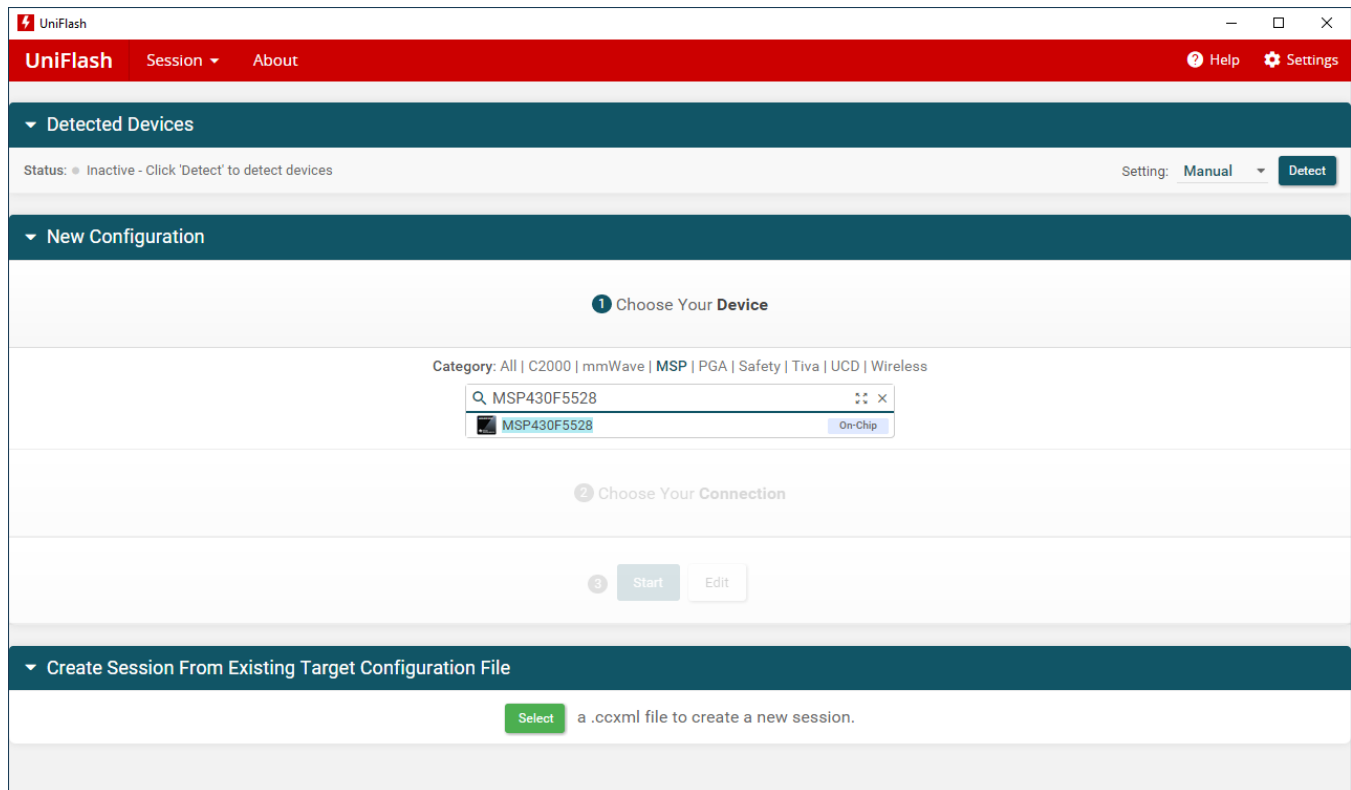

Figure 17. UniFlash Launch Screen, MSP430F5528 device selected.

8. Browse to the firmware file named *USB2ANY-F5528-24MHZ.txt* and select *Load Image*. Upon successful programming, the firmware image will be loaded and the HDC2022EVM will automatically restart. The HDC2022EVM firmware upgrade is then complete.

7 Board Layout

Figure 18 and Figure 19 show the board layout for the HDC2022EVM.

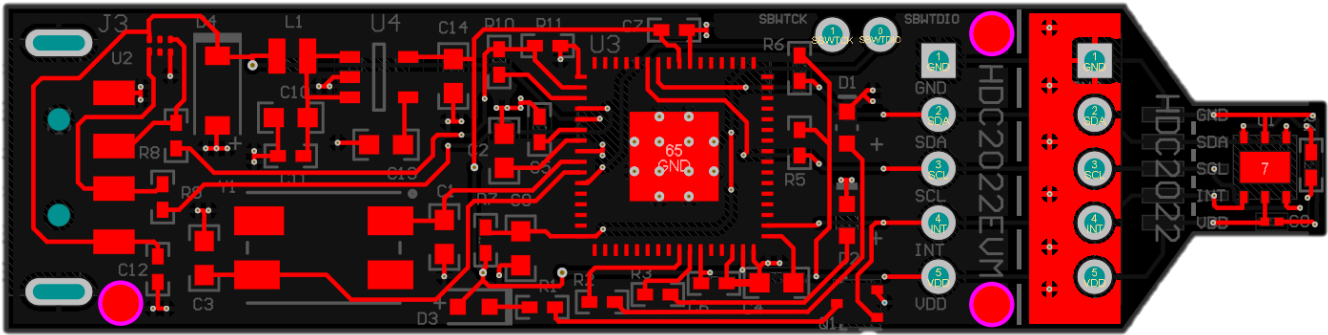

Figure 18. Top Layer Routing

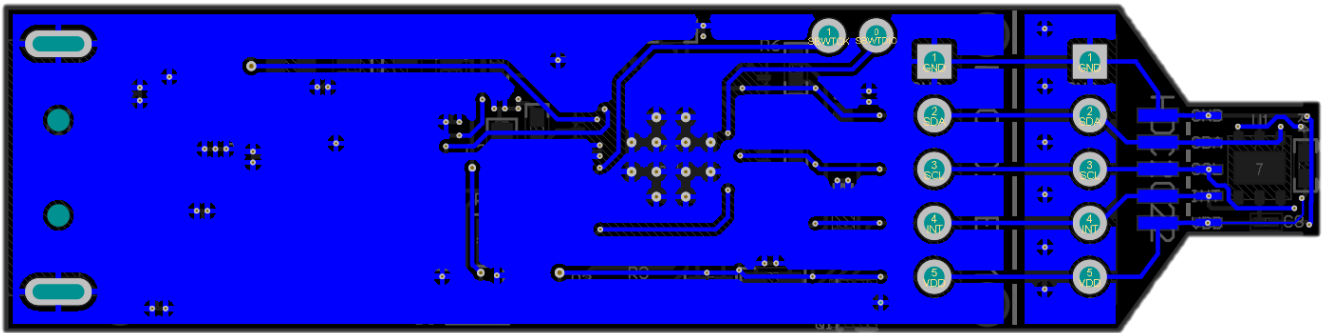

Figure 19. Bottom Layer Routing

8 Schematic

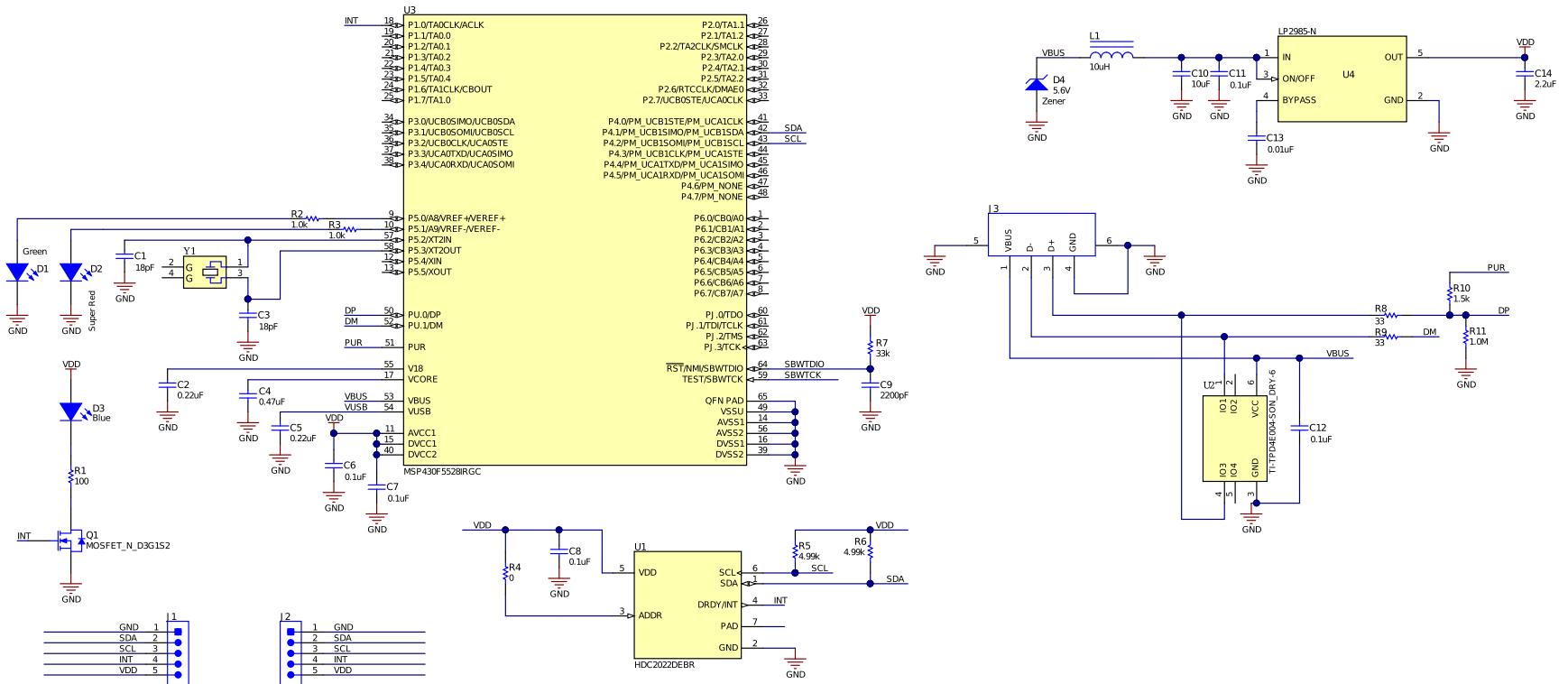

Figure 20. HDC2022EVM Schematic

9 HDC2022EVM Bill of Materials

REF DES	QTY	DESCRIPTION	FOOTPRINT	PART NUMBER
C1, C3	2	CAP, CERM, 18 pF, 50 V, +/- 5%, C0G/NP0, 0603	0603	C0603C180J5GACTU
C2	1	CAP, CERM, 0.22 uF, 25 V, +/- 10%, X5R, 0603	0603	06033D224KAT2A
C4	1	CAP, CERM, 0.47 uF, 10 V, +/- 10%, X7R, 0603	0603	C0603C474K8RACTU
C5	1	CAP, CERM, 0.22 uF, 16 V, +/- 10%, X7R, 0402	0402	GRM155R71C224KA12D
C6, C7, C11, C12	4	CAP, CERM, 0.1 uF, 16 V, +/- 10%, X7R, 0402	0402	0402YC104KAT2A
C8	1	CAP, CERM, 0.1 uF, 10 V, +/- 10%, X5R, 0201	0201	CL03A104KP3NNNC
C9	1	CAP, CERM, 2200 pF, 50 V, +/- 10%, X7R, 0603	0603	C0603X222K5RACTU
C10	1	CAP, CERM, 10 uF, 10 V, +/- 20%, X5R, 0603	0603	C1608X5R1A106M080AC
C13	1	CAP, CERM, 0.01 uF, 50 V, +/- 5%, C0G/NP0, 0603	0603	C1608NP01H103J080AA
C14	1	CAP, CERM, 2.2 uF, 10 V, +/- 10%, X5R, 0603	0603	C0603C225K8PACTU
D1	1	LED, Green, SMD	1.7x0.65x0.8mm	LG L29K-G2J1-24-Z
D2	1	LED, Super Red, SMD	LED, 1.6x.6x.8mm	SML-LX0603SRW-TR
D3	1	LED, Blue, SMD	1.6x0.8mm	LTST-C193TBKT-5A
D4	1	Diode, Zener, 5.6 V, 500 mW, SOD-123	SOD-123	MMSZ5232B-7-F
J3	1	Connector, Plug, USB Type A, R/A, Top Mount SMT	Edge mount USB A CONN	48037-2200
L1	1	Inductor, Shielded, Ferrite, 10 uH, 0.45 A, 1.33 ohm, SMD	Inductor, 2x1x1.6mm	IFSC0806AZER100M01
Q1	1	MOSFET, N-CH, 50 V, 0.2 A, SOT-323	SOT-323	BSS138W-7-F
R1	1	RES, 100, 5%, 0.063 W, AEC-Q200 Grade 0, 0402	0402	CRCW0402100RJNED
R2, R3	2	RES, 1.0 k, 5%, 0.063 W, AEC-Q200 Grade 0, 0402	0402	CRCW04021K00JNED
R4	1	RES, 0, 5%, 0.1 W, AEC-Q200 Grade 0, 0402	0402	ERJ-2GE0R00X
R5, R6	2	RES, 4.99 k, 1%, 0.063 W, AEC-Q200 Grade 0, 0402	0402	CRCW04024K99FKED
R7	1	RES, 33 k, 5%, 0.063 W, AEC-Q200 Grade 0, 0402	0402	CRCW040233K0JNED
R8, R9	2	RES, 33, 5%, 0.063 W, AEC-Q200 Grade 0, 0402	0402	CRCW040233R0JNED
R10	1	RES, 1.5 k, 5%, 0.063 W, AEC-Q200 Grade 0, 0402	0402	CRCW04021K50JNED
R11	1	RES, 1.0 M, 5%, 0.063 W, AEC-Q200 Grade 0, 0402	0402	CRCW04021M00JNED
U1	1	Low Power Humidity and Temperature Digital Sensor, DEB0006A (WSON-6)	DEB0006A	HDC2022DEBR
U2	1	4-Channel ESD Protection Array for High-Speed Data Interfaces, DRY0006A (USON-6)	DRY0006A	TPD4E004DRYR
U3	1	16-Bit Ultra-Low-Power Microcontroller, 128KB Flash, 8KB RAM, USB, 12Bit ADC, 2 USCs, 32Bit HW MPY, RGC0064B (VQFN-64)	RGC0064B	MSP430F5528IRGCR
U4	1	Micropower 150-mA Low-Noise Ultra-Low-Dropout Regulator in SOT-23 and DSBGA Packages, DBV0005A (SOT-23-5)	DBV0005A	LP2985AIM5-3.3/NOPB
Y1	1	Crystal, 24.000 MHz, 18pF, SMD	Xtal, 7.2x1.3x5.2mm	ABMM-24.000MHZ-B2-T
FID1, FID2, FID3	0	Fiducial mark. There is nothing to buy or mount.	N/A	N/A
J1, J2	0	Header, 100mil, 5x1, Gold, TH	5x1 Header	TSW-105-07-G-S

IMPORTANT NOTICE AND DISCLAIMER

TI PROVIDES TECHNICAL AND RELIABILITY DATA (INCLUDING DATA SHEETS), DESIGN RESOURCES (INCLUDING REFERENCE DESIGNS), APPLICATION OR OTHER DESIGN ADVICE, WEB TOOLS, SAFETY INFORMATION, AND OTHER RESOURCES "AS IS" AND WITH ALL FAULTS, AND DISCLAIMS ALL WARRANTIES, EXPRESS AND IMPLIED, INCLUDING WITHOUT LIMITATION ANY IMPLIED WARRANTIES OF MERCHANTABILITY, FITNESS FOR A PARTICULAR PURPOSE OR NON-INFRINGEMENT OF THIRD PARTY INTELLECTUAL PROPERTY RIGHTS.

These resources are intended for skilled developers designing with TI products. You are solely responsible for (1) selecting the appropriate TI products for your application, (2) designing, validating and testing your application, and (3) ensuring your application meets applicable standards, and any other safety, security, regulatory or other requirements.

These resources are subject to change without notice. TI grants you permission to use these resources only for development of an application that uses the TI products described in the resource. Other reproduction and display of these resources is prohibited. No license is granted to any other TI intellectual property right or to any third party intellectual property right. TI disclaims responsibility for, and you will fully indemnify TI and its representatives against, any claims, damages, costs, losses, and liabilities arising out of your use of these resources.

TI's products are provided subject to [TI's Terms of Sale](#) or other applicable terms available either on ti.com or provided in conjunction with such TI products. TI's provision of these resources does not expand or otherwise alter TI's applicable warranties or warranty disclaimers for TI products.

TI objects to and rejects any additional or different terms you may have proposed.

Mailing Address: Texas Instruments, Post Office Box 655303, Dallas, Texas 75265
Copyright © 2022, Texas Instruments Incorporated