

# SD387EVK

## LMH0387 Evaluation Board

### User Guide

National Semiconductor  
EVK User Manual

April 29, 2010



## Overview

The SD387 Evaluation Kit (EVK) enables evaluation of the LMH0387 3G/HD/SD SDI Configurable I/O Adaptive Cable Equalizer / Cable Driver. A graphical user interface allows managing the SPI registers for the input mode (equalizer), and can also be used to control the device's I/O mode.

## Evaluation Kit (SD387EVK) Contents

The EVK contains the following parts:

- SD387EVK board assembly with the LMH0387 configurable I/O
- SPA dongle (SPI→USB card)
- USB cable
- 6-pin parallel cable
- SD387EVK User Guide

## Evaluation Board Description

Figure 1 shows the SD387 evaluation board and highlights some of its features.

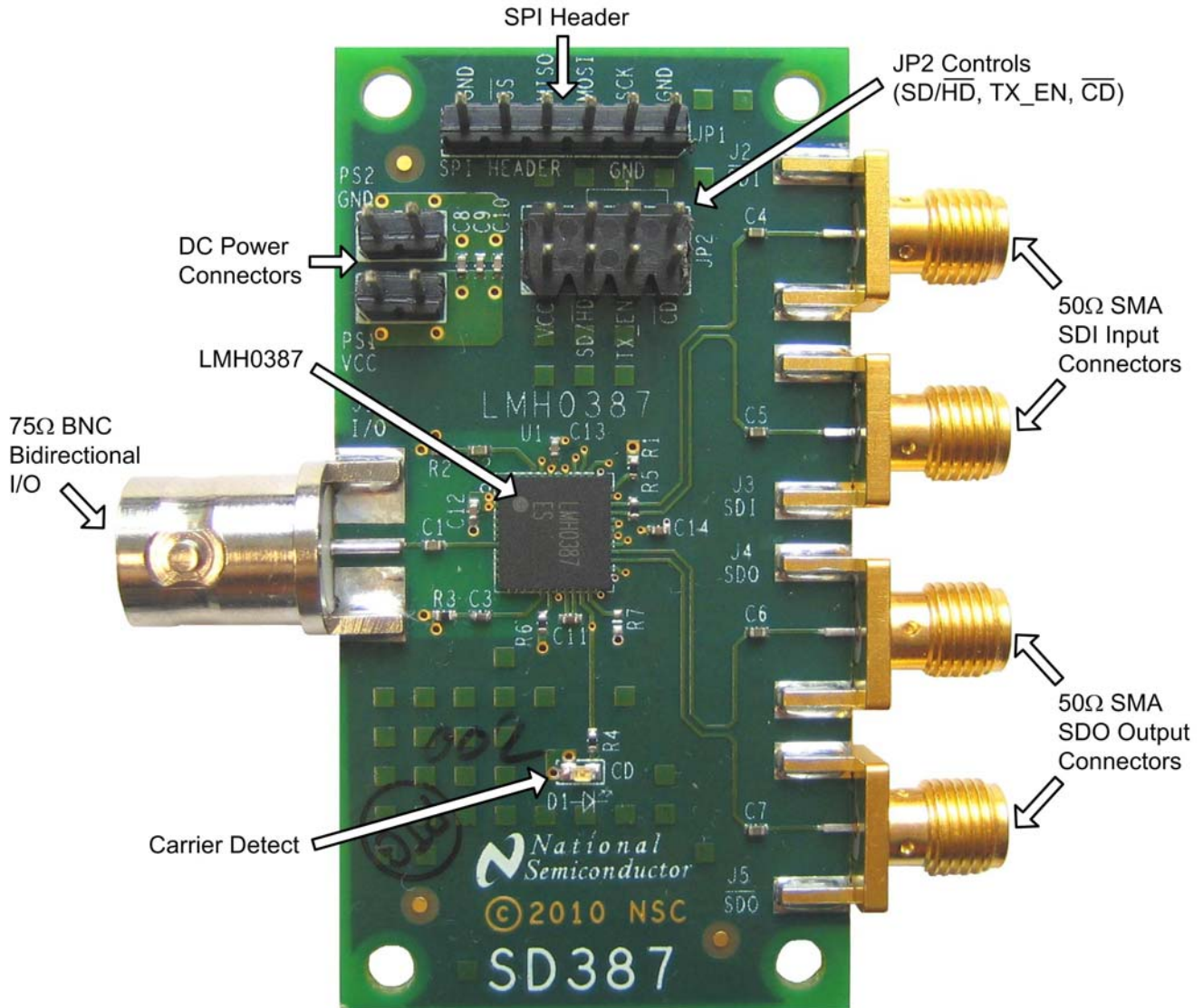

**FIGURE 1. SD387 Evaluation Board**

### Inputs and Outputs: BNC\_IO Input/Output, SDI Input, and SDO Output

The bidirectional I/O (J1) is a 75Ω BNC connector. When the LMH0387 is configured as an input, the input signal on the BNC\_IO pin should conform to the SMPTE 424M, SMPTE 292M, or SMPTE 259M standards. When the LMH0387 is configured as an output, the BNC\_IO pin will drive SMPTE SDI signal levels (800 mV<sub>P-P</sub> into 75Ω).

The SDI input connectors (J2 and J3) are 50Ω SMA connectors. This cable driver input includes a 100Ω differential termination resistor (R5) at the LMH0387 device and is optimized for 100Ω differential input.

The SDO output connectors (J4 and J5) are 50Ω SMA connectors. When using only one side of this equalizer output pair, the other side should be terminated with a 50Ω SMA termination. For example, when only using the SDO output,  $\overline{SDO}$  should be terminated with a 50Ω SMA termination.

## DC Power Connectors

The VCC and GND power connectors should be powered with a DC input voltage of 3.3V ± 5% (3.6V maximum).

## JP2 Controls

### $\overline{CD}$

JP2 allows monitoring of the Carrier Detect ( $\overline{CD}$ ) at the BNC\_IO pin while in the input mode (equalizer).  $\overline{CD}$  is asserted low when an input signal is detected at the BNC\_IO pin, and high when no input signal is present.

### TX\_EN

JP2 allows control of the TX\_EN pin to enable or disable the cable driver. The LMH0387 TX\_EN pin has an internal pullup to enable the cable driver by default, so this pin may be left unconnected when using the LMH0387 in the output mode. To disable the cable driver, place a jumper to tie TX\_EN to GND. When using the LMH0387 in the input mode, the cable driver must be disabled by tying TX\_EN low. TX\_EN may optionally be controlled via the GUI using the SPA dongle as described below.

### SD/ $\overline{HD}$

JP2 allows control of the SD/ $\overline{HD}$  pin for setting the slew rate for the BNC\_IO pin while the LMH0387 is in the output mode (cable driver). This pin may be connected to GND for the faster HD/3G slew rate or connected to V<sub>CC</sub> for the slower SD slew rate. The LMH0387 SD/ $\overline{HD}$  pin has an internal pulldown to enable the HD/3G slew rate by default.

## SPI Header (JP1)

JP1 is the SPI (Serial Peripheral Interface) header. It allows access to the SPI pins ( $\overline{SS}$ , MISO, MOSI, and SCK) to control the SPI registers of the LMH0387 equalizer. To use the SPI interactive GUI, plug the 6-pin parallel cable between this header and JP7 on the SPA dongle to connect the pins one-for-one as shown in Table 1. The SPA dongle requires special software and must be connected to the PC via the USB – see the Software Setup section.

**TABLE 1. SPI Connections between SD387 and SPA Dongle**

SD387 JP1			SPA Dongle JP7	
Pin #	Name		Pin #	Name
1	GND	→	1	GND
2	SCK	→	2	MCK
3	MOSI	→	3	MOSI
4	MISO	→	4	MOSI
5	SS	→	5	SS
6	GND	→	6	GND

## Carrier Detect LED (D1)

D1 shows the status of Carrier Detect at the LMH0387 equalizer input. This LED is GREEN when an input signal has been detected at the BNC\_IO pin, and OFF when no input is detected.

## SPA Dongle Description

The SPA dongle is required to use the SPI interactive GUI. The SPA dongle connects between the LMH0387 SPI pins and the USB input of a PC. The SPA dongle is shown in Figure 2. JP7 is the SPI Header. The SPA dongle is powered through the USB, and the D1 LED is RED when the SPA dongle is connected to a PC via the USB to indicate the board is powered.

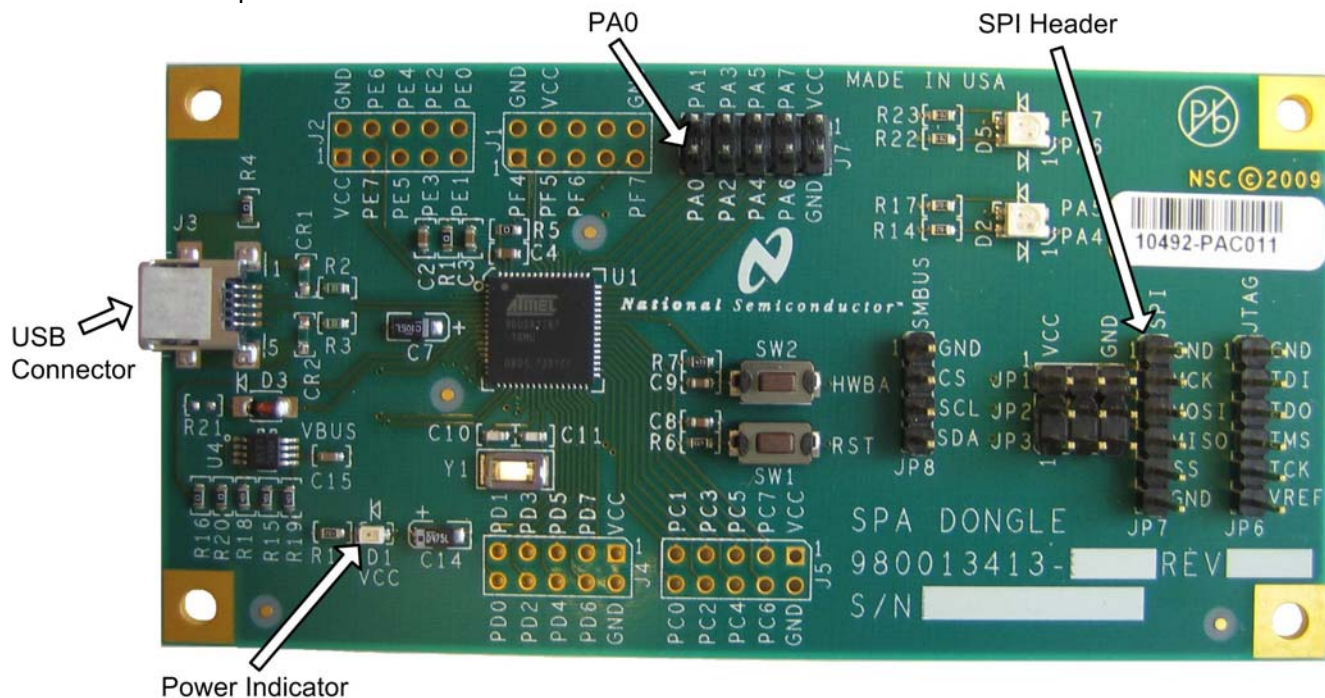

FIGURE 2. SPA Dongle

Figure 3 shows the connection between the SD387 and the SPA dongle. For proper operation, the SPI pins must be connected between the SD387 JP1 and the SPA dongle JP7. Optionally, a single wire may be connected between the SD387 TX\_EN pin (JP2) and the SPA dongle PA0 (J7) to enable software control of the LMH0387 cable driver enable functionality, and allow the GUI to fully control the LMH0387 I/O Mode as described on page 8. If this connection is not used, then the TX\_EN can be controlled manually with a jumper.

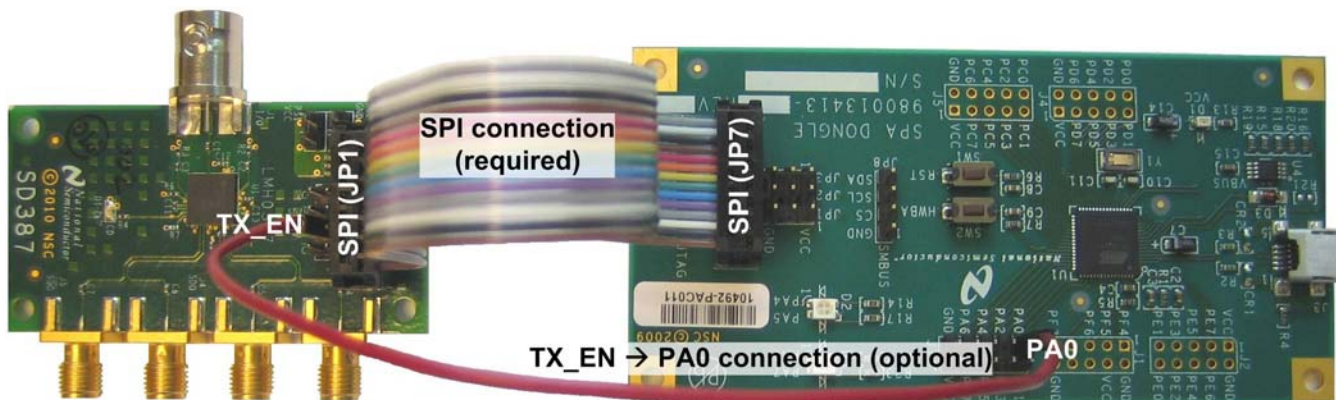

FIGURE 3. SD387 Connection to SPA Dongle

# Software Setup

## System Requirements

**Operating System:** Windows XP or Vista  
**USB:** 2.0

## Installation

Download the latest software from the LMH0387 Evaluation Board page. Extract the ALPF\_monthdayyear\_major version\_minor version.exe" (ex. ALPF\_04062010\_128\_0002.exe) file to a temporary location that can be deleted later.

Make sure the SPA dongle is not connected to the PC. The following installation instructions are for the Windows XP Operating System.

### Install the ALP software

Execute the ALP Setup Wizard program called "ALPF\_monthdayyear\_major version\_minor version.exe" (ex. ALPF\_04062010\_128\_0002.exe) that was extracted to a temporary location.

There are 7 steps to the installation once the setup wizard is started:

1. Select the "Next" button.
2. Select "I accept the agreement" and then select the "Next" button.
3. Select the location to install the ALP software and then select the "Next" button.
4. Select the location for the start menu shortcut and then select the "Next" button.
5. There will then be a screen that allows the creation of a desktop and Quick Launch icon. After selecting the desired choices select the "Next" button.
6. Select the "Install" button, and the software will then be installed to the selected location.
7. Uncheck "Launch Analog LaunchPAD" and select the "Finish" button. The ALP software will start if "Launch Analog LaunchPAD" is checked, but it will not be useful until the USB driver is installed.

Connect JP1 of the SD387 evaluation board to JP7 of the SPA dongle via the 6-pin parallel cable as shown in Table 1. Power on the SD387 evaluation board with a 3.3 VDC power supply. Connect the SPA dongle to the PC with the USB cable. The "Found New Hardware Wizard" will open on the PC. Proceed to the next section to install the USB driver.

### Install the USB driver

There are 6 steps to install the USB driver:

1. Select "No, not at this time" then select the "Next" button.
2. Select "Install from a list or specific location" then select the "Next" button.
3. Select "Search for the best driver in these locations". Uncheck "Search removable media" and check "Include this location in the search".
4. Browse to the Install Directory which is typically located at "C:\Program Files\National Semiconductor Corp\Analog LaunchPAD\vx.x.x\Drivers" and select the "Next" button. Windows should find the driver.
5. Select "Continue Anyway".
6. Select the "Finish" button.

The software installation is complete. The ALP software may now be launched, as described in the next section.

# Software Description

## Startup

Make sure all the software has been installed and the hardware is powered on and connected to the PC. Execute “Analog LaunchPAD” from the start menu. The default start menu location is “Programs\National Semiconductor Corp\Analog LaunchPAD vx.x.x\Analog LaunchPAD”.

The application should come up in the state shown in Figure 4 below. If it does not, see “Trouble Shooting” at the end of this document. Click on “LMH0387 – Nano” to select the device and open up the device profile and its associated tabs.

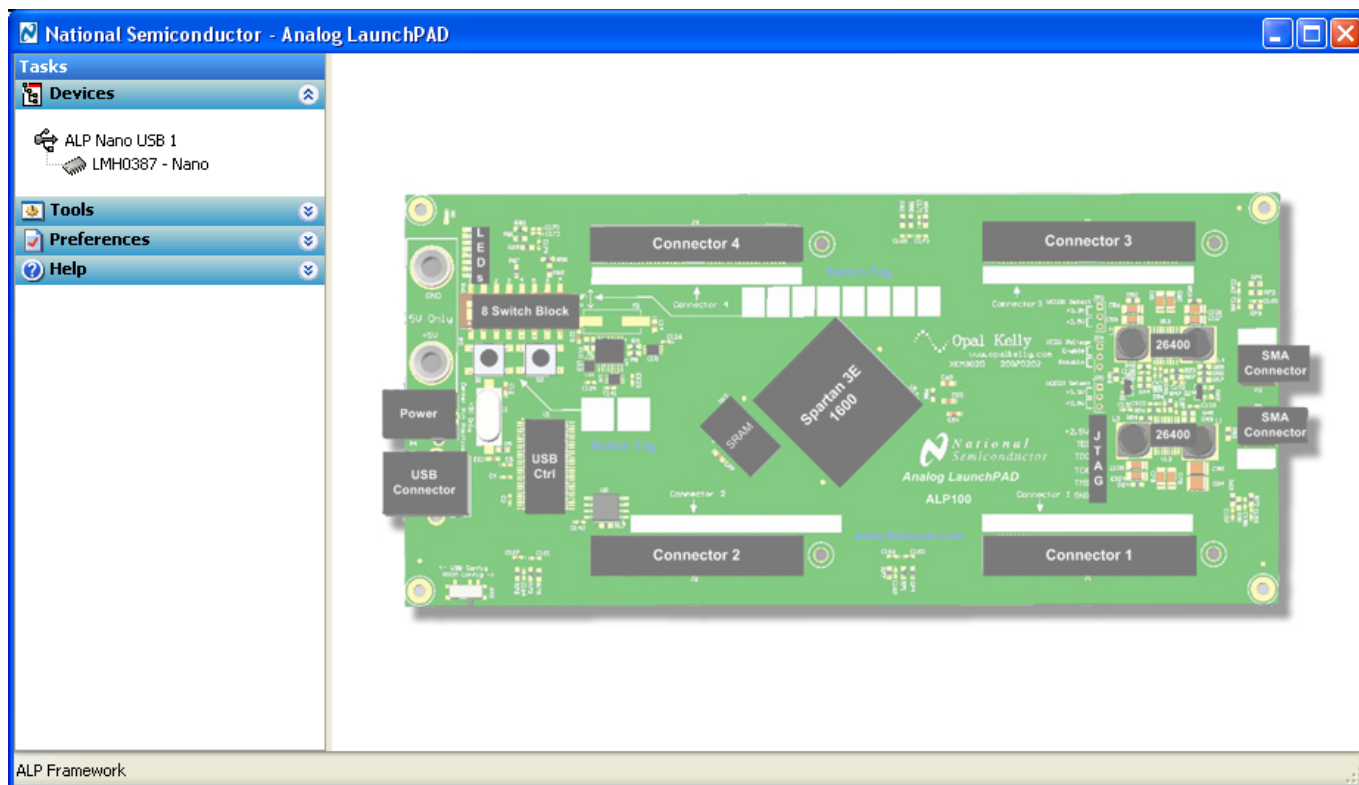

FIGURE 4. ALP Startup Screen for the LMH0387

## Information Tab

The Information tab is shown in Figure 5.

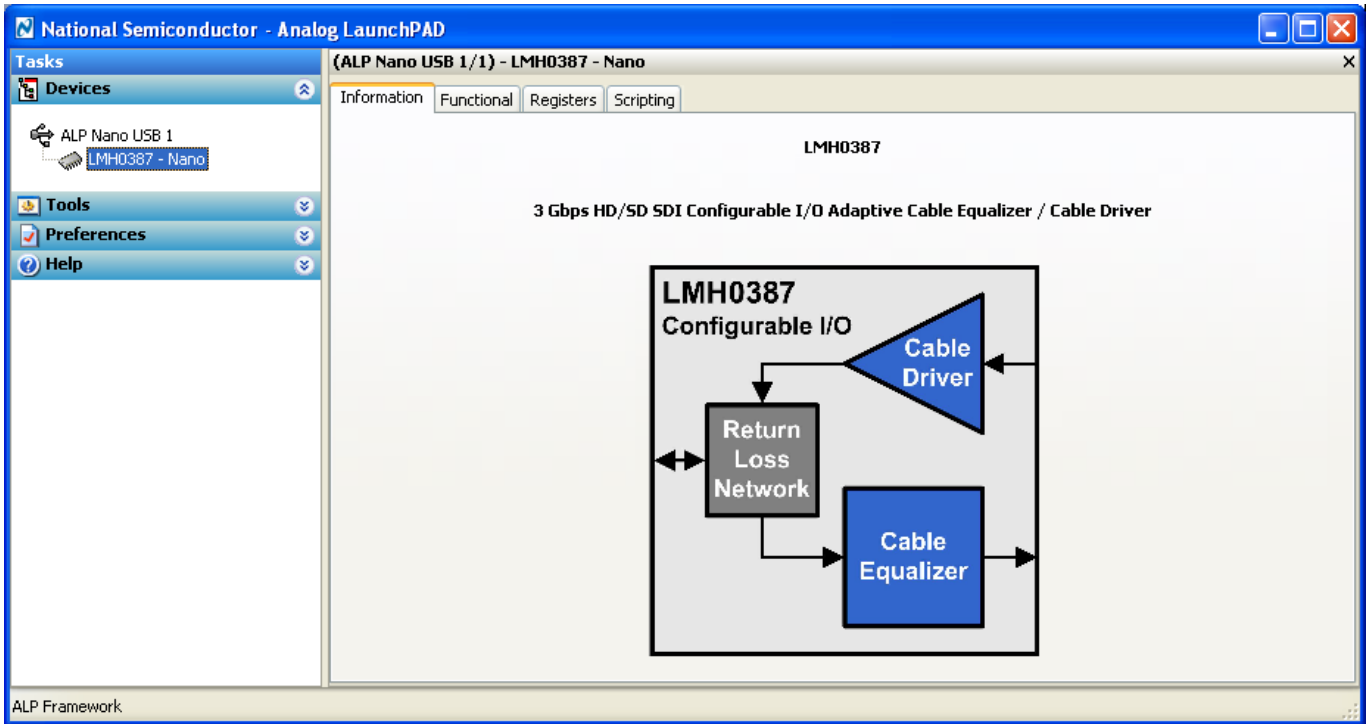

FIGURE 5. LMH0387 Information Tab

## Functional Tab

The Functional tab is the main tab of the GUI and presents a high level view of the LMH0387 equalizer, as shown in Figure 6.

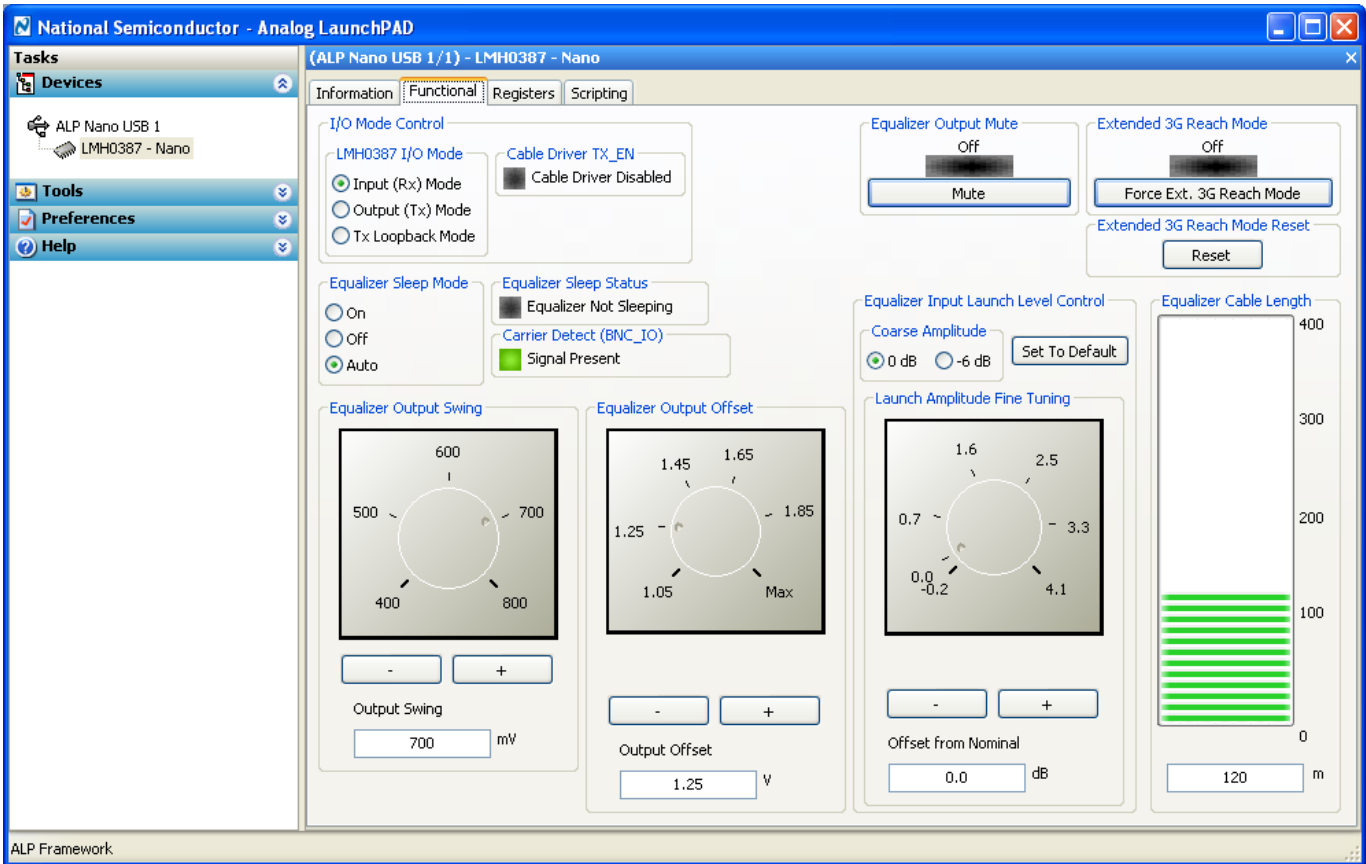
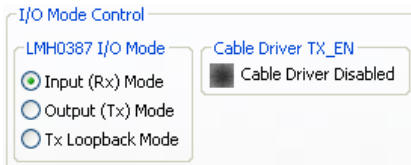

FIGURE 6. LMH0387 Functional Tab

## I/O Mode Control



The I/O Mode Control can be used to control the I/O Mode of the LMH0387, provided an additional wire is connected between the SD387 TX\_EN and the SPA dongle PA0, as shown in Figure 3. The connection between TX\_EN and PA0 allows software control of the LMH0387 cable driver enable functionality. If the SD387 TX\_EN is not connected to the SPA dongle PA0, then TX\_EN may be controlled manually with a jumper and the I/O Mode Control will have

no effect on the LMH0387 cable driver.

The default LMH0387 I/O Mode setting is the Input (Rx) Mode, or equalizer mode. This default setting allows full control of the LMH0387 equalizer. The three I/O modes are described below.

**Input (Rx) Mode:** Configures the LMH0387 for the input mode (equalizer enabled and cable driver disabled). This is the default setting. The LMH0387 equalizer is set to auto sleep, and if TX\_EN is connected to PA0, then PA0 will drive TX\_EN low to disable the LMH0387 cable driver. If this TX\_EN → PA0 connection is not made, then the LMH0387 cable driver should be manually disabled by setting a jumper to tie TX\_EN to GND.

**Output (Tx) Mode:** Configures the LMH0387 for the output mode (cable driver enabled and equalizer disabled). The LMH0387 equalizer is forced to sleep. If TX\_EN is connected to PA0, then PA0 will drive TX\_EN high to enable the LMH0387 cable driver. If this TX\_EN → PA0 connection is not made, then the LMH0387 cable driver should be manually enabled by pulling the jumper between TX\_EN and GND (TX\_EN should be open).



**Tx Loopback Mode:** Configures the LMH0387 for the output mode with a loopback path (cable driver and equalizer both enabled). The LMH0387 equalizer is set to auto sleep. If TX\_EN is connected to PA0, then PA0 will drive TX\_EN high to enable the LMH0387 cable driver. If this TX\_EN → PA0 connection is not made, then the LMH0387 cable driver should be manually enabled by pulling the jumper between TX\_EN and GND (TX\_EN should be open). In this mode, the cable driver output on the BNC\_IO pin is looped back to the LMH0387 equalizer outputs (SDO and  $\overline{\text{SDO}}$ ), so the cable driver output may be observed both at BNC\_IO pin and at the SDO/ $\overline{\text{SDO}}$  output pins.

The Cable Driver TX\_EN indicator shows the current status of the TX\_EN control (*only* if TX\_EN is connected to PA0). It is GREEN to indicate TX\_EN is driven high and the LMH0387 cable driver is enabled, or OFF to indicate TX\_EN is driven low and the LMH0387 cable driver is disabled.

### Equalizer Sleep Mode and Carrier Detect

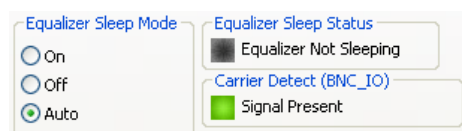

The Equalizer Sleep Mode control shows the status of the Sleep Mode register bits and allows control over the sleep mode. The Equalizer Sleep Mode settings are as follows:

**On:** Force the equalizer into sleep mode (powered down) regardless of whether there is an input signal or not.

**Off:** Disable sleep mode (force equalizer to stay enabled).

**Auto:** Sleep mode active when no input signal detected (default mode).

The Equalizer Sleep Status indicator shows the current sleep status of the equalizer. It is GREEN to indicate sleeping or OFF to indicate not sleeping.

The Carrier Detect shows the status of the BNC\_IO input carrier detect. It is GREEN to indicate the input signal is present or OFF to indicate the input signal is absent.

### Equalizer Output Swing

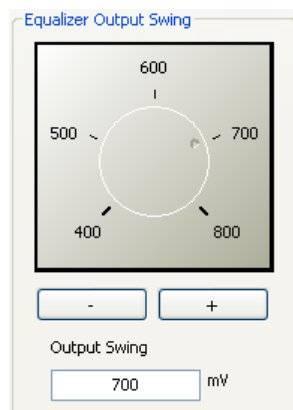

The Equalizer Output Swing control shows the current value of the LMH0387 equalizer output amplitude and allows adjustment in 100 mV increments from 400 mV<sub>P-P</sub> to 800 mV<sub>P-P</sub>. The default setting is 700 mV<sub>P-P</sub>. The Equalizer Output Swing may be set either by clicking on the “+” or “-” buttons, or by grabbing and spinning the “handle” on the knob for a quick adjustment.

### Equalizer Output Offset

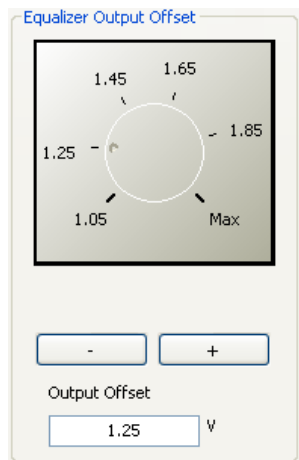

The Equalizer Output Offset control shows the current value of the LMH0387 equalizer output common mode voltage and allows adjustment in 200 mV increments from 1.05V to 1.85V. At the “Max” setting, the outputs are referenced to the positive supply and the output common mode is 2.1V. The default setting is 1.25V. The Equalizer Output Offset may be set either by clicking on the “+” or “-” buttons, or by grabbing and spinning the “handle” on the knob for a quick adjustment.

### Equalizer Output Mute

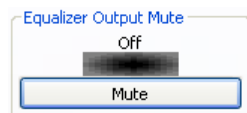

The Equalizer Output Mute indicator shows the mute status, and the button may be used to toggle the mute function. The indicator is GREEN to indicate mute (equalizer outputs are muted) and OFF to indicate normal mode (outputs are not muted).

### Extended 3G Reach Mode

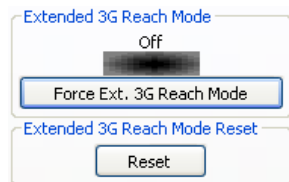

The Extended 3G Reach Mode indicator shows the status of the Extended 3G Reach Mode register bit, and the button may be used to toggle this register bit. The indicator is GREEN when the bit is set for extended 3G reach mode, and OFF when the equalizer is set for normal mode. Note that the indicator shows the status of the register bit – not whether the device is actually in extended 3G reach mode or not. If extended 3G reach mode is set, the equalizer will remain in this mode until the input cable is physically changed or power is cycled. For example, extended 3G reach mode is forced, and then it is turned off. The indicator will show it is off, but the equalizer will still be in extended 3G reach mode until the input cable is changed or the device power is cycled. The GUI provides a simple way to reset the extended 3G reach mode: the Extended 3G Reach Mode Reset button. This button toggles the equalizer sleep mode, and has a similar effect to removing and re-applying the input cable.

## Equalizer Input Launch Level Control

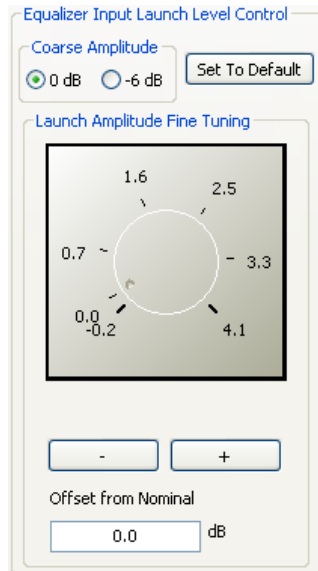

*Note: The GUI automatically sets the nominal equalizer launch amplitude setting upon startup (specifically, it writes 30h to SPI register 02h). This nominal setting is required for correct equalizer operation with the default SMPTE 800 mV<sub>P-P</sub> launch amplitude and no external attenuation. If the equalizer launch amplitude setting is changed, it can be instantly set back to this nominal setting by clicking the “Set To Default” button.*

The Equalizer Input Launch Level Control is useful to compensate for attenuation of the input signal prior to the equalizer due to a passive splitter or non-ideal input termination network.

The Coarse Amplitude control shows the current setting of the Coarse Control register and may be used to set the input for either 0 dB (default) or 6 dB of input attenuation. At the default setting of 0 dB, the equalizer operates normally and expects a launch amplitude of 800 mV<sub>P-P</sub>. With the Coarse Amplitude set to -6 dB, the equalizer is optimized for input signals with 6 dB of input attenuation (400 mV<sub>P-P</sub>).

The Launch Amplitude Fine Tuning may be used to further fine tune the equalizer input compensation, from -0.2 dB to 4.1 dB. The Launch Amplitude Fine Tuning may be set either by clicking on the “+” or “-” buttons, or by grabbing and spinning the

“handle” on the knob for a quick adjustment.

## Equalizer Cable Length

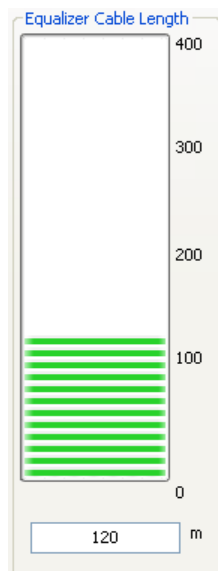

The Equalizer Cable Length shows the interpreted Belden 1694A cable length of the CLI register, both with a visual bar graph and a decimal readout. The Equalizer Cable Length is only valid when an input signal is detected, and is greyed out when there is no input to the LMH0387 equalizer.

## Registers Tab

The Registers tab displays all registers for the LMH0387 equalizer. Figure 7 shows the Registers tab. The Value field indicates the value of the currently selected register.

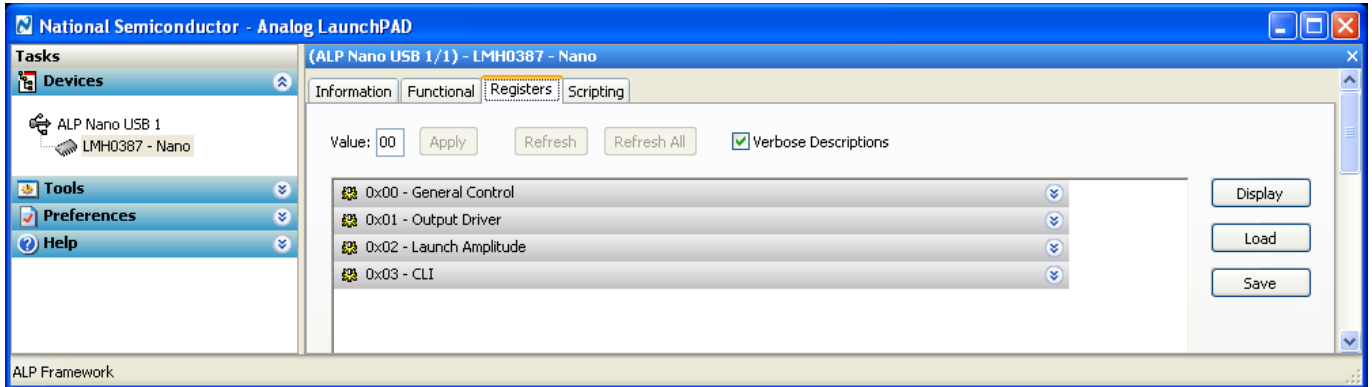

**FIGURE 7. LMH0387 Registers Tab**

Each register can be examined in detail by either double clicking on the desired registers fold bar (with the address and the register name, e.g. 0x00 – General Control) or by single clicking the icon at the right of the fold bar (two inverted carats).

The Refresh button will re-read the currently selected register and the Refresh All will read all registers in the device. Changes may be made to the registers by checking or un-checking the individual register bits or typing in a new register value in the Value field. After setting the appropriate register value, the Apply button must be pressed to apply the changes. The detailed view of the General Control register is shown in Figure 8 with Verbose Descriptions checked and Figure 9 with Verbose Descriptions un-checked.

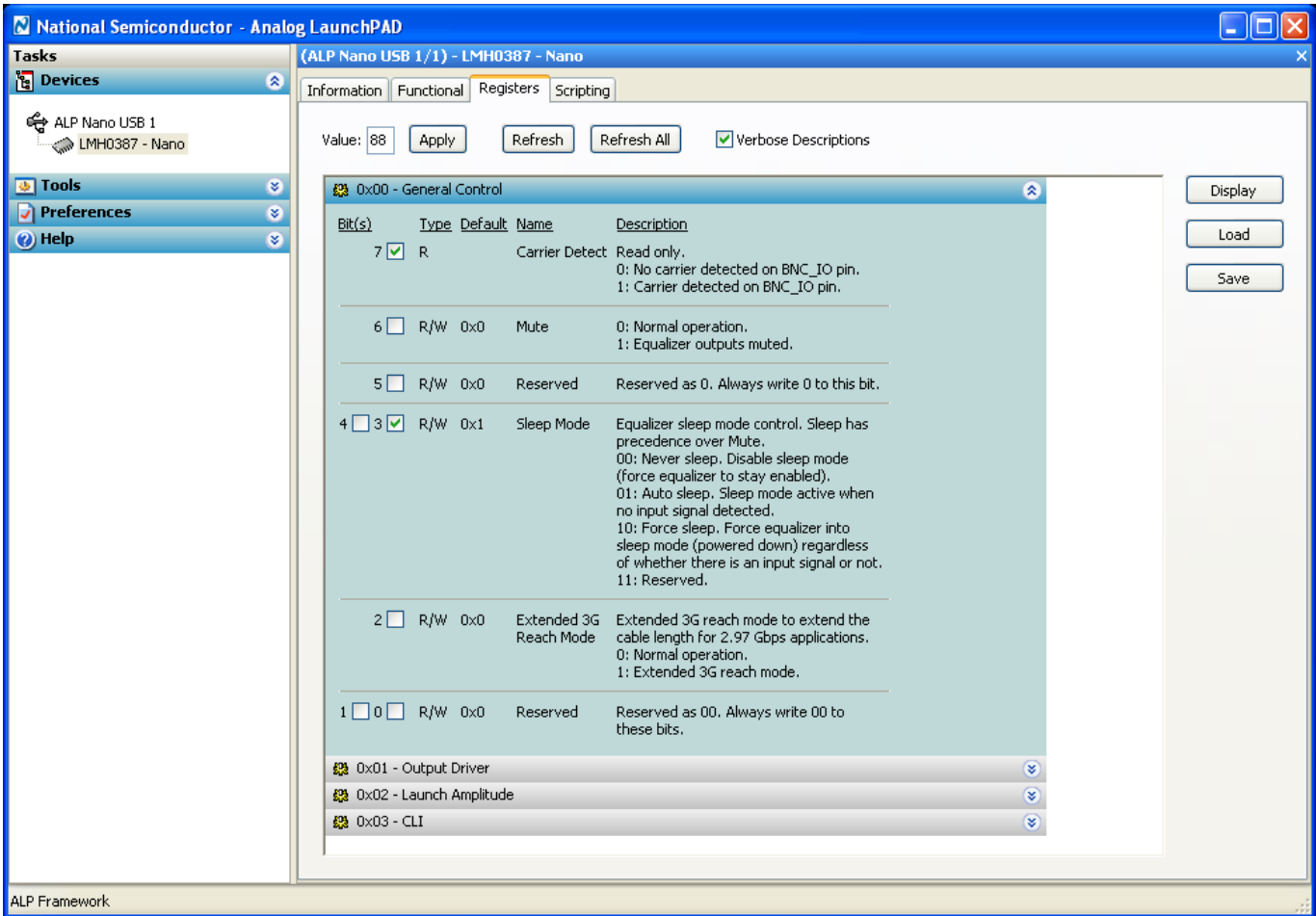

FIGURE 8. LMH0387 Registers Tab with Verbose Descriptions

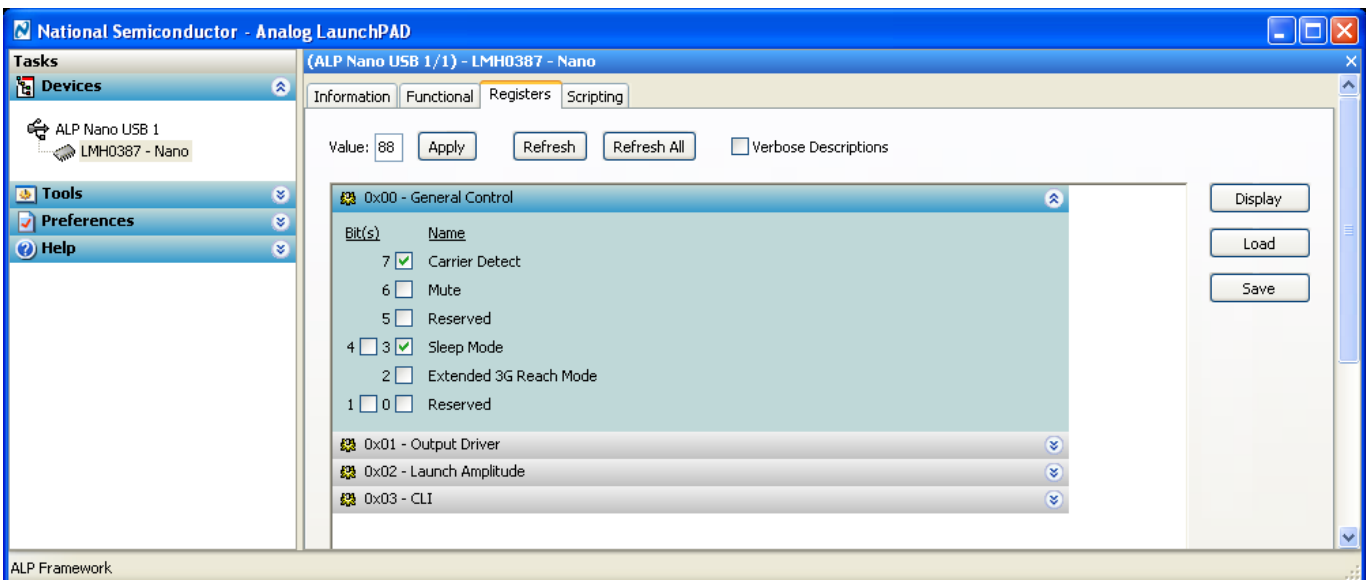
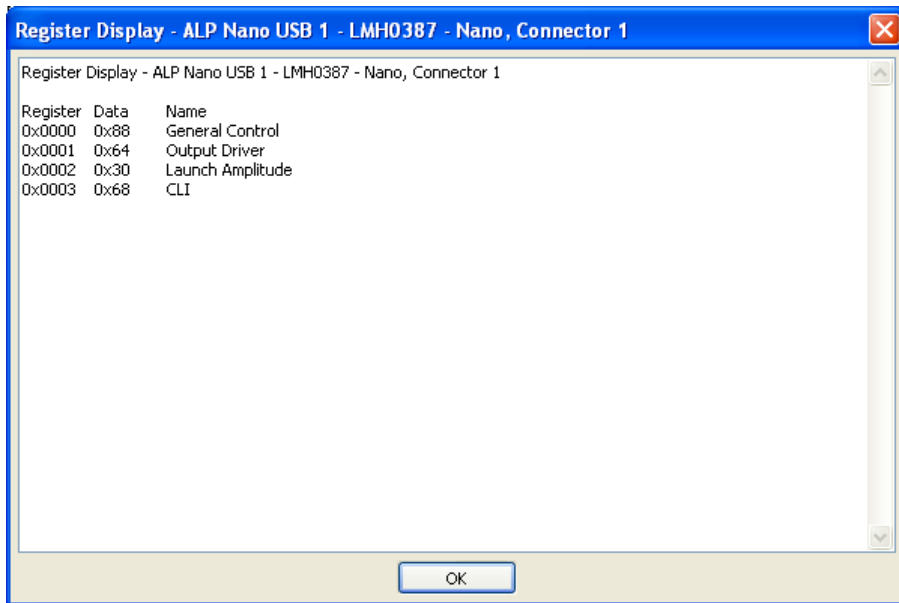

FIGURE 9. LMH0387 Registers Tab without Verbose Descriptions

The Display button provides another view of the register set and is depicted in Figure 10. The Display dialog supports the Windows copy command (Ctrl+c).



**FIGURE 10. LMH0387 Register Display**

The Load and Save buttons provide a handy mechanism for restoring or saving the register set external to the evaluation board.

# Typical Performance

## Cable Driver Output

Figure 11 shows the typical output waveform from the LMH0387 cable driver at 2.97 Gbps. The input signal is a 2.97 Gbps PRBS10 from the Agilent 86130A BERT. The input is connected differentially to the SDI SMA inputs on the SD387 with matched 3' SMA cables. The LMH0387 cable driver slew rate is set for HD/3G mode ( $SD/H\bar{D} = 0$ ). The SD387 BNC\_IO output is connected through 1m of Belden 1694A cable to the TCA75 75Ω input module on the Tektronix DSA7125 12.5 GHz Oscilloscope.

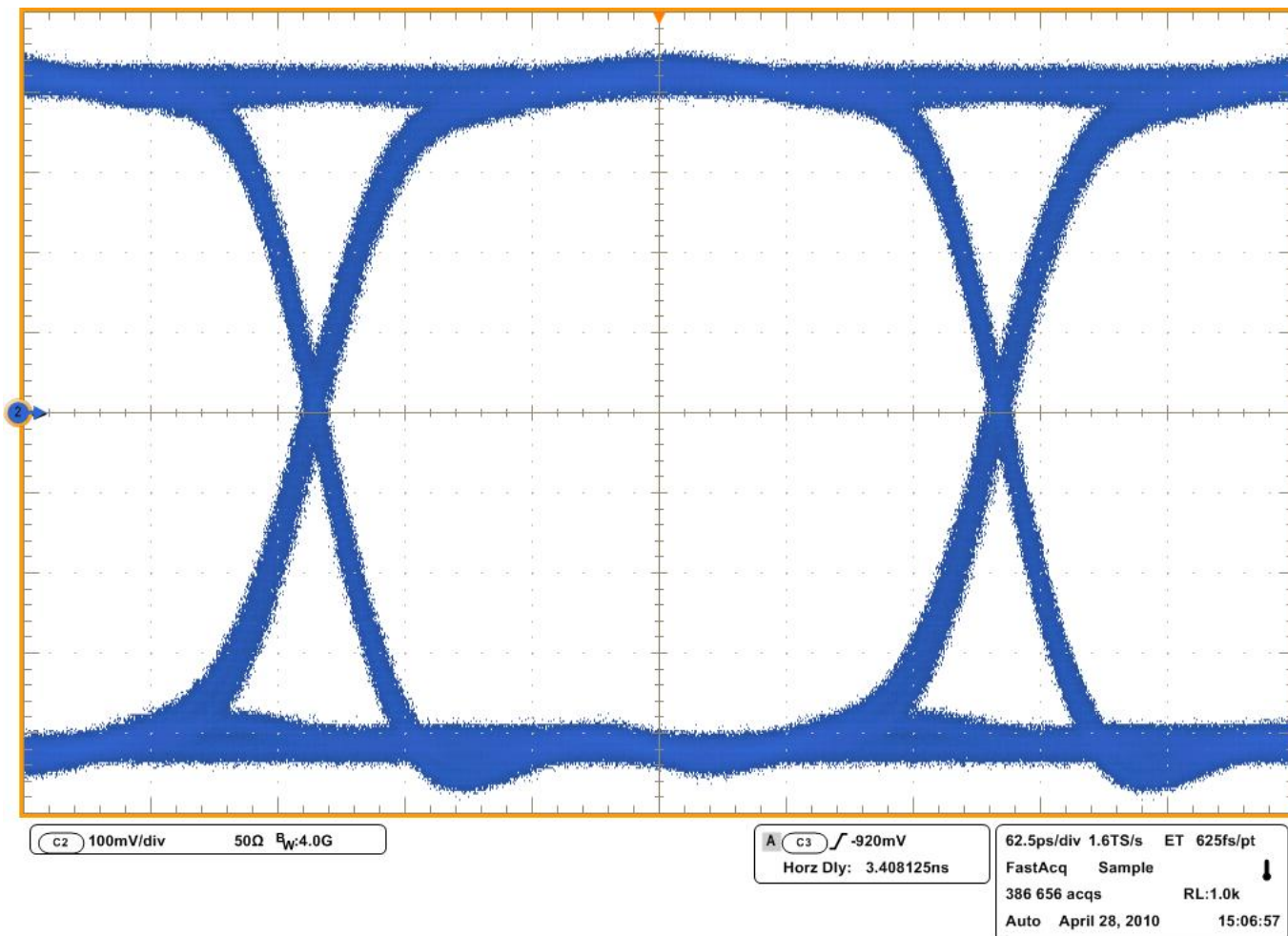

FIGURE 11. LMH0387 Cable Driver Output at 2.97 Gbps

## Equalizer Output

Figure 12 shows the typical output waveform from the LMH0387 equalizer at 2.97 Gbps with 120m Belden 1694A cable on the input. The input signal is a 2.97 Gbps PRBS10 from the Agilent 86130A BERT. The input is connected differentially to the SDI SMA inputs on an SD302 eval board with matched 3' SMA cables. The SD302 output signal is driven through 120m of Belden 1694A cable and received at the BNC\_IO input on the SD387. The SD387 SDO SMA output is connected via a 3' SMA cable to the 50Ω SMA input on the Tektronix DSA7125 12.5 GHz Oscilloscope.

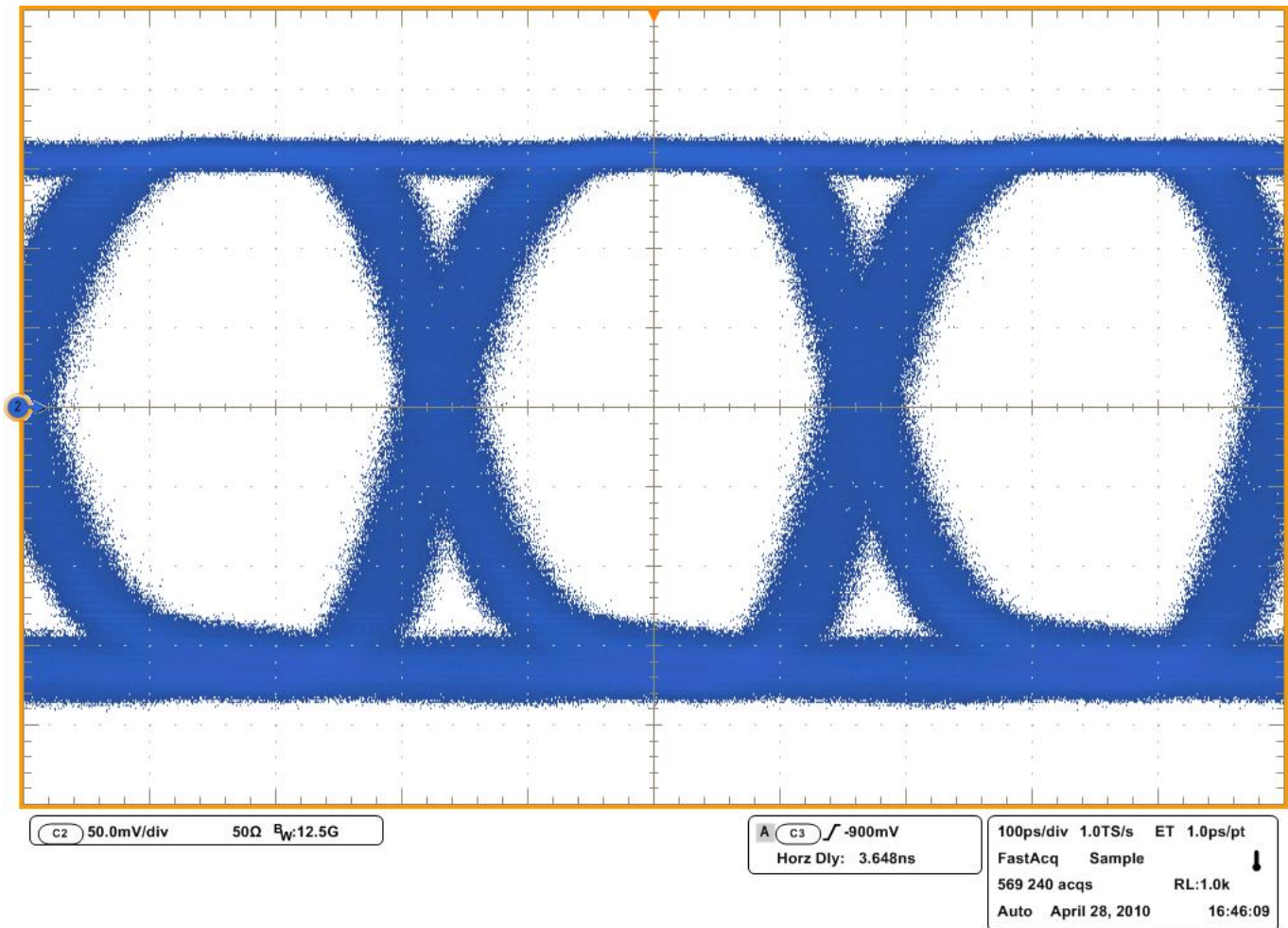

FIGURE 12. LMH0387 Equalizer Output at 2.97 Gbps with 120m



## Input and Output Return Loss

Figure 13 shows the LMH0387 input and output return loss measured at the BNC\_IO on the SD387. The return loss is measured on the Rohde & Schwarz ZVR 75Ω 4GHz network analyzer, with a 75Ω BNC to 75Ω Type N connector on the input. For the input return loss, the equalizer is active and the cable driver is disabled (TX\_EN = 0). For the output return loss, the equalizer is forced to sleep and the cable driver is enabled, with an 8 MHz clock input signal applied to the cable driver inputs.

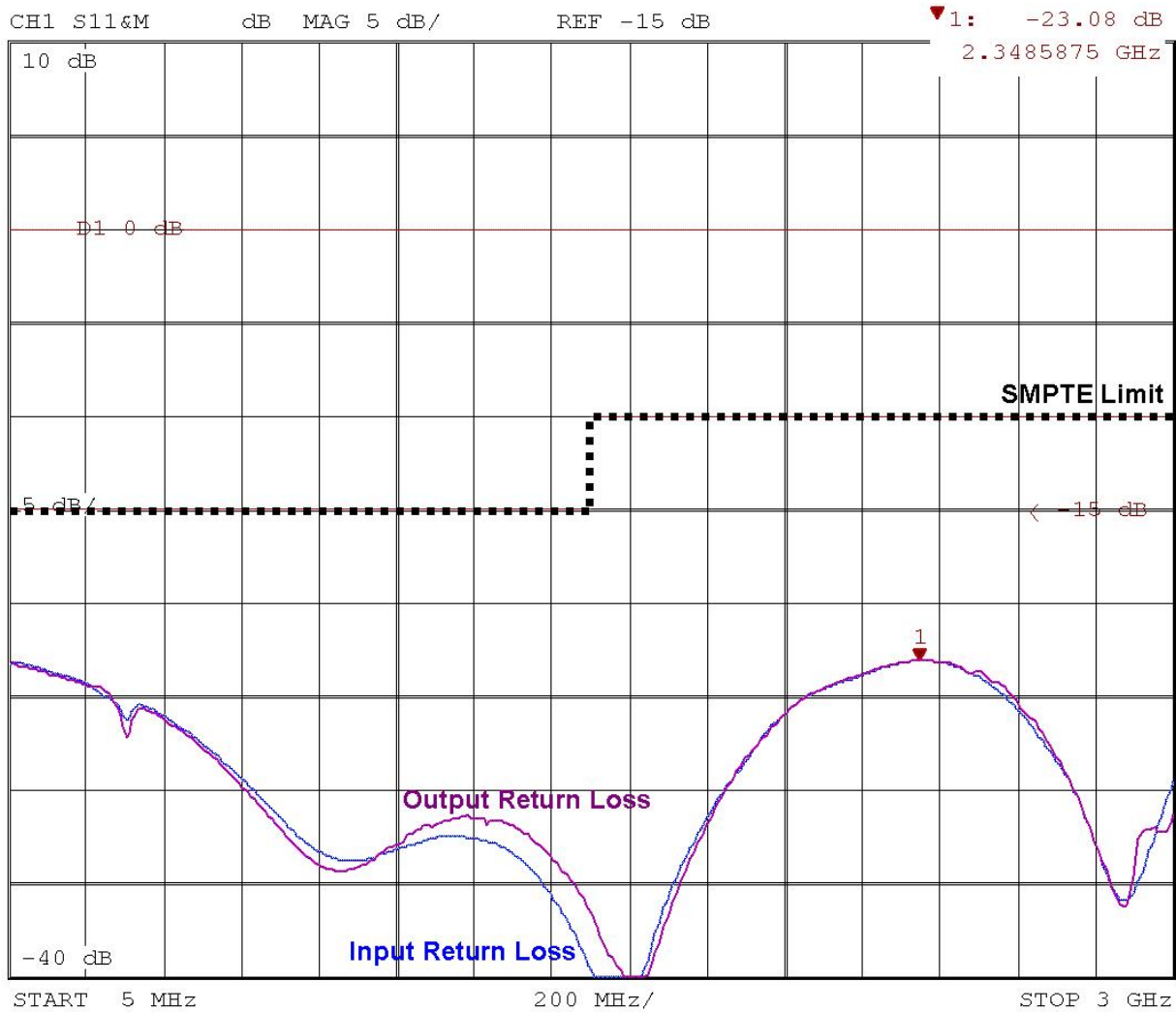
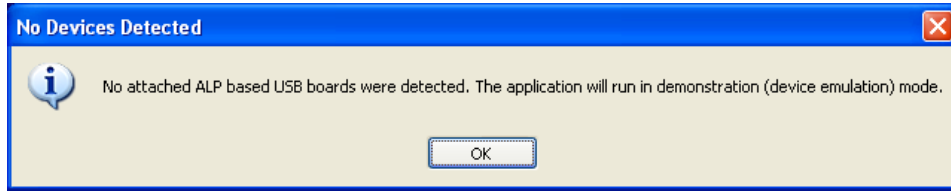

FIGURE 13. LMH0387 Input and Output Return Loss

# Trouble Shooting

If the following window (Figure 14) opens after starting the ALP software, double check the hardware setup.



**FIGURE 14. Analog LaunchPAD No Devices Error**

It may also be that the USB driver is not installed. Check the device manager. There should be an "NSC ALP Nano Atmel" device under the "Universal Serial Bus controllers" as shown in Figure 15.

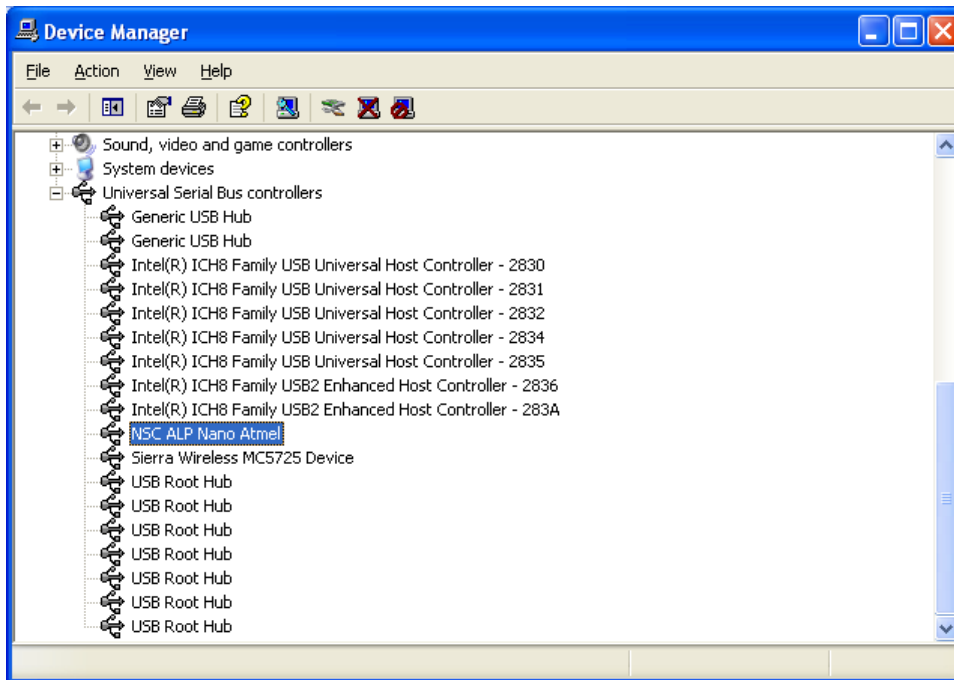

**FIGURE 15. Windows XP, Analog LaunchPAD USB Driver**

The software should start with only "LMH0387 - Nano" in the "Devices" pull down menu. If there are more devices then the software is most likely in demo mode. When the ALP is operating in demo mode there is a "(Demo Mode)" indication in the lower left of the application status bar as shown in Figure 16.

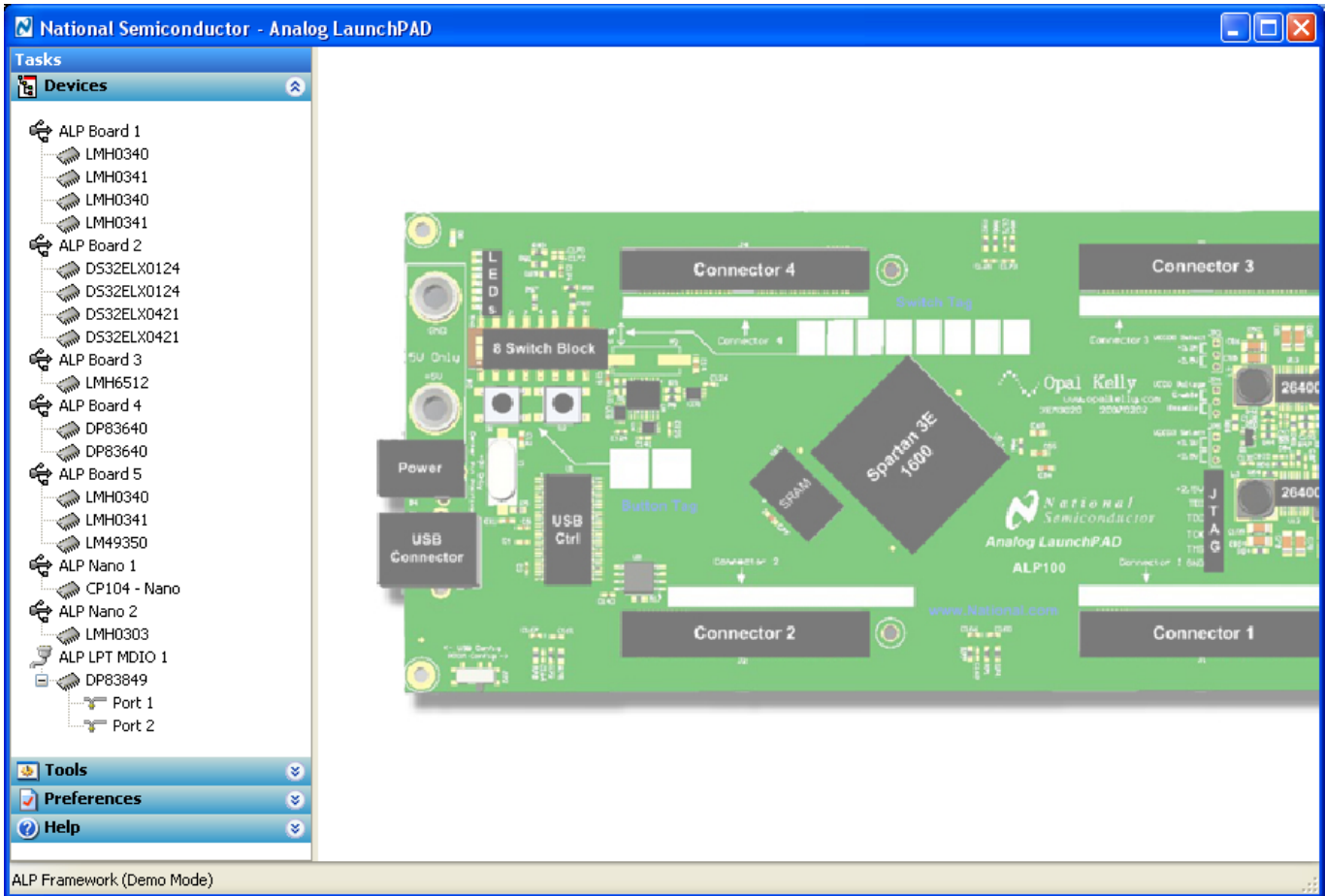

**FIGURE 16. Analog LaunchPAD in Demo Mode**

Disable the demo mode by selecting the “Preferences” pull down menu and un-checking “Enable Demo Mode”.

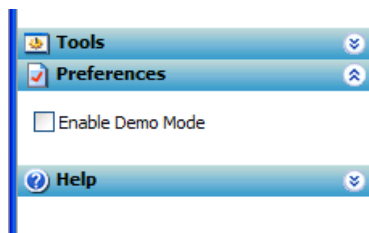

**FIGURE 17. Analog LaunchPAD Preferences Menu**

After demo mode is disabled, the ALP software will poll the ALP hardware. The ALP software will update and have only “LMH0387- Nano” under the “Devices” pull down menu.

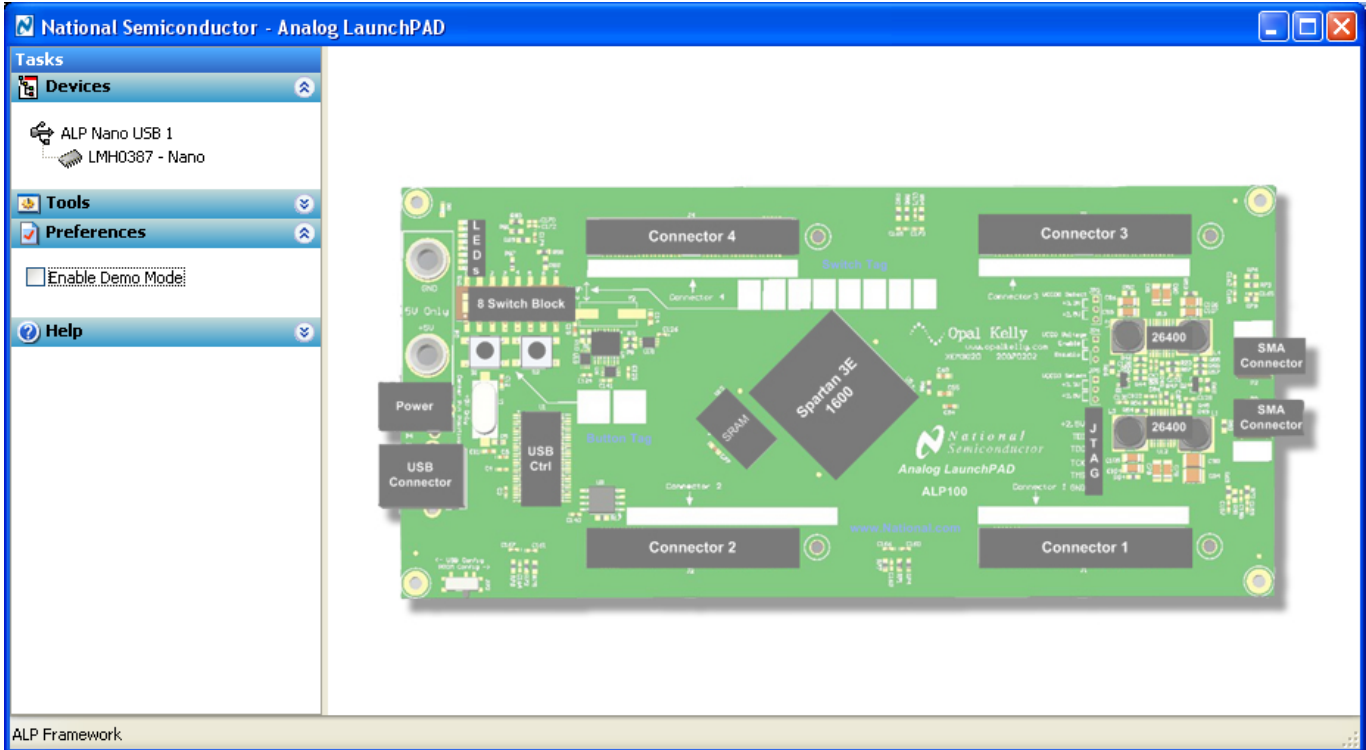
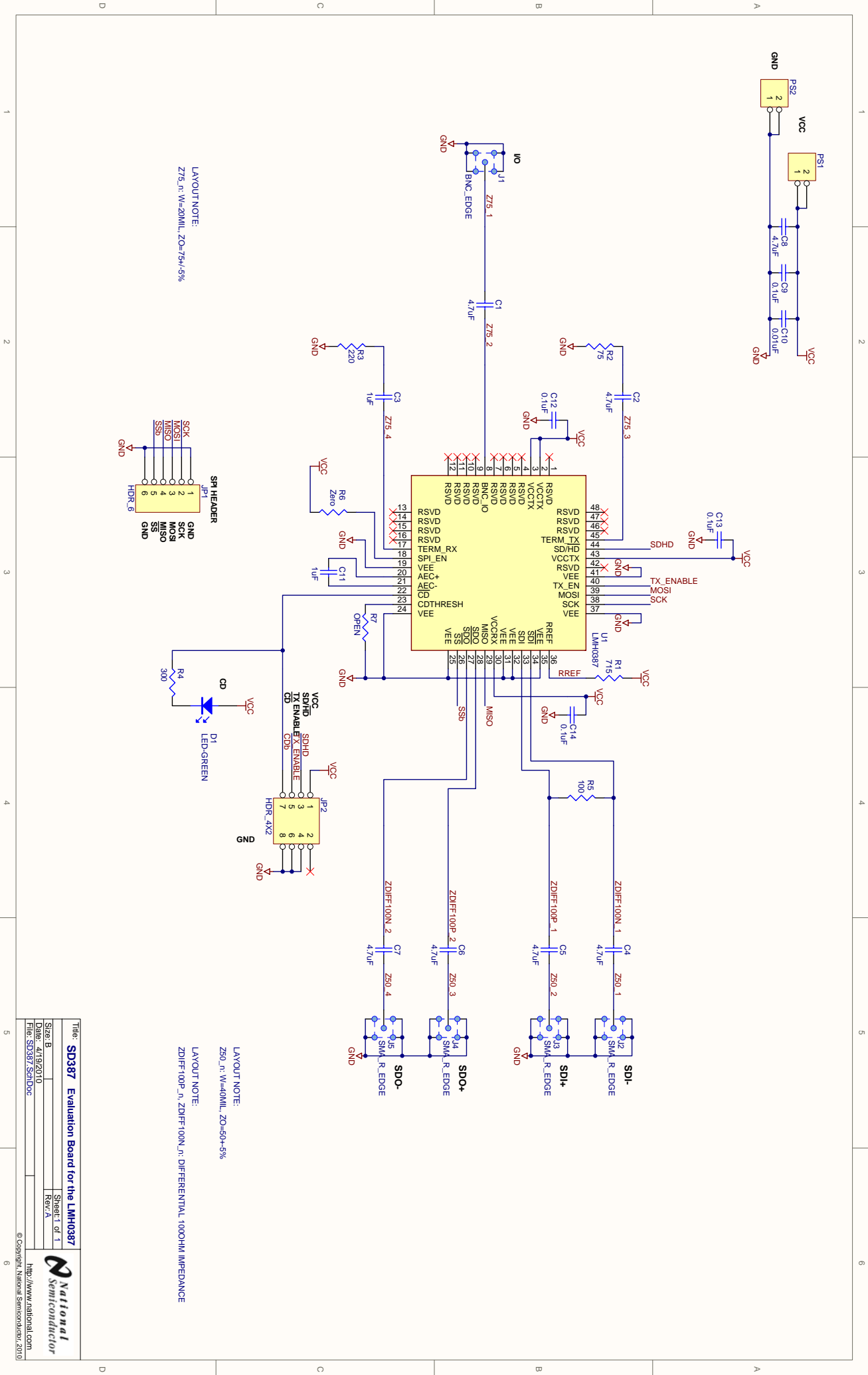

FIGURE 18. Analog LaunchPAD Screen with Demo Mode Off

## SD387 Bill of Materials

Reference Designator	Qty	Description	Manufacturer	Manufacturer Part No.
C1, C2, C4, C5, C6, C7, C8	7	Capacitor, 4.7uF, 6.3V, X5R, 0402	Panasonic - ECG	ECJ-0EB0J475M
C3, C11	2	Capacitor, 1uF, 6.3V, X5R, 0402	Panasonic - ECG	ECJ-0EB0J105M
C9, C12, C13, C14	4	Capacitor, 0.1uF, 16V, X5R, 0402	Panasonic - ECG	ECJ-0EB1C104K
C10	1	Capacitor, 0.01uF, 16V, X7R, 0402	Panasonic - ECG	ECJ-0EB1C103K
D1	1	LED, Green, 0603	Lite-On	LTST-C190GKT
J1	1	BNC, Amphenol, 75-ohm, edge launch	Amphenol	31-6009
J2, J3, J4, J5	4	SMA, 50-ohm, edge launch	Johnson Components	142-0701-851
JP1	1	Header, 6x1, 0.1"	3M/ESD	929834-02-36
JP2	1	Header, 4x2, 0.1"	3M/ESD	929836-02-36
PS1, PS2	2	Header, 2x1, 0.1"	3M/ESD	929834-02-36
R1	1	Resistor, 715-ohm, 1/16W, 1%, 0402	Vishay/Dale	CRCW0402715RFKED
R2	1	Resistor, 75-ohm, 1/16W, 1%, 0402	Yageo	RC0402FR-0775RL
R3	1	Resistor, 220-ohm, 1/16W, 1%, 0402	Rohm	MCR01MZPF2200
R4	1	Resistor, 300-ohm, 1/10W, 5%, 0402	Panasonic - ECG	ERJ-2GEJ301X
R5	1	Resistor, 100-ohm, 1/16W, 1%, 0402	Rohm	MCR01MZPF1000
R6	1	Resistor, 0-ohm, 1/10W, 5%, 0402	Panasonic - ECG	ERJ-2GEOR00X
U1	1	LMH0387 Configurable IO	National Semiconductor	LMH0387SL

## SD387 Schematic



LAYOUT NOTE:  
ZT75\_n: W=20MIL, ZO=75+-5%

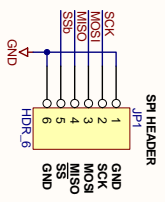

LAYOUT NOTE:  
Z50\_n: W=40MIL, ZO=50+-5%

LAYOUT NOTE:  
ZDIF100P\_n, ZDIF100N\_n: DIFFERENTIAL, 100OHM IMPEDANCE

## SPA Dongle Bill of Materials

Reference Designator	Qty	Description	Manufacturer	Manufacturer Part No.
CR2,CR1	2	SUPPRESSOR ESD 24VDC 0603 SMD	Littelfuse Inc	PGB1010603MR
C1,C2,C3,C4,C5,C6,C100	7	CAP CER .1UF 50V 10% X7R 0603	Murata	GRM188R71H104KA93D
C7	1	CAPACITOR TANT 1.0UF 16V 10% SMD	Kemet	T491A105K016AT
C8,C9	2	CAP CER .22UF 50V Y5V 0603	TDK Corporation	C1608Y5V1H224Z
C10,C11	2	CAP CERAMIC 12PF 50V NP0 0603	Kemet	C0603C120J5GACTU
C14	1	CAPACITOR TANT 4.7UF 16V 10% SMD	Kemet	T491A475K016AT
C15	1	CAP CERM 33000PF 5% 50V X7R 0603	AVX Corporation	06035C333JAT2A
D1	1	LED TOPLED 628NM SUP RED CLR SMD	Osram Opto Semiconductors	LS M670-H2L1-1-0-10-R18-Z
D5,D2	2	LED TOPLED 628/570 RED/GRN 4PLCC	Osram Opto Semiconductors	LSG T670-JL-1-0+JL-1-0-10-R18-Z
D3	1	DIODE HI CONDUCTANCE 100V LL-34	Fairchild Semiconductor	FDLL4148
JP1,JP2,JP3	3	CONN HEADER VERT .100 3POS 15AU	AMP/Tyco	87224-3
JP6,JP7	2	CONN HEADER VERT .100 6POS 15AU	AMP/Tyco	87224-6
JP8	1	CONN HEADER VERT .100 4POS 15AU	AMP/Tyco	87224-4
J3	1	CONN RECEPT MINI USB2.0 5POS.	Hirose	UX60-MB-5ST
J7	1	HEADER, 5x2, 0.1"	3M/ESD	929836-02-05-RK
R1,R4,R5,R16,R20,R100	6	RES ZERO OHM 1/10W 5% 0603 SMD	Panasonic	ERJ-3GEY0R00V
R2,R3	2	RES 22 OHM 1/16W 3300PPM 5% 0603	Panasonic	ERA-V33J220V
R6,R7,R101,R102,R103	5	RES 47K OHM 1/16W .1% 0603 SMD	Panasonic	ERA-3AEB473V
R13,R14,R17,R22,R23	5	RES 1.0K OHM 1/16W .1% 0603 SMD	Panasonic	ERA-3AEB102V
R18,R15	2	RES 100K OHM 1/16W .1% 0603 SMD	Panasonic	ERA-3AEB104V
R19	1	RES 120K OHM 1/16W .1% 0603 SMD	Panasonic	ERA-3AEB124V
SW1,SW2	2	SWITCH TACT	APEM Components	ADTSM31NV
U1	1	IC AVR MCU 128K 64QFN	Atmel	AT90USB1287-16MU
U4	1	IC REG LDO 300MA ADJ 8MSOP	National Semiconductor	LP3982IMM-ADJ/NOPB
Y1	1	CRYSTAL 8.00MHZ 8PF FUND SMD	NDK	NX5032GA 8MHZ AT-W

## SPA Dongle Schematic

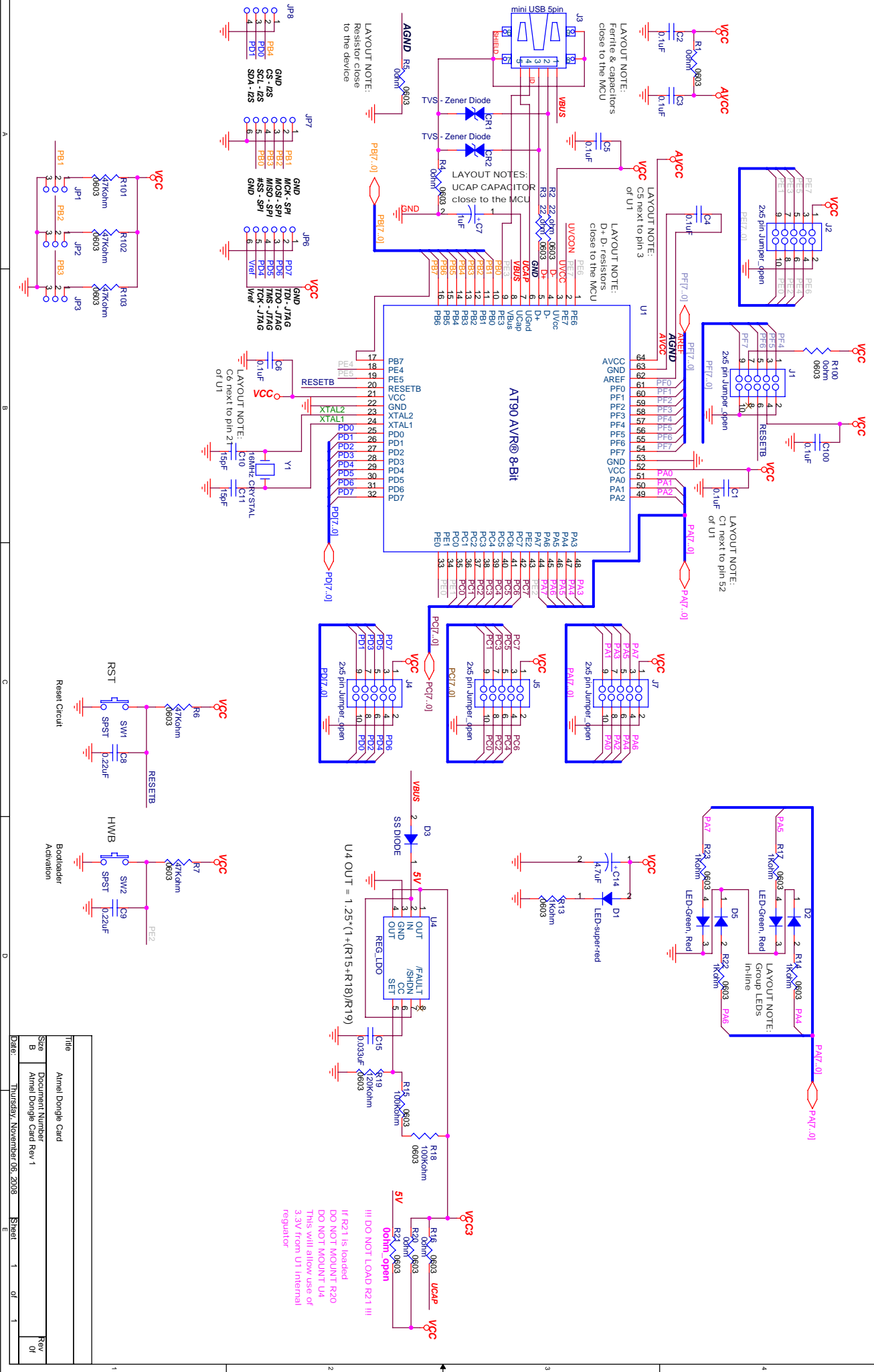

LAYOUT NOTE:  
Ferrite & capacitor's  
close to the MCU

LAYOUT NOTE:  
D+ D- resistors  
close to the MCU

LAYOUT NOTE:  
UCAP CAPACITOR  
close to the MCU

LAYOUT NOTE:  
C5 next to pin 3  
of U1

LAYOUT NOTE:  
C1 next to pin 52  
of U1

LAYOUT NOTE:  
C6 next to pin 27  
of U1

LAYOUT NOTE:  
C7 next to pin 10  
of U1

LAYOUT NOTE:  
C8 next to pin 10  
of U1

LAYOUT NOTE:  
C9 next to pin 10  
of U1

LAYOUT NOTE:  
C10 next to pin 10  
of U1

LAYOUT NOTE:  
C11 next to pin 10  
of U1

LAYOUT NOTE:  
C12 next to pin 10  
of U1

LAYOUT NOTE:  
C13 next to pin 10  
of U1

Title	Atmel Dongle Card
Document Number	Atmel Dongle Card Rev 1
Size	B
Rev	01
Date	Thursday, November 06, 2008
Sheet	1 of 1

!!! DO NOT LOAD R21 !!!  
If R21 is loaded  
DO NOT MOUNT R20  
DO NOT MOUNT U4  
This will allow use of  
3.3V from U1 internal  
regulator.

## IMPORTANT NOTICE

Texas Instruments Incorporated and its subsidiaries (TI) reserve the right to make corrections, modifications, enhancements, improvements, and other changes to its products and services at any time and to discontinue any product or service without notice. Customers should obtain the latest relevant information before placing orders and should verify that such information is current and complete. All products are sold subject to TI's terms and conditions of sale supplied at the time of order acknowledgment.

TI warrants performance of its hardware products to the specifications applicable at the time of sale in accordance with TI's standard warranty. Testing and other quality control techniques are used to the extent TI deems necessary to support this warranty. Except where mandated by government requirements, testing of all parameters of each product is not necessarily performed.

TI assumes no liability for applications assistance or customer product design. Customers are responsible for their products and applications using TI components. To minimize the risks associated with customer products and applications, customers should provide adequate design and operating safeguards.

TI does not warrant or represent that any license, either express or implied, is granted under any TI patent right, copyright, mask work right, or other TI intellectual property right relating to any combination, machine, or process in which TI products or services are used. Information published by TI regarding third-party products or services does not constitute a license from TI to use such products or services or a warranty or endorsement thereof. Use of such information may require a license from a third party under the patents or other intellectual property of the third party, or a license from TI under the patents or other intellectual property of TI.

Reproduction of TI information in TI data books or data sheets is permissible only if reproduction is without alteration and is accompanied by all associated warranties, conditions, limitations, and notices. Reproduction of this information with alteration is an unfair and deceptive business practice. TI is not responsible or liable for such altered documentation. Information of third parties may be subject to additional restrictions.

Resale of TI products or services with statements different from or beyond the parameters stated by TI for that product or service voids all express and any implied warranties for the associated TI product or service and is an unfair and deceptive business practice. TI is not responsible or liable for any such statements.

TI products are not authorized for use in safety-critical applications (such as life support) where a failure of the TI product would reasonably be expected to cause severe personal injury or death, unless officers of the parties have executed an agreement specifically governing such use. Buyers represent that they have all necessary expertise in the safety and regulatory ramifications of their applications, and acknowledge and agree that they are solely responsible for all legal, regulatory and safety-related requirements concerning their products and any use of TI products in such safety-critical applications, notwithstanding any applications-related information or support that may be provided by TI. Further, Buyers must fully indemnify TI and its representatives against any damages arising out of the use of TI products in such safety-critical applications.

TI products are neither designed nor intended for use in military/aerospace applications or environments unless the TI products are specifically designated by TI as military-grade or "enhanced plastic." Only products designated by TI as military-grade meet military specifications. Buyers acknowledge and agree that any such use of TI products which TI has not designated as military-grade is solely at the Buyer's risk, and that they are solely responsible for compliance with all legal and regulatory requirements in connection with such use.

TI products are neither designed nor intended for use in automotive applications or environments unless the specific TI products are designated by TI as compliant with ISO/TS 16949 requirements. Buyers acknowledge and agree that, if they use any non-designated products in automotive applications, TI will not be responsible for any failure to meet such requirements.

Following are URLs where you can obtain information on other Texas Instruments products and application solutions:

### Products

Audio	<a href="http://www.ti.com/audio">www.ti.com/audio</a>
Amplifiers	<a href="http://amplifier.ti.com">amplifier.ti.com</a>
Data Converters	<a href="http://dataconverter.ti.com">dataconverter.ti.com</a>
DLP® Products	<a href="http://www.dlp.com">www.dlp.com</a>
DSP	<a href="http://dsp.ti.com">dsp.ti.com</a>
Clocks and Timers	<a href="http://www.ti.com/clocks">www.ti.com/clocks</a>
Interface	<a href="http://interface.ti.com">interface.ti.com</a>
Logic	<a href="http://logic.ti.com">logic.ti.com</a>
Power Mgmt	<a href="http://power.ti.com">power.ti.com</a>
Microcontrollers	<a href="http://microcontroller.ti.com">microcontroller.ti.com</a>
RFID	<a href="http://www.ti-rfid.com">www.ti-rfid.com</a>
OMAP Mobile Processors	<a href="http://www.ti.com/omap">www.ti.com/omap</a>
Wireless Connectivity	<a href="http://www.ti.com/wirelessconnectivity">www.ti.com/wirelessconnectivity</a>

### Applications

Automotive and Transportation	<a href="http://www.ti.com/automotive">www.ti.com/automotive</a>
Communications and Telecom	<a href="http://www.ti.com/communications">www.ti.com/communications</a>
Computers and Peripherals	<a href="http://www.ti.com/computers">www.ti.com/computers</a>
Consumer Electronics	<a href="http://www.ti.com/consumer-apps">www.ti.com/consumer-apps</a>
Energy and Lighting	<a href="http://www.ti.com/energy">www.ti.com/energy</a>
Industrial	<a href="http://www.ti.com/industrial">www.ti.com/industrial</a>
Medical	<a href="http://www.ti.com/medical">www.ti.com/medical</a>
Security	<a href="http://www.ti.com/security">www.ti.com/security</a>
Space, Avionics and Defense	<a href="http://www.ti.com/space-avionics-defense">www.ti.com/space-avionics-defense</a>
Video and Imaging	<a href="http://www.ti.com/video">www.ti.com/video</a>

TI E2E Community Home Page

[e2e.ti.com](http://e2e.ti.com)

Mailing Address: Texas Instruments, Post Office Box 655303, Dallas, Texas 75265  
Copyright © 2012, Texas Instruments Incorporated