

LMG341xR070 600-V 70-mΩ GaN with Integrated Driver and Protection

1 Features

- TI GaN Process Qualified Through Accelerated Reliability In-application Hard-switching Mission Profiles
- Enables High Density Power Conversion Designs
 - Superior System Performance Over Cascode or Stand-alone GaN FETs
 - Low Inductance 8mm x 8mm QFN Package for Ease of Design, and Layout
 - Adjustable Drive Strength for Switching Performance and EMI Control
 - Digital Fault Status Output Signal
 - Only +12 V Unregulated Supply Needed
- Integrated Gate Driver
 - Zero Common Source Inductance
 - 20 ns Propagation Delay for MHz Operation
 - Process-tuned Gate Bias Voltage for Reliability
 - 25 to 100V/ns User Adjustable Slew Rate
- Robust Protection
 - Requires No External Protection Components
 - Over-current Protection with <100ns Response
 - >150V/ns Slew Rate Immunity
 - Transient Overvoltage Immunity
 - Overtemperature Protection
 - UVLO Protection on All Supply Rails
- **Device Options:**
 - **LMG3410R070:** Latched Overcurrent Protection
 - **LMG3411R070:** Cycle-by-cycle Overcurrent Protection

2 Applications

- High Density Industrial and Consumer Power Supplies
- Multi-level Converters
- Solar Inverters
- Industrial Motor Drives
- Uninterruptible Power Supplies
- High Voltage Battery Chargers

3 Description

The LMG341xR070 GaN power stage with integrated driver and protection enables designers to achieve new levels of power density and efficiency in power electronics systems. The LMG341x's inherent advantages over silicon MOSFETs include ultra-low input and output capacitance, zero reverse recovery to reduce switching losses by as much as 80%, and low switch node ringing to reduce EMI. These advantages enable dense and efficient topologies like the totem-pole PFC.

The LMG341xR070 provides a smart alternative to traditional cascode GaN and standalone GaN FETs by integrating a unique set of features to simplify design, maximize reliability and optimize the performance of any power supply. Integrated gate drive enables 100V/ns switching with near zero Vds ringing, <100 ns current limiting self-protects against unintended shoot-through events, Overtemperature shutdown prevents thermal runaway, and system interface signals provide self-monitoring capability.

Device Information⁽¹⁾

PART NUMBER	PACKAGE	BODY SIZE (NOM)
LMG341xR070	QFN (32)	8.00 mm x 8.00 mm

(1) For all available packages, see the orderable addendum at the end of the data sheet.

Simplified Block Diagram

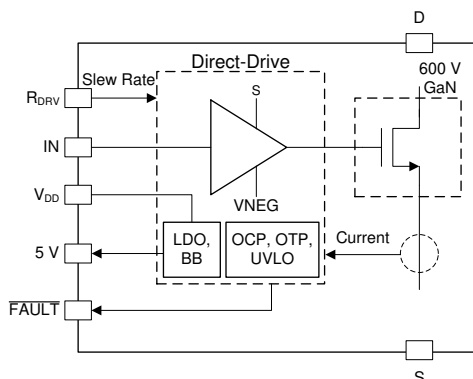

Switching Performance at >100 V/ns

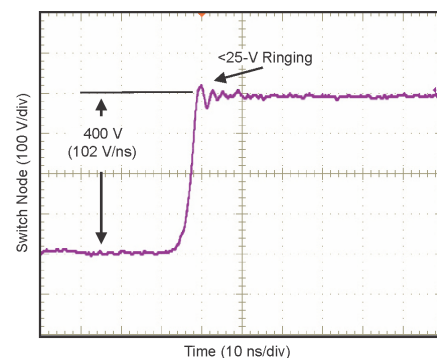

Table of Contents

1 Features	1	9 Application and Implementation	16
2 Applications	1	9.1 Application Information.....	16
3 Description	1	9.2 Typical Application	17
4 Revision History	2	9.3 Paralleling GaN Devices	20
5 Pin Configuration and Functions	4	9.4 Do's and Don'ts	20
6 Specifications	5	10 Power Supply Recommendations	21
6.1 Absolute Maximum Ratings	5	10.1 Using an Isolated Power Supply	21
6.2 ESD Ratings.....	5	10.2 Using a Bootstrap Diode	21
6.3 Recommended Operating Conditions.....	5	11 Layout	23
6.4 Thermal Information	6	11.1 Layout Guidelines	23
6.5 Electrical Characteristics.....	6	11.2 Layout Example	24
6.6 Switching Characteristics	7	12 Device and Documentation Support	26
6.7 Typical Characteristics	8	12.1 Device Support.....	26
7 Parameter Measurement Information	10	12.2 Documentation Support	26
7.1 Switching Parameters	10	12.3 Receiving Notification of Documentation Updates	26
8 Detailed Description	13	12.4 Community Resources.....	26
8.1 Overview	13	12.5 Trademarks	26
8.2 Functional Block Diagram	13	12.6 Electrostatic Discharge Caution.....	26
8.3 Feature Description.....	14	12.7 Glossary	26
8.4 Device Functional Modes.....	16	13 Mechanical, Packaging, and Orderable Information	26

4 Revision History

Changes from Revision E (October 2018) to Revision F	Page
• Deleted max drain-source leakage current	6
• Added test condition for I_{trip}	7
<hr/>	
Changes from Revision D (August 2018) to Revision E	Page
• Added LMG3411R070 to the LMG3410R070 datasheet	1
• Added additional information in the overcurrent protection.....	14
<hr/>	
Changes from Revision C (November 2017) to Revision D	Page
• Changed data sheet status from: Advanced Information to: Production Data	1
• Changed generic part number from: LMG3S10 to: LMG3410R070.....	1
<hr/>	
Changes from Revision B (March 2017) to Revision C	Page
• Changed front page	1
<hr/>	
Changes from Revision A (June 2016) to Revision B	Page
• Changed Gan Technology Preview to Advanced Information	1

Changes from Original (April 2016) to Revision A**Page**

• Clarified part features list on front page	1
• Clarified definition of turn-on and turn-off energy	12
• Corrected wording in Do's and Don'ts section	20
• Removed non-suitable isolated supply recommendation	21

5 Pin Configuration and Functions

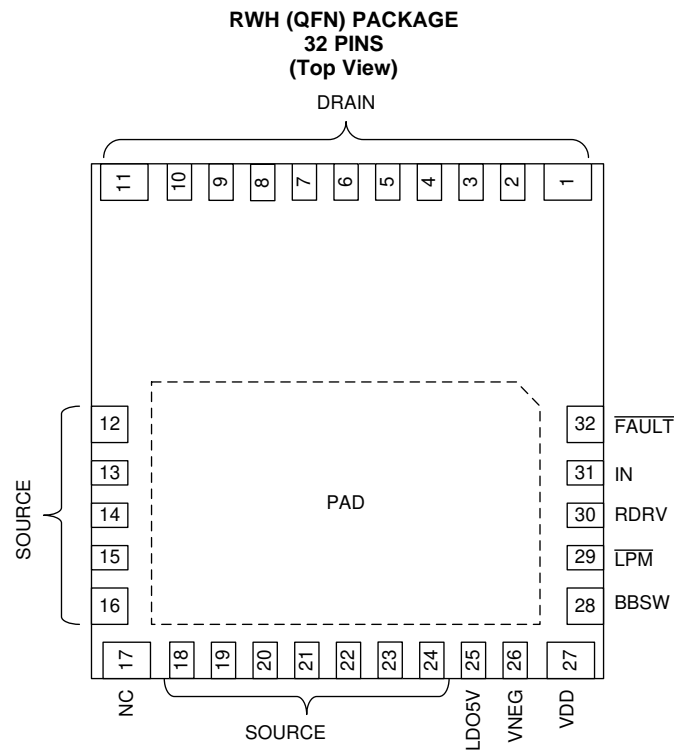

Pin Functions

PIN		I/O ⁽¹⁾	DESCRIPTION
NAME	NO.		
BBSW	28	P	Internal buck-boost converter switch pin. Connect an inductor from this point to source
DRAIN	1-11	P	Power transistor drain
FAULT	32	O	Fault output, push-pull, active low
IN	31	I	CMOS-compatible non-inverting gate drive input
LDO5V	25	P	5-V LDO output for external digital isolator.
LPM	29	I	Enables low-power-mode by connecting the pin to source
SOURCE	12-16, 18-24	P	Power transistor source, die-attach pad, thermal sink, signal ground reference
RDRV	30	I	Drive strength selection pin. Connect a resistor from this pin to ground to set the turn-on drive strength to control slew rate,
VDD	27	P	12-V power input, relative to source. Supplies 5-V rail and gate drive supply.
VNEG	26	P	Negative supply output, bypass to source with 2.2- μ F capacitor
NC	17	—	Not connected, connect to source or leave floating.
PAD	—	P	Thermal Pad, tie to source with multiple vias.

(1) I = Input, O = Output, P = Power

6 Specifications

6.1 Absolute Maximum Ratings

over operating free-air temperature range (unless otherwise noted) ⁽¹⁾

		MIN	MAX	UNIT
V _{DS}	Drain-Source Voltage		600	V
V _{DS,tr} ⁽²⁾	Transient Drain-Source Voltage		800	V
V _{DD}	Supply Voltage	-0.3	20	V
I _{DS,pul} ⁽³⁾	Drain-Source Current, Pulsed		100	A
I _{DS} ⁽⁴⁾	Continuous drain current @T _J =25°C		40	
	Continuous drain current @T _J =100°C		30	A
V _{IN}	IN, $\overline{\text{LPM}}$ Pin Voltage	-0.3	5.5	V
V _{FAULT}	$\overline{\text{FAULT}}$ Pin Voltage	-0.3	5.5	V
T _{STG}	Storage Temperature	-55	150	°C
T _J	Operating Temperature	-40	150	°C

- (1) Stresses beyond those listed under *Absolute Maximum Ratings* may cause permanent damage to the device. These are stress ratings only, which do not imply functional operation of the device at these or any other conditions beyond those indicated under *Recommended Operating Conditions*. Exposure to absolute-maximum-rated conditions for extended periods may affect device reliability.
- (2) <1% duty cycle, <1us, for 1M pulses
- (3) Pulse current <100ns
- (4) The current is the drain current of GaN transistor only. Power stage current is clamped by integrated OCP. Please refer to the OCP thresholds in Electrical Characteristics section.

6.2 ESD Ratings

			VALUE	UNIT
V _(ESD)	Electrostatic discharge	Human body model (HBM), per ANSI/ESDA/JEDEC JS-001, all pins ⁽¹⁾	±1000	V
		Charged device model (CDM), per JEDEC specification JESD22-C101, all pins ⁽²⁾	±250	

- (1) JEDEC document JEP155 states that 500-V HBM allows safe manufacturing with a standard ESD control process.
- (2) JEDEC document JEP157 states that 250-V CDM allows safe manufacturing with a standard ESD control process.

6.3 Recommended Operating Conditions

over operating free-air temperature range (unless otherwise noted)

		MIN	NOM	MAX	UNIT
V _{DS}	Drain-Source Voltage			480	V
V _{DD}	Supply Voltage	9.5	12	18	V
I _{DS}	DC Drain-Source Current (T _J =125°C)			12	A
V _{IN}	IN, $\overline{\text{LPM}}$ Pin Voltage			5	V
I _{+5V}	LDO External Load Current			5	mA
R _{DRV}	Slew rate control resistor	15		150	kΩ
L _{DCDC}	DC-DC buck-boost converter output inductor		22		μH
C _{DCDC}	DC-DC buck/boost converter output capacitor		2.2		μF
T _J	Operating Temperature	-40		125	°C

6.4 Thermal Information

THERMAL METRIC ⁽¹⁾		LMG3410R070	
		RWH (QFN)	
		32 PINS	
			UNIT
R _{θJA}	Junction-to-ambient thermal resistance	57	°C/W
R _{θJC(top)}	Junction-to-case (top) thermal resistance	5.3	°C/W
R _{θJC(bot)}	Junction-to-case (bottom) thermal resistance	0.5	°C/W

(1) For more information about traditional and new thermal metrics, see the Semiconductor and IC Package Thermal Metrics application report, SPRA953.

6.5 Electrical Characteristics

over operating free-air temperature range, 9.5 V < V_{DD} < 18 V, LPM = 5 V, V_{NEG} = -14 V (unless otherwise noted)

PARAMETER		TEST CONDITIONS	MIN	TYP	MAX	UNIT
GaN POWER TRANSISTOR						
R _{DS,ON}	On-state Resistance	T _J = 25°C		70		mΩ
		T _J = 125°C		110		
V _{SD}	Third-quadrant mode source-drain voltage	I _N = 0 V, I _{SD} = 0.1 A		5		V
		I _N = 0 V, I _{SD} = 10 A		7.8		
I _{DSS}	Drain Leakage Current	V _{DS} = 600 V, T _J = 25°C		1		μA
		V _{DS} = 600 V, T _J = 125°C		10		
C _{oss}	GaN output capacitance	I _N = 0 V, V _{DS} = 400 V, f _{SW} = 250 kHz		71		pF
C _{oss,er}	Effective output capacitance, energy related	I _N = 0 V, V _{DS} = 0-400 V		95		pF
C _{oss,tr}	Effective output capacitance, time related	I _D = 5 A, I _N = 0 V, V _{DS} = 0-400 V		145		pF
Q _{rr}	Reverse recovery charge	V _R = 400 V, I _{SD} = 5 A, dI _{SD} /dt = 1 A/ns		0		nC
DRIVER SUPPLY						
I _{VDD,LPM}	Quiescent current, ultra-low-power mode	V _{LPM} = 0 V, V _{DD} = 12 V		80	95	μA
I _{VDD,Q}	Quiescent current (average)	Transistor held off		0.5		mA
		transistor held on		0.5		
I _{VDD,op}	Operating current	V _{DD} = 12 V, f _{SW} = 1 MHz, R _{DRV} = 40 kΩ, 50% duty cycle		43		mA
V _{+5V}	5V LDO output voltage	V _{DD} = 12 V	4.7		5.3	V
V _{NEG}	Negative Supply	30-mA load current		-13.9		V
BUCK BOOST CONVERTER						
f _{SW,GAN}	FET switching frequency			1		MHz
I _{DCDC,PK}	Peak inductor current	I _{OUT} = 20 mA, V _{IN} = 12 V, V _{OUT} = -14 V		250	350	mA
ΔV _{NEG}	DC-DC output ripple voltage, pk-pk	C _{NEG} = 2.2 μF, I _{OUT} = 20 mA		50		mV
DRIVER INPUT						
V _{IH}	Input pin, $\overline{\text{LPM}}$ pin, logic high threshold				2.5	V
V _{IL}	Input pin, $\overline{\text{LPM}}$ pin, low threshold		0.8			V
V _{HYST}	Input pin, $\overline{\text{LPM}}$ pin, hysteresis			0.8		V
R _{IN,L}	Input pull-down resistance			150		kΩ
R _{LPM}	$\overline{\text{LPM}}$ pin pull-down resistance			150		kΩ

Electrical Characteristics (continued)

over operating free-air temperature range, $9.5\text{ V} < V_{DD} < 18\text{ V}$, $LPM = 5\text{ V}$, $V_{NEG} = -14\text{ V}$ (unless otherwise noted)

PARAMETER		TEST CONDITIONS	MIN	TYP	MAX	UNIT
UNDERVOLTAGE LOCKOUT						
$V_{DD,(ON)}$	V_{DD} turnon threshold	Turn-on voltage		9.1		V
$V_{DD,(OFF)}$	V_{DD} turnoff threshold	Turn-off voltage		8.5		V
$\Delta V_{DD,UVLO}$	UVLO Hysteresis			550		mV
FAULT						
I_{trip}	Current Fault Trip Point	$-40^{\circ}\text{C} \leq T_j \leq 125^{\circ}\text{C}$	22	36	50	A
T_{trip}	Temperature Trip Point	trip point		165		$^{\circ}\text{C}$
$T_{tripHys}$	Temperature Trip Hysteresis			20		$^{\circ}\text{C}$

6.6 Switching Characteristics

over operating free-air temperature range, $9.5\text{ V} < V_{DD} < 18\text{ V}$, $V_{NEG} = -14\text{ V}$, $V_{BUS} = 400\text{ V}$ (unless otherwise noted)

PARAMETER		TEST CONDITIONS	MIN	TYP	MAX	UNIT
GaN FET						
dv/dt	Turn-on Drain Slew Rate	$R_{DRV} = 15\text{ k}\Omega$		100		V/ns
		$R_{DRV} = 40\text{ k}\Omega$		50		
		$R_{DRV} = 100\text{ k}\Omega$		25		
$\Delta dv/dt$	Slew Rate Variation	turn on, $I_L = 5\text{ A}$, $R_{DRV} = 40\text{ k}\Omega$		25		%
dv/dt	Edge Rate Immunity	Drain dv/dt, device remains off inductor-fed, max di/dt = 10 A/ns		150		V/ns
STARTUP						
t_{START}	Startup Time, V_{IN} rising above UVLO	Time until gate responds to IN $C_{NEG} = 2.2\text{ }\mu\text{F}$, $C_{LDO} = 1\text{ }\mu\text{F}$		1		ms
DRIVER						
$t_{pd,on}$	Propagation delay, turn on	IN rising to $I_{DS} > 1\text{ A}$, $V_{DS} = 400\text{ V}$, $R_{DRV} = 40\text{ k}\Omega$, $V_{NEG} = -14\text{ V}$		20		ns
$t_{delay,on}$	Turn on delay time	$I_{DS} > 1\text{ A}$ to $V_{DS} < 320\text{ V}$, $R_{DRV} = 40\text{ k}\Omega$		12		ns
$t_{VDS,ft}$	VDS fall time	$V_{DS} = 320\text{ V}$ to $V_{DS} = 80\text{ V}$, $I_D = 5\text{ A}$		4.2		ns
$t_{pd,off}$	Propagation delay, turn off	IN falling to $V_{DS} > 10\text{ V}$; $I_D = 5\text{ A}$		36		ns
$t_{delay,off}$	Turn off delay time	$V_{DS} = 10\text{ V}$ to $V_{DS} = 80\text{ V}$, $I_D = 5\text{ A}$		10		ns
$t_{VDS,rt}$	VDS rise time	$V_{DS} = 80\text{ V}$ to $V_{DS} = 320\text{ V}$, $I_D = 5\text{ A}$		15		ns
FAULT						
t_{curr}	Current Fault Delay	$I_{DS} > I_{TH}$ to $\overline{\text{FAULT}}$ low		50		ns
t_{blank}	Current Fault Blanking Time	$V_{IN} > V_{IH}$ to end of blanking, $R_{DRV} = 15\text{ k}\Omega$		55		ns
t_{reset}	Fault reset time	IN held low	250	350	500	μs

6.7 Typical Characteristics

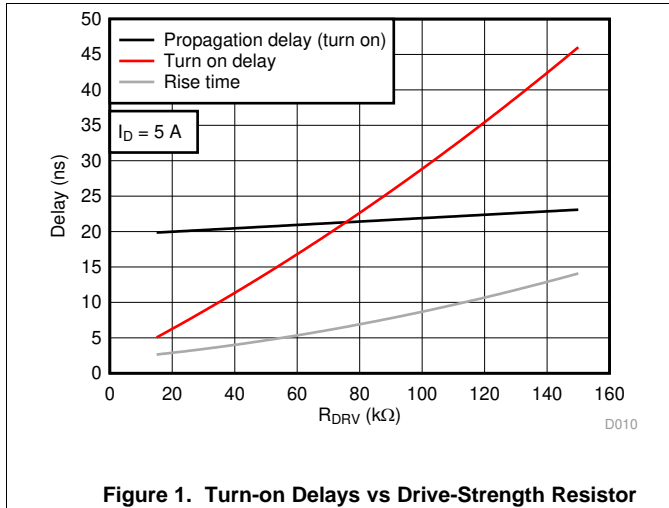

Figure 1. Turn-on Delays vs Drive-Strength Resistor

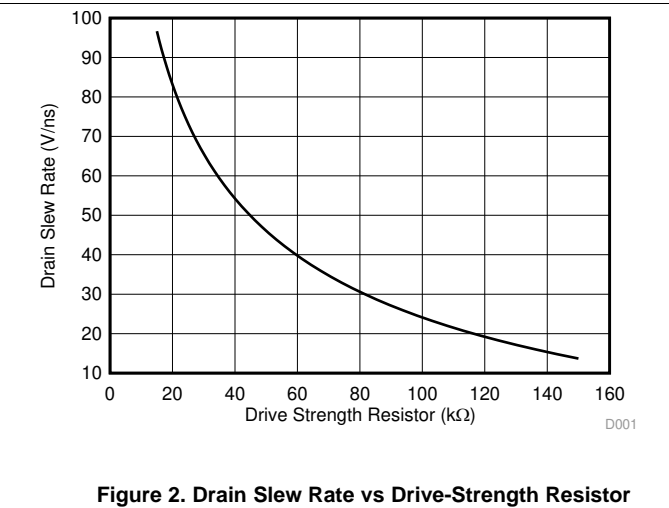

Figure 2. Drain Slew Rate vs Drive-Strength Resistor

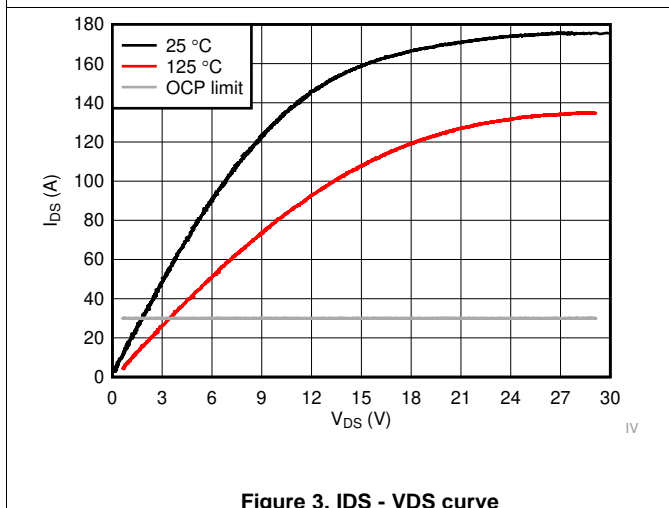

Figure 3. IDS - VDS curve

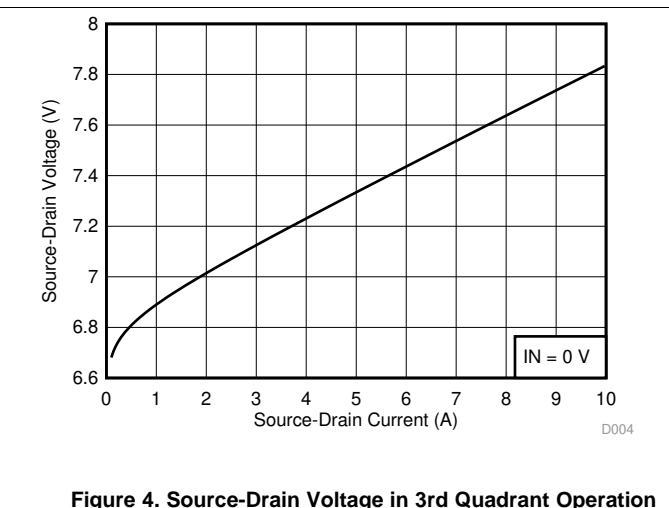

Figure 4. Source-Drain Voltage in 3rd Quadrant Operation

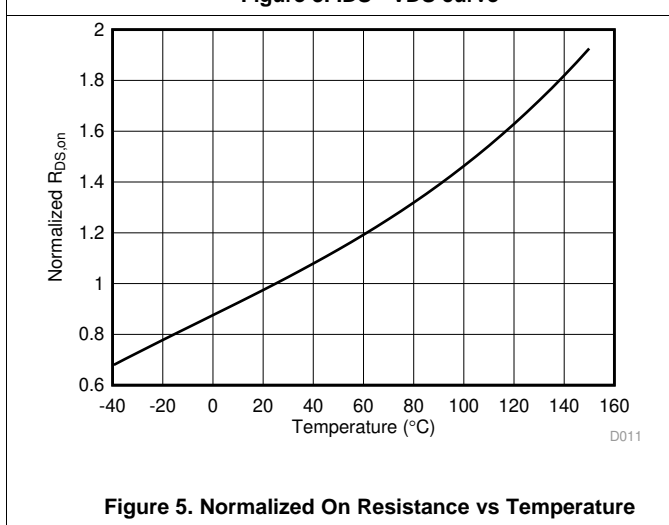

Figure 5. Normalized On Resistance vs Temperature

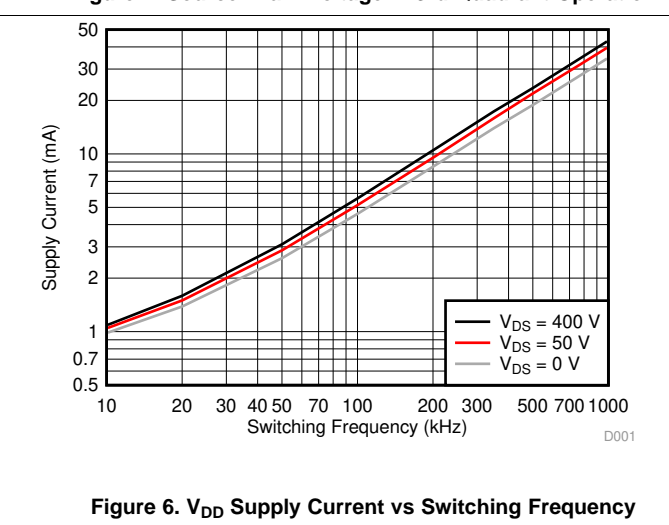

Figure 6. V_{DD} Supply Current vs Switching Frequency

Typical Characteristics (continued)

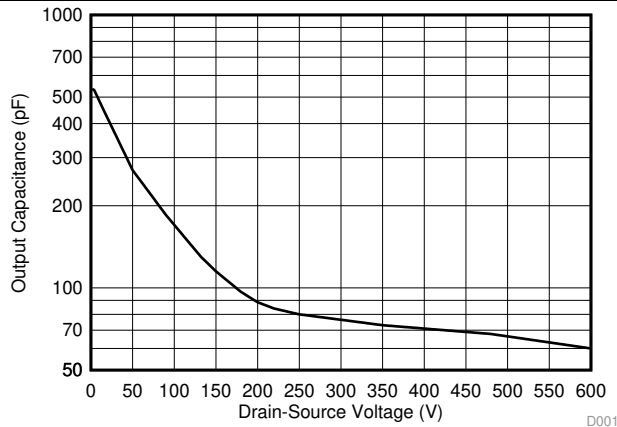

Figure 7. Output Capacitance

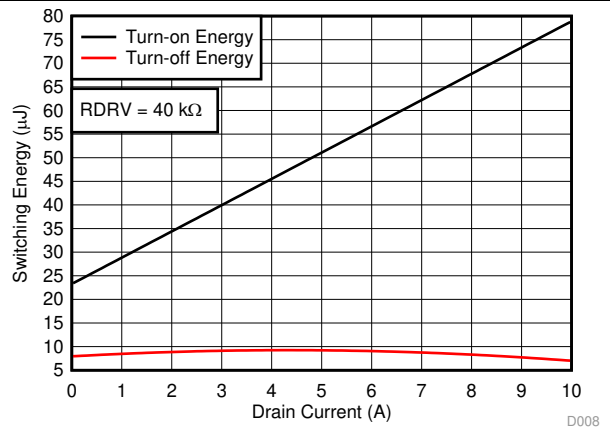

Figure 8. Hard-switched Half-Bridge Turn-on and Turn-off Switching Energy vs Drain Current

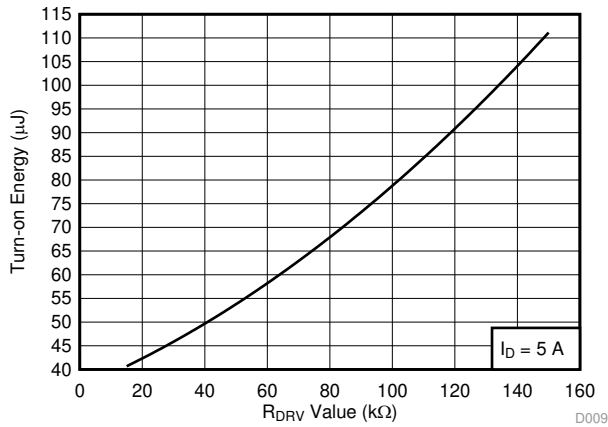

Figure 9. Hard-switched Half-Bridge Turn-On Switching Energy vs Slew Rate Resistor

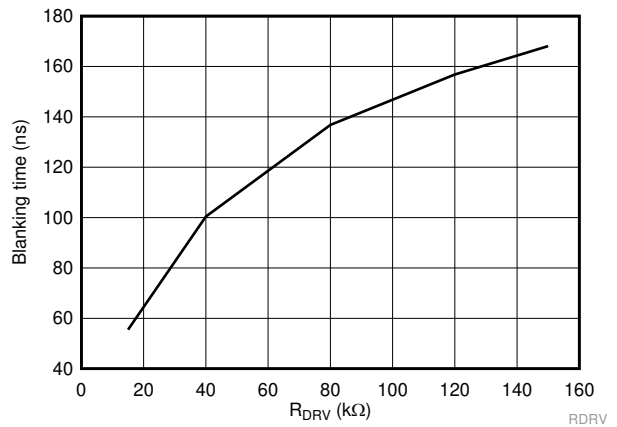

Figure 10. RDRV vs Blanking Time

Switching Parameters (continued)

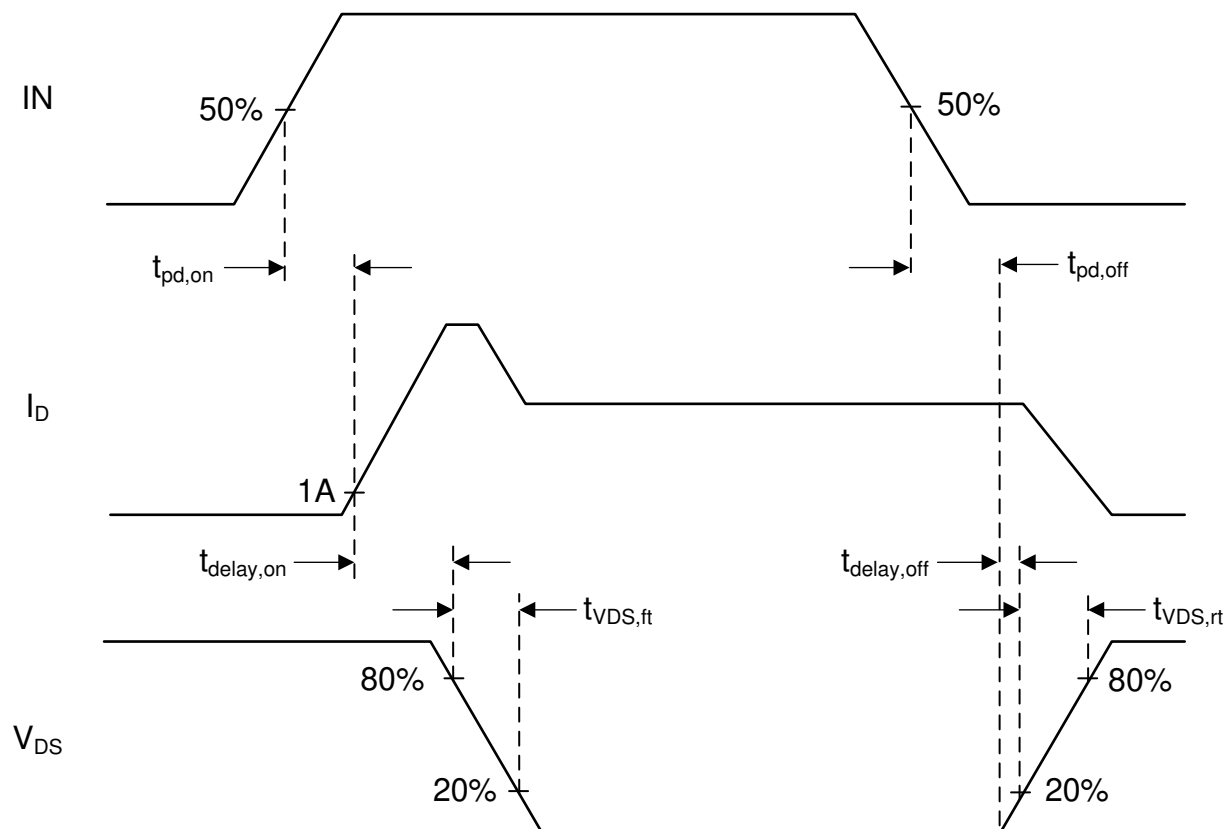

Figure 12. Measurement to Determine Propagation Delays and Slew Rates

7.1.1 Turn-on Delays

The timing of the turn-on transition has three components: propagation delay, turn-on delay and rise time. The first component is the propagation delay of the driver from when the input goes high to when the GaN FET starts turning on (represented by 1 A drain current). The turn-on delay is the delay from when the FET starts turning on to when the drain voltage swings down by 20 percent. Finally, the V_{DS} fall time is the time it takes the drain voltage to slew between 80 percent and 20 percent of the bus voltage. The drive-strength resistor value has a large effect on turn-on delay and V_{DS} fall time but does not affect the propagation delay significantly.

7.1.2 Turn-off Delays

The timing of the turn-off transition has three components: propagation delay, turn-off delay and fall time. The first component is the propagation delay of the driver from when the input goes low to when the GaN FET starts turning off. The turn-off delay is the delay from when the FET starts turning off (represented by the drain rising above 10 V) to when the drain voltage swings up by 20 percent. Finally, the V_{DS} rise time is the time it takes the drain voltage to slew between 20 percent and 80 percent of the bus voltage. The turn-off delays of the LMG341xR070 are independent of the drive-strength resistor but the turn-off delay and the V_{DS} rise time are heavily dependent on the load current.

7.1.3 Drain Slew Rate

The slew rate, measured in volts per nanosecond, is measured on the turn-on edge of the LMG341xR070. The slew rate is considered over the V_{DS} fall time, where the drain falls from 80 percent to 20 percent of the bus voltage. The drain slew rate is thus given by 60 percent of the bus voltage divided by the V_{DS} fall time. This drain slew rate is dependent on the RDRV value and is only slightly affected by drain current. Please refer to [Figure 2](#) for the RDRV that is matched with the needed slew rate.

Switching Parameters (continued)

7.1.4 Turn-on and Turn-off Energy

The turn-on and turn-off energy, shown in [Figure 8](#), represent the energy absorbed by the low-side device during the turn-on and turn-off transients of the circuit in [Figure 11](#), respectively. As this circuit represents a synchronous buck converter, with input shorted to output, the switching energy is dissipated in the low-side device. The turn-on transition is lossy, while the turn-off transition is essentially lossless; the output capacitance of the devices is charged by the inductor current. The turn-on and turn-off losses have been calculated from experimental waveforms by integrating the product of the drain current with the drain-source voltage over the turn-on and turn-off times, respectively. The skew of probes for voltage and current are very important for accurate measurement of turn-on and turn-off energy.

The switching loss of the converter can be determined by adding the turn-on and turn-off energy in [Figure 8](#), adjusting for the R_{DRV} value (shown in [Figure 9](#)). To obtain the switching loss, multiply this value by the switching frequency. The obtained loss is a sum of the V-I overlap loss (due to hard switching) and the loss caused by charging and discharging the C_{OSS} of both devices. Additional test-fixture capacitance, including PCB and inductor intra-winding capacitance, has not been removed from these measurements.

8 Detailed Description

8.1 Overview

LMG341xR070 is a high-performance 600-V GaN transistor with integrated gate driver. The GaN transistor provides ultra-low input and output capacitance and zero reverse recovery. The lack of reverse recovery enables efficient operation in half-bridge and bridge-based topologies.

TI utilizes a Direct Drive architecture to control the GaN FET within the LMG341xR070. When the driver is powered up, the GaN FET is controlled directly with the integrated gate driver. This architecture provides superior switching performance compared with the traditional cascode approach.

The integrated driver solves a number of challenges using GaN devices. The LMG341xR070 contains a driver specifically tuned to the GaN device for fast driving without ringing on the gate. The driver ensures the device stays off for high drain slew rates up to 150 V/ns. In addition, the integrated driver protects against faults by providing over-current and over-temperature protection. This feature can protect the system in case of a device failure, or prevent a device failure in the case of a controller error or malfunction. LMG3410R070 and LMG3411R070 have the same design and features, except the handling of OCP events. LMG3410R070 adopts a latch-off strategy at OCP events, while LMG3411R070 can realize cycle-by-cycle current limit function. Please refer to [Fault Detection](#) for more details.

Unlike silicon MOSFETs, there is no p-n junction from source to drain in GaN devices. That is why GaN devices have no reverse recovery losses. However, the GaN device can still conduct from source to drain in 3rd quadrant of operation similar to a body diode but with higher voltage drop and higher conduction loss. 3rd quadrant operation can be defined as follows; when the GaN device is turned off and negative current pulls the drain node voltage to be lower than its source. The voltage drop across GaN device during 3rd quadrant operation is high; therefore, it is recommended to operate with synchronous switching and keep the duration of 3rd quadrant operation at minimum.

8.2 Functional Block Diagram

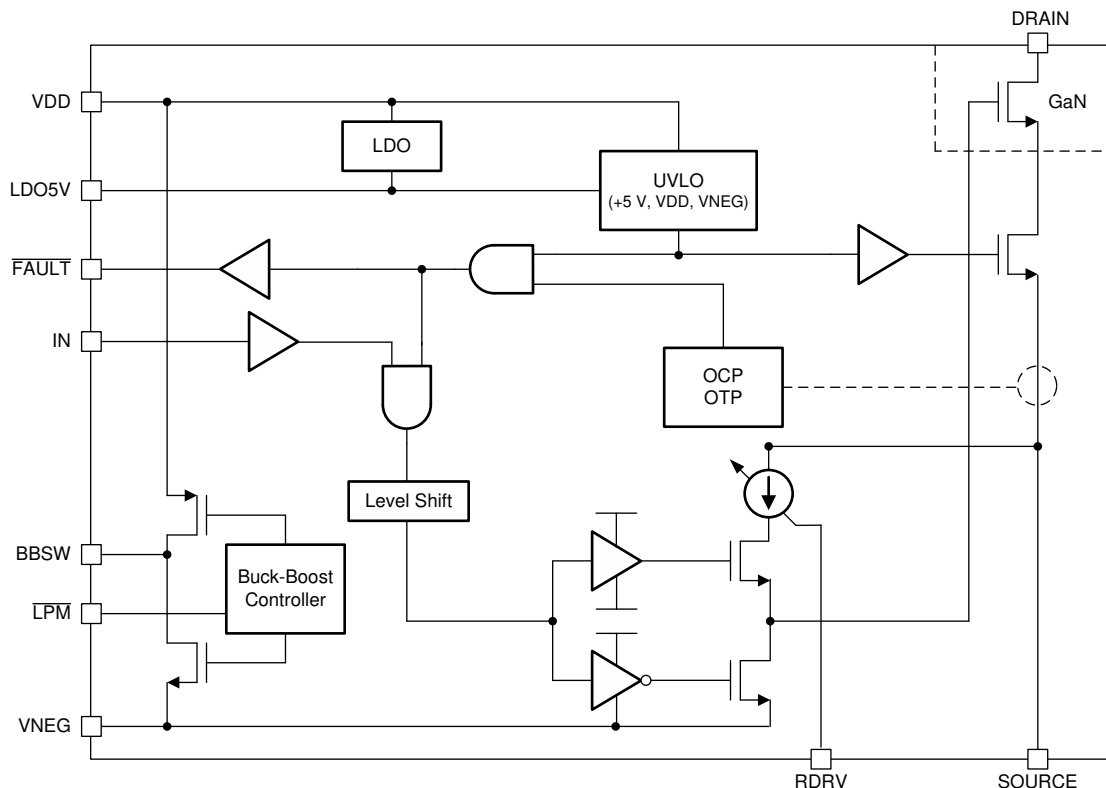

8.3 Feature Description

The LMG341xR070 includes numerous features to provide increased switching performance and efficiency in customers' applications while providing an easy-to-use solution.

8.3.1 Direct-Drive GaN Architecture

The LMG341xR070 utilizes a series FET to ensure the GaN module stays off when V_{DD} is not applied. When this FET is off, the gate of the GaN transistor is held within a volt of the FET's source. As the silicon FET blocks the drain voltage, the V_{GS} of the GaN transistor decreases until it passes its threshold voltage. Then, the GaN transistor turns off and blocks the remaining drain voltage.

When the LMG341xR070 is powered up, the internal buck-boost converter generates a negative voltage (V_{NEG}) that is sufficient to directly turn off the GaN transistor. In this case, the silicon FET is held on and the GaN transistor is gated directly with the negative voltage. During operation, this removes the switching loss of silicon FET.

8.3.2 Internal Buck-Boost DC-DC Converter

An internal inverting buck-boost converter generates a regulated negative rail for the turn-off supply of the GaN device. The buck-boost converter is controlled by a peak current mode, hysteretic controller. In normal operation, the converter remains in discontinuous-conduction mode, but may enter continuous-conduction mode during startup and overload conditions. The converter is controlled internally and requires only a single surface-mount inductor and output bypass capacitor. For recommendations on the required passives, see [Buck-Boost Converter Design](#).

8.3.3 Internal Auxiliary LDO

An internal low-dropout regulator is provided to supply external loads, such as digital isolators for the high-side drive signal. It is capable of delivering up to 5 mA to an external load. A bypass capacitor with 1 μ F typical is required for stability.

8.3.4 Fault Detection

The GaN driver includes built-in over-current protection (OCP), over-temperature protection (OTP) and under voltage lockout (UVLO).

8.3.4.1 Over-current Protection

The OCP circuit monitors the LMG341xR070's drain current and compares that current signal with an internally-set limit. Upon detection of the over-current, the family of GaN FETs has two optional protection actions: 1) latched overcurrent protection; and 2) cycle-by-cycle overcurrent protection.

LMG3410R070 provides 1) latched OCP option, by which the FET is shut off and held off until the fault is reset by either holding the IN pin low for more than 350 microseconds or removing power from VDD.

LMG3411R070 provides 2) cycle-by-cycle cycle-by-cycle OCP option. In this mode, the FET is also shut off when overcurrent happens, but the output fault signal will clear after the input PWM goes low. In the next cycle, the FET can turn on as normal. The cycle-by-cycle function can be used in cases where steady state operation current is below the OCP level but transient response can still reach high current, while the circuit operation cannot be paused. It also prevents the power stage from overheating by having overcurrent induced conduction loss.

During cycle-by-cycle operation, after the current reaches the upper limit but the PWM input is still high, the load current can flow through the third quadrant of the other FET of a half-bridge with no synchronous rectification. The extra high negative voltage drop ($-6V$ to $-8V$) from drain to source could lead to high third quadrant loss, similar to dead time loss but with much longer time. An operation scheme of cycle-by-cycle current limitation is shown as [Figure 13](#). Therefore, it is critical to design the control scheme to make sure the number of switching cycles in cycle-by-cycle mode is limited, or to change PWM input based on the fault signal to shorten the time in third quadrant conduction mode of the power stage.

OCP circuit has a 20ns typical blanking time at slew rate of 100V/ns to prevent false triggering during switch node transitions. The blanking time increases with respect to lower slew rates accordingly since lower slew rates results in longer switching transition time. This fast response OCP circuit protects the GaN device even under a hard short-circuit condition.

Feature Description (continued)

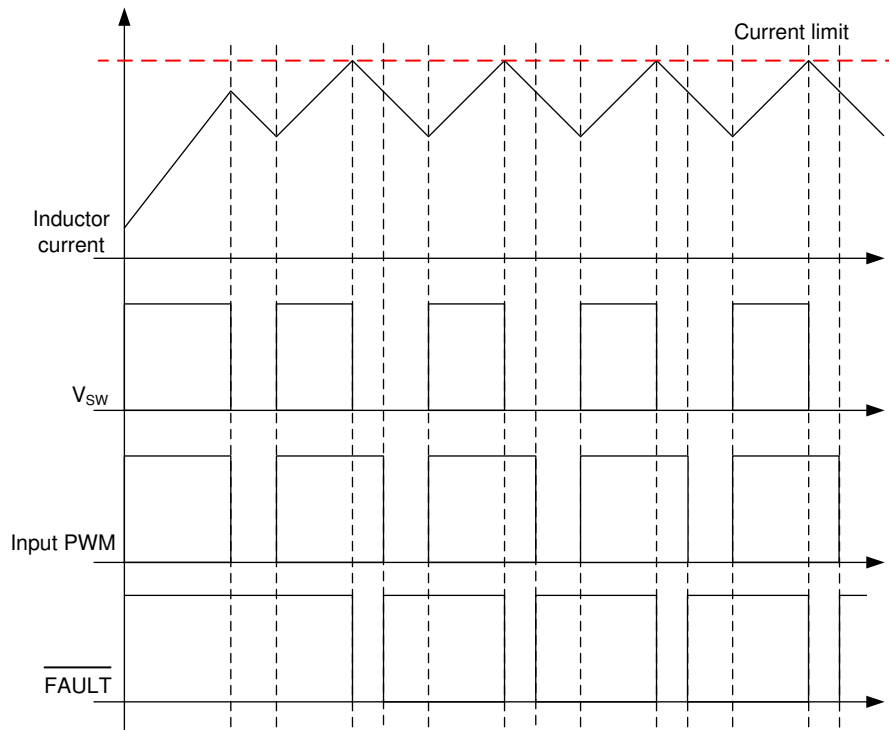

Figure 13. Cycle-by-cycle OCP Operation

8.3.4.2 Over-Temperature Protection and UVLO

The over-temperature protection circuit measures the temperature of the driver die and trips if the temperature exceeds the over-temperature threshold (typically 165 °C). Upon an over-temperature condition, the GaN device is held off until temperature falls below the hysteresis limit, typically 15 degrees below the turn-off threshold.

The $\overline{\text{FAULT}}$ output is a push-pull output indicating the readiness and fault status of the driver. It is held low when starting up until the safety FET is turned on. In an OCP or OTP fault condition, it is held low until the fault latches are reset or fault is cleared. If the power supplies go below the UVLO thresholds, power transistor switching is disabled and $\overline{\text{FAULT}}$ is held low until the power supplies recover.

8.3.5 Drive Strength Adjustment

To allow for an adjustable slew rate to control stability and ringing in the circuit, as well as an adjustment to pass electro-magnetic compliance (EMC) standards, LMG341xR070 allows the user to adjust its drive strength. A resistor is connected the RDRV pin and ground. The value of the resistor determines the slew rate of the device during turn-on between 30V/ns and 100V/ns; see [Figure 2](#) for the relationship between RDRV and the drain slew rate. The propagation delays vary with RDRV; consult [Figure 1](#) for more details. The turn-off slew rate is dependent on the load current; therefore, it is not controlled.

8.4 Device Functional Modes

8.4.1 Low-Power Mode

In some applications, it is important to reduce quiescent current during low power mode such as start up or burst. The LMP pins reduces the quiescent current to support low power modes. When LPM is pulled low, the supply current in the low-power mode is typically 80 μ A. Once this pin is pulled high, the buck-boost converter will start up and LMG341xR070 will be ready to operate within 1 ms.

9 Application and Implementation

NOTE

Information in the following applications sections is not part of the TI component specification, and TI does not warrant its accuracy or completeness. TI's customers are responsible for determining suitability of components for their purposes. Customers should validate and test their design implementation to confirm system functionality.

9.1 Application Information

The LMG341xR070 is a single-channel GaN power stage targeting high-voltage applications. It targets hard-switched and soft-switched applications running from a 350 V to 480 V bus such as power-factor correction (PFC) applications. As GaN devices such as the LMG341xR070 have zero reverse-recovery charge, they are well-suited for hard-switched half-bridge applications, such as the totem-pole bridgeless PFC circuit. It is also well-suited for resonant DC-DC converters, such as the LLC and phase-shifted full-bridge. As both of these converters utilize the half-bridge building block, this section will describe how to use the LMG341xR070 in a half-bridge configuration.

9.2 Typical Application

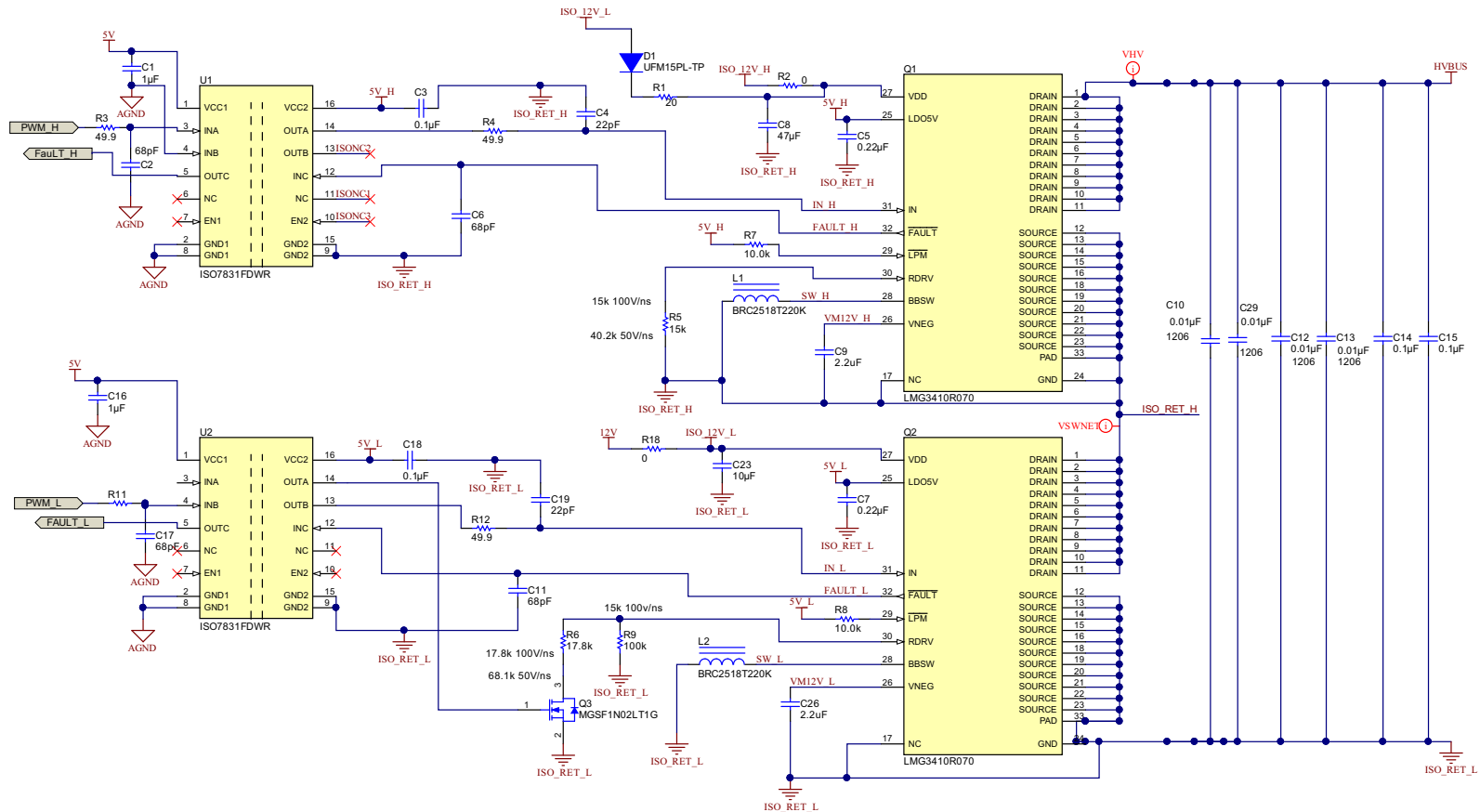

Figure 14. Typical Half-Bridge Application

9.2.1 Design Requirements

This design example is for a hard-switched boost converter which is representative of PFC applications. The system parameters considered are as follows.

Table 1. Design Parameters

DESIGN PARAMETER	EXAMPLE VALUE
Input Voltage	200 VDC
Output Voltage	400 VDC
Input (Inductor) Current	5 A
Switching Frequency	100 kHz

9.2.2 Detailed Design Procedure

In high-voltage power converters, correct circuit design and PCB layout is essential to obtaining a high-performance and even functional power converter. While the general procedure for designing a power converter is out of the scope of this document, this datasheet describes how to utilize the LMG341xR070 to build efficient, well-behaved power converters.

9.2.2.1 Slew Rate Selection

The LMG341xR070 supports slew rate adjustment through connecting a resistor from RDRV to source. The choice of RDRV will control the slew rate of the drain voltage of the device between approximately 25 V/ns and 100 V/ns. The slew rate adjustment is used to control the following aspects of the power stage:

- Switching loss in a hard-switched converter
- Radiated and conducted EMI generated by the switching stage
- Interference elsewhere in the circuit coupled from the switch node
- Voltage overshoot and ringing on the switch node due to power loop inductance and other parasitics

When increasing the slew rate, the switching power loss will decrease, as the portion of the switching period where the switch simultaneously conducts high current while blocking high voltage is decreased. However, by increasing the slew rate of the device, the other three aspects of the power stage get worse. Following the design recommendations in this datasheet will help mitigate the system-related challenges related to high slew rate. Ultimately, it is up to the power designer to ensure the chosen slew rate provides the best performance in his or her end application.

9.2.2.1.1 Startup and Slew Rate with Bootstrap High-Side Supply

Using a bootstrap supply for the high-side LMG341xR070 places additional constraints on the startup of the circuit. Before the high-side LMG341xR070 functions correctly, its VDD, LDO5V and VNEG power supplies must start up and be functional. Prior to the device powering up, the GaN device operates in cascode mode with reduced performance. In particular, under high drain slew rate (dv/dt), the transistor can conduct to a small extent and cause additional power dissipation. The correct startup procedure for a bootstrap-supplied half-bridge depends on the circuit used.

In a buck converter without pre-bias, where the initial output voltage is zero, the startup procedure is straightforward. In this case, before switching begins, turn on the low-side device to allow the high-side bootstrap transistor to charge up. When the $\overline{\text{FAULT}}$ signal goes high, the high-side device has powered up completely, and normal switching can begin.

In a boost converter or a buck converter with a pre-biased output, it is necessary to operate the circuit in switching PWM mode while the high-side LMG341xR070 is powering up. With a boost converter, if the low-side device is held on, the power inductor current will likely run away and the inductor will saturate. To start up a boost converter, the duty cycle has to be very low and gradually increase to charge the output to the desired value without the inductor current reaching saturation. This pulse sequence can be performed open-loop or using a current-mode controller. This startup mode is standard for boost-type converters.

However, with the LMG341xR070, during the boost converter startup, significant shoot-through current can occur for high drain slew rates while starting up. This shoot-through current is approximately $1.25 \mu\text{C}$ per switching event at 50 V/ns , and is comparable to a reverse-recovery event. If this shoot-through current is undesirable, the drain slew rate of the low-side device must be reduced during startup. In Figure 14, the FAULT output from the high-side device is used to gate MOSFET Q1. When FAULT from the high-side is high, once the device is powered up, Q1 turns on and reduces the effective resistance connected to RDRV on the low-side LMG341xR070. With this circuit, the dv/dt of the low-side device can be held low to reduce power dissipation and reduce ringing during high-side startup, but then increase to reduce switching loss during normal operation.

9.2.2.2 Signal Level-Shifting

As the LMG341xR070 is a single-channel power stage, two devices are used to construct a half-bridge converter, such as the one shown in Figure 14. A high-voltage level shifter or digital isolator must be used to provide signals to the high-side device. Using an isolator for the low-side device is optional but will equalize propagation delays between the high-side and low-side signal path, as well as providing the ability to use different grounds for the power stage and the controller. If an isolator is not used on the low-side device, the control ground and the power ground must be connected at the LMG341xR070, as described in [Layout Guidelines](#), and nowhere else on the board. With the high current slew rate of the fast-switching GaN device, any ground-plane inductance common with the power path may cause oscillation or instability in the power stage without the use of an isolator.

Choosing a digital isolator for level-shifting is an important consideration for fault-free operation. Because GaN switches very quickly, exceeding 50 V/ns in hard-switching applications, isolators with high common-mode transient immunity (CMTI) are required. If an isolator suffers from a CMTI issue, it can output a false pulse or signal which can cause shoot-through. In addition, choosing an isolator that is not edge-triggered can improve circuit robustness. In an edge-triggered isolator, a high dv/dt event can cause the isolator to flip states and cause circuit malfunctioning.

On/off keyed isolators are preferred, such as the TI ISO78xxF series, as a high CMTI event would only cause a short (few nanosecond) false pulse, which can be filtered out. To allow for filtering of these false pulses, an R-C filter at the driver input is recommended to ensure these false pulses can be filtered. If issues are observed, values of $1 \text{ k}\Omega$ and 22 pF can be used to filter out any false pulses.

9.2.2.3 Buck-Boost Converter Design

The Buck-boost converter generates the negative voltage necessary to turn off the direct-drive GaN FET. While it is controlled internally, it requires an external power inductor and output capacitor. The converter is designed to use a $22 \mu\text{H}$ inductor and a $2.2 \mu\text{F}$ output capacitor. As the peak current of the buck-boost is limited to less than 350 mA , the inductor chosen must have a saturation current above 350 mA . A Taiyo-Yuden BRC2518T220K $22 \mu\text{H}$ SMT inductor in a 0806 package is recommended. This inductor is connected between the BBSW pin and ground. A $2.2 \mu\text{F}$, 25V 0805 bypass capacitor is required between V_{NEG} and ground. Due to the voltage coefficient of X7R capacitors, a $2.2 \mu\text{F}$ capacitor will provide the required minimum $1.0 \mu\text{F}$ capacitance when operating.

9.2.3 Application Curves

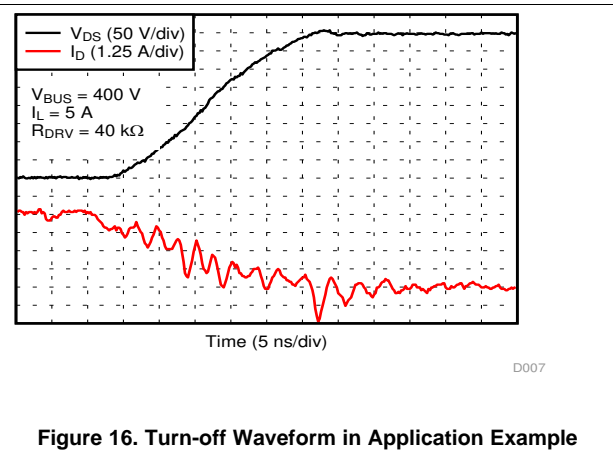
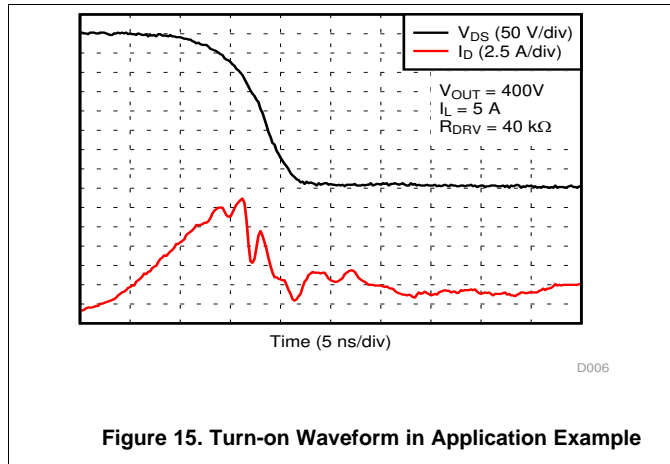

9.3 Paralleling GaN Devices

LMG341xR070s can be paralleled directly in soft-switching applications. As for hard-switching applications, small decoupling inductors should be utilized to parallel the two half-bridge LMG341xR070s. This type of setup prevents current and thermal unbalances among the parallel devices due to any propagation delay and gate-source threshold voltage mismatches, and other factors.

9.4 Do's and Don'ts

The successful use of GaN devices in general and the LMG341xR070 in particular depends on proper use of the device. When using the LMG341xR070, **DO**:

- Read and fully understand the datasheet, including the application notes and layout recommendations
- Use a four-layer board and place the return power path on an inner layer to minimize power-loop inductance
- Use small, surface-mount bypass and bus capacitors to minimize parasitic inductance
- Use the proper size decoupling capacitors and locate them close to the IC as described in the [Layout Guidelines](#) section
- Use a signal isolator to supply the input signal for the low side device. If not, ensure the signal source is connected to the signal GND plane which is tied to the power source **only** at the LMG341xR070 IC
- Use the $\overline{\text{FAULT}}$ pin to determine power-up state and to detect over-current and over-temperature events and safely shut off the converter.

To avoid issues in your system when using the LMG341xR070, **DON'T**:

- Use a single-layer or two-layer PCB for the LMG341xR070 as the power-loop and bypass capacitor inductances will be excessive and prevent proper operation of the IC
- Reduce the bypass capacitor values below the recommended values
- Allow the device to experience drain transients above 600 V as they may damage the device
- Allow significant third-quadrant conduction when the device is OFF or unpowered, which may cause overheating. Self-protection feature cannot protect the device in this mode of operation
- Ignore the $\overline{\text{FAULT}}$ pin output.

10 Power Supply Recommendations

The LMG341xR070 requires an unregulated 12-V supply to power its internal driver and fault protection circuitry. The low-side supply can be supplied from the local controller supply. The high-side device's supply must come from an isolated supply or bootstrap supply.

10.1 Using an Isolated Power Supply

Using an isolated power supply to power the high-side device has the advantage that it will work regardless of continued power-stage switching or duty cycle. It can also power the high-side device before power-stage switching begins, eliminating the power-loss concern of switching with an unpowered LMG341xR070 (see [Startup and Slew Rate with Bootstrap High-Side Supply](#) for details). Finally, a properly-selected isolated supply will contribute fewer parasitics to the switching power stage, increasing power-stage efficiency. However, the isolated power supply solution is larger and more expensive than the bootstrap solution.

The isolated supply can be constructed from an output of a flyback or FlyBuck™ converter, or using an isolated power module. When using an unregulated supply, ensure that the input to the LMG341xR070 does not exceed the maximum supply voltage. If necessary, a 18 V zener to clamp the VDD voltage supplied by the isolated power converter. Minimizing the inter-winding capacitance of the isolated power supply or transformer is necessary to reduce switching loss in hard-switched applications.

10.2 Using a Bootstrap Diode

When used in a half-bridge configuration, a floating supply is necessary for the top-side switch. Due to the switching performance of LMG341xR070, *a transformer-isolated power supply is recommended*. With caution, a bootstrap supply can be used with the recommendations in this section.

10.2.1 Diode Selection

LMG341xR070 has no reverse-recovery charge and little output charge. Hard-switched circuits using LMG341xR070 also exhibit high voltage slew rates. A compatible bootstrap diode must exhibit low output charge and, if used in a hard-switching circuit, very low reverse-recovery charge.

For soft-switching applications, the MCC UFM15PL ultra-fast silicon diode can be used. The output charge of 2.7 nC is small in comparison with the switching transistors, so it will have little influence on switching performance. In a hard-switching application, the reverse recovery charge of the silicon diode may contribute an additional loss to the circuit.

For hard-switched applications, a silicon carbide diode can be used to avoid reverse-recovery effects. The Cree C3D1P7060Q SiC diode has an output charge of 4.5 nC and a reverse recovery charge of about 5 nC. There will be some losses using this diode due to the output charge, but these will not dominate the switching stage's losses.

10.2.2 Managing the Bootstrap Voltage

In a synchronous buck, totem-pole PFC, or other converter where the low-side switch occasionally operates in third-quadrant mode, it is important to consider the bootstrap supply. During the dead time, the bootstrap supply charges through a path that includes the third-quadrant voltage drop of the low-side LMG341xR070. This third-quadrant drop can be large, which may over-charge the bootstrap supply in certain conditions. The V_{DD} supply of LMG341xR070 must not exceed 18 V in bootstrap operation.

Using a Bootstrap Diode (continued)

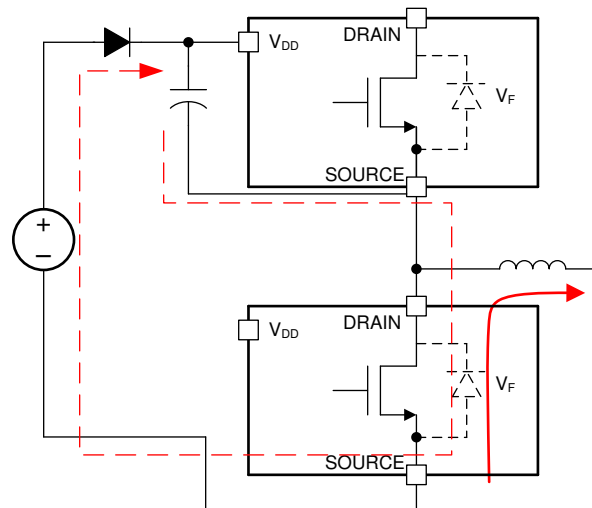

Copyright © 2017, Texas Instruments Incorporated

Figure 17. Charging Path for Bootstrap Diode

The recommended bootstrap supply connection includes a bootstrap diode and a series resistor with an optional zener as shown in [Figure 18](#). The series resistor limits the charging current at startup and when the low-side device is operating in third-quadrant mode. This resistor must be chosen to allow sufficient current to power the LMG341xR070 at the desired operating frequency. At 100 kHz operation, a value of approximately 5.1 ohms is recommended. At higher frequencies, this resistor value should be reduced or the resistor omitted entirely to ensure sufficient supply current.

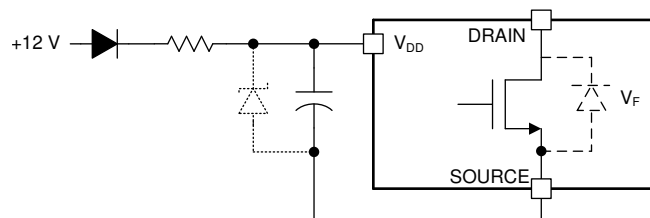

Copyright © 2017, Texas Instruments Incorporated

Figure 18. Suggested Bootstrap Regulation Circuit

Using a series resistor with the bootstrap supply will create a charging time constant in conjunction with the bypass capacitance on the order of a microsecond. When the dead time, or third-quadrant conduction time, is much lower than this time constant, the bootstrap voltage will be well-controlled and the optional zener clamp in [Figure 18](#) will not be necessary. If a large deadtime is needed, a 14-V zener diode can be used in parallel with the V_{DD} bypass capacitor to prevent damaging the high-side LMG341xR070.

10.2.3 Reliable Bootstrap Start-up

In some applications such as boost converter, the low side LMG341xR070 may need to start switching at high frequency while high side LMG341xR070 is not fully biased. If low side GaN device turn-on speed is adjusted to achieve high slew rate, the high side GaN device can turn-on unintentionally as high dv/dt can charge high side GaN device drain to source capacitance. For reliable operation, the slew rate should be slowed down to 30 V/ns by changing the resistance of RDRV pin of the low side LMG341xR070 until high side LMG341xR070's bias is fully settled. This can be monitored through the FAULT output of high side LMG341xR070 as given in [Figure 14](#).

11 Layout

11.1 Layout Guidelines

The layout of the LMG341xR070 is critical to its performance and functionality. Because the half-bridge configuration is typically used with these GaN devices, layout recommendations will be considered with this configuration. A four-layer or higher layer count board is required to reduce the parasitic inductances of the layout to achieve suitable performance.

11.1.1 Power Loop Inductance

The power loop, comprising the two devices in the half bridge and the high-voltage bus capacitance, undergoes large di/dt during switching events. By minimizing the inductance of this loop, ringing and electro-magnetic interference (EMI) can be reduced, as well as reducing voltage stress on the devices.

This loop inductance is minimized by locating the power devices as close together as possible. The bus capacitance is positioned in line with the two devices, either below the low-side device or above the high-side device, on the same side of the PCB. The return path (PGND in this case) is located on the second layer on the PCB in close proximity to the top layer. By using an inner layer and not the bottom layer, the vertical dimension of the loop is reduced, thus minimizing inductance. A large number of vias near both the device terminal and bus capacitance carries the high-frequency switching current to the inner layer while minimizing impedance.

11.1.2 Signal Ground Connection

The LMG341xR070's SOURCE pin is also signal ground reference. The signal GND plane should be connected to SOURCE with low impedance kelvin connection. In addition, the return path for the passives associated to the driver (e.g. bypass capacitance) must be connected to the GND plane. In [Figure 19](#), local signal GND planes are located on the second copper layer to act as the return for the local circuitry. The local signal GND planes are isolated from the high-current SOURCE plane except the kelvin connection at the source pin through enough low impedance vias.

11.1.3 Bypass Capacitors

The gate drive loop impedance must also be minimized to yield strong performance. Although the gate driver is integrated on package, the bypass capacitance for the driver is placed externally on the PCB board. As the GaN device is turned off to a negative voltage, the impedance of the negative source is included in the crucial turn-off path. As the critical hold-off path passes through this external bypass capacitor attached to V_{NEG} , this capacitor must be located close to the LMG341xR070. In the [Figure 19](#), V_{NEG} bypass capacitors C9 and C26 are located immediately adjacent to the pins on the IC with a direct connection to the SOURCE pin.

The bypass capacitors for the input supply (C8 and C23) and the 5V regulator (C5 and C7) must also be located immediately next to the IC with a close connection to the ground plane.

11.1.4 Switch-Node Capacitance

GaN devices have very low output capacitance and switch quickly with a high dv/dt , yielding very low switching loss. To preserve this low switching loss, additional capacitance added to the output node must be minimized. The PCB capacitance at the switch node can be minimized by following these guidelines:

- Minimize overlap between the switch-node plane and other power and ground planes
- Thin the GND return path under the high-side device somewhat while still maintaining a low-inductance path
- Choose high-side isolator ICs and bootstrap diodes with low capacitance
- Locate the power inductor as close to the power stage as possible
- Power inductors should be constructed with a single-layer winding to minimize intra-winding capacitance
- If a single-layer inductor is not possible, consider placing a small inductor between the primary inductor and the power stage to effectively shield the power stage from the additional capacitance
- If a back-side heat-sink is used, restrict the switch-node copper coverage on the bottom copper layer to the minimum area necessary to extract the needed heat

Layout Guidelines (continued)

11.1.5 Signal Integrity

The control signals to the LMG341xR070 must be protected from the high dv/dt that the GaN power stage produces. Coupling between the control signals and the drain may cause circuit instability and potential destruction. Route the control signals (IN, FAULT and LPM) over a ground plane located on an adjacent layer. For example, in the layout in [Figure 19](#), all the signals are routed on the top layer directly over the signal GND plane on the first inner copper layer.

The signals for the high-side device are often particularly vulnerable. Coupling between these signals and system ground planes could cause issues in the circuit. Keep the traces associated with the control signals away from drain copper. For the high-side level shifter, ensure no copper from either the input or output side extends beneath the isolator or the device's CMTI may be compromised.

11.1.6 High-Voltage Spacing

Circuits using the LMG341xR070 involve high voltage, potentially up to 600V. When laying out circuits using the LMG341xR070, understand the creepage and clearance requirements in your application and how they apply to the power stage. Functional (or working) isolation is required between the source and drain of each transistor, and between the high-voltage power supply and ground. Functional isolation or perhaps stronger isolation (such as reinforced isolation) may be required between the input circuitry to the LMG341xR070 and the power controller. Choose signal isolators and PCB spacing (creepage and clearance) distances which meet your isolation requirements.

If a heatsink is used to manage thermal dissipation of the LMG341xR070, ensure necessary electrical isolation and mechanical spacing is maintained between the heatsink and the PCB.

11.1.7 Thermal Recommendations

The LMG341xR070 is a lateral transistor grown on a Si substrate. The thermal pad is connected to the Source node. The LMG341xR070 may be used in applications with significant power dissipation, for example, hard-switched power converters. In these converters, cooling using just the PCB may not be sufficient to keep the part at a reasonable temperature. To improve the thermal dissipation of the part, TI recommends a heatsink is connected to the back of the PCB to extract additional heat. Using power planes and numerous thermal vias, the heat dissipated in the LMG341xR070(s) can be spread out in the PCB and effectively passed to the other side of the PCB. A heat sink can be applied to bare areas on the back of the PCB using an adhesive thermal interface material (TIM). The soldermask from the back of the board underneath the heatsink can be removed for more effective heat removal.

Please refer to the [High Voltage Half Bridge Design Guide for LMG341x Smart GaN FET](#) application note for more recommendations and performance data on thermal layouts.

11.2 Layout Example

Correct layout of the LMG341xR070 and its surrounding components is essential for correct operation. The layout shown here reflects the power stage schematic in [Figure 14](#). It may be possible to obtain acceptable performance with alternate layout schemes, however this layout has been shown to produce good results and is intended as a guideline.

Layout Example (continued)

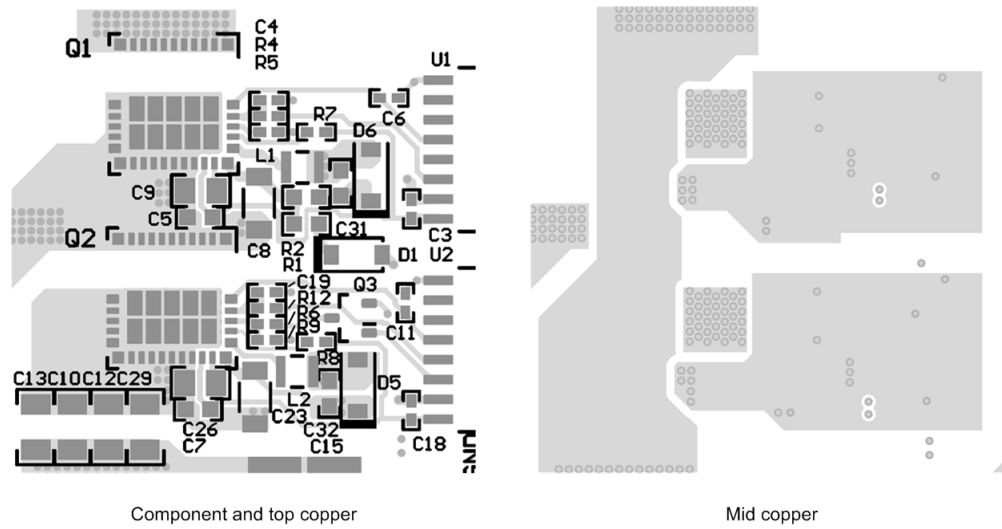

Figure 19. Example Half-Bridge Layout

12 Device and Documentation Support

12.1 Device Support

12.1.1 Third-Party Products Disclaimer

TI'S PUBLICATION OF INFORMATION REGARDING THIRD-PARTY PRODUCTS OR SERVICES DOES NOT CONSTITUTE AN ENDORSEMENT REGARDING THE SUITABILITY OF SUCH PRODUCTS OR SERVICES OR A WARRANTY, REPRESENTATION OR ENDORSEMENT OF SUCH PRODUCTS OR SERVICES, EITHER ALONE OR IN COMBINATION WITH ANY TI PRODUCT OR SERVICE.

12.2 Documentation Support

12.2.1 Related Documentation

[High Voltage Half Bridge Design Guide for LMG3410 Smart GaN FET](#) application note.

12.3 Receiving Notification of Documentation Updates

To receive notification of documentation updates, navigate to the device product folder on ti.com. In the upper right corner, click on *Alert me* to register and receive a weekly digest of any product information that has changed. For change details, review the revision history included in any revised document.

12.4 Community Resources

TI E2E™ [support forums](#) are an engineer's go-to source for fast, verified answers and design help — straight from the experts. Search existing answers or ask your own question to get the quick design help you need.

Linked content is provided "AS IS" by the respective contributors. They do not constitute TI specifications and do not necessarily reflect TI's views; see TI's [Terms of Use](#).

12.5 Trademarks

FlyBuck, E2E are trademarks of Texas Instruments.

12.6 Electrostatic Discharge Caution



These devices have limited built-in ESD protection. The leads should be shorted together or the device placed in conductive foam during storage or handling to prevent electrostatic damage to the MOS gates.

12.7 Glossary

[SLYZ022](#) — *TI Glossary*.

This glossary lists and explains terms, acronyms, and definitions.

13 Mechanical, Packaging, and Orderable Information

The following pages include mechanical, packaging, and orderable information. This information is the most current data available for the designated devices. This data is subject to change without notice and revision of this document. For browser-based versions of this data sheet, refer to the left-hand navigation.

PACKAGING INFORMATION

Orderable Device	Status (1)	Package Type	Package Drawing	Pins	Package Qty	Eco Plan (2)	Lead finish/ Ball material (6)	MSL Peak Temp (3)	Op Temp (°C)	Device Marking (4/5)	Samples
LMG3410R070RWHR	ACTIVE	VQFN	RWH	32	2000	RoHS-Exempt & Green	NIPDAU	Level-3-260C-168HRS	-40 to 150	LMG3410 R070	Samples
LMG3410R070RWHT	ACTIVE	VQFN	RWH	32	250	RoHS-Exempt & Green	NIPDAU	Level-3-260C-168HRS	-40 to 150	LMG3410 R070	Samples
LMG3411R070RWHR	ACTIVE	VQFN	RWH	32	2000	RoHS-Exempt & Green	NIPDAU	Level-3-260C-168HRS	-40 to 150	LMG3411 R070	Samples
LMG3411R070RWHT	ACTIVE	VQFN	RWH	32	250	RoHS-Exempt & Green	NIPDAU	Level-3-260C-168HRS	-40 to 150	LMG3411 R070	Samples

(1) The marketing status values are defined as follows:

ACTIVE: Product device recommended for new designs.

LIFEBUY: TI has announced that the device will be discontinued, and a lifetime-buy period is in effect.

NRND: Not recommended for new designs. Device is in production to support existing customers, but TI does not recommend using this part in a new design.

PREVIEW: Device has been announced but is not in production. Samples may or may not be available.

OBSELETE: TI has discontinued the production of the device.

(2) **RoHS:** TI defines "RoHS" to mean semiconductor products that are compliant with the current EU RoHS requirements for all 10 RoHS substances, including the requirement that RoHS substance do not exceed 0.1% by weight in homogeneous materials. Where designed to be soldered at high temperatures, "RoHS" products are suitable for use in specified lead-free processes. TI may reference these types of products as "Pb-Free".

RoHS Exempt: TI defines "RoHS Exempt" to mean products that contain lead but are compliant with EU RoHS pursuant to a specific EU RoHS exemption.

Green: TI defines "Green" to mean the content of Chlorine (Cl) and Bromine (Br) based flame retardants meet JS709B low halogen requirements of <=1000ppm threshold. Antimony trioxide based flame retardants must also meet the <=1000ppm threshold requirement.

(3) MSL, Peak Temp. - The Moisture Sensitivity Level rating according to the JEDEC industry standard classifications, and peak solder temperature.

(4) There may be additional marking, which relates to the logo, the lot trace code information, or the environmental category on the device.

(5) Multiple Device Markings will be inside parentheses. Only one Device Marking contained in parentheses and separated by a "~" will appear on a device. If a line is indented then it is a continuation of the previous line and the two combined represent the entire Device Marking for that device.

(6) Lead finish/Ball material - Orderable Devices may have multiple material finish options. Finish options are separated by a vertical ruled line. Lead finish/Ball material values may wrap to two lines if the finish value exceeds the maximum column width.

Important Information and Disclaimer:The information provided on this page represents TI's knowledge and belief as of the date that it is provided. TI bases its knowledge and belief on information provided by third parties, and makes no representation or warranty as to the accuracy of such information. Efforts are underway to better integrate information from third parties. TI has taken and

continues to take reasonable steps to provide representative and accurate information but may not have conducted destructive testing or chemical analysis on incoming materials and chemicals. TI and TI suppliers consider certain information to be proprietary, and thus CAS numbers and other limited information may not be available for release.

In no event shall TI's liability arising out of such information exceed the total purchase price of the TI part(s) at issue in this document sold by TI to Customer on an annual basis.

TAPE AND REEL INFORMATION

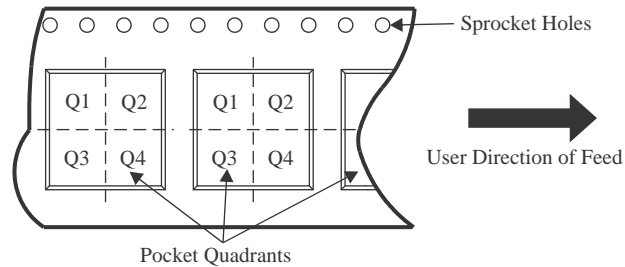
QUADRANT ASSIGNMENTS FOR PIN 1 ORIENTATION IN TAPE

*All dimensions are nominal

Device	Package Type	Package Drawing	Pins	SPQ	Reel Diameter (mm)	Reel Width W1 (mm)	A0 (mm)	B0 (mm)	K0 (mm)	P1 (mm)	W (mm)	Pin1 Quadrant
LMG3410R070RWHR	VQFN	RWH	32	2000	330.0	16.4	8.3	8.3	2.25	12.0	16.0	Q2
LMG3411R070RWHR	VQFN	RWH	32	2000	330.0	16.4	8.3	8.3	2.25	12.0	16.0	Q2

TAPE AND REEL BOX DIMENSIONS

*All dimensions are nominal

Device	Package Type	Package Drawing	Pins	SPQ	Length (mm)	Width (mm)	Height (mm)
LMG3410R070RWHR	VQFN	RWH	32	2000	350.0	350.0	43.0
LMG3411R070RWHR	VQFN	RWH	32	2000	350.0	350.0	43.0

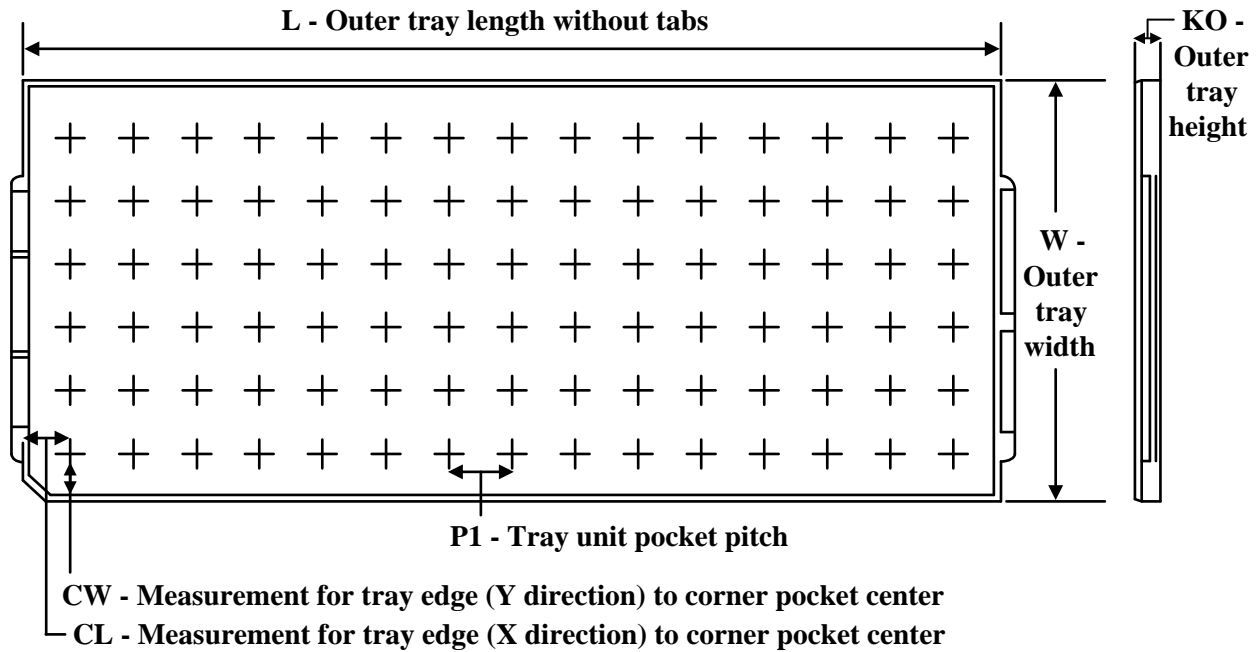
TRAY

Chamfer on Tray corner indicates Pin 1 orientation of packed units.

*All dimensions are nominal

Device	Package Name	Package Type	Pins	SPQ	Unit array matrix	Max temperature (°C)	L (mm)	W (mm)	K0 (µm)	P1 (mm)	CL (mm)	CW (mm)
LMG3410R070RWHR	RWH	VQFN	32	2000	10 x 26	150	315	135.9	7620	11.8	10	10.35
LMG3410R070RWHT	RWH	VQFN	32	250	10 x 26	150	315	135.9	7620	11.8	10	10.35
LMG3411R070RWHR	RWH	VQFN	32	2000	10 x 26	150	315	135.9	7620	11.8	10	10.35
LMG3411R070RWHT	RWH	VQFN	32	250	10 x 26	150	315	135.9	7620	11.8	10	10.35

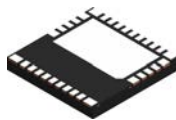

RWH0032A

PACKAGE OUTLINE

VQFN - 1 mm max height

PLASTIC QUAD FLATPACK - NO LEAD

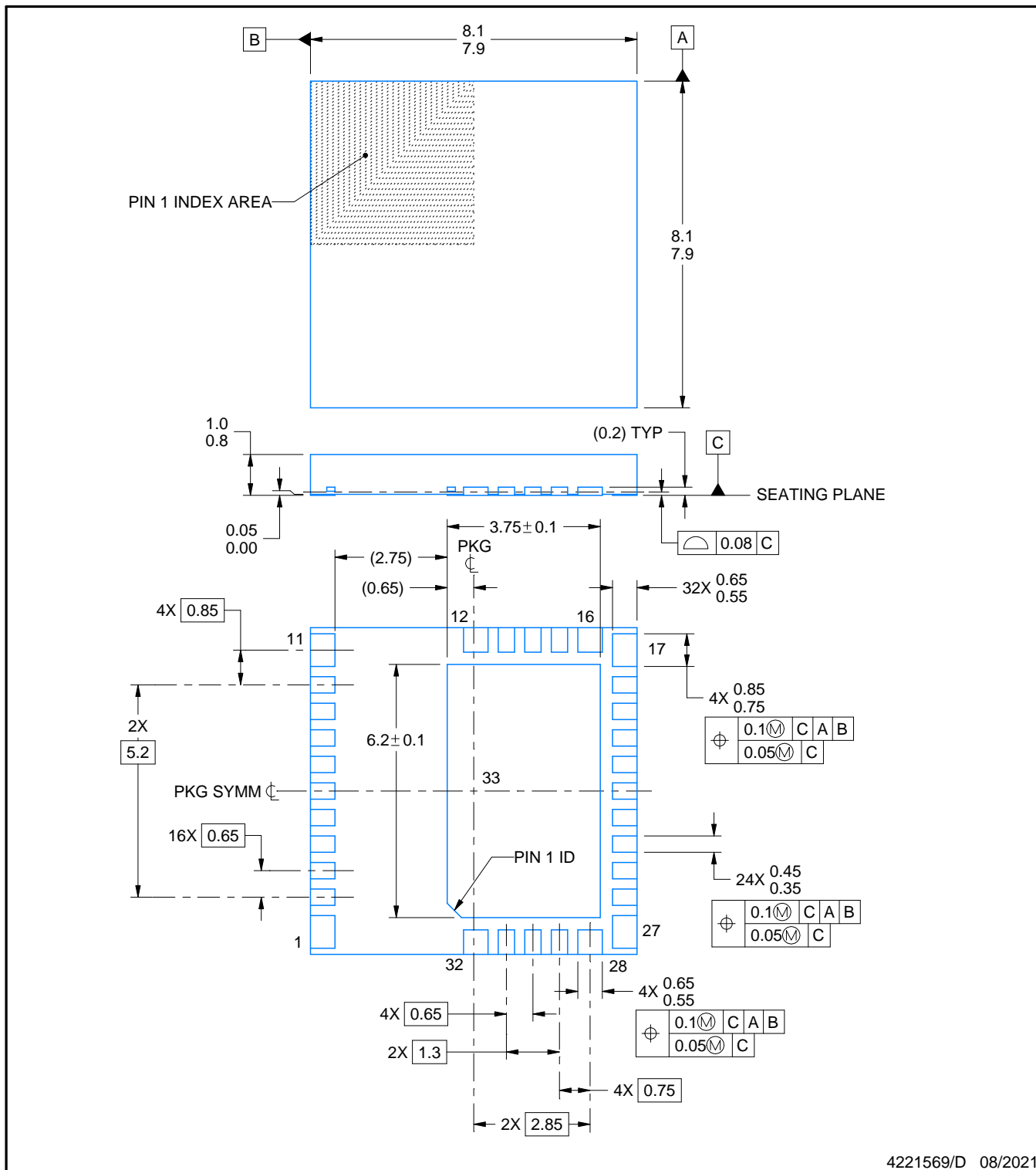

NOTES:

1. All linear dimensions are in millimeters. Any dimensions in parenthesis are for reference only. Dimensioning and tolerancing per ASME Y14.5M.
2. This drawing is subject to change without notice.
3. The package thermal pad must be soldered to the printed circuit board for thermal and mechanical performance.

EXAMPLE BOARD LAYOUT

RWH0032A

VQFN - 1 mm max height

PLASTIC QUAD FLATPACK - NO LEAD

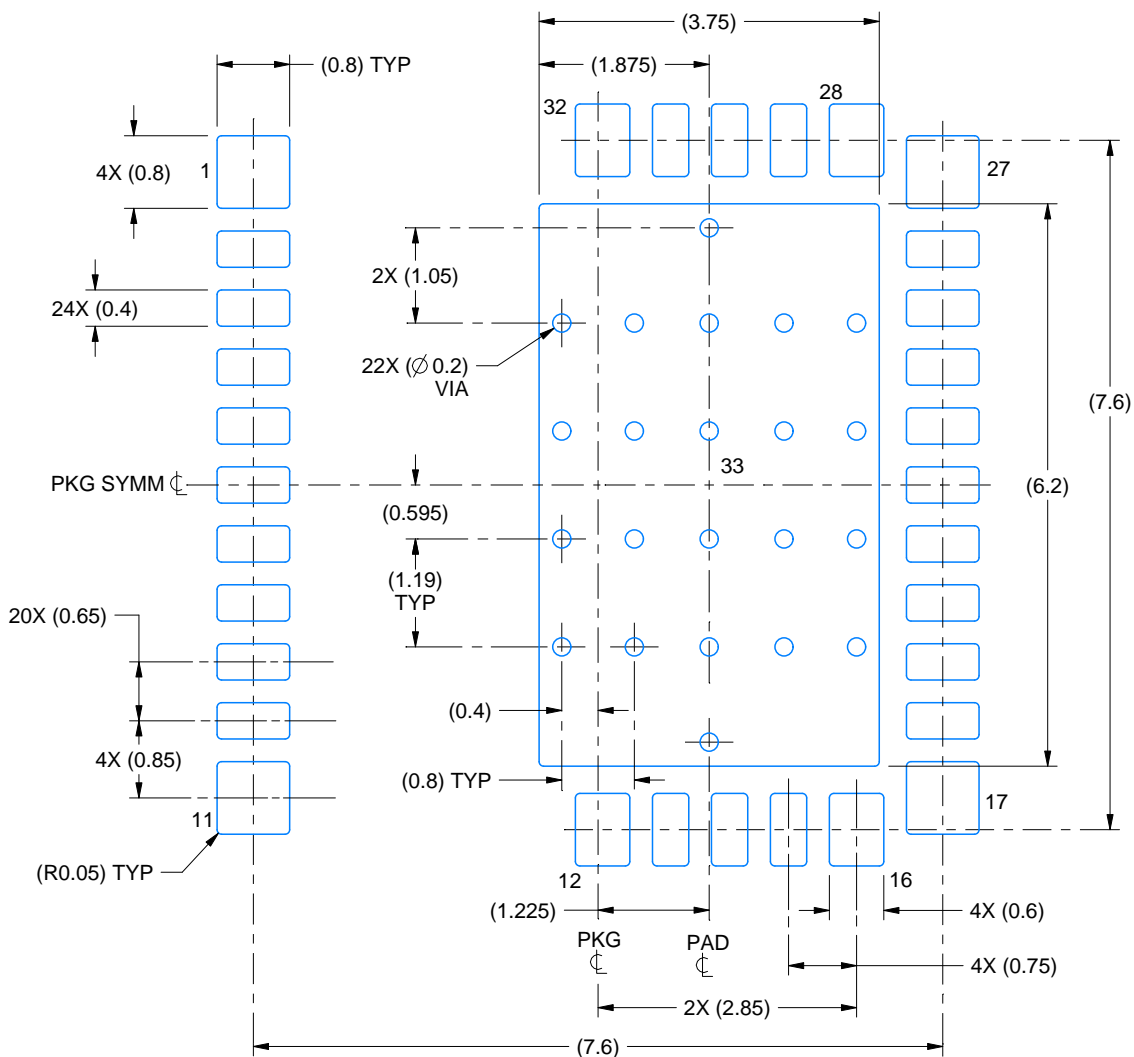

LAND PATTERN EXAMPLE
EXPOSED METAL SHOWN
SCALE:12X

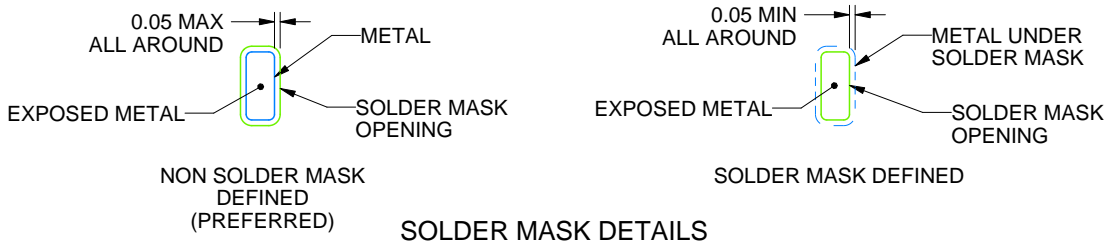

4221569/D 08/2021

NOTES: (continued)

- This package is designed to be soldered to a thermal pad on the board. For more information, see Texas Instruments literature number SLUA271 (www.ti.com/lit/sluea271).
- Vias are optional depending on application, refer to device data sheet. If some or all are implemented, recommended via locations are shown.

EXAMPLE STENCIL DESIGN

RWH0032A

VQFN - 1 mm max height

PLASTIC QUAD FLATPACK - NO LEAD

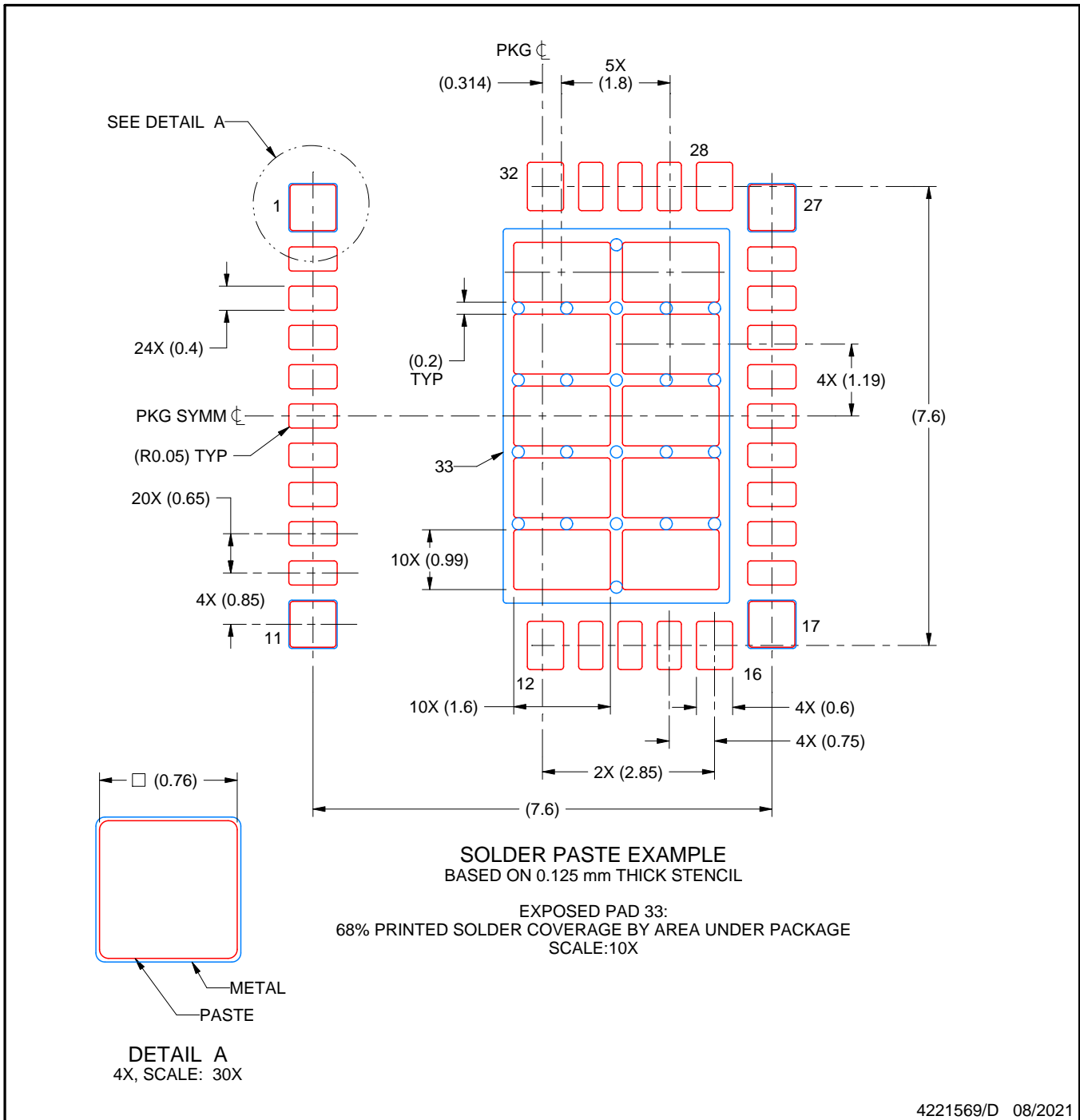

NOTES: (continued)

6. Laser cutting apertures with trapezoidal walls and rounded corners may offer better paste release. IPC-7525 may have alternate design recommendations.

IMPORTANT NOTICE AND DISCLAIMER

TI PROVIDES TECHNICAL AND RELIABILITY DATA (INCLUDING DATA SHEETS), DESIGN RESOURCES (INCLUDING REFERENCE DESIGNS), APPLICATION OR OTHER DESIGN ADVICE, WEB TOOLS, SAFETY INFORMATION, AND OTHER RESOURCES "AS IS" AND WITH ALL FAULTS, AND DISCLAIMS ALL WARRANTIES, EXPRESS AND IMPLIED, INCLUDING WITHOUT LIMITATION ANY IMPLIED WARRANTIES OF MERCHANTABILITY, FITNESS FOR A PARTICULAR PURPOSE OR NON-INFRINGEMENT OF THIRD PARTY INTELLECTUAL PROPERTY RIGHTS.

These resources are intended for skilled developers designing with TI products. You are solely responsible for (1) selecting the appropriate TI products for your application, (2) designing, validating and testing your application, and (3) ensuring your application meets applicable standards, and any other safety, security, regulatory or other requirements.

These resources are subject to change without notice. TI grants you permission to use these resources only for development of an application that uses the TI products described in the resource. Other reproduction and display of these resources is prohibited. No license is granted to any other TI intellectual property right or to any third party intellectual property right. TI disclaims responsibility for, and you will fully indemnify TI and its representatives against, any claims, damages, costs, losses, and liabilities arising out of your use of these resources.

TI's products are provided subject to [TI's Terms of Sale](#) or other applicable terms available either on [ti.com](https://www.ti.com) or provided in conjunction with such TI products. TI's provision of these resources does not expand or otherwise alter TI's applicable warranties or warranty disclaimers for TI products.

TI objects to and rejects any additional or different terms you may have proposed.

Mailing Address: Texas Instruments, Post Office Box 655303, Dallas, Texas 75265
Copyright © 2024, Texas Instruments Incorporated