

# **How to Meet the HDMI 5 V Source Requirement**

Arthur Huang

### **ABSTRACT**

HDMI (High Definition Multimedia Interface) is a connection standard used to transmit high-bandwidth audio and video information between multiple devices. HDMI Standard Guidelines ensure that any connection to an HDMI source remains regulated and protected, whether the output is connected to another HDMI source or sink. This application report provides requirements and recommendations for meeting the 5 V HDMI Source Requirement.

**Table 1. 5 V HDMI Source Solutions**

FEATURE	TPS22948	LM2775	Discrete
Device Topology	Load Switch	Boost Regulator	PTC
Short-Circuit Protection	✓	✓	✓
Reverse Current Blocking	✓	✓	✓
Number of Components (Typical)	1	4	1

### **Contents**

1	Introduction .....	2
2	HDMI Compliance Requirements.....	2
3	HDMI Regulation and Protection using Integrated Circuits .....	4
	3.1 TPS22948 Integrated Load Switch .....	4
	3.2 LM2775 Boost Regulator .....	5
	3.3 PTC .....	6
4	Conclusion .....	7
5	References .....	7

### **List of Figures**

1	5V HDMI Source Block Diagram .....	2
2	5 V Source to Sink Output Protection.....	3
3	Reverse Current Between Two HDMI Sources.....	3
4	Reverse Current When Output is Shorted.....	4
5	TPS22948 5 V Short Circuit Protection .....	5
6	TPS22948 Reverse Current Protection .....	5
7	.....	6
8	PTC Trip Time (sec) Versus Trip Current (A) .....	7

### **Trademarks**

All trademarks are the property of their respective owners.

## 1 Introduction

HDMI has emerged as a standard for high-definition audio and video transmission, and has increased in popularity on platforms such as the following:

- High definition television
- Digital video recorders (DVR)
- Set-top boxes (STB)
- High-resolution personal cameras
- Surround sound audio systems

As multimedia content has grown in popularity, HDMI hardware requirements have been included to ensure that data/power remains within regulation.

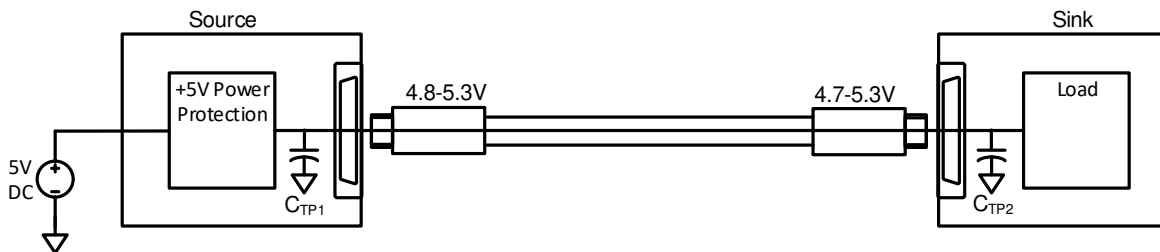

**Figure 1. 5V HDMI Source Block Diagram**

Based on the requirements stated in the HDMI Specifications, compliance requires that HDMI sources follow protection guidelines. [Figure 1](#) highlights a common HDMI application, which is used as an example throughout this application report.

## 2 HDMI Compliance Requirements

In order to ensure a robust HDMI power design, the power rail needs to be regulated in the event of a transient condition. The HDMI 2.1 spec provides full detail of the 5 V regulation requirements. In summary:

The basic requirements for an HDMI source are:

- Output voltage: 4.8 V<sub>min</sub>, 5.3 V<sub>max</sub>
- Short Circuit Current: no more than 0.5 A
- Shorting two HDMI Sources together shall not result in any damage

A sink shall:

- Not draw more than 55 mA from the power signal when powered on
- Assume any voltage within 4.7 V and 5.3 V indicates a source is connected.

Note:

- No damage to the HDMI source or sink can result from the shorting of any combination of signals on any connector. If two HDMI sources are connected together with a single cable, no damage can occur to either of the sources. If two HDMI sinks are connected together with a single cable, no damage can occur to either of the sinks.

Based on these requirements, an ordinary 5 V regulated supply cannot be used. The 5 V power rail must be protected, whether connected to a source or a sink. Depending on whether the HDMI source is connected to a source or a sink, certain transient events can arise.

During the event that the output is connected to an HDMI sink, a potential short can occur along the output path. If the output is not regulated, a short in the cable can cause excessive heat dissipation that can damage the system and create a fire hazard. The 5 V HDMI source needs to be regulated such that if the output line is shorted anywhere to GND, the device can protect the system from the overcurrent event.

In [Figure 2](#), the 5 V HDMI source on the left protects the system in the event of a short on TP1 or TP2.

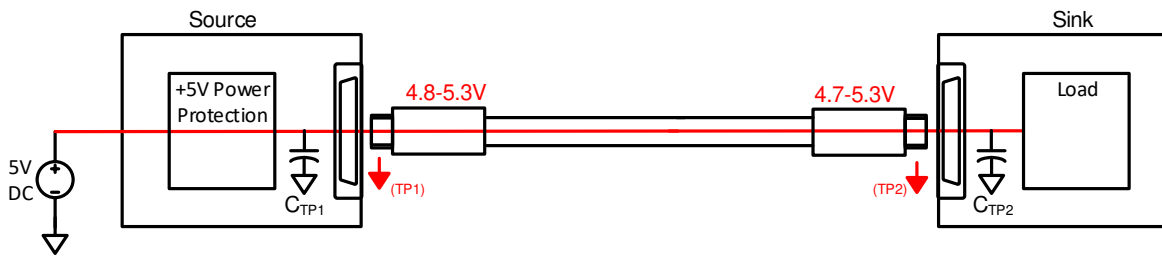

**Figure 2. 5 V Source to Sink Output Protection**

If two HDMI sources are accidentally connected together, the system must protect against any damage to either output. One condition that can arise is a reverse current condition. Since the HDMI voltage specification allows for the output port voltage to be between 4.8 V–5.3 V, there is the possibility that the downstream source is a higher voltage than the upstream source. In this condition, reverse current can potentially flow from the downstream source to the upstream source and damage upstream components. [Figure 3](#) shows an example.

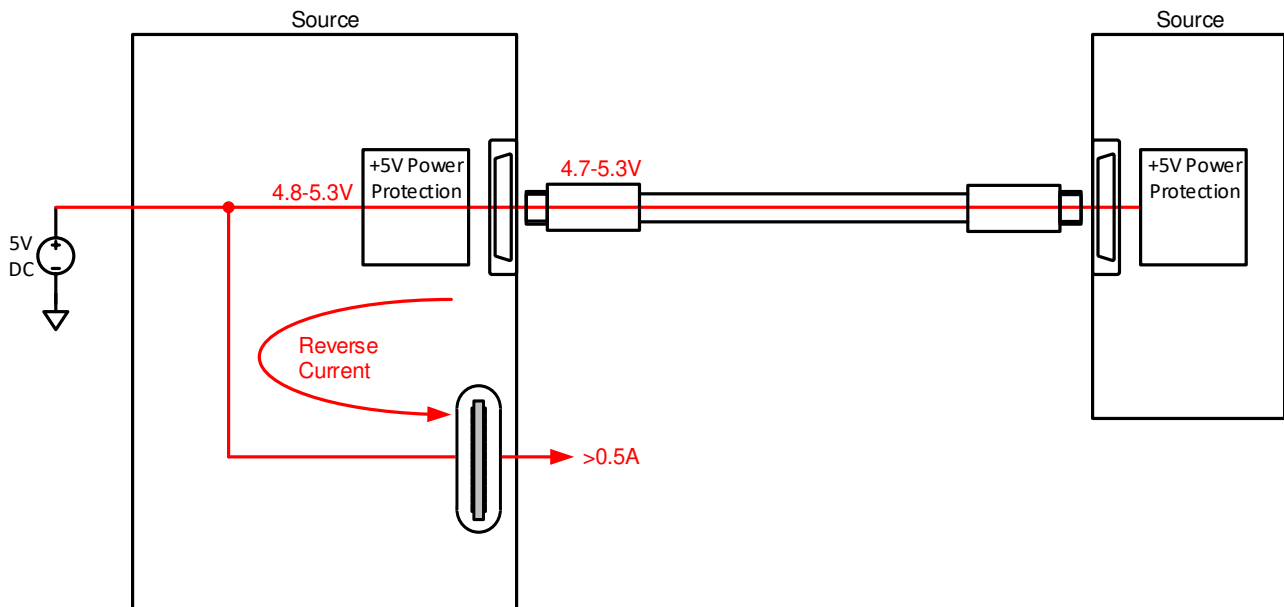

**Figure 3. Reverse Current Between Two HDMI Sources**

The second condition that can arise when connecting two HDMI sources together is an output short to GND. If one source is OFF, there could potentially be an output short to GND, as shown in [Figure 4](#). The 5 V HDMI Protection device must ensure that the system remains protected in this configuration.

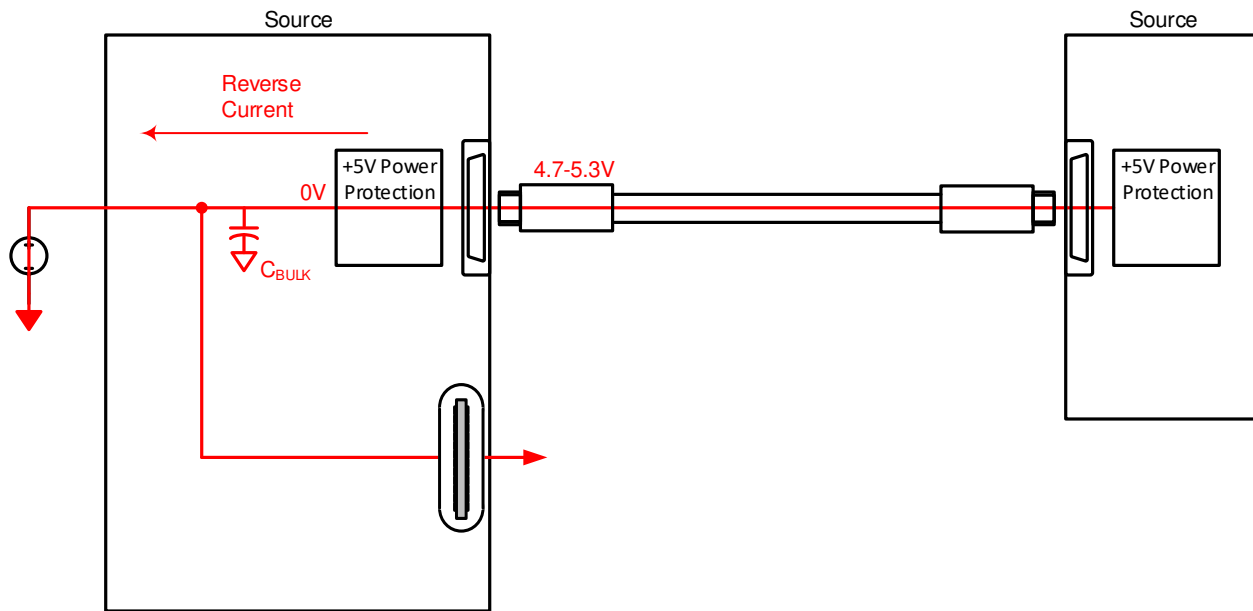
**Figure 4. Reverse Current When Output is Shorted**

### 3 HDMI Regulation and Protection using Integrated Circuits

Texas Instruments provides integrated solutions that can meet the HDMI 5 V Source requirements listed in [Section 2](#).

**Table 2. 5V HDMI Integrated Source Solutions**

FEATURE	TPS22948	LM2775
Device Topology	Load Switch	Boost Regulator
Short-Circuit Protection	✓	✓
Reverse Current Blocking	✓	✓
Number of Components (Typical)	1	4

#### 3.1 TPS22948 Integrated Load Switch

The TPS22948 is a single-channel load switch with robust protection features.

When an overcurrent condition is detected, the TPS22948 responds by limiting the output current and reducing the output voltage. Two possible conditions can occur:

- If the short occurs when the device is powering up, such as turning on the 5 V HDMI source into an output short, the output voltage remains low and the TPS22948 limits the current to 250 mA until the transient event is removed.
- If the short occurs when the device is on, such as connecting a powered-on HDMI source output to GND, then the TPS22948 quickly responds by shutting off the internal power switch. As it retries to turn on, if the short remains then current continues to be limited to 250 mA until the output transient is removed.

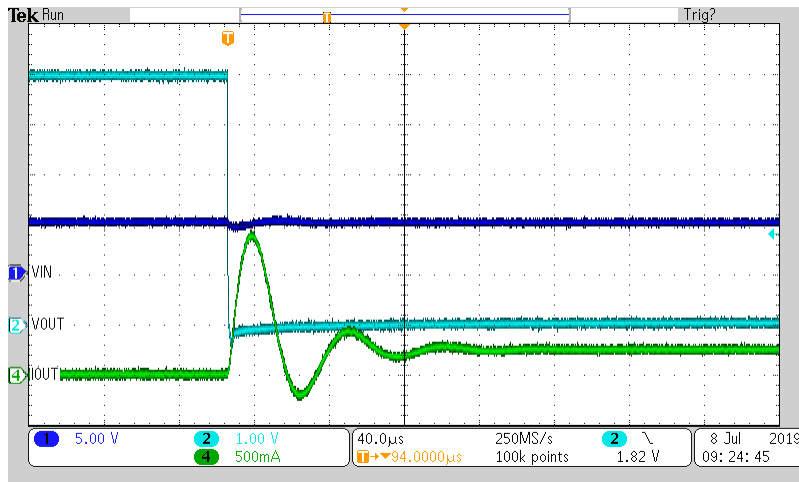

Figure 5. TPS22948 5 V Short Circuit Protection

In a reverse current event, such as when two HDMI sources are connected together, there may be a scenario where VOUT is greater than VIN, which can cause reverse current to flow upstream and possibly damage the system. The TPS22948 measures the reverse current flow by comparing the output and input voltage. Once the reverse current threshold is exceeded, the TPS22948 turns off to stop the reverse current flow. The device remains off and blocks reverse current until the fault condition is removed.

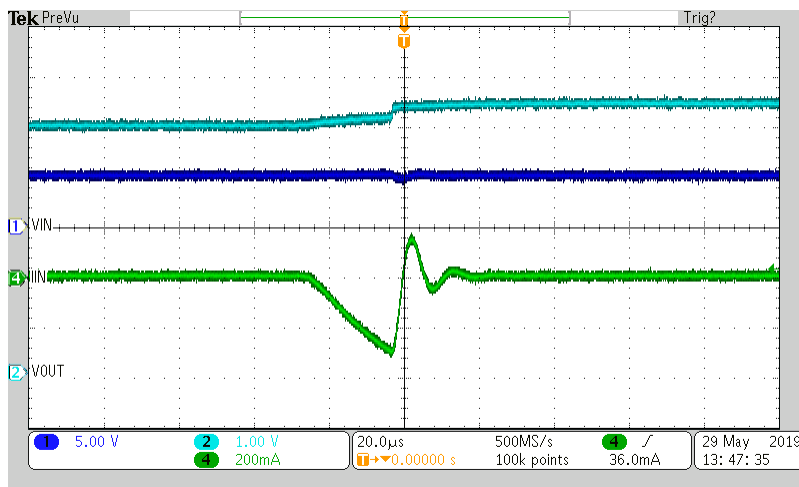

Figure 6. TPS22948 Reverse Current Protection

In any scenario described in Section 2, the TPS22948 protects the 5 V HDMI Source. If the port is connected to a sink that causes an overcurrent condition, such as an output short to GND, then the TPS22948 responds quickly and begins to regulate the output current. If the system is accidentally connected to another HDMI source, the TPS22948 blocks reverse current and protects the upstream system.

### 3.2 LM2775 Boost Regulator

The LM2775 is a regulated switched-capacitor doubler that produces a low-noise output voltage. At low output currents, the LM2775 can reduce the quiescent current by operating in a pulse frequency modulation (PFM) mode. The LM2775 can supply up to 200 mA at 5 V.

In order to meet HDMI protection standards, the LM2775 regulator presents high impedance at the V<sub>OUT</sub> pin when shut down or with no power at the V<sub>IN</sub> pin.

When the LM2775 regulator is operating and supplying 5 V, several protection features may be implemented, depending on the fault condition. If the output is shorted to ground, current limit allows no more than 600 mA to be sourced. If this short is sustained, the device continues to source current until thermal shutdown is reached. If another HDMI source is applied to the output of the LM2775 regulator and that source voltage is below that of the LM2775, then the LM2775 device regulates that voltage up to that of the LM2775. Only enough current is sourced to regulate that voltage up to the LM2775. The LM2775 regulator does not sink current, therefore, if another HDMI source is connected which has a higher voltage, the device acts as though no regulation is needed.

Figure 7 illustrates an example of how the LM2775 boost regulator can be implemented. The device is offered in a 2.0 mm x 2.0 mm package, and requires only three external capacitors. Therefore, by providing a regulated 5 V output, this solution can be implemented with minimal impact to the overall size of the end system.

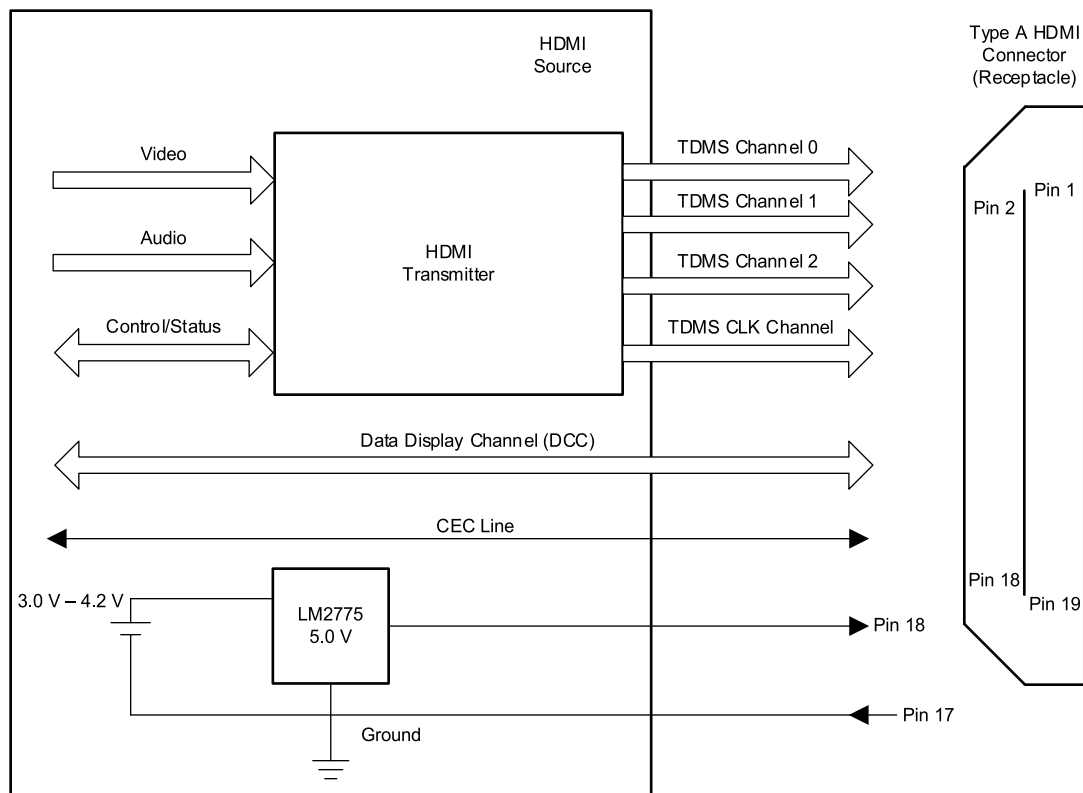

Figure 7.

### 3.3 PTC

There is another way to protect the HDMI port, and that is with a positive temperature coefficient resettable fuse (PTC). While this is a simpler solution than using either the TPS22948 or LM2775, there are several drawbacks, such as a slower response time and degradation after resetting. PTCs operate by increasing the on-resistance as temperature increases. The temperature increase happens during an overcurrent event, but because the response of the PTC is based on this temperature rise, their response time is limited to several milliseconds (as shown in Figure 8).

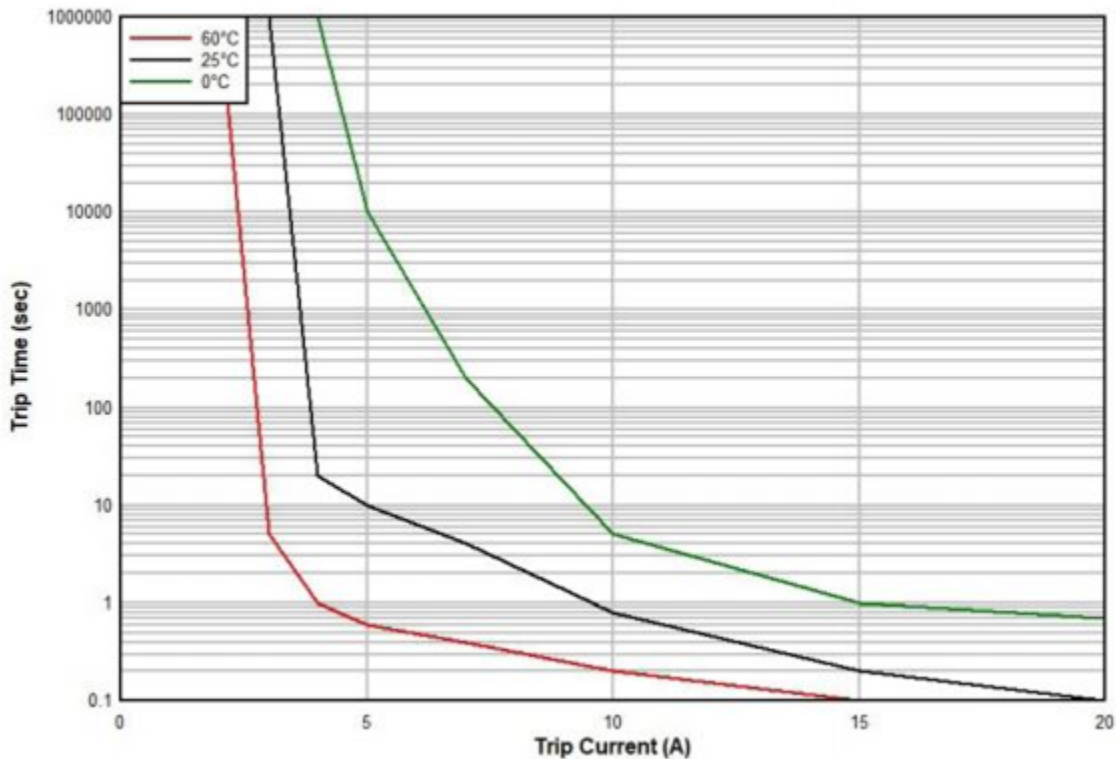

Figure 8. PTC Trip Time (sec) Versus Trip Current (A)

The TPS22948 responds to overcurrent events by monitoring the current rather than the temperature, which allows for a faster response of around 2  $\mu$ s. This fast response time insures that no damage occurs to either the source or sink in overcurrent events.

#### 4 Conclusion

The HDMI 2.1 and prior specifications were developed by the HDMI Forum’s Technical Working Group. In it, they include minimum safety requirements for the +5 V power rail to ensure customers and products are protected against fault conditions. It is the responsibility of HDMI Adopters ([https://www.hdmi.org/learningcenter/adopters\\_founders.aspx#T](https://www.hdmi.org/learningcenter/adopters_founders.aspx#T)) to ensure their products comply with the HDMI Specification and Adopter Agreement. By using an integrated device, such as the TPS22948 or LM2757, the system can be designed to meet the +5 V power rail safety requirements in a compact and space-efficient solution.

#### 5 References

1. *High-Definition Multimedia Interface Specification Version 2.1*
2. Texas Instruments, *11 Ways to Protect Your Power Path*
3. Texas Instruments, *Basics of Power Switches Application Report*
4. Texas Instruments, *Basics of Load Switches Application Note*

## Revision History

NOTE: Page numbers for previous revisions may differ from page numbers in the current version.

<b>Changes from A Revision (April 2013) to C Revision</b>	<b>Page</b>
• Added Discrete column to Table 1. ....	<a href="#">1</a>
• Added section on PTCs. ....	<a href="#">6</a>



## IMPORTANT NOTICE AND DISCLAIMER

TI PROVIDES TECHNICAL AND RELIABILITY DATA (INCLUDING DATASHEETS), DESIGN RESOURCES (INCLUDING REFERENCE DESIGNS), APPLICATION OR OTHER DESIGN ADVICE, WEB TOOLS, SAFETY INFORMATION, AND OTHER RESOURCES "AS IS" AND WITH ALL FAULTS, AND DISCLAIMS ALL WARRANTIES, EXPRESS AND IMPLIED, INCLUDING WITHOUT LIMITATION ANY IMPLIED WARRANTIES OF MERCHANTABILITY, FITNESS FOR A PARTICULAR PURPOSE OR NON-INFRINGEMENT OF THIRD PARTY INTELLECTUAL PROPERTY RIGHTS.

These resources are intended for skilled developers designing with TI products. You are solely responsible for (1) selecting the appropriate TI products for your application, (2) designing, validating and testing your application, and (3) ensuring your application meets applicable standards, and any other safety, security, or other requirements. These resources are subject to change without notice. TI grants you permission to use these resources only for development of an application that uses the TI products described in the resource. Other reproduction and display of these resources is prohibited. No license is granted to any other TI intellectual property right or to any third party intellectual property right. TI disclaims responsibility for, and you will fully indemnify TI and its representatives against, any claims, damages, costs, losses, and liabilities arising out of your use of these resources.

TI's products are provided subject to TI's Terms of Sale ([www.ti.com/legal/termsofsale.html](http://www.ti.com/legal/termsofsale.html)) or other applicable terms available either on [ti.com](http://ti.com) or provided in conjunction with such TI products. TI's provision of these resources does not expand or otherwise alter TI's applicable warranties or warranty disclaimers for TI products.

Mailing Address: Texas Instruments, Post Office Box 655303, Dallas, Texas 75265  
Copyright © 2019, Texas Instruments Incorporated