

AN130 - Using CC2592 Front End With CC2538

James Elliott

ABSTRACT

This application report describes how to implement the CC2538 and the CC2592 in the same design. It further describes the expected performance from this combination as well as important factors to consider with respect to the layout and regulatory requirements. The combined CC2538 and CC2592 solution is suitable for systems targeting compliance with FCC CFR47 Part 15.

Contents

1	Introduction	2
2	Absolute Maximum Ratings	2
3	Electrical Specifications	2
4	Application Circuit.....	9
5	PCB Layout Considerations.....	11
6	Regulatory Requirements	12
7	Controlling the CC2592.....	15
8	References	16
Appendix A	Marker - Delta Method.....	17

List of Figures

1	Output Power vs. Frequency and Power Supply Voltage, TXPOWER = 0xC5	5
2	Output Power vs. Temperature	5
3	Sensitivity vs. Frequency and Power Supply Voltage.....	6
4	Sensitivity vs. Temperature and Power Supply Voltage	6
5	Selectivity Operating at Channel 18 (2440 MHz).....	7
6	RSSI Readout vs. Input Power	7
7	CC2592 Maximum Input Power and CC2538 Output Power vs Temperature	8
8	Conducted Power Spectral Density, TXPOWER = 0xC5, RBW = 100 KHz	9
9	Application Circuit for the CC2538 With CC2592	10
10	Spur DC to Fundamental at 25°C	11
11	Spur DC to Fundamental at -40°C	11
12	Spur Fundamental to 2nd at 25°C	11
13	Spur Fundamental to 2nd at -40°C	11
14	Spur 2nd to 3rd Harmonic at 25°C.....	11
15	Spur 2nd to 3rd Harmonic at -40°C.....	11
16	Conducted Spurious Emission vs. FCC Part 15.247 Limit (TXPOWER = 0xC5, RBW = 1 MHz, VBW = 10 kHz)	14
17	Conducted Spurious Emission, Lower Band Edge (TXPOWER = 0xC5, RBW = 1 MHz, VBW = 10 KHz)	14
18	Conducted Spurious Emission, Upper Band Edge (TXPOWER = 0xC5, RBW = 1 MHz, VBW = 10 KHz)	15
19	CC2538-CC2592 Interconnect	16
20	Band Edge Setup	17

List of Tables

1	Operating Conditions	2
---	----------------------------	---

2	Current Consumption.....	3
3	Receive Parameters.....	3
4	RSSI Compensation.....	3
5	Transmit Parameters.....	4
6	Power Table.....	4
7	Transmit PSD Limits.....	9
8	Summarized FCC 15.247 Regulations for the 2.4 GHz Band.....	13
9	Back-Off Requirement for FCC Part 15.247 Compliance Under Typical Conditions.....	13
10	Control Logic for Connecting the CC2592 to a CC2538 Device.....	15
11	CC2538 Registers for CC2592 Control.....	16

1 Introduction

The CC2538 is TI's ARM® Cortex®-M3 ZigBee®/IEEE 802.15.4 RF System-on-Chip (SoC) for the 2.4 GHz unlicensed ISM band. This chip enables industrial grade applications by offering state-of-the-art selectivity/co-existence, excellent link budget, and low voltage operation.

CC2592 is a range extender for 2.4 GHz RF transceivers, transmitters and SoC products from Texas Instruments. CC2592 increases the link budget by providing a Power Amplifier (PA) for higher output power and a Low Noise Amplifier (LNA) for improved receiver sensitivity. CC2592 contains further RF switches, RF matching, and an on-chip balun for a seamless interface with the CC2538. This allows for simple design of high performance wireless applications.

Texas Instruments ZigBee SW solution, Z-Stack (www.ti.com/z-stack), includes the necessary SW changes for using the CC2592. For details, see the "PA/LNA Service" section in the "HAL Driver API.pdf" in the Z-Stack documents folder, which is located in the Z-stack installation.

2 Absolute Maximum Ratings

The absolute maximum ratings and operating conditions listed in [1] and [2] must be followed at all times. Stress exceeding one or more of these limiting values can cause permanent damage to any of the devices.

3 Electrical Specifications

Note that these characteristics are only valid when using the recommended register settings presented in [Section 3.6](#). For further recommendations, see [Section 7](#).

3.1 CC2538 - Operating Conditions

Table 1. Operating Conditions

Parameter	Min	Max	Unit
Operating Frequency	2405	2483.5	MHz
Operating Supply Voltage	2.0	3.6	V
Operating Temperature	-40	125	°C

CC2538 absolute maximum rating is 3.9 V, CC2592 absolute maximum rating is 3.8 V. The CC2538-CC2592EM has been characterized at a maximum 3.7 V to keep continuity with the CC2592 standalone characterization.

3.2 Current Consumption

$T_C = 25^\circ\text{C}$, $V_{DD} = 3.0\text{ V}$, $f = 2440\text{ MHz}$ if nothing else is stated. All parameters are measured on [3] with a $50\ \Omega$ load.

Table 2. Current Consumption

Parameter	Condition	Typical	Unit
Receive Current	Wait for sync, -90 dBm input level	30	mA
	Wait for sync, -50 dBm input level	26	
Transmit Current	TXPOWER = 0xFF	191	mA
	TXPOWER = 0xED	168	
	TXPOWER = 0xD5	156	
	TXPOWER = 0xC5	142	
	TXPOWER = 0xB6	135	
	TXPOWER = 0xB0	128	
	TXPOWER = 0xA1	116	
	TXPOWER = 0x91	104	
	TXPOWER = 0x88	96	
	TXPOWER = 0x72	88	
	TXPOWER = 0x62	82	
TXPOWER = 0x58	79		
TXPOWER = 0x42	77		
Power Down Current	CC2538 PM2 – CC2592	1.4	μA
Power Down Current	CC2538 PM3 – CC2592	0.5	μA
Power Down Current	CC2592 Standalone	0.1	μA

3.3 Receive Parameters

$T_C = 25^\circ\text{C}$, $V_{DD} = 3.0\text{ V}$, $f = 2440\text{ MHz}$ if nothing else is stated. All parameters are measured on [3] with a $50\ \Omega$ load.

Table 3. Receive Parameters

Parameter	Condition	Typical	Unit
Receive Sensitivity HGM	1 % PER, IEEE 802.15.4 [4] requires -85 dBm	-101	dBm
Receive Sensitivity LGM	1 % PER, IEEE 802.15.4 [4] requires -85 dBm	-99	dBm
Saturation HGM	IEEE 802.15.4 [4] requires -20 dBm	-3	dBm
Saturation LGM	IEEE 802.15.4 [4] requires -20 dBm	-2	dBm
Interferer Rejection	Wanted signal 3 dB above the sensitivity level, IEEE 802.15.4 modulated interferer at IEEE 802.15.4 channels		
	$\pm 5\text{ MHz}$ from wanted signal, IEEE 802.15.4 [4] requires 0 dB	43.5	dB
	$\pm 10\text{ MHz}$ from wanted signal, IEEE 802.15.4 [4] requires 30 dB	46.4	dB
	$\pm 20\text{ MHz}$ from wanted signal. Wanted signal at -82dBm	46.5	dB

3.4 Received Signal Strength Indicator (RSSI)

Due to the external LNA and the offset in the CC2538, the RSSI readouts from the CC2538 - CC2592 are different from RSSI offset values for a standalone CC2538 design. The offset values are shown in Table 4.

Table 4. RSSI Compensation

CC2530-CC2591EM LNA Mode	RSSI Offset ⁽¹⁾
High Gain Mode	85
Low Gain Mode	81

⁽¹⁾ Real RSSI = Register value – RSSI offset.

3.5 Transmit Parameters

$T_C = 25^\circ\text{C}$, $V_{DD} = 3.0\text{ V}$, $f = 2440\text{ MHz}$ if nothing else is stated. All parameters are measured on [3] with a $50\ \Omega$ load. Radiated measurements are done using the PCB antenna.

Table 5. Transmit Parameters

Parameter	Condition	Typical	Unit
Radiated Emission with TXPOWER = 0xC5. Complies with FCC 15.247. See Chapter 7 for more details about regulatory requirements and compliance	Conducted 2•RF (FCC restricted band)	-44.3	dBm
	Conducted 3•RF (FCC restricted band)	-63.9	
	Radiated 2•RF (FCC restricted band)	-47.5	
	Radiated 3•RF (FCC restricted band)	-42	
Max Error Vector Magnitude (EVM)	IEEE 802.15.4 [4] requires maximum 35% Measured as defined by IEEE 802.15.4 [4] Is		
	TXPOWER = 0xFF, $f = \text{IEEE 802.15.4 channels}$	21	%
	TXPOWER = 0xED, $f = \text{IEEE 802.15.4 channels}$	13.8	%
	TXPOWER = 0xD5, $f = \text{IEEE 802.15.4 channels}$	5	%
	TXPOWER = 0xC5 $f = \text{IEEE 802.15.4 channels}$	2.5	%
	TXPOWER = 0xB6 $f = \text{IEEE 802.15.4 channels}$	1.8	%
	TXPOWER = 0xB0, $f = \text{IEEE 802.15.4 channels}$	1.7	%

3.6 Output Power Programming

The RF output power of the CC2538 - CC2592EM is controlled by the 8-bit value in the CC2538 TXPOWER register. Table 6 shows the typical output power and current consumption for the recommended power settings. The results are given for $T_C = 25^\circ\text{C}$, $V_{DD} = 3.0\text{ V}$ and $f = 2440\text{ MHz}$, and are measured on [3] with a $50\ \Omega$ load. For recommendations for the remaining CC2538 registers, see Section 7 or use the settings given by SmartRF™ Studio.

Table 6. Power Table

TXPOWER	Power [dBm]	Current [mA]
0xFF	22	191
0xED	21.5	168
0xD5	20.9	156
0xC5	20.1	142
0xB6	19.6	135
0xB0	19	128
0xA1	17.8	115
0x91	16.4	105
0x88	14.9	96
0x72	13	88
0x62	11	82.5
0x58	9.5	79
0x42	7.5	77

Note that the recommended power settings given in Table 6 are a subset of all the possible TXPOWER register settings. However, using other settings than those recommended might result in sub-optimal performance in areas like current consumption, EVM, and spurious emission. The CC2538 – CC2592 EM has been certified at 0xC5 and for any application requiring 20dBm output power this is recommended.

For applications targeting operation across the full temperature range, Figure 7 indicates that the recommended supply voltage with the 0xC5 power setting is 3 V or higher.

3.7 Typical Performance Curves

$T_C = 25^\circ\text{C}$, $V_{DD} = 3.0\text{ V}$, $f = 2440\text{ MHz}$ if nothing else is stated. All parameters are measured on [3] with a $50\ \Omega$ load.

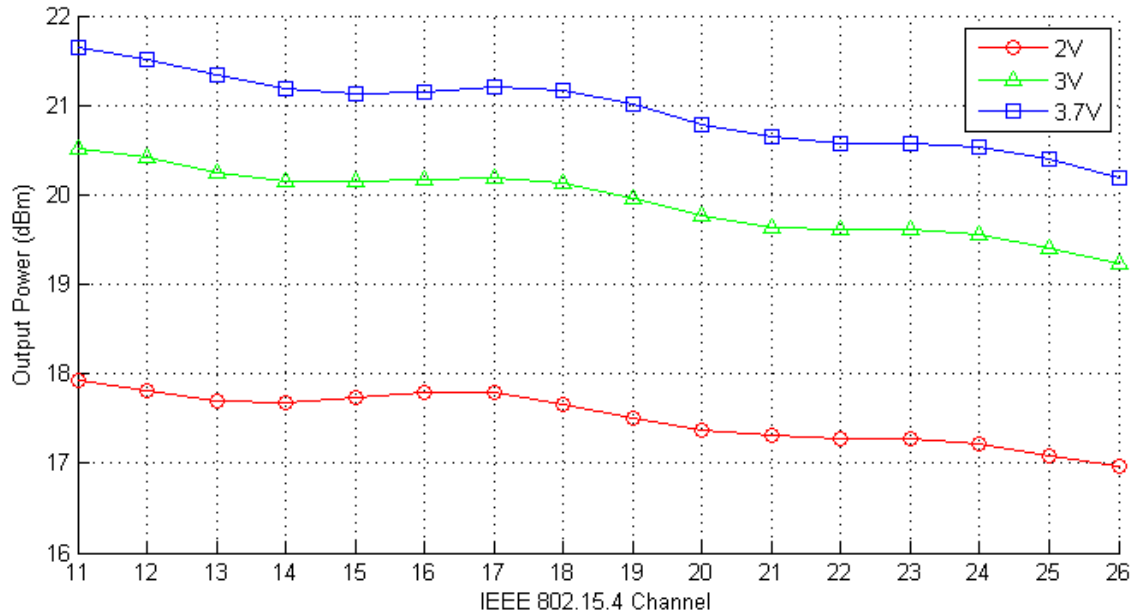

Figure 1. Output Power vs. Frequency and Power Supply Voltage, TXPOWER = 0xC5

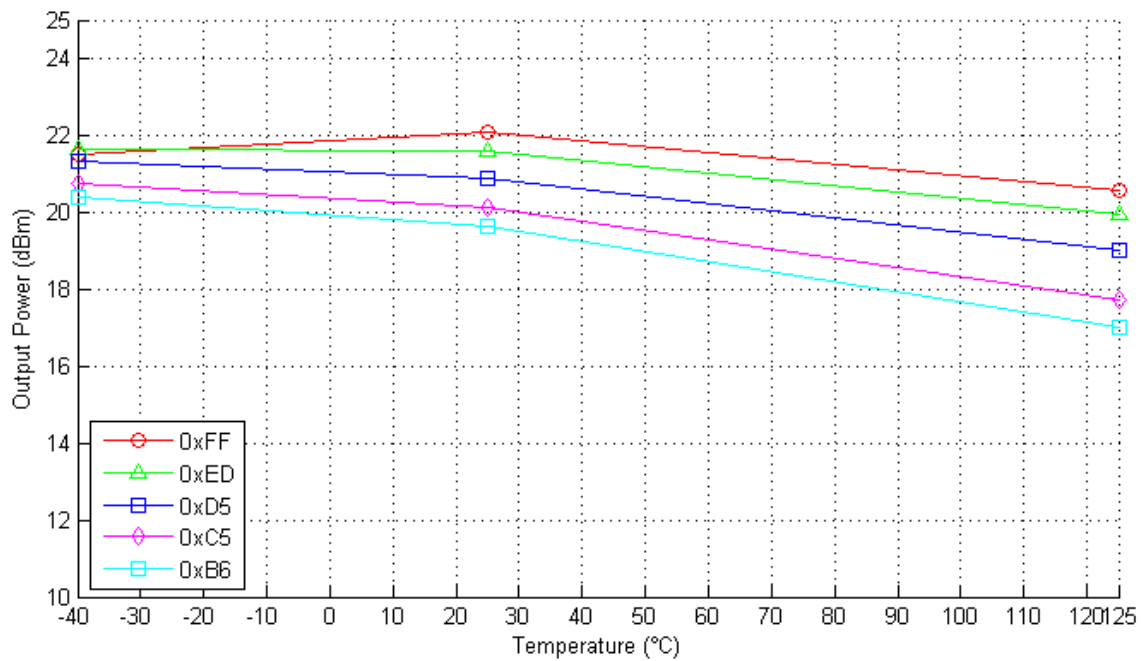

Figure 2. Output Power vs. Temperature

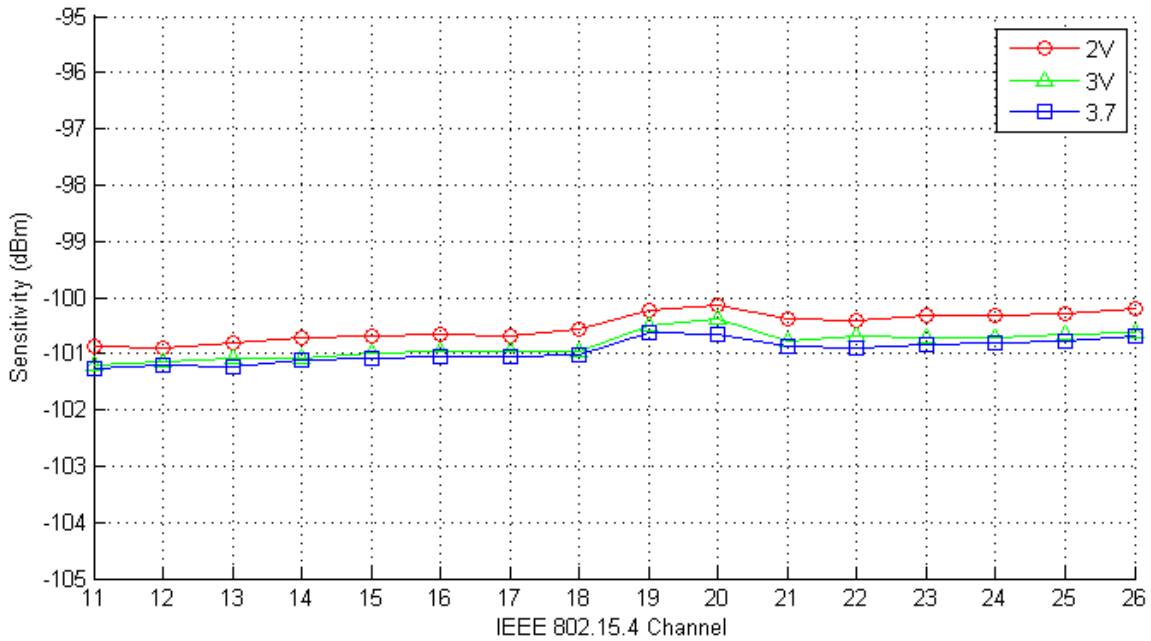

Figure 3. Sensitivity vs. Frequency and Power Supply Voltage

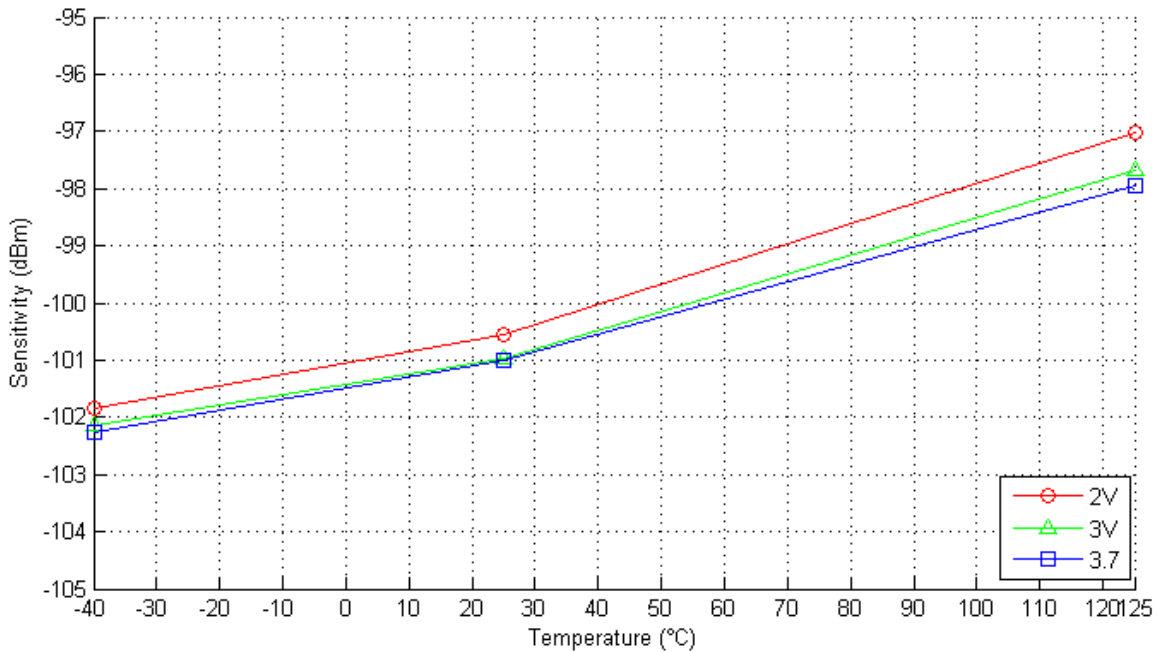

Figure 4. Sensitivity vs. Temperature and Power Supply Voltage

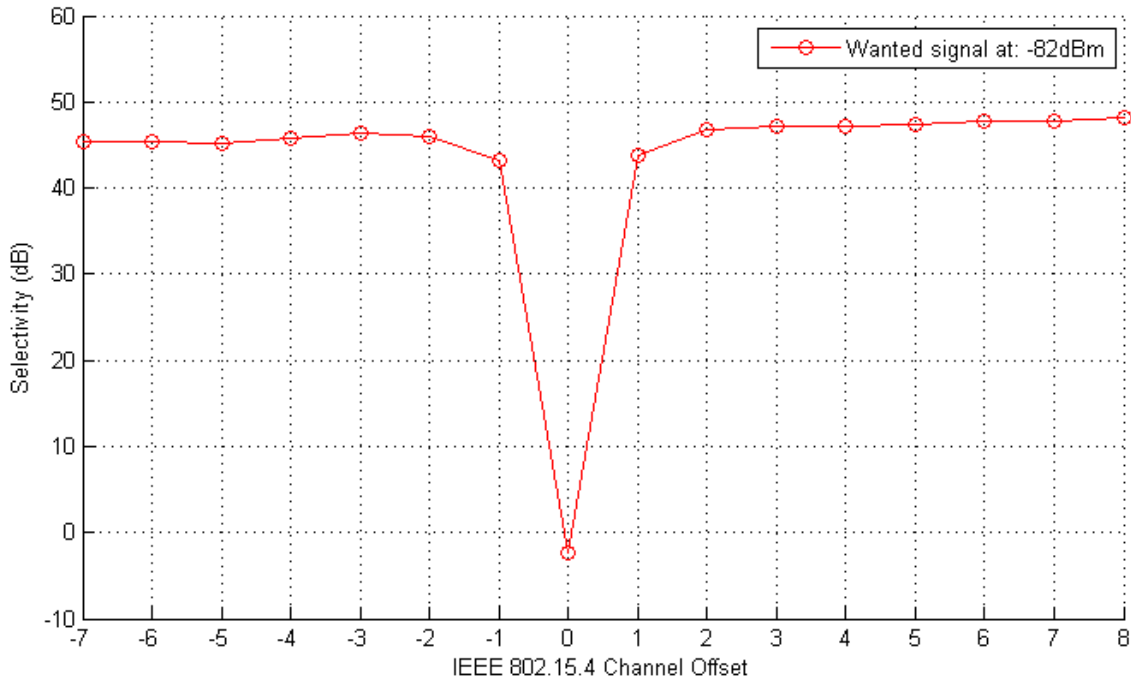

Figure 5. Selectivity Operating at Channel 18 (2440 MHz)

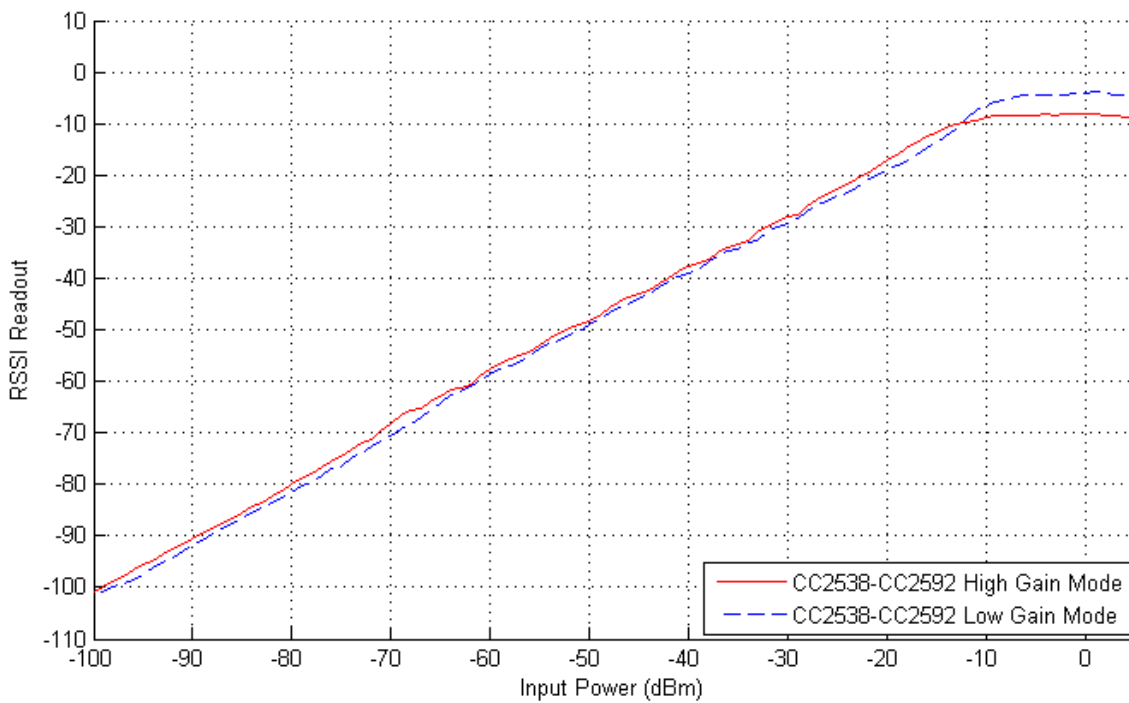

Figure 6. RSSI Readout vs. Input Power

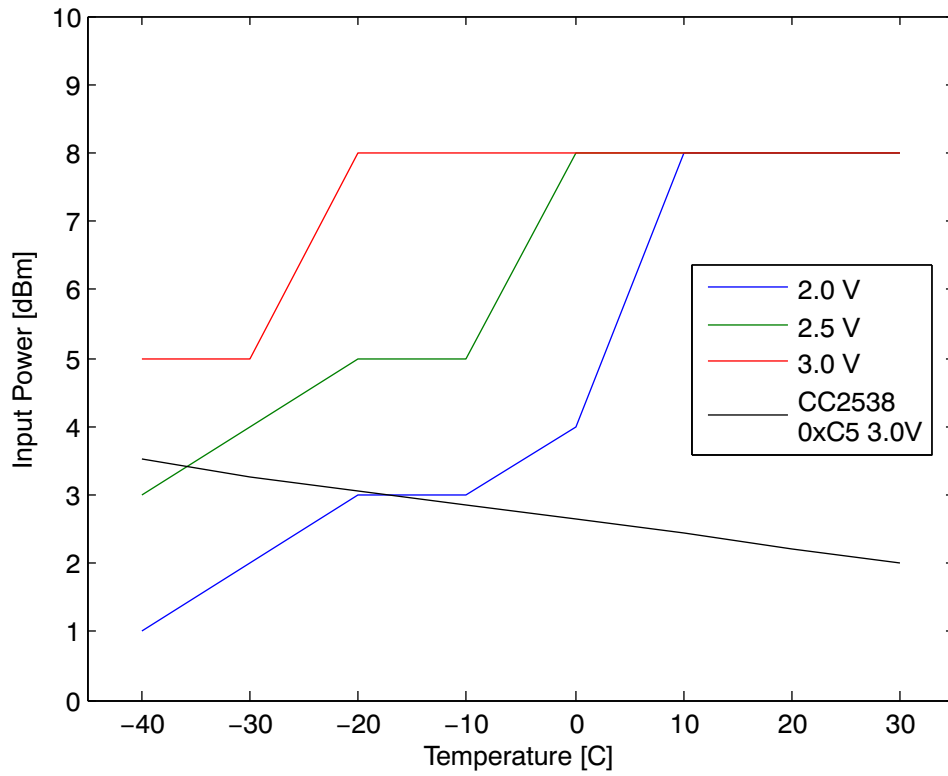

Figure 7. CC2592 Maximum Input Power and CC2538 Output Power vs Temperature

3.8 IEEE - Transmit Power Spectral Density (PSD) Mask

The IEEE standard 802.15.4 [7] requires the transmitted spectral power to be less than the limits specified in Table 7.

Table 7. Transmit PSD Limits

Frequency	Relative Limit	Absolute Limit
$ f - fc > 3.5 \text{ MHz}$	-20 dB	-30 dBm

The results are given for $T_C = 25^\circ\text{C}$, $V_{DD} = 3.0 \text{ V}$ and $f = 2440 \text{ MHz}$, and are measured on [3] with a 50 Ω load.

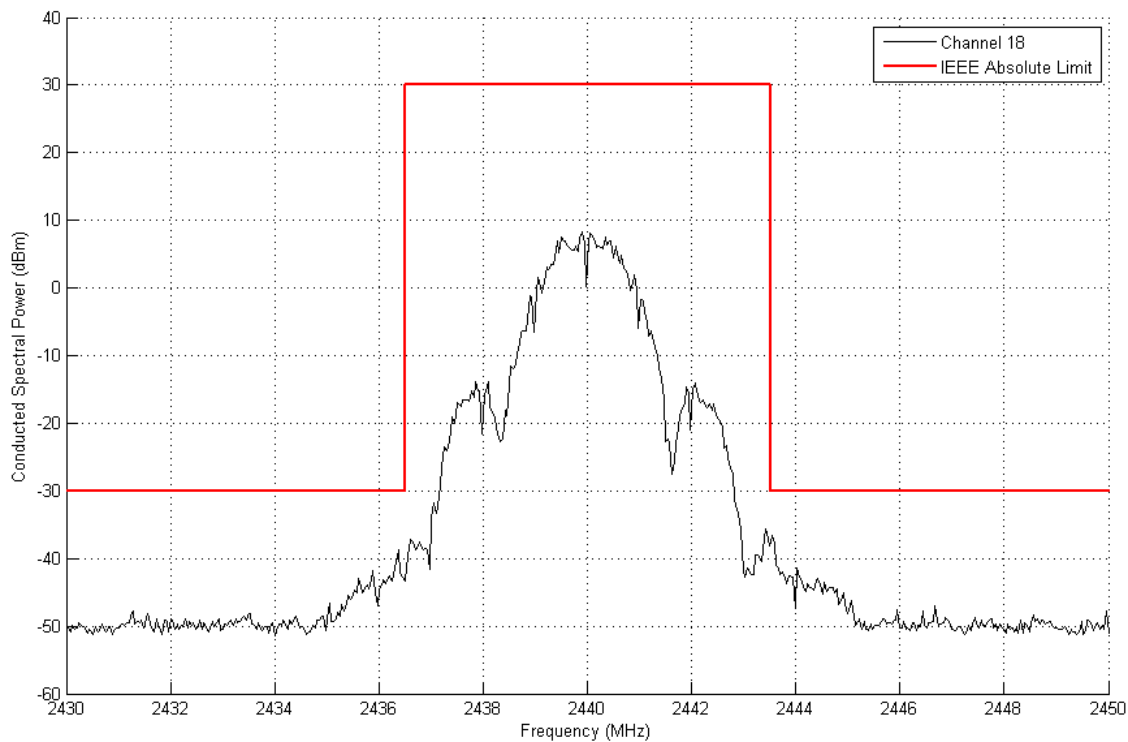

Figure 8. Conducted Power Spectral Density, TXPOWER = 0xC5, RBW = 100 KHz

4 Application Circuit

Only a few external components are required for [3]. A typical application circuit is shown in Section 4.1. Note that the application circuit figure does not show the complete layout of the CC2538 - CC2592EM. The board layout greatly influences the RF performance of the CC2538 - CC2592EM.

When using the CC2538 - CC2592EM at high power levels, a shield is required to be compliant with FCC harmonic emission regulations. TI provides a compact CC2538 - CC2592EM reference design incorporating shielding footprints that it is highly recommended to follow. The layout, stack-up and schematic for the CC2592 need to be copied exactly to obtain optimum performance.

Note that the reference design also includes the bill of materials with manufacturers and part numbers.

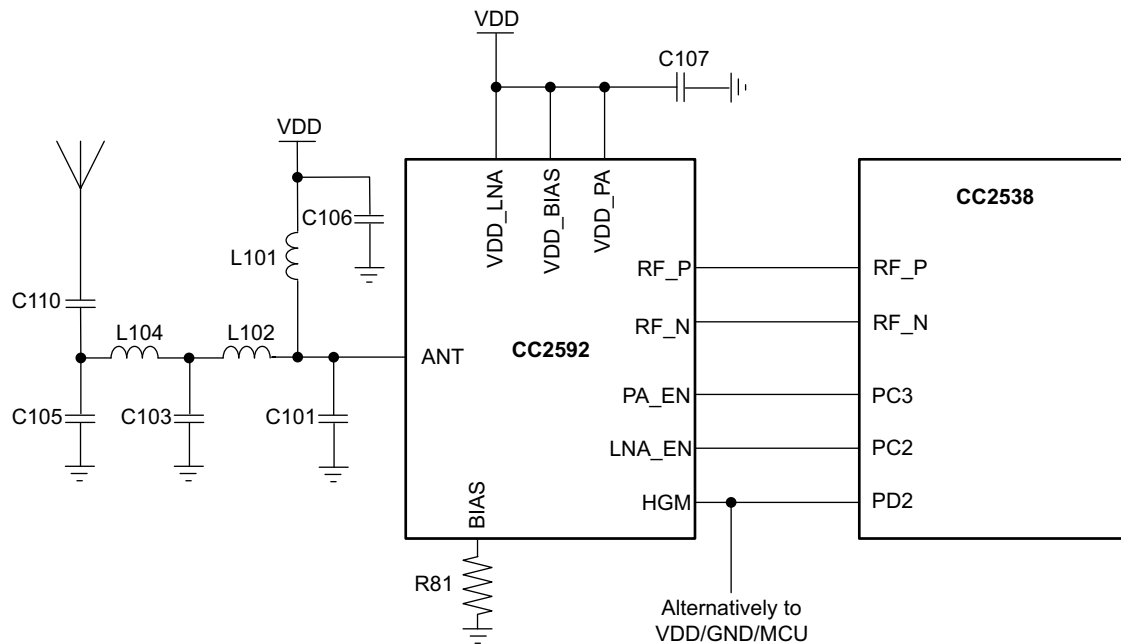

Figure 9. Application Circuit for the CC2538 With CC2592

4.1 Power Decoupling

Proper power supply decoupling must be used for optimum performance. Figure 9 is a simplified schematic only showing the output matching and a reduced number of V_{DD} decoupling components for the CC2592.

The placement and size of the decoupling components, the power supply filtering and the PCB lines are very important to achieve the best performance. Details about the importance of copying [3] exactly and potential consequences of changes are explained in Section 5.

4.2 Input/Output Matching and Filtering

The CC2592 includes a balun and a matching network in addition to the PA, LNA and RF switches, which makes the interface to the CC2538 seamless.

Note that the PCB lines that connect the two devices also are part of the RF matching. Therefore, it is important to copy the distance between the devices, the transmission lines and the stack-up of the PCB according to the reference design to ensure optimum performance.

The network between the CC2592 and the antenna (C101, L101, C106, L102, C103, L104, C105 and C110) matches the CC2592 to a 50 Ω load and provides filtering to pass regulatory demands. C110 also works as a DC-block.

4.3 Bias Resistor

R81 is a bias resistor. The bias resistor is used to set an accurate bias current for internal use in the CC2592.

4.4 Antenna Considerations

The TI reference design contains two antenna options. As default, the PCB antenna, which is a planar inverted F antenna (PIFA), is connected to the output of CC2592 through C110. This capacitor can be soldered off and rotated 90° clockwise in order to connect to the SMA connector. Note that all testing and characterization has been completed using the SMA connector. The PCB antenna has been used to obtain radiated results and FCC certification. The FCC certification will be void if the PCB antenna is not used. For further details on the antenna solutions, see [4] and [5].

5 PCB Layout Considerations

The Texas Instruments reference design uses a 1.6 mm (0.062") 4-layer PCB solution. Note that the different layers have different thickness; it is important to follow the recommendations given in [3] to ensure optimum performance. The top layer is used for components and signal routing, and the open areas are filled with metallization connected to ground using several vias. The areas under the two chips are used for grounding and must be well connected to the ground plane with multiple vias. Footprint recommendation for the CC2592 is given in [2].

Layer two is a complete ground plane and is not used for any routing. This is done to ensure short return current paths. The low impedance of the ground plane prevents any unwanted signal coupling between any of the nodes that are decoupled to it. A dedicated ground plane is also needed to improve stability (see Section 5.1). Layer three is a power and signal routing plane. The power plane ensures low-impedance traces at radio frequencies and prevents unwanted radiation from power traces. Layer four is used for routing, and as for layer one, open areas are filled with metallization connected to ground using several vias.

5.1 CC2538 – CC2592 Stability

The figures located on the next page illustrate the stability of the CC2538-CC2592. Figure 10, Figure 11 and Figure 12 depict the stability of the CC2538-CC2592 at 2480 MHz, 3.6 V and 25°C. Alternatively, Figure 13, Figure 14 and Figure 15 again depict the stability of the CC2538-CC2592, however, this time at 2480 MHz, 3.6 V and -40°C. Note the device stays stable at extreme temperatures and at the maximum recommended voltage level. Furthermore, note that the scaling on each figure may vary.

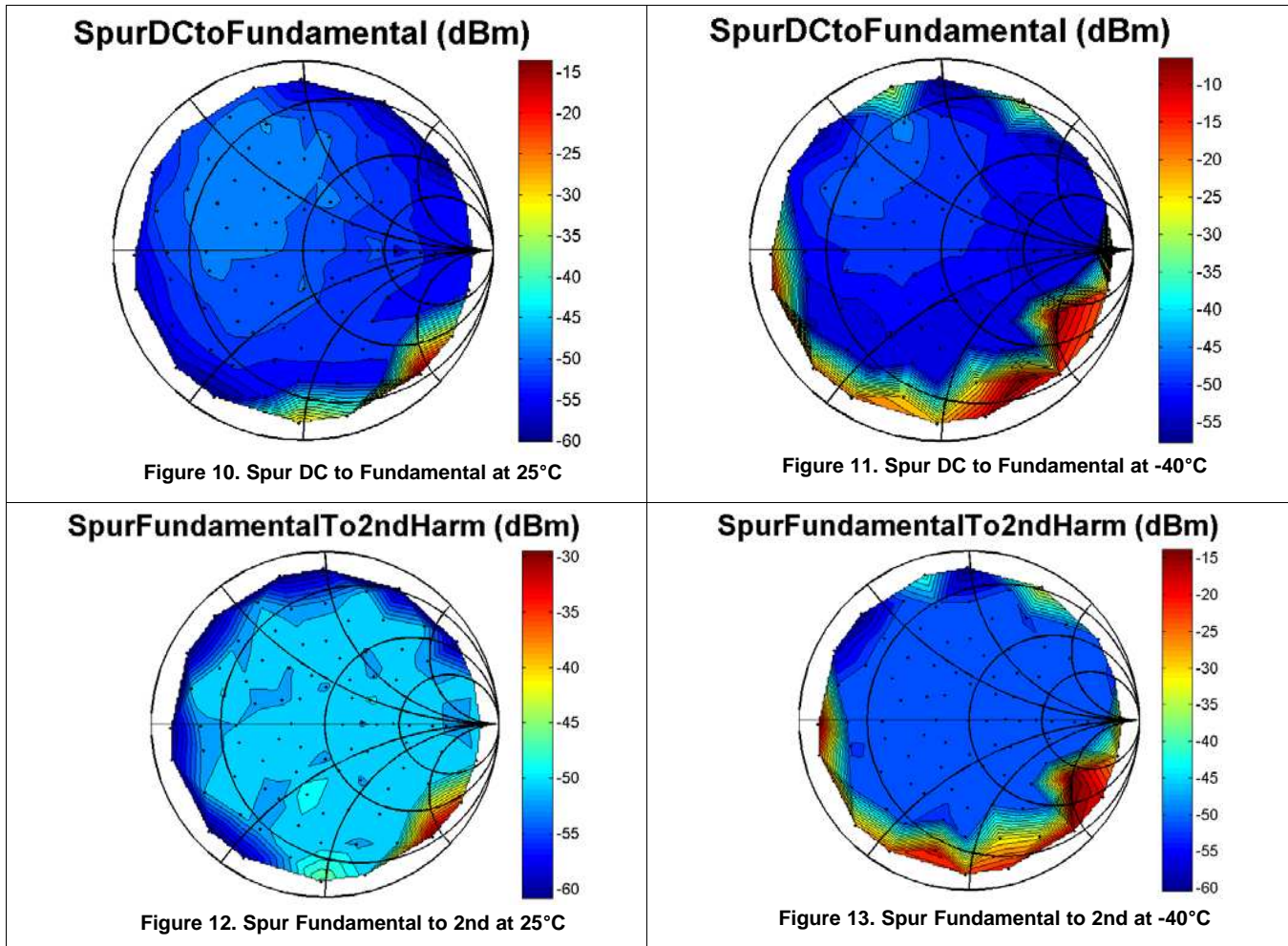

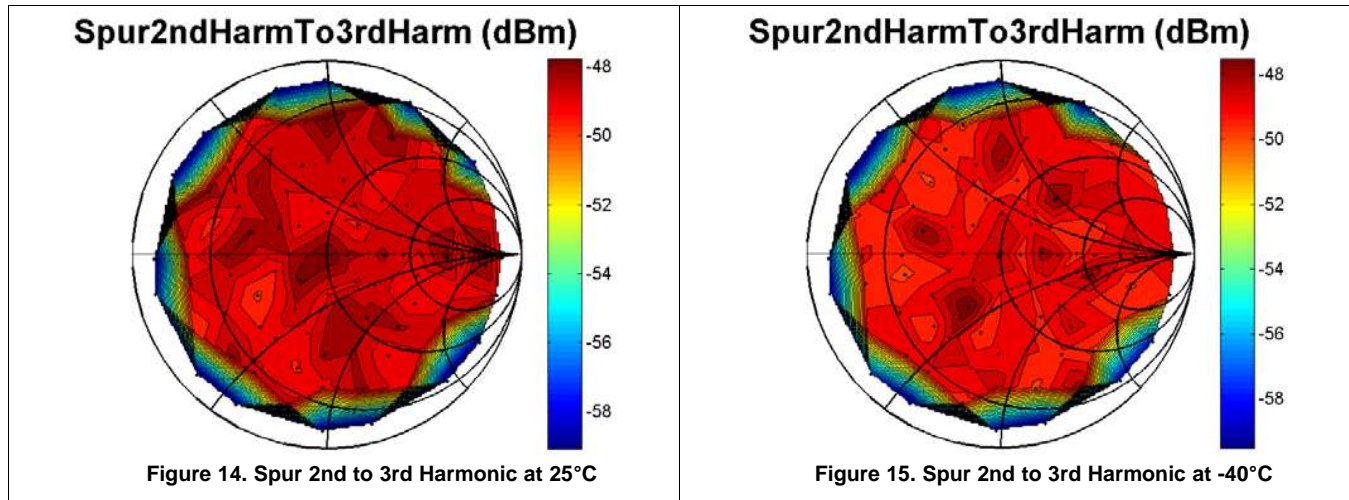

5.2 The Gain of the CC2592

Changing the layout or the stack-up of [3] affects the RF performance of the CC2592. Due to all the contributors to the CC2592 performance, several observations can be made on how changing layout and PCB stack-up affects the amplifier:

- Bad soldering of the ground paddle can reduce the gain significantly
- Too few or too long vias will reduce the gain significantly. This is why a checkered pattern of vias and solder paste and a 4-layer PCB with the ground plane close to the top layer has been chosen for [3].

6 Regulatory Requirements

In the United States, the Federal Communications Commission (FCC) is responsible for the regulation of all RF devices. CFR 47, Part 15, regulates RF products intended for unlicensed operation. A product intended for unlicensed operation has to be subject to compliance testing. If the product is approved, the FCC will issue an identification number.

The specific frequency bands used for unlicensed radio equipment for the 2.4 GHz band are regulated by section 15.247 and 15.249. General rules for certification measurements are found in section 15.35. Restricted bands and general limits for spurious emissions are found in sections 15.205 and 15.209.

[3] has been tested for compliance with FCC Part 15.247. The FCC Part 15.247 compliance is generally a tougher requirement than ETSI compliance (EN 300 328) due to the restricted bands of operation. However, there are requirements with regards to ETSI compliance (EN 300 328) that prevents operation at maximum output power. The clause 4.3.2.2 *Maximum Power Spectral Density* requirement of EN 300 328 requires maximum +10 dBm/1 MHz. The output power must, therefore, be reduced to approximately +12 dBm in order to get CE approval. The final output power level depends on the antenna used.

FCC Part 15.247 limits the output power to 1W or +30 dBm when Direct Sequence Spread Spectrum (DSSS) modulation or Frequency Hopping Spread Spectrum (FHSS) with at least 75 hop channels is used. The spectral density of digital modulation systems (not including FHSS) shall not exceed 8 dBm/3 kHz. The minimum 6 dB bandwidth of such systems is 500 kHz. Since the CC2538 is an IEEE 802.15.4 compliant transceiver, it uses DSSS modulation. The +30 dBm limit, therefore, apply for the CC2538 with the CC2592 combination.

When complying with Part 15.247, in any 100 kHz bandwidth outside the operating band, the power level shall be at least 20 dB below the level in the 100 kHz bandwidth with the highest power level in the operating band. Attenuation below limits given in 15.209 is not required. Emission that fall within restricted bands (15.205) must meet general limits given in 15.209. This is summarized in Table 8. More details about the 2.4 GHz FCC regulations are found in [8].

Table 8. Summarized FCC 15.247 Regulations for the 2.4 GHz Band

Standard	Relevant Frequency	Radiated Power (EIRP)	Conducted Power	Comment
FCC 15.247	2400 – 2483.5 MHz		+30 dBm	Maximum 6 dBi antenna gain
	Restricted bands defined by 15.205, including the 2nd, 3rd and 5th harmonics	-41.2 dBm		
	All frequencies not covered in above cells		-20 dBc	

When using CC2592 with the CC2538, back-off is required for the highest IEEE 802.15.4 channel (channel 26) to comply with FCC. [Table 9](#) shows the back-off needed to comply with the FCC Part 15.247 limits at typical conditions. Note that the numbers in [Table 9](#) are based on conducted emission measurements from [\[3\]](#). The real required back-off may be different for applications with different antennas, plastic covers, or other factors that amplify/ attenuate the radiated power.

[Figure 16](#) depicts the level of the conducted spurious emission and margins to the FCC Part 15.247 limits for the IEEE 802.15.4 channels under typical conditions ($T_C = 25^\circ\text{C}$, $V_{DD} = 3.0\text{ V}$) when transmitting at maximum recommended power (TXPOWER = 0xC5) using [\[3\]](#). [Figure 17](#) and [Figure 18](#) show the margins versus the FCC 15.247 for the lowest frequency channels at the lower band edge and for the upper frequency channels at the upper band edge, respectively. At the band edge, the FCC allows for a Marker-delta method measurement [\[9\]](#) to determine the amount of back-off or duty cycle required to comply with the FCC Part 15.247. This is necessary when conducting radiated band-edge measurements, because there can be an issue obtaining meaningful data since a measurement instrument that is tuned to a band-edge frequency may also capture some of the in-band signal when using the resolution bandwidth (RBW) required by the measurement procedure ANSI C63.4-1992. [Appendix A](#) provides a step-by-step example of using the marker-delta method to calculate the required back-off required.

Table 9. Back-Off Requirement for FCC Part 15.247 Compliance Under Typical Conditions

Frequency [MHz]	Back-Off [dB]
2405	0
2410	0
2415	0
2420	0
2425	0
2430	0
2435	0
2440	0
2445	0
2450	0
2455	0
2460	0
2465	0
2470	0
2475	0
2480	11.6

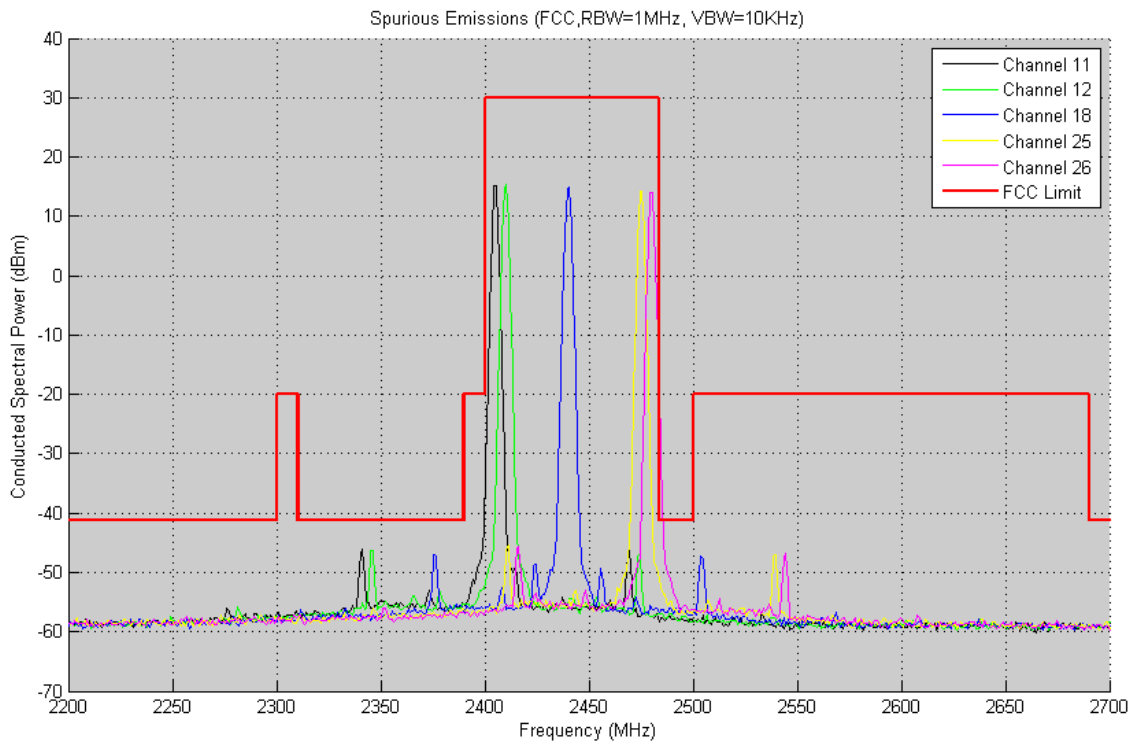

Figure 16. Conducted Spurious Emission vs. FCC Part 15.247 Limit (TXPOWER = 0xC5, RBW = 1 MHz, VBW = 10 kHz)

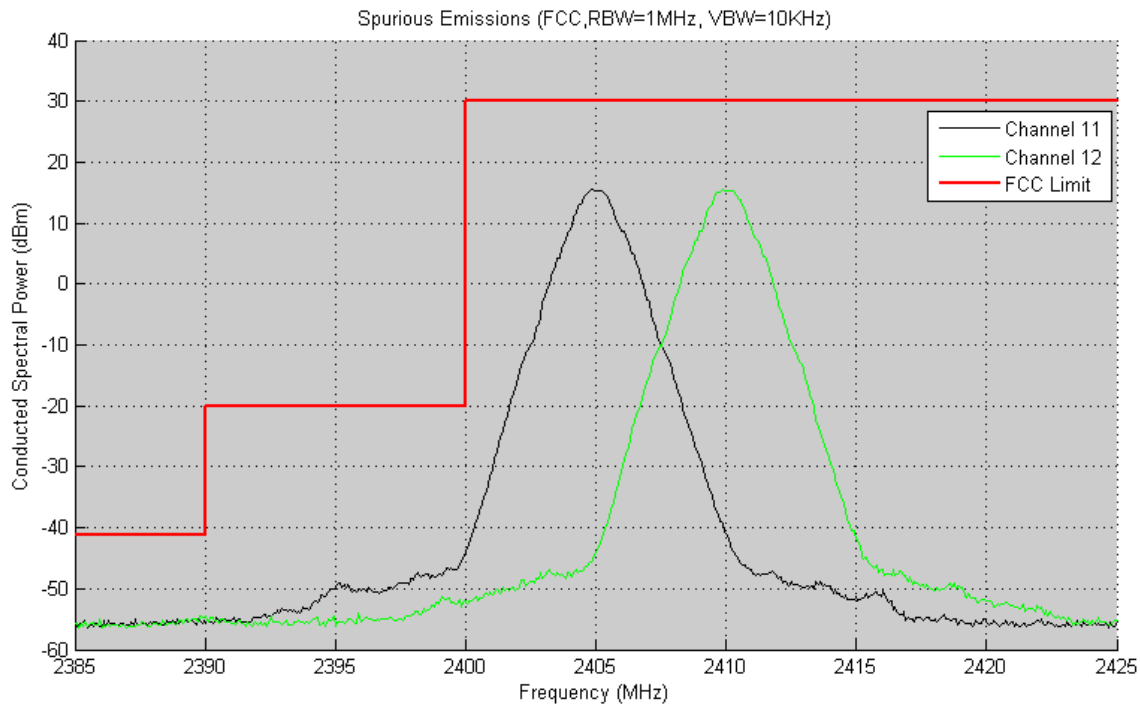

Figure 17. Conducted Spurious Emission, Lower Band Edge (TXPOWER = 0xC5, RBW = 1 MHz, VBW = 10 KHz)

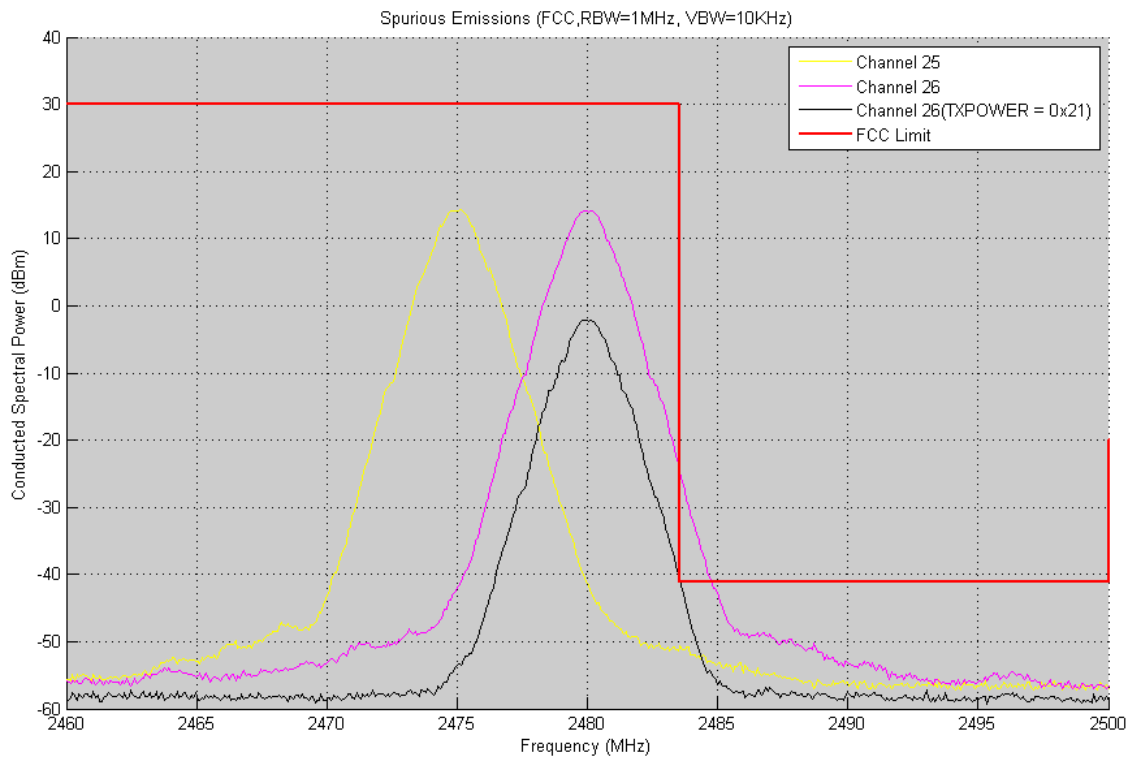

Figure 18. Conducted Spurious Emission, Upper Band Edge (TXPOWER = 0xC5, RBW = 1 MHz, VBW = 10 KHz)

7 Controlling the CC2592

There are three digital control pins on the CC2592 that control the state the chip is in: PA_EN, LNA_EN, and HGM. Table 10 shows the control logic when connecting the CC2592 to a CC2538 device.

Table 10. Control Logic for Connecting the CC2592 to a CC2538 Device

PA_EN	LNA_EN	HGM	Mode of Operation
0	0	X	Power Down
X	1	0	RX Low Gain Mode
X	1	1	RX High Gain Mode
1	0	X	TX

The CC2538 – CC2592EM reference design from TI [3] uses three of the CC2538 GPIO pins on the CC2538 to control the CC2592. The I/O pins used is shown in Table 10. PA_EN and LNA_EN must be controlled by RF observation signals as illustrated in Figure 19, whereas, the HGM pin can be controlled by any GPIO or alternatively tied to V_{DD} or GND.

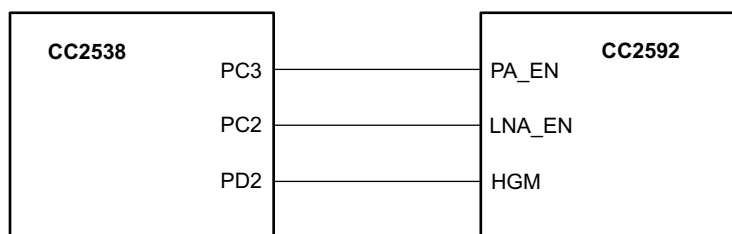

Figure 19. CC2538-CC2592 Interconnect

When using the CC2592 with the CC2538, the RF observation registers must be set according to Table 11. This enables the CC2538 to automatically control the CC2592 through PC2 and PC3. If required, any other PC pin can be used. For details, see [6].

It is not required to change any of the CC2538 radio settings from the recommend configuration when used with the CC2592.

Table 11. CC2538 Registers for CC2592 Control

CC2538 Register	Reccommended Value
CCTEST_OBSSEL2	0x80
CCTEST_OBSSEL3	0x81
RFC_OBS_CTRL0	0x6A
RFC_OBS_CTRL1	0x68

8 References

1. CC2538 A Powerful System-On-Chip for 2.4-GHz IEEE 802.15.4, 6LoWPAN and ZigBee Applications Data Sheet ([SWRS096](#))
2. CC2592 CC2592 2.4-GHz Range Extender Data Manual ([SWRS159](#))
3. CC2538-CC2592 Reference Design (www.ti.com/tool/cc2538-cc2592em-rd)
4. AN058 - Antenna Selection Guide ([SWRA161](#))
5. DN007 - 2.4 GHz Inverted F Antenna Design Note ([SWRU120](#))
6. CC2538 System-on-Chip Solution for 2.4-GHz IEEE 802.15.4 and ZigBee®/ZigBee IP® Applications User's Guide ([SWRU319](#))
7. IEEE std. 802.15.4 – 2006: Wireless Medium Access Control (MAC) and Physical Layer (PHY) specification for Low Rate Wireless Personal Area Networks (<http://standards.ieee.org/getieee802/download/802.15.4-2011.pdf>)
8. AN032 - SRD regulations for license-free transceiver operation in the 2.4 GHz band ([SWRA060](#))
9. DA 00-705 (http://www.fcc.gov/Bureaus/Engineering_Technology/Public_Notices/2000/da000705.doc)

Appendix A Marker - Delta Method

- Power Setting: 0xC5
- Set the DUT in Modulated TX
- Center Frequency: 2480 MHz
- Span: 10 MHz

RBW	VBW	Detector	Meas. Name	Power	Comments
1 MHz	1 MHz	Max Peak + Max Hold	PEAK	19.57	
1 MHz	10 Hz	Average + Max Hold	AVERAGE	17.31	The power will be lower for AVERAGE than for PEAK

- Choose a spectrum analyzer that encompasses both the peak of the fundamental emission and the band-edge emission under investigation (2483.5 MHz, edge in [Figure 20](#)).

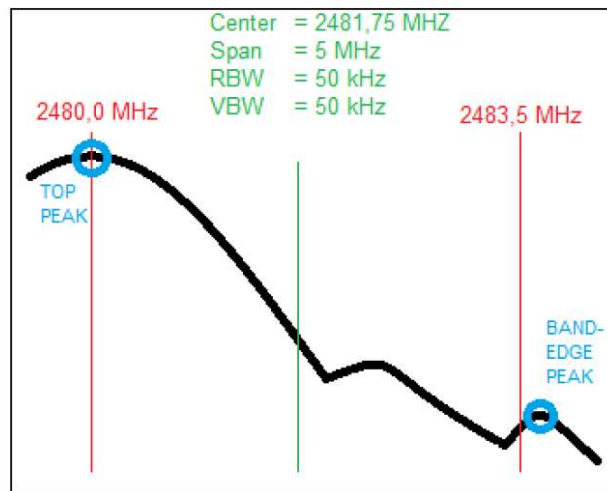

Figure 20. Band Edge Setup

RBW	VBW	Detector	Meas. Name	Power	Comments
1% of total span	>= RBW (100 KHz)	Max Peak + Max Hold	TOP PEAK	13.9	RBW - never less than 30 kHz. several sweeps in peak hold mode
1% of total span	>= RBW (100 KHz)	Max Peak + Max Hold	Band-Edge PEAK	-33	RBW - never less than 30 kHz. several sweeps in peak hold mode
TOP PEAK - Band Edge PEAK ->			DELTA	46.9	Delta will normally be > 40dB

- Record the peak levels of the fundamental emission and the relevant band edge emission. The band edge peak is measured at the highest point to the right of the 2483.5 MHz line, which is typically on this line. However, in some cases there may be a higher peak nearby. Observe the stored trace and measure the amplitude delta between the top peak of the fundamental and the peak of the band-edge emission.
- Note a lower RBW, even as low as 30 KHz may be required to see the band-edge peak.

- When the DELTA value is calculated, this can be used to check how the PEAK and Average Values are compared to their respective limits.

MATH	Power (dBm)	Limits and Comments
PEAK - DELTA =	-27.33	-21.2 dBm (74 dBuV/m)
AVERAGE - DELTA =	-29.59	-41.2 dBm (54 dBuV/m)
BACK OFF =	$(-29.59) - (-41.2) = 11.61$	Required back-off on channel 26

IMPORTANT NOTICE

Texas Instruments Incorporated and its subsidiaries (TI) reserve the right to make corrections, enhancements, improvements and other changes to its semiconductor products and services per JESD46, latest issue, and to discontinue any product or service per JESD48, latest issue. Buyers should obtain the latest relevant information before placing orders and should verify that such information is current and complete. All semiconductor products (also referred to herein as "components") are sold subject to TI's terms and conditions of sale supplied at the time of order acknowledgment.

TI warrants performance of its components to the specifications applicable at the time of sale, in accordance with the warranty in TI's terms and conditions of sale of semiconductor products. Testing and other quality control techniques are used to the extent TI deems necessary to support this warranty. Except where mandated by applicable law, testing of all parameters of each component is not necessarily performed.

TI assumes no liability for applications assistance or the design of Buyers' products. Buyers are responsible for their products and applications using TI components. To minimize the risks associated with Buyers' products and applications, Buyers should provide adequate design and operating safeguards.

TI does not warrant or represent that any license, either express or implied, is granted under any patent right, copyright, mask work right, or other intellectual property right relating to any combination, machine, or process in which TI components or services are used. Information published by TI regarding third-party products or services does not constitute a license to use such products or services or a warranty or endorsement thereof. Use of such information may require a license from a third party under the patents or other intellectual property of the third party, or a license from TI under the patents or other intellectual property of TI.

Reproduction of significant portions of TI information in TI data books or data sheets is permissible only if reproduction is without alteration and is accompanied by all associated warranties, conditions, limitations, and notices. TI is not responsible or liable for such altered documentation. Information of third parties may be subject to additional restrictions.

Resale of TI components or services with statements different from or beyond the parameters stated by TI for that component or service voids all express and any implied warranties for the associated TI component or service and is an unfair and deceptive business practice. TI is not responsible or liable for any such statements.

Buyer acknowledges and agrees that it is solely responsible for compliance with all legal, regulatory and safety-related requirements concerning its products, and any use of TI components in its applications, notwithstanding any applications-related information or support that may be provided by TI. Buyer represents and agrees that it has all the necessary expertise to create and implement safeguards which anticipate dangerous consequences of failures, monitor failures and their consequences, lessen the likelihood of failures that might cause harm and take appropriate remedial actions. Buyer will fully indemnify TI and its representatives against any damages arising out of the use of any TI components in safety-critical applications.

In some cases, TI components may be promoted specifically to facilitate safety-related applications. With such components, TI's goal is to help enable customers to design and create their own end-product solutions that meet applicable functional safety standards and requirements. Nonetheless, such components are subject to these terms.

No TI components are authorized for use in FDA Class III (or similar life-critical medical equipment) unless authorized officers of the parties have executed a special agreement specifically governing such use.

Only those TI components which TI has specifically designated as military grade or "enhanced plastic" are designed and intended for use in military/aerospace applications or environments. Buyer acknowledges and agrees that any military or aerospace use of TI components which have **not** been so designated is solely at the Buyer's risk, and that Buyer is solely responsible for compliance with all legal and regulatory requirements in connection with such use.

TI has specifically designated certain components as meeting ISO/TS16949 requirements, mainly for automotive use. In any case of use of non-designated products, TI will not be responsible for any failure to meet ISO/TS16949.

Products

Audio	www.ti.com/audio
Amplifiers	amplifier.ti.com
Data Converters	dataconverter.ti.com
DLP® Products	www.dlp.com
DSP	dsp.ti.com
Clocks and Timers	www.ti.com/clocks
Interface	interface.ti.com
Logic	logic.ti.com
Power Mgmt	power.ti.com
Microcontrollers	microcontroller.ti.com
RFID	www.ti-rfid.com
OMAP Applications Processors	www.ti.com/omap
Wireless Connectivity	www.ti.com/wirelessconnectivity

Applications

Automotive and Transportation	www.ti.com/automotive
Communications and Telecom	www.ti.com/communications
Computers and Peripherals	www.ti.com/computers
Consumer Electronics	www.ti.com/consumer-apps
Energy and Lighting	www.ti.com/energy
Industrial	www.ti.com/industrial
Medical	www.ti.com/medical
Security	www.ti.com/security
Space, Avionics and Defense	www.ti.com/space-avionics-defense
Video and Imaging	www.ti.com/video

TI E2E Community

e2e.ti.com