

Using the Wireless SimpleLink™ CC26xx in External Regulator Mode With the TPS62740

Charlotte Stephansen and Amjad El Hilali

ABSTRACT

This application report describes the set-up and expected performance when using the CC2640 in external regulator mode together with the TPS62740. Although this application report focuses on the CC2640 and *Bluetooth*® Smart applications, the solutions provided are also applicable for the entire CC26xx family and its supported protocols. Note that waveforms and power consumption measurement results presented in this application report may not be up to date with the latest software optimizations.

Contents

1	Introduction	2
2	The CC2640 Supply Voltage System and Configurations.....	2
3	Typical Performance Results.....	4
4	References	8

List of Figures

1	Simplified CC26xx Family Power Supply Configuration	3
2	Power Consumption in RX	4
3	Power Consumption in TX, 0 dBm Setting	5
4	Power Consumption in Standby	5
5	Power Consumption in Advertisement Mode for the CC2640 Using the Internal DCDC, VDDS 3.0 V, VDDR 1.7 V	6
6	Power Consumption in Advertise Mode for the CC2640 Using the External Regulator Mode and the TPS62740, VDD Into the TPS62470 3.0 V, VDDS/VDDR 1.8V	6
7	Power Consumption in Advertise Mode for the CC2640 Without DCDC, VDDS/VDDR 1.8V	7
8	Average Power Consumption in Bluetooth Smart Advertise Mode (advertise interval 500 ms).....	7
9	Average Power Consumption in Bluetooth Smart Connection Mode (connection interval 1 s)	7

List of Tables

1	Acronyms and Definitions.....	2
---	-------------------------------	---

SimpleLink is a trademark of Texas Instruments.
Bluetooth is a registered trademark of Bluetooth SIG, Inc.
 All other trademarks are the property of their respective owners.

1 Introduction

The SimpleLink CC2640 [1] uses an internal DCDC and LDO to achieve ultra-low power consumption when operated in normal mode. For systems with power supplies outside the CC2640 operating range or complex systems that include external peripherals running on different voltage levels than the CC2640, adding an external regulator may be necessary. Using the CC2640 external regulator mode with TPS62740 is a good choice for these systems.

The CC2640 is an ultra-low power wireless MCU targeting Bluetooth Smart applications and is a member of the CC26xx device family. The CC26xx wireless MCU platform System-on-Chips (SoCs) are optimized for ultra-low power, while providing fast and capable MCU systems to enable short processing times and high integration. This makes the CC2640 a good choice for a wide range of applications where long battery lifetime, small form factor, and ease of use is important. Very low active RF- and MCU current and low-power mode power consumption provides excellent battery lifetime and allows operation on small coin cell batteries and in energy-harvesting applications.

The TPS62740 [2] is industry's first step down converter featuring typical 360 nA quiescent current. The new DCS-Control-based device extends the light load efficiency range below 10 μ A load currents, thus making it a good match to support sleep and low power modes of the CC2640. TPS62740 supports output currents up to 300 mA, TPS62742 up to 400 mA. TPS6274x features low output ripple voltage and low noise with a small output capacitor. Once the battery voltage comes close to the output voltage (close to 100% duty cycle) the device enters no ripple 100% mode operation to prevent an increase of output ripple voltage. The device then stops switching and the output is connected to the input voltage. This makes it a good fit for RF applications.

1.1 Acronyms and Definitions

Table 1. Acronyms and Definitions

Acronym	Description
BLE	Bluetooth Low Energy (Bluetooth® Smart)
DC	Direct Current
DCS-Control	Direct Control with Seamless Transition into Power Save Mode
EVM	Evaluation Module
LDO	Low-Dropout regulator
MCU	Microcontroller Unit
RF	Radio Frequency
RX	Receive
TX	Transmit
SoC	System-on-Chip
USB	Universal Serial Bus

2 The CC2640 Supply Voltage System and Configurations

Figure 1 shows the power supply configurations for the CC2640. The main supply voltage on the CC2640 is called the VDDS. This supply has the highest potential in the system and is typically the only one provided by the user. In normal mode (configurations using the internal DCDC and LDO shown in Figure 1), the main voltage supply typically feeds the internal DCDC and LDO regulator, which outputs the VDDR supply. The two VDDR pins have a lower potential, typically 1.68 V.

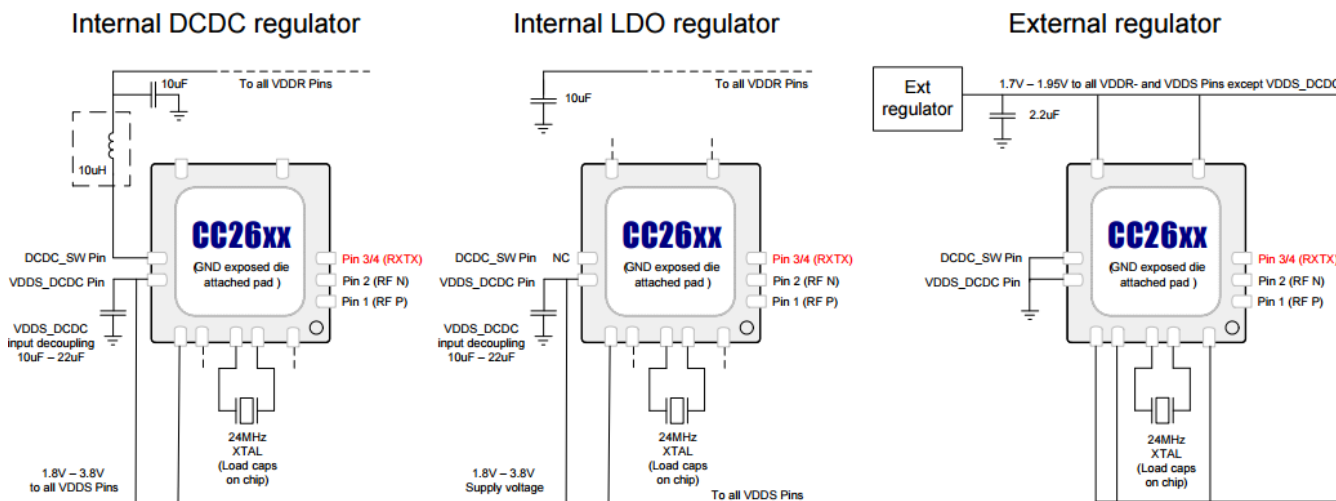

Figure 1. Simplified CC26xx Family Power Supply Configuration

In normal mode (using the internal DCDC and/or LDO), the allowed VDDC supply voltage range is from 1.8 V to 3.8 V. For low cost systems requiring little peripherals and that only have one supply voltage (within the CC2640 specifications), using the internal DCDC and LDO on the CC2640 will be an efficient and good solution. The solution has low cost, small size factor, low power consumption and simple design. However, the peripherals must be able to run directly on battery as it is not supported to sink current from the internal DCDC.

Some systems require higher supply voltage ratings than the maximum allowed 3.8 V for the CC2640, for example, Li-ion batteries or USB powered devices. Complex systems can further include more peripherals in addition to the wireless MCU such as different kinds of sensors, motors, and so forth. If running the CC2640 in normal mode with a high battery voltage, these external peripherals might require a different voltage level than the CC2640 and adding an external regulator like the TPS62740 may be a good choice. The external regulator makes sure that the CC2640 and the remaining peripherals always sees a stable supply voltage regardless of battery voltage, ensuring a stable and reliable operation of the full system. The TPS6274x is further best in the market for ultra-low power, it has a small size factor and compact DCDC solution and has tested RF friendliness on RX and TX.

When using the external regulator mode on the CC2640, the main supply voltages VDDC and VDDR are tied together as shown in Figure 1. The allowed supply voltage range in this mode is from 1.7 V to 1.95 V. For more information and details on how to configure the CC2640 for normal or external regulator mode, see the CC26xx Wireless MCU Technical Reference Manual [3] and the CC2640 Datasheet [1].

Note that all TI software examples run with the internal DCDC regulator enabled in software, unless otherwise notified. When configuring the CC2640 for external regulator mode, both of the VDDC_DCDC and DCDC_SW pins must be connected to ground and the internal DCDC must be disabled in software. To disable the internal DCDC, the following changes shown below must be included in the ccfg.c file.

```
//*****
// Select DC/DC during recharge
//*****
// 0 = Use the DC/DC during recharge in powerdown, 1 = Do not use...
//#define SET_CCFG_MODE_CONF_DCDC_RECHARGE 0x0
#define SET_CCFG_MODE_CONF_DCDC_RECHARGE 0x1

//*****
// Select DC/DC during active mode
//*****
// 0 = Use the DC/DC during active mode, 1 = Do not use...
//#define SET_CCFG_MODE_CONF_DCDC_ACTIVE 0x0
#define SET_CCFG_MODE_CONF_DCDC_ACTIVE 0x1
```

3 Typical Performance Results

All performance measurements mentioned in this document are performed on the CC2650EM-4XS_EXT_REG_MODE EVMs [4] at room temperature. The level shifters on the EVMs were removed for the current measurements as they affect the current measurements slightly.

3.1 RF Performance

The Bluetooth Smart sensitivity, output power and harmonics were tested for the different Bluetooth Smart channels and seen to be the same when using the TPS62740 with the CC2650EM-4XS_EXT_REG_MODE EVMs [4], and when using the internal DCDC on the CC2640 on the regular CC2650 EVMs. A full set of RF-PHY tests specified in the Bluetooth core specification was further run with the C2650EM-4XS_EXT_REG_MODE EVMs and passed with good margins.

3.2 Power Consumption

The RX, TX and Standby mode power consumption for the CC2640 external regulator mode with the TPS62740 were measured and compared with using the normal mode for the CC2640 and the internal DCDC. The results are shown in Figure 2, Figure 3 and Figure 4. The results show that the expected performance is very similar for the two set-ups with external or internal DCDC given the same output VDDR voltage level for the DCDCs. The difference in the standby current for the two configurations is seen to be almost constant and basically represents the quiescent current of the external DCDC.

Note that in the measurements (shown in Figure 2 and Figure 3), the output of the internal DCDC regulator was trimmed to 1.78 V (approximately 1.8 V) to get an accurate comparison with the TPS62740 regulator. Trimming the VDDR voltage in normal mode is not supported for the CC2640 and was done for test purposes only. In normal operation the CC2640 internal DCDC regulator will output 1.68 V ⁽¹⁾ for optimum efficiency and thus have slightly lower power consumption. This is seen in the measurements described later in the document.

- (1) Even though 1.68 V is outside the VDDR operating voltage for «External Regulator Mode», this is the expected voltage on VDDR when configured for normal mode, in which case the CC2640 controls the VDDR supply voltage by itself

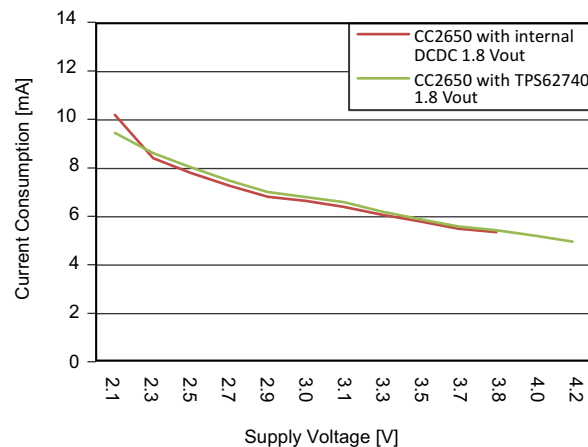

Figure 2. Power Consumption in RX

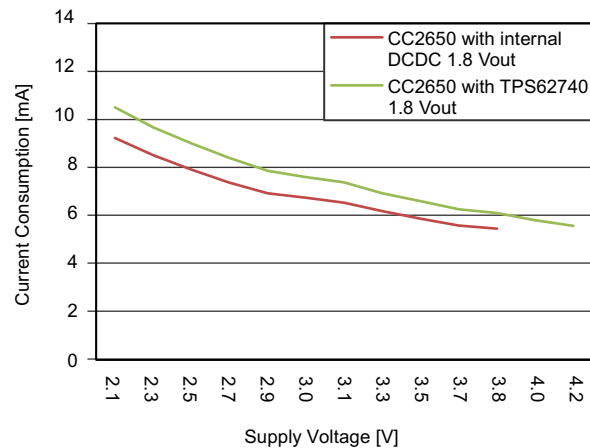

Figure 3. Power Consumption in TX, 0 dBm Setting

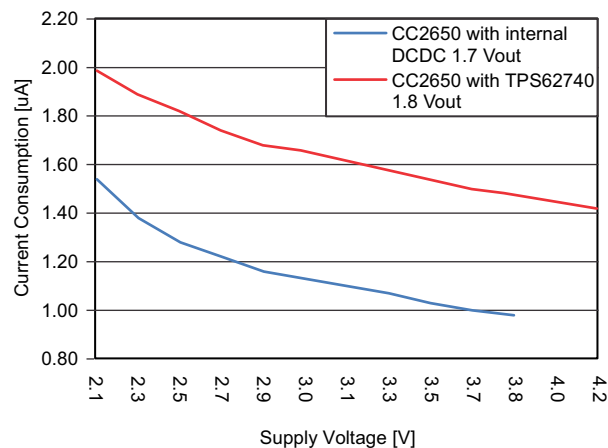

Figure 4. Power Consumption in Standby

3.3 Example Bluetooth Smart Application Power Consumption

A Bluetooth Smart device achieves low average power consumption by keeping radio activity short and allowing the device to reside in low-power modes most of the operating time. For details on how to best set-up and measure the power consumption for a Bluetooth Smart application, see *Measuring Bluetooth® Smart Power Consumption* [5]. Following the set-up provided in the latter, the power consumption for the different stages in an advertisement event for different hardware configurations is shown in Figure 5, Figure 6 and Figure 7. During the Standby period of the event, the current pulses seen between the advertisements for the set-ups in Figure 5 and Figure 5 are the recharge pulses for the CC2640 internal DCDC and the TPS62740. These pulses are not seen if bypassing the DCDC (Figure 7), but in this case, the average power consumption from the main power is higher.

Note that in the average power consumption measurements presented in Figure 8 and Figure 9, external regulator mode using the TPS62741 (programmed to 1.7 V out) is included in addition to the TPS62470 (programmed to 1.8 V out). This was included for test purposes to get an accurate comparison of power consumption when using an external DCDC and when using the internal CC2640 DCDC operating in normal mode. 1.8 V is the recommended output voltage from an external DCDC when running external regulator mode to have margins to the voltage ratings for this mode.

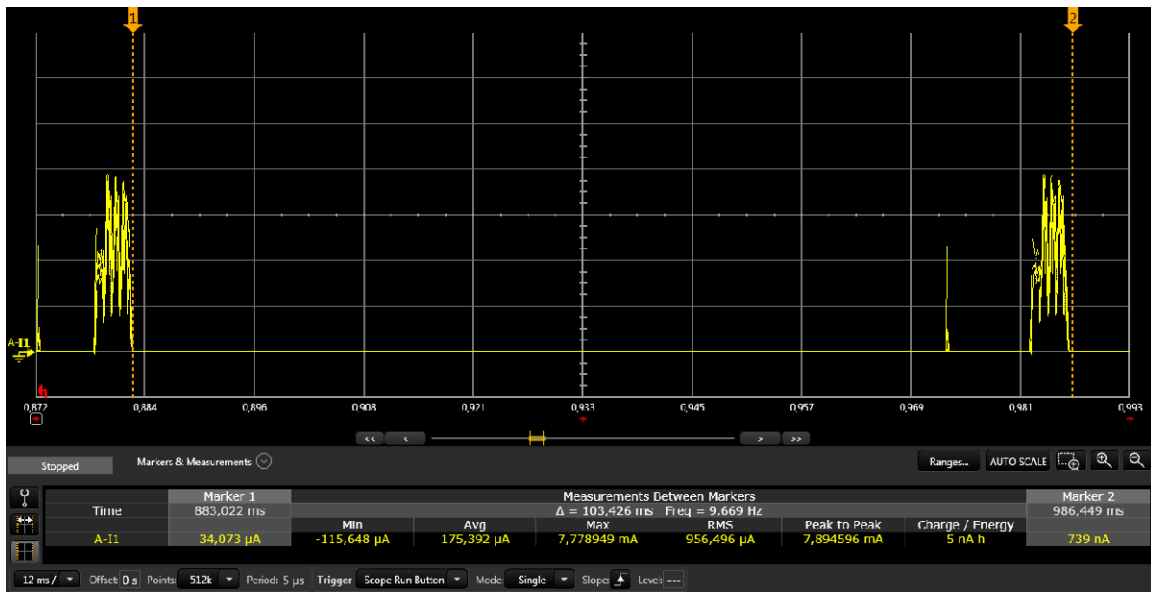

Figure 5. Power Consumption in Advertisement Mode for the CC2640 Using the Internal DCDC, VDDS 3.0 V, VDDR 1.7 V

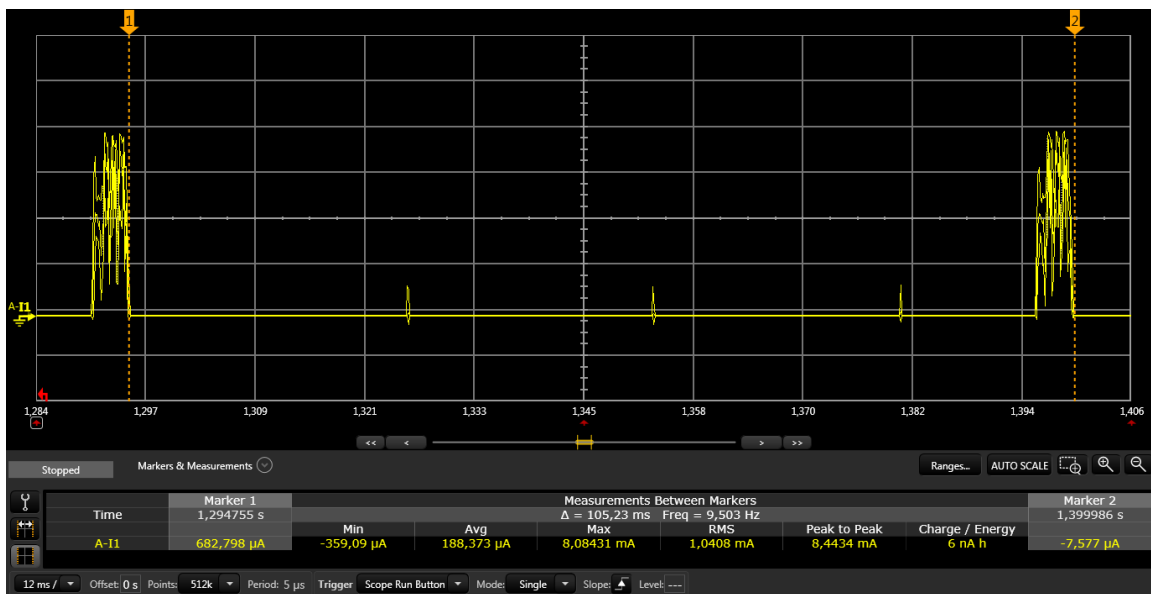

Figure 6. Power Consumption in Advertise Mode for the CC2640 Using the External Regulator Mode and the TPS62740, VDD Into the TPS62470 3.0 V, VDDS/VDDR 1.8V

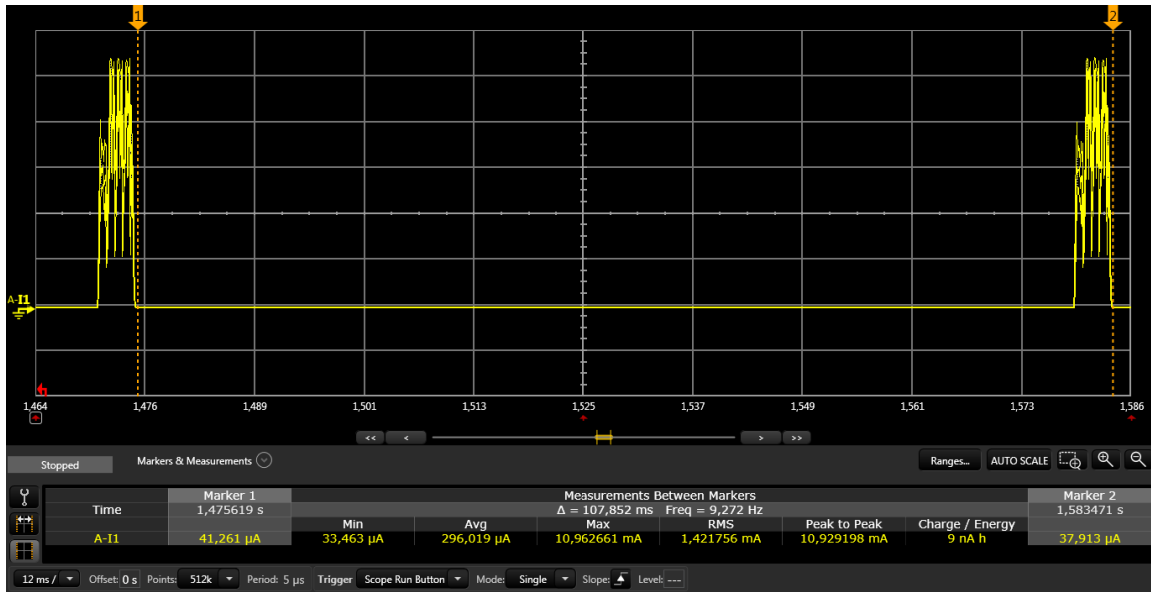

Figure 7. Power Consumption in Advertise Mode for the CC2640 Without DCDC, VDDS/VDDR 1.8V

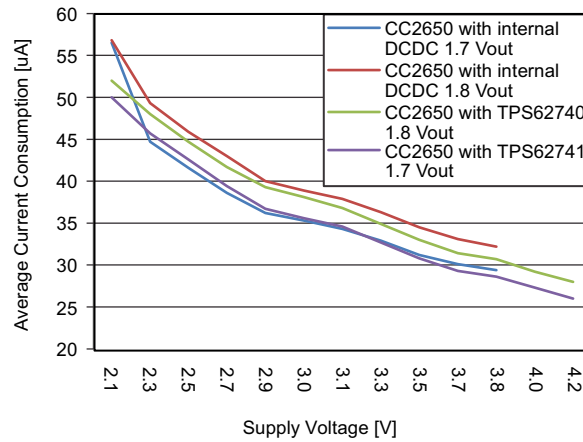

Figure 8. Average Power Consumption in Bluetooth Smart Advertise Mode (advertise interval 500 ms)

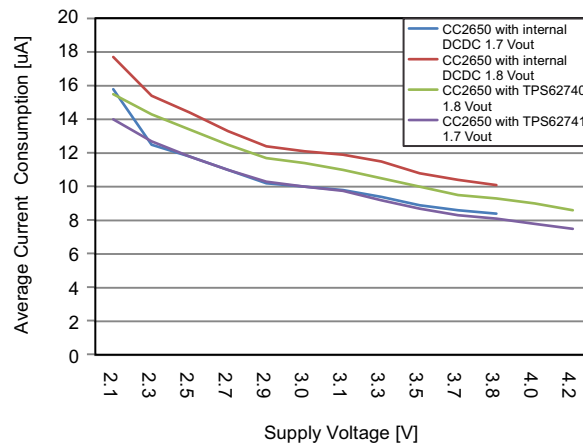

Figure 9. Average Power Consumption in Bluetooth Smart Connection Mode (connection interval 1 s)

4 References

1. CC2640 SimpleLink™ Bluetooth® Smart Wireless MCU Data Manual ([SWRS176](#))
2. TPS6274x 360nA I_Q Step Down Converter for Low Power Applications Data Sheet ([SLVSB02](#))
3. CC13xx, CC26xx SimpleLink™ Wireless MCU Technical Reference Manual ([SWCU117](#))
4. SimpleLink CC2650 EVM Kit 4XS_Ext_Reg (CC2650EM-4XS_Ext_Reg) v2.0.0 Design Files ([SWRC301](#))
5. Measuring Bluetooth® Smart Power Consumption ([SWRA478](#))

IMPORTANT NOTICE

Texas Instruments Incorporated and its subsidiaries (TI) reserve the right to make corrections, enhancements, improvements and other changes to its semiconductor products and services per JESD46, latest issue, and to discontinue any product or service per JESD48, latest issue. Buyers should obtain the latest relevant information before placing orders and should verify that such information is current and complete. All semiconductor products (also referred to herein as "components") are sold subject to TI's terms and conditions of sale supplied at the time of order acknowledgment.

TI warrants performance of its components to the specifications applicable at the time of sale, in accordance with the warranty in TI's terms and conditions of sale of semiconductor products. Testing and other quality control techniques are used to the extent TI deems necessary to support this warranty. Except where mandated by applicable law, testing of all parameters of each component is not necessarily performed.

TI assumes no liability for applications assistance or the design of Buyers' products. Buyers are responsible for their products and applications using TI components. To minimize the risks associated with Buyers' products and applications, Buyers should provide adequate design and operating safeguards.

TI does not warrant or represent that any license, either express or implied, is granted under any patent right, copyright, mask work right, or other intellectual property right relating to any combination, machine, or process in which TI components or services are used. Information published by TI regarding third-party products or services does not constitute a license to use such products or services or a warranty or endorsement thereof. Use of such information may require a license from a third party under the patents or other intellectual property of the third party, or a license from TI under the patents or other intellectual property of TI.

Reproduction of significant portions of TI information in TI data books or data sheets is permissible only if reproduction is without alteration and is accompanied by all associated warranties, conditions, limitations, and notices. TI is not responsible or liable for such altered documentation. Information of third parties may be subject to additional restrictions.

Resale of TI components or services with statements different from or beyond the parameters stated by TI for that component or service voids all express and any implied warranties for the associated TI component or service and is an unfair and deceptive business practice. TI is not responsible or liable for any such statements.

Buyer acknowledges and agrees that it is solely responsible for compliance with all legal, regulatory and safety-related requirements concerning its products, and any use of TI components in its applications, notwithstanding any applications-related information or support that may be provided by TI. Buyer represents and agrees that it has all the necessary expertise to create and implement safeguards which anticipate dangerous consequences of failures, monitor failures and their consequences, lessen the likelihood of failures that might cause harm and take appropriate remedial actions. Buyer will fully indemnify TI and its representatives against any damages arising out of the use of any TI components in safety-critical applications.

In some cases, TI components may be promoted specifically to facilitate safety-related applications. With such components, TI's goal is to help enable customers to design and create their own end-product solutions that meet applicable functional safety standards and requirements. Nonetheless, such components are subject to these terms.

No TI components are authorized for use in FDA Class III (or similar life-critical medical equipment) unless authorized officers of the parties have executed a special agreement specifically governing such use.

Only those TI components which TI has specifically designated as military grade or "enhanced plastic" are designed and intended for use in military/aerospace applications or environments. Buyer acknowledges and agrees that any military or aerospace use of TI components which have **not** been so designated is solely at the Buyer's risk, and that Buyer is solely responsible for compliance with all legal and regulatory requirements in connection with such use.

TI has specifically designated certain components as meeting ISO/TS16949 requirements, mainly for automotive use. In any case of use of non-designated products, TI will not be responsible for any failure to meet ISO/TS16949.

Products

Audio	www.ti.com/audio
Amplifiers	amplifier.ti.com
Data Converters	dataconverter.ti.com
DLP® Products	www.dlp.com
DSP	dsp.ti.com
Clocks and Timers	www.ti.com/clocks
Interface	interface.ti.com
Logic	logic.ti.com
Power Mgmt	power.ti.com
Microcontrollers	microcontroller.ti.com
RFID	www.ti-rfid.com
OMAP Applications Processors	www.ti.com/omap
Wireless Connectivity	www.ti.com/wirelessconnectivity

Applications

Automotive and Transportation	www.ti.com/automotive
Communications and Telecom	www.ti.com/communications
Computers and Peripherals	www.ti.com/computers
Consumer Electronics	www.ti.com/consumer-apps
Energy and Lighting	www.ti.com/energy
Industrial	www.ti.com/industrial
Medical	www.ti.com/medical
Security	www.ti.com/security
Space, Avionics and Defense	www.ti.com/space-avionics-defense
Video and Imaging	www.ti.com/video

TI E2E Community

e2e.ti.com