

4

9

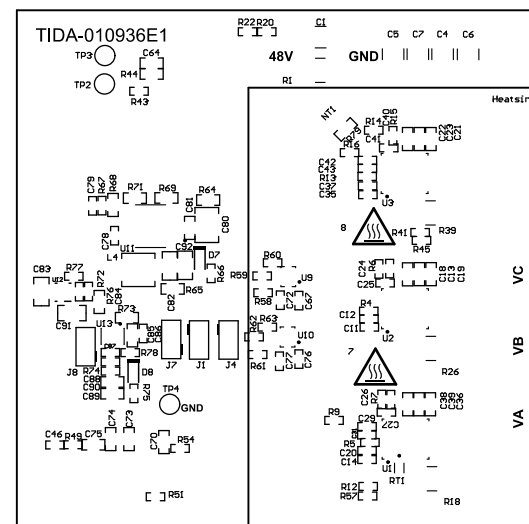

10

12

11

ALL ARTWORK VIEWED FROM TOP SIDE	BOARD #: TIDA-010936	REV: E1	SUN REV: Not in version control
LAYER NAME = Top Overlay	TID #: TIDA-010936		
PLOT NAME = Top Overlay	GENERATED : 2/14/2024 1:41:24 PM	TEXAS INSTRUMENTS	

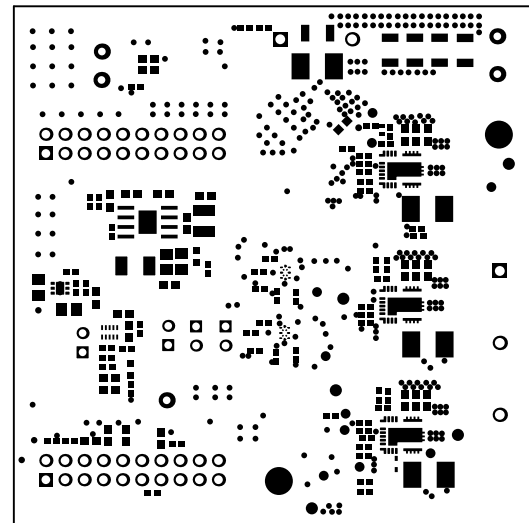

ALL ARTWORK VIEWED FROM TOP SIDE	BOARD #: TIDA-010936	REV: E1	SUN REV: Not in version control
LAYER NAME = Top Solder	TID #: TIDA-010936		
PLOT NAME = Top Solder Mask	GENERATED : 2/14/2024 1:41:25 PM	TEXAS INSTRUMENTS	

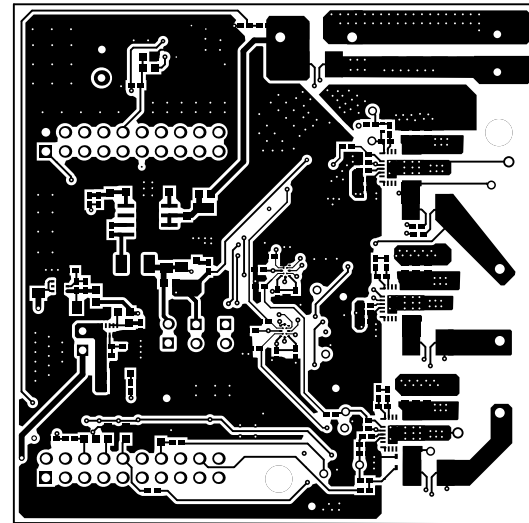

ALL ARTWORK VIEWED FROM TOP SIDE	BOARD #: TIDA-010936	REV: E1	SUN REV: Not in version control
LAYER NAME = Top Layer	TID #: TIDA-010936		
PLOT NAME = Top Layer	GENERATED : 2/14/2024	1:41:25 PM	TEXAS INSTRUMENTS

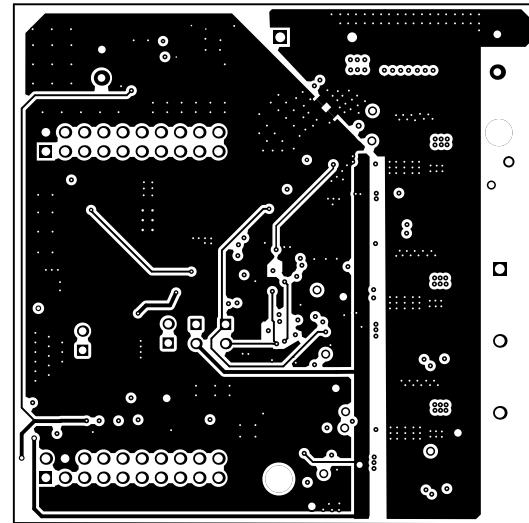

ALL ARTWORK VIEWED FROM TOP SIDE	BOARD #: TIDA-010936	REV: E1	SUN REV: Not in version control
LAYER NAME =	TID #: TIDA-010936		
PLOT NAME = Signal Layer 1	GENERATED : 2/14/2024 1:41:25 PM	TEXAS INSTRUMENTS	

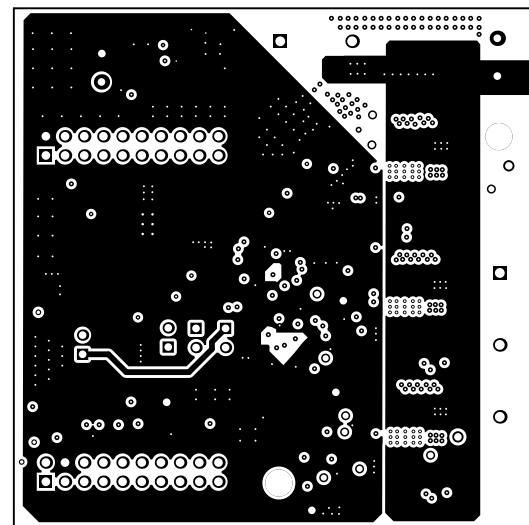

ALL ARTWORK VIEWED FROM TOP SIDE	BOARD #: TIDA-010936	REV: E1	SUN REV: Not in version control
LAYER NAME =	TID #: TIDA-010936		
PLOT NAME = Signal Layer 2	GENERATED : 2/14/2024 1:41:26 PM	TEXAS INSTRUMENTS	

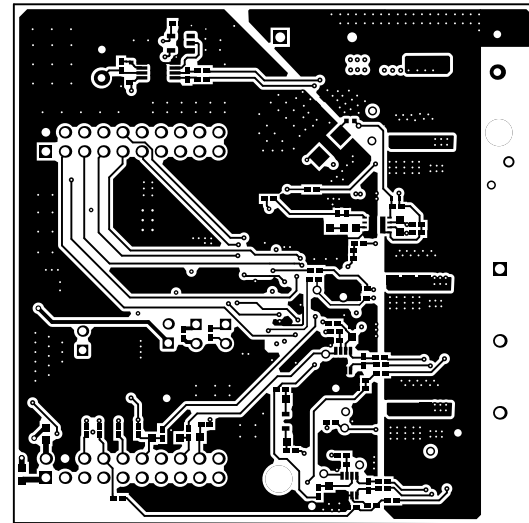

ALL ARTWORK VIEWED FROM TOP SIDE	BOARD #: TIDA-010936	REV: E1	SUN REV: Not in version control
LAYER NAME = Bottom Layer	TID #: TIDA-010936		
PLOT NAME = Bottom Layer	GENERATED : 2/14/2024 1:41:26 PM	TEXAS INSTRUMENTS	

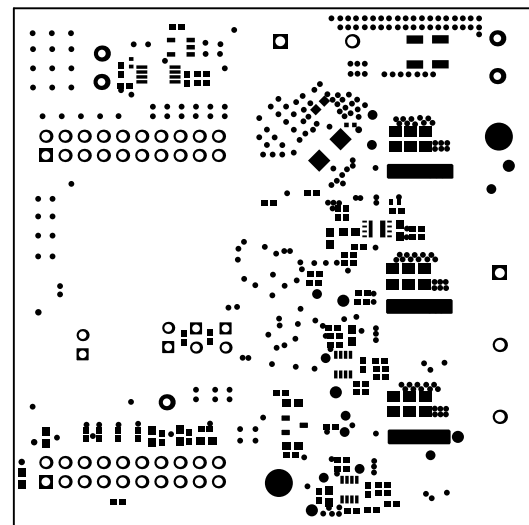

ALL ARTWORK VIEWED FROM TOP SIDE	BOARD #: TIDA-010936	REV: E1	SUN REV: Not in version control
LAYER NAME = Bottom Solder	TID #: TIDA-010936		
PLOT NAME = Bottom Solder Mask	GENERATED : 2/14/2024 1:41:27 PM	TEXAS INSTRUMENTS	

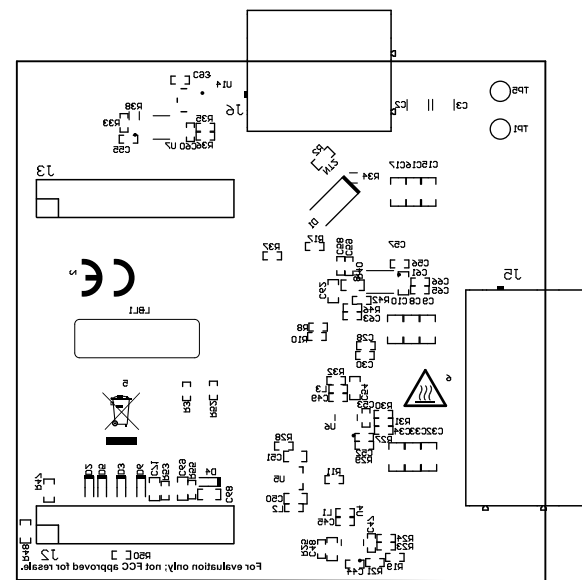

ALL ARTWORK VIEWED FROM TOP SIDE	BOARD #: TIDA-010936	REV: E1	SUN REV: Not in version control
LAYER NAME = Bottom Overlay	TID #: TIDA-010936		
PLOT NAME = Bottom Overlay	GENERATED : 2/14/2024	1:41:27 PM	TEXAS INSTRUMENTS

Symbol	Quantity	Finished Hole Size	Plated	Hole Type	Drill Layer Pair	Hole Tolerance
⊗	4	8.00mil (0.203mm)	PTH	Round	Top Layer - Bottom Layer	
⊗	408	10.00mil (0.254mm)	PTH	Round	Top Layer - Bottom Layer	
◇	6	12.99mil (0.330mm)	PTH	Round	Top Layer - Bottom Layer	
▽	1	15.75mil (0.400mm)	PTH	Round	Top Layer - Bottom Layer	
⊗	3	17.87mil (0.454mm)	PTH	Round	Top Layer - Bottom Layer	
▽	10	31.50mil (0.800mm)	PTH	Round	Top Layer - Bottom Layer	
⊗	5	39.37mil (1.000mm)	PTH	Round	Top Layer - Bottom Layer	
□	13	40.00mil (1.016mm)	PTH	Round	Top Layer - Bottom Layer	
☆	40	45.28mil (1.150mm)	PTH	Round	Top Layer - Bottom Layer	
⊗	5	51.18mil (1.300mm)	PTH	Round	Top Layer - Bottom Layer	+/-3.94mil
○	2	141.73mil (3.600mm)	PTH	Round	Top Layer - Bottom Layer	
	497 Total					

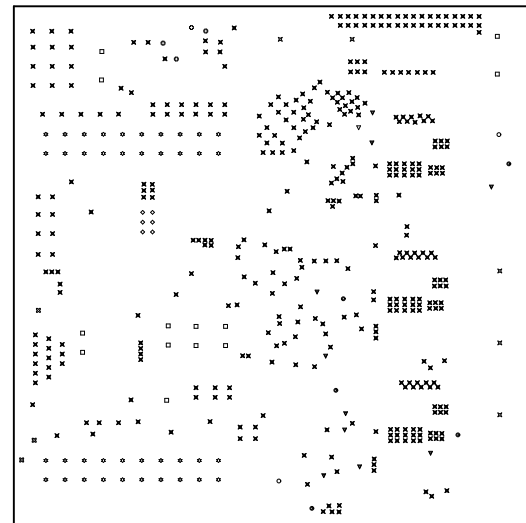

ALL ARTWORK VIEWED FROM TOP SIDE	BOARD #: TIDA-010936	REV: E1	SUN REV: Not in version control
LAYER NAME = Drill Drawing	TID #: TIDA-010936		
PLOT NAME = Drill Drawing	GENERATED : 2/14/2024	1:41:28 PM	TEXAS INSTRUMENTS

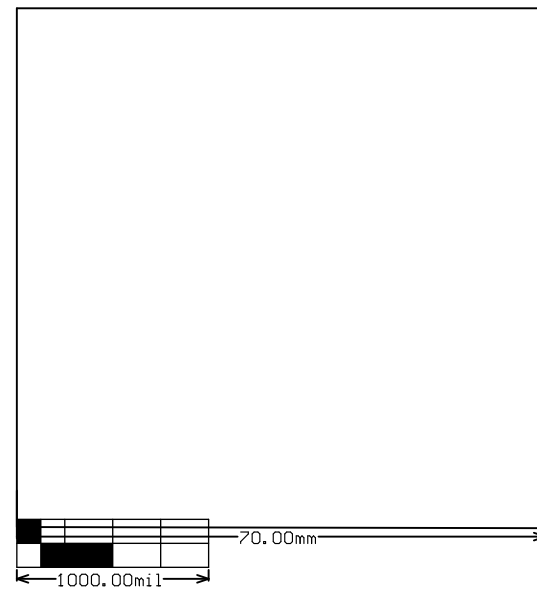

ALL ARTWORK VIEWED FROM TOP SIDE	BOARD #: TIDA-010936	REV: E1	SUN REV: Not in version control
LAYER NAME = M2 Board Dimensions	TID #: TIDA-010936		
PLOT NAME = Board Dimensions	GENERATED : 2/14/2024	1:41:30 PM	TEXAS INSTRUMENTS

IMPORTANT NOTICE AND DISCLAIMER

TI PROVIDES TECHNICAL AND RELIABILITY DATA (INCLUDING DATA SHEETS), DESIGN RESOURCES (INCLUDING REFERENCE DESIGNS), APPLICATION OR OTHER DESIGN ADVICE, WEB TOOLS, SAFETY INFORMATION, AND OTHER RESOURCES "AS IS" AND WITH ALL FAULTS, AND DISCLAIMS ALL WARRANTIES, EXPRESS AND IMPLIED, INCLUDING WITHOUT LIMITATION ANY IMPLIED WARRANTIES OF MERCHANTABILITY, FITNESS FOR A PARTICULAR PURPOSE OR NON-INFRINGEMENT OF THIRD PARTY INTELLECTUAL PROPERTY RIGHTS.

These resources are intended for skilled developers designing with TI products. You are solely responsible for (1) selecting the appropriate TI products for your application, (2) designing, validating and testing your application, and (3) ensuring your application meets applicable standards, and any other safety, security, regulatory or other requirements.

These resources are subject to change without notice. TI grants you permission to use these resources only for development of an application that uses the TI products described in the resource. Other reproduction and display of these resources is prohibited. No license is granted to any other TI intellectual property right or to any third party intellectual property right. TI disclaims responsibility for, and you will fully indemnify TI and its representatives against, any claims, damages, costs, losses, and liabilities arising out of your use of these resources.

TI's products are provided subject to [TI's Terms of Sale](#) or other applicable terms available either on [ti.com](https://www.ti.com) or provided in conjunction with such TI products. TI's provision of these resources does not expand or otherwise alter TI's applicable warranties or warranty disclaimers for TI products.

TI objects to and rejects any additional or different terms you may have proposed.

Mailing Address: Texas Instruments, Post Office Box 655303, Dallas, Texas 75265
Copyright © 2024, Texas Instruments Incorporated