

Description

The TPS53355 Inductor-On-Top Step-Down Buck Converter reference design enables reduction of X-Y area while enabling >86% efficiency with only 1.8W of power loss and 6mV of output voltage ripple with only 5x100uF ceramic output caps. This power reference design supports a 12V input and a 1V output at 12A and switches at 650 KHz.

TPS53355EVM Set up

- **VIN**=12V
- **VOUT**=1V
- **IOUT**=E-Load Dynamic: 3A to 6A at ~2.5A/μs & Static=6A
- **IOUT_Max**=12A
- **COUT**=5x100μF_Ceramic, 6.3V
- **Inductor**=Pulse PA4200.471HL
- **FREQ**=650kHz
- **Temperature**=25°C
- **Min Bias Voltage** = 4.5 V

TPS53355 EVM Schematic

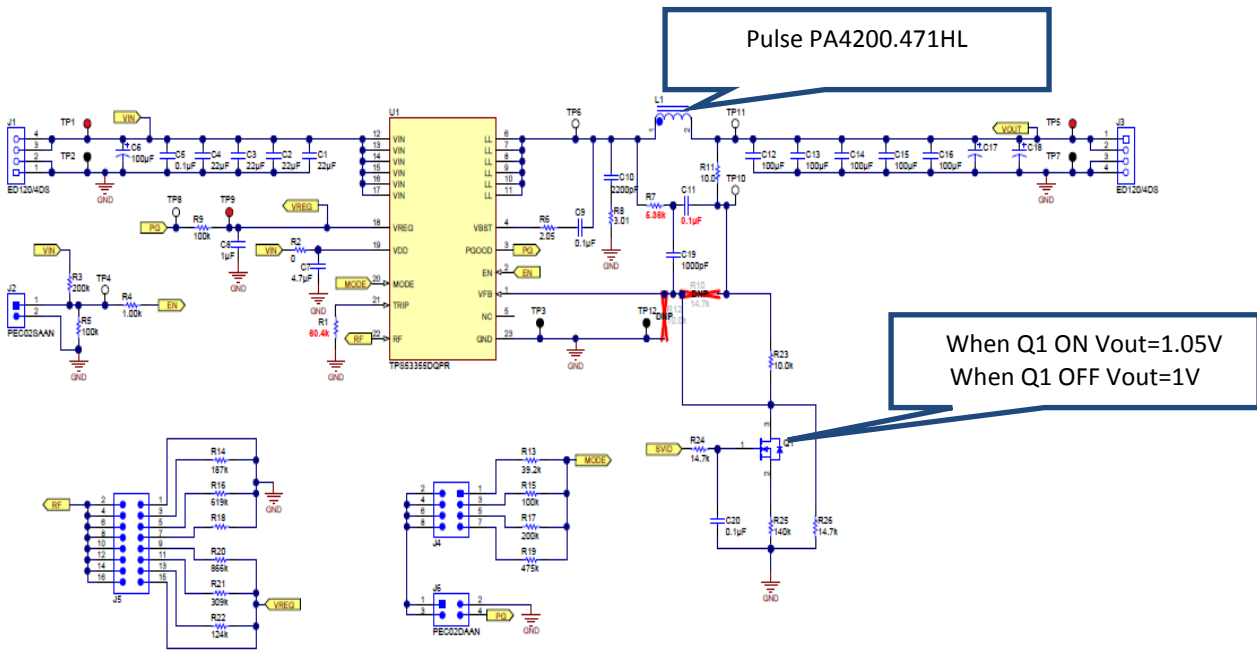

TPS53355 L-TOP Pictures

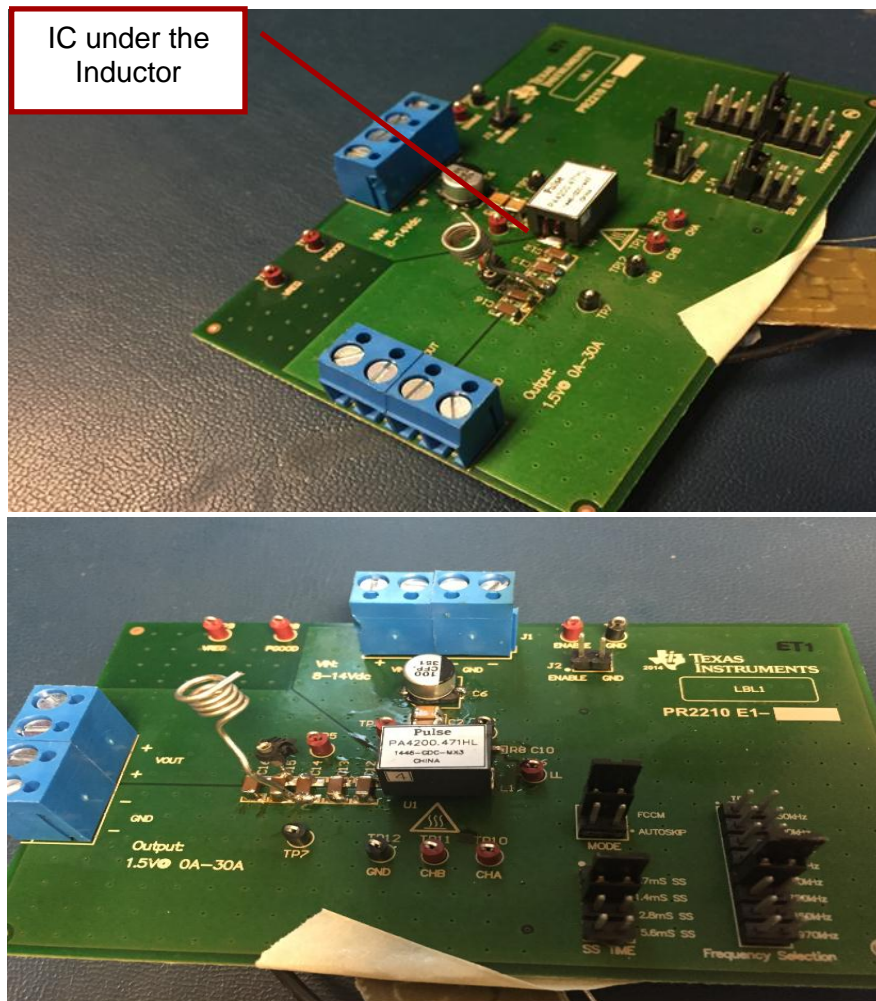

TIDA-00471 Synchronous DC/DC Converter with Inductor on top of IC for Small Footprint

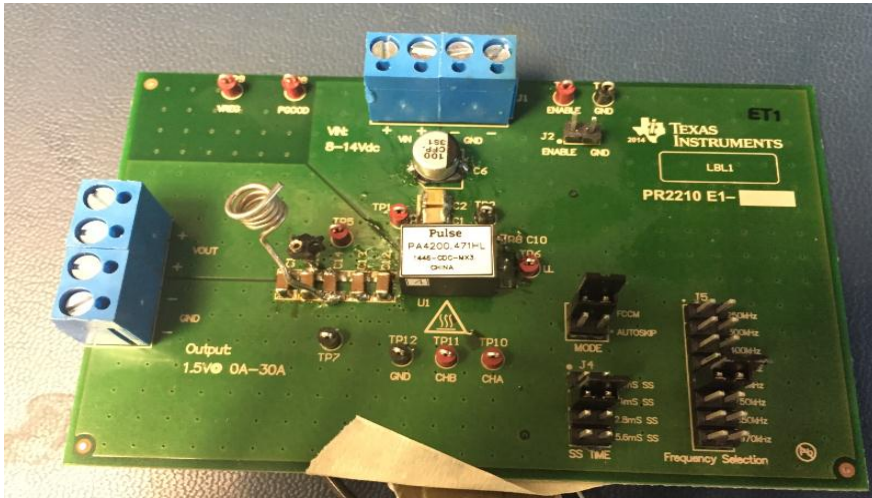

Efficiency Performance

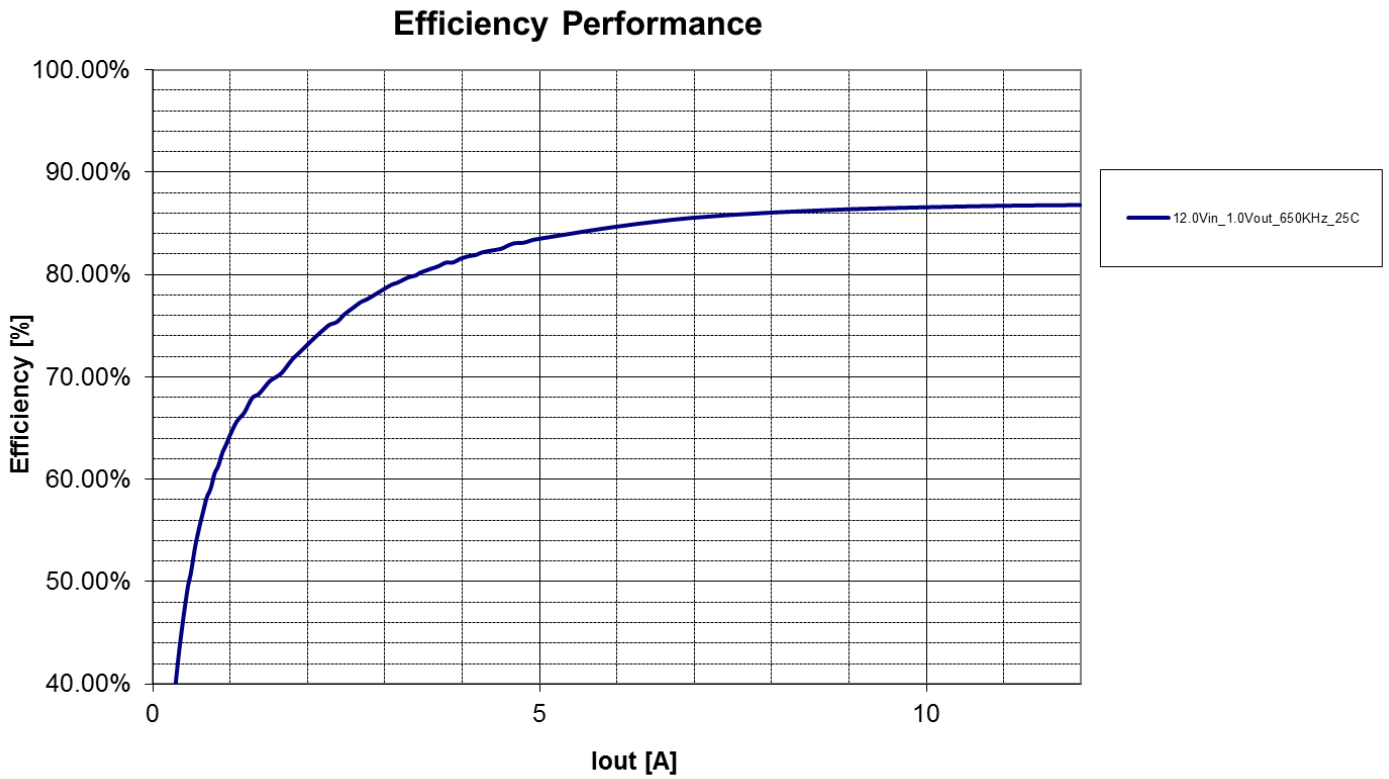

Frequency Performance

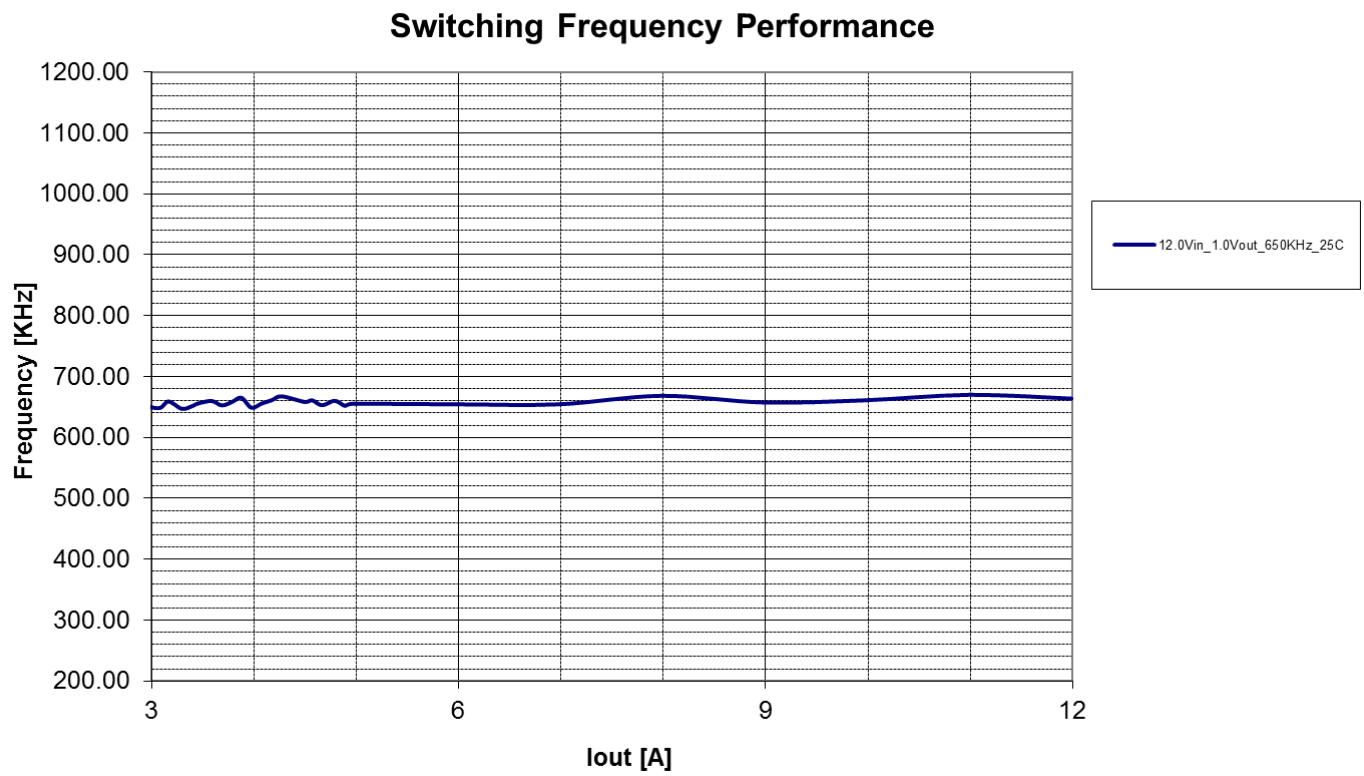

VOUT Load Regulation Performance

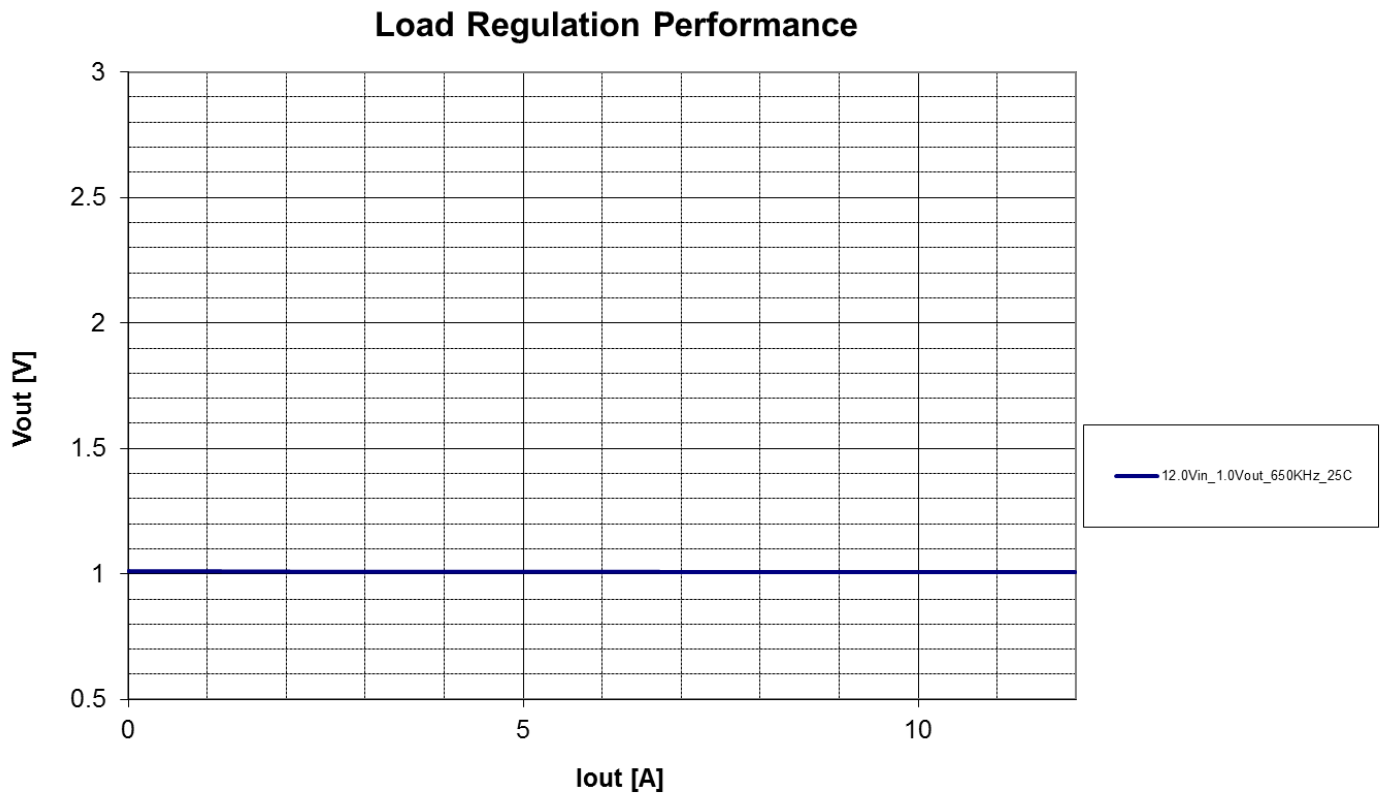

Power Loss Performance



VOUT Ripple Test

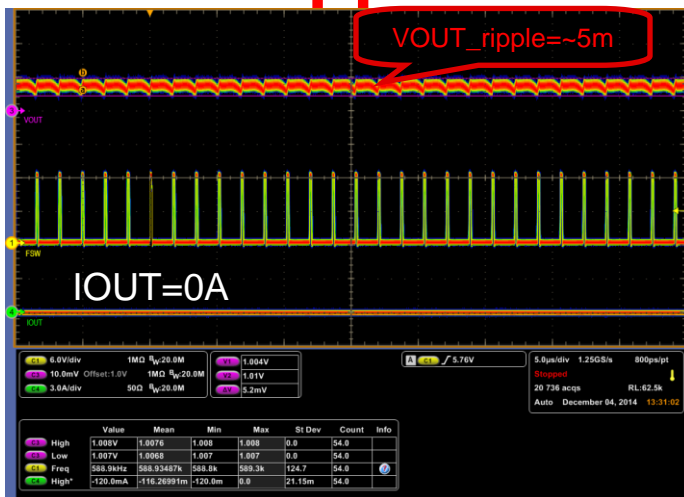

TIDA-00471 Synchronous DC/DC Converter with Inductor on top of IC for Small Footprint

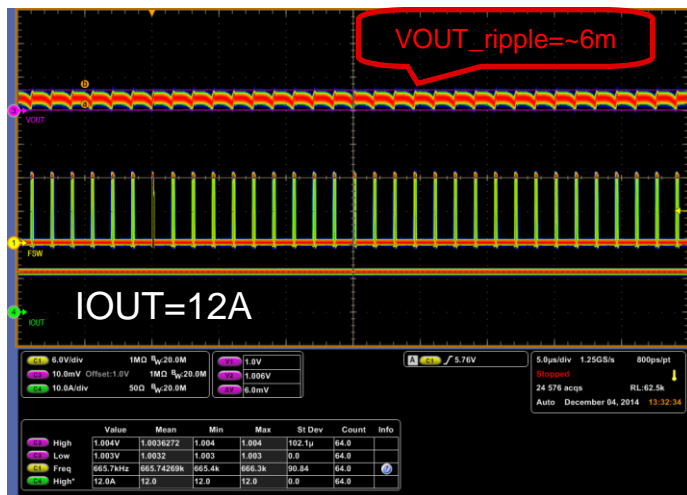
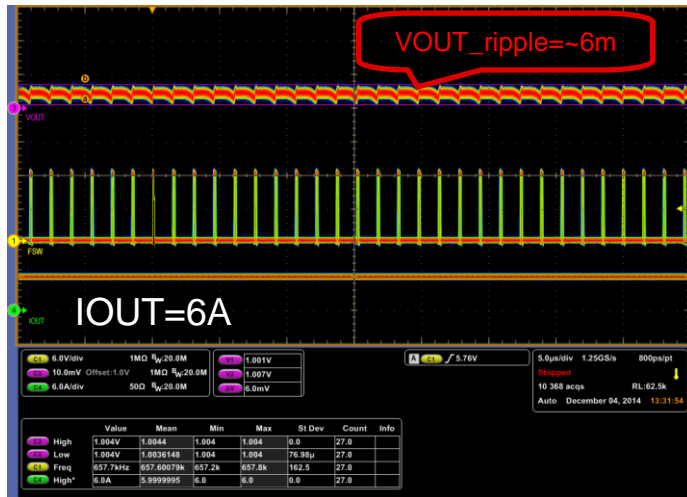

Under/Overshoot Measurements

IOU=3A to 6A @ 2.5A/μs (E-Load)

TIDA-00471 Synchronous DC/DC Converter with Inductor on top of IC for Small Footprint

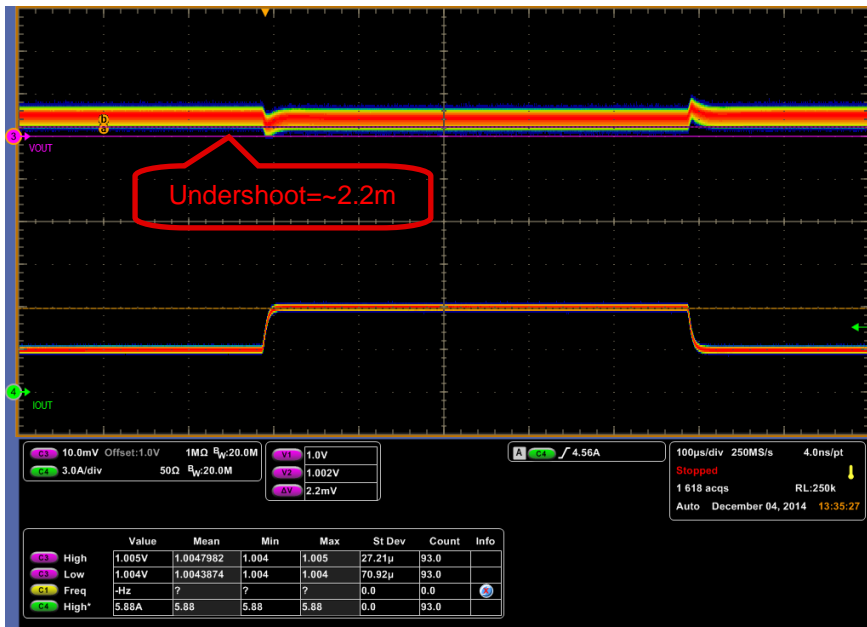

Transient Performance

I_{OUT}=3A to 6A@2.5A/µs(E-Load)

TIDA-00471 Synchronous DC/DC Converter with Inductor on top of IC for Small Footprint

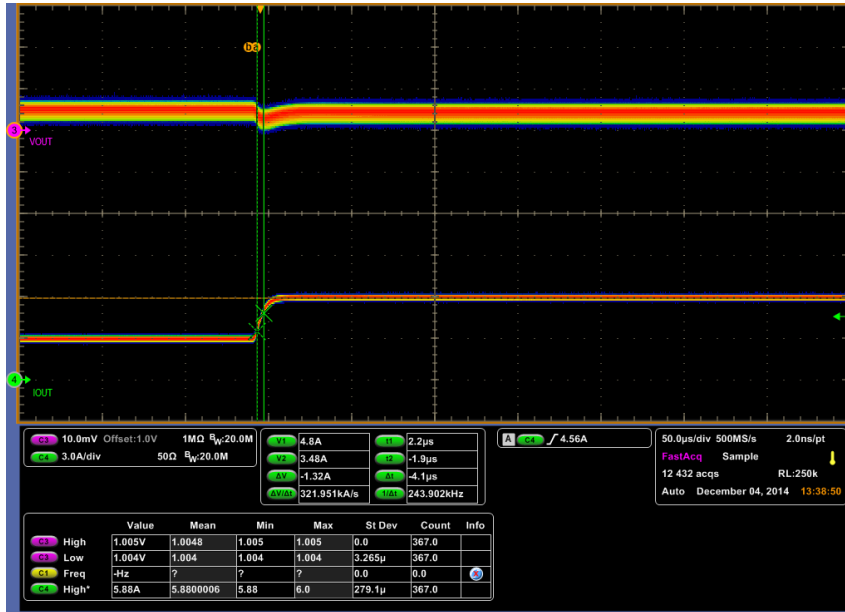

Jitter Performance

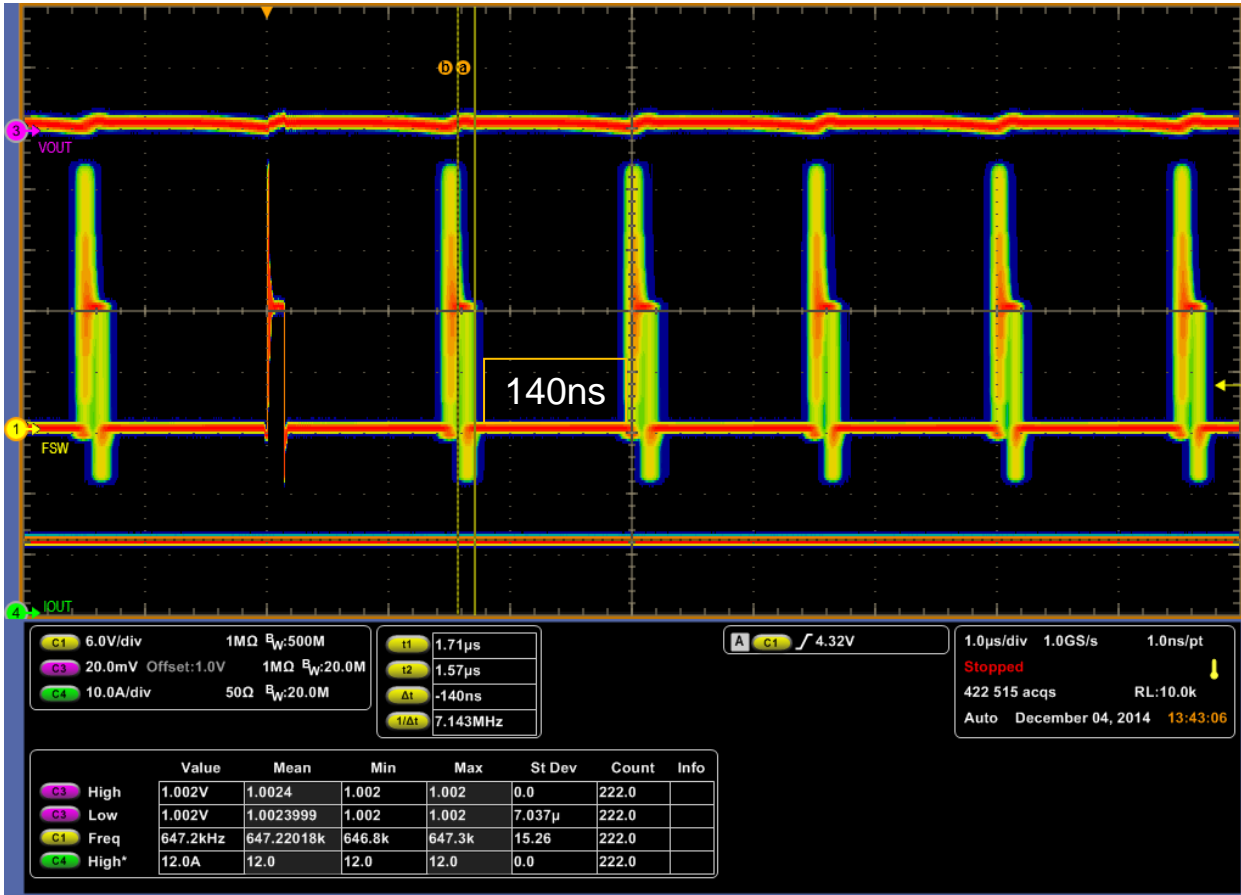

IC Case Temperature

Vin=12V, Vout=1.05V, Amb=25°C, Wait 10min

Load (A)	Case Temp (°C)
0	27.9
3	30.4
6	31.9
9	34

TIDA-00471 Synchronous DC/DC Converter with Inductor on top of IC for Small Footprint

12	38.3		

Temperature



Image and Object Parameters

Camera Model FLIR T300

Text Comments

Due to the location of the IC, the measurement is just an estimate and it may not be accurate

Image Date 12/4/2014 10:54:45 PM

Image Name IR_0332.jpg

Emissivity 0.98

Reflected apparent temperature 25.0 °C

Object Distance 0.8 ft

Description

Vin=12V, Vout=1.05V, Iout=0A

TIDA-00471 Synchronous DC/DC Converter with Inductor on top of IC for Small Footprint

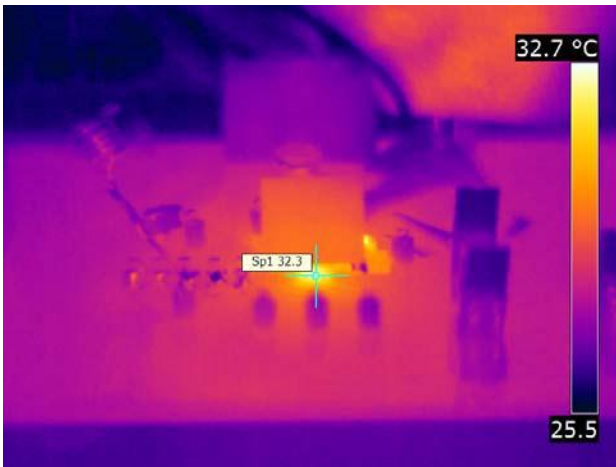

Image and Object Parameters

Camera Model FLIR T300

Text Comments

Due to the location of the IC, the measurement is just an estimate and it may not be accurate

Image Date 12/4/2014 11:19:47 PM

Image Name IR_0333.jpg

Emissivity 0.98

Reflected apparent temperature 25.0 °C

Object Distance 0.8 ft

Description

Vin=12V, Vout=1.05V, Iout=6A



Image and Object Parameters

Camera Model FLIR T300

Image Date 12/4/2014 11:42:50 PM

Image Name IR_0334.jpg

Emissivity 0.98

Reflected apparent temperature 25.0 °C

Object Distance 0.8 ft

Text Comments

Due to the location of the IC, the measurement is just an estimate and it may not be accurate

Description

Vin=12V, Vout=1.05V, Iout=12A

IMPORTANT NOTICE AND DISCLAIMER

TI PROVIDES TECHNICAL AND RELIABILITY DATA (INCLUDING DATA SHEETS), DESIGN RESOURCES (INCLUDING REFERENCE DESIGNS), APPLICATION OR OTHER DESIGN ADVICE, WEB TOOLS, SAFETY INFORMATION, AND OTHER RESOURCES "AS IS" AND WITH ALL FAULTS, AND DISCLAIMS ALL WARRANTIES, EXPRESS AND IMPLIED, INCLUDING WITHOUT LIMITATION ANY IMPLIED WARRANTIES OF MERCHANTABILITY, FITNESS FOR A PARTICULAR PURPOSE OR NON-INFRINGEMENT OF THIRD PARTY INTELLECTUAL PROPERTY RIGHTS.

These resources are intended for skilled developers designing with TI products. You are solely responsible for (1) selecting the appropriate TI products for your application, (2) designing, validating and testing your application, and (3) ensuring your application meets applicable standards, and any other safety, security, regulatory or other requirements.

These resources are subject to change without notice. TI grants you permission to use these resources only for development of an application that uses the TI products described in the resource. Other reproduction and display of these resources is prohibited. No license is granted to any other TI intellectual property right or to any third party intellectual property right. TI disclaims responsibility for, and you will fully indemnify TI and its representatives against, any claims, damages, costs, losses, and liabilities arising out of your use of these resources.

TI's products are provided subject to [TI's Terms of Sale](#) or other applicable terms available either on ti.com or provided in conjunction with such TI products. TI's provision of these resources does not expand or otherwise alter TI's applicable warranties or warranty disclaimers for TI products.

TI objects to and rejects any additional or different terms you may have proposed.

Mailing Address: Texas Instruments, Post Office Box 655303, Dallas, Texas 75265
Copyright © 2021, Texas Instruments Incorporated