

THS6212 差分宽带 PLC 线路驱动器放大器

1 特性

- 低功耗：
 - 满偏置模式：23mA
 - 中偏置模式：17.5mA
 - 低偏置模式：11.9mA
 - 低功耗关断模式
 - IADJ 引脚，用于调节偏置电流
- 低噪声：
 - 电压噪声：2.5nV/√Hz
 - 反相电流噪声：18pA/√Hz
 - 同相电流噪声：1.4pA/√Hz
- 低失真：
 - 86dBc HD2 (1MHz, 100Ω 差分负载)
 - 101dBc HD3 (1MHz, 100Ω 差分负载)
- 高输出电流：> 665mA (25Ω 负载)
- 宽输出摆幅：
 - 49V_{PP} (28V, 100Ω 差分负载)
- 高带宽：205MHz (G_{DIFF} = 10V/V)
- PSRR：在 1MHz 频率下提供 >55dB 的良好隔离
- 宽电源电压范围：10V 至 28V
- 过热保护：175°C (典型值)
- 具有集成共模缓冲器的替代器件：[THS6222](#)

2 应用

- 高电压、高电流驱动
- 宽带电力线通信

3 说明

THS6212 是一款具有电流反馈架构的差分线路驱动器放大器。该器件专用于宽带电力线通信 (PLC) 线路驱动器应用，运行速度飞快，足以支持 14.5dBm 线路功率的传输 (在最高 30MHz 的频率下)。

THS6212 采用独特架构，在更大限度降低静态电流的同时仍能实现超高线性度。满偏置条件下的差分失真在 1MHz 时为 -86dBc，在 10MHz 时降至仅 -71dBc。这款放大器具有多种固定偏置设置，对于无需放大器发挥全部性能的线路驱动器而言，可显著节能。此外，还可以通过可调电流引脚 (IADJ) 进一步降低偏置电流，从而实现更为出色的灵活性与节能效果。

49V_{PP} (100Ω 差分负载) 的宽输出摆幅搭配 28V 电源以及超过 650mA 的电流驱动能力 (25Ω 负载)，使得该器件拥有较宽的动态余量，能够将失真限制在尽可能低的水平。

THS6212 采用 24 引脚 VQFN 封装。

封装信息

器件型号	封装 ⁽¹⁾	封装尺寸 ⁽²⁾
THS6212	RHF (VQFN, 24)	5mm × 4mm

(1) 有关更多信息，请参阅节 10。

(2) 封装尺寸 (长 × 宽) 为标称值，并包括引脚 (如适用)。

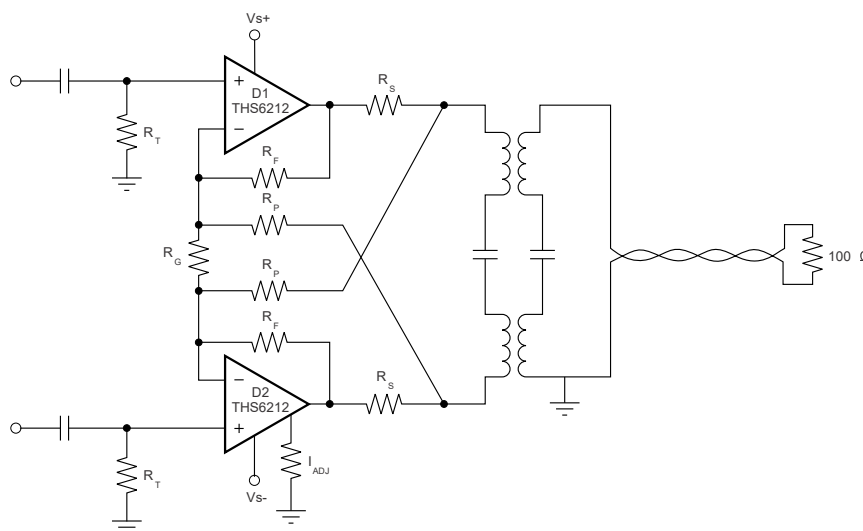

采用 THS6212 的典型线路驱动器电路



Table of Contents

1 特性	1	6.4 Device Functional Modes.....	23
2 应用	1	7 Application and Implementation	24
3 说明	1	7.1 Application Information.....	24
4 Pin Configuration and Functions	3	7.2 Typical Applications.....	24
5 Specifications	4	7.3 Best Design Practices.....	30
5.1 Absolute Maximum Ratings.....	4	7.4 Power Supply Recommendations.....	31
5.2 ESD Ratings.....	4	7.5 Layout.....	32
5.3 Recommended Operating Conditions.....	4	8 Device and Documentation Support	35
5.4 Thermal Information.....	4	8.1 Documentation Support.....	35
5.5 Electrical Characteristics $V_S = 12\text{ V}$	5	8.2 接收文档更新通知.....	35
5.6 Electrical Characteristics $V_S = 28\text{ V}$	8	8.3 支持资源.....	35
5.7 Timing Requirements.....	9	8.4 Trademarks.....	35
5.8 Typical Characteristics: $V_S = 12\text{ V}$	10	8.5 静电放电警告.....	35
5.9 Typical Characteristics: $V_S = 28\text{ V}$	16	8.6 术语表.....	35
6 Detailed Description	19	9 Revision History	35
6.1 Overview.....	19	10 Mechanical, Packaging, and Orderable Information	37
6.2 Functional Block Diagram.....	19		
6.3 Feature Description.....	20		

4 Pin Configuration and Functions



图 4-1. RHF Package, 24-Pin VQFN With Exposed Thermal Pad (Top View)

表 4-1. Pin Functions⁽¹⁾

PIN		TYPE	DESCRIPTION
NAME	NO.		
BIAS-1	23	Input	Bias mode parallel control, LSB
BIAS-2	24	Input	Bias mode parallel control, MSB
D1_FB	19	Input	Amplifier D1 inverting input
D2_FB	18	Input	Amplifier D2 inverting input
D1_IN+	1	Input	Amplifier D1 noninverting input
D2_IN+	2	Input	Amplifier D2 noninverting input
D1_OUT	20	Output	Amplifier D1 output
D2_OUT	17	Output	Amplifier D2 output
GND ⁽²⁾	3	Input/Output	Control pin ground reference
IADJ	4	Input/Output	Bias current adjustment pin
NC	5-16	—	No internal connection
VS -	22	Input/Output	Negative power-supply connection
VS+	21	Input/Output	Positive power-supply connection

(1) The THS6212 defaults to the shutdown (disable) state if a signal is not present on the bias pins.

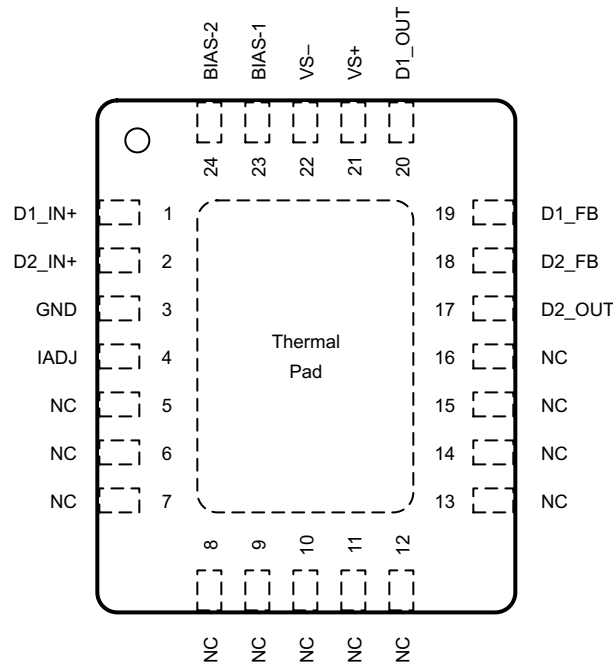
(2) The GND pin ranges from VS - to (VS+ - 5 V).

5 Specifications

5.1 Absolute Maximum Ratings

over operating free-air temperature range (unless otherwise noted)⁽¹⁾

		MIN	MAX	UNIT
Voltage	Supply voltage, $V_S = (V_{S+}) - (V_{S-})$		28	V
	Bias control pin voltage, referenced to GND pin	0	14.5	V
	All pins except V_{S+} , V_{S-} , and BIAS control	$(V_{S-}) - 0.5$	$(V_{S+}) + 0.5$	V
	Differential input voltage (each amplifier), V_{ID}		±2	V
Current	All input pins, current limit		±10	mA
	Continuous power dissipation ⁽²⁾	See Thermal Information table		
Temperature	Maximum junction, T_J (under any condition) ⁽³⁾		150	°C
	Storage, T_{stg}	- 65	150	°C

- (1) Stresses beyond those listed under [Absolute Maximum Rating](#) may cause permanent damage to the device. These are stress ratings only, which do not imply functional operation of the device at these or any other conditions beyond those indicated under [Recommended Operating Condition](#). Exposure to absolute-maximum-rated conditions for extended periods may affect device reliability.
- (2) The THS6212 incorporates a thermal pad on the underside of the device. This pad functions as a heat sink and must be connected to a thermally dissipating plane for proper power dissipation. Failure to do so can result in exceeding the maximum junction temperature, which can permanently damage the device.
- (3) The absolute maximum junction temperature under any condition is limited by the constraints of the silicon process.

5.2 ESD Ratings

			VALUE	UNIT
$V_{(ESD)}$	Electrostatic discharge	Human body model (HBM), per ANSI/ESDA/JEDEC JS-001, all pins ⁽¹⁾	±2000	V
		Charged device model (CDM), per JEDEC specification JESD22-C101, all pins ⁽²⁾	±500	

- (1) JEDEC document JEP155 states that 500-V HBM allows safe manufacturing with a standard ESD control process.
- (2) JEDEC document JEP157 states that 250-V CDM allows safe manufacturing with a standard ESD control process.

5.3 Recommended Operating Conditions

over operating free-air temperature range (unless otherwise noted)

		MIN	NOM	MAX	UNIT
V_S	Supply voltage, $V_S = (V_{S+}) - (V_{S-})$	10		28	V
V_{GND}	GND pin voltage	V_{S-}		$V_{S+} - 5$	V
T_J	Operating junction temperature			125	°C
T_A	Ambient operating air temperature	- 40	25	85	°C

5.4 Thermal Information

THERMAL METRIC ⁽¹⁾		THS6212	UNIT
		RHF (VQFN)	
		24 PINS	
$R_{\theta JA}$	Junction-to-ambient thermal resistance	42.3	°C/W
$R_{\theta JC(top)}$	Junction-to-case (top) thermal resistance	32.8	°C/W
$R_{\theta JB}$	Junction-to-board thermal resistance	20.9	°C/W
Ψ_{JT}	Junction-to-top characterization parameter	3.8	°C/W
Ψ_{JB}	Junction-to-board characterization parameter	20.9	°C/W

5.4 Thermal Information (续)

THERMAL METRIC ⁽¹⁾		THS6212	UNIT
		RHF (VQFN)	
		24 PINS	
$R_{\theta JC(bot)}$	Junction-to-case (bottom) thermal resistance	9.5	°C/W

(1) For information about traditional and new thermal metrics, see the [Semiconductor and IC Package Thermal Metrics](#) application report.

5.5 Electrical Characteristics $V_S = 12\text{ V}$

at $T_A \approx 25^\circ\text{C}$, differential closed-loop gain (A_V) = 10 V/V, differential load (R_L) = 50 Ω , series isolation resistor (R_S) = 2.5 Ω each, $R_F = 1.24\text{ k}\Omega$, $R_{ADJ} = 0\ \Omega$, $V_O = D1_OUT - D2_OUT$, and full bias (unless otherwise noted)

PARAMETER		TEST CONDITIONS	MIN	TYP	MAX	UNIT
AC PERFORMANCE						
SSBW	Small-signal bandwidth	$A_V = 5\text{ V/V}$, $R_F = 1.5\text{ k}\Omega$, $V_O = 2\text{ V}_{PP}$		250		MHz
		$A_V = 10\text{ V/V}$, $R_F = 1.24\text{ k}\Omega$, $V_O = 2\text{ V}_{PP}$		180		
		$A_V = 15\text{ V/V}$, $R_F = 1\text{ k}\Omega$, $V_O = 2\text{ V}_{PP}$		165		
	0.1-dB bandwidth flatness			17		MHz
LSBW	Large-signal bandwidth	$V_O = 16\text{ V}_{PP}$		195		MHz
SR	Slew rate (20% to 80%)	$V_O = 16\text{-V step}$		5500		V/ μs
	Rise and fall time (10% to 90%)	$V_O = 2\text{ V}_{PP}$		2.1		ns
HD2	2nd-order harmonic distortion	$A_V = 10\text{ V/V}$, $V_O = 2\text{ V}_{PP}$, $R_L = 50\ \Omega$	Full bias, $f = 1\text{ MHz}$		-80	dBc
			Mid bias, $f = 1\text{ MHz}$		-78	
			Low bias, $f = 1\text{ MHz}$		-78	
			Full bias, $f = 10\text{ MHz}$		-61	
			Mid bias, $f = 10\text{ MHz}$		-61	
			Low bias, $f = 10\text{ MHz}$		-61	
HD3	3rd-order harmonic distortion	$A_V = 10\text{ V/V}$, $V_O = 2\text{ V}_{PP}$, $R_L = 50\ \Omega$	Full bias, $f = 1\text{ MHz}$		-90	dBc
			Mid bias, $f = 1\text{ MHz}$		-86	
			Low bias, $f = 1\text{ MHz}$		-83	
			Full bias, $f = 10\text{ MHz}$		-69	
			Mid bias, $f = 10\text{ MHz}$		-65	
			Low bias, $f = 10\text{ MHz}$		-62	
e_n	Differential input voltage noise	$f \geq 1\text{ MHz}$, input-referred		2.5		nV/ $\sqrt{\text{Hz}}$
i_{n+}	Noninverting input current noise	$f \geq 1\text{ MHz}$, each amplifier		1.4		pA/ $\sqrt{\text{Hz}}$
i_{n-}	Inverting input current noise	$f \geq 1\text{ MHz}$, each amplifier		18		pA/ $\sqrt{\text{Hz}}$
DC PERFORMANCE						
Z_{OL}	Open-loop transimpedance gain			1300		k Ω
	Input offset voltage (each amplifier)			± 12		mV
		$T_A = -40^\circ\text{C}$		± 16		
		$T_A = 85^\circ\text{C}$		± 11		
	Noninverting input bias current			± 1		μA
		$T_A = -40^\circ\text{C}$		± 1		
		$T_A = 85^\circ\text{C}$		± 1		
	Inverting input bias current			± 8		μA
		$T_A = -40^\circ\text{C}$		± 7		
		$T_A = 85^\circ\text{C}$		± 4		

5.5 Electrical Characteristics $V_S = 12\text{ V}$ (续)

at $T_A \cong 25^\circ\text{C}$, differential closed-loop gain (A_V) = 10 V/V, differential load (R_L) = 50 Ω , series isolation resistor (R_S) = 2.5 Ω each, $R_F = 1.24\text{ k}\Omega$, $R_{ADJ} = 0\ \Omega$, $V_O = D1_OUT - D2_OUT$, and full bias (unless otherwise noted)

PARAMETER		TEST CONDITIONS	MIN	TYP	MAX	UNIT
INPUT CHARACTERISTICS						
	Common-mode input voltage	Each input with respect to midsupply		± 3.0		V
CMRR	Common-mode rejection ratio	Each input		64		dB
		$T_A = -40^\circ\text{C}$		67		
		$T_A = 85^\circ\text{C}$		62		
	Noninverting differential input resistance			10 2		k Ω pF
	Inverting input resistance			43		Ω

5.5 Electrical Characteristics $V_S = 12\text{ V}$ (续)

at $T_A \cong 25^\circ\text{C}$, differential closed-loop gain (A_V) = 10 V/V, differential load (R_L) = 50 Ω , series isolation resistor (R_S) = 2.5 Ω each, $R_F = 1.24\text{ k}\Omega$, $R_{ADJ} = 0\ \Omega$, $V_O = \text{D1_OUT} - \text{D2_OUT}$, and full bias (unless otherwise noted)

PARAMETER		TEST CONDITIONS	MIN	TYP	MAX	UNIT
OUTPUT CHARACTERISTICS						
V_O	Output voltage swing	$R_L = 100\ \Omega$, $R_S = 0\ \Omega$		± 9.7		V
		$R_L = 50\ \Omega$, $R_S = 0\ \Omega$		± 9.3		
		$R_L = 25\ \Omega$, $R_S = 0\ \Omega$		± 8.4		
I_O	Output current (sourcing and sinking)	$R_L = 25\ \Omega$, $R_S = 0\ \Omega$, based on V_O specification		± 338		mA
	Short-circuit output current			± 0.81		A
Z_O	Closed-loop output impedance	$f = 1\text{ MHz}$, differential		0.03		Ω
POWER SUPPLY						
V_S	Operating voltage		10	12	28	V
		$T_A = -40^\circ\text{C}$ to $+85^\circ\text{C}$	10		28	
V_{GND}	GND pin voltage		V_{S-}	0	$V_{S+} - 5$	V
I_{S+}	Quiescent current, positive rail, V_{S+}	Full bias (BIAS-1 = 0, BIAS-2 = 0)		19.5		mA
		Mid bias (BIAS-1 = 1, BIAS-2 = 0)		15		
		Low bias (BIAS-1 = 0, BIAS-2 = 1)		10.4		
		Bias off (BIAS-1 = 1, BIAS-2 = 1)		0.8		
I_{S-}	Quiescent current, negative rail, V_{S-}	Full bias (BIAS-1 = 0, BIAS-2 = 0)		18.8		mA
		Mid bias (BIAS-1 = 1, BIAS-2 = 0)		14.4		
		Low bias (BIAS-1 = 0, BIAS-2 = 1)		9.6		
		Bias off (BIAS-1 = 1, BIAS-2 = 1)		0.01		
	Current through GND pin	Full bias (BIAS-1 = 0, BIAS-2 = 0)		0.8		mA
+PSRR	Positive power-supply rejection ratio	Differential		83		dB
- PSRR	Negative power-supply rejection ratio	Differential		83		dB
BIAS CONTROL						
	Bias control pin voltage	With respect to GND pin, $T_A = -40^\circ\text{C}$ to $+85^\circ\text{C}$	0	3.3	12	V
	Bias control pin logic threshold	Logic 1, with respect to GND pin, $T_A = -40^\circ\text{C}$ to $+85^\circ\text{C}$	2.1			V
		Logic 0, with respect to GND pin, $T_A = -40^\circ\text{C}$ to $+85^\circ\text{C}$			0.8	
	Bias control pin current ⁽¹⁾	BIAS-1, BIAS-2 = 0.5 V (logic 0)		- 9.6		μA
		BIAS-1, BIAS-2 = 3.3 V (logic 1)		0.3	1	
	Open-loop output impedance	Off bias (BIAS-1 = 1, BIAS-2 = 1)		70 5		$\text{M}\ \Omega$ pF

(1) Current is considered positive out of the pin.

5.6 Electrical Characteristics $V_S = 28\text{ V}$

at $T_A \cong 25^\circ\text{C}$, differential closed-loop gain (A_V) = 10 V/V, differential load (R_L) = 100 Ω , $R_F = 1.24\text{ k}\Omega$, $R_{ADJ} = 0\ \Omega$, $V_O = D1_OUT - D2_OUT$, and full bias (unless otherwise noted)

PARAMETER		TEST CONDITIONS		MIN	TYP	MAX	UNIT
AC PERFORMANCE							
SSBW	Small-signal bandwidth, -3 dB	$A_V = 5\text{ V/V}$, $R_F = 1.5\text{ k}\Omega$, $V_O = 2\text{ V}_{PP}$			285		MHz
		$A_V = 10\text{ V/V}$, $R_F = 1.24\text{ k}\Omega$, $V_O = 2\text{ V}_{PP}$			205		
	0.1-dB bandwidth flatness				13		MHz
LSBW	Large-signal bandwidth	$V_O = 40\text{ V}_{PP}$			170		MHz
SR	Slew rate (20% to 80% level)	$V_O = 40\text{-V step}$			11,000		V/ μs
	Rise and fall time	$V_O = 2\text{ V}_{PP}$			2		ns
HD2	2nd-order harmonic distortion	$A_V = 10\text{ V/V}$, $V_O = 2\text{ V}_{PP}$, $R_L = 100\ \Omega$	Full bias, $f = 1\text{ MHz}$		-86		dBc
			Low bias, $f = 1\text{ MHz}$		-79		
			Full bias, $f = 10\text{ MHz}$		-71		
			Low bias, $f = 10\text{ MHz}$		-63		
HD3	3rd-order harmonic distortion	$A_V = 10\text{ V/V}$, $V_O = 2\text{ V}_{PP}$, $R_L = 100\ \Omega$	Full bias, $f = 1\text{ MHz}$		-101		dBc
			Low bias, $f = 1\text{ MHz}$		-88		
			Full bias, $f = 10\text{ MHz}$		-80		
			Low bias, $f = 10\text{ MHz}$		-65		
e_n	Differential input voltage noise	$f \geq 1\text{ MHz}$, input-referred			2.5		nV/ $\sqrt{\text{Hz}}$
i_{n+}	Noninverting input current noise (each amplifier)	$f \geq 1\text{ MHz}$			1.7		pA/ $\sqrt{\text{Hz}}$
i_{n-}	Inverting input current noise (each amplifier)	$f \geq 1\text{ MHz}$			18		pA/ $\sqrt{\text{Hz}}$
DC PERFORMANCE							
Z_{OL}	Open-loop transimpedance gain				1500		k Ω
	Input offset voltage				± 12		mV
	Input offset voltage drift	$T_A = -40^\circ\text{C to } +85^\circ\text{C}$			-40		$\mu\text{V}/^\circ\text{C}$
	Input offset voltage matching	Amplifier A to B			± 0.5		mV
	Noninverting input bias current				± 1		μA
	Inverting input bias current				± 6		μA
	Inverting input bias current matching				± 8		μA
INPUT CHARACTERISTICS							
	Common-mode input voltage	Each input		± 9	± 10		V
CMRR	Common-mode rejection ratio	Each input		53	65		dB
	Noninverting input resistance				10 2		k Ω pF
	Inverting input resistance				38		Ω
OUTPUT CHARACTERISTICS							
V_O	Output voltage swing ⁽¹⁾	$R_L = 100\ \Omega$			± 24.5		V
		$R_L = 25\ \Omega$			± 12.3		
I_O	Output current (sourcing and sinking) ⁽¹⁾	$R_L = 25\ \Omega$, based on V_O specification		± 580	± 665		mA
		Short-circuit output current			1		
Z_O	Output impedance	$f = 1\text{ MHz}$, differential			0.01		Ω

5.6 Electrical Characteristics $V_S = 28\text{ V}$ (续)

at $T_A \cong 25^\circ\text{C}$, differential closed-loop gain (A_V) = 10 V/V, differential load (R_L) = 100 Ω , $R_F = 1.24\text{ k}\Omega$, $R_{ADJ} = 0\ \Omega$, $V_O = D1_OUT - D2_OUT$, and full bias (unless otherwise noted)

PARAMETER		TEST CONDITIONS	MIN	TYP	MAX	UNIT
POWER SUPPLY						
V_S	Operating voltage		10	12	28	V
		$T_A = -40^\circ\text{C to } +85^\circ\text{C}$	10		28	
I_{S+}	Quiescent current, positive rail, V_{S+}	Full bias (BIAS-1 = 0, BIAS-2 = 0)		23		mA
		Mid bias (BIAS-1 = 1, BIAS-2 = 0)		17.5		
		Low bias (BIAS-1 = 0, BIAS-2 = 1)		11.9		
		Bias off (BIAS-1 = 1, BIAS-2 = 1)		1.1	1.3	
I_{S-}	Quiescent current, negative rail, V_{S-}	Full bias (BIAS-1 = 0, BIAS-2 = 0)		22		mA
		Mid bias (BIAS-1 = 1, BIAS-2 = 0)		16.4		
		Low bias (BIAS-1 = 0, BIAS-2 = 1)		10.8		
		Bias off (BIAS-1 = 1, BIAS-2 = 1)		0.1	0.8	
	Current through GND pin	Full bias (BIAS-1 = 0, BIAS-2 = 0)		1		mA
+PSRR	Positive power-supply rejection ratio	Differential		83		dB
- PSRR	Negative power-supply rejection ratio	Differential		77		dB
BIAS CONTROL						
	Bias control pin voltage	With respect to GND pin, $T_A = -40^\circ\text{C to } +85^\circ\text{C}$	0	3.3	14.5	V
	Bias control pin logic threshold	Logic 1, with respect to GND pin, $T_A = -40^\circ\text{C to } +85^\circ\text{C}$	1.9			V
		Logic 0, with respect to GND pin, $T_A = -40^\circ\text{C to } +85^\circ\text{C}$			0.8	
	Bias control pin current ⁽²⁾	BIAS-1, BIAS-2 = 0.5 V (logic 0)	- 15	- 10		μA
		BIAS-1, BIAS-2 = 3.3 V (logic 1)		0.1	1	

(1) See [Section 6.3.1](#) for output voltage vs output current characteristics.

(2) Current is considered positive out of the pin.

5.7 Timing Requirements

		MIN	NOM	MAX	UNIT
t_{ON}	Turn-on time delay: time for output to start tracking the input		25		ns
t_{OFF}	Turn-off time delay: time for output to stop tracking the input		275		ns

5.8 Typical Characteristics: $V_S = 12\text{ V}$

at $T_A \approx 25^\circ\text{C}$, $A_V = 10\text{ V/V}$, $R_F = 1.24\text{ k}\Omega$, $R_L = 50\ \Omega$, $R_S = 2.5\ \Omega$, $R_{ADJ} = 0\ \Omega$, full-bias mode (unless otherwise noted)



图 5-1. Small-Signal Frequency Response



图 5-2. Large-Signal Frequency Response

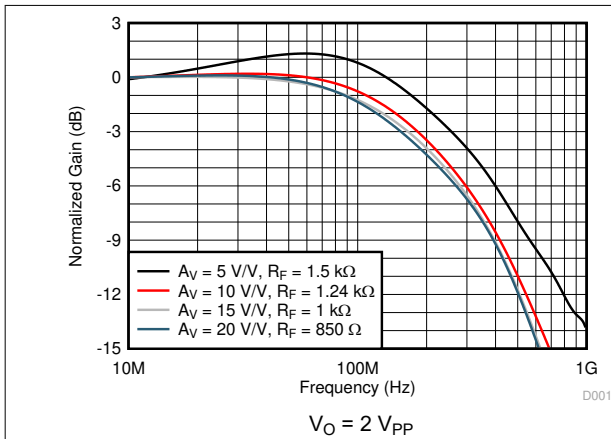

图 5-3. Out-of-Band Suppression

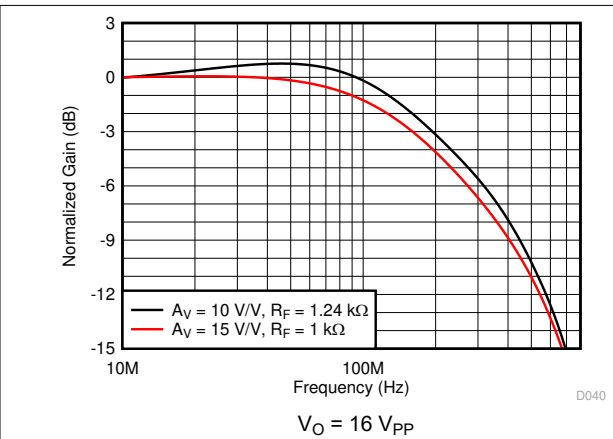

图 5-4. Small-Signal Frequency Response vs Temperature

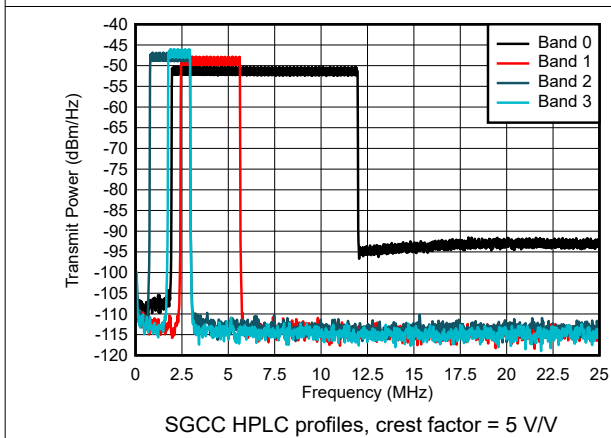

图 5-5. Small-Signal Frequency Response vs R_F

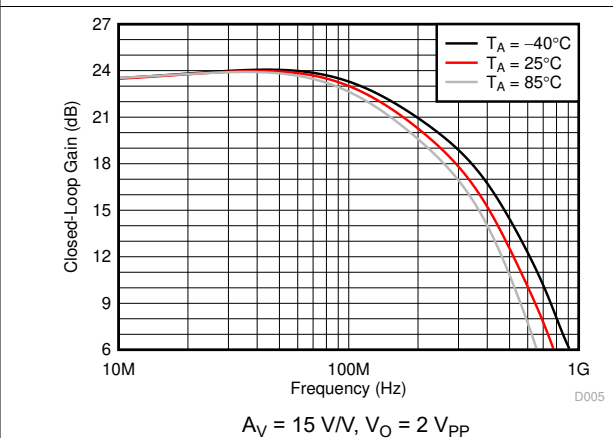

图 5-6. Small-Signal Frequency Response vs R_F

5.8 Typical Characteristics: $V_S = 12\text{ V}$ (continued)

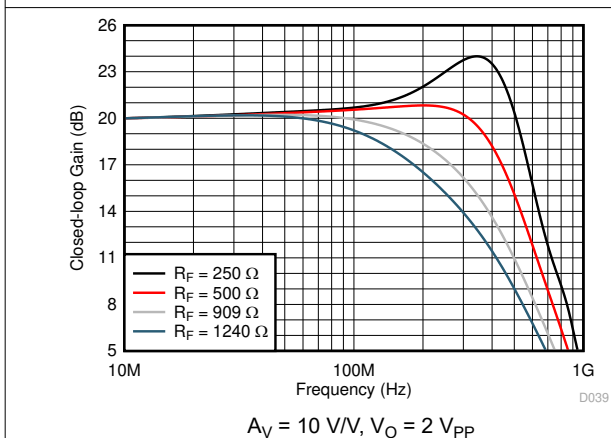
at $T_A \approx 25^\circ\text{C}$, $A_V = 10\text{ V/V}$, $R_F = 1.24\text{ k}\Omega$, $R_L = 50\ \Omega$, $R_S = 2.5\ \Omega$, $R_{ADJ} = 0\ \Omega$, full-bias mode (unless otherwise noted)

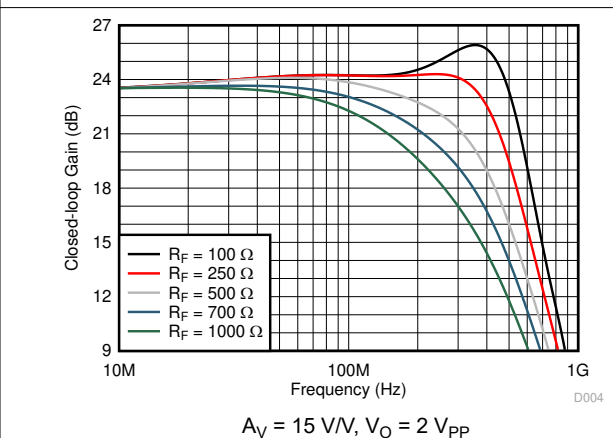
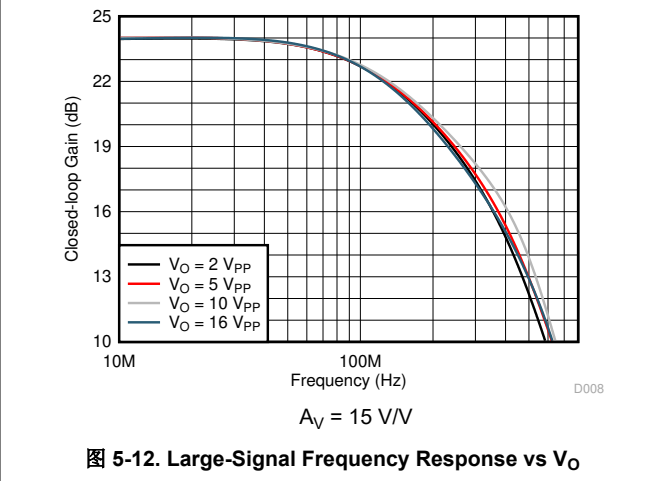
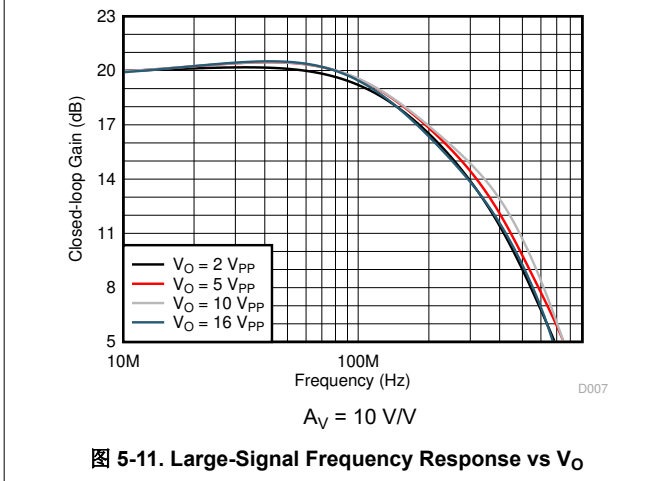
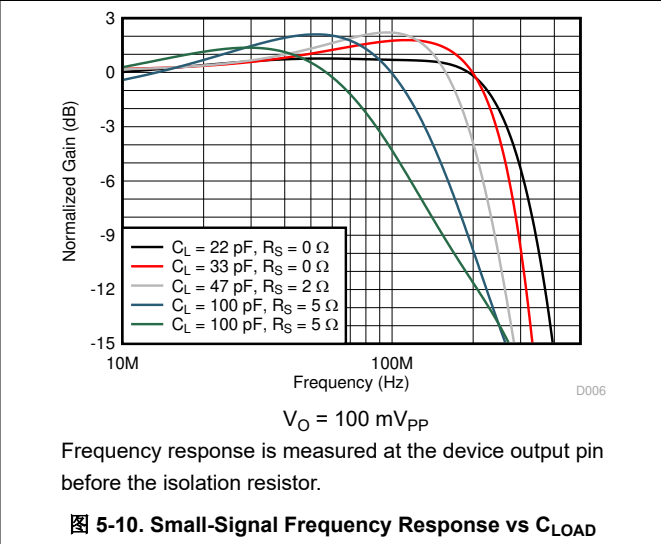
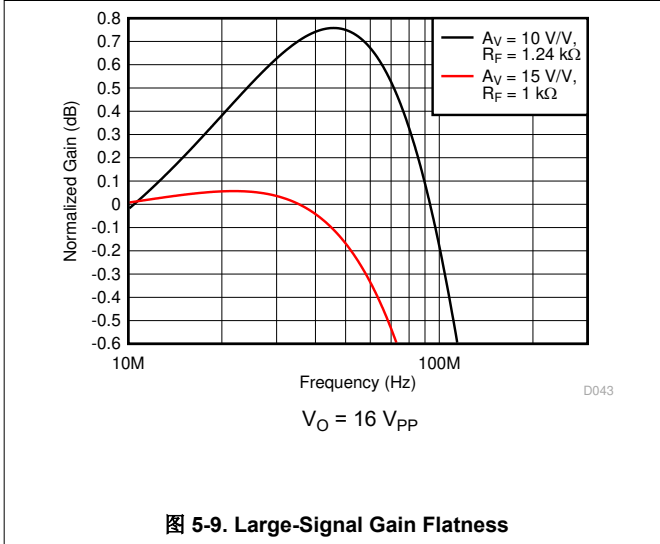
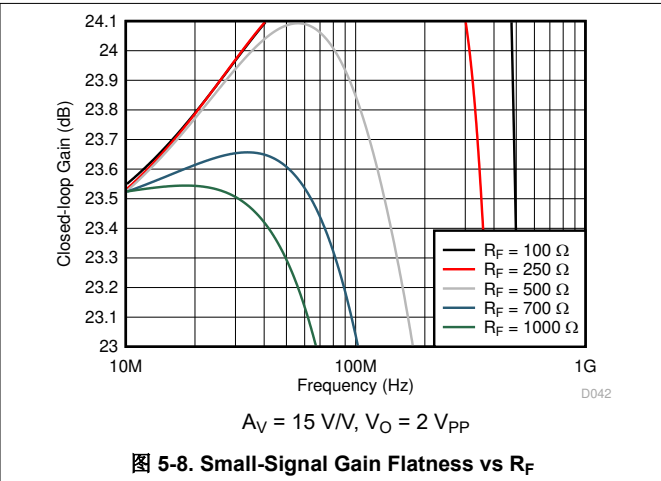
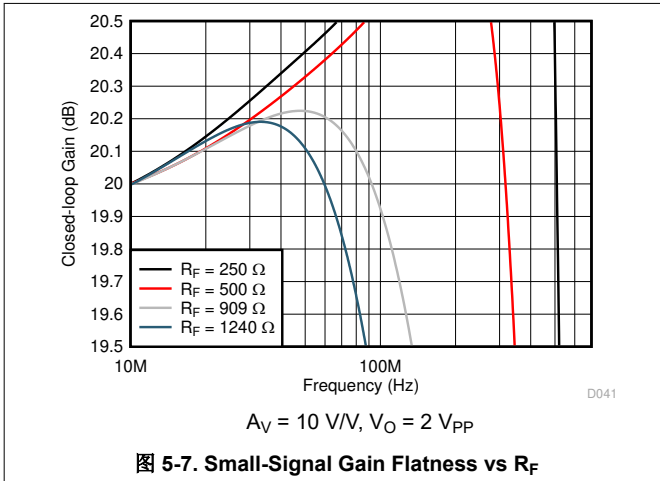

5.8 Typical Characteristics: $V_S = 12\text{ V}$ (continued)

at $T_A \approx 25^\circ\text{C}$, $A_V = 10\text{ V/V}$, $R_F = 1.24\text{ k}\Omega$, $R_L = 50\ \Omega$, $R_S = 2.5\ \Omega$, $R_{ADJ} = 0\ \Omega$, full-bias mode (unless otherwise noted)



图 5-13. Small-Signal Frequency Response vs Bias Modes



图 5-14. Small-Signal Frequency Response vs Bias Modes

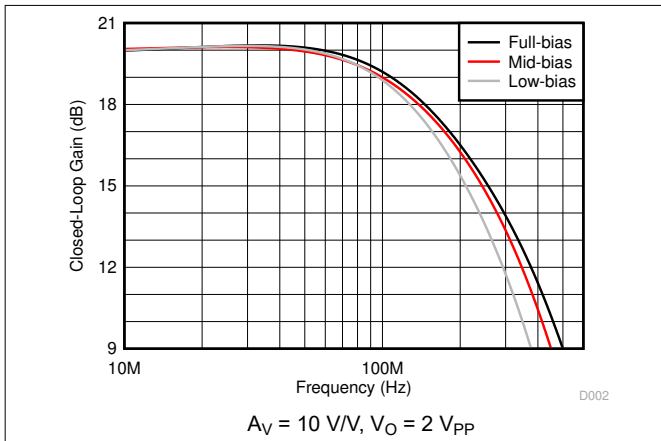

图 5-15. Large-Signal Frequency Response vs Bias Modes

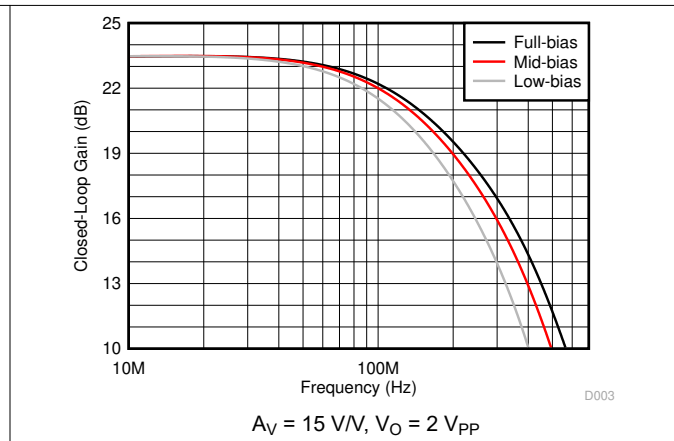

图 5-16. Input Voltage and Current Noise Density vs Frequency

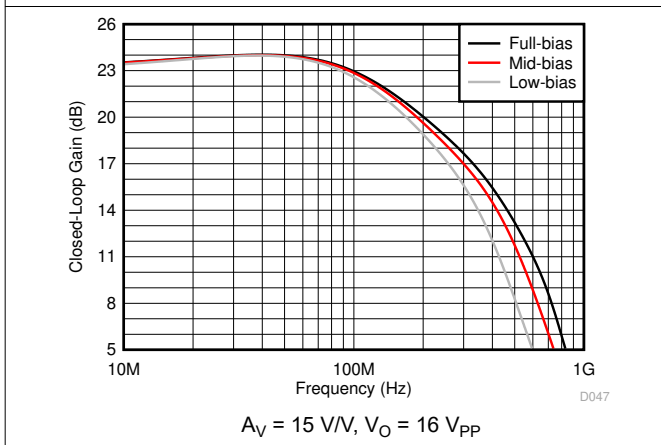

图 5-17. Harmonic Distortion vs Frequency

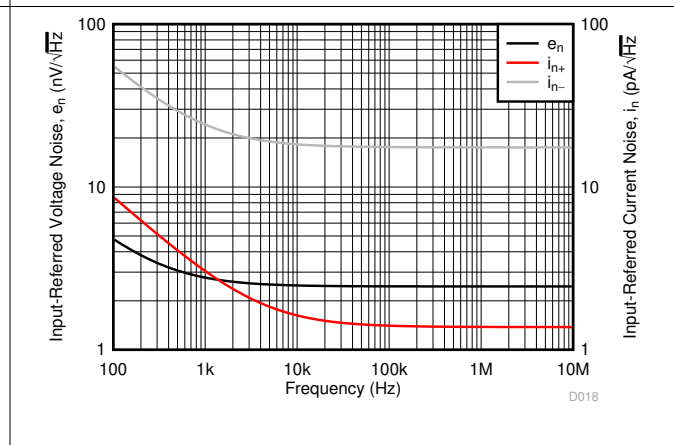

图 5-18. Harmonic Distortion vs Gain

5.8 Typical Characteristics: $V_S = 12\text{ V}$ (continued)

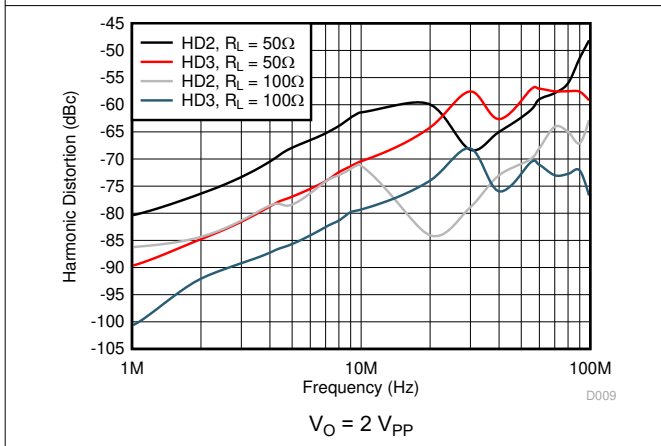
at $T_A \approx 25^\circ\text{C}$, $A_V = 10\text{ V/V}$, $R_F = 1.24\text{ k}\Omega$, $R_L = 50\ \Omega$, $R_S = 2.5\ \Omega$, $R_{ADJ} = 0\ \Omega$, full-bias mode (unless otherwise noted)

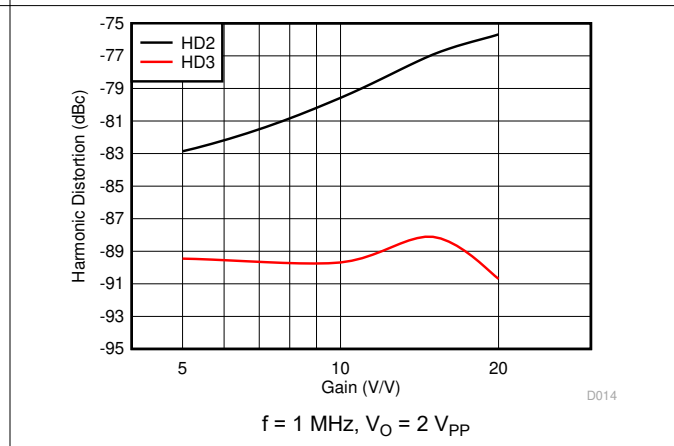

图 5-19. Harmonic Distortion vs V_O



图 5-20. Harmonic Distortion vs V_O

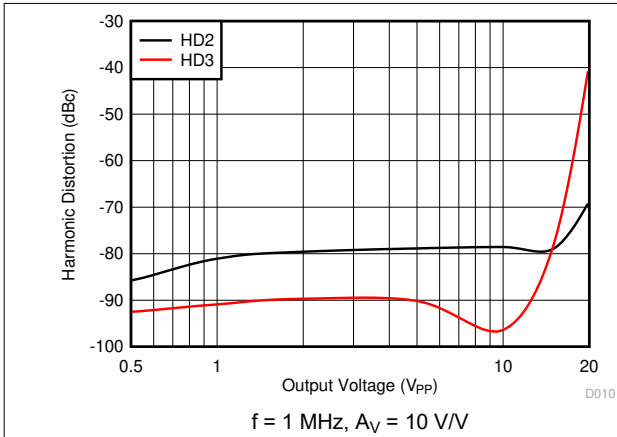

图 5-21. Harmonic Distortion vs R_L

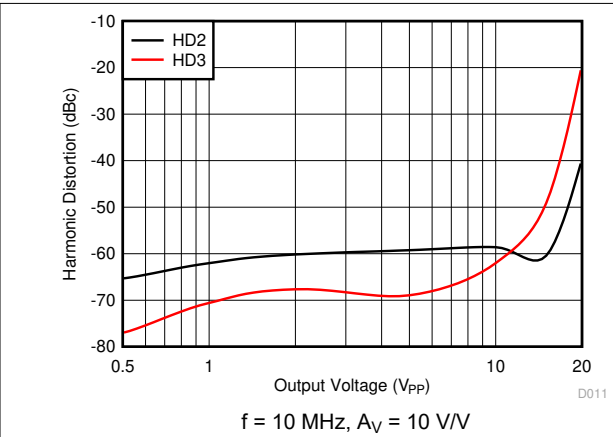

图 5-22. Harmonic Distortion vs R_L

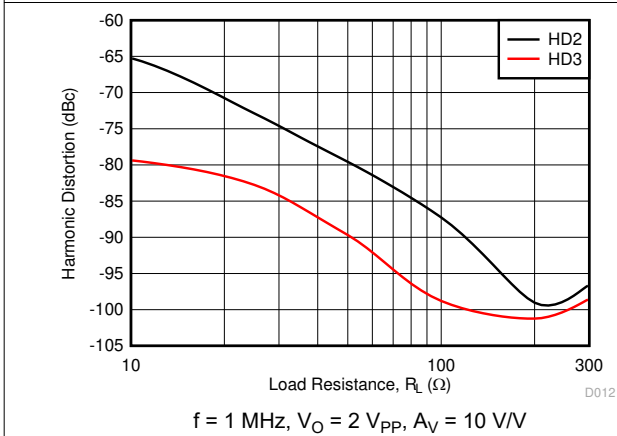

图 5-23. Intermodulation Distortion vs Frequency

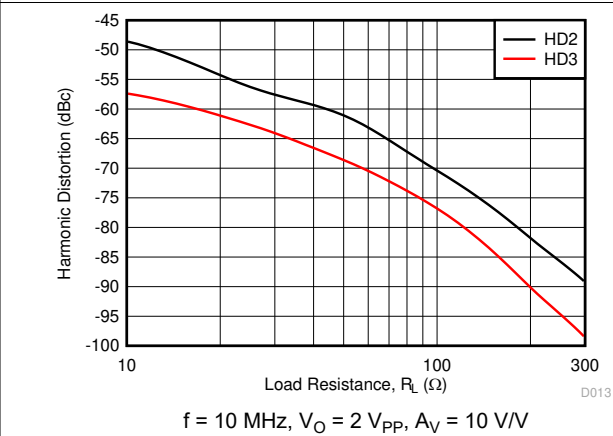

图 5-24. Overdrive Recovery

5.8 Typical Characteristics: $V_S = 12\text{ V}$ (continued)

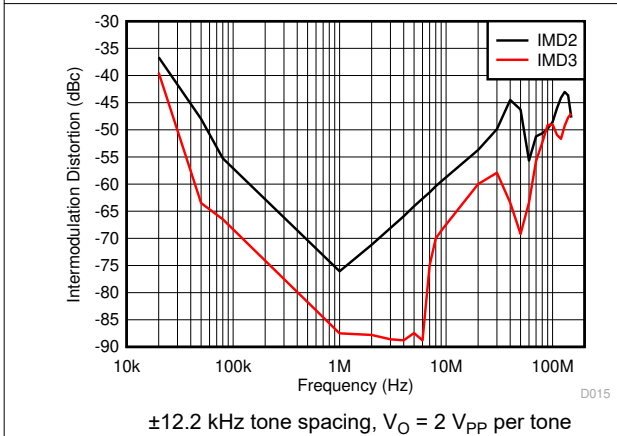
at $T_A \approx 25^\circ\text{C}$, $A_V = 10\text{ V/V}$, $R_F = 1.24\text{ k}\Omega$, $R_L = 50\ \Omega$, $R_S = 2.5\ \Omega$, $R_{ADJ} = 0\ \Omega$, full-bias mode (unless otherwise noted)

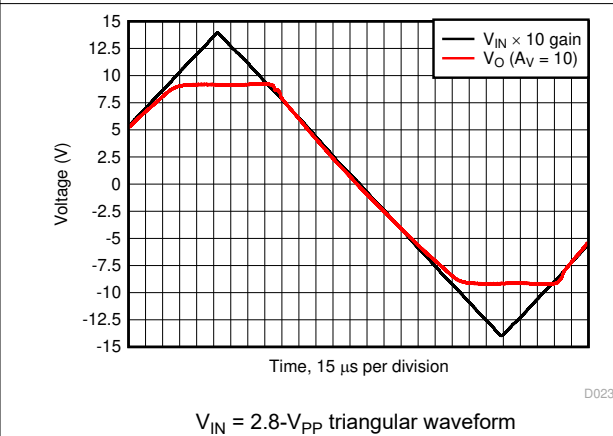

图 5-25. Small-Signal Pulse Response



图 5-26. Large-Signal Pulse Response

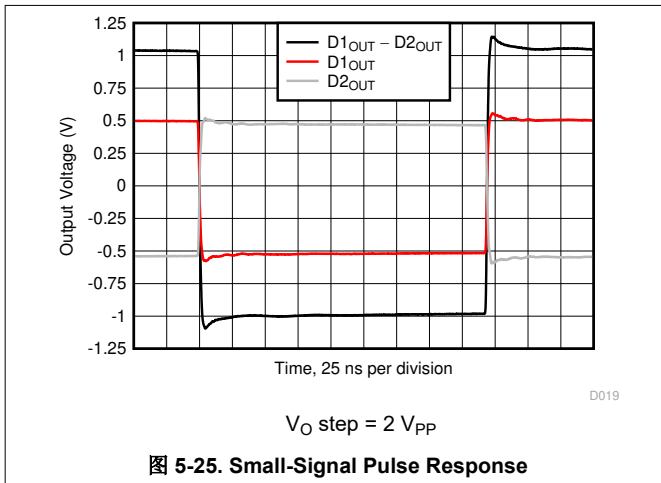

图 5-27. Open-Loop Transimpedance Gain and Phase vs Frequency

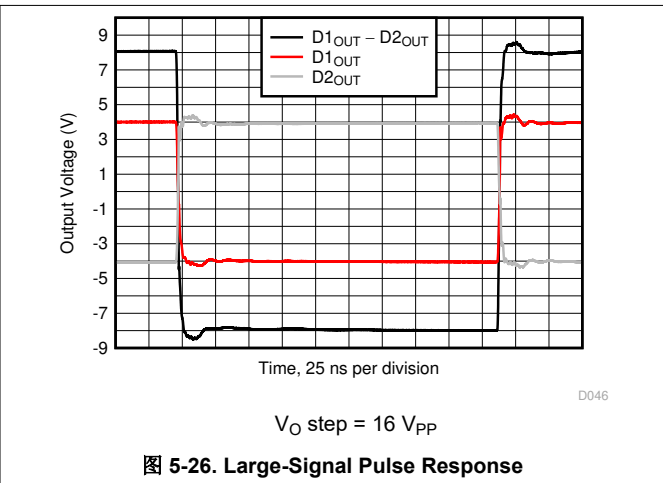

图 5-28. Open-Loop Transimpedance Gain and Phase vs Frequency

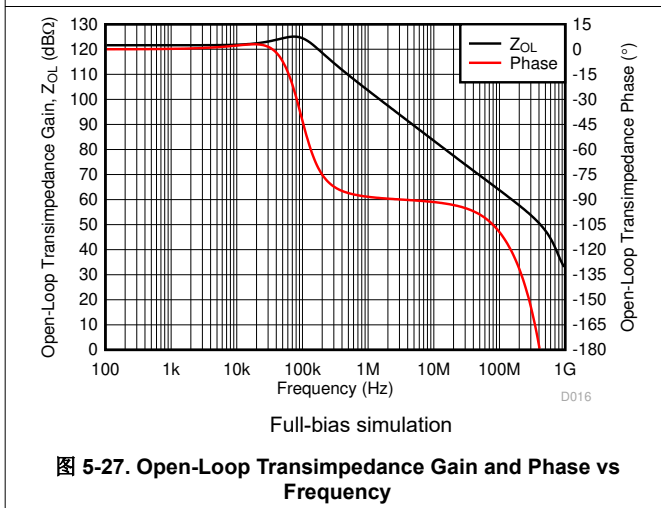

图 5-29. Open-Loop Transimpedance Gain and Phase vs Frequency

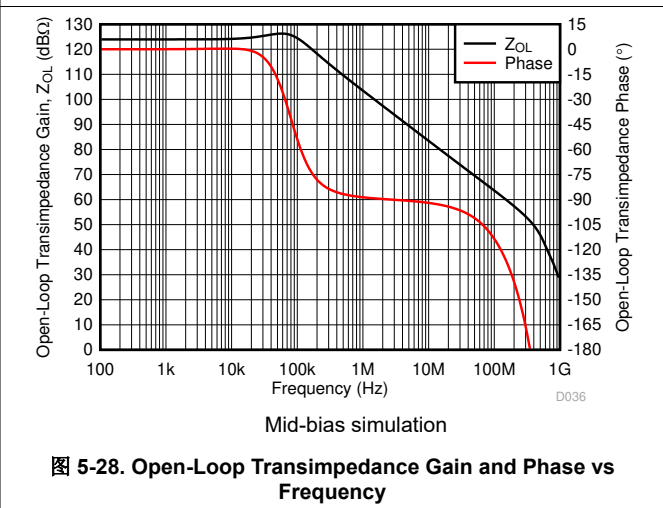

图 5-30. Open-Loop Output Impedance vs Frequency

5.8 Typical Characteristics: $V_S = 12\text{ V}$ (continued)

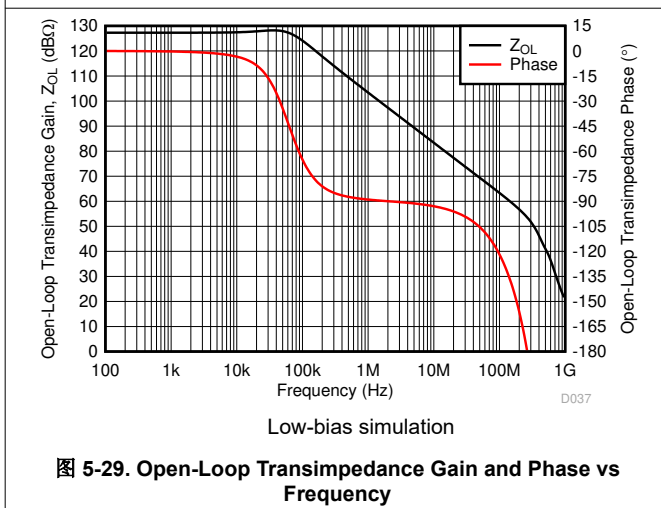
at $T_A \approx 25^\circ\text{C}$, $A_V = 10\text{ V/V}$, $R_F = 1.24\text{ k}\Omega$, $R_L = 50\ \Omega$, $R_S = 2.5\ \Omega$, $R_{ADJ} = 0\ \Omega$, full-bias mode (unless otherwise noted)

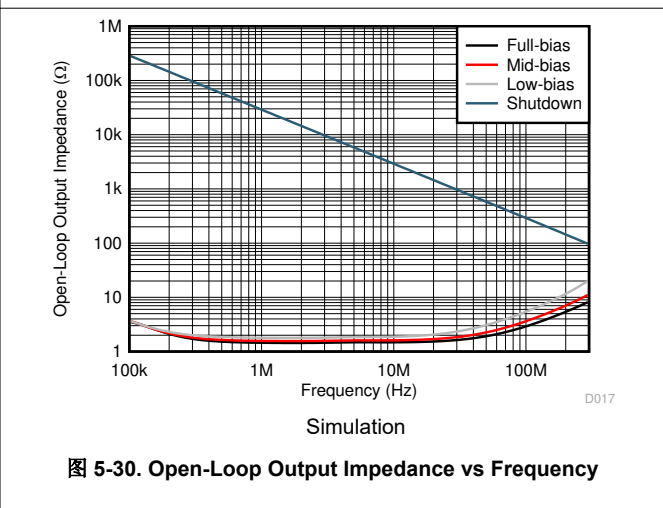

图 5-31. Quiescent Current vs Single-Supply Voltage



图 5-32. Quiescent Current vs R_{ADJ}

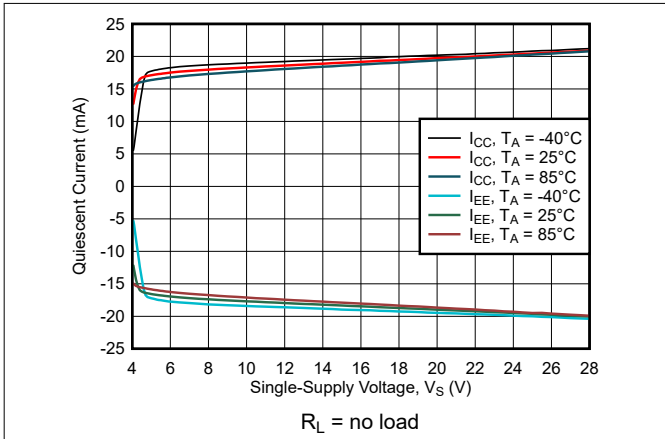

图 5-33. Quiescent Current vs Temperature

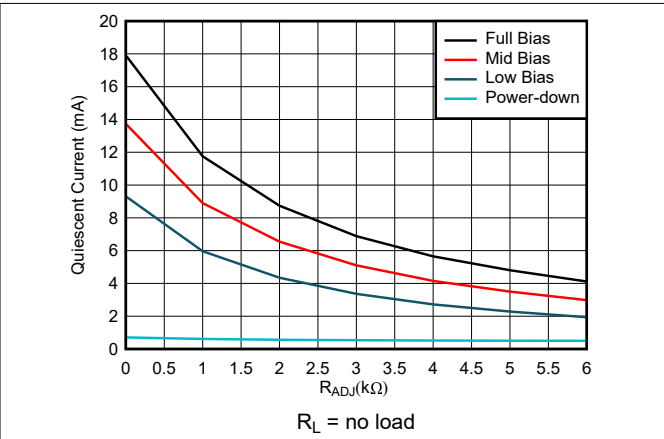

图 5-34. PSRR and CMRR vs Frequency

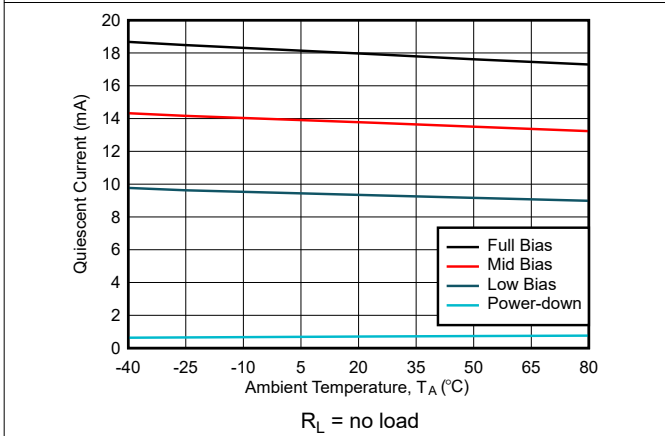

图 5-35. Mode Transition Voltage Threshold

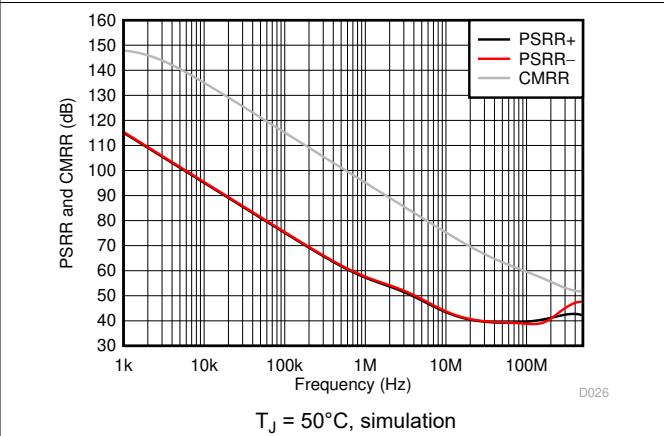

图 5-36. Full-Bias and Shutdown Mode Transition Timing

5.9 Typical Characteristics: $V_S = 28\text{ V}$

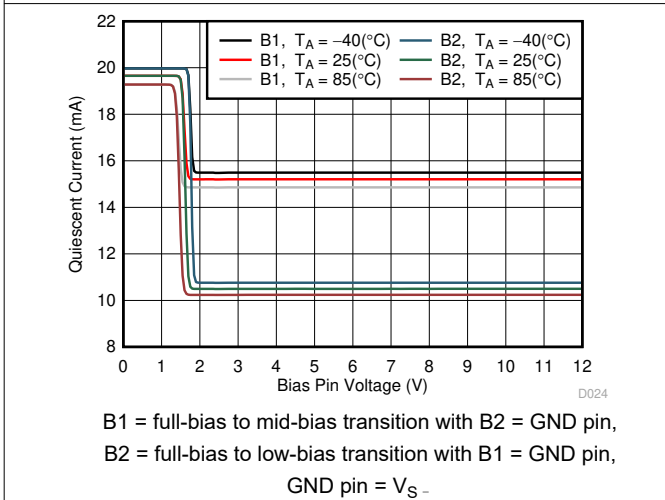
At $T_A \cong 25^\circ\text{C}$, $A_V = 10\text{ V/V}$, $R_F = 1.24\text{ k}\Omega$, $R_L = 100\ \Omega$, $R_S = 2.5\ \Omega$, $R_{ADJ} = 0\ \Omega$, full-bias mode (unless otherwise noted).

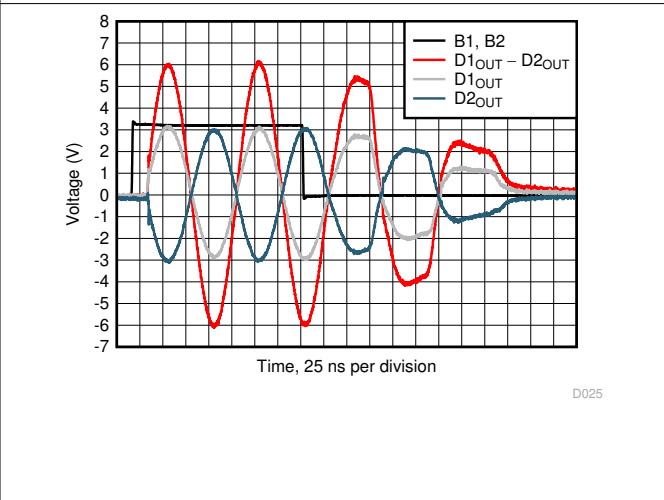

图 5-37. Small-Signal Frequency Response



图 5-38. Small-Signal Frequency Response vs R_F

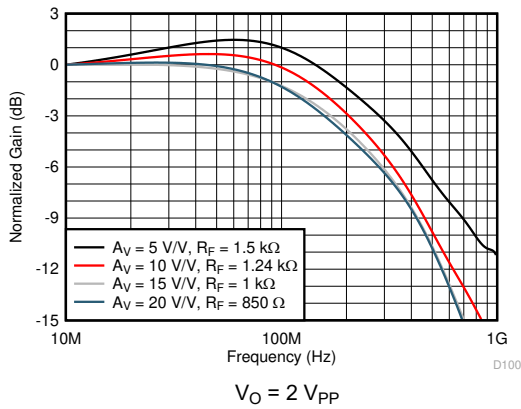

图 5-39. Large-Signal Frequency Response vs V_O

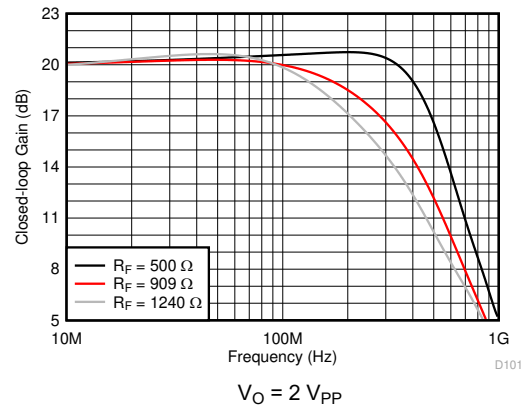

图 5-40. Large-Signal Frequency Response vs V_O

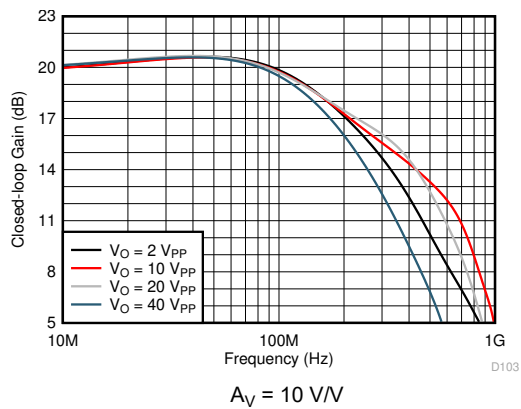

图 5-41. Large-Signal Frequency Response vs Bias Modes

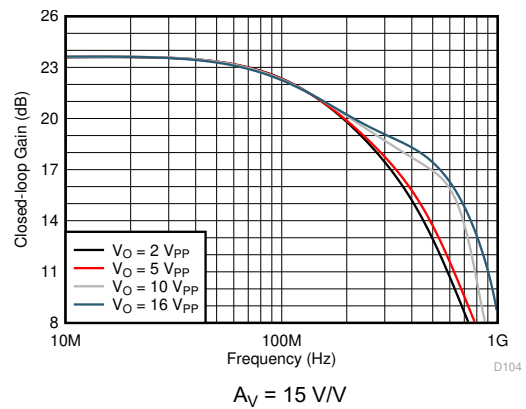

图 5-42. Intermodulation Distortion vs Frequency

5.9 Typical Characteristics: $V_S = 28\text{ V}$ (continued)

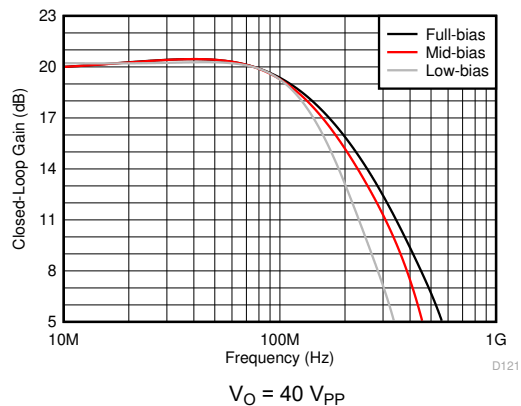
At $T_A \cong 25^\circ\text{C}$, $A_V = 10\text{ V/V}$, $R_F = 1.24\text{ k}\Omega$, $R_L = 100\ \Omega$, $R_S = 2.5\ \Omega$, $R_{ADJ} = 0\ \Omega$, full-bias mode (unless otherwise noted).

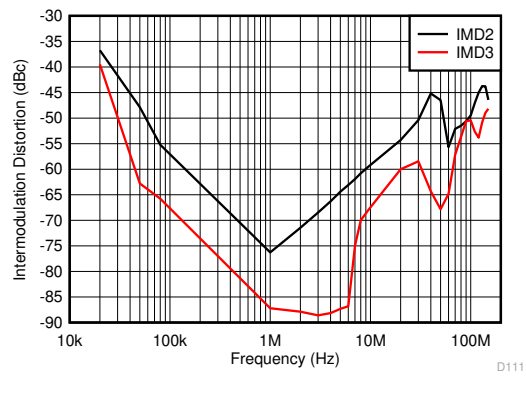

图 5-43. Harmonic Distortion vs Frequency



图 5-44. Harmonic Distortion vs Gain

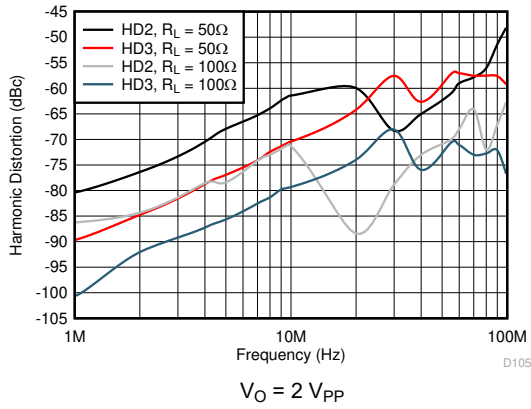

图 5-45. Harmonic Distortion vs V_O

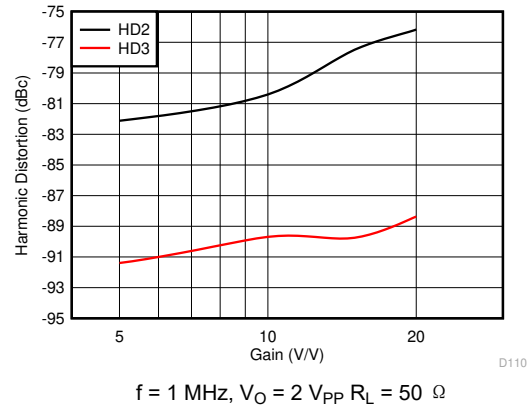

图 5-46. Harmonic Distortion vs V_O

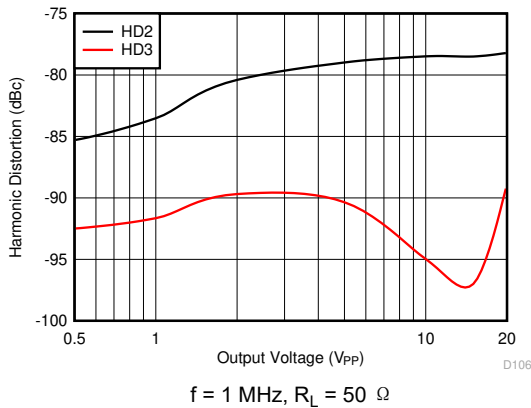

图 5-47. Harmonic Distortion vs R_L

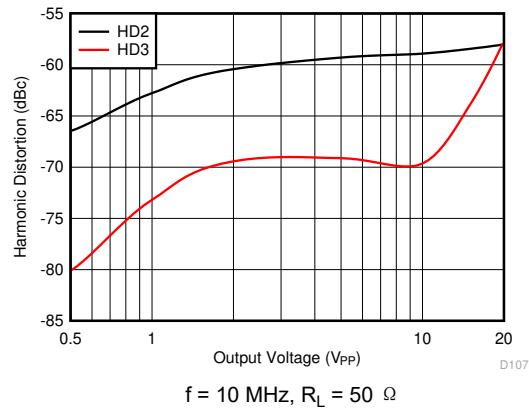

图 5-48. Harmonic Distortion vs R_L

5.9 Typical Characteristics: $V_S = 28\text{ V}$ (continued)

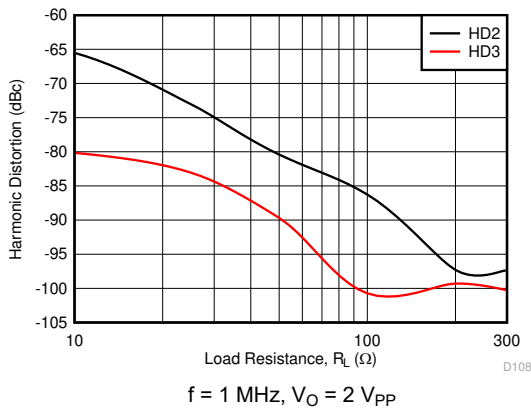
At $T_A \cong 25^\circ\text{C}$, $A_V = 10\text{ V/V}$, $R_F = 1.24\text{ k}\Omega$, $R_L = 100\ \Omega$, $R_S = 2.5\ \Omega$, $R_{ADJ} = 0\ \Omega$, full-bias mode (unless otherwise noted).

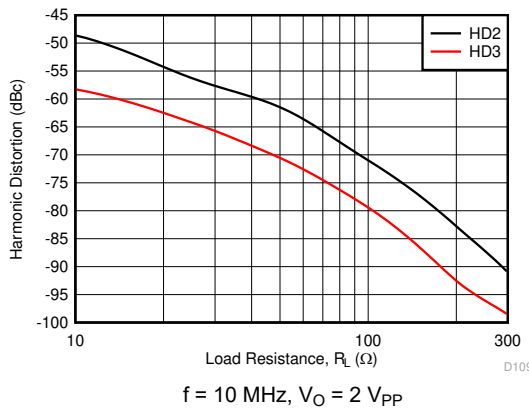
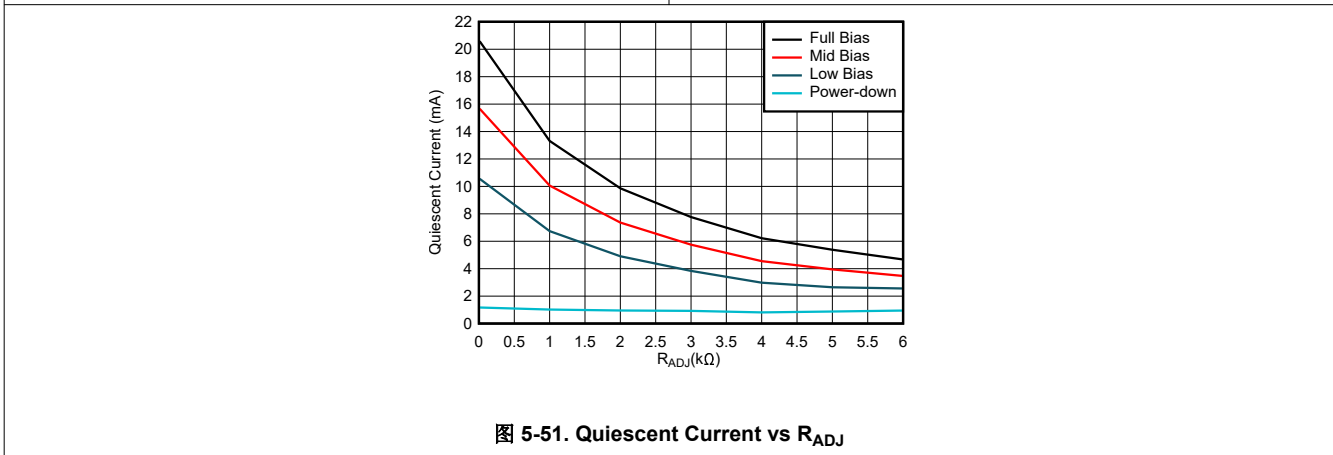
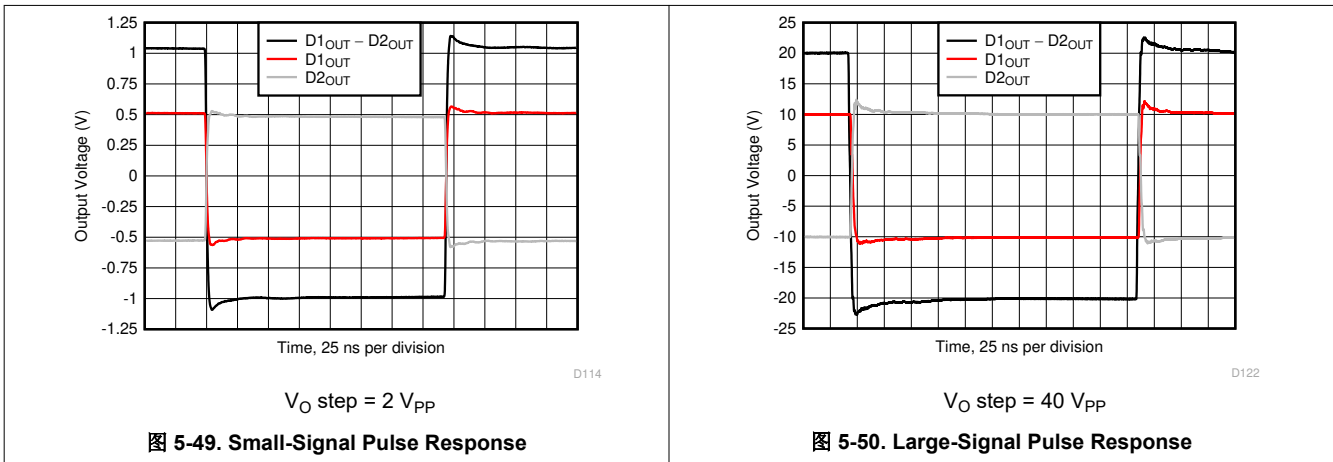

6 Detailed Description

6.1 Overview

The THS6212 is a differential line-driver amplifier with a current-feedback architecture. The device is targeted for use in line-driver applications (such as wide-band power-line communications) and is fast enough to support transmissions of 14.5-dBm line power up to 30 MHz.

The THS6212 is designed as a single-channel device that can be a drop-in replacement for dual-channel footprint packages. The package pinout is compatible with the pinout of the [THS6214](#) dual, differential line driver, and provides an alternative for systems that only require a single-channel device.

The architecture of the THS6212 is designed to provide maximum flexibility with multiple bias settings that are selectable based on application performance requirements, and also provides an external current pin (IADJ) to further adjust the bias current to the device. The wide output swing ($49V_{PP}$) and high current drive (650mA) of the THS6212 make the device an excellent choice for high-power, line-driving applications.

The THS6212 features thermal protection that typically triggers at a junction temperature of $175^{\circ}C$. The device behavior is similar to the bias off mode when thermal shutdown is activated. The device resumes normal operation when the die junction temperature reaches approximately $145^{\circ}C$. The device can go in and out of thermal shutdown until the overload conditions are removed because of the unpredictable behavior of the overload and thermal characteristics.

6.2 Functional Block Diagram

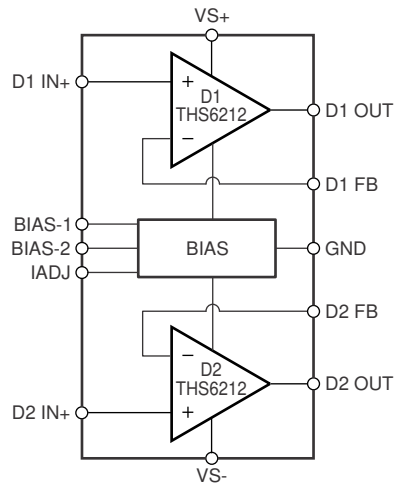

6.3 Feature Description

6.3.1 Output Voltage and Current Drive

The THS6212 provides output voltage and current capabilities that are unsurpassed in a low-cost, monolithic op amp. The output voltage (under no load at room temperature) typically swings closer than 1.1 V to either supply rail and typically swings to within 1.1 V of either supply with a 100 Ω differential load. The THS6212 can deliver over 350 mA of current with a 25 Ω load.

Good thermal design of the system is important, including use of heat sinks and active cooling methods, if the THS6212 is pushed to the limits of the output drive capabilities. 图 6-1 and 图 6-2 show the output drive of the THS6212 under two different sets of conditions where T_A is approximately equal to T_J . In practical applications, T_J is often much higher than T_A and highly depends on the device configuration, signal parameters, and PCB thermal design. To represent the full output drive capability of the THS6212 in 图 6-1 and 图 6-2, $T_J \approx T_A$ is achieved by pulsing or sweeping the output current for a duration of less than 100 ms.

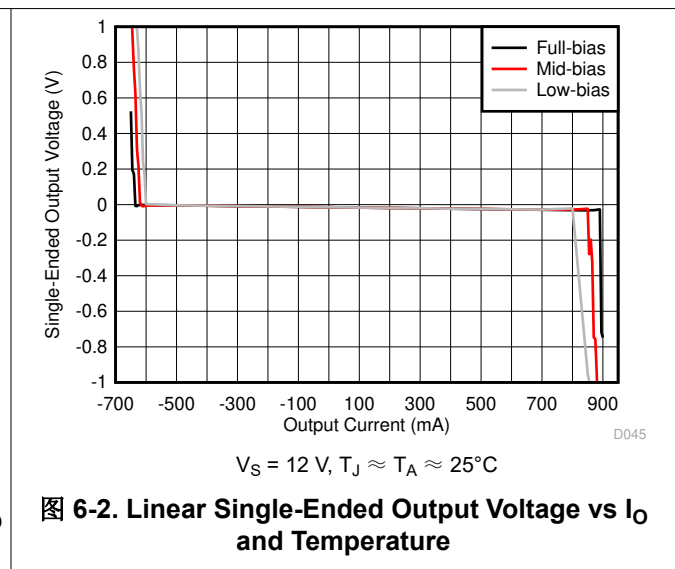
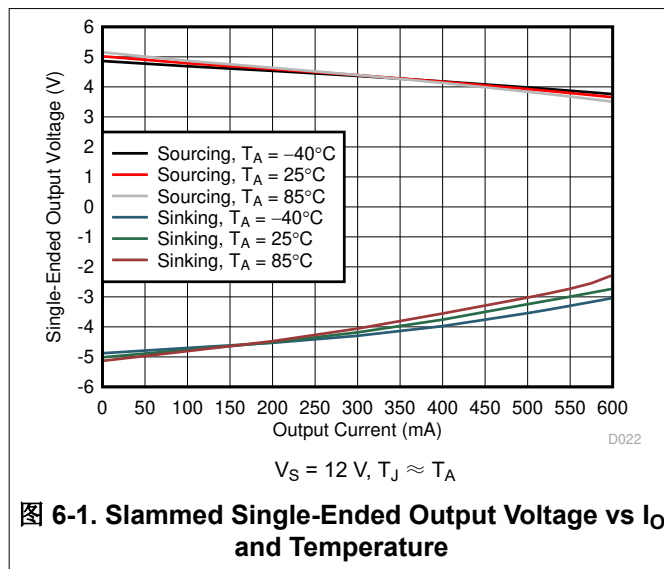

In 图 6-1, the output voltages are differentially slammed to the rail and the output current is single-endedly sourced or sunk using a source measure unit (SMU) for less than 100 ms. The single-ended output voltage of each output is then measured prior to removing the load current. After removing the load current, the outputs are brought back to mid-supply before repeating the measurement for different load currents. This entire process is repeated for each ambient temperature. Under the slammed output voltage condition of 图 6-1, the output transistors are in saturation and the transistors start going into linear operation as the output swing is backed off for a given I_O ,

In 图 6-2, the inputs are floated and the output voltages are allowed to settle to the mid-supply voltage. The load current is then single-endedly swept for sourcing (greater than 0 mA) and sinking (less than 0 mA) conditions and the single-ended output voltage is measured at each current-forcing condition. The current sweep is completed in a few seconds (approximately 3 to 4 seconds) so as not to significantly raise the junction temperature (T_J) of the device from the ambient temperature (T_A). The output is not swinging and the output transistors are in linear operation in 图 6-2 until the current drawn exceeds the device capabilities, at which point the output voltage starts to deviate quickly from the no load output voltage.

To maintain maximum output stage linearity, output short-circuit protection is not provided. This absence of short-circuit protection is normally not a problem because most applications include a series-matching resistor at the output that limits the internal power dissipation if the output side of this resistor is shorted to ground. However, shorting the output pin directly to the adjacent positive power-supply pin, in most cases, permanently damages the amplifier.

6.3.2 Driving Capacitive Loads

One of the most demanding and yet very common load conditions for an op amp is capacitive loading. Often, the capacitive load is the input of an ADC—including additional external capacitance that can be recommended to improve the ADC linearity. A high-speed, high open-loop gain amplifier such as the THS6212 can be very susceptible to decreased stability and closed-loop response peaking when a capacitive load is placed directly on the output pin. When the amplifier open-loop output resistance is considered, this capacitive load introduces an additional pole in the signal path that can decrease the phase margin. One external solution to this problem is described in this section.

When the primary considerations are frequency response flatness, pulse response fidelity, and distortion, the simplest and most effective solution is to isolate the capacitive load from the feedback loop by inserting a series isolation resistor between the amplifier output and the capacitive load. This series resistor does not eliminate the pole from the loop response, but shifts the pole and adds a zero at a higher frequency. The additional zero functions to cancel the phase lag from the capacitive load pole, thus increasing the phase margin and improving stability.

The [Typical Characteristics](#) sections describe the recommended R_S versus capacitive load (see [图 5-10](#)) and the resulting frequency response at the load. Parasitic capacitive loads greater than 2 pF can begin to degrade device performance. Long printed-circuit board (PCB) traces, unmatched cables, and connections to multiple devices can easily cause this value to be exceeded. Always consider this effect carefully, and add the recommended series resistor as close as possible to the THS6212 output pin (see the [Layout Guidelines](#) section).

6.3.3 Distortion Performance

The THS6212 provides good distortion performance into a 100- Ω load on a 28V supply. Relative to alternative solutions, the amplifier provides exceptional performance into lighter loads and operation on a 12V supply. Generally, until the fundamental signal reaches very high frequency or power levels, the second harmonic dominates the distortion with a negligible third-harmonic component. Focusing then on the second harmonic, increasing the load impedance improves distortion directly. Remember that the total load includes the feedback network—in the noninverting configuration (see [图 7-1](#)), this value is the sum of $R_F + R_G$, whereas in the inverting configuration this value is just R_F . Providing an additional supply decoupling capacitor (0.01 μ F) between the supply pins (for bipolar operation) also improves the second-order distortion slightly (from 3 dB to 6 dB).

In most op amps, increasing the output voltage swing directly increases harmonic distortion. The [Typical Characteristics](#) sections illustrate the second harmonic increasing at a little less than the expected 2x rate, whereas the third harmonic increases at a little less than the expected 3x rate. Where the test power doubles, the difference between the fundamental power and the second harmonic decreases less than the expected 6 dB, whereas the difference between the fundamental power and the third harmonic decreases by less than the expected 12 dB. This difference also appears in the two-tone, third-order intermodulation (IM3) spurious response curves. The third-order spurious levels are extremely low at low-output power levels. The output stage continues to hold the third-order spurious levels low even when the fundamental power reaches very high levels.

6.3.4 Differential Noise Performance

The THS6212 is designed to be used as a differential driver in high-performance applications. Therefore, analyzing the noise in such a configuration is important. 图 6-3 shows the op amp noise model for the differential configuration.



图 6-3. Differential Op Amp Noise Analysis Model

As a reminder, the differential gain is expressed in 方程式 1:

$$G_D = 1 + \frac{2 \times R_F}{R_G} \quad (1)$$

The output noise can be expressed as shown in 方程式 2:

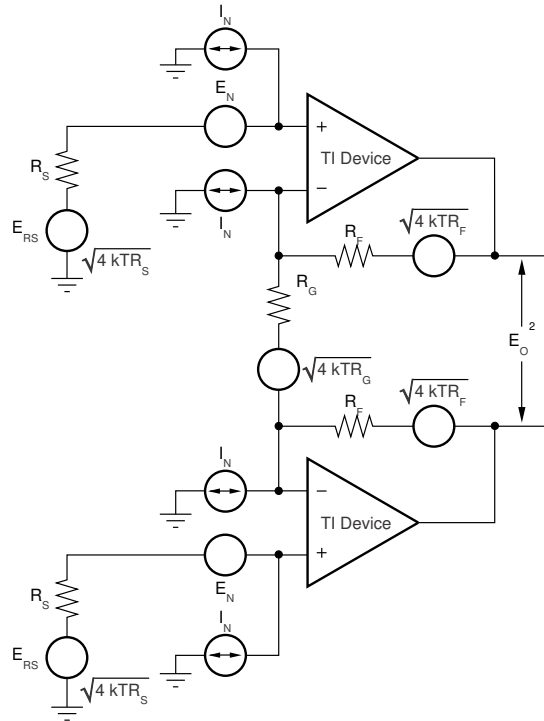
$$E_O = \sqrt{2 \times G_D^2 \times \left[e_N^2 + (i_N \times R_S)^2 + 4 kTR_S \right] + 2(i_1 R_F)^2 + 2(4 kTR_F G_D)} \quad (2)$$

Dividing this expression by the differential noise gain [$G_D = (1 + 2R_F / R_G)$] gives the equivalent input-referred spot noise voltage at the noninverting input, as shown in 方程式 3.

$$E_O = \sqrt{2 \times \left[e_N^2 + (i_N \times R_S)^2 + 4 kTR_S \right] + 2 \left[\frac{i_1 R_F}{G_D} \right]^2 + 2 \left[\frac{4 kTR_F}{G_D} \right]} \quad (3)$$

Evaluating these equations for the THS6212 circuit and component values of 图 7-1 with $R_S = 50 \Omega$, gives a total output spot noise voltage of 53.3 nV/√Hz and a total equivalent input spot noise voltage of 6.5 nV/√Hz.

To minimize the output noise as a result of the noninverting input bias current noise, keep the noninverting source impedance as low as possible.

6.3.5 DC Accuracy and Offset Control

A current-feedback op amp such as the THS6212 provides exceptional bandwidth in high gains, giving fast pulse settling but only moderate dc accuracy. The [Electrical Characteristics](#) tables describe an input offset voltage that is comparable to high-speed, voltage-feedback amplifiers; however, the two input bias currents are somewhat higher and are unmatched. Although bias current cancellation techniques are very effective with most voltage-feedback op amps, these techniques do not generally reduce the output dc offset for wideband current-feedback op amps. Because the two input bias currents are unrelated in both magnitude and polarity, matching the input source impedance to reduce error contribution to the output is ineffective. Evaluating the configuration of [图 7-1](#), using a typical condition at 25°C input offset voltage and the two input bias currents, gives a typical output offset range equal to [方程式 4](#):

$$\begin{aligned}
 V_{\text{OFF}} &= \left(\pm \text{NG} \times V_{\text{OS(TYP)}} \right) + \left(I_{\text{BN}} \times \frac{R_{\text{S}}}{2} \times \text{NG} \right) \pm (I_{\text{BI}} \times R_{\text{F}}) \\
 &= \pm (10 \times 0.5 \text{ mV}) + (1 \mu\text{A} \times 25 \Omega \times 10) \pm (6 \mu\text{A} \times 1.24 \text{ k}\Omega) \\
 &= \pm 5 \text{ mV} + 0.250 \text{ mV} \pm 7.44 \text{ mV} \\
 V_{\text{OFF}} &= -12.19 \text{ mV to } 12.69 \text{ mV}
 \end{aligned}
 \tag{4}$$

where

- NG = noninverting signal gain

6.4 Device Functional Modes

The THS6212 has four different functional modes set by the BIAS-1 and BIAS-2 pins. [表 6-1](#) shows the truth table for the device mode pin configuration and the associated description of each mode.

表 6-1. BIAS-1 and BIAS-2 Logic Table

BIAS-1	BIAS-2	FUNCTION	DESCRIPTION
0	0	Full-bias mode (100%)	Amplifiers on with lowest distortion possible (default state)
1	0	Mid-bias mode (75%)	Amplifiers on with power savings and a reduction in distortion performance
0	1	Low-bias mode (50%)	Amplifiers on with enhanced power savings and a reduction of overall performance
1	1	Shutdown mode	Amplifiers off and output has high impedance

7 Application and Implementation

备注

以下应用部分中的信息不属于 TI 器件规格的范围，TI 不担保其准确性和完整性。TI 的客户应负责确定器件是否适用于其应用。客户应验证并测试其设计，以确保系统功能。

7.1 Application Information

The THS6212 is typically used to drive high output power applications with various load conditions. In the [Typical Applications](#) section, the amplifier is presented in a general-purpose, wideband, current-feedback configuration, and a more specific 100- Ω twisted pair cable line driver; however, the amplifier is also applicable for many different general-purpose and specific cable line-driving scenarios beyond what is shown in the [Typical Applications](#) section.

7.2 Typical Applications

7.2.1 Wideband Current-Feedback Operation

The THS6212 provides the exceptional ac performance of a wideband current-feedback op amp with a highly linear, high-power output stage. Requiring only 19.5 mA of quiescent current, the THS6212 has an output swing of 49 V_{pp} (100- Ω load) coupled with over 650 mA current drive (25 Ω load). This low-output headroom requirement, along with biasing that is independent of the supply voltage, provides a remarkable 28-V supply operation. The THS6212 delivers greater than 285-MHz bandwidth driving a 2-V_{PP} output into 100 Ω on a 28-V supply. Previous boosted output stage amplifiers typically suffer from very poor crossover distortion when the output current goes through zero. The THS6212 achieves a comparable power gain with improved linearity. The primary advantage of a current-feedback op amp over a voltage-feedback op amp is that ac performance (bandwidth and distortion) is relatively independent of signal gain. 图 7-1 shows the dc-coupled, gain of 10 V/V, dual power-supply circuit configuration used as the basis of the 28-V [Electrical Characteristics](#) tables and [Typical Characteristics](#) sections.



图 7-1. Noninverting Differential I/O Amplifier

7.2.1.1 Design Requirements

The main design requirements for wideband current-feedback operation are to choose power supplies that satisfy common-mode requirements at the input and output of the device, and also to use a feedback resistor value that allows for the proper bandwidth when maintaining stability. These requirements and the proper solutions are described in the [Detailed Design Procedure](#) section. Using transformers and split power supplies can be required for certain applications.

7.2.1.2 Detailed Design Procedure

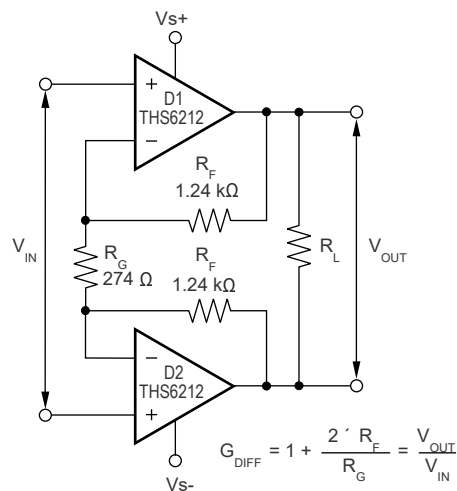
For ease of test purposes in this design, the THS6212 input impedance is set to 50 Ω with a resistor to ground and the output impedance is set to 50 Ω with a series output resistor. Voltage swings reported in the [Electrical Characteristics](#) tables are taken directly at the input and output pins, whereas load powers (dBm) are defined at a matched 50-Ω load. For the circuit of [图 7-1](#), the total effective load is 100 Ω || 1.24 kΩ || 1.24 kΩ = 86.1 Ω. This approach allows a source termination impedance to be set at the input that is independent of the signal gain. For instance, simple differential filters can be included in the signal path right up to the noninverting inputs with no interaction with the gain setting. The differential signal gain for the circuit of [图 7-1](#) is given by [方程式 5](#):

$$A_D = 1 + 2 \times \frac{R_F}{R_G} \quad (5)$$

where

- A_D = differential gain

A value of 274 Ω for the $A_D = 10$ -V/V design is given by [图 7-1](#). The device bandwidth is primarily controlled with the feedback resistor value because the THS6212 is a current-feedback (CFB) amplifier; the differential gain, however, can be adjusted with considerable freedom using just the R_G resistor. In fact, R_G can be reduced by a reactive network that provides a very isolated shaping to the differential frequency response.

Various combinations of single-supply or ac-coupled gain can also be delivered using the basic circuit of [图 7-1](#). Common-mode bias voltages on the two noninverting inputs pass on to the output with a gain of 1 V/V because an equal dc voltage at each inverting node does not create current through R_G . This circuit does show a common-mode gain of 1 V/V from the input to output. The source connection must either remove this common-mode signal if undesired (using an input transformer can provide this function), or the common-mode voltage at the inputs can be used to set the output common-mode bias. If the low common-mode rejection of this circuit is a problem, the output interface can also be used to reject that common-mode signal. For instance, most modern differential input analog-to-digital converters (ADCs) reject common-mode signals very well, and a line-driver application through a transformer also attenuates the common-mode signal through to the line.

7.2.1.3 Application Curves

[图 7-2](#) and [图 7-3](#) show the frequency response and distortion performance of the circuit in [图 7-1](#). The measurements are made with a load resistor (R_L) of 100 Ω, and at room temperature. [图 7-2](#) is measured using the three different device power modes, and the distortion measurements in [图 7-3](#) are made at an output voltage level of 2 V_{pp}.

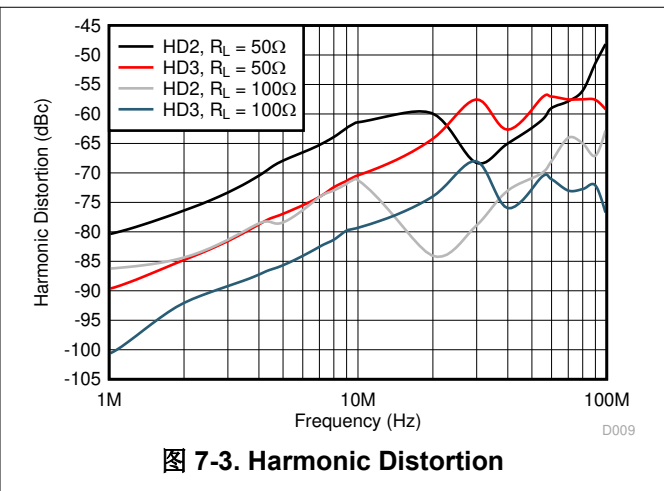
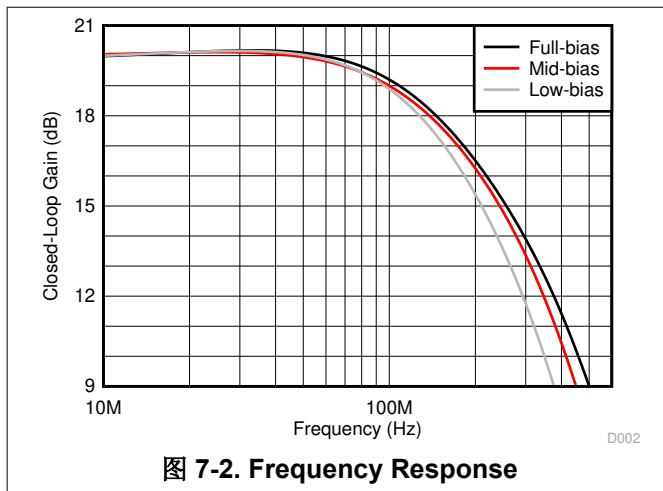

7.2.2 Dual-Supply Downstream Driver

图 7-4 显示了一个双电源下游驱动器的示例，具有合成的输出阻抗电路。THS6212 配置为差分增益级，以提供信号驱动到变压器的初级绕组（一个升压变压器，匝数比为 1:n 在图 7-4 中所示）。这种配置的主要优点是抵消所有偶次谐波失真产品。另一个重要优点是，每个放大器只需摆动总输出所需驱动负载的一半。



图 7-4. Dual-Supply Downstream Driver

The analog front-end (AFE) signal is ac-coupled to the driver, and the noninverting input of each amplifier is biased to the mid-supply voltage (ground in this case). In addition to providing the proper biasing to the amplifier, this approach also provides a high-pass filtering with a corner frequency that is set at 5 kHz in this example. Because the signal bandwidth starts at 26 kHz, this high-pass filter does not generate any problems and has the advantage of filtering out unwanted lower frequencies.

7.2.2.1 Design Requirements

The main design requirements for 图 7-4 是要正确匹配输出阻抗，满足裕量要求，并确认电路满足功率驱动要求。这些要求是在 [Detailed Design Procedure](#) 部分中描述的，并包括正确实施设计所需的方程。设计必须在物理实现之前完全完成，因为单个参数的微小变化可能会对性能产生重大影响。

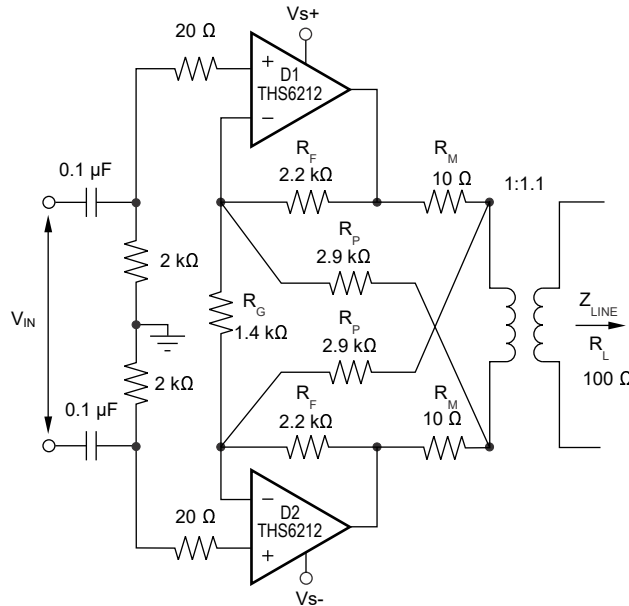
7.2.2.2 Detailed Design Procedure

对于 图 7-4，输入信号通过 [方程式 6](#) 进行放大：

$$G_D = 1 + \frac{2 \times R_F}{R_G} \quad (6)$$

The two back-termination resistors ($R_M = 10 \Omega$, each) added at each terminal of the transformer make the impedance of the amplifier match the impedance of the line, and also provide a means of detecting the received signal for the receiver. The value of these resistors (R_M) is a function of the line impedance and the transformer turns ratio (n), given by [方程式 7](#):

$$R_M = \frac{Z_{LINE}}{2n^2} \quad (7)$$

7.2.2.2.1 Line Driver Headroom Requirements

The first step in a transformer-coupled, twisted-pair driver design is to compute the peak-to-peak output voltage from the target specifications. This calculation is done using [方程式 8](#) to [方程式 11](#):

$$P_L = 10 \times \log \frac{V_{RMS}^2}{(1 \text{ mW}) \times R_L} \quad (8)$$

where

- P_L = power at the load
- V_{RMS} = voltage at the load
- R_L = load impedance

These values produce the following:

$$V_{RMS} = \sqrt{(1 \text{ mW}) \times R_L \times 10 \frac{P_L}{10}} \quad (9)$$

$$V_P = \text{Crest Factor} \times V_{RMS} = CF \times V_{RMS} \quad (10)$$

where

- V_P = peak voltage at the load
- CF = crest factor

$$V_{LPP} = 2 \times CF \times V_{RMS} \quad (11)$$

where

- V_{LPP} = peak-to-peak voltage at the load

Consolidating [方程式 8](#) to [方程式 11](#) allows the required peak-to-peak voltage at the load to be expressed as a function of the crest factor, the load impedance, and the power at the load, as given by [方程式 12](#):

$$V_{LPP} = 2 \times CF \times \sqrt{(1 \text{ mW}) \times R_L \times 10 \frac{P_L}{10}} \quad (12)$$

V_{LPP} is usually computed for a nominal line impedance and can be taken as a fixed design target.

The next step in the design is to compute the individual amplifier output voltage and currents as a function of peak-to-peak voltage on the line and transformer-turns ratio.

When this turns ratio changes, the minimum allowed supply voltage also changes. The peak current in the amplifier output is given by [方程式 13](#):

$$\pm I_P = \frac{1}{2} \times \frac{2 \times V_{LPP}}{n} \times \frac{1}{4 R_M} \tag{13}$$

where

- V_{PP} is as defined in 方程式 12, and
- R_M is as defined in 方程式 7 and 图 7-5



图 7-5. Driver Peak Output Voltage

With the previous information available, a supply voltage and the turns ratio desired for the transformer can now be selected, and the headroom for the THS6212 can be calculated.

The model shown in 图 7-6 can be described with 方程式 14 and 方程式 15 as:

1. The available output swing:

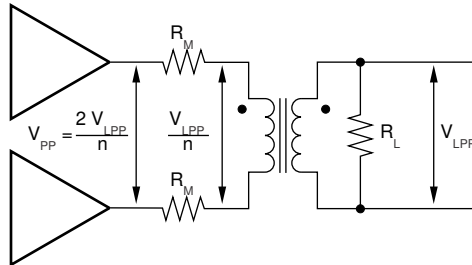
$$V_{PP} = V_{CC} - (V_1 + V_2) - I_P \times (R_1 + R_2) \tag{14}$$

2. Or as the required supply voltage:

$$V_{CC} = V_{PP} + (V_1 + V_2) + I_P \times (R_1 + R_2) \tag{15}$$

The minimum supply voltage for power and load requirements is given by 方程式 15.

V_1 , V_2 , R_1 , and R_2 are given in 表 7-1 for the ± 14 -V operation.



图 7-6. Line Driver Headroom Model

表 7-1. Line Driver Headroom Model Values

V_S	V_1	R_1	V_2	R_2
$\pm 14\text{ V}$	1 V	$0.6\ \Omega$	1 V	$1.2\ \Omega$

When using a synthetic output impedance circuit (see 图 7-4), a significant drop in bandwidth occurs from the specification provided in the *Electrical Characteristics* tables. This apparent drop in bandwidth for the differential signal is a result of the apparent increase in the feedback transimpedance for each amplifier. This feedback transimpedance equation is given by 方程式 16:

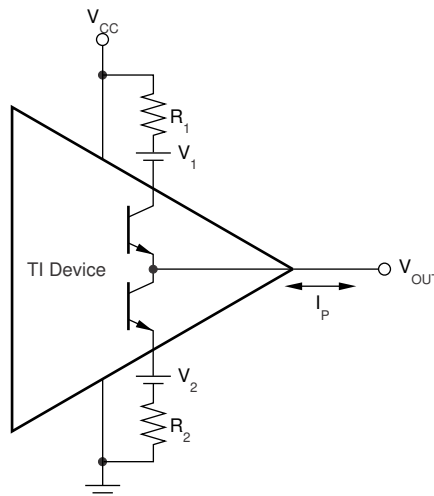
$$Z_{FB} = R_F \times \frac{1 + 2 \times \frac{R_S}{R_L} + \frac{R_S}{R_P}}{1 + 2 \times \frac{R_S}{R_L} + \frac{R_S}{R_P} - \frac{R_F}{R_P}} \quad (16)$$

To increase the 0.1-dB flatness to the frequency of interest, adding a serial RC in parallel with the gain resistor can be needed, as shown in 图 7-7.



图 7-7. 0.1-dB Flatness Compensation Circuit

7.2.2.2.2 Computing Total Driver Power for Line-Driving Applications

The total internal power dissipation for the THS6212 in a line-driver application is the sum of the quiescent power and the output stage power. The THS6212 holds a relatively constant quiescent current versus supply voltage—giving a power contribution that is simply the quiescent current times the supply voltage used (the supply voltage is greater than the solution given in 方程式 15). The total output stage power can be computed with reference to 图 7-8.

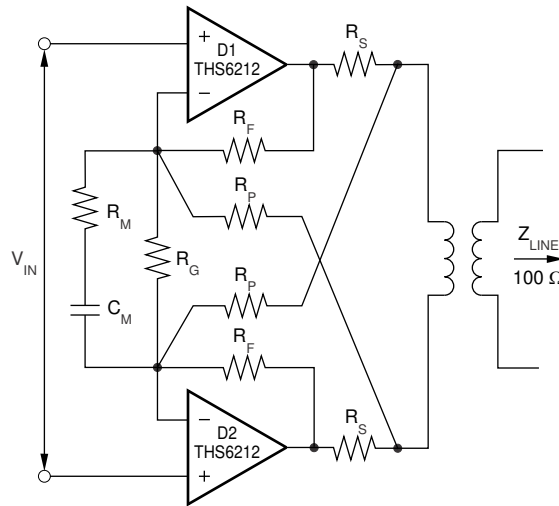

图 7-8. Output Stage Power Model

The two output stages used to drive the load of 图 7-5 are shown as an H-Bridge in 图 7-8. The average current drawn from the supply into this H-Bridge and load is the peak current in the load given by 方程式 13 divided by the crest factor (CF) for the signal modulation. This total power from the supply is then reduced by the power in R_T , leaving the power dissipated internal to the drivers in the four output-stage transistors. That power is simply the target line power used in 方程式 8 plus the power lost in the matching elements (R_M). In the following examples, a perfect match is targeted giving the same power in the matching elements as in the load. The output stage power is then set by 方程式 17.

$$P_{\text{OUT}} = \frac{I_P}{\text{CF}} \times V_{\text{CC}} - 2P_L \quad (17)$$

The total amplifier power is then given by 方程式 18:

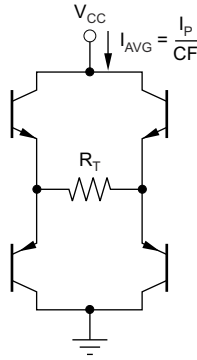
$$P_{\text{TOT}} = I_Q \times V_{\text{CC}} + \frac{I_P}{\text{CF}} \times V_{\text{CC}} - 2P_L \quad (18)$$

For the example given by 图 7-4, the peak current is 159 mA for a signal that requires a crest factor of 5.6 with a target line power of 20.5 dBm into a 100- Ω load (115 mW).

With a typical quiescent current of 19.5mA and a nominal supply voltage of $\pm 14\text{V}$, the total internal power dissipation for the solution of 图 7-4 is given by 方程式 19:

$$P_{\text{TOT}} = 19.5\text{mA}(28\text{V}) + \frac{159\text{mA}}{5.6}(28\text{V}) - 2(115\text{mW}) = 1111\text{mW} \quad (19)$$

7.3 Best Design Practices

- Include a thermal design at the beginning of the project.
- Use well-terminated transmission lines for all signals.
- Use solid metal layers for the power supplies.
- Keep signal lines as straight as possible.
- Use split supplies where required.
- Do not use a lower supply voltage than necessary.
- Do not use thin metal traces to supply power.
- Do not forget about the common-mode response of filters and transmission lines.

7.4 Power Supply Recommendations

The THS6212 is designed to operate optimally using split power supplies. The device has a very wide supply range of 10V 至 28V to accommodate many different application scenarios. Choose power-supply voltages that allow for adequate swing on both the inputs and outputs of the amplifier to prevent affecting device performance. The ground pin provides the ground reference for the control pins and must be within V_{S-} to $(V_{S+} - 5\text{ V})$ for proper operation.

7.5 Layout

7.5.1 Layout Guidelines

Achieving optimum performance with a high-frequency amplifier such as the THS6212 requires careful attention to board layout parasitic and external component types. Recommendations that optimize performance include:

1. Minimize parasitic capacitance to any ac ground for all signal I/O pins. Parasitic capacitance on the output and inverting input pins can cause instability; on the noninverting input, this capacitance can react with the source impedance to cause unintentional band limiting. To reduce unwanted capacitance, a window around the signal I/O pins must be opened in all ground and power planes around these pins. Otherwise, ground and power planes must be unbroken elsewhere on the board.
2. Minimize the distance (less than 0.25 in, or 6.35 mm) from the power-supply pins to high-frequency 0.1- μ F decoupling capacitors. At the device pins, the ground and power plane layout must not be in close proximity to the signal I/O pins. Avoid narrow power and ground traces to minimize inductance between the pins and the decoupling capacitors. The power-supply connections must always be decoupled with these capacitors. An optional supply decoupling capacitor across the two power supplies (for bipolar operation) improves second-harmonic distortion performance. Larger (2.2 μ F to 6.8 μ F) decoupling capacitors, effective at lower frequencies, must also be used on the main supply pins. These capacitors can be placed somewhat farther from the device and can be shared among several devices in the same area of the PCB.
3. Careful selection and placement of external components preserve the high-frequency performance of the THS6212. Resistors must be of a very low reactance type. Surface-mount resistors work best and allow a tighter overall layout. Metal film and carbon composition, axially-leaded resistors can also provide good high-frequency performance.

Again, keep leads and PCB trace length as short as possible. Never use wire-wound type resistors in a high-frequency application. Although the output pin and inverting input pin are the most sensitive to parasitic capacitance, always position the feedback and series output resistor, if any, as close as possible to the output pin. Other network components, such as noninverting input termination resistors, must also be placed close to the package. Where double-side component mounting is allowed, place the feedback resistor directly under the package on the other side of the board between the output and inverting input pins. The frequency response is primarily determined by the feedback resistor value as described in the Wideband Current-Feedback Operation [Detailed Design Procedure](#) section. Increasing the value reduces the bandwidth, whereas decreasing the value leads to a more peaked frequency response. The 1.24-k Ω feedback resistor used in the [Typical Characteristics](#) sections at a gain of 10 V/V on 28V supplies is a good starting point for design. Note that a 1.5-k Ω feedback resistor, rather than a direct short, is recommended for a unity-gain follower application. A current-feedback op amp requires a feedback resistor to control stability even in the unity-gain follower configuration.

4. Make connections to other wideband devices on the board with short direct traces or through onboard transmission lines. For short connections, consider the trace and the input to the next device as a lumped capacitive load. Relatively wide traces (50 mils to 100 mils [0.050 in to 0.100 in, or 1.27 mm to 2.54 mm]) must be used, preferably with ground and power planes opened up around them. Estimate the total capacitive load and set R_S from the recommended R_S versus capacitive load plots (see [图 5-10](#)). Low parasitic capacitive loads (less than 5 pF) do not always need an isolation resistor because the THS6212 is nominally compensated to operate with a 2-pF parasitic load. If a long trace is required, and the 6-dB signal loss intrinsic to a doubly-terminated transmission line is acceptable, implement a matched-impedance transmission line using microstrip or stripline techniques (consult an ECL design handbook for microstrip and stripline layout techniques). A 50- Ω environment is not necessary on board; in fact, a higher impedance environment improves distortion (see the distortion versus load plots). With a characteristic board trace impedance defined based on board material and trace dimensions, a matching series resistor into the trace from the output of the THS6212 is used, as well as a terminating shunt resistor at the input of the destination device. Remember also that the terminating impedance is the parallel combination of the shunt resistor and the input impedance of the destination device.

This total effective impedance must be set to match the trace impedance. The high output voltage and current capability of the THS6212 allows multiple destination devices to be handled as separate transmission lines, each with respective series and shunt terminations. If the 6-dB attenuation of a doubly-terminated transmission line is unacceptable, a long trace can be series-terminated at the source end only.

Treat the trace as a capacitive load in this case and set the series resistor value as shown in the recommended R_S versus capacitive load plots. However, this configuration does not preserve signal integrity as well as a doubly-terminated line. If the input impedance of the destination device is low, there is some signal attenuation as a result of the voltage divider formed by the series output into the terminating impedance.

5. Socketing a high-speed part such as the THS6212 is not recommended. The additional lead length and pin-to-pin capacitance introduced by the socket can create an extremely troublesome parasitic network, and can make achieving a smooth, stable frequency response almost impossible. Best results are obtained by soldering the THS6212 directly onto the board.
6. Solder the exposed thermal pad to a heat-spreading power or ground plane. This pad is electrically isolated from the die, but must be connected to a power or ground plane and not floated.

7.5.2 Layout Example



图 7-9. THS6212EVM Top-Layer Example

Resistors for the optional synthesized
output impedance network.

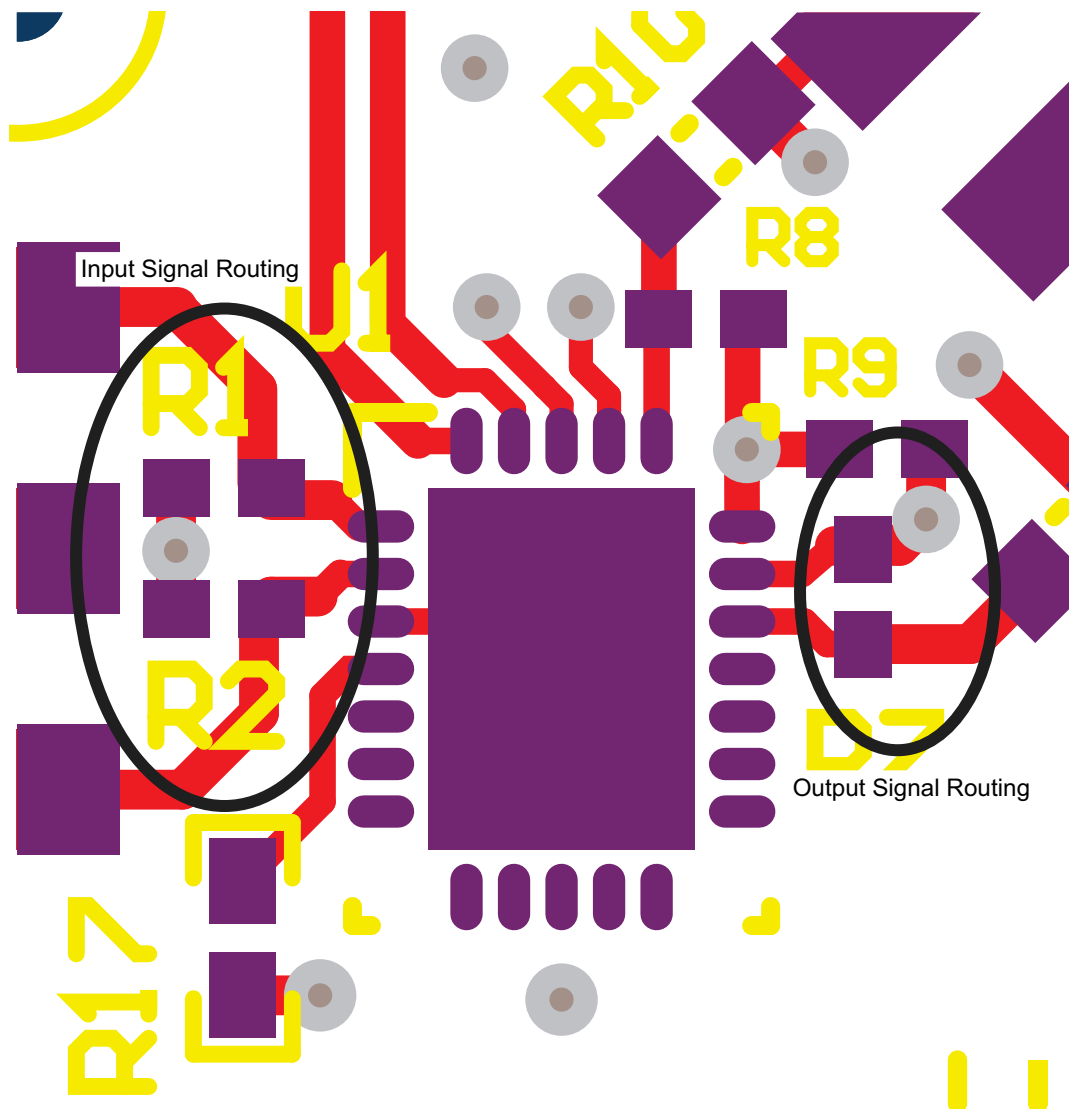

图 7-10. THS6212EVM Bottom Layer Example

8 Device and Documentation Support

8.1 Documentation Support

8.1.1 Related Documentation

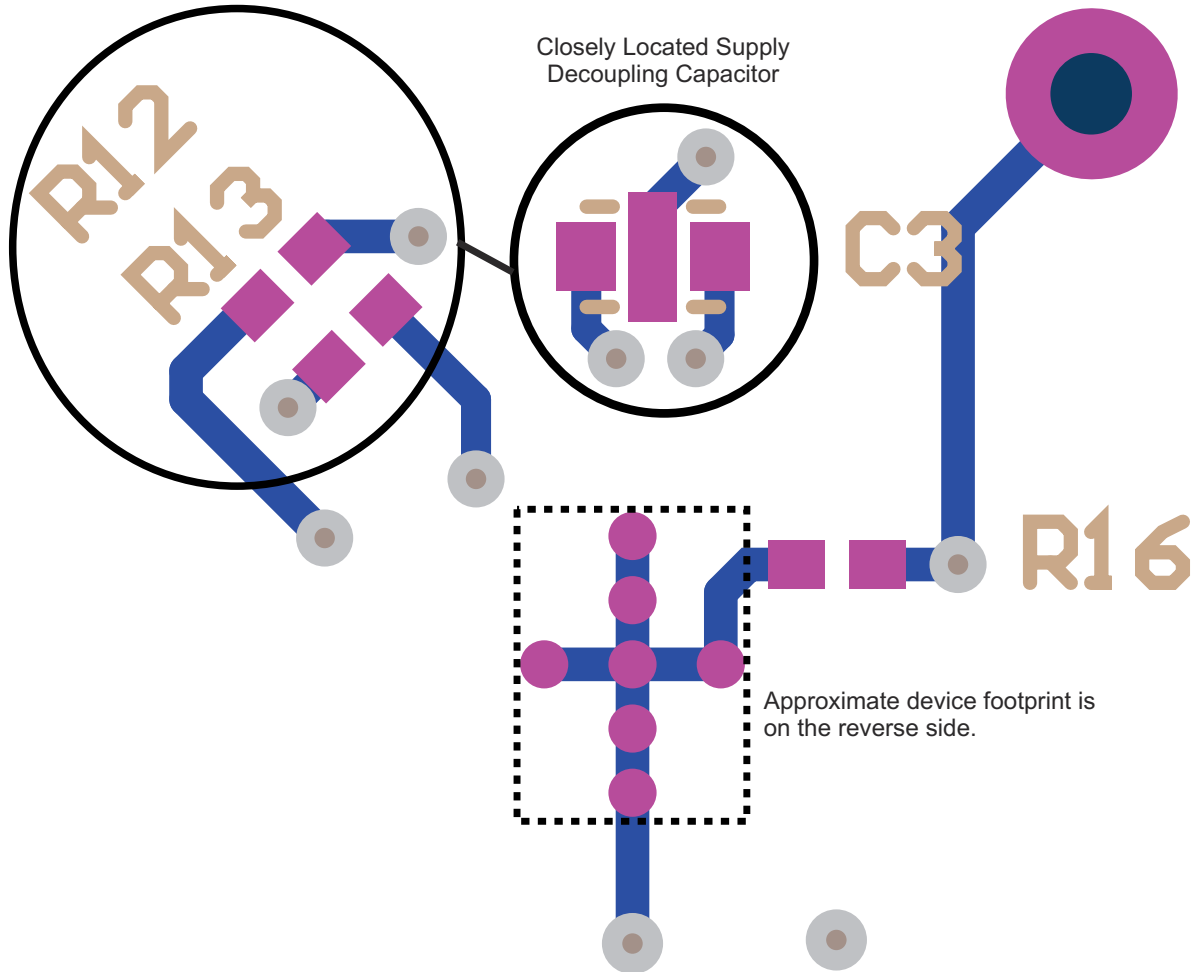
For related documentation see the following:

- Texas Instruments, [THS6214 Dual-Port, Differential, VDSL2 Line Driver Amplifiers data sheet](#)
- Texas Instruments, [THS6222 8-V to 32-V, Differential Broadband HPLC Line Driver With Common-Mode Buffer data sheet](#)
- Texas Instruments, [THS6212EVM User's Guide](#)

8.2 接收文档更新通知

要接收文档更新通知，请导航至 ti.com 上的器件产品文件夹。点击 [通知](#) 进行注册，即可每周接收产品信息更改摘要。有关更改的详细信息，请查看任何已修订文档中包含的修订历史记录。

8.3 支持资源

[TI E2E™ 中文支持论坛](#) 是工程师的重要参考资料，可直接从专家处获得快速、经过验证的解答和设计帮助。搜索现有解答或提出自己的问题，获得所需的快速设计帮助。

链接的内容由各个贡献者“按原样”提供。这些内容并不构成 TI 技术规范，并且不一定反映 TI 的观点；请参阅 TI 的 [使用条款](#)。

8.4 Trademarks

TI E2E™ is a trademark of Texas Instruments.

所有商标均为其各自所有者的财产。

8.5 静电放电警告



静电放电 (ESD) 会损坏这个集成电路。德州仪器 (TI) 建议通过适当的预防措施处理所有集成电路。如果不遵守正确的处理和安装程序，可能会损坏集成电路。

ESD 的损坏小至导致微小的性能降级，大至整个器件故障。精密的集成电路可能更容易受到损坏，这是因为非常细微的参数更改都可能会导致器件与其发布的规格不相符。

8.6 术语表

[TI 术语表](#) 本术语表列出并解释了术语、首字母缩略词和定义。

9 Revision History

注：以前版本的页码可能与当前版本的页码不同

Changes from Revision E (May 2021) to Revision F (June 2024)	Page
• 更新了 <i>说明</i> 中的 <i>封装信息表</i>	1
• Deleted maximum junction temperature continuous operation, long-term reliability from <i>Absolute Maximum Ratings</i>	4

Changes from Revision D (November 2019) to Revision E (May 2021)	Page
• 通篇更新了表格、图和交叉参考的编号格式.....	1
• 将 <i>特性</i> 中的中偏置模式值从 17.7mA 更改为 17.5mA.....	1
• 将 <i>特性</i> 中的低偏置模式值从 12.2mA 更改为 11.9mA.....	1
• 将 <i>特性</i> 中的电压噪声值从 2.7nV/√Hz 更改为 2.5nV/√Hz.....	1
• 将 <i>特性</i> 中的反相电流噪声值从 17pA/√Hz 更改为 18pA/√Hz.....	1
• 将 <i>特性</i> 中的同相电流噪声值从 1.2pA/√Hz 更改为 1.4pA/√Hz.....	1

• 将特性中的 HD2 失真从 -100dBc 更改为 -86dBc.....	1
• 将特性中的 HD3 失真从 -89dBc 更改为 -101dBc.....	1
• 将特性中的输出电流从 > 416mA 更改为 > 665mA.....	1
• 将特性中的输出摆幅从 43.2Vpp 更改为 49Vpp.....	1
• 将特性中的带宽从 150MHz 更改为 205MHz.....	1
• 将特性中的 PSRR 从 50dB 更改为 > 55dB.....	1
• 将特性中的过热保护从 170°C 更改为 175°C.....	1
• 将差分失真更改为 HD2 并更新了说明中的值.....	1
• 将说明中的输出摆幅从 43.2Vpp 更改为 49Vpp.....	1
• 将说明中的电源从 ±12V 更改为 28V.....	1
• 将说明中的电流驱动从 416mA 更改为 650mA.....	1
• 从文档中删除了 YS 接合焊盘封装.....	1
• 更改了采用 THS6212 的典型线路驱动器电路图.....	1
• Removed YS die package and Bond Pad Functions table.....	3
• Deleted Output current, IO from Absolute Maximum Ratings	4
• Added Bias control pin voltage in Absolute Maximum Ratings	4
• Added Input voltage to all pins except VS+, VS-, and BIAS control in Absolute Maximum Ratings	4
• Added Input current limit in Absolute Maximum Ratings	4
• Changed Maximum junction, TJ from 130 C to 125 C in Absolute Maximum Ratings	4
• Deleted ESD MM in ESD Ratings	4
• Changed Operating junction temperature from 130°C to 125°C in Recommended Operating Conditions	4
• Added Minimum ambient operating air temperature spec in Recommended Operating Conditions	4
• Changed R _{θJA} from 33.2 °C/W to 42.3 °C/W in Thermal Information	4
• Changed R _{θJC(Top)} from 31.7 °C/W to 32.8 °C/W in Thermal Information	4
• Changed R _{θJB} from 11.3 °C/W to 20.9 °C/W in Thermal Information	4
• Changed ψ _{JT} from 0.4 °C/W to 3.8 °C/W in Thermal Information	4
• Changed ψ _{JB} from 11.3 °C/W to 20.9 °C/W in Thermal Information	4
• Changed ψ _{JC(bot)} from 3.9 °C/W to 9.5 °C/W in Thermal Information	4
• Added Electrical Characteristics: V _S = 12 V	5
• Deleted Electrical Characteristics: V _S = ±6 V	5
• Added Electrical Characteristics: V _S = 28 V	8
• Changed t _{ON} from 1μs to 25ns in Timing Requirements	9
• Changed t _{OFF} from 1μs to 275ns in Timing Requirements	9
• Added Typical Characteristics: V _S = 12 V.....	10
• Deleted Typical Characteristics: V _S = ±6 V (Full Bias).....	10
• Deleted Typical Characteristics: V _S = ±6 V (Mid Bias).....	10
• Deleted Typical Characteristics: V _S = ±6 V (Low Bias).....	10
• Added Typical Characteristics: V _S = 28 V.....	16
• Deleted Typical Characteristics: V _S = ±12 V (Full Bias).....	16
• Deleted Typical Characteristics: V _S = ±12 V (Mid Bias).....	16
• Deleted Typical Characteristics: V _S = ±12 V (Low Bias).....	16
• Changed output swing from 43.2 Vpp to 49 Vpp in Overview section.....	19
• Changed current drive from 416 mA to 650 mA in Overview section.....	19
• Changed thermal protection junction temperature from 170°C to 175°C in Overview section.....	19
• Deleted Output Current and Voltage section.....	20
• Added Output Voltage and Current Drive section.....	20
• Changed referenced figures for R _S versus capacitive load in Driving Capacitive Loads section.....	21
• Changed ±12-V supplies to 28-V supply in Distortion Performance	21
• Changed ±6-V supplies to 12-V supply in Distortion Performance	21

• Updated noise evaluation in <i>Differential Noise Performance</i>	22
• Added $R_S = 50 \Omega$ in <i>Differential Noise Performance</i>	22
• Changed 38.9 nV/√Hz calculation to 53.3 nV/√Hz in <i>Differential Noise Performance</i>	22
• Changed 7 nV/√Hz calculation to 6.5 nV/√Hz in <i>Differential Noise Performance</i>	22
• Changed output offset calculation to typical rather than worst case in <i>DC Accuracy and Offset Control</i> section	23
• Changed quiescent current value from 23 mA to 19.5 mA in <i>Wideband Current-Feedback Operation</i> section.....	24
• Changed swing from 1.9 V from either rail to 49 Vpp in <i>Wideband Current-Feedback Operation</i> section.....	24
• Changed current drive from 416 mA to 650 mA in <i>Wideband Current-Feedback Operation</i> section.....	24
• Changed ± 6 V supply to 28 V supply in <i>Wideband Current-Feedback Operation</i> section.....	24
• Changed 140 MHz bandwidth to 285 MHz in <i>Wideband Current-Feedback Operation</i> section.....	24
• Changed <i>Noninverting Differential I/O Amplifier</i> figure in <i>Wideband Current-Feedback Operation</i> section.....	24
• Changed <i>Frequency Response</i> and <i>Harmonic Distortion</i> figures in <i>Application Curves</i> section.....	25
• Changed <i>Dual-Supply Downstream Driver</i> figure.....	26
• Changed supply voltages to ±14 V in <i>Line Driver Headroom Requirements</i> section.....	27
• Changed quiescent current value from 23 mA to 19.5 mA and ±12 V to ±14 V in <i>Computing Total Driver Power for Line-Driving Applications</i>	29
• Changed 23 mA to 19.5 mA, 24 V to 28 V and 1003 mW to 11 mW in <i>Computing Total Driver Power for Line-Driving Applications</i>	29
• Changed supply range from "±5 V to ±14 V" to "10 V to 28 V" in <i>Power Supply Recommendations</i> section..	31
• Changed referenced figures for R_S versus capacitive load in <i>Driving Capacitive Loads</i> section.....	32
• Deleted <i>Wafer and Die Information</i> section.....	32
• Changed ±12-V to 28-V in <i>Layout Guidelines</i> section.....	32

Changes from Revision C (May 2016) to Revision D (November 2019)	Page
• 添加了最后两个特性要点.....	1
• Added GND pin voltage spec in <i>Recommended Operating Conditions</i>	4
• Added last paragraph to <i>Overview</i> section	19
• Changed <i>Dual-Supply Downstream Driver</i> figure.....	26

10 Mechanical, Packaging, and Orderable Information

The following pages include mechanical, packaging, and orderable information. This information is the most current data available for the designated devices. This data is subject to change without notice and revision of this document. For browser-based versions of this data sheet, refer to the left-hand navigation.

PACKAGING INFORMATION

Orderable Device	Status (1)	Package Type	Package Drawing	Pins	Package Qty	Eco Plan (2)	Lead finish/ Ball material (6)	MSL Peak Temp (3)	Op Temp (°C)	Device Marking (4/5)	Samples
THS6212IRHFR	ACTIVE	VQFN	RHF	24	3000	RoHS & Green	NIPDAU	Level-2-260C-1 YEAR	-40 to 85	THS6212	Samples
THS6212IRHFT	ACTIVE	VQFN	RHF	24	250	RoHS & Green	NIPDAU NIPDAUAG	Level-2-260C-1 YEAR	-40 to 85	THS6212	Samples

(1) The marketing status values are defined as follows:

ACTIVE: Product device recommended for new designs.

LIFEBUY: TI has announced that the device will be discontinued, and a lifetime-buy period is in effect.

NRND: Not recommended for new designs. Device is in production to support existing customers, but TI does not recommend using this part in a new design.

PREVIEW: Device has been announced but is not in production. Samples may or may not be available.

OBSELETE: TI has discontinued the production of the device.

(2) **RoHS:** TI defines "RoHS" to mean semiconductor products that are compliant with the current EU RoHS requirements for all 10 RoHS substances, including the requirement that RoHS substance do not exceed 0.1% by weight in homogeneous materials. Where designed to be soldered at high temperatures, "RoHS" products are suitable for use in specified lead-free processes. TI may reference these types of products as "Pb-Free".

RoHS Exempt: TI defines "RoHS Exempt" to mean products that contain lead but are compliant with EU RoHS pursuant to a specific EU RoHS exemption.

Green: TI defines "Green" to mean the content of Chlorine (Cl) and Bromine (Br) based flame retardants meet JS709B low halogen requirements of <=1000ppm threshold. Antimony trioxide based flame retardants must also meet the <=1000ppm threshold requirement.

(3) MSL, Peak Temp. - The Moisture Sensitivity Level rating according to the JEDEC industry standard classifications, and peak solder temperature.

(4) There may be additional marking, which relates to the logo, the lot trace code information, or the environmental category on the device.

(5) Multiple Device Markings will be inside parentheses. Only one Device Marking contained in parentheses and separated by a "~" will appear on a device. If a line is indented then it is a continuation of the previous line and the two combined represent the entire Device Marking for that device.

(6) Lead finish/Ball material - Orderable Devices may have multiple material finish options. Finish options are separated by a vertical ruled line. Lead finish/Ball material values may wrap to two lines if the finish value exceeds the maximum column width.

Important Information and Disclaimer:The information provided on this page represents TI's knowledge and belief as of the date that it is provided. TI bases its knowledge and belief on information provided by third parties, and makes no representation or warranty as to the accuracy of such information. Efforts are underway to better integrate information from third parties. TI has taken and continues to take reasonable steps to provide representative and accurate information but may not have conducted destructive testing or chemical analysis on incoming materials and chemicals. TI and TI suppliers consider certain information to be proprietary, and thus CAS numbers and other limited information may not be available for release.

In no event shall TI's liability arising out of such information exceed the total purchase price of the TI part(s) at issue in this document sold by TI to Customer on an annual basis.

TAPE AND REEL INFORMATION

QUADRANT ASSIGNMENTS FOR PIN 1 ORIENTATION IN TAPE

*All dimensions are nominal

Device	Package Type	Package Drawing	Pins	SPQ	Reel Diameter (mm)	Reel Width W1 (mm)	A0 (mm)	B0 (mm)	K0 (mm)	P1 (mm)	W (mm)	Pin1 Quadrant
THS6212IRHFR	VQFN	RHF	24	3000	330.0	12.4	4.3	5.3	1.3	8.0	12.0	Q1
THS6212IRHFT	VQFN	RHF	24	250	180.0	12.4	4.3	5.3	1.3	8.0	12.0	Q1

TAPE AND REEL BOX DIMENSIONS



*All dimensions are nominal

Device	Package Type	Package Drawing	Pins	SPQ	Length (mm)	Width (mm)	Height (mm)
THS6212IRHFR	VQFN	RHF	24	3000	367.0	367.0	35.0
THS6212IRHFT	VQFN	RHF	24	250	210.0	185.0	35.0

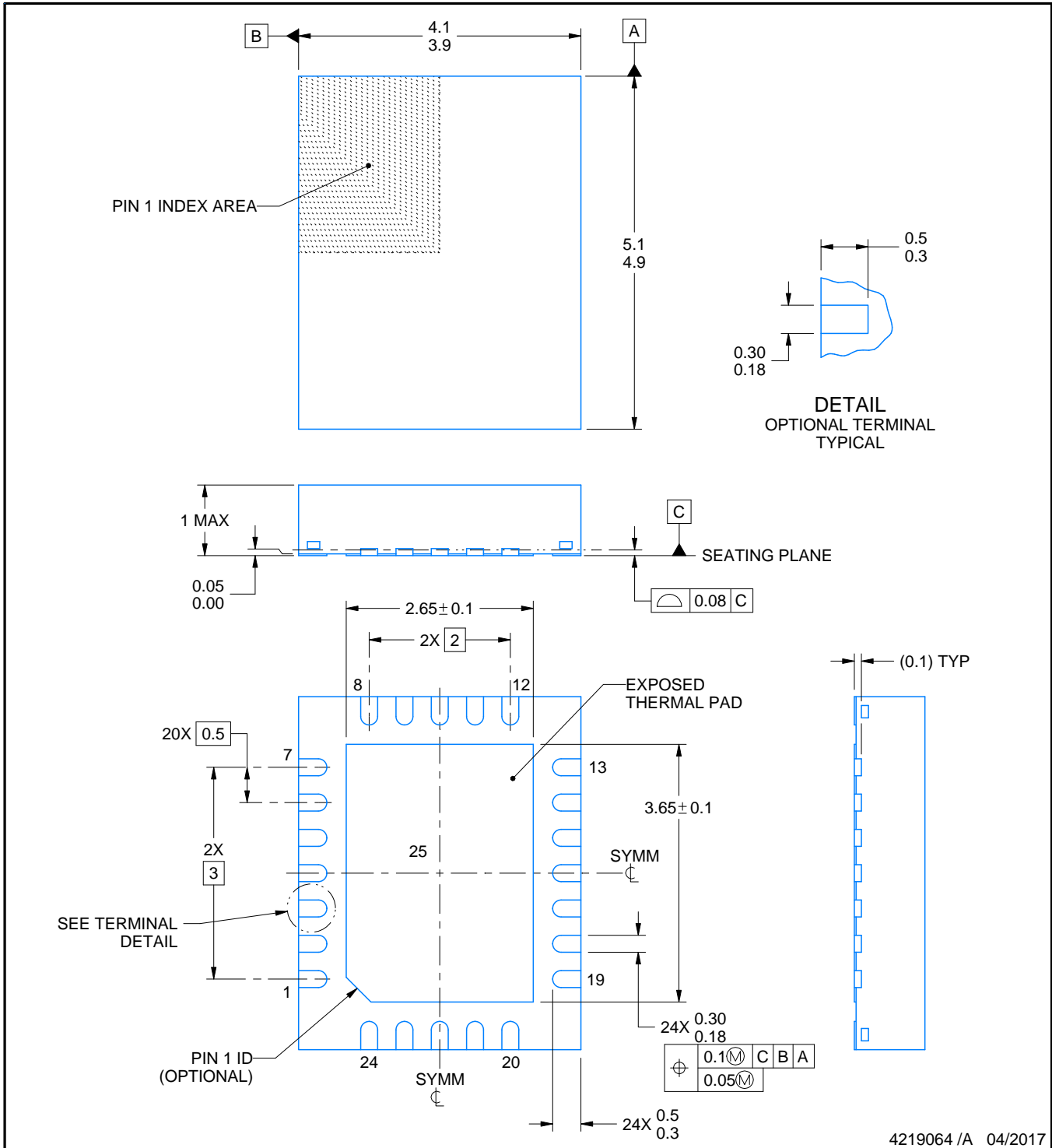
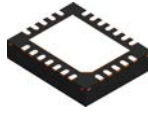

4219064 /A 04/2017

NOTES:

1. All linear dimensions are in millimeters. Any dimensions in parenthesis are for reference only. Dimensioning and tolerancing per ASME Y14.5M.
2. This drawing is subject to change without notice.
3. The package thermal pad must be soldered to the printed circuit board for thermal and mechanical performance.

EXAMPLE BOARD LAYOUT

RHF0024A

VQFN - 1 mm max height

PLASTIC QUAD FLATPACK - NO LEAD

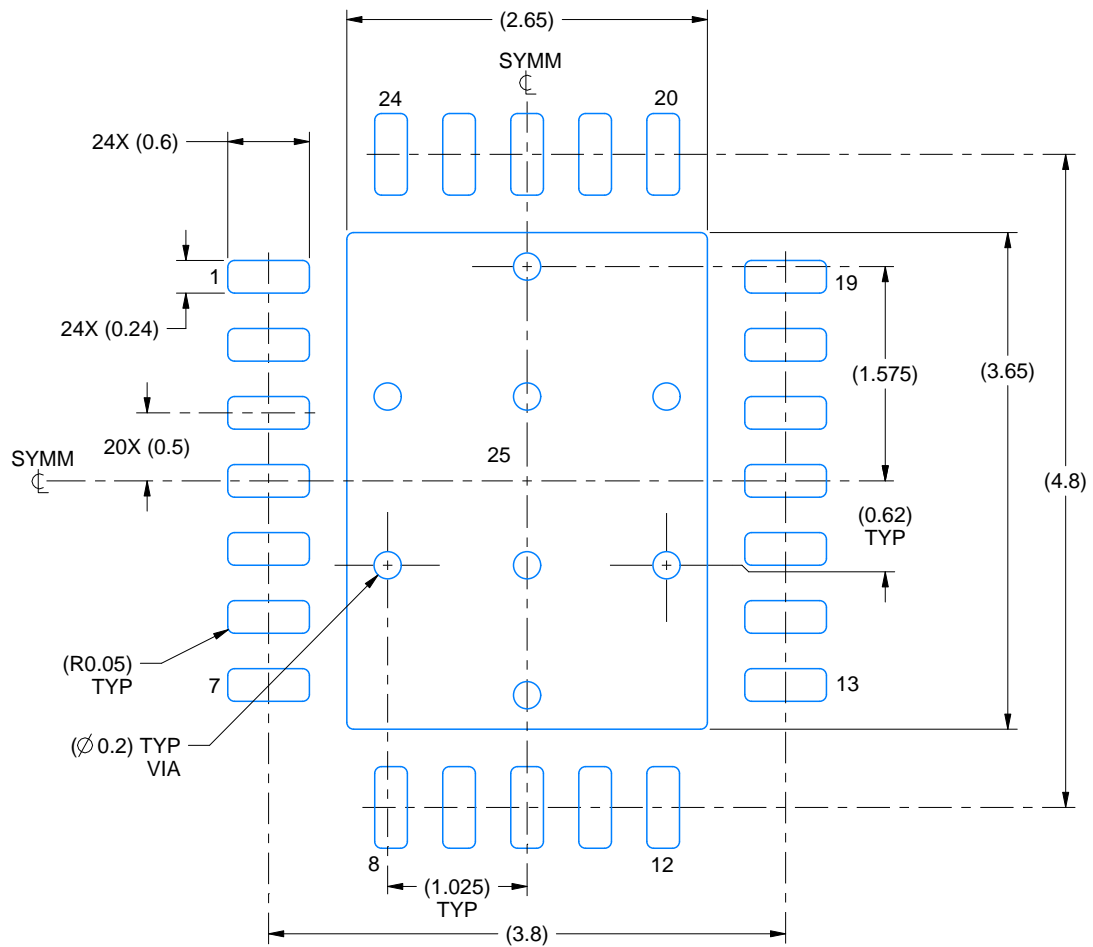

LAND PATTERN EXAMPLE
EXPOSED METAL SHOWN
SCALE:18X

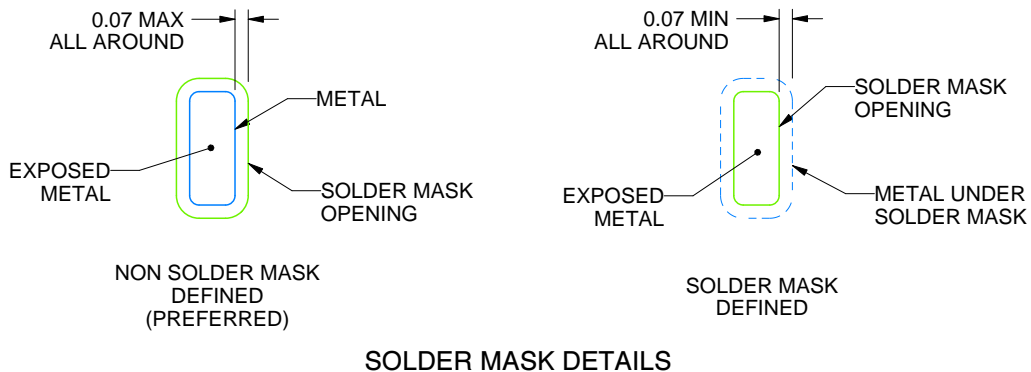

4219064 /A 04/2017

NOTES: (continued)

- This package is designed to be soldered to a thermal pad on the board. For more information, see Texas Instruments literature number SLUA271 (www.ti.com/lit/slua271).
- Vias are optional depending on application, refer to device data sheet. If any vias are implemented, refer to their locations shown on this view. It is recommended that vias under paste be filled, plugged or tented.

EXAMPLE STENCIL DESIGN

RHF0024A

VQFN - 1 mm max height

PLASTIC QUAD FLATPACK - NO LEAD

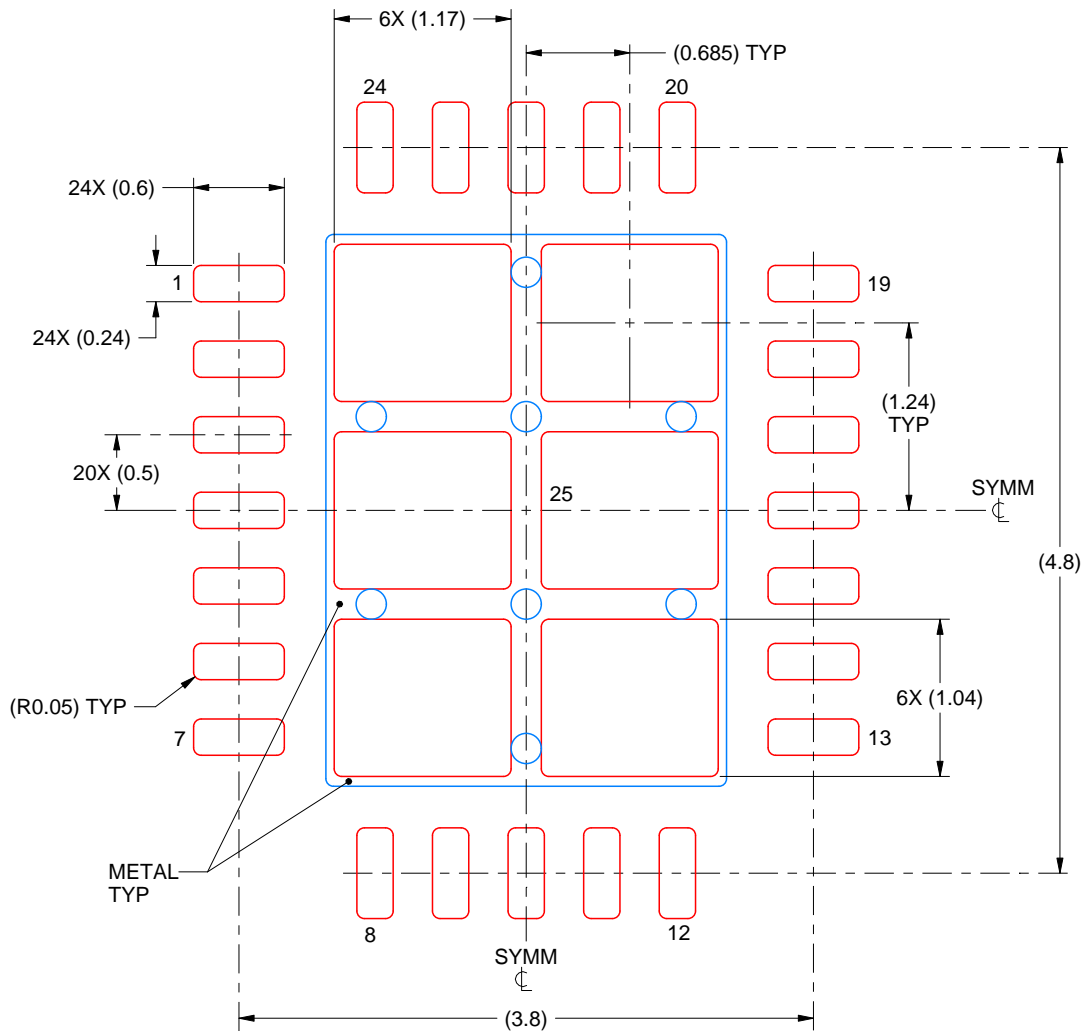

SOLDER PASTE EXAMPLE
 BASED ON 0.125 mm THICK STENCIL

EXPOSED PAD 25
 75% PRINTED SOLDER COVERAGE BY AREA UNDER PACKAGE
 SCALE:20X

4219064 /A 04/2017

NOTES: (continued)

6. Laser cutting apertures with trapezoidal walls and rounded corners may offer better paste release. IPC-7525 may have alternate design recommendations.

重要声明和免责声明

TI“按原样”提供技术和可靠性数据（包括数据表）、设计资源（包括参考设计）、应用或其他设计建议、网络工具、安全信息和其他资源，不保证没有瑕疵且不做任何明示或暗示的担保，包括但不限于对适销性、某特定用途方面的适用性或不侵犯任何第三方知识产权的暗示担保。

这些资源可供使用 TI 产品进行设计的熟练开发人员使用。您将自行承担以下全部责任：(1) 针对您的应用选择合适的 TI 产品，(2) 设计、验证并测试您的应用，(3) 确保您的应用满足相应标准以及任何其他功能安全、信息安全、监管或其他要求。

这些资源如有变更，恕不另行通知。TI 授权您仅可将这些资源用于研发本资源所述的 TI 产品的应用。严禁对这些资源进行其他复制或展示。您无权使用任何其他 TI 知识产权或任何第三方知识产权。您应全额赔偿因在这些资源的使用中对 TI 及其代表造成的任何索赔、损害、成本、损失和债务，TI 对此概不负责。

TI 提供的产品受 [TI 的销售条款](#) 或 [ti.com](#) 上其他适用条款/TI 产品随附的其他适用条款的约束。TI 提供这些资源并不会扩展或以其他方式更改 TI 针对 TI 产品发布的适用的担保或担保免责声明。

TI 反对并拒绝您可能提出的任何其他或不同的条款。

邮寄地址：Texas Instruments, Post Office Box 655303, Dallas, Texas 75265

Copyright © 2024，德州仪器 (TI) 公司