

# SN65DSI83-Q1 汽车类单通道 MIPI® DSI 转单链路 LVDS 桥接器

## 1 特性

- 符合汽车类应用的要求
- 具有符合 AEC-Q100 标准的下列特性：
  - 器件温度等级 2：环境工作温度范围为  $-40^{\circ}\text{C}$  至  $+105^{\circ}\text{C}$
  - 器件 HBM ESD 分类等级 3A
  - 器件 CDM ESD 分类等级 C6
- 实现 MIPI®D-PHY 1.00.00 版本的物理层前端和 1.02.00 版本的显示串行接口 (DSI)
- 单通道 DSI 接收器每通道可配置 1、2、3 或 4 条 D-PHY 数据信道，每条信道的运行速率高达 1Gbps
- 支持 RGB666 和 RGB888 格式的 18bpp 与 24bpp DSI 视频流
- 最大分辨率高达 60fps WUXGA 1920 × 1200 (18bpp 和 24bpp 颜色，采用简化消隐)。适合 60fps 1366 × 768/1280 × 800 (18bpp 和 24bpp)
- 针对单链路 LVDS 的输出
- 支持单通道 DSI 至单链路 LVDS 运行模式
- LVDS 输出时钟范围为 25MHz 至 154MHz
- LVDS 像素时钟可采用自由运行持续 D-PHY 时钟或外部基准时钟 (REFCLK)
- 1.8V 主  $V_{CC}$  电源
- 低功耗特性包括关断模式、低 LVDS 输出电压摆幅、共模以及 MIPI 超低功耗状态 (ULPS) 支持
- 针对简化印刷电路板 (PCB) 走线的 LVDS 通道交换 (SWAP)，LVDS 引脚顺序反向特性
- 采用 64 引脚 10mm × 10mm HTQFP (PAP) 封装 PowerPAD™IC 封装

## 2 应用

- 集成显示屏的信息娱乐系统主机
- 具有远程显示屏的信息娱乐系统主机
- 后座信息娱乐系统
- 混合动力汽车仪表盘
- 便携式导航设备
- 导航
- 工业人机界面 (HMI) 和显示屏

## 3 说明

SN65DSI83-Q1 DSI 转 LVDS 桥接器具有一个单通道 MIPI D-PHY 接收器前端配置，此配置中在每个通道上具有 4 条信道，每条信道的运行速率为 1Gbps，最大输入带宽为 4Gbps。该桥接器可解码 MIPI DSI 18bpp RGB666 和 24bpp RGB888 视频流，并将格式化视频数据流转换为 LVDS 输出（像素时钟范围为 25MHz 至 154MHz），从而提供单链路 LVDS（每个链路具有 4 个数据信道）。

SN65DSI83-Q1 器件可支持高达 WUXGA 1920 × 1200（每秒 60 帧，24bpp，采用简化消隐）的分辨率。SN65DSI83-Q1 器件还适用于使用 60fps 1366 × 768/1280 × 800（18bpp 和 24bpp）的应用。该器件实现了部分线路缓冲以适应 DSI 与 LVDS 接口间的数据流不匹配的情况。

SN65DSI83-Q1 器件采用小外形 10mm × 10mm HTQFP（0.5mm 间距）封装，工作温度范围为  $-40^{\circ}\text{C}$  至  $+105^{\circ}\text{C}$ 。

### 器件信息<sup>(1)</sup>

器件编号	封装	封装尺寸（标称值）
SN65DSI83-Q1	HTQFP (64)	10.00mm x 10.00mm

(1) 如需了解所有可用封装，请参阅产品说明书末尾的可订购产品附录。

### SN65DSI83-Q1 原理图

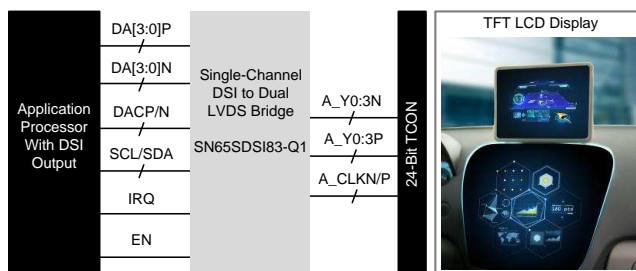

Copyright © 2016, Texas Instruments Incorporated



## 目录

1	特性 .....	1	8.5	Register Maps .....	23
2	应用 .....	1	<b>9</b>	<b>Application and Implementation</b> .....	<b>37</b>
3	说明 .....	1	9.1	Application Information .....	37
4	修订历史记录 .....	2	9.2	Typical Application .....	38
<b>5</b>	<b>Pin Configuration and Functions</b> .....	<b>3</b>	<b>10</b>	<b>Power Supply Recommendations</b> .....	<b>43</b>
<b>6</b>	<b>Specifications</b> .....	<b>6</b>	10.1	V <sub>CC</sub> Power Supply .....	43
6.1	Absolute Maximum Ratings .....	6	10.2	V <sub>CORE</sub> Power Supply .....	43
6.2	ESD Ratings .....	6	<b>11</b>	<b>Layout</b> .....	<b>43</b>
6.3	Recommended Operating Conditions .....	6	11.1	Layout Guidelines .....	43
6.4	Thermal Information .....	6	11.2	Layout Example .....	44
6.5	Electrical Characteristics .....	7	<b>12</b>	<b>器件和文档支持</b> .....	<b>45</b>
6.6	Switching Characteristics .....	9	12.1	文档支持 .....	45
<b>7</b>	<b>Parameter Measurement Information</b> .....	<b>10</b>	12.2	接收文档更新通知 .....	45
<b>8</b>	<b>Detailed Description</b> .....	<b>13</b>	12.3	社区资源 .....	45
8.1	Overview .....	13	12.4	商标 .....	45
8.2	Functional Block Diagram .....	13	12.5	静电放电警告 .....	45
8.3	Feature Description .....	13	12.6	术语表 .....	45
8.4	Programming .....	21	<b>13</b>	<b>机械、封装和可订购信息</b> .....	<b>46</b>

## 4 修订历史记录

Changes from Original (December 2016) to Revision A	Page
• Deleted figure <i>RESET and Initialization Timing Definition While V<sub>CC</sub> is High</i> .....	12
• Changed the paragraph following <a href="#">Figure 8</a> .....	15
• Changed <i>Recommended Initialization Sequence</i> To: <i>Initialization Sequence</i> .....	16
• Changed <a href="#">Table 2</a> .....	16
• Changed item 3 in <i>Video Stop and Restart Sequence</i> From: Drive all DSI input lanes including DSI CLK lane to LP11. To: Drive all DSI data lanes to LP11, but keep the DSI CLK lanes in HS. ....	37

## 5 Pin Configuration and Functions

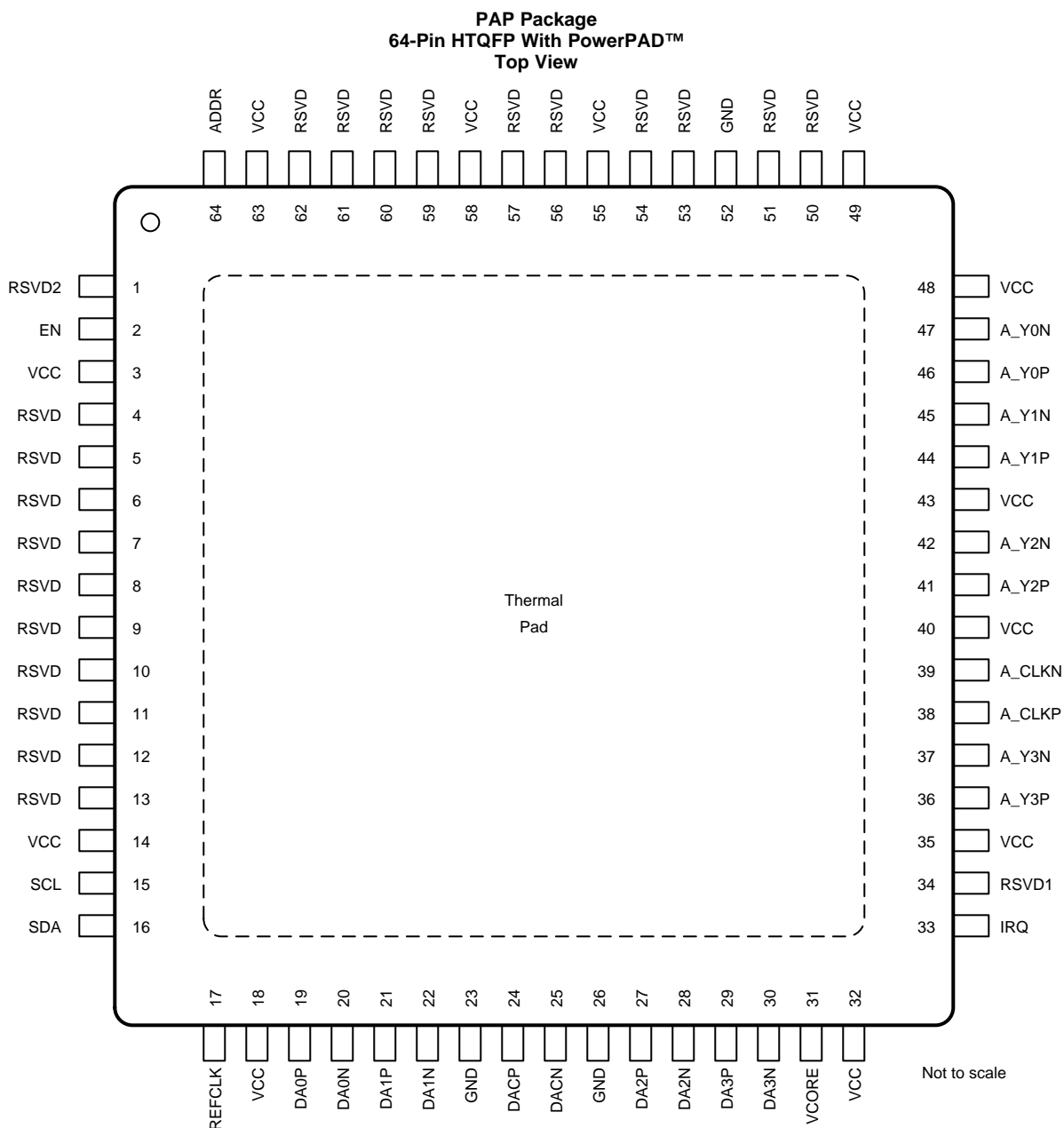

See the [Layout](#) section for layout information.

### Pin Functions

PIN		TYPE	DESCRIPTION
NAME	NO.		
ADDR	64	I/O	Local I <sup>2</sup> C interface target address select. See <a href="#">Table 3</a> . In normal operation this pin is an input. When the ADDR pin is programmed high, it must be tied to the same 1.8-V power rails where the SN65DSI83-Q1 VCC 1.8-V power rail is connected
A_CLKP	38	O	LVDS channel A, LVDS clock output
A_CLKN	39		
A_Y0P	46	O	LVDS channel A, LVDS data output 0
A_Y0N	47		
A_Y1P	44	O	LVDS channel A, LVDS data output 1
A_Y1N	45		
A_Y2P	41	O	LVDS channel A, LVDS data output 2
A_Y2N	42		
A_Y3P	36	O	LVDS channel A, LVDS data output 3. A_Y3P and A_Y3N must be left not connected (NC) for 18-bpp panels
A_Y3N	37		
DA0P	19	I	MIPI D-PHY channel A, data lane 0; data rate up to 1 Gbps
DA0N	20		
DA1P	21	I	MIPI D-PHY channel A, data lane 1; data rate up to 1 Gbps
DA1N	22		
DA2P	27	I	MIPI D-PHY channel A, data lane 2; data rate up to 1 Gbps
DA2N	28		
DA3P	29	I	MIPI D-PHY channel A, data lane 3; data rate up to 1 Gbps
DA3N	30		
DACP	24	I	MIPI D-PHY channel A, clock lane; data rate up to 1 Gbps
DACN	25		
EN	2	I	Chip enable and reset. The device is reset (shutdown) when the EN pin is low
GND	23, 26, 52	G	Reference ground
IRQ	33	O	Interrupt signal
REFCLK	17	I	This pin is an optional external reference clock for the LVDS pixel clock. If an external reference clock is not used, this pin must be pulled to ground with an external resistor. The source of the reference clock must be placed as close as possible with a series resistor near the source to reduce EMI

**Pin Functions (continued)**

PIN		TYPE	DESCRIPTION
NAME	NO.		
RSVD	4	RSVD	Reserved and leave them unconnected
	5		
	6		
	7		
	8		
	9		
	10		
	11		
	12		
	13		
	50		
	51		
	53		
	54		
	56		
57			
59			
60			
61			
62			
RSVD1	34	I/O	Reserved. This pin must be left unconnected for normal operation
RSVD2	1	I	Reserved. This pin must be left unconnected for normal operation
SCL	15	I	Local I <sup>2</sup> C interface clock
SDA	16	I/O	Local I <sup>2</sup> C interface data
V <sub>CC</sub>	3	—	1.8-V power supply
	14		
	18		
	32		
	35		
	40		
	43		
	48		
	49		
	55		
58			
63			
VCORE	31	P	1.1-V output from the voltage regulator. This pin must have a 1-μF external capacitor to ground
PowerPAD	—	—	Reference ground

## 6 Specifications

### 6.1 Absolute Maximum Ratings

over operating free-air temperature range (unless otherwise noted)<sup>(1)</sup>

		MIN	MAX	UNIT	
V <sub>CC</sub>	Supply voltage	-0.3	2.175	V	
	Input voltage	CMOS input pins	-0.5	2.175	V
		DSI input pins (DAxP, DAxN)	-0.4	1.4	V
T <sub>A</sub>	Operating free-air temperature	-40	105	°C	
T <sub>J</sub>	Junction temperature	-40	115	°C	
T <sub>stg</sub>	Storage temperature	-65	150	°C	

- (1) Stresses beyond those listed under *Absolute Maximum Ratings* may cause permanent damage to the device. These are stress ratings only, which do not imply functional operation of the device at these or any other conditions beyond those indicated under *Recommended Operating Conditions*. Exposure to absolute-maximum-rated conditions for extended periods may affect device reliability.

### 6.2 ESD Ratings

		VALUE	UNIT
V <sub>(ESD)</sub>	Electrostatic discharge	Human-body model (HBM), per AEC Q100-002 <sup>(1)</sup>	±4000
		Charged-device model (CDM), per AEC Q100-011	±1000

- (1) AEC Q100-002 indicates that HBM stressing shall be in accordance with the ANSI/ESDA/JEDEC JS-001 specification.

### 6.3 Recommended Operating Conditions

over operating free-air temperature range (unless otherwise noted)

		MIN	NOM	MAX	UNIT
V <sub>CC</sub>	V <sub>CC</sub> power supply	1.65	1.8	1.95	V
V <sub>PSN</sub>	Supply noise on any V <sub>CC</sub> pin	$f_{(noise)} > 1 \text{ MHz}$		0.05	V
V <sub>(DSI)</sub>	DSI input pin voltage	-50		1350	mV
f <sub>(I2C)</sub>	Local I <sup>2</sup> C input frequency			400	kHz
f <sub>HS(CLK)</sub>	DSI high-speed (HS) clock input frequency	40		500	MHz
t <sub>su</sub>	DSI HS data to clock setup time; see <a href="#">Figure 1</a>	0.15			UI <sup>(1)</sup>
t <sub>h</sub>	DSI HS data to clock hold time; see <a href="#">Figure 1</a>	0.15			UI <sup>(1)</sup>
Z <sub>OD(LVDS)</sub>	LVDS output differential impedance	90		132	Ω
T <sub>C</sub>	Case temperature			92.2	°C

- (1) The unit interval (UI) is one half of the period of the HS clock; at 500 MHz the minimum setup and hold time is 150 ps.

### 6.4 Thermal Information

THERMAL METRIC <sup>(1)</sup>		SN65DSI83-Q1	UNIT
		PAP (HTQFP)	
		64 PINS	
R <sub>θJA</sub>	Junction-to-ambient thermal resistance	36.1	°C/W
R <sub>θJC(top)</sub>	Junction-to-case (top) thermal resistance	18.2	°C/W
R <sub>θJB</sub>	Junction-to-board thermal resistance	20.6	°C/W
ψ <sub>JT</sub>	Junction-to-top characterization parameter	0.8	°C/W
ψ <sub>JB</sub>	Junction-to-board characterization parameter	20.5	°C/W
R <sub>θJC(bot)</sub>	Junction-to-case (bottom) thermal resistance	2.2	°C/W

- (1) For more information about traditional and new thermal metrics, see the [Semiconductor and IC Package Thermal Metrics](#) application report.

## 6.5 Electrical Characteristics

over operating free-air temperature range (unless otherwise noted)

PARAMETER		TEST CONDITIONS	MIN	TYP <sup>(1)</sup>	MAX	UNIT
V <sub>IL</sub>	Low-level control signal input voltage				0.3 × V <sub>CC</sub>	V
V <sub>IH</sub>	High-level control signal input voltage		0.7 × V <sub>CC</sub>			V
V <sub>OH</sub>	High-level output voltage	I <sub>OH</sub> = -4 mA	1.25			V
V <sub>OL</sub>	Low-level output voltage	I <sub>OL</sub> = 4 mA			0.4	V
I <sub>LKG</sub>	Input failsafe leakage current	V <sub>CC</sub> = 0; V <sub>CC(PIN)</sub> = 1.8 V			±30	μA
I <sub>IH</sub>	High level input current	Any input terminal			±30	μA
I <sub>IL</sub>	Low level input current	Any input terminal			±30	μA
I <sub>OZ</sub>	High-impedance output current	CMOS output terminals			±10	μA
I <sub>OS</sub>	Short-circuit output current	Any output driving GND short			±50	mA
I <sub>CC</sub>	Device active current	See <sup>(2)</sup>		77	124	mA
I <sub>ULPS</sub>	Device standby current	All data and clock lanes are in ultra-low power state (ULPS)		7.7	14	mA
I <sub>RST</sub>	Shutdown current	EN = 0			130	μA
R <sub>EN</sub>	EN control input resistor			200		kΩ

- (1) All typical values are at V<sub>CC</sub> = 1.8 V and T<sub>A</sub> = 25°C  
(2) SN65DSI83-Q1: SINGLE Channel DSI to SINGLE Channel DSI, 1280 × 800  
(a) Number of LVDS lanes = 3 data lanes + 1 CLK lane  
(b) Number of DSI lanes = 4 data lanes + 1 CLK lane  
(c) LVDS CLK OUT = 83 M  
(d) DSI CLK = 500 M  
(e) RGB888, LVDS 18 bpp  
Maximum values are at V<sub>CC</sub> = 1.95 V and T<sub>A</sub> = 85°C

**Electrical Characteristics (continued)**

over operating free-air temperature range (unless otherwise noted)

PARAMETER	TEST CONDITIONS	MIN	TYP <sup>(1)</sup>	MAX	UNIT	
<b>MIPI DSI INTERFACE</b>						
V <sub>IH-LP</sub>	LP receiver input high threshold	See Figure 2	880		mV	
V <sub>IL-LP</sub>	LP receiver input low threshold	See Figure 2		550	mV	
V <sub>ID</sub>	HS differential input voltage		100	270	mV	
V <sub>IDT</sub>	HS differential input voltage threshold			50	mV	
V <sub>IL-ULPS</sub>	LP receiver input low threshold; ultra-low power state (ULPS)			300	mV	
V <sub>CM-HS</sub>	HS common mode voltage; steady-state		70	330	mV	
ΔV <sub>CM-HS</sub>	HS common mode peak-to-peak variation including symbol delta and interference			100	mV	
V <sub>IH-HS</sub>	HS single-ended input high voltage	See Figure 2		460	mV	
V <sub>IL-HS</sub>	HS single-ended input low voltage	See Figure 2	-40		mV	
V <sub>TERM-EN</sub>	HS termination enable; single-ended input voltage (both Dp AND Dn apply to enable)	Termination is switched simultaneous for Dn and Dp		450	mV	
R <sub>DIFF-HS</sub>	HS mode differential input impedance		80	125	Ω	
<b>LVDS OUTPUT</b>						
V <sub>Odl</sub>	Steady-state differential output voltage A <sub>Y</sub> x P/N	CSR 0x19.3:2=00 100 Ω near end termination	180	245	330	mV
		CSR 0x19.3:2=01 100 Ω near end termination	215	293	392	
		CSR 0x19.3:2=10 100 Ω near end termination	250	341	455	
		CSR 0x19.3:2=11 100 Ω near end termination	290	389	515	
		CSR 0x19.3:2=00 200 Ω near end termination	150	204	275	
		CSR 0x19.3:2=01 200 Ω near end termination	200	271	365	
		CSR 0x19.3:2=10 200 Ω near end termination	250	337	450	
		CSR 0x19.3:2=11 200 Ω near end termination	300	402	535	
V <sub>Odl</sub>	Steady-state differential output voltage for A <sub>CLKP/N</sub>	CSR 0x19.3:2=00 near end termination	140	191	262	mV
		CSR 0x19.3:2=01 100 Ω near end termination	168	229	315	
		CSR 0x19.3:2=10 100 Ω near end termination	195	266	365	
		CSR 0x19.3:2=11 100 Ω near end termination	226	303	415	
		CSR 0x19.3:2=00 200 Ω near end termination	117	159	220	
		CSR 0x19.3:2=01 200 Ω near end termination	156	211	295	
		CSR 0x19.3:2=10 200 Ω near end termination	195	263	362	
		CSR 0x19.3:2=11 200 Ω near end termination	234	314	435	
Δ V <sub>Odl</sub>	Change in steady-state differential output voltage between opposite binary states	RL = 100 Ω		35	mV	
V <sub>OC(SS)</sub>	Steady state common-mode output voltage <sup>(3)</sup>	CSR 0x19.6 = 1 and CSR 0x1B.6 = 1 Figure 3	0.75	0.9	1.13	V
		CSR 0x19.6 = 0 see Figure 3	1	1.25	1.5	
V <sub>OC(PP)</sub>	Peak-to-peak common-mode output voltage	see Figure 3		35	mV	
R <sub>LVDS_D IS</sub>	Pulldown resistance for disabled LVDS outputs		1		kΩ	

 (3) Tested at V<sub>CC</sub> = 1.8V, T<sub>A</sub> = -40°C for MIN, T<sub>A</sub> = 25°C for TYP, T<sub>A</sub> = 105°C for MAX.



## 6.6 Switching Characteristics

over operating free-air temperature range (unless otherwise noted)

PARAMETER		TEST CONDITIONS	MIN	TYP <sup>(1)</sup>	MAX	UNIT
<b>DSI</b>						
$t_{GS}$	DSI LP glitch suppression pulse width				300	ps
<b>LVDS</b>						
$t_c$	Output clock period		6.49		40	ns
$t_w$	High-level output clock (CLK) pulse duration			$4/7 t_c$		ns
$t_0$	Delay time, CLK $\uparrow$ to 1st serial bit position		-0.15		0.15	ns
$t_1$	Delay time, CLK $\uparrow$ to 2nd serial bit position	$t_c = 6.49$ ns; Input clock jitter < 25 ps (REFCLK) See <a href="#">Figure 4</a>	$1/7 t_c - 0.15$		$1/7 t_c + 0.15$	ns
$t_2$	Delay time, CLK $\uparrow$ to 3rd serial bit position		$2/7 t_c - 0.15$		$2/7 t_c + 0.15$	ns
$t_3$	Delay time, CLK $\uparrow$ to 4th serial bit position		$3/7 t_c - 0.15$		$3/7 t_c + 0.15$	ns
$t_4$	Delay time, CLK $\uparrow$ to 5th serial bit position		$4/7 t_c - 0.15$		$4/7 t_c + 0.15$	ns
$t_5$	Delay time, CLK $\uparrow$ to 6th serial bit position		$5/7 t_c - 0.15$		$5/7 t_c + 0.15$	ns
$t_6$	Delay time, CLK $\uparrow$ to 7th serial bit position		$6/7 t_c - 0.15$		$6/7 t_c + 0.15$	ns
$t_r$	Differential output rise time		See <a href="#">Figure 4</a>		180	
$t_f$	Differential output fall time			500		ps
<b>EN, ULPS, RESET</b>						
$t_{en}$	Enable time from EN or ULPS	$t_{c(o)} = 12.9$ ns			1	ms
$t_{dis}$	Disable time to standby; see	$t_{c(o)} = 12.9$ ns			0.1	ms
$t_{reset}$	Reset yime		10			ms
<b>REFCLK</b>						
$F_{REFCLK}$	REFCLK frequency. Supported frequencies: 25 MHz - 154 MHz		25		154	MHz
$t_r, t_f$	REFCLK rise and fall time		$100 \times 10^{-12}$		$1 \times 10^{-9}$	s
$t_{pj}$	REFCLK peak-to-peak phase jitter				50	ps
Duty	REFCLK duty cycle		40%	50%	60%	
<b>REFCLK or DSI CLK (DACP/N)</b>						
SSC_CLKIN	SSC enabled Input CLK center spread depth <sup>(2)</sup>		0.5%	1%	2%	
	Modulation frequency		30		60	kHz

(1) All typical values are at  $V_{CC} = 1.8$  V and  $T_A = 25^\circ\text{C}$ 

(2) For EMI reduction purpose, the SN65DSI83-Q1 supports the center spreading of the LVDS CLK output through the REFCLK or DSI CLK input. The center spread CLK input to the REFCLK or DSI CLK is passed through to the LVDS CLK output A\_CLKP/N.

## 7 Parameter Measurement Information

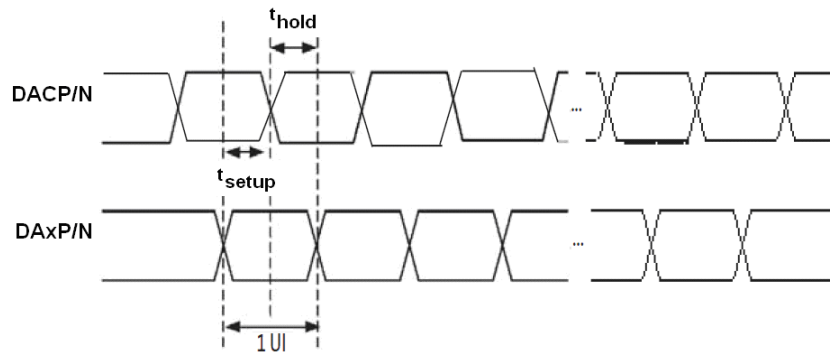

Figure 1. DSI HS Mode Receiver Timing Definitions

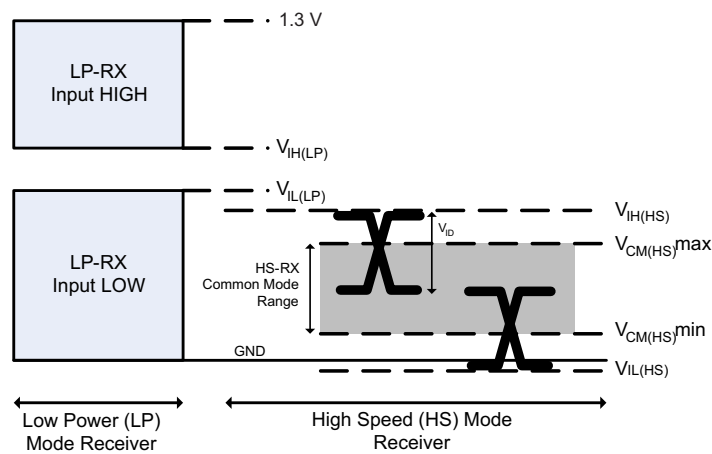

Figure 2. DSI Receiver Voltage Definitions

Parameter Measurement Information (continued)

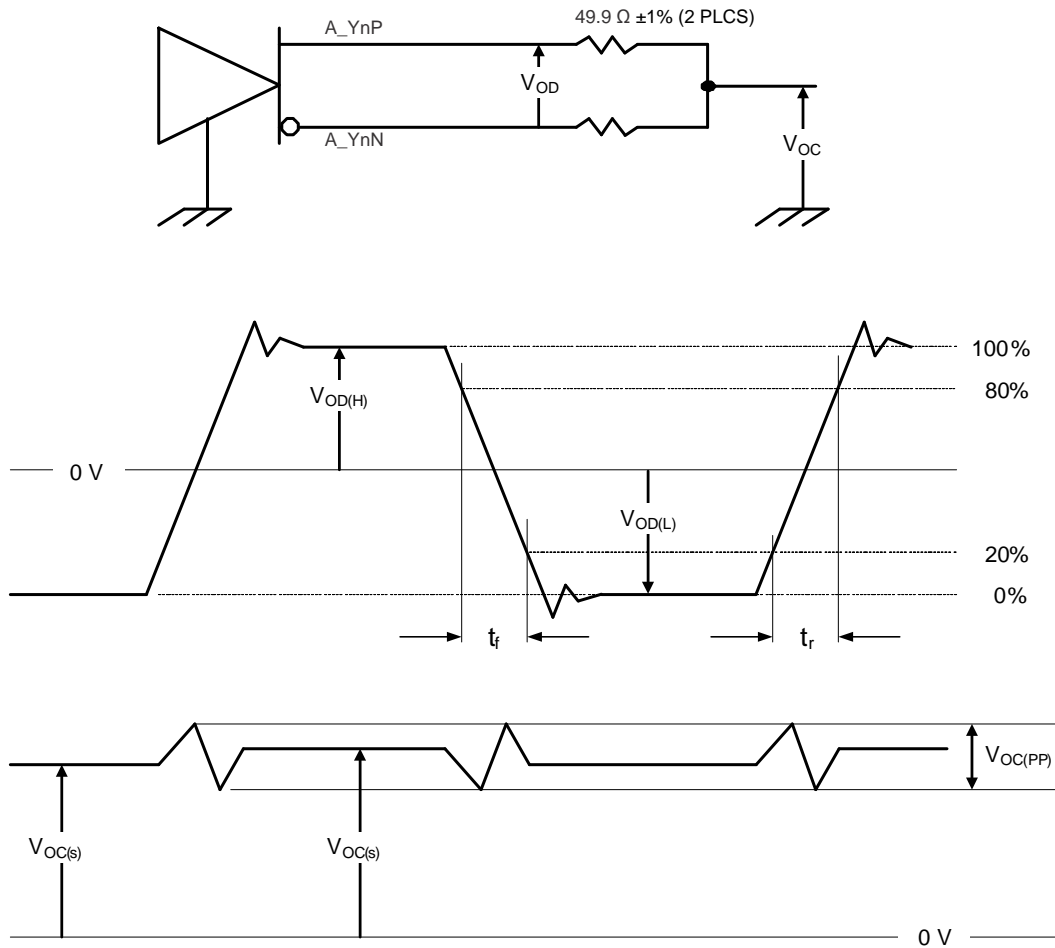

Figure 3. Test Load and Voltage Definitions for LVDS Outputs

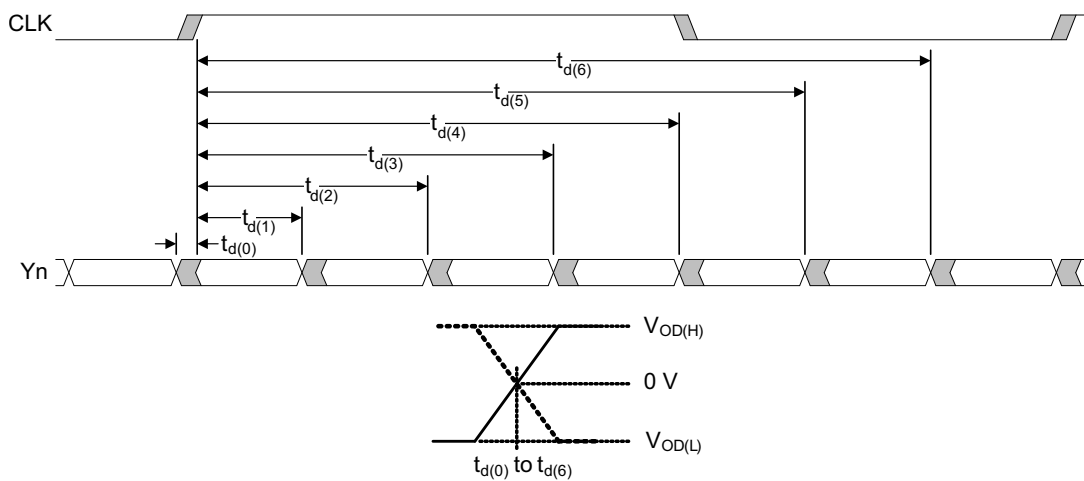
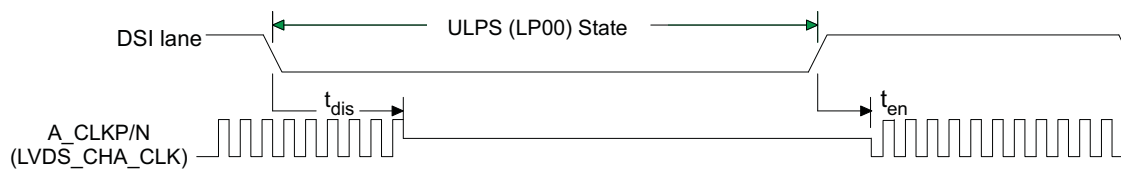

Figure 4. SN65DSI83-Q1 LVDS Timing Definitions

**Parameter Measurement Information (continued)**

- (1) See the [ULPS](#) section of the data sheet for the ULPS entry and exit sequence.
- (2) ULPS entry and exit protocol and timing requirements must be met according to the MIPI DPHY specification.

**Figure 5. ULPS Timing Definition**

## 8 Detailed Description

### 8.1 Overview

The SN65DSI83-Q1 DSI to LVDS bridge device features a single-channel MIPI® D-PHY receiver front-end configuration with four lanes per channel operating at 1 Gbps per lane; a maximum input bandwidth of 4 Gbps. The bridge decodes MIPI DSI 18-bpp RGB666 and 24-bpp RGB888 packets and converts the formatted video data stream to an LVDS output operating at pixel clocks operating from 25 MHz to 154 MHz, offering a Single-Link LVDS with four data lanes per link.

### 8.2 Functional Block Diagram

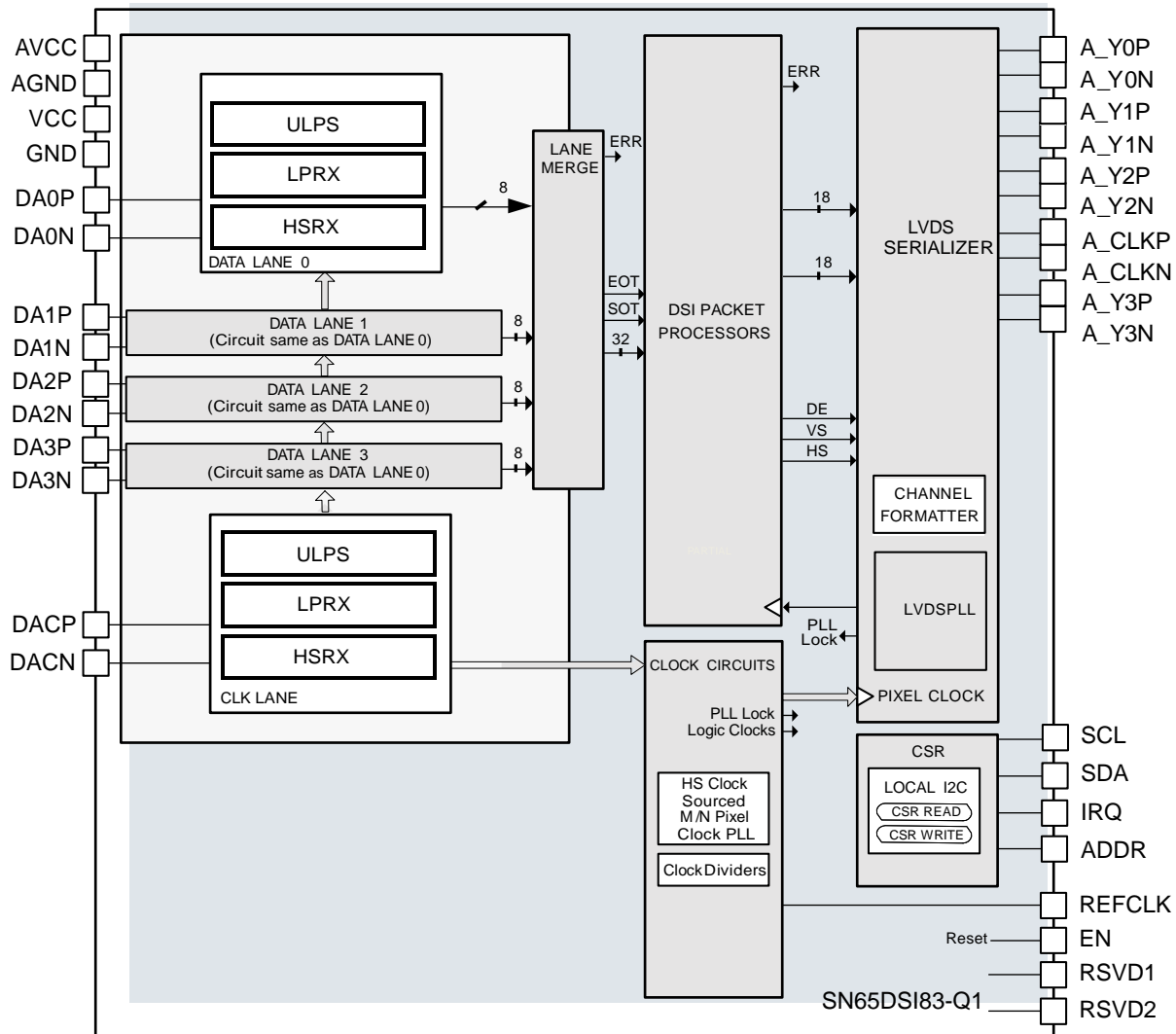

### 8.3 Feature Description

#### 8.3.1 Clock Configurations and Multipliers

The LVDS clock may be derived from the DSI channel A clock, or from an external reference clock source. When the MIPI D-PHY channel A HS clock is used as the LVDS clock source, the D-PHY clock lane must operate in HS free-running (continuous) mode. This feature eliminates the need for an external reference clock reducing system costs.

## Feature Description (continued)

The reference clock source is selected by HS\_CLK\_SRC (CSR 0x0A.0) programmed through the local I<sup>2</sup>C interface. If an external reference clock is selected, it is multiplied by the factor in REFCLK\_MULTIPLIER (CSR 0x0B.1:0) to generate the LVDS output clock. When an external reference clock is selected, it must be between 25 MHz and 154 MHz. If the DSI channel A clock is selected, it is divided by the factor in DSI\_CLK\_DIVIDER (CSR 0x0B.7:3) to generate the LVDS output clock. Additionally, LVDS\_CLK\_RANGE (CSR 0x0A.3:1) and CH\_DSI\_CLK\_RANGE (CSR 0x12) must be set to the frequency range of the LVDS output clock and DSI Channel A input clock respectively for the internal PLL to operate correctly. After these settings are programmed, PLL\_EN (CSR 0x0D.0) must be set to enable the internal PLL.

### 8.3.2 ULPS

The SN65DSI83-Q1 device supports the MIPI defined ULPS. While the device is in the ULPS, the CSR registers are accessible via I<sup>2</sup>C interface. ULPS sequence must be issued to all active DSI CLK and, or DSI data lanes of the enabled DSI channels for the SN65DSI83-Q1 device to enter the ULPS. The following sequence must be followed to enter and exit the ULPS.

1. The host issues a ULPS entry sequence to all DSI CLK and data lanes enabled.
2. When the host is ready to exit the ULPS mode, the host issues a ULPS exit sequence to all DSI CLK and data lanes that need to be active in normal operation.
3. Wait for the PLL\_LOCK bit (CSR 0x0A.7) to be set.
4. Set the SOFT\_RESET bit (CSR 0x09.0).
5. Device resumes normal operation (that is, video streaming resumes on the panel).

### 8.3.3 LVDS Pattern Generation

The SN65DSI83-Q1 device supports a pattern generation feature on LVDS channels. This feature can be used to test the LVDS output path and LVDS panels in a system platform. The pattern generation feature can be enabled by setting the CHA\_TEST\_PATTERN bit at address 0x3C. No DSI data is received while the pattern generation feature is enabled.

There are three modes available for LVDS test pattern generation. The mode of test pattern generation is determined by register configuration, as shown in [Table 1](#).

**Table 1. Video Registers**

ADDRESS BIT	REGISTER NAME
0x20.7:0	CHA_ACTIVE_LINE_LENGTH_LOW
0x21.3:0	CHA_ACTIVE_LINE_LENGTH_HIGH
0x24.7:0	CHA_VERTICAL_DISPLAY_SIZE_LOW
0x25.3:0	CHA_VERTICAL_DISPLAY_SIZE_HIGH
0x2C.7:0	CHA_HSYNC_PULSE_WIDTH_LOW
0x2D.1:0	CHA_HSYNC_PULSE_WIDTH_HIGH
0x30.7:0	CHA_VSYNC_PULSE_WIDTH_LOW
0x31.1:0	CHA_VSYNC_PULSE_WIDTH_HIGH
0x34.7:0	CHA_HORIZONTAL_BACK_PORCH
0x36.7:0	CHA_VERTICAL_BACK_PORCH
0x38.7:0	CHA_HORIZONTAL_FRONT_PORCH
0x3A.7:0	CHA_VERTICAL_FRONT_PORCH

### 8.3.4 Reset Implementation

When the EN pin is deasserted (low), the SN65DSI83-Q1 device is in SHUTDOWN or RESET state. In this state, CMOS inputs are ignored, the MIPI D-PHY inputs are disabled and outputs are high impedance. Transitioning the EN input from a low to a high level after the V<sub>CC</sub> supply has reached the minimum operating voltage as shown in [Figure 6](#) is critical. This transition is achieved by a control signal to the EN input, or by an external capacitor connected between EN and GND.

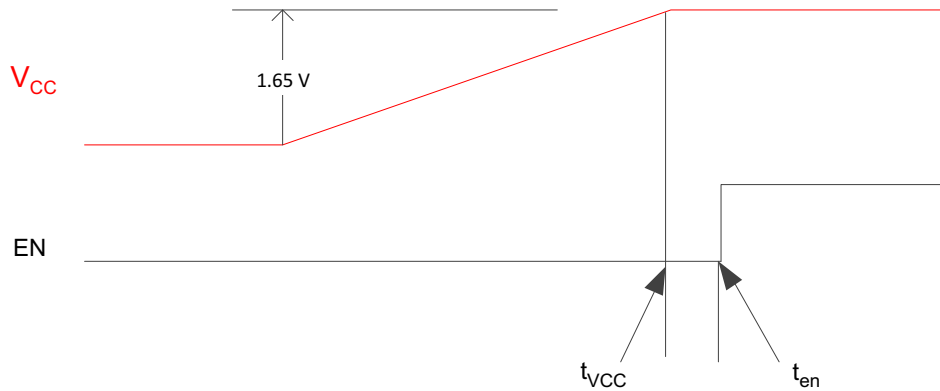

Figure 6. Cold-Start V<sub>CC</sub> Ramp Up to EN

When implementing the external capacitor, the size of the external capacitor depends on the power up ramp of the V<sub>CC</sub> supply, where a slower ramp-up results in a larger value external capacitor. Consider an approximately 200-nF capacitor as a reasonable first estimate for the size of the external capacitor.

Figure 7 and Figure 8 show both EN implementations.

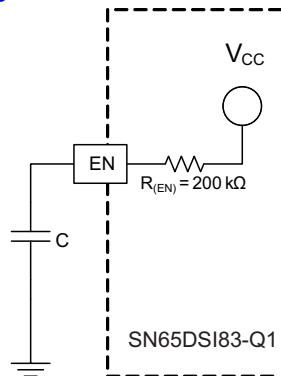

Figure 7. External Capacitor Controlled EN

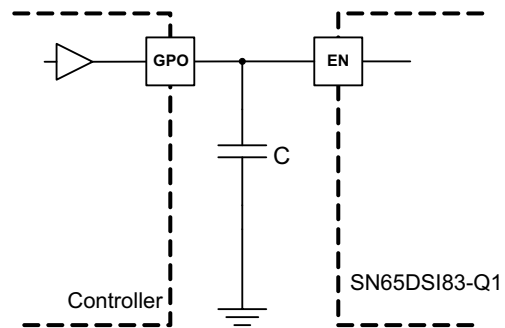

Figure 8. EN Input from Active Controller

When the SN65DSI83-Q1 is reset while V<sub>CC</sub> is high, the EN pin must be held low for at least 10 ms before being asserted high as described in Table 2 to be sure that the device is properly reset. The DSI CLK lane MUST be in HS and the DSI data lanes MUST be driven to LP11 while the device is in reset before the EN pin is asserted per the timing described in Table 2.

### 8.3.5 Initialization Sequence

Use the following initialization sequence to setup the SN65DSI83-Q1. This sequence is required for proper operation of the device. Steps 9 through 11 in the sequence are optional. Also see [Figure 6](#).

**Table 2. Initialization Sequence**

INITIALIZATION SEQUENCE NUMBER	INITIALIZATION SEQUENCE DESCRIPTION
Init seq 1	Power on
Init seq 2	After power is applied and stable, the DSI CLK lanes MUST be in HS state and the DSI data lanes MUST be driven to LP11 state
Init seq 3	Set EN pin to Low
Wait 10 ms <sup>(1)</sup>	
Init seq 4	Tie EN pin to High
Wait 10 ms <sup>(1)</sup>	
Init seq 5	Initialize all CSR registers to their appropriate values based on the implementation (The SN65DSI8x is not functional until the CSR registers are initialized)
Init seq 6	Set the PLL_EN bit (CSR 0x0D.0)
Wait 10 ms <sup>(1)</sup>	
Init seq 7	Set the SOFT_RESET bit (CSR 0x09.0)
Wait 10 ms <sup>(1)</sup>	
Init seq 8	Change DSI data lanes to HS state and start DSI video stream
Wait 5 ms <sup>(1)</sup>	
Init seq 9	Read back all registers and confirm they were correctly written
Init seq 10	Write 0xFF to CSR 0xE5 to clear the error registers
Wait 1 ms <sup>(1)</sup>	
Init seq 11	Read CSR 0xE5. If CSR 0xE5 != 0x00, then go back to step #2 and re-initialize

(1) Minimum recommended delay. It is fine to exceed these.

### 8.3.6 LVDS Output Formats

The SN65DSI83-Q1 device processes DSI packets and produces video data driven to the LVDS interface in an industry standard format. Single-Link LVDS is supported by the SN65DSI83-Q1 device. During conditions such as the default condition, and some video synchronization periods, where no video stream data is passing from the DSI input to the LVDS output, the SN65DSI83-Q1 device transmits zero value pixel data on the LVDS outputs while maintaining transmission of the vertical sync and horizontal sync status.

[Figure 9](#) illustrates a Single-Link LVDS 18-bpp application.

[Figure 10](#) illustrates a Single-Link 24-bpp application using Format 2, controlled by CHA\_24BPP\_FORMAT1 (CSR 0x18.1). In data Format 2, the two MSB per color are transferred on the Y3P/N LVDS lane.

[Figure 11](#) illustrates a 24-bpp Single-Link application using Format 1. In data Format 1, the two LSB per color are transferred on the Y3P/N LVDS lane.

[Figure 12](#) illustrates a Single-Link LVDS application where 24-bpp data is received from DSI and converted to 18 bpp data for transmission to an 18-bpp panel. This application is configured by setting CHA\_24BPP\_FORMAT1 (CSR 0x18.1) to 1 and CHA\_24BPP\_MODE (CSR 0x18.3) to 0. In this configuration, the SN65DSI83-Q1 device does not transmit the 2 LSB per color since the Y3P and Y3N LVDS lane is disabled.

**NOTE**

[Figure 9](#), [Figure 10](#), [Figure 11](#), and [Figure 12](#) only illustrate a few example applications for the SN65DSI83-Q1 device. Other applications are also supported.



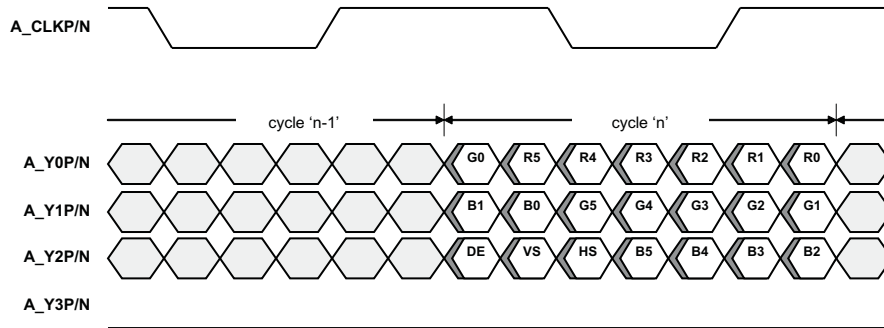

DE = Data Enable; A\_Y3P/N are Output Low

**Figure 9. LVDS Output Data; Single-Link 18 bpp**

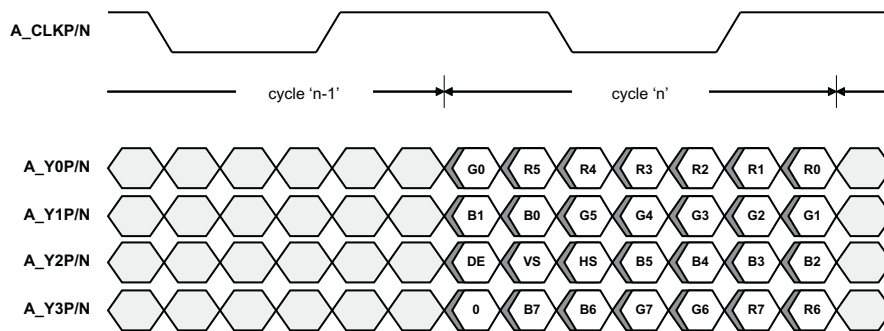

DE = Data Enable

**Figure 10. LVDS Output Data (Format 2); Single-Link 24 bpp**

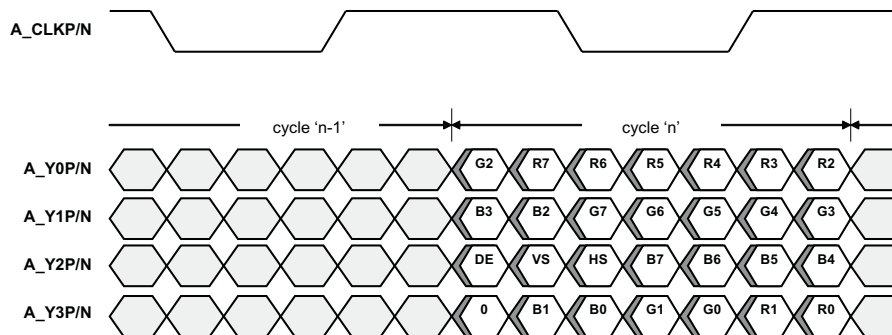

DE = Data Enable

**Figure 11. LVDS Output Data (Format 1); Single-Link 24 bpp**

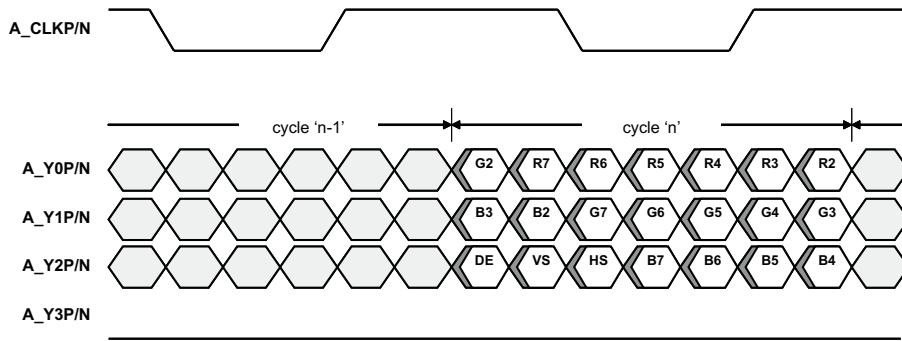

DE = Data Enable; A\_Y3P and A\_Y3N are output low; A\_Y3P and A\_Y3N are output low

Figure 12. LVDS Output Data (Format 1); 24 bpp to Single-Link 18 bpp Conversion

### 8.3.7 DSI Lane Merging

The SN65DSI83-Q1 supports four DSI data lanes per input channel, and may be configured to support one, two, or three DSI data lanes per channel. Unused DSI input pins on the SN65DSI83-Q1 must be left unconnected or driven to LP11 state. The bytes received from the data lanes are merged in HS mode to form packets that carry the video stream. DSI data lanes are bit and byte aligned.

Figure 13 shows the lane merging function for each channel; 4-Lane, 3-Lane, and 2-Lane modes are illustrated.

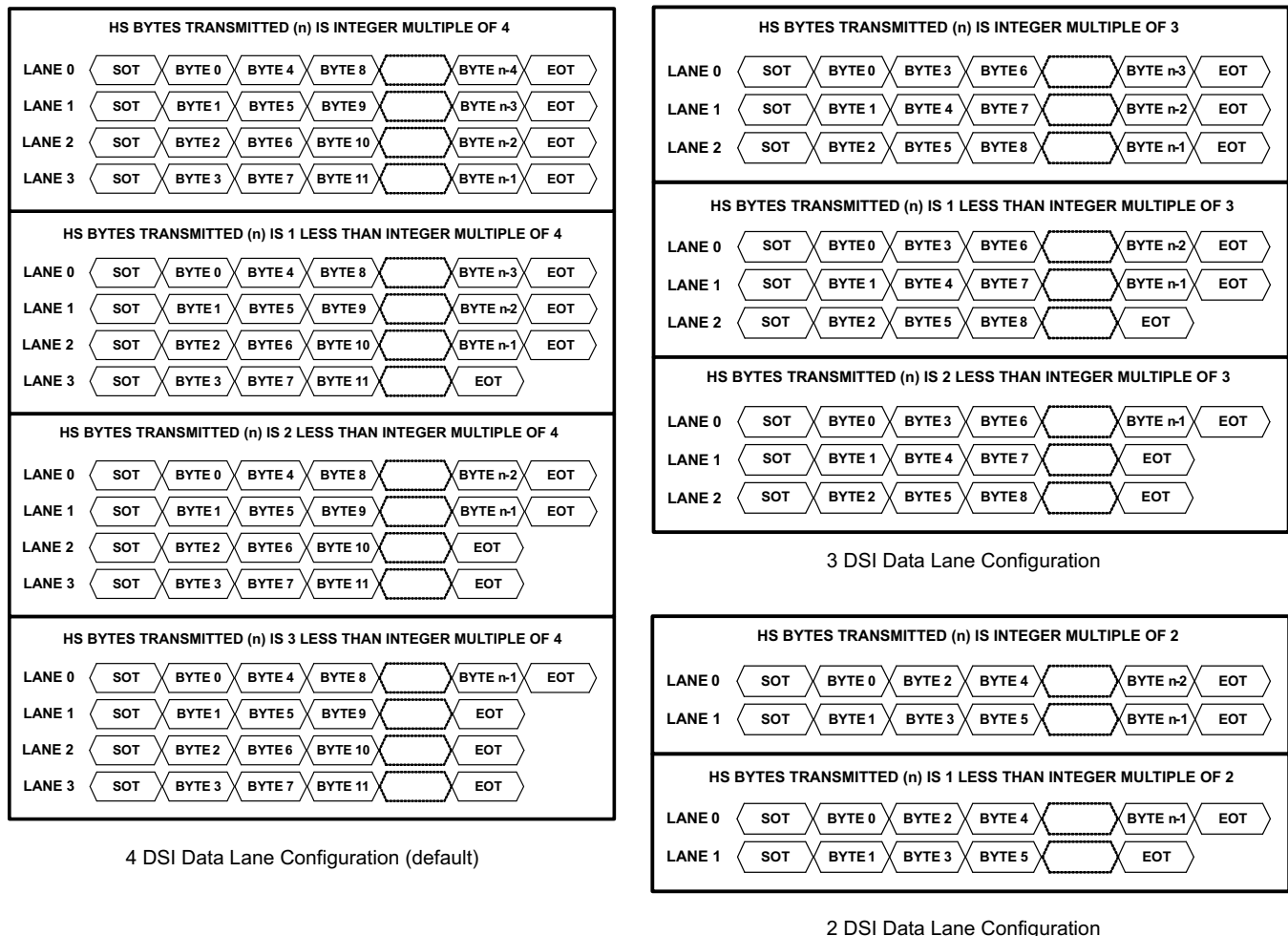

Figure 13. SN65DSI83-Q1 DSI Lane Merging Illustration

### 8.3.8 DSI Pixel Stream Packets

The SN65DSI83-Q1 processes 18-bpp (RGB666) and 24-bpp (RGB888) DSI packets as shown in Figure 14, Figure 15, and Figure 16.

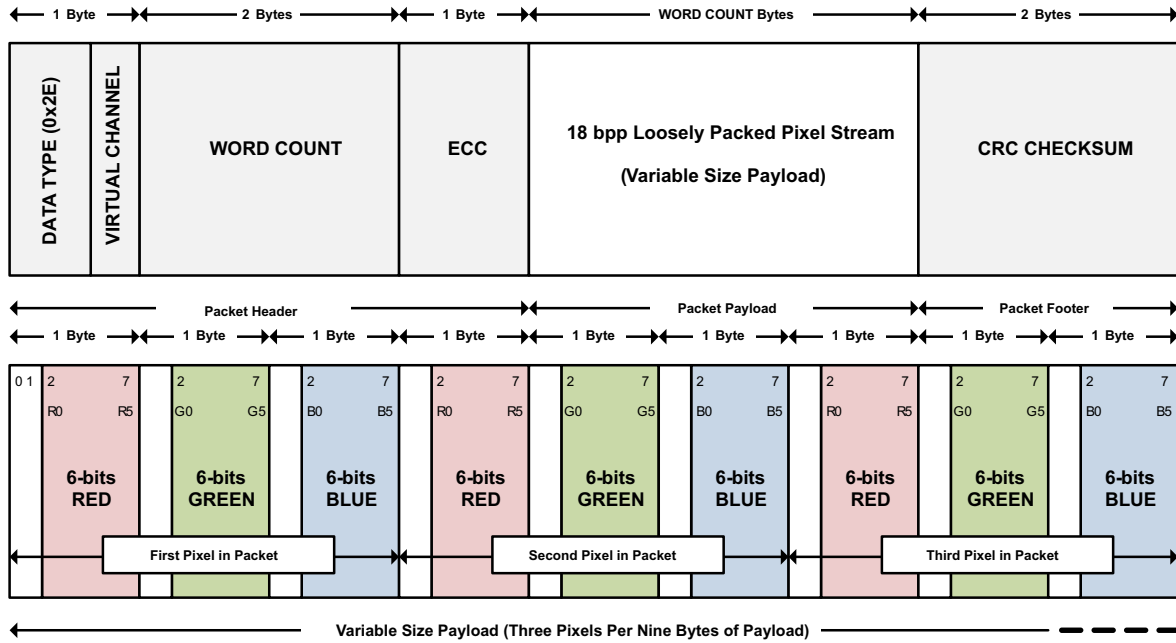

Figure 14. 18-bpp (Loosely Packed) DSI Packet Structure

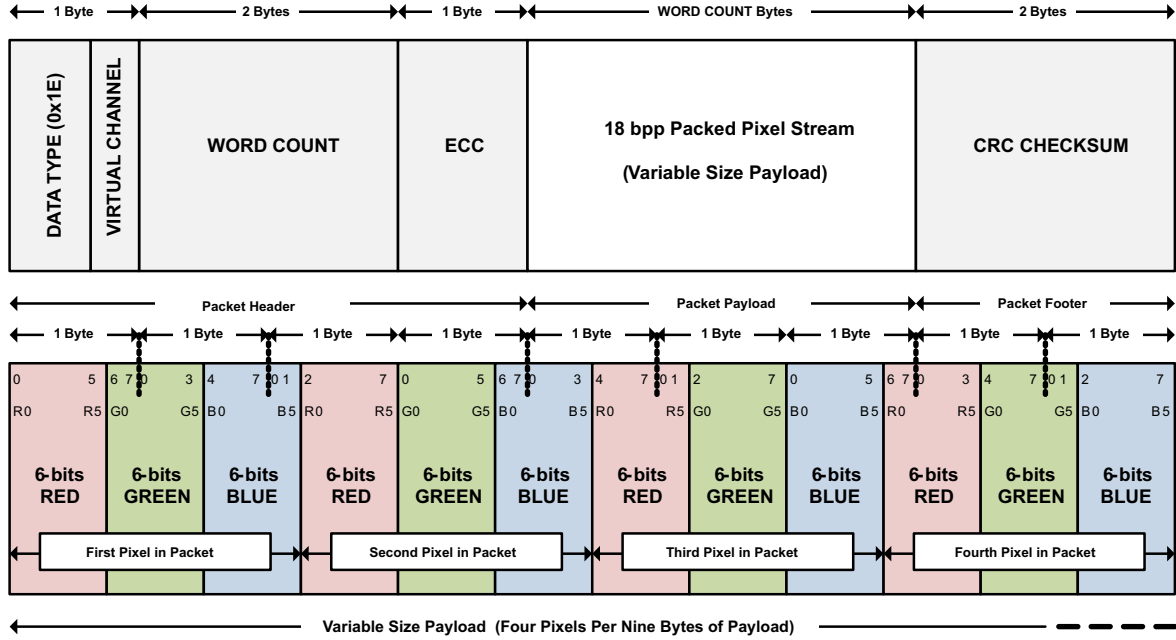

Figure 15. 18-bpp (Tightly Packed) DSI Packet Structure

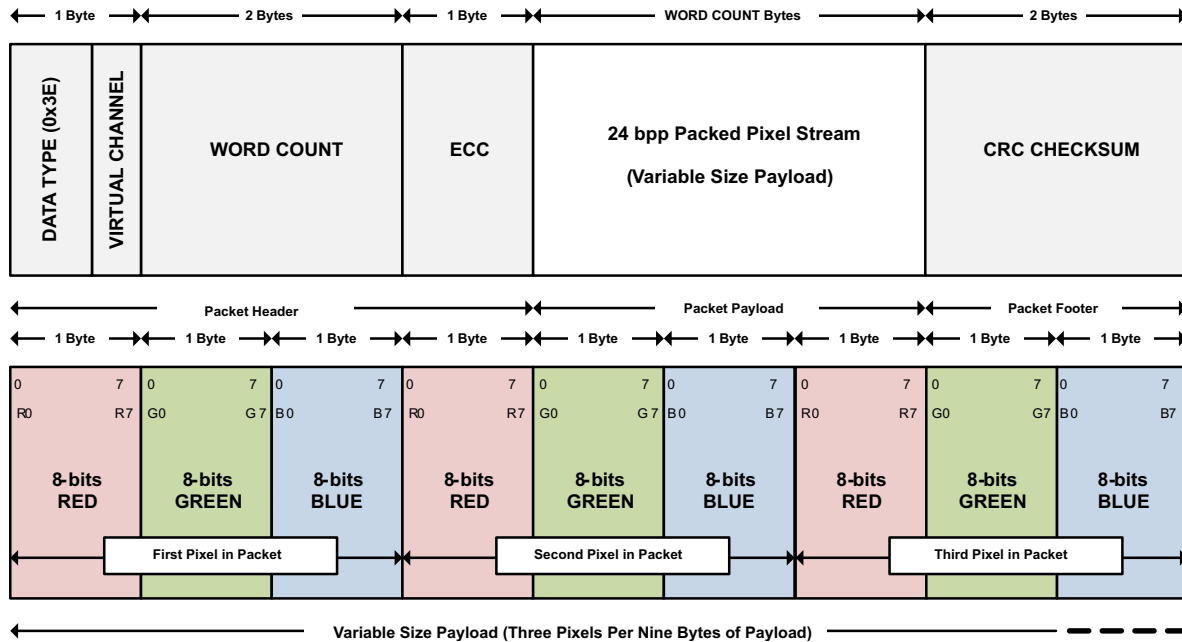

Figure 16. 24-bpp DSI Packet Structure

### 8.3.9 DSI Video Transmission Specifications

The SN65DSI83-Q1 supports burst video mode and non-burst video mode with sync events or with sync pulses packet transmission as described in the DSI specification. The burst mode supports time-compressed pixel stream packets that leave added time per scan line for power savings LP mode. The SN65DSI83-Q1 requires a transition to LP mode once per frame to enable PHY synchronization with the DSI host processor; however, for a robust and low-power implementation, the transition to LP mode is recommended on every video line.

Figure 17 shows the DSI video transmission applied to SN65DSI83-Q1 applications. In all applications, the LVDS output rate must be less than or equal to the DSI input rate. The first line of a video frame shall start with a VSS packet, and all other lines start with VSE or HSS. The position of the synchronization packets in time is of utmost importance since this has a direct impact on the visual performance of the display panel; that is, these packets generate the HS and VS (horizontal and vertical sync) signals on the LVDS interface after the delay programmed into CHA\_SYNC\_DELAY\_LOW/HIGH (CSR 0x28.7:0 and 0x29.3:0).

As required in the DSI specification, the SN65DSI83-Q1 requires that pixel stream packets contain an integer number of pixels (i.e. end on a pixel boundary); it is recommended to transmit an entire scan line on one pixel stream packet. When a scan line is broken in to multiple packets, inter-packet latency shall be considered such that the video pipeline (ie. pixel queue or partial line buffer) does not run empty (i.e. under-run); during scan line processing, if the pixel queue runs empty, the SNDSI83-Q1 transmits zero data (18'b0 or 24'b0) on the LVDS interface.

**NOTE**

When the HS clock is used as a source for the LVDS pixel clock, the LP mode transitions apply only to the data lanes, and the DSI clock lane remains in the HS mode during the entire video transmission.

The SN65DSI83-Q1 does not support the DSI Virtual Channel capability or reverse direction (peripheral to processor) transmissions.

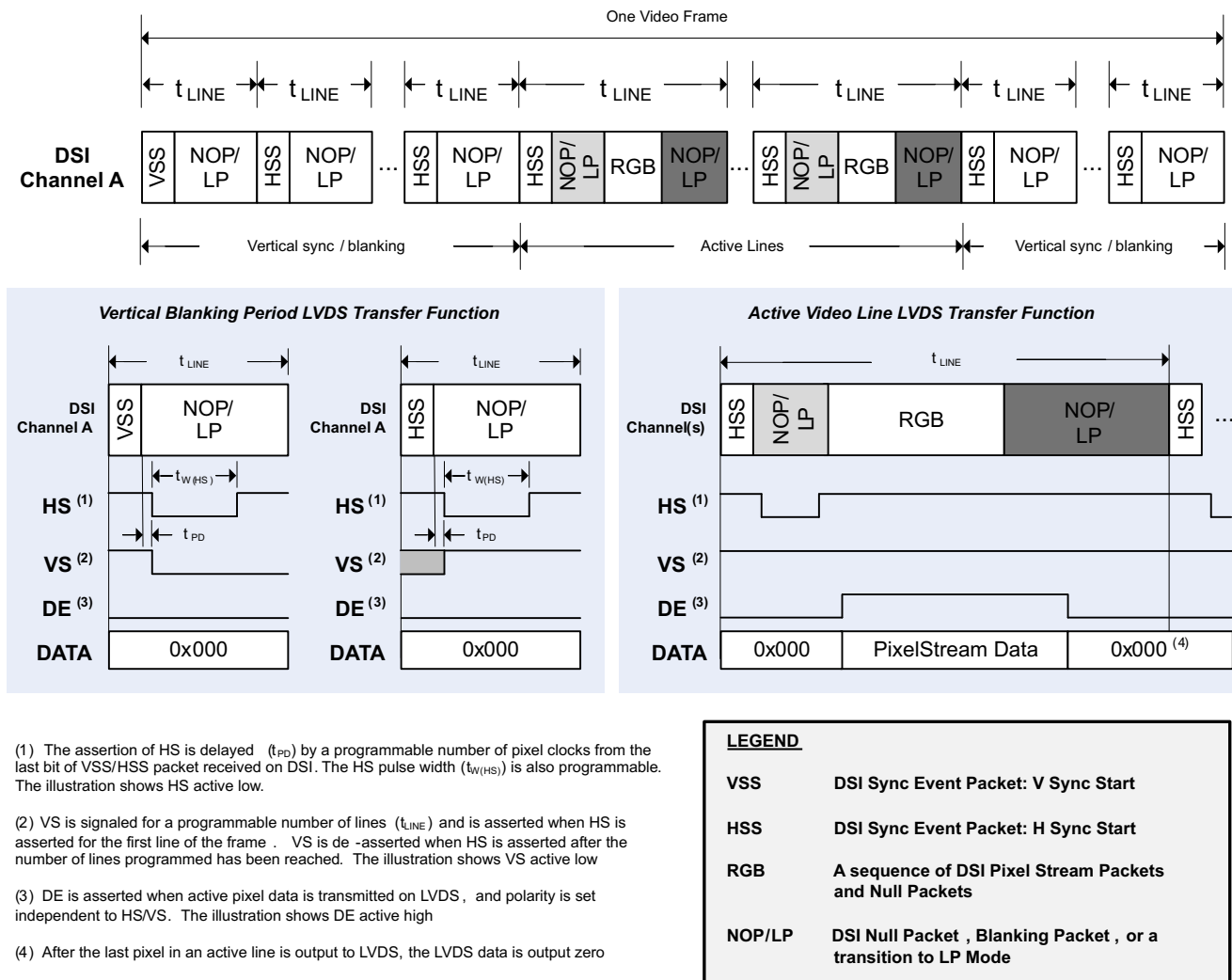

Figure 17. DSI Channel Transmission and Transfer Function

## 8.4 Programming

### 8.4.1 Local I<sup>2</sup>C Interface Overview

The SN65DSI83-Q1 device local I<sup>2</sup>C interface is enabled when EN is input high, access to the CSR registers is supported during ULPS. The SCL and SDA pins are used for I<sup>2</sup>C clock and I<sup>2</sup>C data respectively. The SN65DSI83-Q1 device I<sup>2</sup>C interface conforms to the 2-wire serial interface defined by the I<sup>2</sup>C Bus Specification, Version 2.1 (January 2000) and supports fast mode transfers up to 400 kbps.

The device address byte is the first byte received following the start condition from the master device. The 7-bit device address for SN65DSI83-Q1 device is factory preset to 010110X with the least significant bit being determined by the ADDR control input. Table 3 clarifies the SN65DSI83-Q1 device target address.

Table 3. SN65DSI83-Q1 I<sup>2</sup>C Target Address Description (1)(2)

BIT 7 (MSB)	BIT 6	BIT 5	BIT 4	BIT 3	BIT 2	BIT 1	BIT 0 (W/R)
0	1	0	1	1	0	ADDR	0/1

(1) When ADDR = 1, Address cycle is 0x5A (write) and 0x5B (read)

(2) When ADDR = 0, Address cycle is 0x58 (write) and 0x59 (read)

The following procedure is followed to write to the SN65DSI83-Q1 device I<sup>2</sup>C registers:

1. The master initiates a write operation by generating a start condition (S), followed by the SN65DSI83-Q1 device 7-bit address and a zero-value W/R bit to indicate a write cycle.
2. The SN65DSI83-Q1 device acknowledges the address cycle.
3. The master presents the subaddress (I<sup>2</sup>C register within SN65DSI83-Q1 device) to be written, consisting of one byte of data, MSB-first.
4. The SN65DSI83-Q1 device acknowledges the subaddress cycle.
5. The master presents the first byte of data to be written to the I<sup>2</sup>C register.
6. The SN65DSI83-Q1 device acknowledges the byte transfer.
7. The master may continue presenting additional bytes of data to be written, with each byte transfer completing with an acknowledge from the SN65DSI83-Q1 device.
8. The master terminates the write operation by generating a stop condition (P).

The following procedure is followed to read the SN65DSI83-Q1 I<sup>2</sup>C registers:

1. The master initiates a read operation by generating a start condition (S), followed by the SN65DSI83-Q1 device 7-bit address and a one-value W/R bit to indicate a read cycle.
2. The SN65DSI83-Q1 device acknowledges the address cycle.
3. The SN65DSI83-Q1 device transmits the contents of the memory registers MSB-first starting at register 00h. If a write to the SN65DSI83-Q1 I<sup>2</sup>C register occurred prior to the read, then the SN65DSI83-Q1 device starts at the subaddress specified in the write.
4. The SN65DSI83-Q1 device waits for either an acknowledge (ACK) or a not-acknowledge (NACK) from the master after each byte transfer; the I<sup>2</sup>C master acknowledges reception of each data byte transfer.
5. If an ACK is received, the SN65DSI83-Q1 device transmits the next byte of data.
6. The master terminates the read operation by generating a stop condition (P).

The following procedure is followed for setting a starting subaddress for I<sup>2</sup>C reads:

1. The master initiates a write operation by generating a start condition (S), followed by the SN65DSI83-Q1 device 7-bit address and a zero-value W/R bit to indicate a write cycle.
2. The SN65DSI83-Q1 device acknowledges the address cycle.
3. The master presents the subaddress (I<sup>2</sup>C register within the SN65DSI83-Q1 device) to be written, consisting of one byte of data, MSB first.
4. The SN65DSI83-Q1 device acknowledges the subaddress cycle.
5. The master terminates the write operation by generating a stop condition (P).

## 8.5 Register Maps

### 8.5.1 Control and Status Registers Overview

Many of the SN65DSI83-Q1 functions are controlled by the Control and Status Registers (CSR). All CSR registers are accessible through the local I<sup>2</sup>C interface.

See the following tables for the SN65DSI83-Q1 CSR descriptions. Reserved or undefined bit fields should not be modified. Otherwise, the device may operate incorrectly.

#### 8.5.1.1 CSR Bit Field Definitions – ID Registers

##### 8.5.1.1.1 Registers 0x00 – 0x08

**Figure 18. Registers 0x00 – 0x08**

7	6	5	4	3	2	1	0
Reserved							
R							

LEGEND: R/W = Read/Write; R = Read only; -n = value after reset

**Table 4. Registers 0x00 – 0x08 Field Descriptions**

Bit	Field	Type	Reset	Description
7-0	Reserved	R		Reserved Addresses 0x08 - 0x00 = {0x01, 0x20, 0x20, 0x20, 0x44, 0x53, 0x49, 0x38, 0x35}

#### 8.5.1.2 CSR Bit Field Definitions – Reset and Clock Registers

##### 8.5.1.2.1 Register 0x09

**Figure 19. Register 0x09**

7	6	5	4	3	2	1	0
Reserved							SOFT_RESET
R							W

LEGEND: R/W = Read/Write; R = Read only; -n = value after reset

**Table 5. Register 0x09 Field Descriptions**

Bit	Field	Type	Reset	Description
7-1	Reserved	R		Reserved
0	SOFT_RESET	W	0	This bit automatically clears when set to '1' and returns zeros when read. This bit must be set after the CSR's are updated. This bit must also be set after making any changes to the DIS clock rate or after changing between DSI burst and non-burst modes. 0 – No action (default) 1 – Reset device to default condition excluding the CSR bits.

**8.5.1.2.2 Register 0x0A**
**Figure 20. Register 0x0A**

7	6	5	4	3	2	1	0
PLL_EN_STAT	Reserved			LVDS_CLK_RANGE			HS_CLK_SRC
R	R			R/W			R/W

LEGEND: R/W = Read/Write; R = Read only; -n = value after reset

**Table 6. Register 0x0A Field Descriptions**

Bit	Field	Type	Reset	Description
7	PLL_EN_STAT	R	0	0 – PLL not enabled (default) 1 – PLL enabled Note: After PLL_EN_STAT = 1, wait at least 3ms for PLL to lock.
6-4	Reserved	R		
3-1	LVDS_CLK_RANGE	R/W	101	This field selects the frequency range of the LVDS output clock. 000 – 25 MHz ≤ LVDS_CLK < 37.5 MHz 001 – 37.5 MHz ≤ LVDS_CLK < 62.5 MHz 010 – 62.5 MHz ≤ LVDS_CLK < 87.5 MHz 011 – 87.5 MHz ≤ LVDS_CLK < 112.5 MHz 100 – 112.5 MHz ≤ LVDS_CLK < 137.5 MHz 101 – 137.5 MHz ≤ LVDS_CLK ≤ 154 MHz (default) 110 – Reserved 111 – Reserved
0	HS_CLK_SRC	R/W	0	0 – LVDS pixel clock derived from input REFCLK (default) 1 – LVDS pixel clock derived from MIPI D-PHY channel A HS continuous clock

**8.5.1.2.3 Register 0x0B**
**Figure 21. Register 0x0B**

7	6	5	4	3	2	1	0
DSI_CLK_DIVIDER					Reserved	REFCLK_MULTIPLIER	
R/W					R	R/W	

LEGEND: R/W = Read/Write; R = Read only; -n = value after reset

**Table 7. Register 0x0B Field Descriptions**

Bit	Field	Type	Reset	Description
7-3	DSI_CLK_DIVIDER	R/W	00000	When CSR 0x0A.0 = '1', this field controls the divider used to generate the LVDS output clock from the MIPI D-PHY Channel A HS continuous clock. When CSR 0x0A.0 = '0', this field must be programmed to 00000. 00000 – LVDS clock = source clock (default) 00001 – Divide by 2 00010 – Divide by 3 00011 – Divide by 4 • • • 10111 – Divide by 24 11000 – Divide by 25 11001 through 11111 – Reserved
2	Reserved	R		
1-0	REFCLK_MULTIPLIER	R/W	00	When CSR 0x0A.0 = '0', this field controls the multiplier used to generate the LVDS output clock from the input REFCLK. When CSR 0x0A.0 = '1', this field must be programmed to 00. 00 – LVDS clock = source clock (default) 01 – Multiply by 2 10 – Multiply by 3 11 – Multiply by 4



**8.5.1.2.4 Register 0x0D**
**Figure 22. Register 0x0D**

7	6	5	4	3	2	1	0
Reserved							PLL_EN
R							R/W

LEGEND: R/W = Read/Write; R = Read only; -n = value after reset

**Table 8. Register 0x0D Field Descriptions**

Bit	Field	Type	Reset	Description
7-1	Reserved	R		Reserved
0	PLL_EN	R/W	0	When this bit is set, the PLL is enabled with the settings programmed into CSR 0x0A and CSR 0x0B. The PLL should be disabled before changing any of the settings in CSR 0x0A and CSR 0x0B. The input clock source must be active and stable before the PLL is enabled. 0 – PLL disabled (default) 1 – PLL enabled

**8.5.1.3 CSR Bit Field Definitions – DSI Registers**
**8.5.1.3.1 Register 0x10**
**Figure 23. Register 0x10**

7	6	5	4	3	2	1	0
Reserved			CHA_DSI_LANES		Reserved		SOT_ERR_TO L_DIS
R			R/W		R		

LEGEND: R/W = Read/Write; R = Read only; -n = value after reset

**Table 9. Register 0x10 Field Descriptions**

Bit	Field	Type	Reset	Description
7-5	Reserved	R		Reserved
4-3	CHA_DSI_LANES	R/W	11	This field controls the number of lanes that are enabled for DSI Channel A. 00 – Four lanes are enabled 01 – Three lanes are enabled 10 – Two lanes are enabled 11 – One lane is enabled (default) Note: Unused DSI input pins on the SN65DSI83-Q1 should be left unconnected.
2-1	Reserved	R		Reserved
0	SOT_ERR_TOL_DIS	R/W	0	0 – Single bit errors are tolerated for the start of transaction SoT leader sequence (default) 1 – No SoT bit errors are tolerated

8.5.1.3.2 Register 0x11

Figure 24. Register 0x11

7	6	5	4	3	2	1	0
CHA_DSI_DATA_EQ		Reserved		CHA_DSI_CLK_EQ		Reserved	
R/W		R		R/W		R	

LEGEND: R/W = Read/Write; R = Read only; -n = value after reset

Table 10. Register 0x11 Field Descriptions

Bit	Field	Type	Reset	Description
7-6	CHA_DSI_DATA_EQ	R/W	00	This field controls the equalization for the DSI Channel A Data Lanes 00 – No equalization (default) 01 – 1 dB equalization 10 – Reserved 11 – 2 dB equalization
5-4	Reserved	R		Reserved
3-2	CHA_DSI_CLK_EQ	R/W	00	This field controls the equalization for the DSI Channel A Clock 00 – No equalization (default) 01 – 1 dB equalization 10 – Reserved 11 – 2 dB equalization
1-0	Reserved	R		Reserved

8.5.1.3.3 Register 0x12

Figure 25. Register 0x12

7	6	5	4	3	2	1	0
CHA_DSI_CLK_RANGE							
R/W							

LEGEND: R/W = Read/Write; R = Read only; -n = value after reset

Table 11. Register 0x12 Field Descriptions

Bit	Field	Type	Reset	Description
7-0	CHA_DSI_CLK_RANGE	R/W	0	This field specifies the DSI Clock frequency range in 5 MHz increments for the DSI Channel A Clock 0x00 through 0x07 – Reserved 0x08 – 40 ≤ frequency < 45 MHz 0x09 – 45 ≤ frequency < 50 MHz ... 0x63 – 495 ≤ frequency < 500 MHz 0x64 – 500 MHz 0x65 through 0xFF – Reserved

### 8.5.1.4 CSR Bit Field Definitions – LVDS Registers

#### 8.5.1.4.1 Register 0x18

**Figure 26. Register 0x18**

7	6	5	4	3	2	1	0
DE_NEG_POLARITY	HS_NEG_POLARITY	VS_NEG_POLARITY	Reserved	CHA_24BPP_MODE	Reserved	CHA_24BPP_FORMAT1	Reserved
R/W	R/W	R/W	R	R/W	R	R/W	R

LEGEND: R/W = Read/Write; R = Read only; -n = value after reset

**Table 12. Register 0x18 Field Descriptions**

Bit	Field	Type	Reset	Description
7	DE_NEG_POLARITY	R/W	0	0 – DE is positive polarity driven '1' during active pixel transmission on LVDS (default) 1 – DE is negative polarity driven '0' during active pixel transmission on LVDS
6	HS_NEG_POLARITY	R/W	1	0 – HS is positive polarity driven '1' during corresponding sync conditions 1 – HS is negative polarity driven '0' during corresponding sync (default)
5	VS_NEG_POLARITY	R/W	1	0 – VS is positive polarity driven '1' during corresponding sync conditions 1 – VS is negative polarity driven '0' during corresponding sync (default)
4	Reserved	R		Reserved. Do not write to this field. Must remain at default.
3	CHA_24BPP_MODE	R/W	0	0 – Force 18bpp; LVDS channel A lane 4 (A_Y3P/N) is disabled (default) 1 – Force 24bpp; LVDS channel A lane 4 (B_Y3P/N) is enabled
2	Reserved	R		Reserved. Do not write to this field. Must remain at default.
1	CHA_24BPP_FORMAT1	R/W	0	This field selects the 24bpp data format 0 – LVDS channel A lane A_Y3P/N transmits the 2 most significant bits (MSB) per color; Format 2 (default) 1 – LVDS channel B lane A_Y3P/N transmits the 2 least significant bits (LSB) per color; Format 1 Note1: This field must be '0' when 18bpp data is received from DSI. Note2: If this field is set to '1' and CHA_24BPP_MODE is '0', the SN65DSI83-Q1 will convert 24bpp data to 18bpp data for transmission to an 18bpp panel. In this configuration, the SN65DSI83-Q1 will not transmit the 2 LSB per color on LVDS channel A, because LVDS channel A lane A_Y3P/N is disabled.
0	Reserved	R		Reserved. Do not write to this field. Must remain at default.

#### 8.5.1.4.2 Register 0x19

**Figure 27. Register 0x19**

7	6	5	4	3	2	1	0
Reserved	CHA_LVDS_VOCM	Reserved	Reserved	CHA_LVDS_VOD_SWING	Reserved	Reserved	Reserved
R	R/W	R	R	R/W	R	R	R

LEGEND: R/W = Read/Write; R = Read only; -n = value after reset

**Table 13. Register 0x19 Field Descriptions**

Bit	Field	Type	Reset	Description
7	Reserved	R		Reserved. Do not write to this filed. Must remain at default.
6	CHA_LVDS_VOVM	R/W	0	This field controls the common mode output voltage for LVDS Channel A 0 – 1.2V (default) 1 – 0.9V (CSR 0x1B.5:4 CHA_LVDS_CM_ADJUST must be set to '01b')
5-4	Reserved	R		Reserved. Do not write to this filed. Must remain at default.
3-2	CHA_LVDS_VOD_SWING	R/W	01	This field controls the differential output voltage for LVDS Channel A. See the <a href="#">Electrical Characteristics table</a> for  V <sub>OD</sub>   for each setting: 00, 01 (default), 10, 11.
1-0	Reserved	R		Reserved. Do not write to this filed. Must remain at default.

**8.5.1.4.3 Register 0x1A**
**Figure 28. Register 0x1A**

7	6	5	4	3	2	1	0
Reserved		CHA_REVERSE_LVDS		Reserved		CHA_LVDS_TERM	Reserved
R		R/W		R		R/W	R

LEGEND: R/W = Read/Write; R = Read only; -n = value after reset

**Table 14. Register 0x1A Field Descriptions**

Bit	Field	Type	Reset	Description
7-6	Reserved	R		Reserved. Do not write to this filed. Must remain at default.
5	CHA_REVERSE_LVDS	R/W	0	This bit controls the order of the LVDS pins for Channel A. 0 – Normal LVDS Channel A pin order. LVDS Channel A pin order is the same as listed in the Terminal Assignments Section. (default) 1 – Reversed LVDS Channel A pin order. LVDS Channel A pin order is remapped as follows: <ul style="list-style-type: none"> <li>• A_Y0P → A_Y3P</li> <li>• A_Y0N → A_Y3N</li> <li>• A_Y1P → A_CLKP</li> <li>• A_Y1N → A_CLKN</li> <li>• A_Y2P → A_Y2P</li> <li>• A_Y2N → A_Y2N</li> <li>• A_CLKP → A_Y1P</li> <li>• A_CLKN → A_Y1N</li> <li>• A_Y3P → A_Y0P</li> <li>• A_Y3N → A_Y0N</li> </ul>
4-2	Reserved	R		Reserved. Do not write to this filed. Must remain at default.
1	CHA_LVDS_TERM	R/W	1	This bit controls the near end differential termination for LVDS Channel A. This bit also affects the output voltage for LVDS Channel A. 0 – 100Ω differential termination 1 – 200Ω differential termination (default)
0	Reserved	R		Reserved. Do not write to this filed. Must remain at default.

**8.5.1.4.4 Register 0x1B**
**Figure 29. Register 0x1B**

7	6	5	4	3	2	1	0
Reserved		CHA_LVDS_CM_ADJUST		Reserved			
R		R/W		R			

LEGEND: R/W = Read/Write; R = Read only; -n = value after reset

**Table 15. Register 0x1B Field Descriptions**

Bit	Field	Type	Reset	Description
7-6	Reserved	R		Reserved
5-4	CHA_LVDS_CM_ADJUST	R/W	00	This field can be used to adjust the common mode output voltage for LVDS Channel A. 00 – No change to common mode voltage (default) 01 – Adjust common mode voltage down 3% 10 – Adjust common mode voltage up 3% 11 – Adjust common mode voltage up 6%
3-0	Reserved	R		Reserved

Note for all video registers:

1. TEST PATTERN GENERATION PURPOSE ONLY registers are for test pattern generation use only. Others are for normal operation unless the test pattern generation feature is enabled.

**8.5.1.5 CSR Bit Field Definitions – Video Registers**
**8.5.1.5.1 Register 0x20**
**Figure 30. Register 0x20**

7	6	5	4	3	2	1	0
CHA_ACTIVE_LINE_LENGTH_LOW							
R/W							

LEGEND: R/W = Read/Write; R = Read only; -n = value after reset

**Table 16. Register 0x20 Field Descriptions**

Bit	Field	Type	Reset	Description
7-0	CHA_ACTIVE_LINE_LENGTH_LO W	R/W	0	This field controls the length in pixels of the active horizontal line line that are received on DSI Channel A and output to LVDS Channel A in single LVDS Channel mode(CSR 0x18.4=1), Channel A and B in dual LVDS Channel mode(CSR 0x18.4=0). The value in this field is the lower 8 bits of the 12-bit value for the horizontal line length.

**8.5.1.5.2 Register 0x21**
**Figure 31. Register 0x21**

7	6	5	4	3	2	1	0
Reserved				CHA_ACTIVE_LINE_LENGTH_HIGH			
R				R/W			

LEGEND: R/W = Read/Write; R = Read only; -n = value after reset

**Table 17. Register 0x21 Field Descriptions**

Bit	Field	Type	Reset	Description
7-4	Reserved	R		Reserved
3-0	CHA_ACTIVE_LINE_LENGTH_HIGH	R/W	0	This field controls the length in pixels of the active horizontal line that are received on DSI Channel A and output to LVDS Channel A in single LVDS Channel mode(CSR 0x18.4=1), Channel A and B in dual LVDS Channel mode(CSR 0x18.4=0). The value in this field is the upper 4 bits of the 12-bit value for the horizontal line length.

**8.5.1.5.3 Register 0x24**
**Figure 32. Register 0x24**

7	6	5	4	3	2	1	0
CHA_VERTICAL_DISPLAY_SIZE_LOW							
R/W							

LEGEND: R/W = Read/Write; R = Read only; -n = value after reset

**Table 18. Register 0x24 Field Descriptions**

Bit	Field	Type	Reset	Description
7-0	CHA_VERTICAL_DISPLAY_SIZE_LOW	R/W	0	TEST PATTERN GENERATION PURPOSE ONLY. This field controls the vertical display size in lines for LVDS Channel A in single LVDS Channel mode(CSR 0x18.4=1), Channel A and B in dual LVDS Channel mode(CSR 0x18.4=0). The value in this field is the lower 8 bits of the 12-bit value for the vertical display size.

**8.5.1.5.4 Register 0x25**
**Figure 33. Register 0x25**

7	6	5	4	3	2	1	0
Reserved				CHA_VERTICAL_DISPLAY_SIZE_HIGH			
R				R/W			

LEGEND: R/W = Read/Write; R = Read only; -n = value after reset

**Table 19. Register 0x25 Field Descriptions**

Bit	Field	Type	Reset	Description
7-4	Reserved	R		Reserved
3-0	CHA_VERTICAL_DISPLAY_SIZE_HIGH	R/W	0	TEST PATTERN GENERATION PURPOSE ONLY. This field controls the vertical display size in lines for LVDS Channel A in single LVDS Channel mode(CSR 0x18.4=1), Channel A and B in dual LVDS Channel mode(CSR 0x18.4=0). The value in this field is the upper 4 bits of the 12-bit value for the vertical display size.

**8.5.1.5.5 Register 0x28**

**Figure 34. Register 0x28**

7	6	5	4	3	2	1	0
CHA_SYNC_DELAY_LOW							
R/W							

LEGEND: R/W = Read/Write; R = Read only; -n = value after reset

**Table 20. Register 0x28 Field Descriptions**

Bit	Field	Type	Reset	Description
7-0	CHA_SYNC_DELAY_LOW	R/W	0	This field controls the delay in pixel clocks from when an HSync or VSync is received on the DSI to when it is transmitted on the LVDS interface for Channel A in single LVDS Channel mode(CSR 0x18.4=1), Channel A and B in dual LVDS Channel mode(CSR 0x18.4=0). The delay specified by this field is in addition to the pipeline and synchronization delays in the SN65DSI83-Q1. The additional delay is approximately 10 pixel clocks. The Sync delay must be programmed to at least 32 pixel clocks to ensure proper operation. The value in this field is the lower 8 bits of the 12-bit value for the Sync delay.

#### 8.5.1.5.6 Register 0x29

**Figure 35. Register 0x29**

7	6	5	4	3	2	1	0
Reserved				CHA_SYNC_DELAY_HIGH			
R				R/W			

LEGEND: R/W = Read/Write; R = Read only; -n = value after reset

**Table 21. Register 0x29 Field Descriptions**

Bit	Field	Type	Reset	Description
7-4	Reserved	R		Reserved
3-0	CHA_SYNC_DELAY_HIGH	R/W	0	This field controls the delay in pixel clocks from when an HSync or VSync is received on the DSI to when it is transmitted on the LVDS interface for Channel A in single LVDS Channel mode(CSR 0x18.4=1), Channel A and B in dual LVDS Channel mode(CSR 0x18.4=0). The delay specified by this field is in addition to the pipeline and synchronization delays in the SN65DSI83-Q1. The additional delay is approximately 10 pixel clocks. The Sync delay must be programmed to at least 32 pixel clocks to ensure proper operation. The value in this field is the upper 4 bits of the 12-bit value for the Sync delay.

#### 8.5.1.5.7 Register 0x2C

**Figure 36. Register 0x2C**

7	6	5	4	3	2	1	0
CHA_HSYNC_PULSE_WIDTH_LOW							
R/W							

LEGEND: R/W = Read/Write; R = Read only; -n = value after reset

**Table 22. Register 0x2C Field Descriptions**

Bit	Field	Type	Reset	Description
7-0	CHA_HSYNC_PULSE_WIDTH_LO W	R/W	0	This field controls the width in pixel clocks of the HSync Pulse Width for LVDS Channel A in single LVDS Channel mode(CSR 0x18.4=1), Channel A and B in dual LVDS Channel mode(CSR 0x18.4=0). The value in this field is the lower 8 bits of the 10-bit value for the HSync Pulse Width.

**8.5.1.5.8 Register 0x2D**
**Figure 37. Register 0x2D**

7	6	5	4	3	2	1	0
Reserved						CHA_HSYNC_PULSE_WIDTH_HIGH	
R						R/W	

LEGEND: R/W = Read/Write; R = Read only; -n = value after reset

**Table 23. Register 0x2D Field Descriptions**

Bit	Field	Type	Reset	Description
7-2	Reserved	R		Reserved
1-0	CHA_HSYNC_PULSE_WIDTH_HIGH	R/W	0	This field controls the width in pixel clocks of the HSync Pulse Width for LVDS Channel A in single LVDS Channel mode(CSR 0x18.4=1), Channel A and B in dual LVDS Channel mode(CSR 0x18.4=0). The value in this field is the upper 2 bits of the 10-bit value for the HSync Pulse Width.

**8.5.1.5.9 Register 0x30**
**Figure 38. Register 0x30**

7	6	5	4	3	2	1	0
CHA_VSYNC_PULSE_WIDTH_LOW							
R/W							

LEGEND: R/W = Read/Write; R = Read only; -n = value after reset

**Table 24. Register 0x30 Field Descriptions**

Bit	Field	Type	Reset	Description
7-0	CHA_VSYNC_PULSE_WIDTH_LOW	R/W	0	This field controls the length in lines of the VSync Pulse Width for LVDS Channel A in single LVDS Channel mode(CSR 0x18.4=1), Channel A and B in dual LVDS Channel mode(CSR 0x18.4=0). The value in this field is the lower 8 bits of the 10-bit value for the VSync Pulse Width.

**8.5.1.5.10 Register 0x31**
**Figure 39. Register 0x31**

7	6	5	4	3	2	1	0
Reserved						CHA_VSYNC_PULSE_WIDTH_HIGH	
R						R/W	

LEGEND: R/W = Read/Write; R = Read only; -n = value after reset

**Table 25. Register 0x31 Field Descriptions**

Bit	Field	Type	Reset	Description
7-2	Reserved	R		Reserved
1-0	CHA_VSYNC_PULSE_WIDTH_HIGH	R/W	0	This field controls the length in lines of the VSync Pulse Width for LVDS Channel A in single LVDS Channel mode(CSR 0x18.4=1), Channel A and B in dual LVDS Channel mode(CSR 0x18.4=0). The value in this field is the upper 2 bits of the 10-bit value for the VSync Pulse Width.

**8.5.1.5.11 Register 0x34**



**Figure 40. Register 0x34**

7	6	5	4	3	2	1	0
CHA_HORIZONTAL_BACK_PORCH							
R/W							

LEGEND: R/W = Read/Write; R = Read only; -n = value after reset

**Table 26. Register 0x34 Field Descriptions**

Bit	Field	Type	Reset	Description
7-0	CHA_HORIZONTAL_BACK_PORCH	R/W	0	This field controls the time in pixel clocks between the end of the HSync Pulse and the start of the active video data for LVDS Channel A in single LVDS Channel mode(CSR 0x18.4=1), Channel A and B in dual LVDS Channel mode(CSR 0x18.4=0).

**8.5.1.5.12 Register 0x36**
**Figure 41. Register 0x36**

7	6	5	4	3	2	1	0
CHA_VERTICAL_BACK_PORCH							
R/W							

LEGEND: R/W = Read/Write; R = Read only; -n = value after reset

**Table 27. Register 0x36 Field Descriptions**

Bit	Field	Type	Reset	Description
7-0	CHA_VERTICAL_BACK_PORCH	R/W	0	TEST PATTERN GENERATION PURPOSE ONLY. This field controls the number of lines between the end of the VSync Pulse and the start of the active video data for LVDS Channel A in single LVDS Channel mode(CSR 0x18.4=1), Channel A and B in dual LVDS Channel mode(CSR 0x18.4=0).

**8.5.1.5.13 Register 0x38**
**Figure 42. Register 0x38**

7	6	5	4	3	2	1	0
CHA_HORIZONTAL_FRONT_PORCH							
R/W							

LEGEND: R/W = Read/Write; R = Read only; -n = value after reset

**Table 28. Register 0x38 Field Descriptions**

Bit	Field	Type	Reset	Description
7-0	CHA_HORIZONTAL_FRONT_PORCH	R/W	0	TEST PATTERN GENERATION PURPOSE ONLY. This field controls the time in pixel clocks between the end of the active video data and the start of the HSync Pulse for LVDS Channel A in single LVDS Channel mode(CSR 0x18.4=1), Channel A and B in dual LVDS Channel mode(CSR 0x18.4=0).

**8.5.1.5.14 Register 0x3A**
**Figure 43. Register 0x3A**

7	6	5	4	3	2	1	0
CHA_VERTICAL_FRONT_PORCH							
R/W							

LEGEND: R/W = Read/Write; R = Read only; -n = value after reset

**Table 29. Register 0x3A Field Descriptions**

Bit	Field	Type	Reset	Description
7-0	CHA_VERTICAL_FRONT_PORCH	R/W	0	TEST PATTERN GENERATION PURPOSE ONLY. This field controls the number of lines between the end of the active video data and the start of the VSync Pulse for LVDS Channel A in single LVDS Channel mode(CSR 0x18.4=1), Channel A and B in dual LVDS Channel mode(CSR 0x18.4=0).

**8.5.1.5.15 Register 0x3C**
**Figure 44. Register 0x3C**

7	6	5	4	3	2	1	0
Reserved			CHA_TEST_P ATTERN	Reserved			
R			R/W	R			

LEGEND: R/W = Read/Write; R = Read only; -n = value after reset

**Table 30. Register 0x3C Field Descriptions**

Bit	Field	Type	Reset	Description
7-5	Reserved	R		Reserved
4	CHA_TEST_PATTERN	R/W	0	TEST PATTERN GENERATION PURPOSE ONLY. When this bit is set, the SN65DSI83-Q1 will generate a video test pattern based on the values programmed into the Video Registers for LDS Channel A in single LVDS Channel mode(CSR 0x18.4=1), Channel A and B in dual LVDS Channel mode(CSR 0x18.4=0).
3-0	Reserved	R		Reserved

**8.5.1.6 CSR Bit Field Definitions – IRQ Registers**
**8.5.1.6.1 Register 0xE0**
**Figure 45. Register 0xE0**

7	6	5	4	3	2	1	0
Reserved							IRQ_EN
R							R/W

LEGEND: R/W = Read/Write; R = Read only; -n = value after reset

**Table 31. Register 0xE0 Field Descriptions**

Bit	Field	Type	Reset	Description
7-1	Reserved	R		Reserved
0	IRQ_EN	R/W	0	When enabled by this field, the IRQ output is driven high to communicate IRQ events. 0 – IRQ output is high-impedance (default) 1 – IRQ output is driven high when a bit is set in registers 0xE5 that also has the corresponding IRQ_EN bit set to enable the interrupt condition

**8.5.1.6.2 Register 0xE1**
**Figure 46. Register 0xE1**

7	6	5	4	3	2	1	0
CHA_SYNC_ERR_EN	CHA_CRC_ERR_EN	CHA_UNC_EC_C_ERR_EN	CHA_COR_EC_C_ERR_EN	CHA_LLP_ERR_EN	CHA_SOT_BIT_ERR_EN	Reserved	PLL_UNLOCK_EN
R/W	R/W	R/W	R/W	R/W	R/W	R	R/W

LEGEND: R/W = Read/Write; R = Read only; -n = value after reset

**Table 32. Register 0xE1 Field Descriptions**

Bit	Field	Type	Reset	Description
7	CHA_SYNC_ERR_EN	R/W	0	0 – CHA_SYNC_ERR is masked 1 – CHA_SYNC_ERR is enabled to generate IRQ events
6	CHA_CRC_ERR_EN	R/W	0	0 – CHA_CRC_ERR is masked 1 – CHA_CRC_ERR is enabled to generate IRQ events
5	CHA_UNC_ECC_ERR_EN	R/W	0	0 – CHA_UNC_ECC_ERR is masked 1 – CHA_UNC_ECC_ERR is enabled to generate IRQ events
4	CHA_COR_ECC_ERR_EN	R/W	0	0 – CHA_COR_ECC_ERR is masked 1 – CHA_COR_ECC_ERR is enabled to generate IRQ events
3	CHA_LLP_ERR_EN	R/W	0	0 – CHA_LLP_ERR is masked 1 – CHA_LLP_ERR is enabled to generate IRQ events
2	CHA_SOT_BIT_ERR_EN	R/W	0	0 – CHA_SOT_BIT_ERR is masked 1 – CHA_SOT_BIT_ERR is enabled to generate IRQ events
1	Reserved	R		Reserved
0	PLL_UNLOCK_EN	R/W	0	0 – PLL_UNLOCK is masked 1 – PLL_UNLOCK is enabled to generate IRQ events

**8.5.1.6.3 Register 0xE5**
**Figure 47. Register 0xE5**

7	6	5	4	3	2	1	0
CHA_SYNCH_ERR	CHA_CRC_ERR	CHA_UNC_EC_C_ERR	CHA_COR_EC_C_ERR	CHA_LL_P_ERR	CHA_SOT_BIT_ERR	Reserved	PLL_UNLOCK
R/W	R/W	R/W	R/W	R/W	R/W	R	R/W

LEGEND: R/W = Read/Write; R = Read only; -n = value after reset

**Table 33. Register 0xE5 Field Descriptions**

Bit	Field	Type	Reset	Description
7	CHA_SYNCH_ERR	R/W	0	When the DSI channel A packet processor detects an HS or VS synchronization error, that is, an unexpected sync packet; this bit is set; this bit is cleared by writing a '1' value.
6	CHA_CRC_ERR	R/W	0	When the DSI channel A packet processor detects a data stream CRC error, this bit is set; this bit is cleared by writing a '1' value.
5	CHA_UNC_ECC_ERR	R/W	0	When the DSI channel A packet processor detects an uncorrectable ECC error, this bit is set; this bit is cleared by writing a '1' value.
4	CHA_COR_ECC_ERR	R/W	0	When the DSI channel A packet processor detects a correctable ECC error, this bit is set; this bit is cleared by writing a '1' value.
3	CHA_LL_P_ERR	R/W	0	When the DSI channel A packet processor detects a low level protocol error, this bit is set; this bit is cleared by writing a '1' value. Low level protocol errors include SoT and EoT sync errors, Escape Mode entry command errors, LP transmission sync errors, and false control errors. Lane merge errors are reported by this status condition.
2	CHA_SOT_BIT_ERR	R/W	0	When the DSI channel A packet processor detects an SoT leader sequence bit error, this bit is set; this bit is cleared by writing a '1' value.
1	Reserved	R		Reserved
0	PLL_UNLOCK	R/W	1	This bit is set whenever the PLL Lock status transitions from LOCK to UNLOCK.

## 9 Application and Implementation

---

### NOTE

Information in the following applications sections is not part of the TI component specification, and TI does not warrant its accuracy or completeness. TI's customers are responsible for determining suitability of components for their purposes. Customers should validate and test their design implementation to confirm system functionality.

---

### 9.1 Application Information

The SN65DSI83-Q1 device is primarily targeted for portable applications such as tablets and smart phones that utilize the MIPI DSI video format. The SN65DSI83-Q1 device can be used between a GPU with DSI output and a video panel with LVDS inputs.

#### 9.1.1 Video STOP and Restart Sequence

When the system requires to stop outputting video to the display, TI recommends to use the following sequence for the SN65DSI83-Q1 device:

1. Clear the PLL\_EN bit to 0 (CSR 0x0D.0).
2. Stop video streaming on DSI inputs.
3. Drive all DSI data lanes to LP11, but keep the DSI CLK lanes in HS.

When the system is ready to restart the video streaming.

1. Start video streaming on DSI inputs.
2. Set the PLL\_EN bit to 1 (CSR 0x0D.0).
3. Wait for minimum of 3 ms.
4. Set the SOFT\_RESET bit (0x09.0).

#### 9.1.2 Reverse LVDS Pin Order Option

For ease of PCB routing, the SN65DSI83-Q1 device supports reversing the pin order via configuration register programming. The order of the LVDS pin for LVDS channel A can be reversed by setting the address 0x1A bit 5 CHA\_REVERSE\_LVDS. See the corresponding register bit definition for details.

#### 9.1.3 IRQ Usage

The SN65DSI83-Q1 device provides an IRQ pin that can be used to indicate when certain errors occur on DSI. The IRQ output is enabled through the IRQ\_EN bit (CSR 0xE0.0). The IRQ pin is asserted when an error occurs on DSI, the corresponding error enable bit is set, and the IRQ\_EN bit is set. An error is cleared by writing a 1 to the corresponding error status bit.

---

### NOTE

If the SOFT\_RESET bit is set while the DSI video stream is active, some of the error status bits may be set.

---



---

### NOTE

If the DSI video stream is stopped, some of the error status bits may be set. These error status bits must be cleared before restarting the video stream.

---



---

### NOTE

If the DSI video stream starts before the device is configured, some of the error status bits may be set. TI recommends to start streaming after the device is correctly configured as recommended in the initialization sequence in the [Initialization Sequence](#) section.

---

## 9.2 Typical Application

Figure 48 shows a typical application using the SN65DSI83-Q1 device for a single channel DSI receiver to interface a single-channel DSI application processor to an LVDS single-link 18 bit-per-pixel panel supporting 1280 × 800 WXGA resolutions at 60 frames per second.

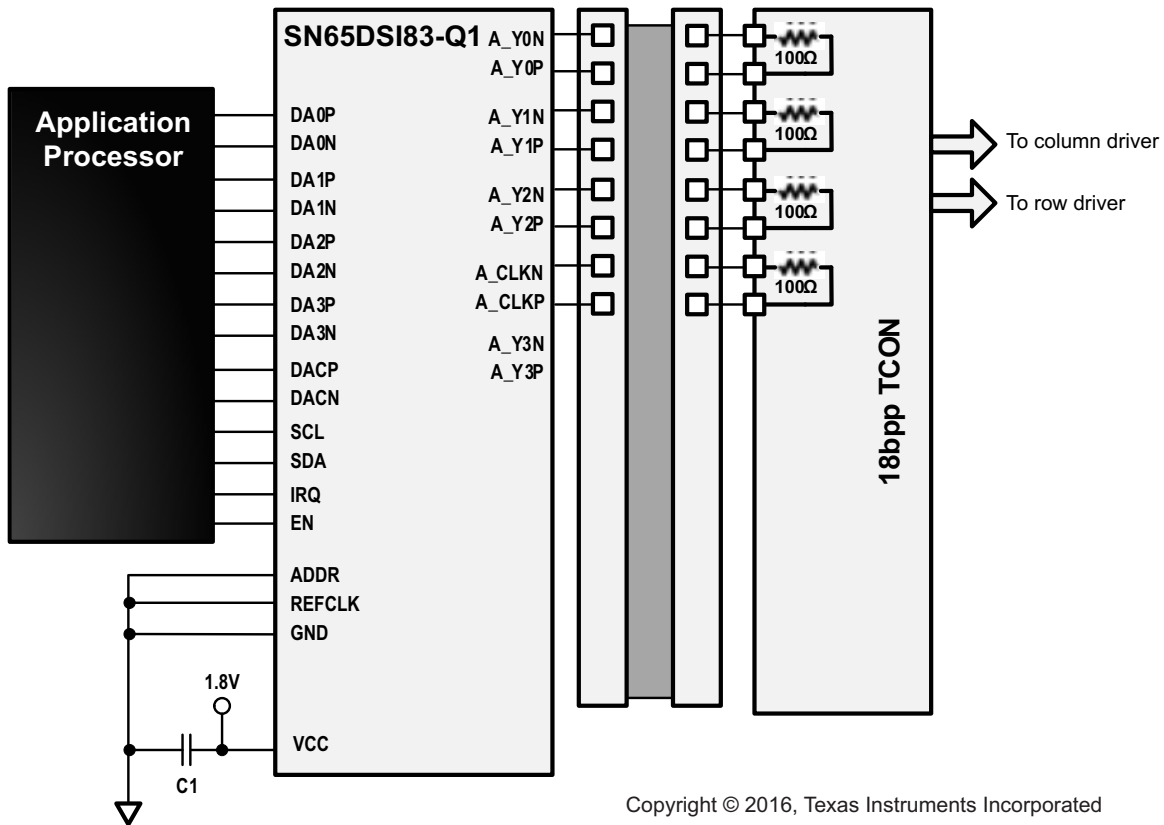

**Figure 48. Typical WXGA 18-bpp Panel Application**

### 9.2.1 Design Requirements

Table 34 shows the SN65DSI83-Q1 design parameters.

**Table 34. Design Parameters**

DESIGN PARAMETERS	EXAMPLE VALUE
VCC	1.8 V (±5%)
Clock source (REFCLK or DSIA_CLK)	DSIA_CLK
REFCKL frequency	N/A
DSIA clock frequency	500 MHz
<b>PANEL INFORMATION</b>	
Pixel clock (MHz)	83 MHz
Horizontal active (pixels)	1280
Horizontal blanking (pixels)	384
Vertical active (lines)	800
Vertical blanking (lines)	30
Horizontal sync offset (pixels)	64
Horizontal sync pulse width (pixels)	128
Vertical sync offset (lines)	3
Vertical sync pulse width (lines)	7

**Table 34. Design Parameters (continued)**

DESIGN PARAMETERS	EXAMPLE VALUE
<b>PANEL INFORMATION (continued)</b>	
Horizontal sync pulse polarity	Negative
Vertical sync pulse polarity	Negative
Color bit depth (6 bpc or 8 bpc)	6-bit
Number of LVDS lanes	1 × [3 Data Lanes + 1 Clock Lane]
<b>DSI INFORMATION</b>	
Number of DSI lanes	1 × [4 Data Lanes + 1 Clock Lane]
DSI clock frequency(MHz)	500 MHz
Dual DSI configuration(odd/even or left/right)	N/A

### 9.2.2 Detailed Design Procedure

The video resolution parameters required by the panel need to be programmed into the SN65DSI83-Q1 device. For this example, the parameters programmed are the following:

Horizontal Active = 1280 or 0x500

CHA\_ACTIVE\_LINE\_LENGTH\_LOW = 0x00

CHA\_ACTIVE\_LINE\_LENGTH\_HIGH = 0x05

Vertical Active = 800 or 0x320

CHA\_VERTICAL\_DISPLAY\_SIZE\_LOW = 0x20

CHA\_VERTICAL\_DISPLAY\_SIZE\_HIGH = 0x03

Horizontal Pulse Width = 128 or 0x80

CHA\_HSYNC\_PULSE\_WIDTH\_LOW = 0x80

CHA\_HSYNC\_PULSE\_WIDTH\_HIGH = 0x00

Vertical Pulse Width = 7

CHA\_VSYNC\_PULSE\_WIDTH\_LOW = 0x07

CHA\_VSYNC\_PULSE\_WIDTH\_HIGH = 0x00

Horizontal Backporch = HorizontalBlanking – (HorizontalSyncOffset + HorizontalSyncPulseWidth)

Horizontal Backporch = 384 – (64 + 128)

Horizontal Backporch = 192 or 0xC0

CHA\_HORIZONTAL\_BACK\_PORCH = 0xC0

Vertical Backporch = VerticalBlanking – (VerticalSyncOffset + VerticalSyncPulseWidth)

Vertical Backporch = 30 – (3 + 7)

Vertical Backporch = 20 or 0x14

CHA\_VERTICAL\_BACK\_PORCH = 0x14

**SN65DSI83-Q1**

ZHCSFS0A – DECEMBER 2016 – REVISED JUNE 2018

[www.ti.com.cn](http://www.ti.com.cn)

Horizontal Frontporch = HorizontalSyncOffset

Horizontal Frontporch = 64 or 0x40

CHA\_HORIZONTAL\_FRONT\_PORCH = 0x40

Vertical Frontporch = VerticalSyncOffset

Vertical Frontporch = 3

CHA\_VERTICAL\_FRONT\_PORCH = 0x03

The pattern generation feature can be enabled by setting the CHA\_TEST\_PATTERN bit at address 0x3C and configuring the TEST PATTERN GENERATION PURPOSE ONLY register as shown in [Table 30](#).

LVDS clock is derived from the DSI channel A clock. When the MIPI D-PHY channel A HS clock is used as the LVDS clock source, it is divided by the factor in DSI\_CLK\_DIVIDER (CSR 0x0B.7:3) to generate the LVDS output clock. Additionally, LVDS\_CLK\_RANGE (CSR 0x0A.3:1) and CH\_DSI\_CLK\_RANGE (CSR 0x12) must be set to the frequency range of the LVDS output clock and DSI Channel A input clock respectively for the internal PLL to operate correctly. After these settings are programmed, PLL\_EN (CSR 0x0D.0) must be set to enable the internal PLL.

LVDS\_CLK\_RANGE = 2 –  $62.5 \text{ MHz} \leq \text{LVDS\_CLK} < 87.5 \text{ MHz}$ 

HS\_CLK\_SRC = 1 – LVDS pixel clock derived from MIPI D-PHY channel A

DSI\_CLK\_DIVIDER = 00101 – Divide by 6

CHA\_DSI\_LANES = 00 – Four lanes are enabled

CHA\_DSI\_CLK\_RANGE = 0x64 – 500 MHz



### 9.2.2.1 Example Script

This example configures the SN65DSI83-Q1 device for the following configuration:

```

<aardvark>
<configure i2c="1" spi="1" gpio="0" tpower="1" pullups="1"/>
<i2c_bitrate khz="100"/>

=====SOFTRESET=====
<i2c_write addr="0x2D" count="1" radix="16">09 01</i2c_write> <sleep ms="10"/>

=====PLL_EN(bit 0) - Enable LAST after addr 0A and 0B configured=====
<i2c_write addr="0x2D" count="1" radix="16">0D 00</i2c_write> <sleep ms="10"/>

=====HS_CLK_SRC bit0===
=====LVDS_CLK_Range bit 3:1=====
<i2c_write addr="0x2D" count="1" radix="16"> 0A 05</i2c_write> <sleep ms="10"/>

=====DSI_CLK_DIVIDER bit7:3=====
=====RefCLK multiplier(bit1:0)=====
=====00 - LVDSclk=source clk, 01 - x2, 10 -x3, 11 - x4=====
<i2c_write addr="0x2D" count="1" radix="16">0B 28</i2c_write> <sleep ms="10"/>

=====DSI Ch Config Left_Right Pixels(bit7 - 0 for A ODD, B EVEN, 1 for the other config)=====
=====DSI Ch Mode(bit6:5) 00 - Dual, 01 - single, 10 - two single =====

=====SOT_ERR_TOL_DIS(bit0)=====
<i2c_write addr="0x2D" count="1" radix="16">10 26</i2c_write> <sleep ms="10"/>

====500M====
<i2c_write addr="0x2D" count="1" radix="16">12 64</i2c_write> <sleep ms="10"/>

=====bit7: DE_Pol, bit6:HS_Pol, bit5:VS_Pol, bit4: LVDS Link Cfg, bit3:CHA 24bpp, bit2: CHB 24bpp,
bit1: CHA 24bpp fmt1, bit0: CHB 24bpp fmt1=====
<i2c_write addr="0x2D" count="1" radix="16">18 72</i2c_write> <sleep ms="10"/>
<i2c_write addr="0x2D" count="1" radix="16">19 00</i2c_write> <sleep ms="10"/>

=====CHA_LINE_LENGTH_LOW=====
<i2c_write addr="0x2D" count="1" radix="16">20 00</i2c_write> <sleep ms="10"/>

=====CHA_LINE_LENGTH_HIGH=====
<i2c_write addr="0x2D" count="1" radix="16">21 05</i2c_write> <sleep ms="10"/>

=====CHA_VERTICAL_DISPLAY_SIZE_LOW=====
<i2c_write addr="0x2D" count="1" radix="16">24 00</i2c_write> <sleep ms="10"/>

=====CHA_VERTICAL_DISPLAY_SIZE_HIGH=====
<i2c_write addr="0x2D" count="1" radix="16">25 04</i2c_write> <sleep ms="10"/>

=====CHA_SYNC_DELAY_LOW=====
<i2c_write addr="0x2D" count="1" radix="16">28 20</i2c_write> <sleep ms="10"/>

=====CHA_SYNC_DELAY_HIGH=====
<i2c_write addr="0x2D" count="1" radix="16">29 01</i2c_write> <sleep ms="10"/>

=====CHA_HSYNC_PULSE_WIDTH_LOW=====
<i2c_write addr="0x2D" count="1" radix="16">2C 80</i2c_write> <sleep ms="10"/>

=====CHA_HSYNC_PULSE_WIDTH_HIGH=====
<i2c_write addr="0x2D" count="1" radix="16">2D 00</i2c_write> <sleep ms="10"/>

=====CHA_VSYNC_PULSE_WIDTH_LOW=====
<i2c_write addr="0x2D" count="1" radix="16">30 07</i2c_write> <sleep ms="10"/>

=====CHA_VSYNC_PULSE_WIDTH_HIGH=====
<i2c_write addr="0x2D" count="1" radix="16">31 00</i2c_write> <sleep ms="10"/>

=====CHA_HOR_BACK_PORCH=====
<i2c_write addr="0x2D" count="1" radix="16">34 C0</i2c_write> <sleep ms="10"/>

=====CHA_VER_BACK_PORCH=====
<i2c_write addr="0x2D" count="1" radix="16">36 00</i2c_write> <sleep ms="10"/>

=====CHA_HOR_FRONT_PORCH=====

```

```

<i2c_write addr="0x2D" count="1" radix="16">38 00</i2c_write> <sleep ms="10"/>

=====CHA_VER_FRONT_PORCH=====
<i2c_write addr="0x2D" count="1" radix="16">3A 00</i2c_write> <sleep ms="10"/>

=====CHA/CHB TEST PATTERN(bit4 CHA, bit0 CHB)=====
<i2c_write addr="0x2D" count="1" radix="16">3C 00</i2c_write> <sleep ms="10"/>

=====PLL_EN(bit 0) - Enable LAST after addr 0A and 0B configured=====
<i2c_write addr="0x2D" count="1" radix="16">0D 01</i2c_write> <sleep ms="10"/>

=====Read=====
<i2c_write addr="0x2D" count="1" radix="16">00</i2c_write> <sleep ms="10"/>

=====Read=====
<i2c_write addr="0x2D" count="256" radix="16">00</i2c_write> <sleep ms="10"/>

</aardvark>

```

### 9.2.3 Application Curve

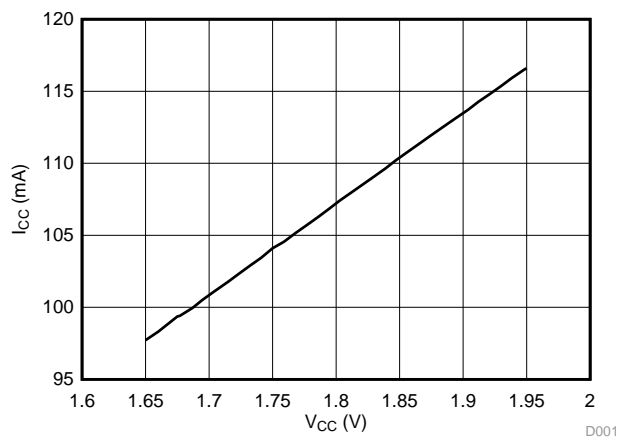

- B. SN65DSI83-Q1: SINGLE Channel DSI to SINGLE Channel DSI, 1280 x 800
- a. number of LVDS lanes = 3 data lanes + 1 CLK lane
  - b. number of DSI lanes = 4 data lanes + 1 CLK lane
  - c. LVDS CLK OUT = 83 M
  - d. DSI CLK = 500 M
  - e. RGB666, LVDS 18 bpp

**Figure 49. Power Consumption**

## 10 Power Supply Recommendations

### 10.1 V<sub>CC</sub> Power Supply

Each VCC power supply pin must have a 100-nF capacitor to ground connected as close as possible to the SN65DSI83-Q1 device. It is recommended to have one bulk capacitor (1  $\mu$ F to 10  $\mu$ F) on it. It is also recommended to have the pins connected to a solid power plane.

### 10.2 V<sub>CORE</sub> Power Supply

This pin must have a 100-nF capacitor to ground connected as close as possible to the SN65DSI83-Q1 device. It is recommended to have one bulk capacitor (1  $\mu$ F to 10  $\mu$ F) on it. It is also recommended to have the pins connected to a solid power plane.

## 11 Layout

### 11.1 Layout Guidelines

#### 11.1.1 Package Specific

For the PAP package, to minimize the power supply noise floor, provide good decoupling near the SN65DSI83-Q1 device power pins. The use of four ceramic capacitors (2  $\times$  0.1  $\mu$ F and 2  $\times$  0.01  $\mu$ F) provides good performance. At the least, TI recommends to install one 0.1- $\mu$ F and one 0.01- $\mu$ F capacitor near the SN65DSI83-Q1 device. To avoid large current loops and trace inductance, the trace length between decoupling capacitor and device power inputs pins must be minimized. Placing the capacitor underneath the SN65DSI83-Q1 device on the bottom of the PCB is often a good choice.

#### 11.1.2 Differential Pairs

- Differential pairs must be routed with controlled 100- $\Omega$  differential impedance ( $\pm$  20%) or 50- $\Omega$  single-ended impedance ( $\pm$ 15%).
- Keep away from other high speed signals
- Keep lengths to within 5 mils of each other.
- Length matching must be near the location of mismatch.
- Each pair must be separated at least by 3 times the signal trace width.
- The use of bends in differential traces must be kept to a minimum. When bends are used, the number of left and right bends must be as equal as possible and the angle of the bend must be  $\geq$  135 degrees. This arrangement minimizes any length mismatch caused by the bends and therefore minimizes the impact that bends have on EMI.
- Route all differential pairs on the same of layer.
- The number of vias must be kept to a minimum. It is recommended to keep the via count to 2 or less.
- Keep traces on layers adjacent to ground plane.
- Do NOT route differential pairs over any plane split.
- Adding Test points cause impedance discontinuity and therefore negatively impacts signal performance. If test points are used, they must be placed in series and symmetrically. They must not be placed in a manner that causes a stub on the differential pair.

#### 11.1.3 Ground

TI recommends that only one board ground plane be used in the design. This provides the best image plane for signal traces running above the plane. The thermal pad of the SN65DSI83-Q1 must be connected to this plane with vias.

SN65DSI83-Q1

ZHCSFS0A – DECEMBER 2016 – REVISED JUNE 2018

www.ti.com.cn

11.2 Layout Example

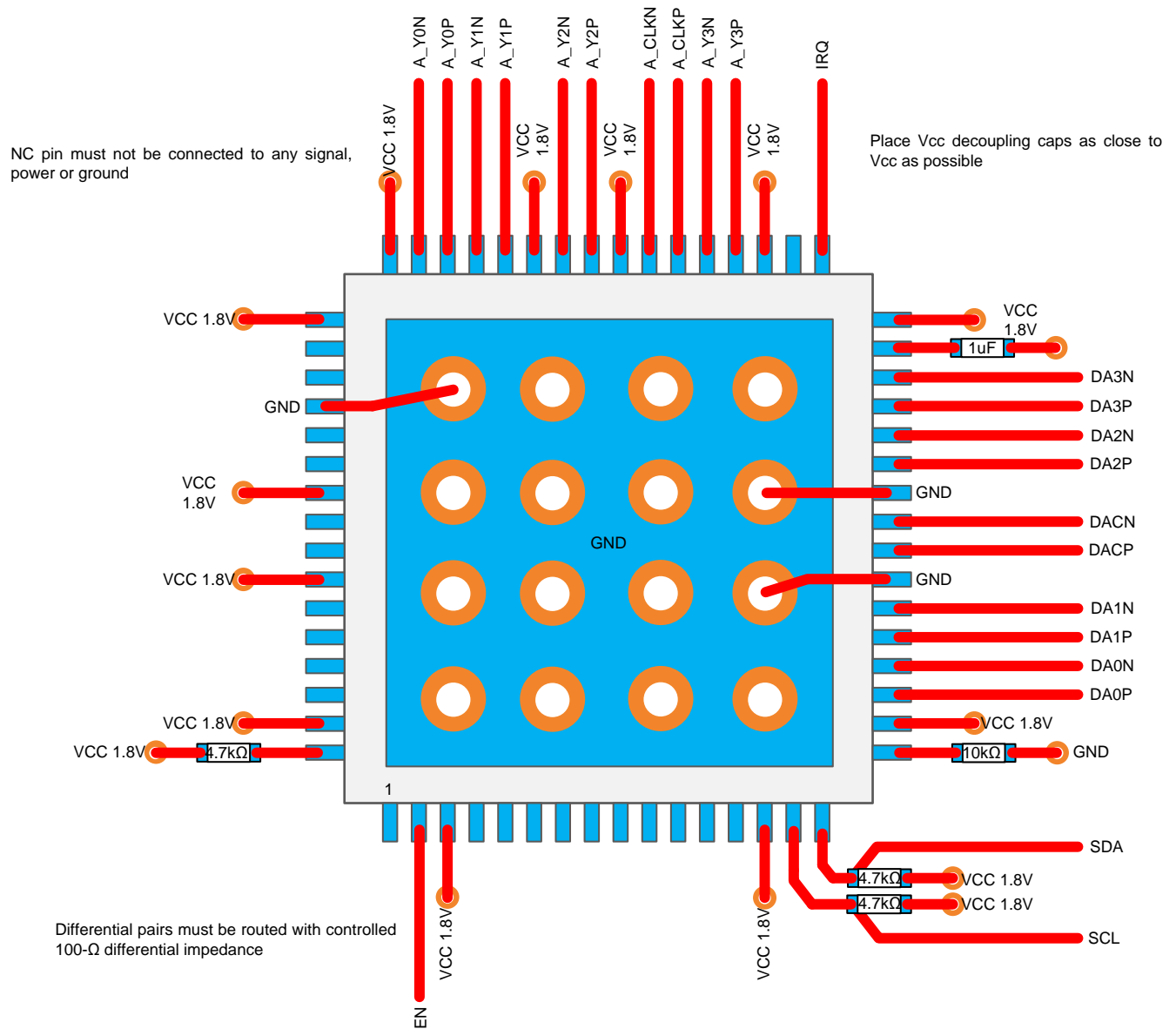

Copyright © 2016, Texas Instruments Incorporated

Figure 50. SN65DSI83-Q1 Layout Example

## 12 器件和文档支持

### 12.1 文档支持

#### 12.1.1 相关文档

请参阅如下相关文档：

- 《SN65DSI8x 视频配置指南和配置工具软件用户手册》
- 《SN65DSI83、SN65DSI84 和 SN65DSI85 硬件实现指南》

### 12.2 接收文档更新通知

要接收文档更新通知，请导航至 [ti.com.cn](http://ti.com.cn) 上的器件产品文件夹。单击右上角的通知我 进行注册，即可每周接收产品信息更改摘要。有关更改的详细信息，请查阅已修订文档中包含的修订历史记录。

### 12.3 社区资源

下列链接提供到 TI 社区资源的连接。链接的内容由各个分销商“按照原样”提供。这些内容并不构成 TI 技术规范，并且不一定反映 TI 的观点；请参阅 TI 的《使用条款》。

**TI E2E™ 在线社区** *TI 的工程师对工程师 (E2E) 社区*。此社区的创建目的在于促进工程师之间的协作。在 [e2e.ti.com](http://e2e.ti.com) 中，您可以咨询问题、分享知识、拓展思路并与同行工程师一道帮助解决问题。

**设计支持** *TI 参考设计支持* 可帮助您快速查找有帮助的 E2E 论坛、设计支持工具以及技术支持的联系信息。

### 12.4 商标

PowerPAD, E2E are trademarks of Texas Instruments.  
MIPI is a registered trademark of Arasan Chip Systems, Inc.  
All other trademarks are the property of their respective owners.

### 12.5 静电放电警告



这些装置包含有限的内置 ESD 保护。存储或装卸时，应将导线一起截短或将装置放置于导电泡棉中，以防止 MOS 门极遭受静电损伤。

### 12.6 术语表

**SLYZ022** — *TI 术语表*。

这份术语表列出并解释术语、缩写和定义。

### 13 机械、封装和可订购信息

以下页面包含机械、封装和可订购信息。这些信息是指定器件的最新可用数据。数据如有变更，恕不另行通知，且不会对此文档进行修订。如需获取此产品说明书的浏览器版本，请查阅左侧的导航栏。

**PACKAGING INFORMATION**

Orderable Device	Status (1)	Package Type	Package Drawing	Pins	Package Qty	Eco Plan (2)	Lead finish/ Ball material (6)	MSL Peak Temp (3)	Op Temp (°C)	Device Marking (4/5)	Samples
SN65DSI83TPAPRQ1	ACTIVE	HTQFP	PAP	64	1000	RoHS & Green	NIPDAU	Level-3-260C-168 HR	-40 to 105	DSI83TQ1	Samples

(1) The marketing status values are defined as follows:

**ACTIVE:** Product device recommended for new designs.

**LIFEBUY:** TI has announced that the device will be discontinued, and a lifetime-buy period is in effect.

**NRND:** Not recommended for new designs. Device is in production to support existing customers, but TI does not recommend using this part in a new design.

**PREVIEW:** Device has been announced but is not in production. Samples may or may not be available.

**OBSELETE:** TI has discontinued the production of the device.

(2) **RoHS:** TI defines "RoHS" to mean semiconductor products that are compliant with the current EU RoHS requirements for all 10 RoHS substances, including the requirement that RoHS substance do not exceed 0.1% by weight in homogeneous materials. Where designed to be soldered at high temperatures, "RoHS" products are suitable for use in specified lead-free processes. TI may reference these types of products as "Pb-Free".

**RoHS Exempt:** TI defines "RoHS Exempt" to mean products that contain lead but are compliant with EU RoHS pursuant to a specific EU RoHS exemption.

**Green:** TI defines "Green" to mean the content of Chlorine (Cl) and Bromine (Br) based flame retardants meet JS709B low halogen requirements of <=1000ppm threshold. Antimony trioxide based flame retardants must also meet the <=1000ppm threshold requirement.

(3) MSL, Peak Temp. - The Moisture Sensitivity Level rating according to the JEDEC industry standard classifications, and peak solder temperature.

(4) There may be additional marking, which relates to the logo, the lot trace code information, or the environmental category on the device.

(5) Multiple Device Markings will be inside parentheses. Only one Device Marking contained in parentheses and separated by a "-" will appear on a device. If a line is indented then it is a continuation of the previous line and the two combined represent the entire Device Marking for that device.

(6) Lead finish/Ball material - Orderable Devices may have multiple material finish options. Finish options are separated by a vertical ruled line. Lead finish/Ball material values may wrap to two lines if the finish value exceeds the maximum column width.

**Important Information and Disclaimer:**The information provided on this page represents TI's knowledge and belief as of the date that it is provided. TI bases its knowledge and belief on information provided by third parties, and makes no representation or warranty as to the accuracy of such information. Efforts are underway to better integrate information from third parties. TI has taken and continues to take reasonable steps to provide representative and accurate information but may not have conducted destructive testing or chemical analysis on incoming materials and chemicals. TI and TI suppliers consider certain information to be proprietary, and thus CAS numbers and other limited information may not be available for release.

In no event shall TI's liability arising out of such information exceed the total purchase price of the TI part(s) at issue in this document sold by TI to Customer on an annual basis.

**OTHER QUALIFIED VERSIONS OF SN65DSI83-Q1 :**

- Catalog : [SN65DS183](#)

NOTE: Qualified Version Definitions:

- Catalog - TI's standard catalog product



**TAPE AND REEL INFORMATION**

**QUADRANT ASSIGNMENTS FOR PIN 1 ORIENTATION IN TAPE**

\*All dimensions are nominal

Device	Package Type	Package Drawing	Pins	SPQ	Reel Diameter (mm)	Reel Width W1 (mm)	A0 (mm)	B0 (mm)	K0 (mm)	P1 (mm)	W (mm)	Pin1 Quadrant
SN65DSI83TPAPRQ1	HTQFP	PAP	64	1000	330.0	24.4	13.0	13.0	1.5	16.0	24.0	Q2

**TAPE AND REEL BOX DIMENSIONS**

\*All dimensions are nominal

Device	Package Type	Package Drawing	Pins	SPQ	Length (mm)	Width (mm)	Height (mm)
SN65DSI83TPAPRQ1	HTQFP	PAP	64	1000	367.0	367.0	55.0

## GENERIC PACKAGE VIEW

**PAP 64**

**HTQFP - 1.2 mm max height**

10 x 10, 0.5 mm pitch

QUAD FLATPACK

This image is a representation of the package family, actual package may vary.  
Refer to the product data sheet for package details.

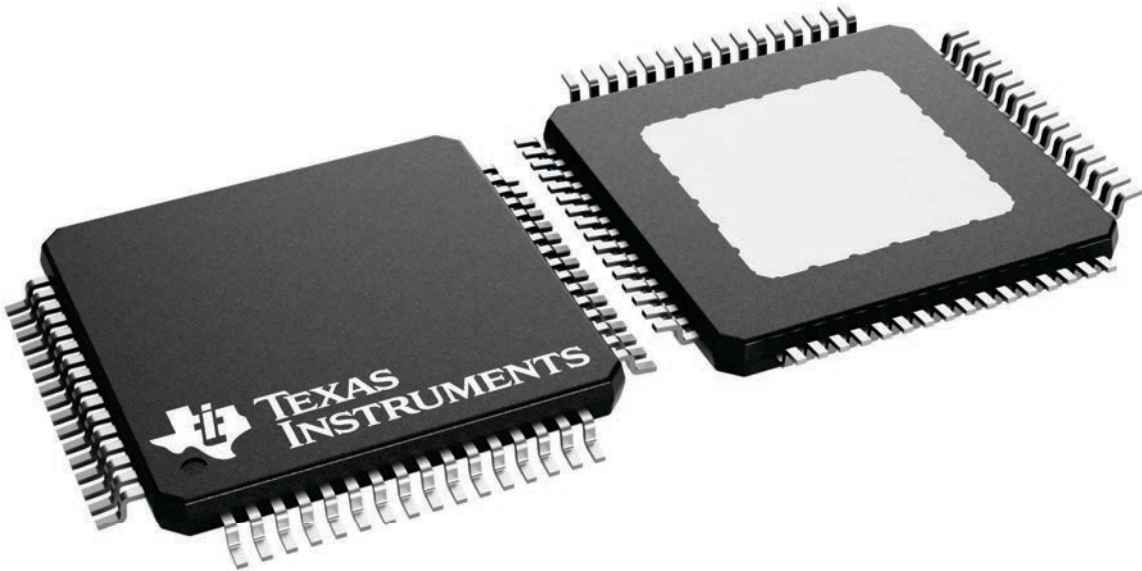

4226442/A

# PAP0064Q

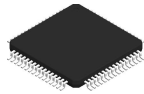

# PACKAGE OUTLINE

PowerPAD™ TQFP - 1.2 mm max height

PLASTIC QUAD FLATPACK

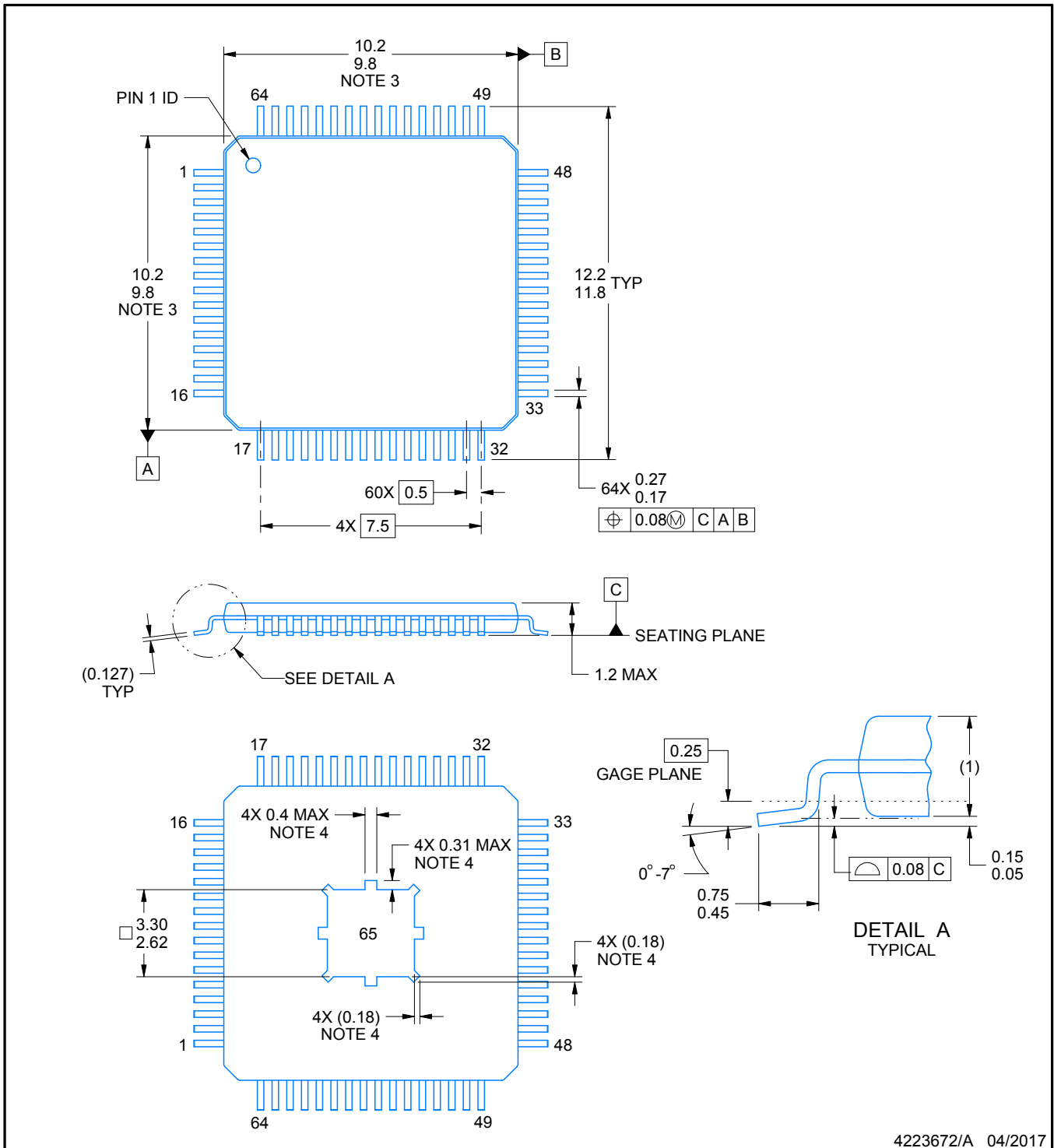

4223672/A 04/2017

**NOTES:**

PowerPAD is a trademark of Texas Instruments.

1. All linear dimensions are in millimeters. Any dimensions in parenthesis are for reference only. Dimensioning and tolerancing per ASME Y14.5M.
2. This drawing is subject to change without notice.
3. This dimension does not include mold flash, protrusions, or gate burrs.
4. Strap features may not be present.
5. Reference JEDEC registration MS-026.

# EXAMPLE BOARD LAYOUT

PAP0064Q

PowerPAD™ TQFP - 1.2 mm max height

PLASTIC QUAD FLATPACK

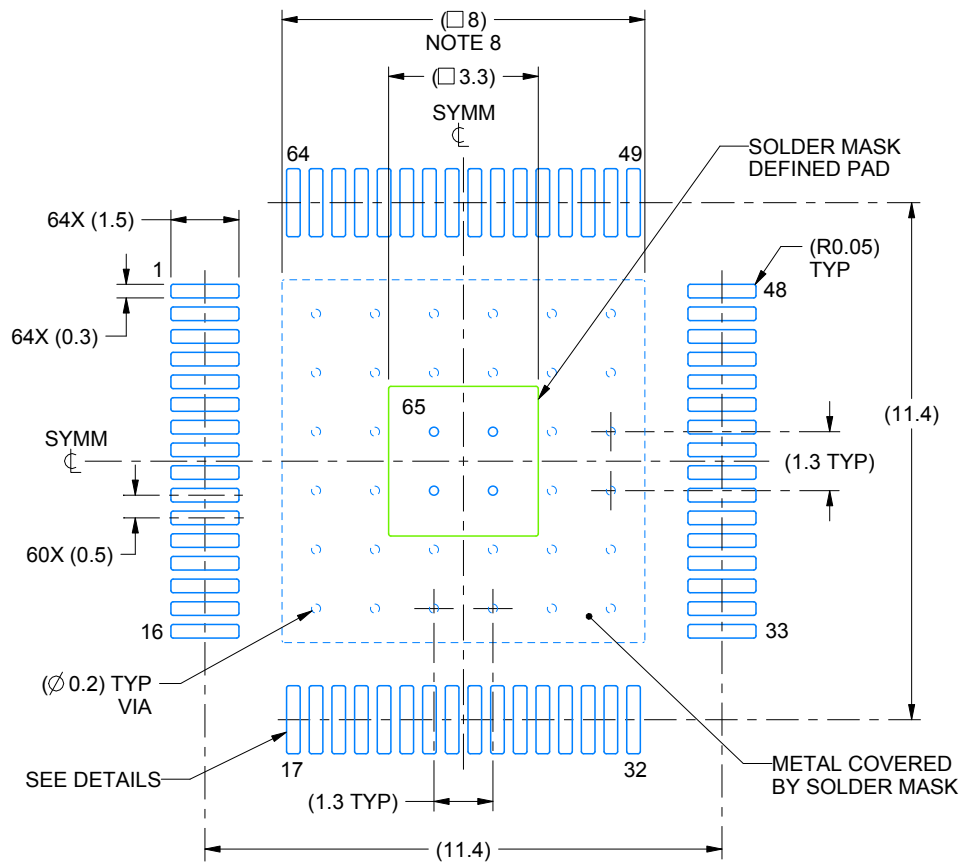

LAND PATTERN EXAMPLE  
EXPOSED METAL SHOWN  
SCALE:6X

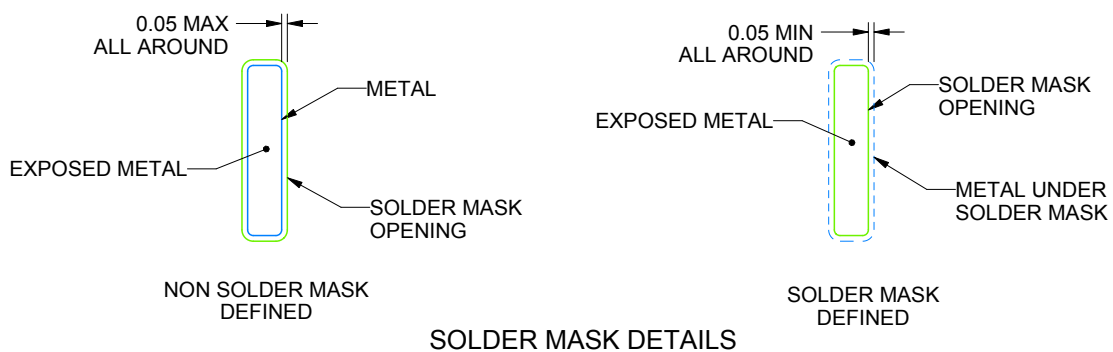

4223672/A 04/2017

NOTES: (continued)

6. Publication IPC-7351 may have alternate designs.
7. Solder mask tolerances between and around signal pads can vary based on board fabrication site.
8. This package is designed to be soldered to a thermal pad on the board. See technical brief, Powerpad thermally enhanced package, Texas Instruments Literature No. SLMA002 ([www.ti.com/lit/slma002](http://www.ti.com/lit/slma002)) and SLMA004 ([www.ti.com/lit/slma004](http://www.ti.com/lit/slma004)).
9. Vias are optional depending on application, refer to device data sheet. It is recommended that vias under paste be filled, plugged or tented.
10. Size of metal pad may vary due to creepage requirement.

# EXAMPLE STENCIL DESIGN

PAP0064Q

PowerPAD™ TQFP - 1.2 mm max height

PLASTIC QUAD FLATPACK

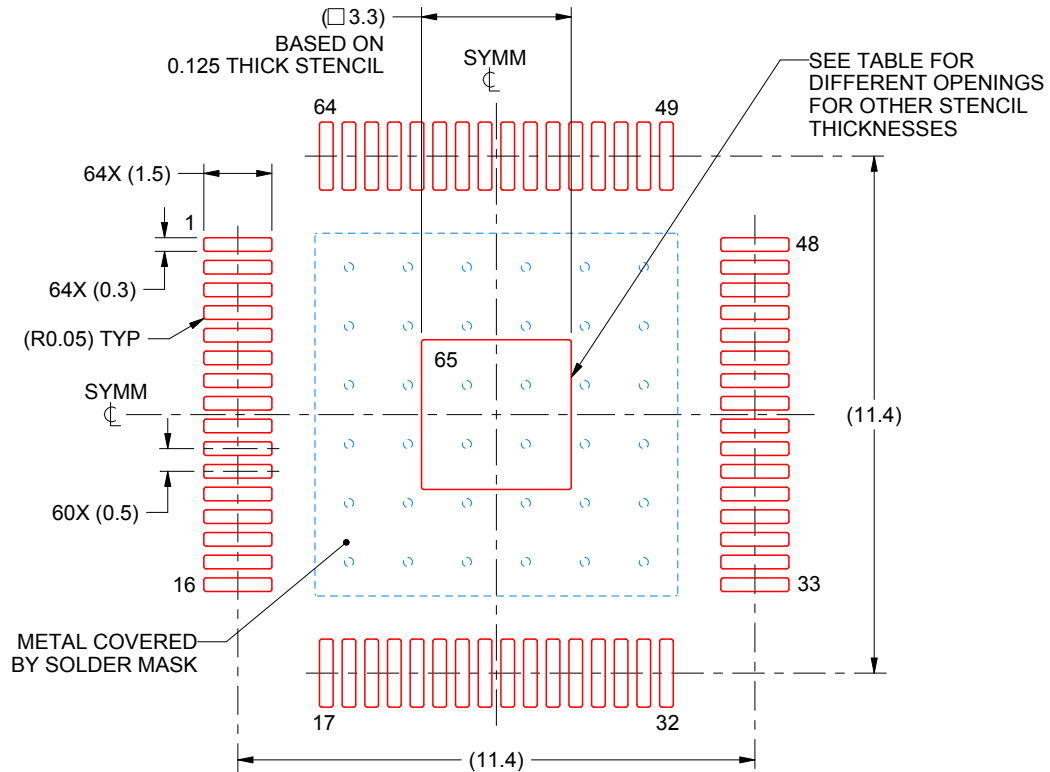

**SOLDER PASTE EXAMPLE**  
 EXPOSED PAD  
 100% PRINTED SOLDER COVERAGE BY AREA  
 SCALE:6X

STENCIL THICKNESS	SOLDER STENCIL OPENING
0.1	3.69 X 3.69
0.125	3.3 X 3.3 (SHOWN)
0.15	3.01 X 3.01
0.175	2.79 X 2.79

4223672/A 04/2017

NOTES: (continued)

11. Laser cutting apertures with trapezoidal walls and rounded corners may offer better paste release. IPC-7525 may have alternate design recommendations.
12. Board assembly site may have different recommendations for stencil design.

## 重要通知和免责声明

TI“按原样”提供技术和可靠性数据（包括数据表）、设计资源（包括参考设计）、应用或其他设计建议、网络工具、安全信息和其他资源，不保证没有瑕疵且不做任何明示或暗示的担保，包括但不限于对适销性、某特定用途方面的适用性或不侵犯任何第三方知识产权的暗示担保。

这些资源可供使用 TI 产品进行设计的熟练开发人员使用。您将自行承担以下全部责任：(1) 针对您的应用选择合适的 TI 产品，(2) 设计、验证并测试您的应用，(3) 确保您的应用满足相应标准以及任何其他功能安全、信息安全、监管或其他要求。

这些资源如有变更，恕不另行通知。TI 授权您仅可将这些资源用于研发本资源所述的 TI 产品的相关应用。严禁以其他方式对这些资源进行复制或展示。您无权使用任何其他 TI 知识产权或任何第三方知识产权。您应全额赔偿因在这些资源的使用中对 TI 及其代表造成的任何索赔、损害、成本、损失和债务，TI 对此概不负责。

TI 提供的产品受 [TI 的销售条款](#) 或 [ti.com](#) 上其他适用条款/TI 产品随附的其他适用条款的约束。TI 提供这些资源并不会扩展或以其他方式更改 TI 针对 TI 产品发布的适用的担保或担保免责声明。

TI 反对并拒绝您可能提出的任何其他或不同的条款。

邮寄地址：Texas Instruments, Post Office Box 655303, Dallas, Texas 75265  
版权所有 © 2025，德州仪器 (TI) 公司