

# LM36010 具有 1.5A 高侧电流源的同步升压、单 LED 闪光灯驱动器

## 1 特性

- 精确且可编程 LED 电流
  - 闪光灯/IR 电流范围：11mA 至 1.5A（128 个级别）
  - 手电筒电流范围：2.4mA 至 376mA（128 个级别）
- 闪光灯超时时间长达 1.6 秒
- 优化了低电池电量条件下的闪光灯 LED 电流 (IVFM)
- LED 阴极对地短路运行以提高热管理
- 较小的总体解决方案尺寸：< 7mm<sup>2</sup>
- 硬件闪光灯使能 (STROBE)
- 输入电压范围：2.5V 至 5.5V
- 400kHz I<sup>2</sup>C 兼容接口
  - I<sup>2</sup>C 地址 = 0x64

## 2 应用

- 手机
- 平板电脑
- IR LED 驱动器
- 视频监控：IP 摄像机
- 条形码扫描仪
- 便携式数据终端

## 3 说明

LM36010 是一款超小型 LED 闪光灯驱动器，具有高度可调节性。总解决方案尺寸为 7mm<sup>2</sup>，可提供高达 1.5A 的 LED 闪光灯电流或高达 376mA 的手电筒电流。

该器件采用 2MHz 或 4MHz 固定频率的同步升压转换器为 1.5A 恒定电流 LED 源供电。自适应调节方法可在闪光灯模式下将电流控制在 11mA 至 1.5A 的范围内，或在手电筒模式下将电流控制在 2.4mA 至 376mA 的范围内，因此可确保电流源保持可调节状态，并可最大限度地提高效率。

LM36010 的特性由与 I<sup>2</sup>C 兼容的接口控制。这些特性包括：硬件闪光灯 (STROBE) 以及适用于闪光灯和影片模式 (手电筒) 的 128 级可编程电流。该器件的开关频率为 2MHz 或 4MHz，具备过压保护 (OVP) 和可调节限流功能，因此可使用微型超薄电感器和陶瓷电容器。该器件可在 -40°C 至 +85°C 的环境温度范围内工作。

器件信息<sup>(1)</sup>

器件型号	封装	封装尺寸 (标称值)
LM36010	DSBGA (8)	1.512mm x 0.800mm

(1) 要了解所有可用封装，请参阅数据表末尾的可订购产品附录。

简化电路原理图

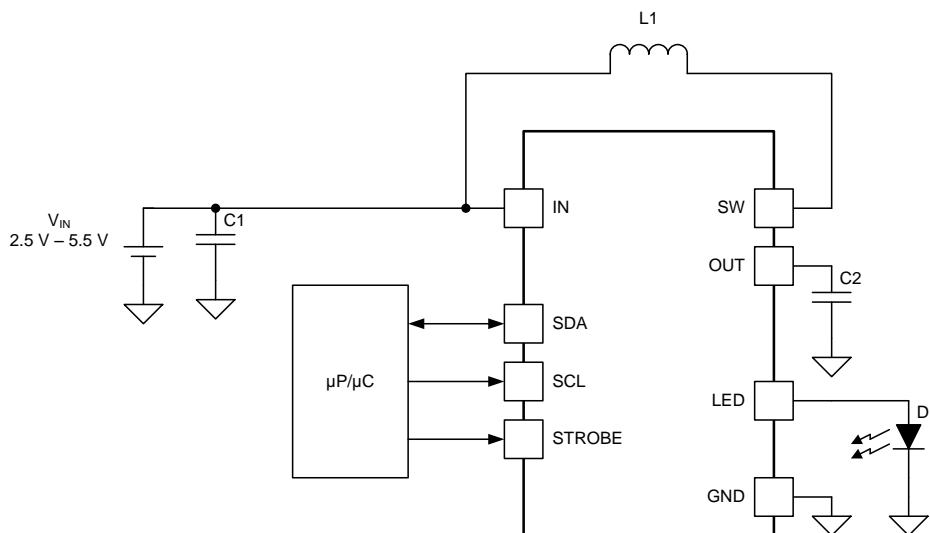

Copyright © 2016, Texas Instruments Incorporated



## 目录

<b>1</b>	特性 .....	<b>1</b>	7.5	Programming.....	<b>18</b>
<b>2</b>	应用 .....	<b>1</b>	7.6	Register Descriptions .....	<b>20</b>
<b>3</b>	说明 .....	<b>1</b>	<b>8</b>	<b>Applications and Implementation .....</b>	<b>22</b>
<b>4</b>	修订历史记录 .....	<b>2</b>	8.1	Application Information.....	<b>22</b>
<b>5</b>	<b>Pin Configuration and Functions .....</b>	<b>3</b>	8.2	Typical Application .....	<b>22</b>
<b>6</b>	<b>Specifications.....</b>	<b>4</b>	<b>9</b>	<b>Power Supply Recommendations.....</b>	<b>33</b>
6.1	Absolute Maximum Ratings .....	<b>4</b>	<b>10</b>	<b>Layout.....</b>	<b>33</b>
6.2	ESD Ratings.....	<b>4</b>	10.1	Layout Guidelines .....	<b>33</b>
6.3	Recommended Operating Conditions.....	<b>4</b>	10.2	Layout Example .....	<b>34</b>
6.4	Thermal Information .....	<b>4</b>	<b>11</b>	<b>器件和文档支持 .....</b>	<b>35</b>
6.5	Electrical Characteristics.....	<b>5</b>	11.1	器件支持 .....	<b>35</b>
6.6	Timing Requirements .....	<b>5</b>	11.2	文档支持 .....	<b>35</b>
6.7	Switching Characteristics .....	<b>5</b>	11.3	接收文档更新通知 .....	<b>35</b>
6.8	Typical Characteristics .....	<b>7</b>	11.4	社区资源 .....	<b>35</b>
<b>7</b>	<b>Detailed Description .....</b>	<b>12</b>	11.5	商标 .....	<b>35</b>
7.1	Overview .....	<b>12</b>	11.6	静电放电警告 .....	<b>35</b>
7.2	Functional Block Diagram .....	<b>13</b>	11.7	Glossary .....	<b>35</b>
7.3	Feature Description .....	<b>14</b>	<b>12</b>	<b>机械、封装和可订购信息.....</b>	<b>36</b>
7.4	Device Functioning Modes.....	<b>16</b>			

## 4 修订历史记录

<b>Changes from Revision A (July 2017) to Revision B</b>	<b>Page</b>
• 更正了封装尺寸 .....	<b>36</b>

<b>Changes from Original (April 2017) to Revision A</b>	<b>Page</b>
• 已更改 器件状态从“高级信息”更改为“生产数据” .....	<b>1</b>

## 5 Pin Configuration and Functions

**YKB Package  
8-Pin DSBGA  
Top View**

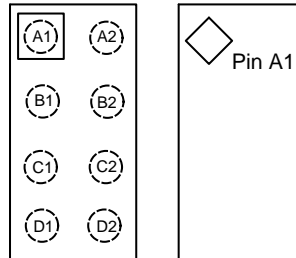

**Pin Functions**

PIN		TYPE <sup>(1)</sup>	DESCRIPTION
NAME	NO.		
A1	GND	G	Ground
A2	IN	P	Input voltage connection. Connect IN to the input supply and bypass to GND with a 10- $\mu$ F or larger ceramic capacitor.
B1	SW	P	Drain connection for Internal NMOS and synchronous PMOS switches.
B2	STROBE	I	Active high hardware flash enable. Drive STROBE high to turn on flash pulse. An internal pulldown resistor of 300 k $\Omega$ is between STROBE and GND.
C1	OUT	P	Step-up DC-DC converter output. Connect a 10- $\mu$ F ceramic capacitor between this terminal and GND.
C2	SDA	I/O	I <sup>2</sup> C serial data input/output.
D1	LED	P	High-side current source output for flash LED.
D2	SCL	I	I <sup>2</sup> C serial clock input.

(1) G = Ground; P = Power; I = Input; O = Output

## 6 Specifications

### 6.1 Absolute Maximum Ratings

over operating free-air temperature range (unless otherwise noted)<sup>(1)(2)</sup>

	MIN	MAX	UNIT
IN, SW, OUT, LED	-0.3	6	V
SDA, SCL, STROBE	-0.3	(V <sub>IN</sub> + 0.3) w/ 6 V maximum	
Continuous power dissipation <sup>(3)</sup>	Internally limited		
Junction temperature, T <sub>J-MAX</sub>		150	°C
Storage temperature, T <sub>stg</sub>	-65	150	°C

- (1) Stresses beyond those listed under *Absolute Maximum Ratings* may cause permanent damage to the device. These are stress ratings only, which do not imply functional operation of the device at these or any other conditions beyond those indicated under *Recommended Operating Conditions*. Exposure to absolute-maximum-rated conditions for extended periods may affect device reliability.
- (2) All voltages are with respect to the potential at the GND pin.
- (3) Internal thermal shutdown circuitry protects the device from permanent damage. Thermal shutdown engages at T<sub>J</sub> = 150°C (typical) and disengages at T<sub>J</sub> = 135°C (typical). Thermal shutdown is ensured by design.

### 6.2 ESD Ratings

		VALUE	UNIT
V <sub>(ESD)</sub> Electrostatic discharge	Human-body model (HBM), per ANSI/ESDA/JEDEC JS-001 <sup>(1)</sup>	±1000	V
	Charged-device model (CDM), per JEDEC specification JESD22-C101 <sup>(2)</sup>	±250	

- (1) JEDEC document JEP155 states that 500-V HBM allows safe manufacturing with a standard ESD control process.
- (2) JEDEC document JEP157 states that 250-V CDM allows safe manufacturing with a standard ESD control process.

### 6.3 Recommended Operating Conditions

over operating free-air temperature range (unless otherwise noted)<sup>(1)(2)</sup>

		MIN	MAX	UNIT
V <sub>IN</sub>		2.5	5.5	V
Junction temperature, T <sub>J</sub>		-40	125	°C
Ambient temperature, T <sub>A</sub> <sup>(3)</sup>		-40	85	°C

- (1) Stresses beyond those listed under *absolute maximum ratings* may cause permanent damage to the device. These are stress ratings only, and functional operation of the device at these or any other conditions beyond those indicated under *recommended operating conditions* is not implied. Exposure to absolute-maximum-rated conditions for extended periods may affect device reliability.
- (2) All voltages are with respect to the potential at the GND pin.
- (3) In applications where high power dissipation and/or poor package thermal resistance is present, the maximum ambient temperature may have to be derated. Maximum ambient temperature (T<sub>A-MAX</sub>) is dependent on the maximum operating junction temperature (T<sub>J-MAX-OP</sub> = 125°C), the maximum power dissipation of the device in the application (P<sub>D-MAX</sub>), and the junction-to-ambient thermal resistance of the part/package in the application (R<sub>θJA</sub>), as given by the following equation: T<sub>A-MAX</sub> = T<sub>J-MAX-OP</sub> - (R<sub>θJA</sub> × P<sub>D-MAX</sub>).

### 6.4 Thermal Information

THERMAL METRIC <sup>(1)</sup>		LM36010	UNIT
		YKB (DSBGA)	
		8 PINS	
R <sub>θJA</sub>	Junction-to-ambient thermal resistance	117.3	°C/W
R <sub>θJC(top)</sub>	Junction-to-case (top) thermal resistance	1.3	°C/W
R <sub>θJB</sub>	Junction-to-board thermal resistance	34.3	°C/W
Ψ <sub>JT</sub>	Junction-to-top characterization parameter	0.5	°C/W
Ψ <sub>JB</sub>	Junction-to-board characterization parameter	34.6	°C/W

- (1) For more information about traditional and new thermal metrics, see the *Semiconductor and IC Package Thermal Metrics* application report.

## 6.5 Electrical Characteristics

$T_A = 25^\circ\text{C}$  and  $V_{IN} = 3.6\text{ V}$ , unless otherwise specified. Minimum and maximum limits apply over the full operating ambient temperature range ( $-40^\circ\text{C} \leq T_A \leq 85^\circ\text{C}$ ).<sup>(1)(2)</sup>

PARAMETER		TEST CONDITIONS	MIN	TYP	MAX	UNIT	
<b>CURRENT SOURCE SPECIFICATIONS</b>							
$I_{LED}$	Current source accuracy	$V_{OUT} = 4\text{ V}$ , flash code = 0x7F = 1.5 A <sup>(3)</sup>		-10%	1.5	10%	A
		$V_{OUT} = 4\text{ V}$ , torch code = 0x7F = 376 mA		-10%	376	10%	mA
$V_{HR}$	LED current source regulation voltage	$I_{LED} = 1.5\text{ A}$	Flash	550		mV	
		$I_{LED} = 376\text{ mA}$	Torch	350			
$V_{OVP}$	Overvoltage Protection	ON threshold		4.86	5	5.10	V
		OFF threshold		4.71	4.85	4.95	
<b>STEP-UP DC-DC CONVERTER SPECIFICATIONS</b>							
$R_{PMOS}$	PMOS switch on-resistance			175		m $\Omega$	
$R_{NMOS}$	NMOS switch on-resistance			130			
$I_{CL}$	Switch current limit	Reg 0x01, bit [5] = 0		-15%	1.9	15%	A
		Reg 0x01, bit [5] = 1		-15%	2.8	15%	
$V_{UVLO}$	Undervoltage lockout threshold	Falling $V_{IN}$		2.5		V	
$V_{IVFM}$	Input voltage flash monitor trip threshold	Reg 0x02, bits [7:5] = 000		-3%	2.9	3%	V
$I_Q$	Quiescent supply current	Device not switching, in pass mode		0.3		mA	
$I_{SB}$	Standby supply current	Device disabled $2.5\text{ V} \leq V_{IN} \leq 5.5\text{ V}$		0.8		4	$\mu\text{A}$
<b>STROBE VOLTAGE SPECIFICATIONS</b>							
$V_{IL}$	Input logic low	$2.5\text{ V} \leq V_{IN} \leq 5.5\text{ V}$		0	0.4		V
$V_{IH}$	Input logic high			1.2	$V_{IN}$		V
<b>I<sup>2</sup>C-COMPATIBLE INTERFACE SPECIFICATIONS (SCL, SDA)</b>							
$V_{IL}$	Input logic low	$2.5\text{ V} \leq V_{IN} \leq 4.2\text{ V}$		0	0.4		V
$V_{IH}$	Input logic high			1.2	$V_{IN}$		
$V_{OL}$	Output logic low	$I_{LOAD} = 3\text{ mA}$		400		mV	

- (1) Minimum (MIN) and Maximum (MAX) limits are specified by design, test, or statistical analysis. Typical (TYP) numbers are not verified, but do represent the most likely norm. Unless otherwise specified, conditions for typical specifications are:  $V_{IN} = 3.6\text{ V}$  and  $T_A = 25^\circ\text{C}$ .
- (2) All voltages are with respect to the potential at the GND pin.
- (3) The ability to deliver 1.5 A of LED current is highly dependent upon the input voltage, LED voltage, ambient temperature and PCB layout. Depending upon the system conditions, it is possible that the device could hit the internal thermal shutdown or thermal scale-back value before the desired flash duration is reached. See [Thermal Performance](#) for more details.

## 6.6 Timing Requirements

		MIN	NOM	MAX	UNIT
$t_1$	SCL clock period	2.4			$\mu\text{s}$
$t_2$	Data in set-up time to SCL high	100			ns
$t_3$	Data out stable after SCL low	0			ns
$t_4$	SDA low set-up time to SCL low (start)	100			ns
$t_5$	SDA high hold time after SCL high (stop)	100			ns

## 6.7 Switching Characteristics

over operating free-air temperature range (unless otherwise noted)

PARAMETER		TEST CONDITIONS	MIN	TYP	MAX	UNIT
$f_{SW}$	Switching frequency	$2.5\text{ V} \leq V_{IN} \leq 5.5\text{ V}$	-10%	2	10%	MHz
			-10%	4	10%	

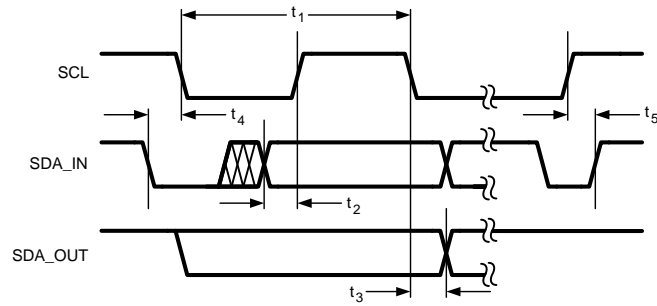

**图 1. I<sup>2</sup>C-Compatible Interface Specifications**

### 6.8 Typical Characteristics

$T_A = 25^\circ\text{C}$ ,  $V_{IN} = 3.6\text{ V}$ ,  $C_{IN} = 10\ \mu\text{F}$ ,  $C_{OUT} = 10\ \mu\text{F}$ ,  $L = 1\ \mu\text{H}$ ,  $V_{LED} = 3.4\text{ V}$ , Flash Time-out = 320 ms and Thermal Scale-Back (TSB) disabled, unless otherwise noted.



图 2. LED Flash Current vs Brightness Code



图 3. LED Flash Current vs Brightness Code

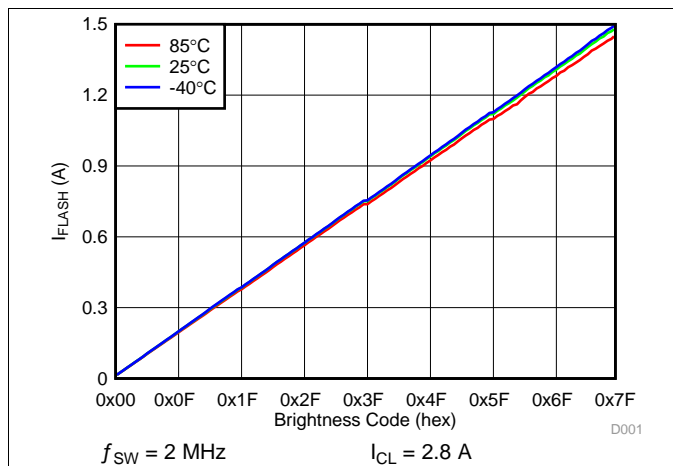

图 4. LED Flash Current vs Input Voltage

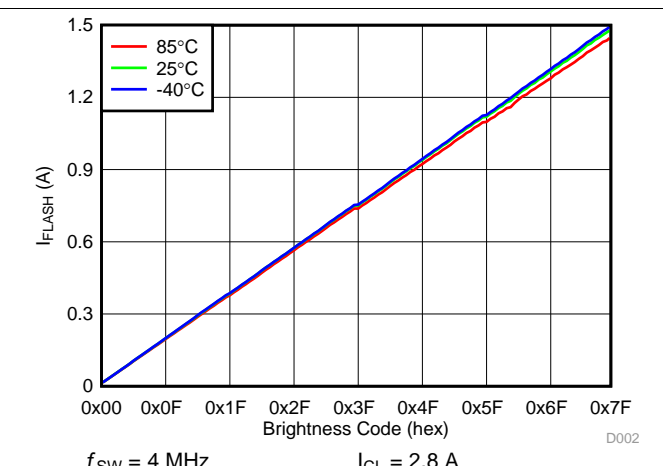

图 5. LED Flash Current vs Input Voltage

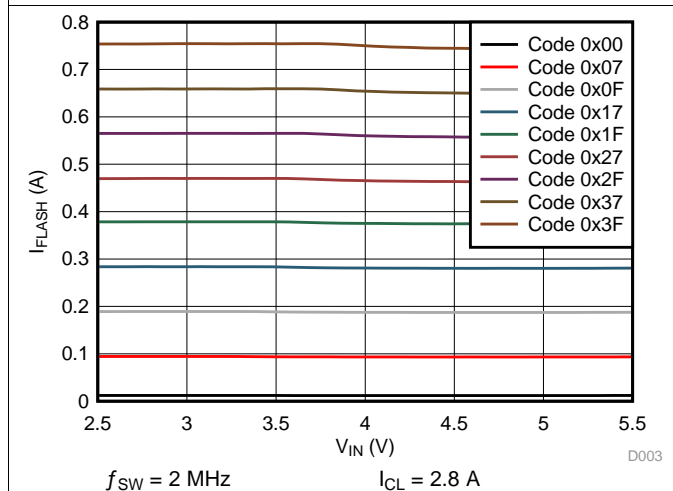

图 6. LED Flash Current vs Input Voltage

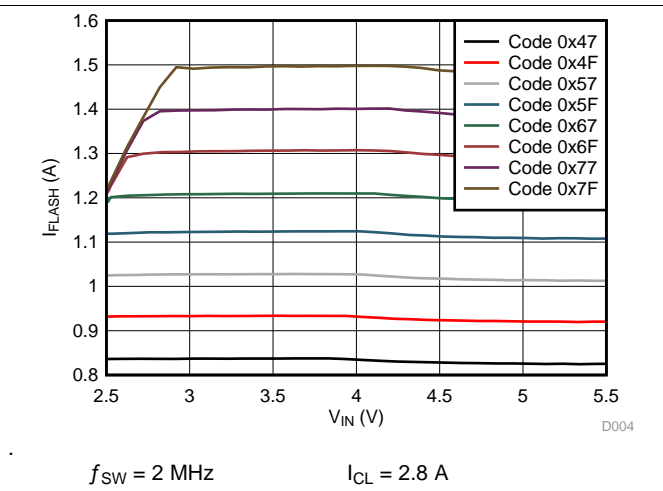

图 7. LED Flash Current vs Input Voltage

Typical Characteristics (接下页)

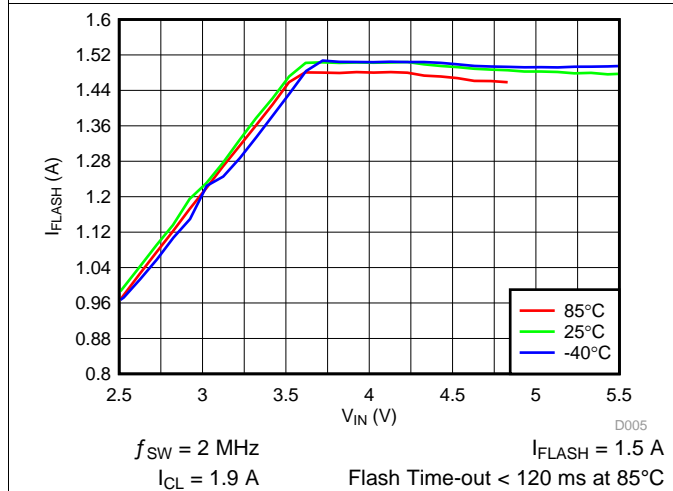
$T_A = 25^\circ\text{C}$ ,  $V_{IN} = 3.6\text{ V}$ ,  $C_{IN} = 10\ \mu\text{F}$ ,  $C_{OUT} = 10\ \mu\text{F}$ ,  $L = 1\ \mu\text{H}$ ,  $V_{LED} = 3.4\text{ V}$ , Flash Time-out = 320 ms and Thermal Scale-Back (TSB) disabled, unless otherwise noted.



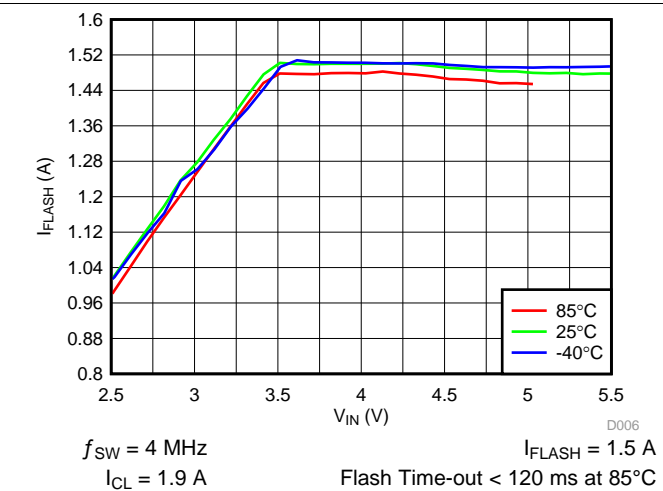
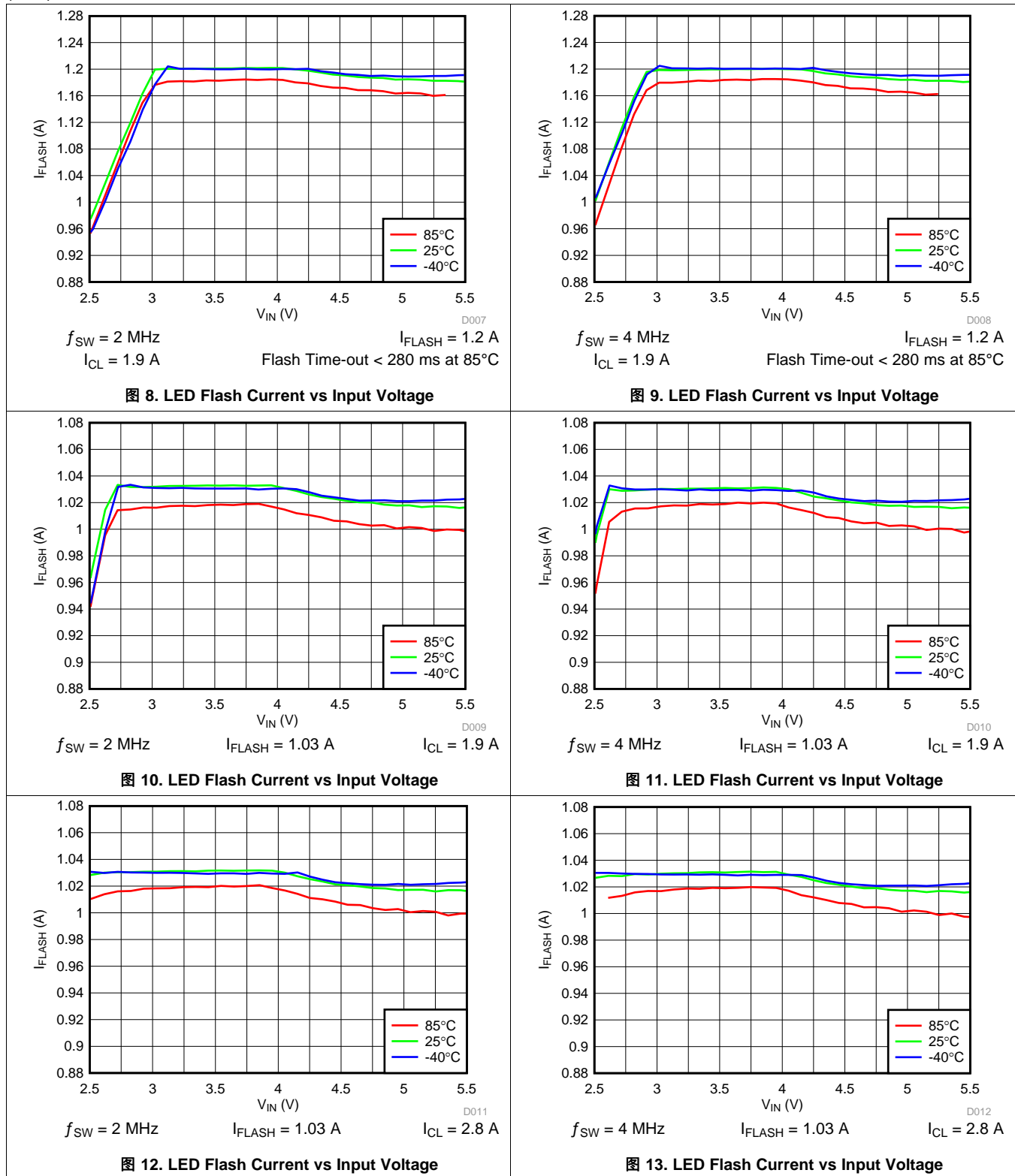

Typical Characteristics (接下页)

$T_A = 25^\circ\text{C}$ ,  $V_{IN} = 3.6\text{ V}$ ,  $C_{IN} = 10\ \mu\text{F}$ ,  $C_{OUT} = 10\ \mu\text{F}$ ,  $L = 1\ \mu\text{H}$ ,  $V_{LED} = 3.4\text{ V}$ , Flash Time-out = 320 ms and Thermal Scale-Back (TSB) disabled, unless otherwise noted.



图 14. LED Flash Current vs Input Voltage



图 15. LED Flash Current vs Input Voltage

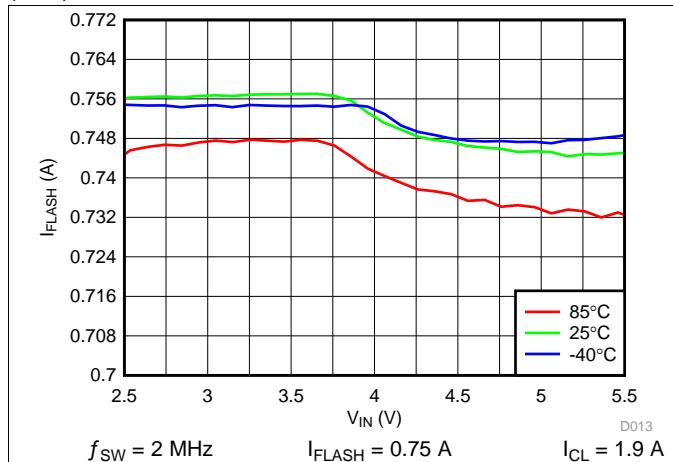

图 16. LED Flash Current vs Input Voltage

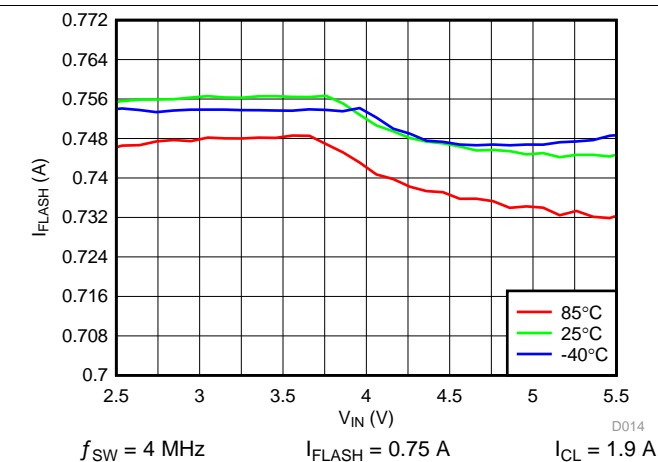

图 17. LED Flash Current vs Input Voltage

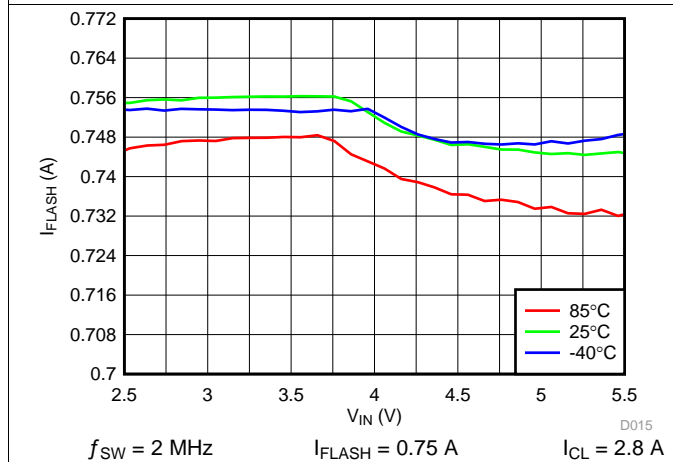

图 18. LED Torch Current vs Brightness Code

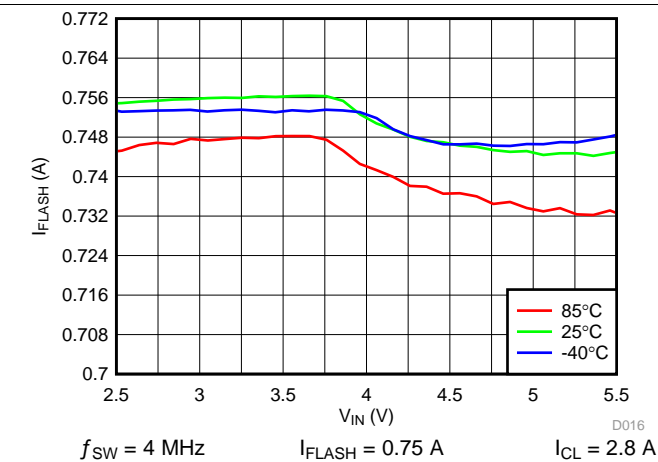

图 19. LED Torch Current vs Brightness Code

Typical Characteristics (接下页)

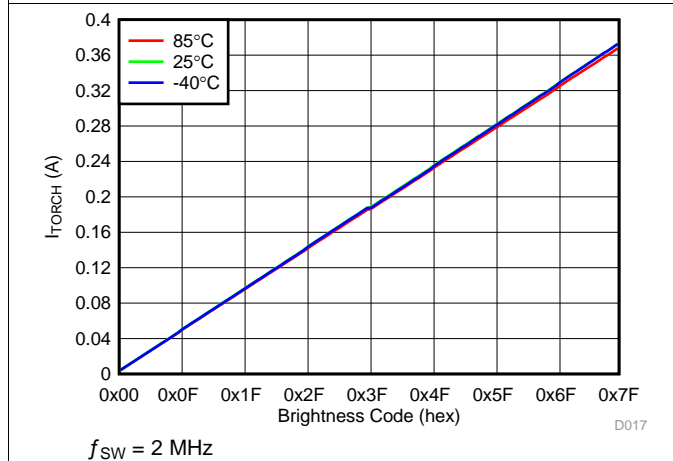
$T_A = 25^\circ\text{C}$ ,  $V_{IN} = 3.6\text{ V}$ ,  $C_{IN} = 10\ \mu\text{F}$ ,  $C_{OUT} = 10\ \mu\text{F}$ ,  $L = 1\ \mu\text{H}$ ,  $V_{LED} = 3.4\text{ V}$ , Flash Time-out = 320 ms and Thermal Scale-Back (TSB) disabled, unless otherwise noted.

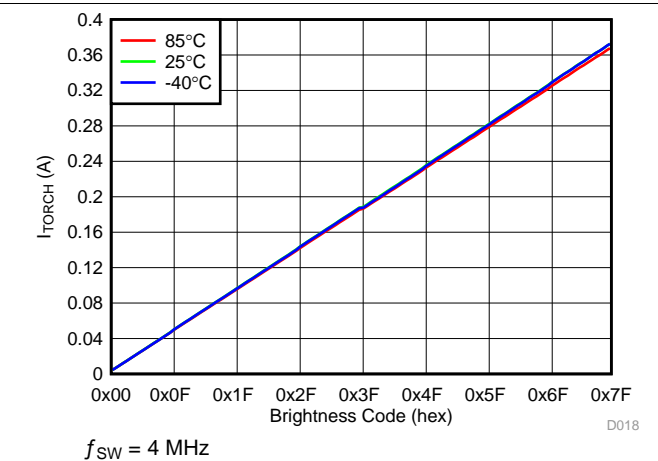
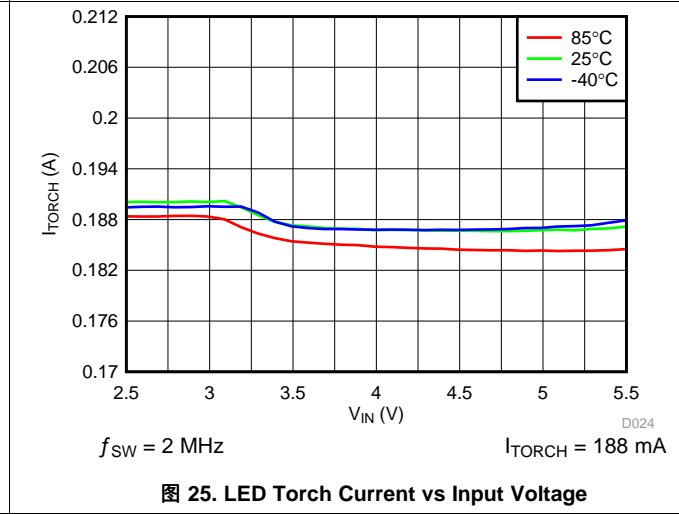
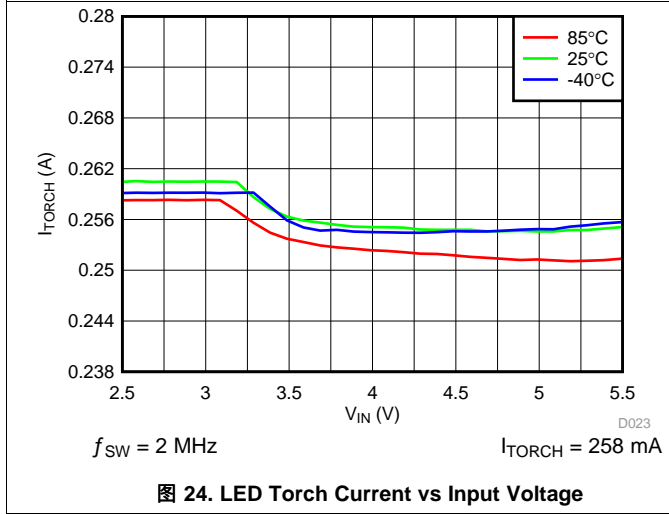
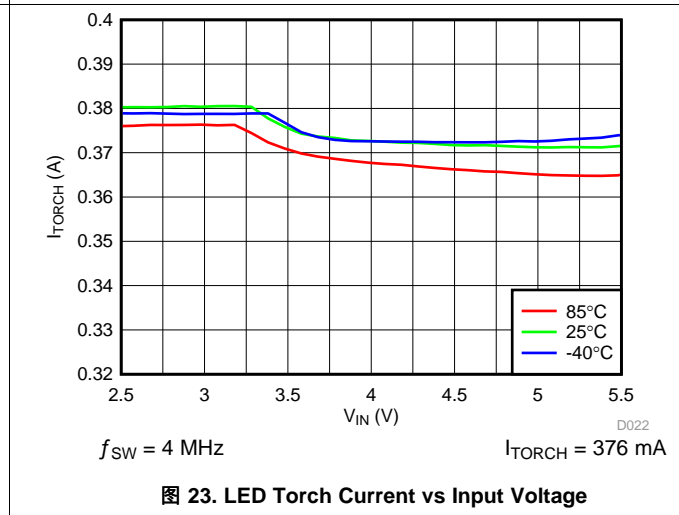
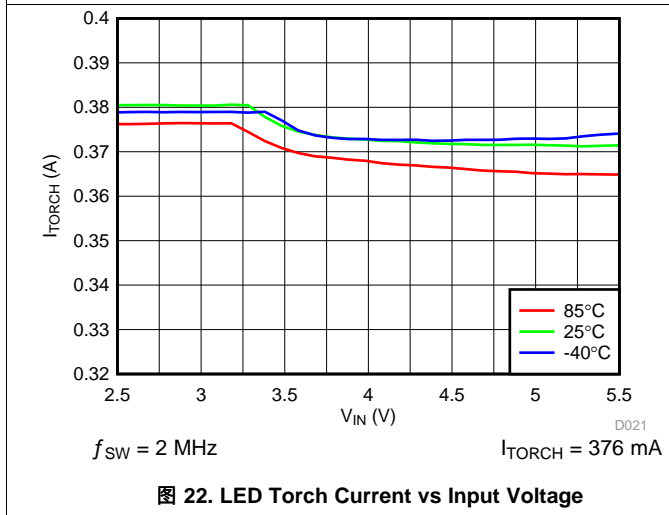
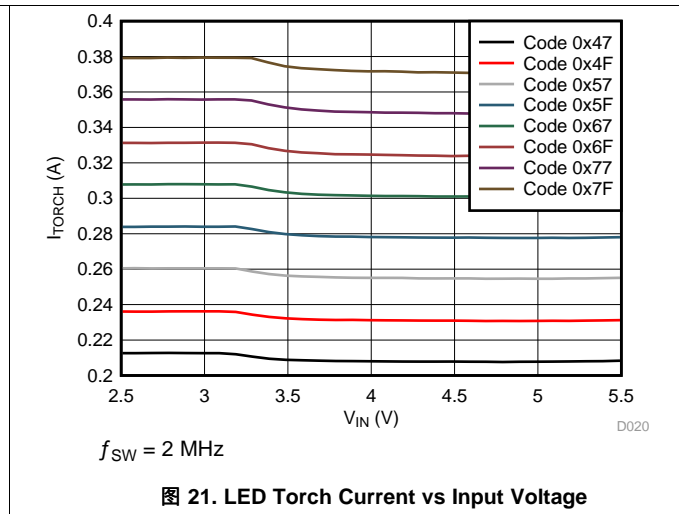
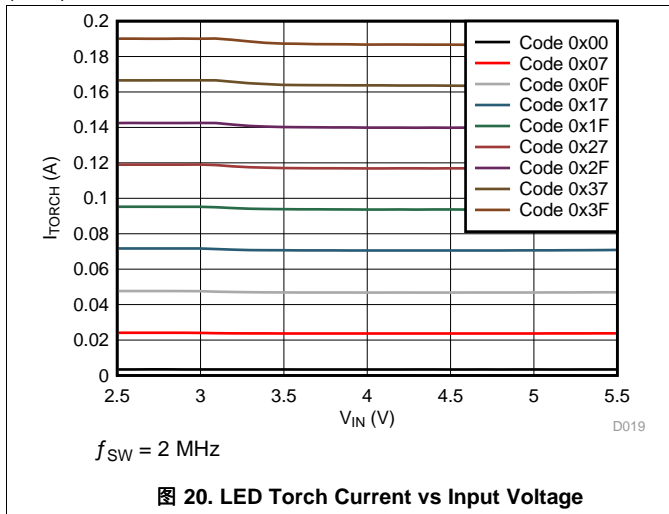

Typical Characteristics (接下页)

$T_A = 25^\circ\text{C}$ ,  $V_{IN} = 3.6\text{ V}$ ,  $C_{IN} = 10\ \mu\text{F}$ ,  $C_{OUT} = 10\ \mu\text{F}$ ,  $L = 1\ \mu\text{H}$ ,  $V_{LED} = 3.4\text{ V}$ , Flash Time-out = 320 ms and Thermal Scale-Back (TSB) disabled, unless otherwise noted.

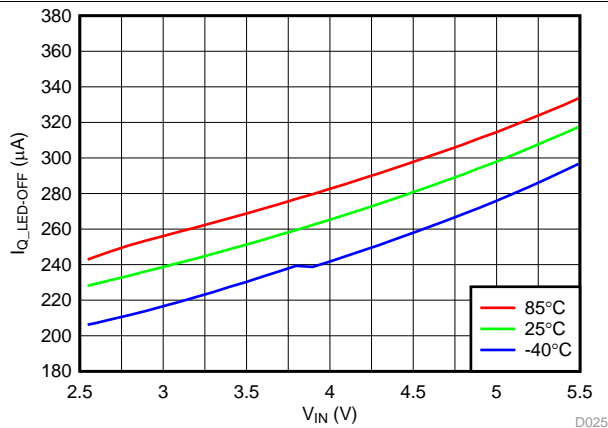

Mode (Reg 0x01 bits[1:0]) = 01 (IR Mode)

图 26. LED Off Current vs Input Voltage

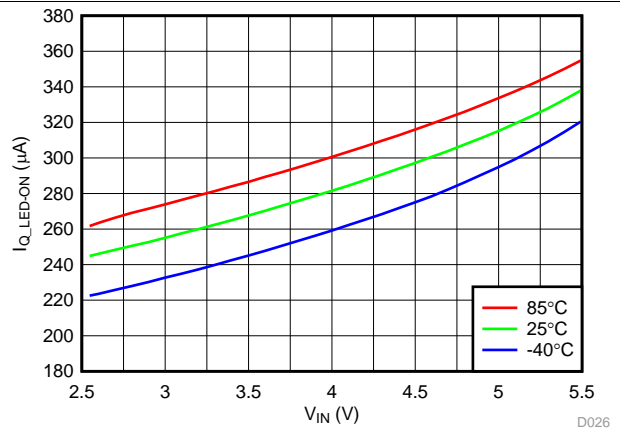

Mode (Reg 0x01 bits[1:0]) = 10 (Torch Mode)

图 27. LED On Current vs Input Voltage



图 28. Standby Current vs Input Voltage

## 7 Detailed Description

### 7.1 Overview

The LM36010 is a high-power white LED flash driver capable of delivering up to 1.5 A to the LED. The device incorporates a 2-MHz or 4-MHz constant frequency-synchronous current-mode PWM boost converter and a high-side current source to regulate the LED current over the 2.5-V to 5.5-V input voltage range.

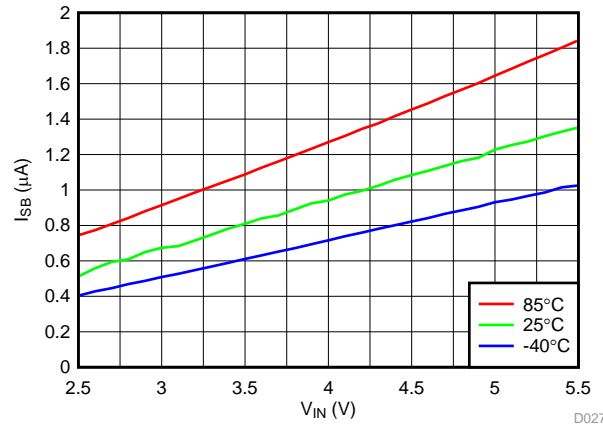
The LM36010 PWM DC-DC boost converter switches and boosts the output to maintain at least  $V_{HR}$  across the current source. This minimum headroom voltage ensures that the current source remains in regulation. If the input voltage is above the LED voltage + current source headroom voltage the device does not switch, but turns the PFET on continuously (pass mode). In pass mode, the drop across the current source is the difference between  $(V_{IN} - I_{LED} \times R_{PMOS})$  and  $V_{LED}$ .

The device has one logic input for a hardware flash enable (STROBE). This logic input has an internal 300-k $\Omega$  (typical) pulldown resistor to GND.

Additional features of the device include an input voltage monitor that can reduce the flash current during low  $V_{IN}$  conditions and a temperature based current scale-back feature that forces the flash current to the set torch level if the on-chip junction temperature reaches 125°C.

Control is done via an I<sup>2</sup>C-compatible interface. This includes adjustment of the flash and torch current levels, changing the switch current limit, and changing the flash time-out duration. Additionally, there are flag and status bits that indicate flash current time-out, LED over-temperature condition, LED failure (open/short), device thermal shutdown, thermal current scale-back, and  $V_{IN}$  undervoltage conditions.

### 7.2 Functional Block Diagram

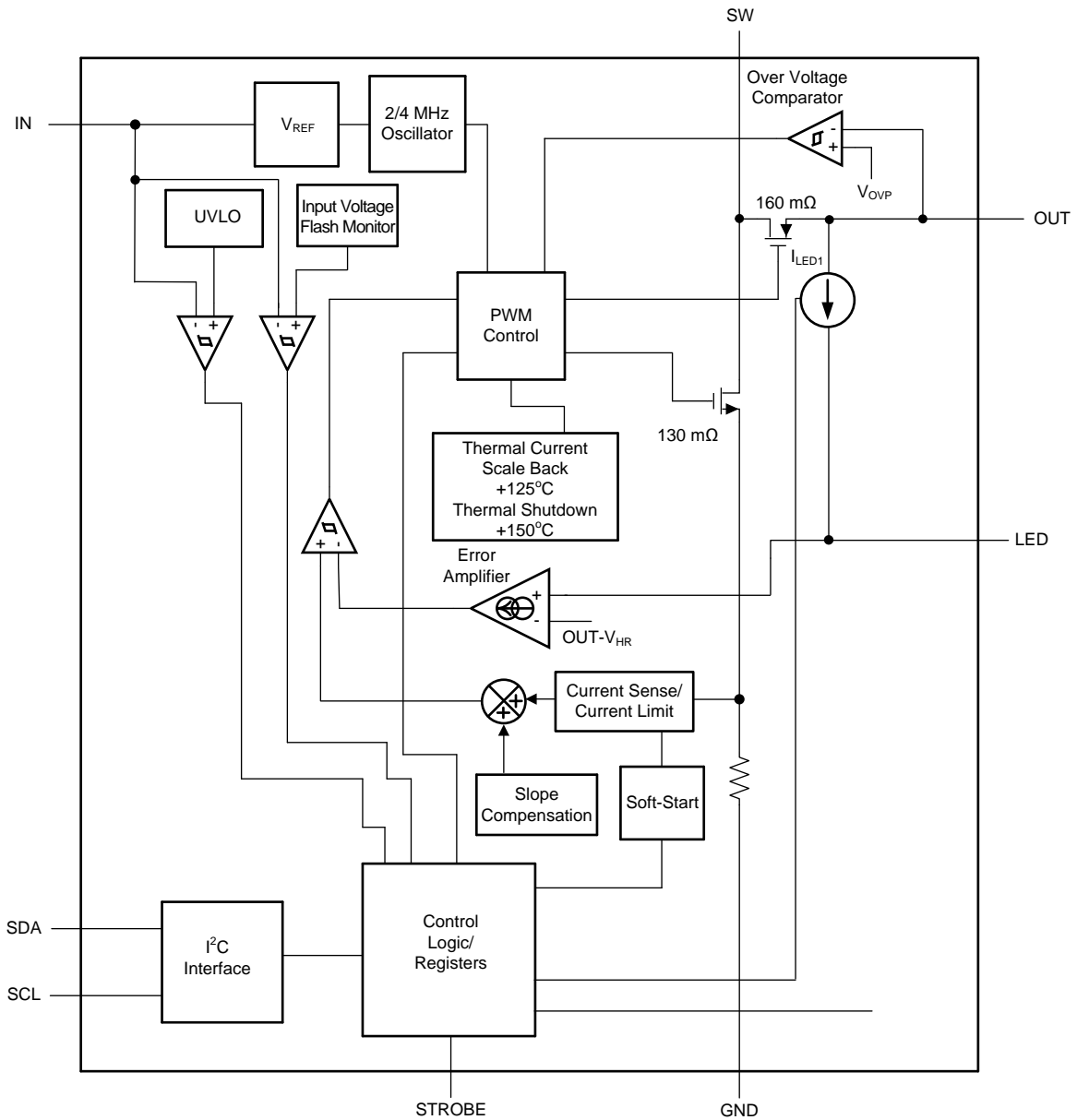

Copyright © 2017, Texas Instruments Incorporated

## 7.3 Feature Description

### 7.3.1 Flash Mode

In flash mode, the LED current source provides 128 target current levels from 11 mA to 1.5 A, set by the LED Flash Brightness Register (0x03 bits [6:0]). Flash mode is activated by the Enable Register (0x01), setting mode M1, M0 (bits [1:0]) to 11. Once the flash sequence is activated, the LED current source ramps up to the programmed flash current by stepping through all current steps until the programmed current is reached. The headroom on the current source is regulated to provide 11 mA to 1.5 A.

When flash mode is enabled using the mode M1, M0 (bits [1:0]) of the Enable Register (0x01), the mode bits in the Enable Register are cleared after a flash time-out event.

### 7.3.2 Torch Mode

In torch mode, the LED current source provides 128 target current levels from 2.4 mA to 376 mA, set by the LED Torch Brightness Register (0x04 bits [6:0]). Torch mode is activated by the Enable Register (0x01), setting mode M1, M0 (bits [1:0]) to 10. Once the TORCH sequence is activated, the LED current source ramps up to the programmed torch current by stepping through all current steps until the programmed current is reached. The rate at which the current ramps is determined by the value chosen in the Torch Ramp bit [0] in Timing Register (0x02).

### 7.3.3 IR Mode

In IR mode, the target LED current is equal to the value stored in the LED Flash Brightness Register (0x03 bits [7:0]). When IR mode is enabled by the Enable Register (0x01) setting mode M1, M0 (bits [1:0]) to 01, the boost converter turns on and sets the output equal to the input (pass mode). In IR mode, toggling the STROBE pin enables and disables the LED current source. The STROBE pin can only be set to be Level sensitive, as all timing of the IR pulse is externally controlled. In IR mode, the current source does not control the ramp rate of the LED output. The current transitions immediately from off to on and then on to off.

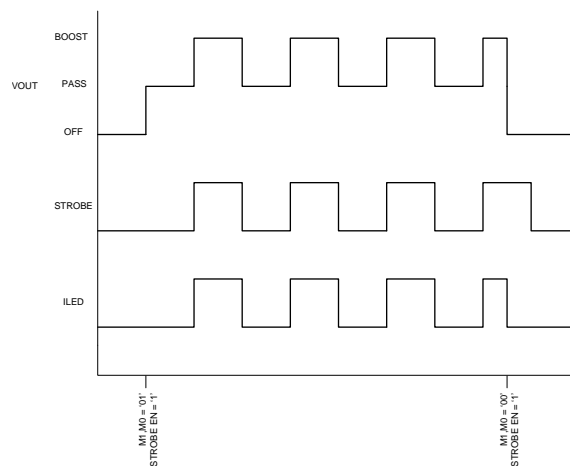

- (1) If needed, the DC/DC boost will turn on when the LED current is delivered (Strobe Pin = High). When the Strobe Pin goes low, the output voltage will return to  $V_{IN}$  (Pass Mode)

**图 29. IR Mode with Boost**

Feature Description (接下页)

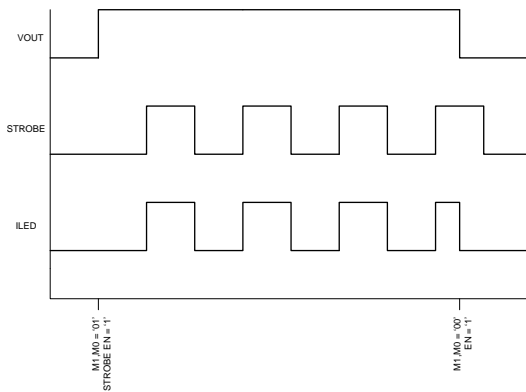

(1) In pass mode, the boost stays disabled and  $V_{OUT} = V_{IN}$  when the Strobe Pin is high or low

图 30. IR Mode Pass Only

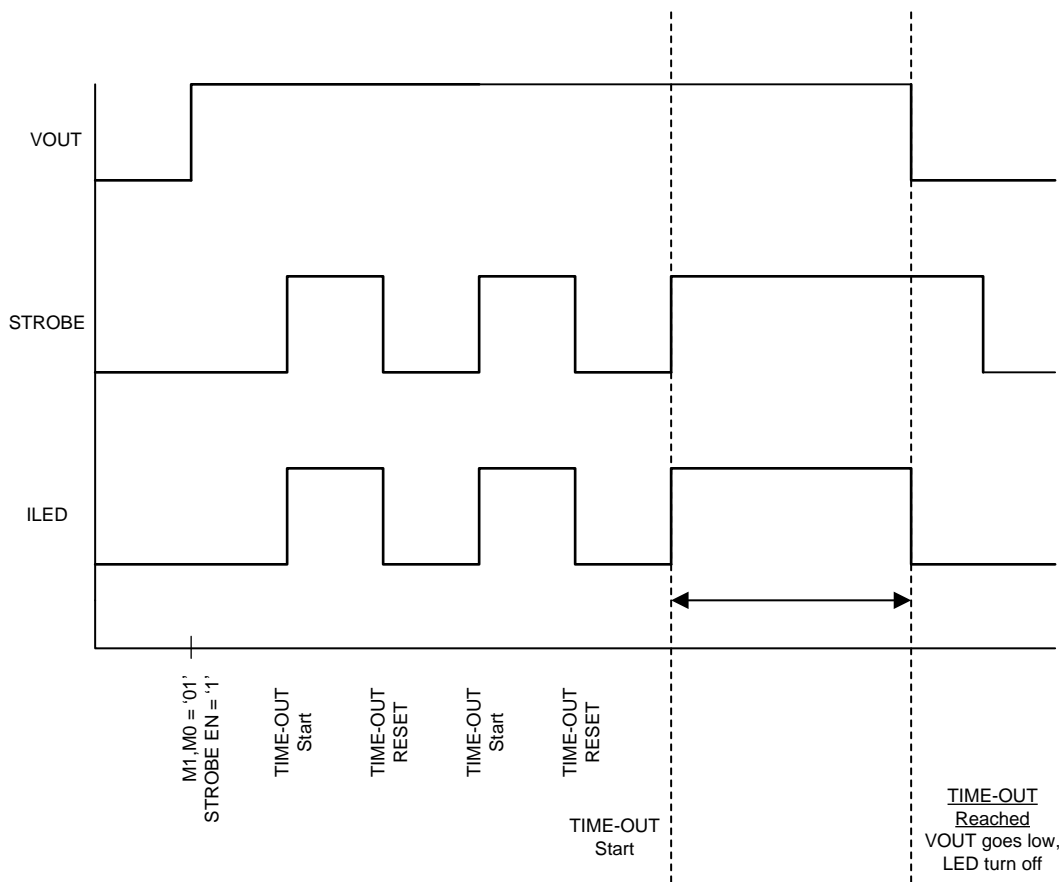

(1) When the flash timer elapses, the device goes into stand-by regardless of strobe state

图 31. IR Mode Time-out

## 7.4 Device Functioning Modes

### 7.4.1 Start-Up (Enabling The Device)

At turnon the LED current source steps through each FLASH or TORCH level until the target LED current is reached. This gives the device a controlled turnon and limits inrush current from the  $V_{IN}$  supply. The target LED flash and the target LED torch currents are set by the LED Flash Brightness Register (0x03 bits [6:0]) and LED Torch Brightness Register (0x04 bits [6:0]) respectively.

### 7.4.2 Pass Mode

The LM36010 starts up in pass mode and stays there until boost mode is needed to maintain regulation. If the voltage difference between  $V_{OUT}$  and  $V_{LED}$  falls below  $V_{HR}$ , the device switches to boost mode. In pass mode, the boost converter does not switch, the synchronous PFET turns fully on bringing  $V_{OUT}$  up to  $V_{IN} - I_{LED} \times R_{PMOS}$ , and the inductor current is not limited by the peak current limit.

### 7.4.3 Input Voltage Flash Monitor (IVFM)

The LM36010 has the ability to adjust the flash current based upon the voltage level present at the IN pin utilizing the input voltage flash monitor (IVFM). The adjustable threshold IVFM-D ranges from 2.9 V to 3.6 V in 100-mV steps and is set by Configuration Register (0x02) bits [7:5]. Additionally, the IVFM-D threshold sets the input voltage boundary that forces the LM36010 to stop ramping the flash current during start-up.



图 32. IVFM Mode

### 7.4.4 Fault/Protections

Upon a fault condition, the LM36010 sets the appropriate flag(s) in the Flags Register (0x05) and switches into stand-by mode obtained by clearing the mode M1, M0 (bits [1:0]) of the Enable Register (0x01). The LM36010 remains in standby until an I<sup>2</sup>C read of the Flags Register. I<sup>2</sup>C read of the Flags Register clears the flags and the fault status can be re-checked. If the fault(s) is still present, the LM36010 re-sets the appropriate flag bits and enters stand-by again.

#### 7.4.4.1 Overvoltage Protection (OVP)

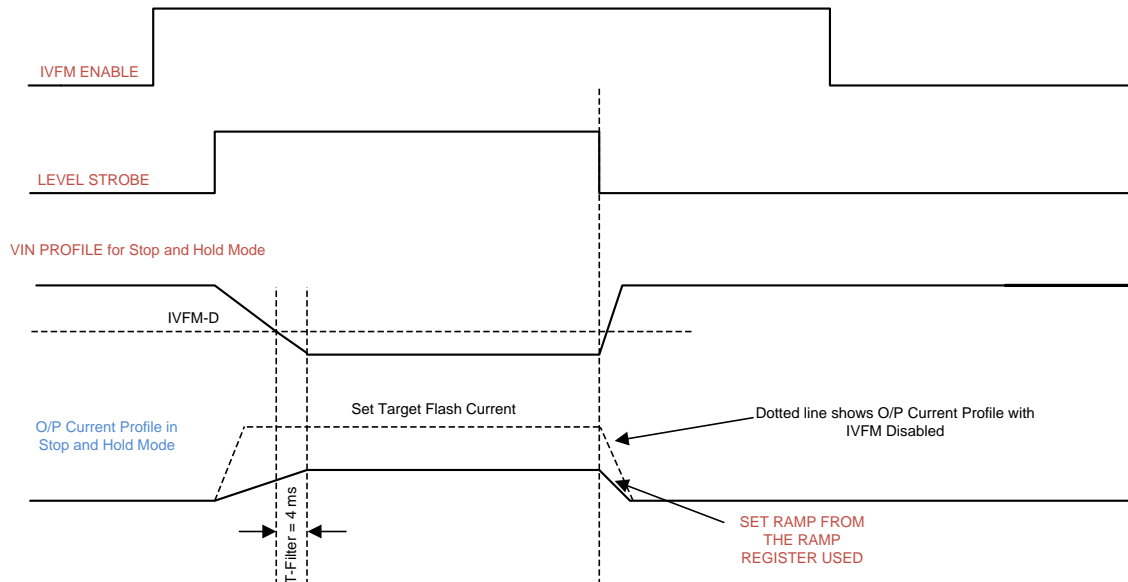
The output voltage is limited to typically 5 V (see  $V_{OVP}$  specification in the [Electrical Characteristics](#)). In situations such as an open LED, the LM36010 raises the output voltage in order to keep the LED current at its target value. When  $V_{OUT}$  reaches 5 V (typical), the overvoltage comparator trips and turns off the internal NFET. When OVP condition is present for three consecutive OVP events, LM36010 enters stand-by mode and OVP flag (bit [0]) of Flags Register (0x01) is set. Checking for three consecutive events prevents forcing the device to shut down due to momentary OVP condition. When  $V_{OUT}$  falls below the  $V_{OVP}$  off threshold, the LM36010 switches again.



## Device Functioning Modes (接下页)

### 7.4.4.2 Input Voltage Flash Monitor (IVFM)

When the input voltage crosses the IVFM-D value, programmed by Configuration Register (0x02) bits [7:5], the LM36010 sets the IVFM flag (bit [6]) of Flags Register (0x05).

### 7.4.4.3 LED and/or VOUT Short Fault

LM36010 enters stand-by mode from flash or torch mode and  $V_{LED}$  Short Fault flag (bit [5]) of Flags Register (0x05) is set, if the LED output and/or VOUT experiences a short condition. An LED short condition occurs if the voltage at the LED pin goes below 500 mV (typical). There is a deglitch time of 256  $\mu$ s before the LED short flag is valid, and a deglitch time of 2.048 ms before the VOUT short flag is valid. The LED and/or VOUT short fault can be reset to 0 by removing power to the LM36010, or setting the software reset field (Register 0x06 bit [7]) to a 1, or by reading back the Flags Register.

### 7.4.4.4 Current Limit (OCP)

The LM36010 features two selectable inductor current limits, 1.9A and 2.8A, programmable through the I<sup>2</sup>C-compatible interface by writing to Register 0x01 bit [5]. When the inductor current limit is reached, the LM36010 terminates the charging phase of the switching cycle and sets the OCP flag (bit [4]) of Flags Register (0x05). However, the mode M1, M0 (bits [1:0]) are not cleared as the device operates at current limit. Switching resumes at the start of the next switching period.

In pass mode, there is no mechanism to limit the current as the current does not flow through the NMOS, which senses the current limit.

In the boost mode or the pass mode, if  $V_{OUT}$  falls below 2.3 V, the device stops switching, and the PFET operates as a current source limiting the current to 200 mA. This prevents the LM36010 from drawing excessive current from the battery during output short-circuit conditions.

### 7.4.4.5 Thermal Scale-Back (TSB)

When the LM36010 die temperature reaches 125°C, the thermal scale-back (TSB) circuit trips and TSB flag (bit [2]) of Flags Register (0x05) is set. The LED current then shifts to torch current level, set by the LED Torch Brightness Register (0x04 bits [6:0]) for the duration of the flash pulse, set by the flash time-out in the Configuration Register (0x02 bits [4:1]). After I<sup>2</sup>C read of the Flags Register and upon re-flash, if the die temperature is still above 125°C, the LM36010 re-enters into torch current level and sets the TSB flag bit again.

### 7.4.4.6 Thermal Shutdown (TSD)

When the LM36010 die temperature reaches 150°C, the thermal shutdown (TSD) circuit trips, forcing the LM36010 into standby and writing a 1 to the TSD flag (bit [2]) of the Flags Register (0x05). The LM36010 restarts only after the Flags Register is read, which clears the fault flag. Upon restart, if the die temperature is still above 150°C, the LM36010 resets the TSD flag and re-enters standby.

### 7.4.4.7 Undervoltage Lockout (UVLO)

The LM36010 has an internal comparator that monitors the voltage at IN pin. If the input voltage drops to 2.5 V, the UVLO flag (bit [1]) of Flags Register (0x05) is set and the LM36010 switches to stand-by mode. After the UVLO flag is set, even if the input voltage rises above 2.5 V, the LM36010 is not available for operation until there is an I<sup>2</sup>C read of the Flags Register. Upon an I<sup>2</sup>C read of the Flags Register, the UVLO fault is cleared and normal operation can resume.

### 7.4.4.8 Flash Time-out (FTO)

The LM36010 sources the flash current for the time period set by Flash Time-out (0x02 bits [4:1]). The LED current source has 16 time-out levels ranging from 40 ms to 1600 ms.

## 7.5 Programming

### 7.5.1 Control Truth Table

M1 (Register 0x01 bit[1])	M0 (Register 0x01 bit[0])	STROBE EN (Register 0x01 bit[2])	STROBE PIN	ACTION
0	0	0	X	Standby
0	0	1	pos edge	Ext flash
1	0	X	X	Int torch
1	1	X	X	Int flash
0	1	0	X	IR LED standby
0	1	1	0	IR LED standby
0	1	1	pos edge	IR LED enabled

### 7.5.2 I<sup>2</sup>C-Compatible Interface

#### 7.5.2.1 Data Validity

The data on SDA must be stable during the HIGH period of the clock signal (SCL). In other words, the state of the data line can only be changed when SCL is LOW.



图 33. Data Validity Data

A pullup resistor between the VIO line of the controller and SDA must be greater than  $[(VIO - V_{OL}) / 3 \text{ mA}]$  to meet the  $V_{OL}$  requirement on SDA. Using a larger pullup resistor results in lower switching current with slower edges, while using a smaller pullup resistor results in higher switching currents with faster edges.

#### 7.5.2.2 Start and Stop Conditions

START and STOP conditions classify the beginning and the end of the I<sup>2</sup>C session. A START condition is defined as the SDA signal transitioning from HIGH to LOW while SCL line is HIGH. A STOP condition is defined as the SDA transitioning from LOW to HIGH while SCL is HIGH. The I<sup>2</sup>C master always generates START and STOP conditions. The I<sup>2</sup>C bus is considered busy after a START condition and free after a STOP condition. During data transmission, the I<sup>2</sup>C master can generate repeated START conditions. First START and repeated START conditions are equivalent, function-wise.

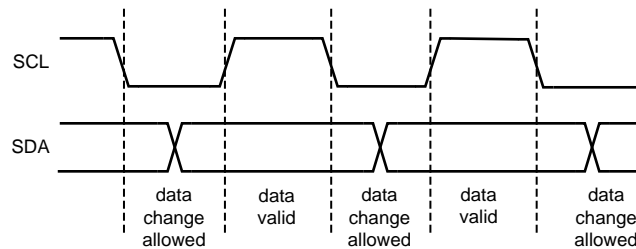

图 34. Start and Stop Conditions

### 7.5.2.3 Transferring Data

Every byte put on the SDA line must be eight bits long, with the most significant bit (MSB) transferred first. Each byte of data has to be followed by an acknowledge bit. The acknowledge related clock pulse is generated by the master. The master releases the SDA line (HIGH) during the acknowledge clock pulse. The LM36010 pulls down the SDA line during the 9th clock pulse, signifying an acknowledge. The LM36010 generates an acknowledge after each byte is received. There is no acknowledge created after data is read from the device.

After the START condition, the I<sup>2</sup>C master sends a chip address. This address is seven bits long followed by an eighth bit which is a data direction bit (R/W). The LM36010 7-bit address is 0x64. For the eighth bit, a 0 indicates a WRITE, and a 1 indicates a READ. The second byte selects the register to which the data is written. The third byte contains data to write to the selected register.

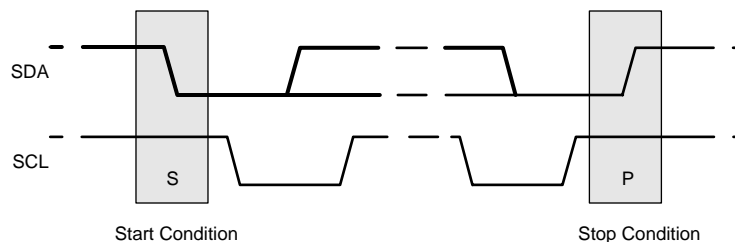

图 35. Write Cycle W = Write (SDA = 0) R = Read (SDA = 1) Ack = Acknowledge (SDA Pulled Down by Either Master or Slave) ID = Chip Address, 64h for LM36010

### 7.5.2.4 I<sup>2</sup>C-Compatible Chip Address

The device address for the LM36010 is 1100100 (0x64). After the START condition, the I<sup>2</sup>C-compatible master sends the 7-bit address followed by an eighth read or write bit (R/W). R/W = 0 indicates a WRITE and R/W = 1 indicates a READ. The second byte following the device address selects the register address to which the data is written. The third byte contains the data for the selected register.

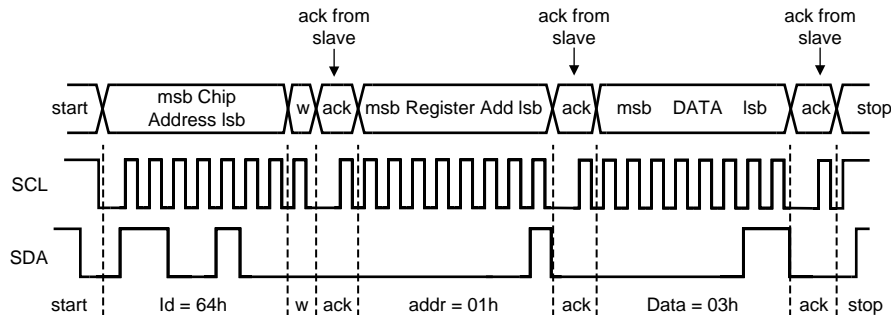

图 36. I<sup>2</sup>C-Compatible Chip Address

## 7.6 Register Descriptions

REGISTER NAME	INTERNAL HEX ADDRESS	POWER ON/RESET VALUE
		LM36010
Enable Register	0x01	0x20
Configuration Register	0x02	0x15
LED Flash Brightness Register	0x03	0x00
LED Torch Brightness Register	0x04	0x00
Flags Register	0x05	0x00
Device ID Register	0x06	0x01

### 7.6.1 Enable Register (0x01)

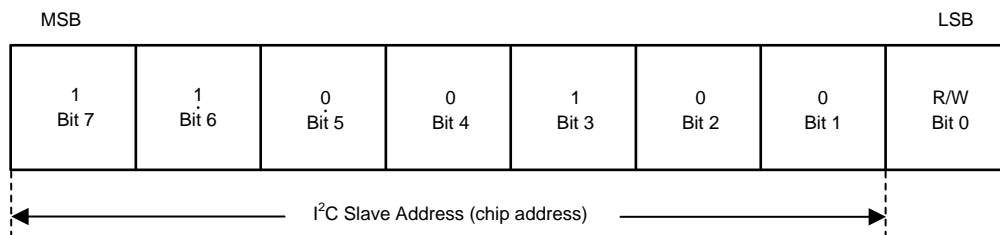
Bit 7	Bit 6	Bit 5	Bit 4	Bit 3	Bit 2	Bit 1	Bit 0
<b>Boost Mode</b> 0 = Normal (Default) 1 = Pass Mode Only	<b>Boost Frequency Select</b> 0 = 2 MHz (Default) 1 = 4 MHz	<b>Boost Current Limit Setting</b> 0 = 1.9 A (Default) 1 = 2.8 A (Default)	<b>IVFM Enable</b> 0 = Disabled (Default) 1 = Enabled	<b>Strobe Type</b> 0 = Level Triggered (Default) 1 = Edge Triggered	<b>Strobe Enable</b> 0 = Disabled (Default) 1 = Enabled	<b>Mode Bits: M1, M0</b> 00 = Standby (Default) 01 = IR Drive 10 = Torch 11 = Flash	

**注**

Edge strobe mode is not valid in IR MODE. Switching between level and edge strobe types while the device is enabled is not recommended.

In edge or level strobe mode, TI recommends that the trigger pulse width be set greater than 1 ms to ensure proper turn-on of the device.

### 7.6.2 Configuration Register (0x02)

Bit 7	Bit 6	Bit 5	Bit 4	Bit 3	Bit 2	Bit 1	Bit 0
<b>IVFM Levels (IVFM-D)</b> 000 = 2.9 V (Default) 001 = 3 V 010 = 3.1 V 011 = 3.2 V 100 = 3.3 V 101 = 3.4 V 110 = 3.5 V 111 = 3.6 V			<b>Flash Time-out Duration</b> 0000 = 40 ms 0001 = 80 ms 0010 = 120 ms 0011 = 160 ms 0100 = 200 ms 0101 = 240 ms 0110 = 280 ms 0111 = 320 ms 1000 = 360 ms 1001 = 400 ms 1010 = 600 ms (Default) 1011 = 800 ms 1100 = 1000 ms 1101 = 1200 ms 1110 = 1400 ms 1111 = 1600 ms			<b>Torch Ramp</b> 0 = No Ramp 1 = 1 ms (default)	

**注**

On the LM36010, special care must be taken with regards to thermal management when using time-out values greater than 500 ms. Depending on the PCB layout, input voltage, and output current, it is possible to have the internal thermal shutdown circuit trip prior to reaching the desired flash time-out value.

**7.6.3 LED Flash Brightness Register (0x03)**

Bit 7	Bit 6	Bit 5	Bit 4	Bit 3	Bit 2	Bit 1	Bit 0
<b>Thermal Current Scale-Back</b> 0 = Disabled 1 = Enabled (default) If enabled, the LED current shifts to torch current level if $T_J$ reaches 125 °C	<b>LED Flash Brightness Level</b> 0000000 = 11 mA (Default)						
	.....						
	00010101 (0x15) = 0.257 A						
	.....						
	01111111 (0x3F) = 0.75 A						
	.....						
	01011111 (0x5F) = 1.03 A						
.....							
01100110 (0x66) = 1.2 A							
.....							
11111111 (0x7F) = 1.5 A							

**7.6.4 LED Torch Brightness Register (0x04)**

Bit 7	Bit 6	Bit 5	Bit 4	Bit 3	Bit 2	Bit 1	Bit 0
<b>RFU</b>	<b>LED Torch Brightness Levels</b> 0000000 = 2.4 mA (Default)						
	.....						
	00010101 (0x15) = 64 mA						
	.....						
	01111111 (0x3F) = 188 mA						
	.....						
	01011111 (0x5F) = 258 mA						
.....							
01100110 (0x66) = 302 mA							
.....							
11111111 (0x7F) = 376 mA							

**7.6.5 Flags Register (0x05)**

Bit 7	Bit 6	Bit 5	Bit 4	Bit 3	Bit 2	Bit 1	Bit 0
OVP Fault	IVFM Trip Flag	$V_{OUT} / V_{LED}$ Short Fault	Current Limit Flag	Thermal Current Scale-back (TSB) Flag	Thermal Shutdown (TSD) Fault	UVLO Fault	Flash Time-Out Flag

**7.6.6 Device ID and RESET Register (0x06)**

Bit 7	Bit 6	Bit 5	Bit 4	Bit 3	Bit 2	Bit 1	Bit 0
<b>Software RESET</b> 0 = Normal (default) 1 = Force device RESET	<b>RFU</b>	<b>Device ID</b> 000			<b>Silicon Revision Bits</b> 001		

## 8 Applications and Implementation

### 注

Information in the following applications sections is not part of the TI component specification, and TI does not warrant its accuracy or completeness. TI's customers are responsible for determining suitability of components for their purposes. Customers should validate and test their design implementation to confirm system functionality.

### 8.1 Application Information

The LM36010 can drive a flash LED at currents up to 1.5 A. The 2-MHz or 4-MHz DC-DC boost regulator allows for the use of small value discrete external components.

### 8.2 Typical Application

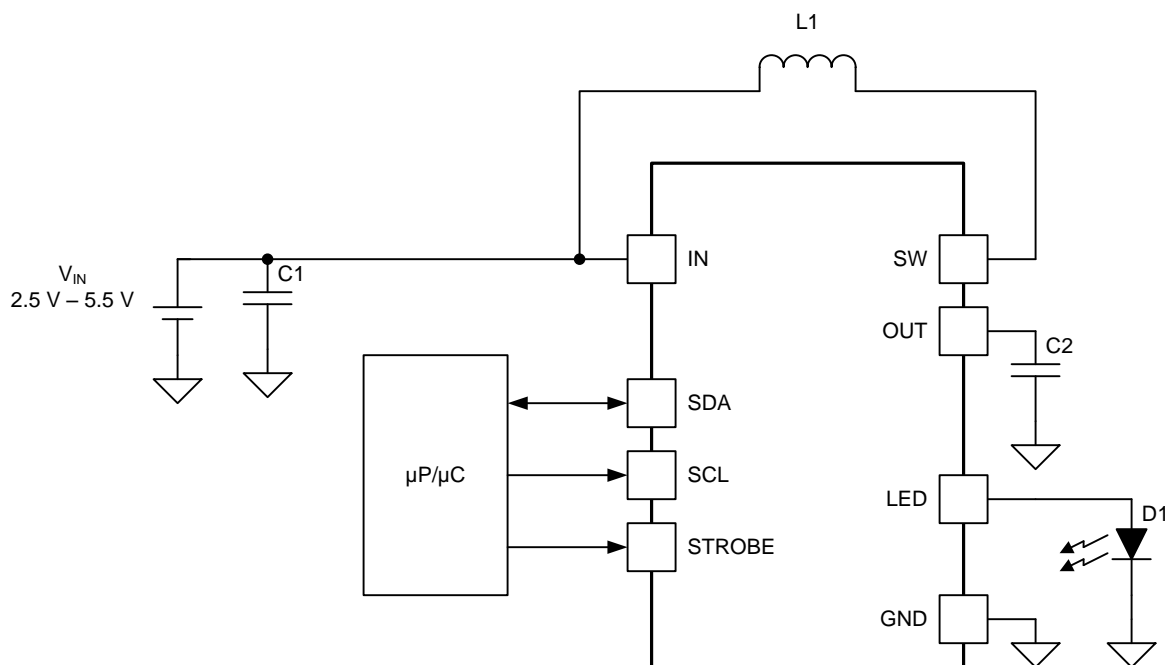

Copyright © 2016, Texas Instruments Incorporated

图 37. LM36010 Typical Application

#### 8.2.1 Design Requirements

Example requirements based on default register values:

表 1. Design Parameters

DESIGN PARAMETER	EXAMPLE VALUE
Input voltage range	2.5 V to 5.5 V
Brightness control	I <sup>2</sup> C Register
LED configuration	1 flash LED
Boost switching frequency	2 MHz (4 MHz selectable)
Flash brightness	1.5-A maximum current

## 8.2.2 Detailed Design Procedure

### 8.2.2.1 Thermal Performance

Output power is limited by three things: the peak current limit, the ambient temperature, and the maximum power dissipation in the package. If the die temperature of the device is below the absolute maximum rating of 125°C, the maximum output power can be over 6 W. However, any appreciable output current causes the internal power dissipation to increase and therefore increase the die temperature. Any circuit configuration must ensure that the die temperature remains below 125°C taking into account the ambient temperature derating. The thermal scale-back protection (TSB) helps ensure that temperature requirement is held valid. If the TSB feature is disabled, thermal shutdown (TSD) is the next level of protection for the device, which is set to 150°C. This mechanism cannot be disabled, and operation of the device above 125°C is not ensured by the electrical specification.

In boost mode, where  $V_{IN} < V_{LED} + V_{HR}$ , the power dissipation can be approximated by [公式 1](#):

$$P_{DISS} \approx \left[ \left[ \left( \frac{(V_{OUT} - V_{IN}) \times V_{OUT}}{V_{IN}^2} \right) \times I_{LED}^2 \times R_{NFET} \right] + \left[ \left( \frac{V_{OUT}}{V_{IN}} \right) \times I_{LED}^2 \times R_{PFET} \right] + (V_{HR} \times I_{LED}) \right] \quad (1)$$

When the device is in pass mode, where  $V_{IN} > V_{LED} + V_{HR}$ , the power dissipation equals:

$$P_{DISS} = \left[ (V_{IN} - V_{LED}) \times I_{LED} \right] - (I_{LED}^2 \times R_{INDUCTOR}) \quad (2)$$

Use [公式 3](#) to calculate the junction temperature ( $T_J$ ) of the device:

$$T_J = R_{\theta JA} \times P_{DISS} \quad (3)$$

Note that these equations only provide approximation of the junction temperature and do not take into account thermal time constants, which play a large role in determining maximum deliverable output power and flash durations.

### 8.2.2.2 Output Capacitor Selection

The LM36010 is designed to operate with a 10- $\mu$ F ceramic output capacitor. When the boost converter is running, the output capacitor supplies the load current during the boost converter on-time. When the NMOS switch turns off, the inductor energy is discharged through the internal PMOS switch, supplying power to the load and restoring charge to the output capacitor. This causes a sag in the output voltage during the on-time and a rise in the output voltage during the off-time. Therefore, choose the output capacitor to limit the output ripple to an acceptable level depending on load current and input or output voltage differentials and also to ensure the converter remains stable.

Larger capacitors such as a 22- $\mu$ F or capacitors in parallel can be used if lower output voltage ripple is desired. To estimate the output voltage ripple considering the ripple due to capacitor discharge ( $\Delta V_Q$ ) and the ripple due to the capacitors ESR ( $\Delta V_{ESR}$ ), use [公式 4](#) and [公式 5](#):

For continuous conduction mode, the output voltage ripple due to the capacitor discharge is:

$$\Delta V_Q = \frac{I_{LED} \times (V_{OUT} - V_{IN})}{f_{SW} \times V_{OUT} \times C_{OUT}} \quad (4)$$

The output voltage ripple due to the output capacitors ESR is found by:

$$\Delta V_{ESR} = R_{ESR} \times \left( \left( \frac{I_{LED} \times V_{OUT}}{V_{IN}} \right) + \Delta I_L \right) \Delta I_L = \frac{V_{IN} \times (V_{OUT} - V_{IN})}{2 \times f_{SW} \times L \times V_{OUT}} \quad (5)$$

In ceramic capacitors, the ESR is very low so the assumption is that 80% of the output voltage ripple is due to capacitor discharge and 20% from ESR. [表 2](#) lists different manufacturers for various output capacitors and their case sizes suitable for use with the LM36010.

### 8.2.2.3 Input Capacitor Selection

Choosing the correct size and type of input capacitor helps minimize the voltage ripple caused by the switching of the boost converter and reduces noise on the input pin of the boost converter that can feed through and disrupt internal analog signals. In the typical application circuit a 10- $\mu\text{F}$  ceramic input capacitor works well. It is important to place the input capacitor as close as possible to the LM36010 input (IN) pin. This reduces the series resistance and inductance that can inject noise into the device due to the input switching currents. 表 2 lists various input capacitors recommended for use with the LM36010.

**表 2. Recommended Input/Output Capacitors (X5R/X7R Dielectric)**

MANUFACTURER	PART NUMBER	VALUE	CASE SIZE	VOLTAGE RATING
TDK Corporation	C1608JB0J106M	10 $\mu\text{F}$	0603 (1.6 mm $\times$ 0.8 mm $\times$ 0.8 mm)	6.3 V
TDK Corporation	C2012JB1A106M	10 $\mu\text{F}$	0805 (2 mm $\times$ 1.25 mm $\times$ 1.25 mm)	10 V
Murata	GRM188R60J106M	10 $\mu\text{F}$	0603 (1.6 mm $\times$ 0.8 mm $\times$ 0.8 mm)	6.3 V
Murata	GRM21BR61A106KE19	10 $\mu\text{F}$	0805 (2 mm $\times$ 1.25 mm $\times$ 1.25 mm)	10 V

### 8.2.2.4 Inductor Selection

The LM36010 is designed to use a 0.47- $\mu\text{H}$  or 1- $\mu\text{H}$  inductor. 表 3 lists various inductors and their manufacturers that work well with the LM36010. When the device is boosting ( $V_{\text{OUT}} > V_{\text{IN}}$ ) the inductor is typically the largest area of efficiency loss in the circuit. Therefore, choosing an inductor with the lowest possible series resistance is important. Additionally, the saturation rating of the inductor must be greater than the maximum operating peak current of the LM36010. This prevents excess efficiency loss that can occur with inductors that operate in saturation. For proper inductor operation and circuit performance, ensure that the inductor saturation and the peak current limit setting of the LM36010 are greater than  $I_{\text{PEAK}}$  in 公式 6:

$$I_{\text{PEAK}} = \frac{I_{\text{LED}}}{\eta} \times \frac{V_{\text{OUT}}}{V_{\text{IN}}} + \Delta I_{\text{L}} \Delta I_{\text{L}} = \frac{V_{\text{IN}} \times (V_{\text{OUT}} - V_{\text{IN}})}{2 \times f_{\text{SW}} \times L \times V_{\text{OUT}}}$$

where

- $f_{\text{SW}} = 2$  or 4 MHz

(6)

Efficiency details can be found in the [Application Curves](#).

**表 3. Recommended Inductors**

MANUFACTURER	L	PART NUMBER	DIMENSIONS (L $\times$ W $\times$ H)	$I_{\text{SAT}}$	$R_{\text{DC}}$
TOKO	0.47 $\mu\text{H}$	DFE201610P-R470M	2 mm $\times$ 1.6 mm $\times$ 1 mm	4.1 A	32 m $\Omega$
TOKO	1 $\mu\text{H}$	DFE201610P-1R0M	2 mm $\times$ 1.6 mm $\times$ 1 mm	3.7 A	58 m $\Omega$



### 8.2.3 Application Curves

$T_A = 25^\circ\text{C}$ ,  $V_{IN} = 3.6\text{ V}$ ,  $C_{IN} = 10\ \mu\text{F}$ ,  $C_{OUT} = 10\ \mu\text{F}$ ,  $L = 1\ \mu\text{H}$ ,  $V_{LED} = 3.4\text{ V}$ , Flash Time-out = 320 ms and Thermal Scale-Back (TSB) disabled, unless otherwise noted.



图 38. LED Flash Efficiency vs Brightness Code



图 39. LED Flash Efficiency vs Brightness Code

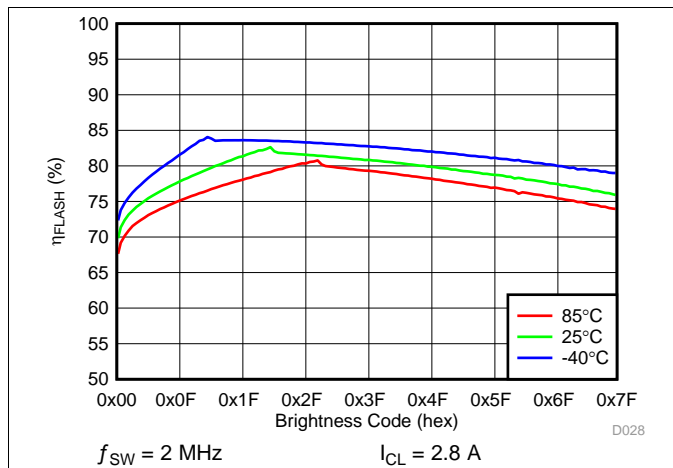

图 40. LED Flash Efficiency vs Input Voltage

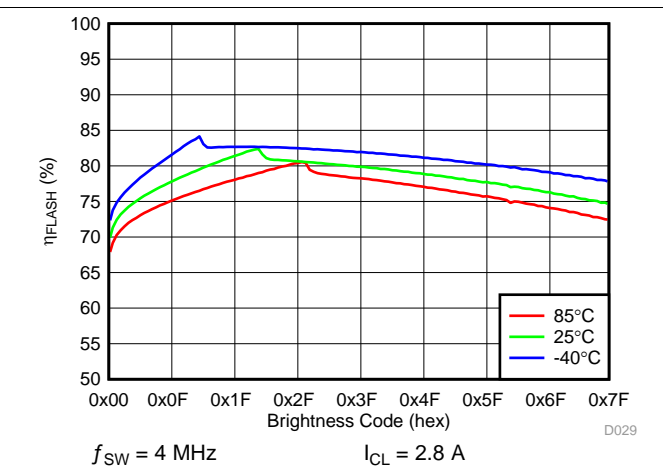

图 41. LED Flash Efficiency vs Input Voltage

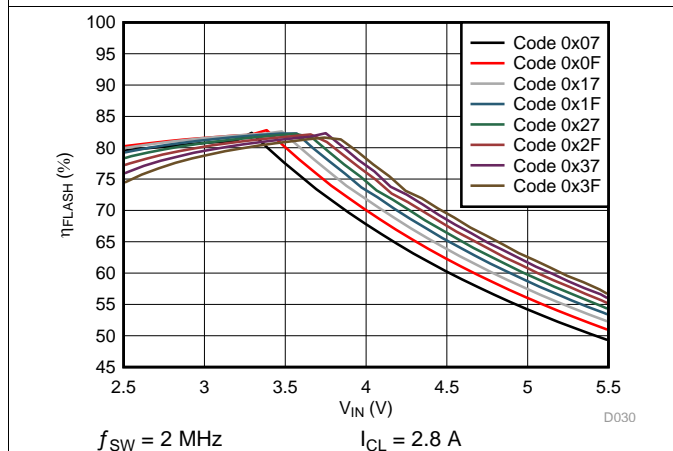

图 42. LED Flash Efficiency vs Input Voltage

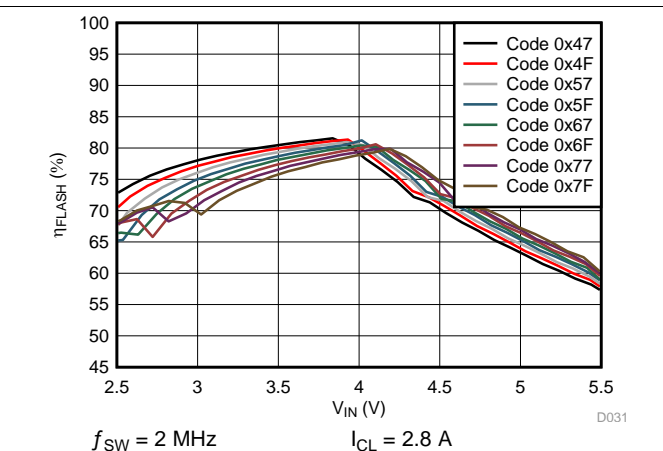

图 43. LED Flash Efficiency vs Input Voltage

$T_A = 25^\circ\text{C}$ ,  $V_{IN} = 3.6\text{ V}$ ,  $C_{IN} = 10\ \mu\text{F}$ ,  $C_{OUT} = 10\ \mu\text{F}$ ,  $L = 1\ \mu\text{H}$ ,  $V_{LED} = 3.4\text{ V}$ , Flash Time-out = 320 ms and Thermal Scale-Back (TSB) disabled, unless otherwise noted.

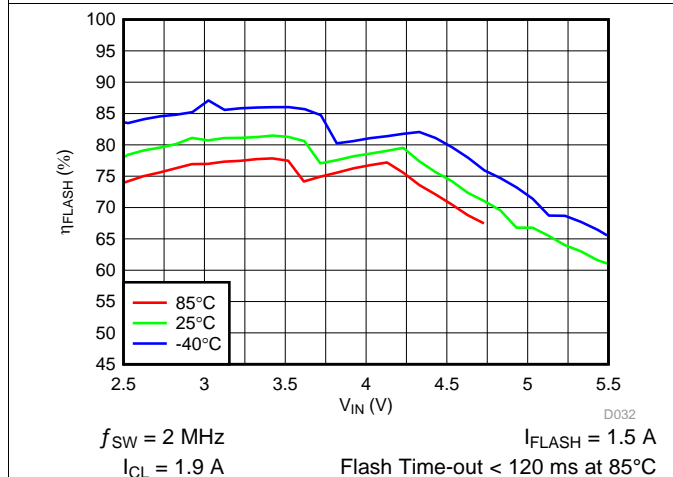

图 44. LED Flash Efficiency vs Input Voltage

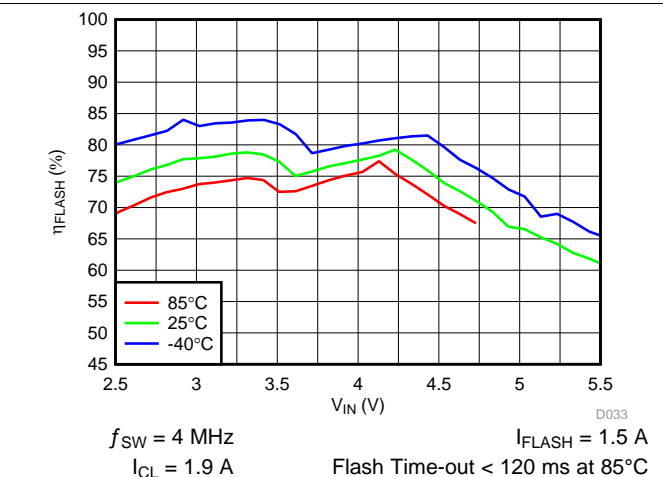

图 45. LED Flash Efficiency vs Input Voltage

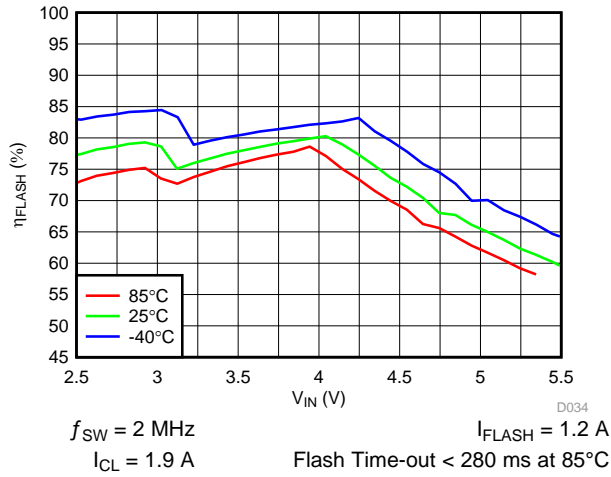

图 46. LED Flash Efficiency vs Input Voltage

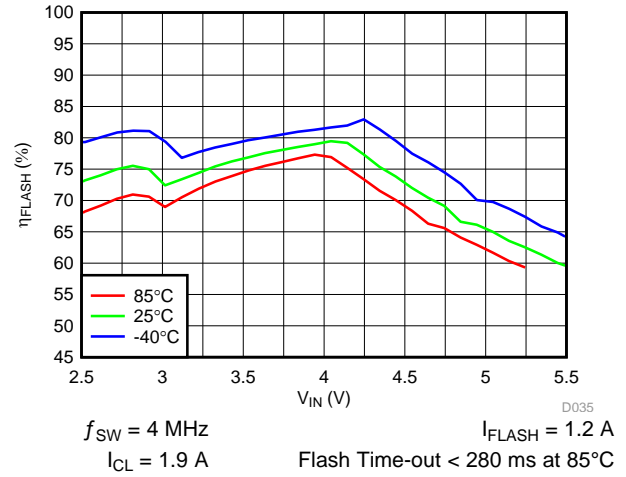

图 47. LED Flash Efficiency vs Input Voltage

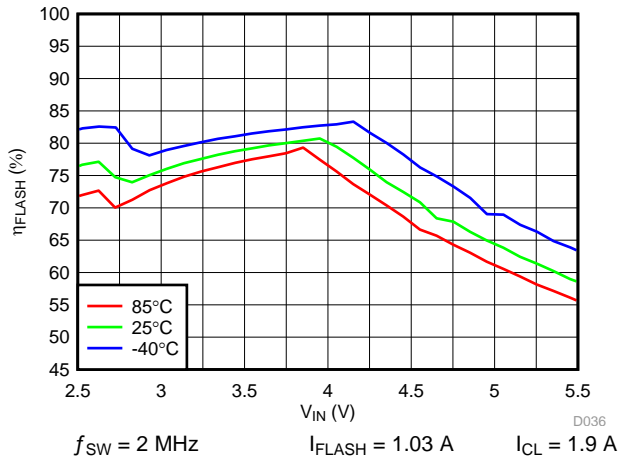

图 48. LED Flash Efficiency vs Input Voltage

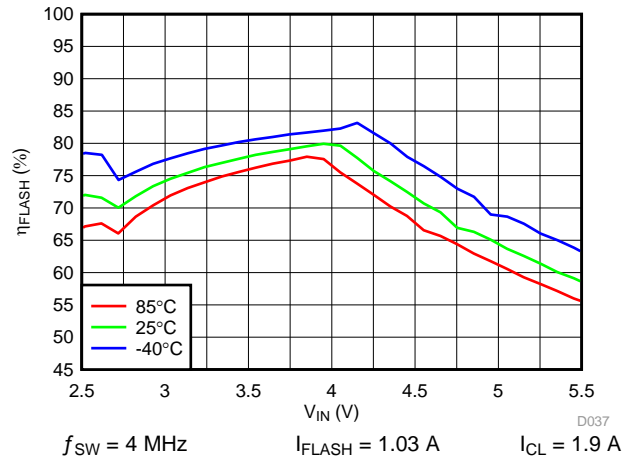

图 49. LED Flash Efficiency vs Input Voltage

$T_A = 25^\circ\text{C}$ ,  $V_{IN} = 3.6\text{ V}$ ,  $C_{IN} = 10\ \mu\text{F}$ ,  $C_{OUT} = 10\ \mu\text{F}$ ,  $L = 1\ \mu\text{H}$ ,  $V_{LED} = 3.4\text{ V}$ , Flash Time-out = 320 ms and Thermal Scale-Back (TSB) disabled, unless otherwise noted.

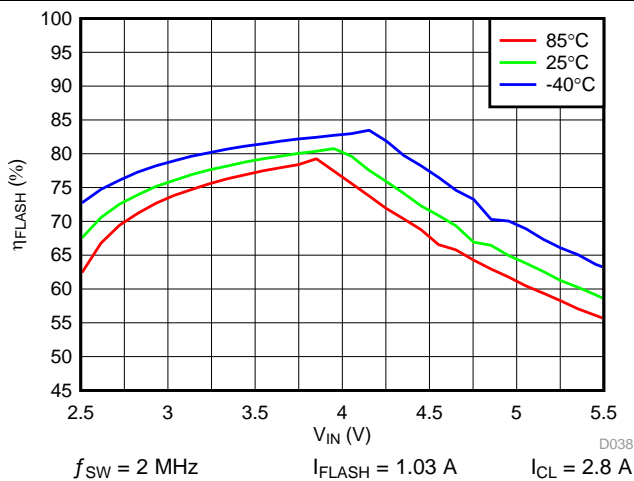

图 50. LED Flash Efficiency vs Input Voltage

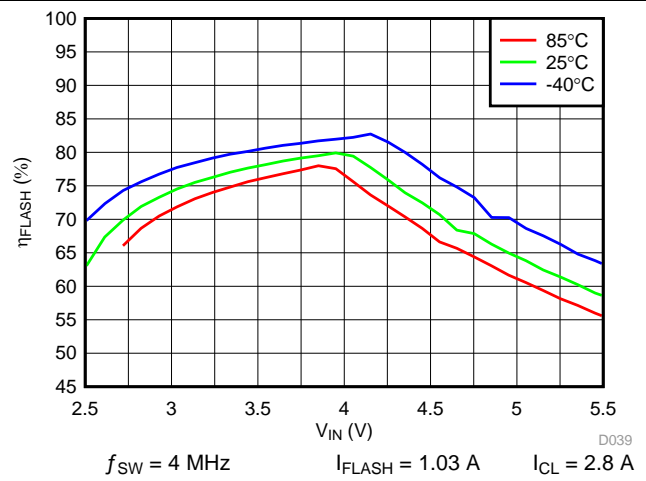

图 51. LED Flash Efficiency vs Input Voltage

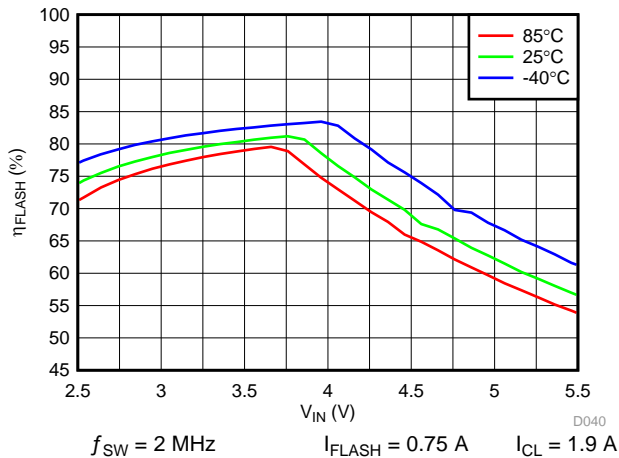

图 52. LED Flash Efficiency vs Input Voltage

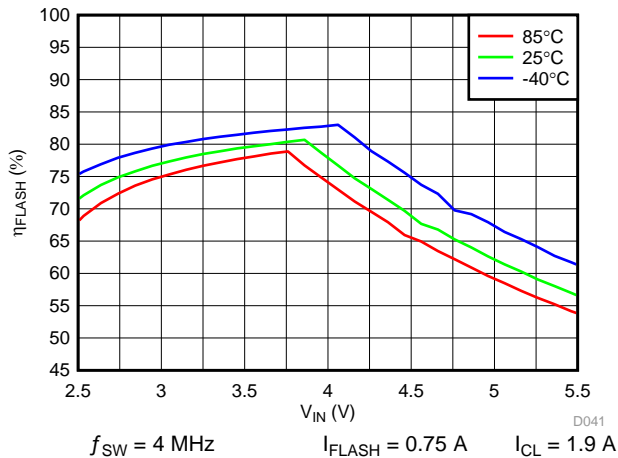

图 53. LED Flash Efficiency vs Input Voltage

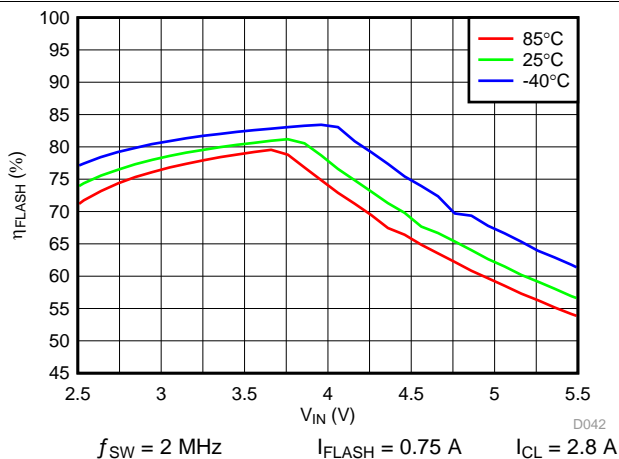

图 54. LED Torch Efficiency vs Brightness Code

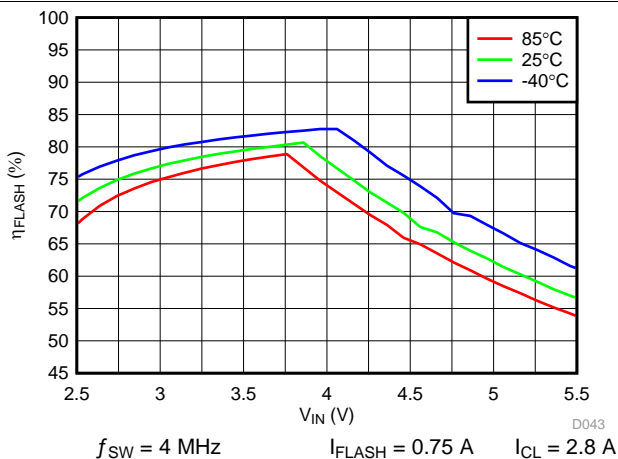

图 55. LED Torch Efficiency vs Brightness Code

$T_A = 25^\circ\text{C}$ ,  $V_{IN} = 3.6\text{ V}$ ,  $C_{IN} = 10\ \mu\text{F}$ ,  $C_{OUT} = 10\ \mu\text{F}$ ,  $L = 1\ \mu\text{H}$ ,  $V_{LED} = 3.4\text{ V}$ , Flash Time-out = 320 ms and Thermal Scale-Back (TSB) disabled, unless otherwise noted.

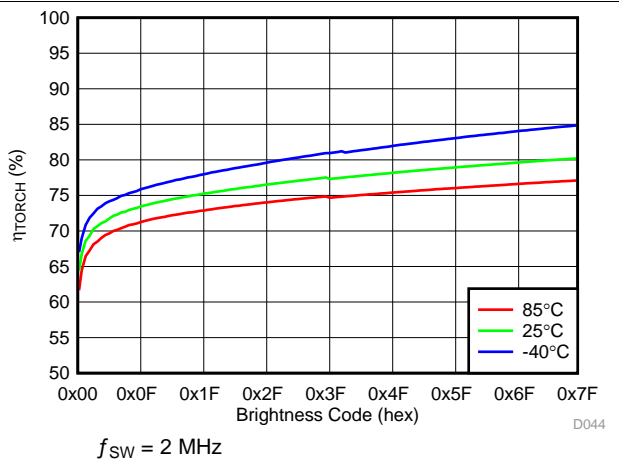

图 56. LED Torch Efficiency vs Input Voltage

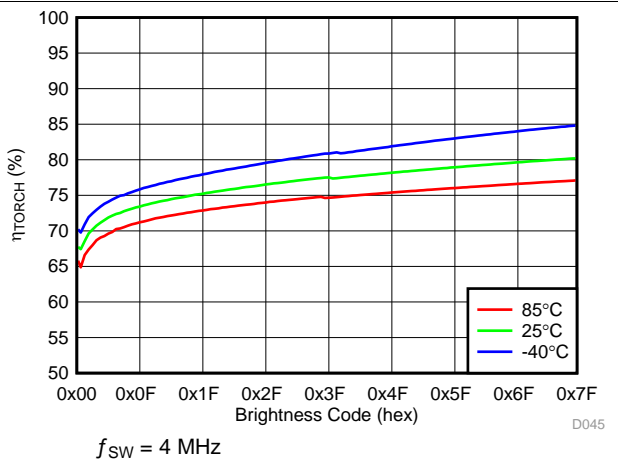

图 57. LED Torch Efficiency vs Input Voltage

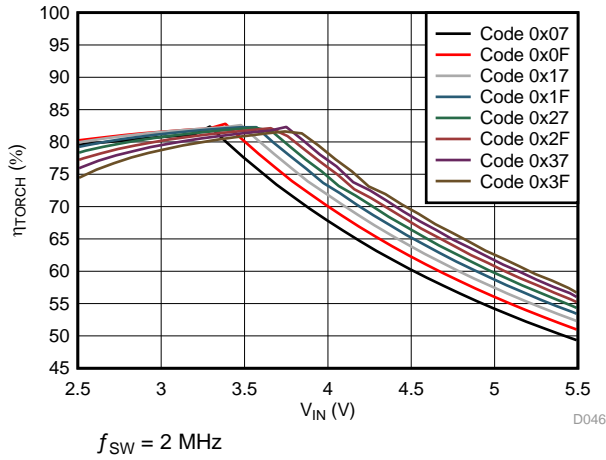

图 58. LED Torch Efficiency vs Input Voltage

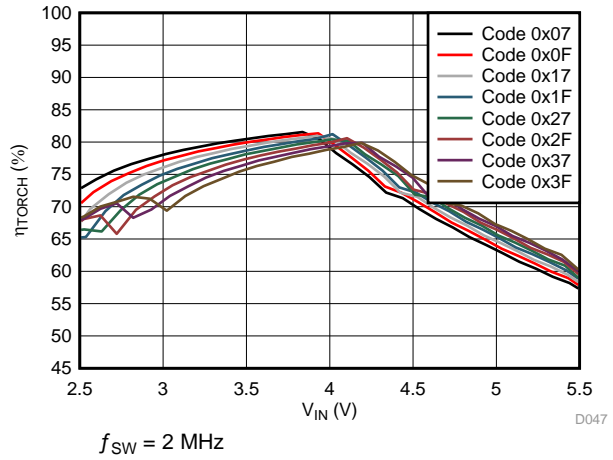

图 59. LED Torch Efficiency vs Input Voltage

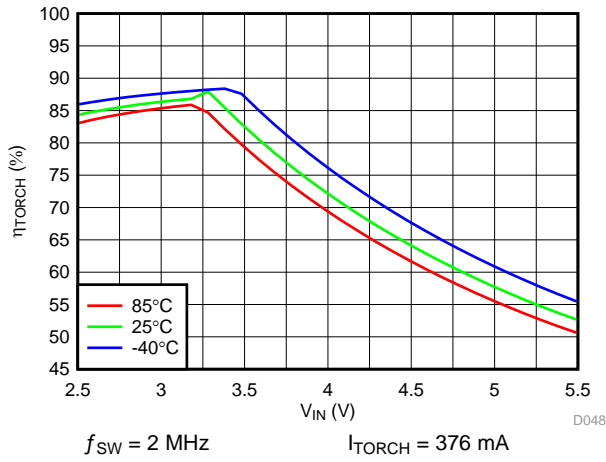

图 60. LED Torch Efficiency vs Input Voltage

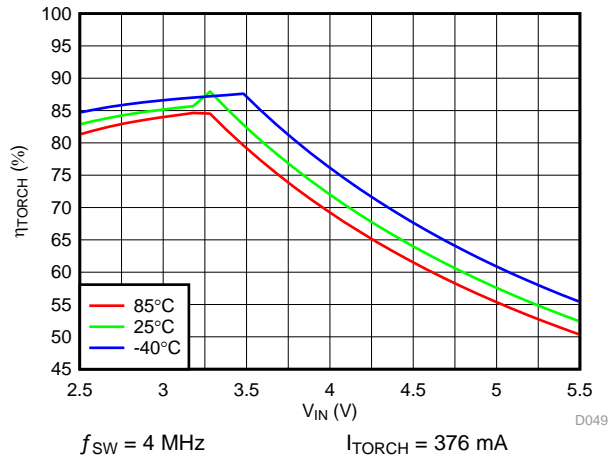

图 61. LED Torch Efficiency vs Input Voltage

$T_A = 25^\circ\text{C}$ ,  $V_{IN} = 3.6\text{ V}$ ,  $C_{IN} = 10\ \mu\text{F}$ ,  $C_{OUT} = 10\ \mu\text{F}$ ,  $L = 1\ \mu\text{H}$ ,  $V_{LED} = 3.4\text{ V}$ , Flash Time-out = 320 ms and Thermal Scale-Back (TSB) disabled, unless otherwise noted.

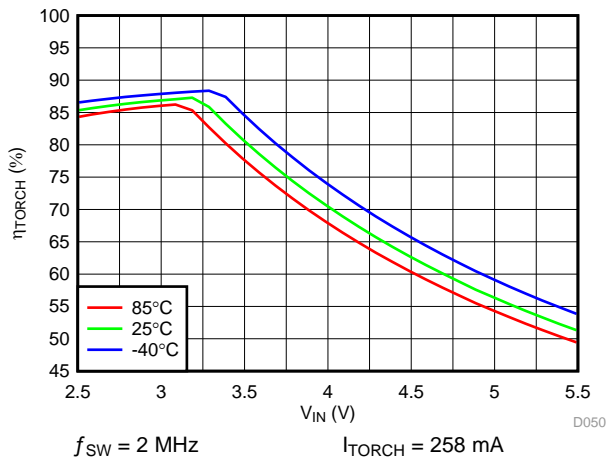

Time (400  $\mu\text{s}$ /DIV)  
Mode bits (Reg 0x01 bit[1:0]) = 11 (Flash Mode)

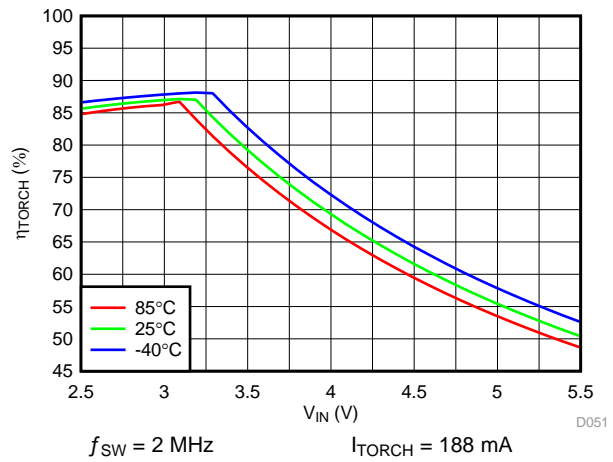
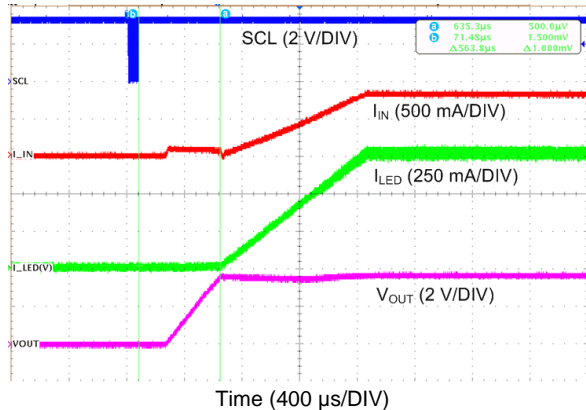
图 62. Flash Start-up with I<sup>2</sup>C

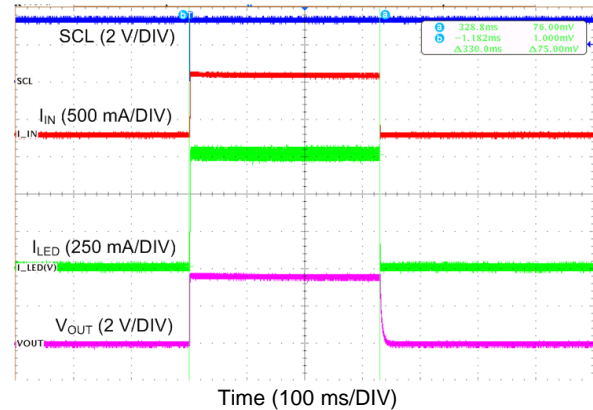

Time (100 ms/DIV)  
Flash Time-out (Reg 0x02 bits[4:1]) = 0111 (320 ms)

图 63. Flash Time-Out

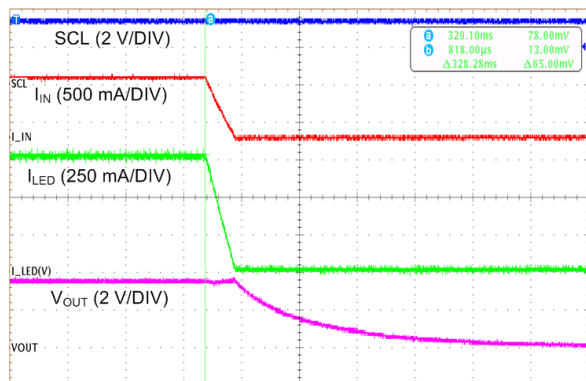

Time (2 ms/DIV)

图 64. Flash Turnoff with I<sup>2</sup>C

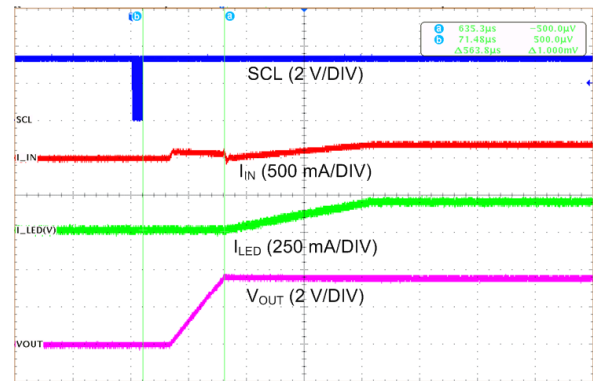

Time (400  $\mu\text{s}$ /DIV)  
Mode bits (Reg 0x01 bit[1:0]) = 10 (Torch Mode)

图 65. Torch Start-up with I<sup>2</sup>C

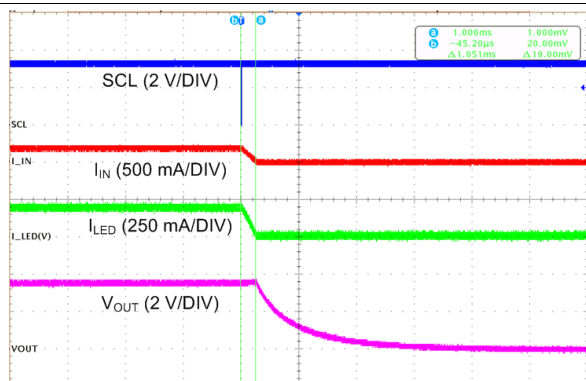

Time (4 ms/DIV)

Mode bits (Reg 0x01 bit[1:0]) = 00 (Standby Mode)

图 66. Torch Turnoff with I<sup>2</sup>C

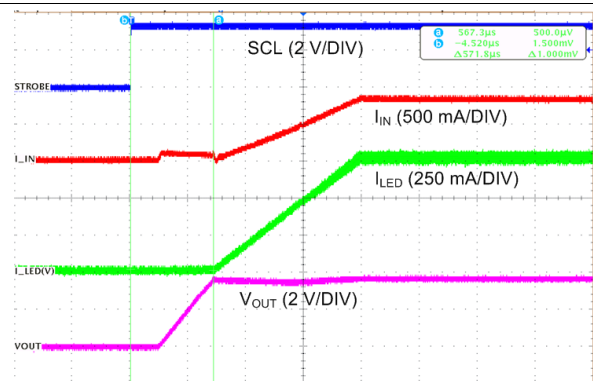

Time (400  $\mu\text{s}$ /DIV)

STROBE Enabled (Reg 0x01 bit[2] = 1)

图 67. Flash Start-up with STROBE

$T_A = 25^\circ\text{C}$ ,  $V_{IN} = 3.6\text{ V}$ ,  $C_{IN} = 10\ \mu\text{F}$ ,  $C_{OUT} = 10\ \mu\text{F}$ ,  $L = 1\ \mu\text{H}$ ,  $V_{LED} = 3.4\text{ V}$ , Flash Time-out = 320 ms and Thermal Scale-Back (TSB) disabled, unless otherwise noted.



图 68. Flash Turnoff with Level Triggered STROBE

图 69. Flash Turnoff with Edge Triggered STROBE

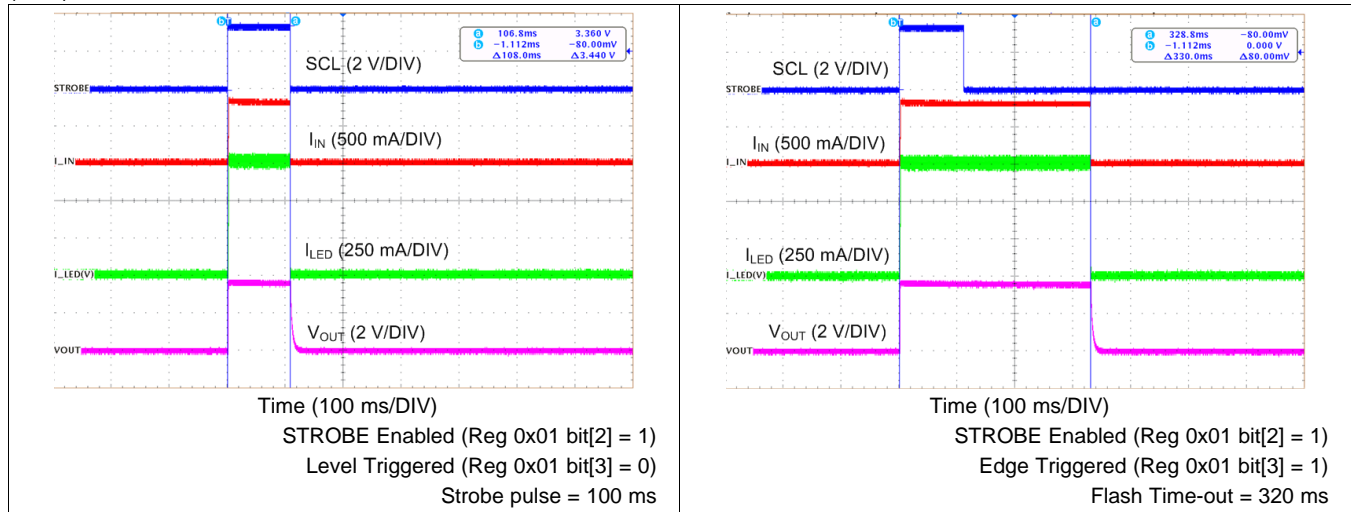

图 70. Boost I<sup>2</sup>C Torch

图 71. Boost I<sup>2</sup>C Flash

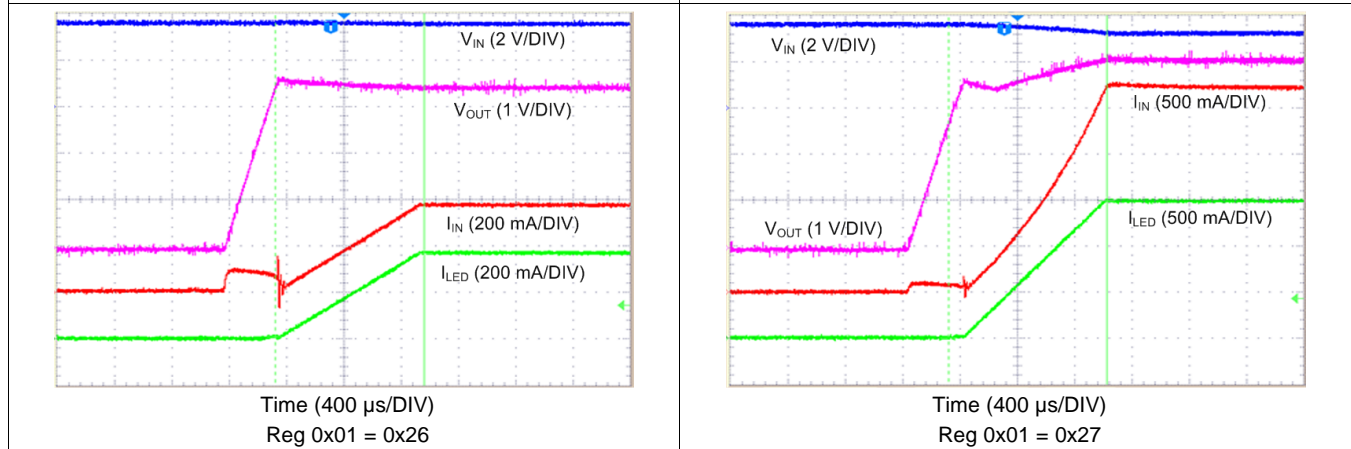

图 72. Boost Edge Triggered Flash

图 73. Boost Level Triggered Flash

$T_A = 25^\circ\text{C}$ ,  $V_{IN} = 3.6\text{ V}$ ,  $C_{IN} = 10\ \mu\text{F}$ ,  $C_{OUT} = 10\ \mu\text{F}$ ,  $L = 1\ \mu\text{H}$ ,  $V_{LED} = 3.4\text{ V}$ , Flash Time-out = 320 ms and Thermal Scale-Back (TSB) disabled, unless otherwise noted.

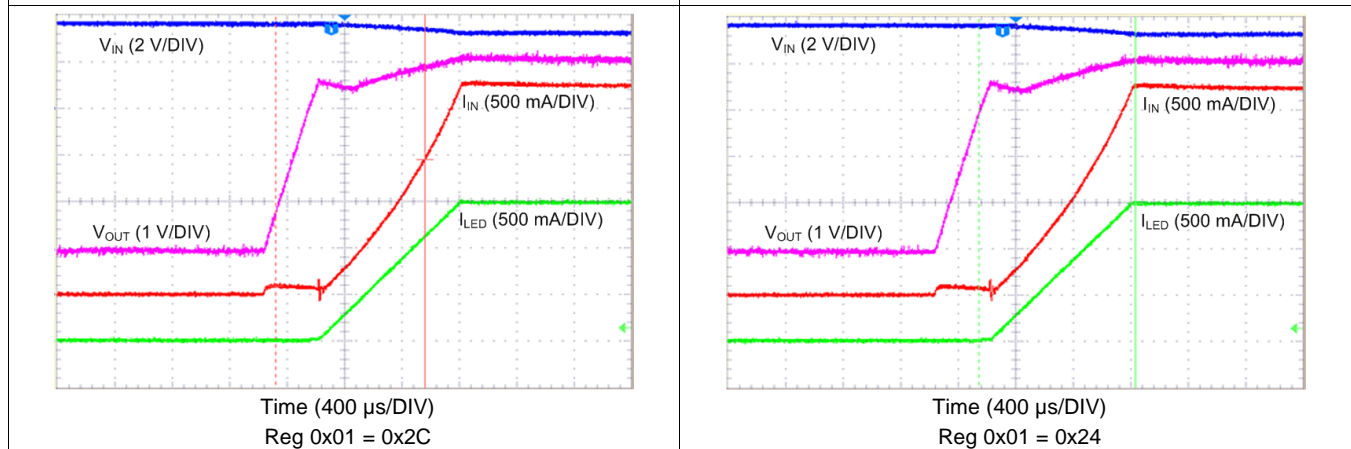
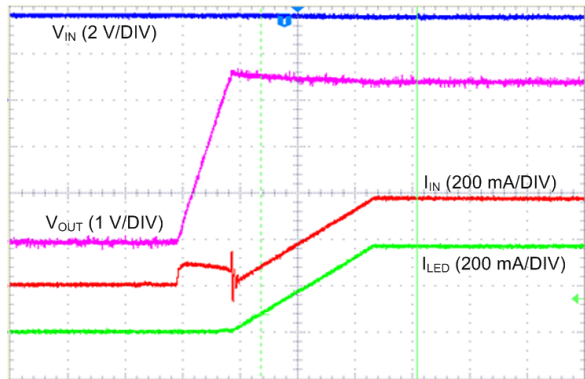

Time (400  $\mu\text{s}$ /DIV)  
Reg 0x01 = 0xA6

图 74. Pass Mode I<sup>2</sup>C Torch

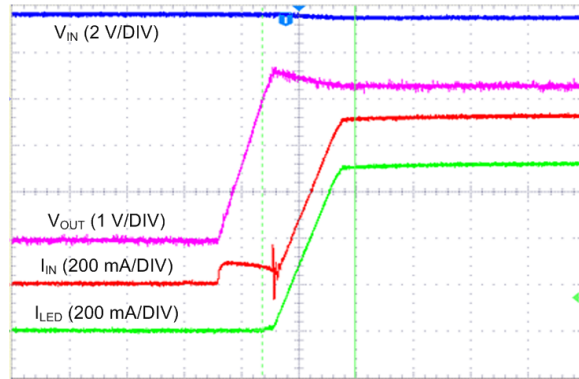

Time (400  $\mu\text{s}$ /DIV)  
Reg 0x01 = 0xA7

图 75. Pass Mode I<sup>2</sup>C Flash

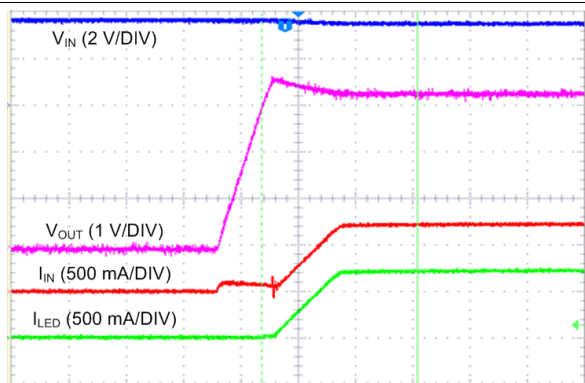

Time (400  $\mu\text{s}$ /DIV)  
Reg 0x01 = 0xA4

图 76. Pass mode Edge Triggered Flash

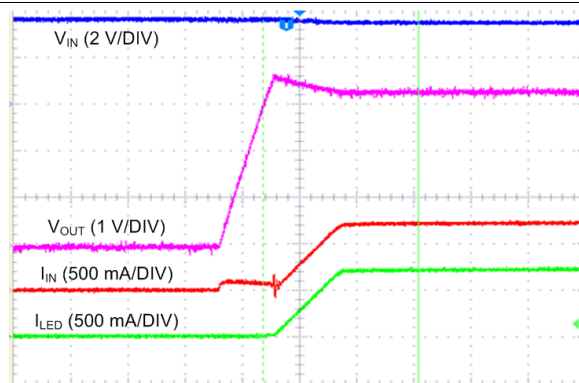

Time (400  $\mu\text{s}$ /DIV)  
Reg 0x01 = 0xA4

图 77. Pass mode Level Triggered Flash

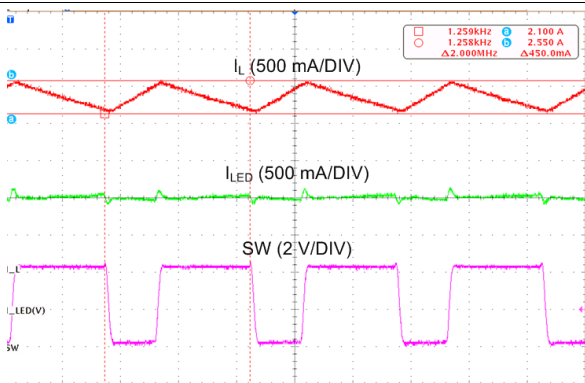

Time (200 ns/DIV)  
 $f_{SW} = 2\text{ MHz}$

图 78. Inductor Current and Switch node (SW) Waveform

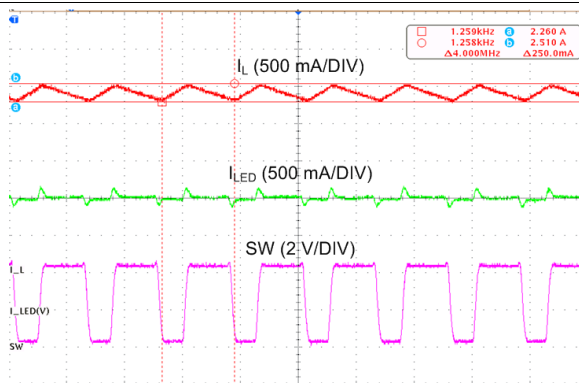

Time (200 ns/DIV)  
 $f_{SW} = 4\text{ MHz}$

图 79. Inductor Current and Switch node (SW) Waveform

**LM36010**

ZHCSGJ8B –APRIL 2017–REVISED OCTOBER 2017

www.ti.com.cn

$T_A = 25^\circ\text{C}$ ,  $V_{IN} = 3.6\text{ V}$ ,  $C_{IN} = 10\ \mu\text{F}$ ,  $C_{OUT} = 10\ \mu\text{F}$ ,  $L = 1\ \mu\text{H}$ ,  $V_{LED} = 3.4\text{ V}$ , Flash Time-out = 320 ms and Thermal Scale-Back (TSB) disabled, unless otherwise noted.

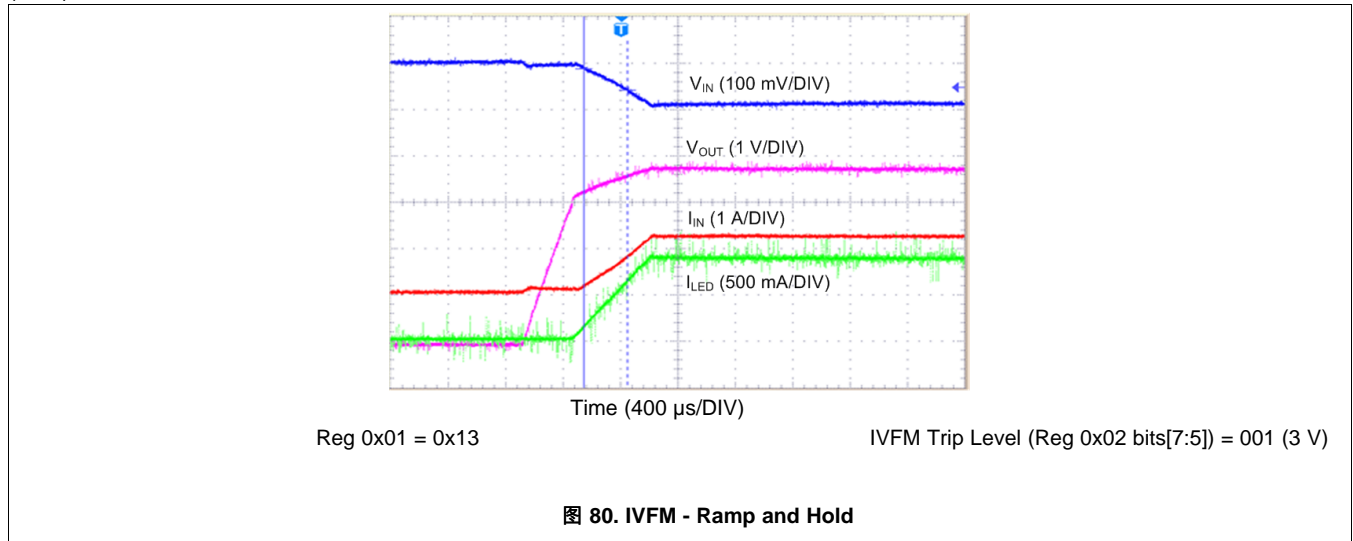



## 9 Power Supply Recommendations

The LM36010 is designed to operate from an input voltage supply range between 2.5 V and 5.5 V. This input supply must be well regulated and capable to supply the required input current. If the input supply is located far from the LM36010 additional bulk capacitance may be required in addition to the ceramic bypass capacitors.

## 10 Layout

### 10.1 Layout Guidelines

The high switching frequency and large switching currents of the LM36010 make the choice of layout important. The following steps are to be used as a reference to ensure the device is stable and maintains proper LED current regulation across its intended operating voltage and current range.

1. Place  $C_{IN}$  on the top layer (same layer as the LM36010) and as close as possible to the device. The input capacitor conducts the driver currents during the low-side MOSFET turnon and turnoff and can detect current spikes over 1 A in amplitude. Connecting the input capacitor through short, wide traces to both the IN and GND pins reduces the inductive voltage spikes that occur during switching which can corrupt the  $V_{IN}$  line.
2. Place  $C_{OUT}$  on the top layer (same layer as the LM36010) and as close as possible to the OUT and GND pins. The returns for both  $C_{IN}$  and  $C_{OUT}$  must come together at one point, as close as possible to the GND pin. Connecting  $C_{OUT}$  through short, wide traces reduce the series inductance on the OUT and GND pins that can corrupt the  $V_{OUT}$  and GND lines and cause excessive noise in the device and surrounding circuitry.
3. Connect the inductor on the top layer close to the SW pin. There must be a low-impedance connection from the inductor to SW due to the large DC inductor current, and at the same time the area occupied by the SW node must be small so as to reduce the capacitive coupling of the high  $dV/dT$  present at SW that can couple into nearby traces.
4. Avoid routing logic traces near the SW node so as to avoid any capacitively coupled voltages from SW onto any high-impedance logic lines such as STROBE, SDA, and SCL. A good approach is to insert an inner layer GND plane underneath the SW node and between any nearby routed traces. This creates a shield from the electric field generated at SW.
5. Terminate the flash LED cathode directly to the GND pin of the LM36010. If possible, route the LED return with a dedicated path so as to keep the high amplitude LED current out of the GND plane. For a flash LED that is routed relatively far away from the LM36010, a good approach is to sandwich the forward and return current paths over the top of each other on two layers. This helps reduce the inductance of the LED current path.

## 10.2 Layout Example



图 81. LM36010 Layout Example

## 11 器件和文档支持

### 11.1 器件支持

#### 11.1.1 Third-Party Products Disclaimer

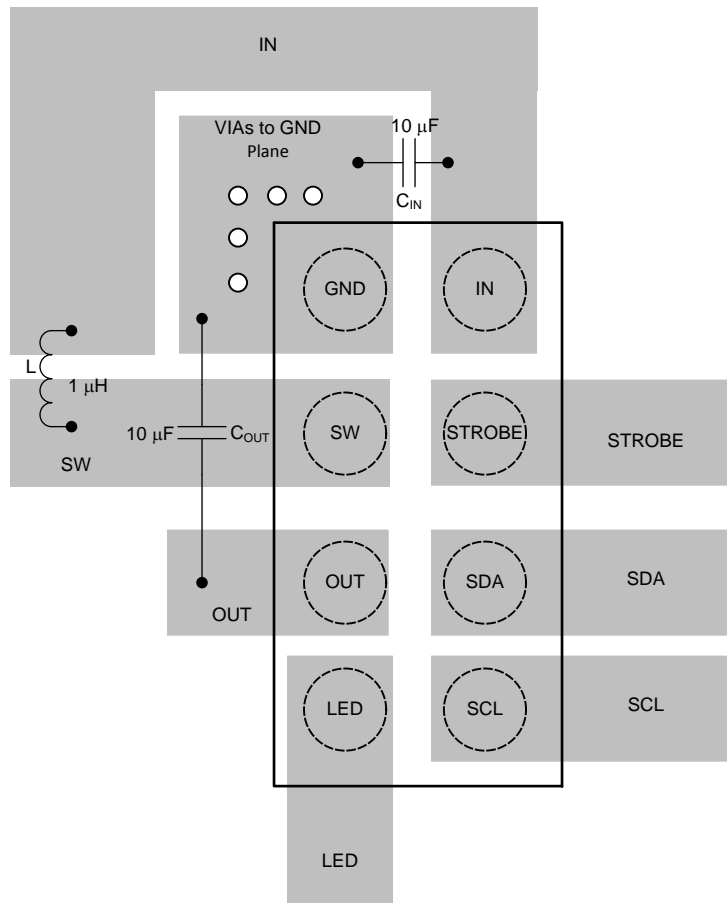
TI'S PUBLICATION OF INFORMATION REGARDING THIRD-PARTY PRODUCTS OR SERVICES DOES NOT CONSTITUTE AN ENDORSEMENT REGARDING THE SUITABILITY OF SUCH PRODUCTS OR SERVICES OR A WARRANTY, REPRESENTATION OR ENDORSEMENT OF SUCH PRODUCTS OR SERVICES, EITHER ALONE OR IN COMBINATION WITH ANY TI PRODUCT OR SERVICE.

### 11.2 文档支持

#### 11.2.1 相关文档

相关文档如下：

[AN-1112 DSBGA 晶圆级芯片级封装](#)

### 11.3 接收文档更新通知

要接收文档更新通知，请转至 [TI.com](http://TI.com) 上的器件产品文件夹。单击右上角的 [通知我](#) 进行注册，即可每周接收产品信息更改摘要。有关更改的详细信息，请查看任何已修订文档中包含的修订历史记录。

### 11.4 社区资源

下列链接提供到 TI 社区资源的连接。链接的内容由各个分销商“按照原样”提供。这些内容并不构成 TI 技术规范，并且不一定反映 TI 的观点；请参阅 TI 的 [《使用条款》](#)。

**TI E2E™ 在线社区** [TI 的工程师对工程师 \(E2E\) 社区](#)。此社区的创建目的在于促进工程师之间的协作。在 [e2e.ti.com](http://e2e.ti.com) 中，您可以咨询问题、分享知识、拓展思路并与同行工程师一道帮助解决问题。

**设计支持** [TI 参考设计支持](#) 可帮助您快速查找有帮助的 E2E 论坛、设计支持工具以及技术支持的联系信息。

### 11.5 商标

E2E is a trademark of Texas Instruments.  
All other trademarks are the property of their respective owners.

### 11.6 静电放电警告



ESD 可能会损坏该集成电路。德州仪器 (TI) 建议通过适当的预防措施处理所有集成电路。如果不遵守正确的处理措施和安装程序，可能会损坏集成电路。

ESD 的损坏小至导致微小的性能降级，大至整个器件故障。精密的集成电路可能更容易受到损坏，这是因为非常细微的参数更改都可能会导致器件与其发布的规格不相符。

### 11.7 Glossary

[SLYZ022](#) — *TI Glossary*.

This glossary lists and explains terms, acronyms, and definitions.

## 12 机械、封装和可订购信息

以下页面包含机械、封装和可订购信息。这些信息是指定器件的最新可用数据。这些数据如有变更，恕不另行通知和修订此文档。如欲获取此产品说明书的浏览器版本，请参阅左侧的导航。

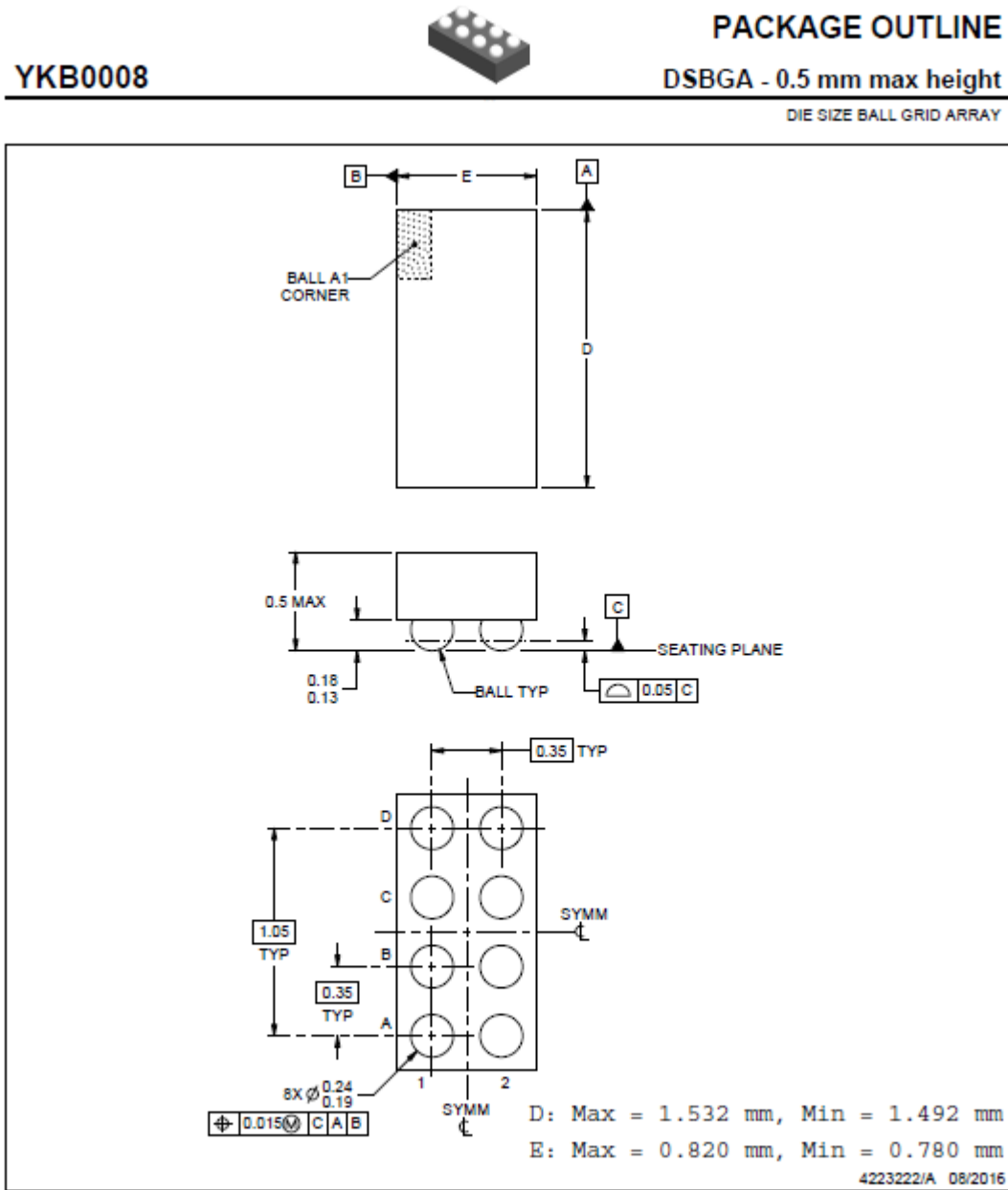

NOTES:

1. All linear dimensions are in millimeters. Any dimensions in parenthesis are for reference only. Dimensioning and tolerancing per ASME Y14.5M.
2. This drawing is subject to change without notice.

## EXAMPLE BOARD LAYOUT

YKB0008

DSBGA - 0.5 mm max height

DIE SIZE BALL GRID ARRAY

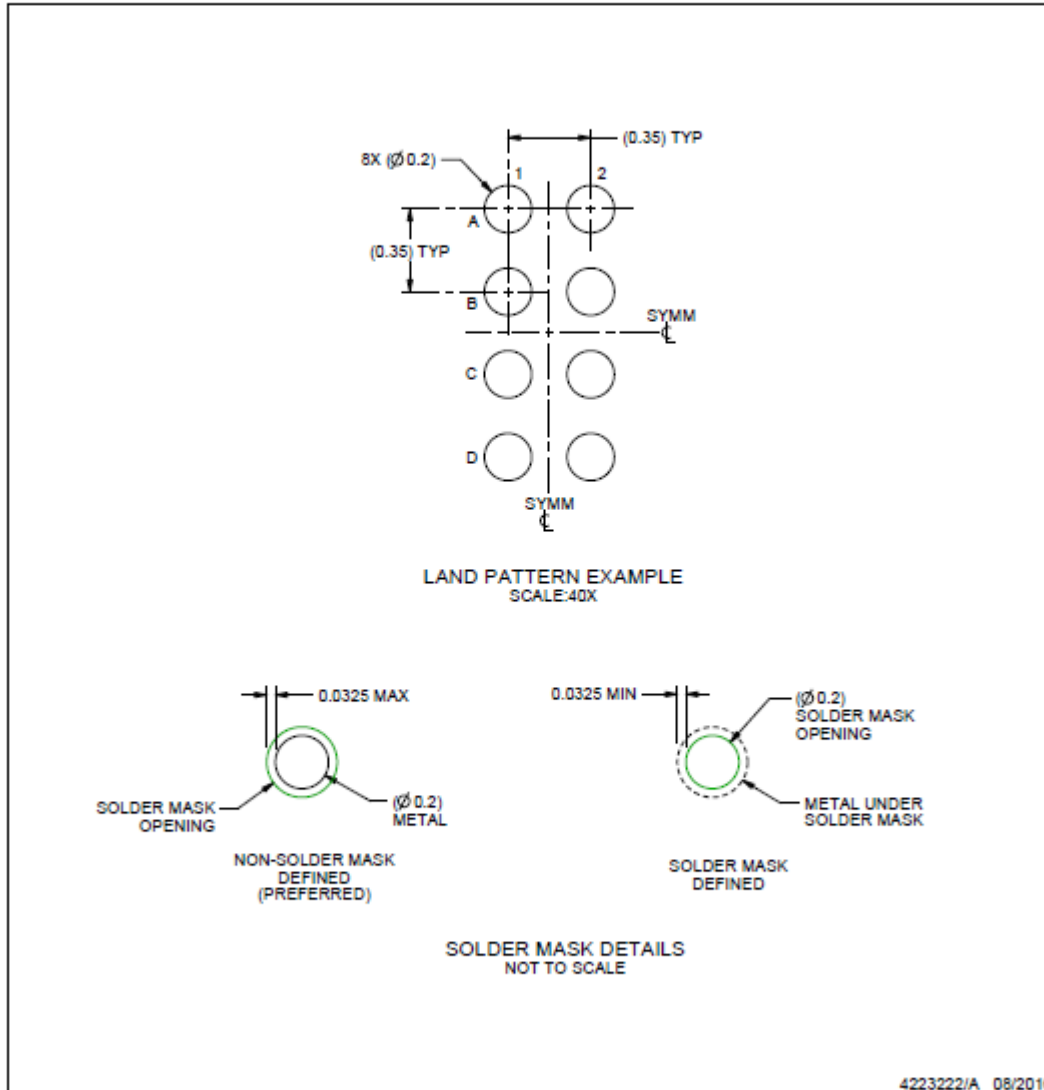

NOTES: (continued)

- Final dimensions may vary due to manufacturing tolerance considerations and also routing constraints. For more information, see Texas Instruments literature number SNVA009 ([www.ti.com/lit/snva009](http://www.ti.com/lit/snva009)).

EXAMPLE STENCIL DESIGN

YKB0008

DSBGA - 0.5 mm max height

DIE SIZE BALL GRID ARRAY

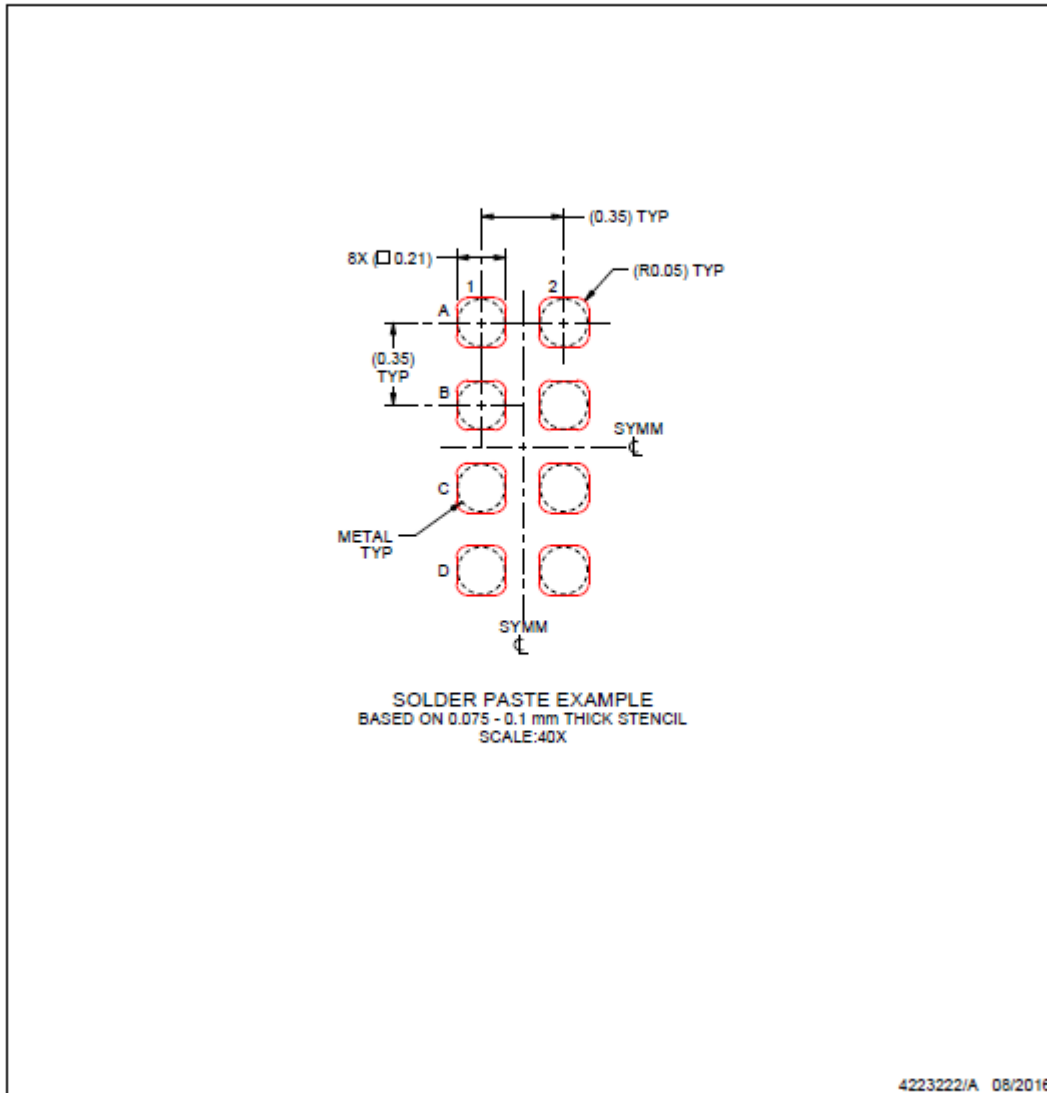

NOTES: (continued)

4. Laser cutting apertures with trapezoidal walls and rounded corners may offer better paste release.

**PACKAGING INFORMATION**

Orderable Device	Status (1)	Package Type	Package Drawing	Pins	Package Qty	Eco Plan (2)	Lead finish/ Ball material (6)	MSL Peak Temp (3)	Op Temp (°C)	Device Marking (4/5)	Samples
LM36010YKBR	ACTIVE	DSBGA	YKB	8	3000	RoHS & Green	SAC396   SNAGCU	Level-1-260C-UNLIM	-40 to 85	6010	<b>Samples</b>

(1) The marketing status values are defined as follows:

**ACTIVE:** Product device recommended for new designs.

**LIFEBUY:** TI has announced that the device will be discontinued, and a lifetime-buy period is in effect.

**NRND:** Not recommended for new designs. Device is in production to support existing customers, but TI does not recommend using this part in a new design.

**PREVIEW:** Device has been announced but is not in production. Samples may or may not be available.

**OBSOLETE:** TI has discontinued the production of the device.

(2) **RoHS:** TI defines "RoHS" to mean semiconductor products that are compliant with the current EU RoHS requirements for all 10 RoHS substances, including the requirement that RoHS substance do not exceed 0.1% by weight in homogeneous materials. Where designed to be soldered at high temperatures, "RoHS" products are suitable for use in specified lead-free processes. TI may reference these types of products as "Pb-Free".

**RoHS Exempt:** TI defines "RoHS Exempt" to mean products that contain lead but are compliant with EU RoHS pursuant to a specific EU RoHS exemption.

**Green:** TI defines "Green" to mean the content of Chlorine (Cl) and Bromine (Br) based flame retardants meet JS709B low halogen requirements of <=1000ppm threshold. Antimony trioxide based flame retardants must also meet the <=1000ppm threshold requirement.

(3) MSL, Peak Temp. - The Moisture Sensitivity Level rating according to the JEDEC industry standard classifications, and peak solder temperature.

(4) There may be additional marking, which relates to the logo, the lot trace code information, or the environmental category on the device.

(5) Multiple Device Markings will be inside parentheses. Only one Device Marking contained in parentheses and separated by a "-" will appear on a device. If a line is indented then it is a continuation of the previous line and the two combined represent the entire Device Marking for that device.

(6) Lead finish/Ball material - Orderable Devices may have multiple material finish options. Finish options are separated by a vertical ruled line. Lead finish/Ball material values may wrap to two lines if the finish value exceeds the maximum column width.

**Important Information and Disclaimer:**The information provided on this page represents TI's knowledge and belief as of the date that it is provided. TI bases its knowledge and belief on information provided by third parties, and makes no representation or warranty as to the accuracy of such information. Efforts are underway to better integrate information from third parties. TI has taken and continues to take reasonable steps to provide representative and accurate information but may not have conducted destructive testing or chemical analysis on incoming materials and chemicals. TI and TI suppliers consider certain information to be proprietary, and thus CAS numbers and other limited information may not be available for release.

In no event shall TI's liability arising out of such information exceed the total purchase price of the TI part(s) at issue in this document sold by TI to Customer on an annual basis.

## 重要声明和免责声明

TI 均以“原样”提供技术性 & 可靠性数据（包括数据表）、设计资源（包括参考设计）、应用或其他设计建议、网络工具、安全信息和其他资源，不保证其中不含任何瑕疵，且不做任何明示或暗示的担保，包括但不限于对适销性、适合某特定用途或不侵犯任何第三方知识产权的暗示担保。

所述资源可供专业开发人员应用 TI 产品进行设计使用。您将对以下行为独自承担全部责任：(1) 针对您的应用选择合适的 TI 产品；(2) 设计、验证并测试您的应用；(3) 确保您的应用满足相应标准以及任何其他安全、安保或其他要求。所述资源如有变更，恕不另行通知。TI 对您使用所述资源的授权仅限于开发资源所涉及 TI 产品的相关应用。除此之外不得复制或展示所述资源，也不提供其它 TI 或任何第三方的知识产权授权许可。如因使用所述资源而产生任何索赔、赔偿、成本、损失及债务等，TI 对此概不负责，并且您须赔偿由此对 TI 及其代表造成的损害。

TI 所提供产品均受 TI 的销售条款 (<http://www.ti.com.cn/zh-cn/legal/termsofsale.html>) 以及 [ti.com.cn](http://www.ti.com.cn) 上或随附 TI 产品提供的其他可适用条款的约束。TI 提供所述资源并不扩展或以其他方式更改 TI 针对 TI 产品所发布的可适用的担保范围或担保免责声明。

邮寄地址：上海市浦东新区世纪大道 1568 号中建大厦 32 楼，邮政编码：200122  
Copyright © 2020 德州仪器半导体技术（上海）有限公司