

TPS563249 17V、3A、恒定 1.4MHz 同步降压稳压器

1 特性

- 在 3A 转换器集成了 70mΩ 和 30mΩ FET
- D-CAP3™ 模式控制，用于快速瞬态响应
- 输入电压范围：4.5V 至 17V
- 输出电压范围：0.6V 至 7V
- 强制连续导通模式
- 恒定 1.4MHz 开关频率
- 低关断电流（低于 10μA）
- 1% 反馈电压精度 (25°C)
- 从预偏置输出电压中启动
- 逐周期过流限制
- 断续模式过流保护
- 非锁存欠压保护 (UVP) 和热关断 (TSD) 保护
- 固定软启动时间：1.7ms

2 应用

- 宽带调制解调器
- 接入点网络
- 无线路由器
- 安全监控
- 电视、机顶盒

3 说明

TPS563249 是一款采用 SOT-23 封装的简单易用型 3A 同步降压转换器。

该器件经过优化，最大限度地减少了运行所需的外部组件并可实现低待机电流。

此开关稳压器采用 D-CAP3 模式控制，能够提供快速瞬态响应，并且在无需外部补偿组件的情况下支持诸如高分子聚合物等低等效串联电阻 (ESR) 输出电容以及超低 ESR 陶瓷电容器。

TPS563249 采用强制连续导通模式 (FCCM) 运行，在轻载工作期间保持固定的 1.4MHz 开关频率，并可消除系统干扰。TPS563249 采用 6 引脚 1.6mm x 2.9mm SOT (DDC) 封装，额定结温范围为 -40°C 至 125°C。

器件信息⁽¹⁾

器件型号	封装	封装尺寸 (标称值)
TPS563249	SOT-23-THIN (6)	1.60mm x 2.90mm

(1) 如需了解所有可用封装，请参阅产品说明书末尾的可订购产品附录。

简化原理图

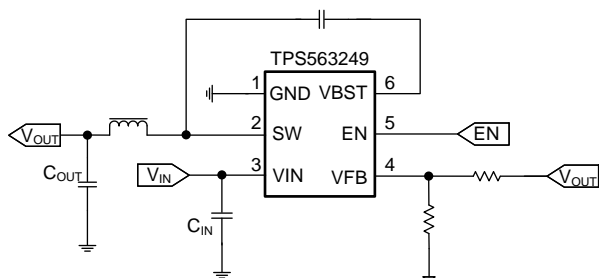

TPS563249 效率

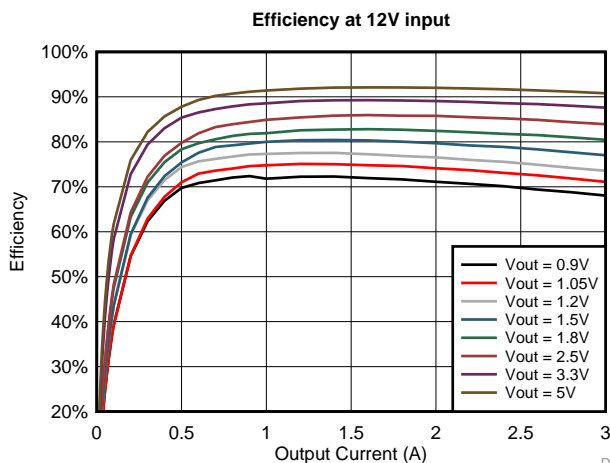

D001



目录

1	特性	1	7.4	Device Functional Modes	11
2	应用	1	8	Application and Implementation	12
3	说明	1	8.1	Application Information	12
4	修订历史记录	2	8.2	Typical Application	12
5	Pin Configuration and Functions	3	9	Power Supply Recommendations	16
6	Specifications	4	10	Layout	17
6.1	Absolute Maximum Ratings	4	10.1	Layout Guidelines	17
6.2	ESD Ratings	4	10.2	Layout Example	17
6.3	Recommended Operating Conditions	4	11	器件和文档支持	18
6.4	Thermal Information	4	11.1	接收文档更新通知	18
6.5	Electrical Characteristics	5	11.2	社区资源	18
6.6	Typical Characteristics	6	11.3	商标	18
7	Detailed Description	9	11.4	静电放电警告	18
7.1	Overview	9	11.5	术语表	18
7.2	Functional Block Diagram	9	12	机械、封装和可订购信息	18
7.3	Feature Description	9			

4 修订历史记录

注：之前版本的页码可能与当前版本有所不同。

日期	修订版本	说明
2018 年 12 月	*	初始发行版。

5 Pin Configuration and Functions

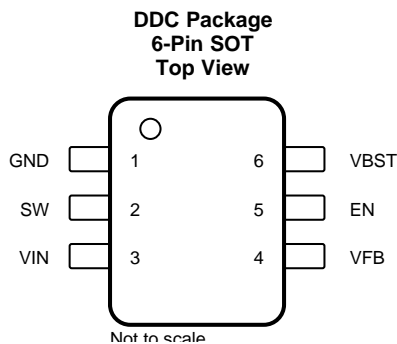

Pin Functions

PIN		I/O	DESCRIPTION
NAME	NO.		
EN	5	I	Enable input control. Active high and must be pulled up to enable the device.
GND	1	—	Ground pin Source terminal of low-side power NFET as well as the ground terminal for controller circuit. Connect sensitive VFB to this GND at a single point.
SW	2	O	Switch node connection between high-side NFET and low-side NFET.
VBST	6	O	Supply input for the high-side NFET gate drive circuit. Connect 0.1 μ F capacitor between VBST and SW pins.
VFB	4	I	Converter feedback input. Connect to output voltage with feedback resistor divider.
VIN	3	I	Input voltage supply pin. The drain terminal of high-side power NFET.

6 Specifications

6.1 Absolute Maximum Ratings

over operating free-air temperature range (unless otherwise noted)⁽¹⁾

		MIN	MAX	UNIT
Input voltage	V _{IN}	-0.3	19	V
	VBST	-0.3	24.5	V
	VBST (10 ns transient)	-0.3	26.5	V
	VBST (vs SW)	-0.3	5.5	V
	VFB	-0.3	5.5	V
	SW	-2	19	V
	SW (10 ns transient)	-3.5	21	V
	EN	-0.3	V _{IN} + 0.3	V
Operating junction temperature, T _J		-40	150	°C
Storage temperature, T _{stg}		-55	150	°C

(1) Stresses beyond those listed under *Absolute Maximum Ratings* may cause permanent damage to the device. These are stress ratings only, which do not imply functional operation of the device at these or any other conditions beyond those indicated under *Recommended Operating Conditions*. Exposure to absolute-maximum-rated conditions for extended periods may affect device reliability.

6.2 ESD Ratings

			VALUE	UNIT
V _(ESD)	Electrostatic discharge	Human-body model (HBM), per ANSI/ESDA/JEDEC JS-001 ⁽¹⁾	±2000	V
		Charged-device model (CDM), per JEDEC specification JESD22-C101 ⁽²⁾	±500	

(1) JEDEC document JEP155 states that 500-V HBM allows safe manufacturing with a standard ESD control process.

(2) JEDEC document JEP157 states that 250-V CDM allows safe manufacturing with a standard ESD control process.

6.3 Recommended Operating Conditions

over operating free-air temperature range (unless otherwise noted)

		MIN	NOM	MAX	UNIT
V _{IN}	Supply input voltage range	4.5		17	V
EN	EN Input voltage range	-0.1		V _{IN}	V
T _J	Operating junction temperature	-40		125	°C

6.4 Thermal Information

THERMAL METRIC ⁽¹⁾		TPS563249	UNIT
		DDC (SOT)	
		6 PINS	
R _{θJA}	Junction-to-ambient thermal resistance	117.1	°C/W
R _{θJC(top)}	Junction-to-case (top) thermal resistance	57.3	°C/W
R _{θJB}	Junction-to-board thermal resistance	31.2	°C/W
ψ _{JT}	Junction-to-top characterization parameter	11.2	°C/W
ψ _{JB}	Junction-to-board characterization parameter	31.3	°C/W

(1) For more information about traditional and new thermal metrics, see the [Semiconductor and IC Package Thermal Metrics](#) application report.

6.5 Electrical Characteristics

 $T_J = -40^{\circ}\text{C}$ to 125°C , $V_{IN} = 12\text{ V}$ (unless otherwise noted)

PARAMETER		TEST CONDITIONS	MIN	TYP	MAX	UNIT
SUPPLY CURRENT						
$I_{VIN(SDN)}$	Shutdown supply current	V_{IN} current, $EN = 0\text{ V}$, $T_J = 25^{\circ}\text{C}$		2.5	10	μA
LOGIC THRESHOLD						
V_{ENH}	Enable threshold	Rising		1.27	1.34	V
V_{ENL}	Enable threshold	Falling	1.08	1.15		V
R_{EN}	EN pin resistance to GND	$V_{EN} = 1\text{ V}$	800	1000	1200	$\text{k}\Omega$
V_{FB} VOLTAGE AND DISCHARGE RESISTANCE						
V_{FB}	FB voltage	$T_J = 25^{\circ}\text{C}$	594	600	606	mV
			588	600	612	mV
I_{FB}	FB input current	$V_{FB} = 0.7\text{ V}$		0	± 50	nA
MOSFET						
$R_{DS(on)h}$	High-side switch resistance	$T_J = 25^{\circ}\text{C}$		70		$\text{m}\Omega$
$R_{DS(on)l}$	Low-side switch resistance	$T_J = 25^{\circ}\text{C}$		30		$\text{m}\Omega$
CURRENT LIMIT						
$I_{ocl_h_source}$	High side FET source Current limit		5.5	6.3	7.1	A
$I_{ocl_l_source}$	Low side FET source Current limit		3.1	3.9	4.7	A
$I_{ocl_l_sink}$	Low side FET sink Current limit		1.1	1.7		A
THERMAL SHUTDOWN						
T_{SDN}	Thermal shutdown threshold ⁽¹⁾	Shutdown temperature		160		$^{\circ}\text{C}$
		Hysteresis		25		
ON-TIME TIMER CONTROL						
$t_{ON(MIN)}$	Minimum on time ⁽¹⁾	$V_{IN} = 12\text{ V}$, load = 3 A		50		ns
$t_{OFF(MIN)}$	Minimum off time			250		ns
SOFT START						
t_{ss}	Soft-start time	Internal soft-start time		1.7		ms
FREQUENCY						
F_{sw}	Switching frequency		1250	1400	1550	kHz
OUTPUT UNDERVOLTAGE PROTECTION						
V_{UVP}	Output UVP threshold	Hiccup detect ($H > L$)		65%		
t_{UVPDLY}	UVP propagation delay			0.36		ms
t_{HIC}	UVP protection Hiccup Time before restart			25		ms
UVLO						
UVLO	UVLO threshold	Wake up VIN voltage		4.2	4.4	V
		Shutdown VIN voltage	3.6	3.8		
		Hysteresis VIN voltage		0.4		

(1) Not production tested.

6.6 Typical Characteristics

$V_{IN} = 12\text{ V}$ (unless otherwise noted)



图 1. Shutdown Current vs Junction Temperature



图 2. VFB Voltage vs Junction Temperature

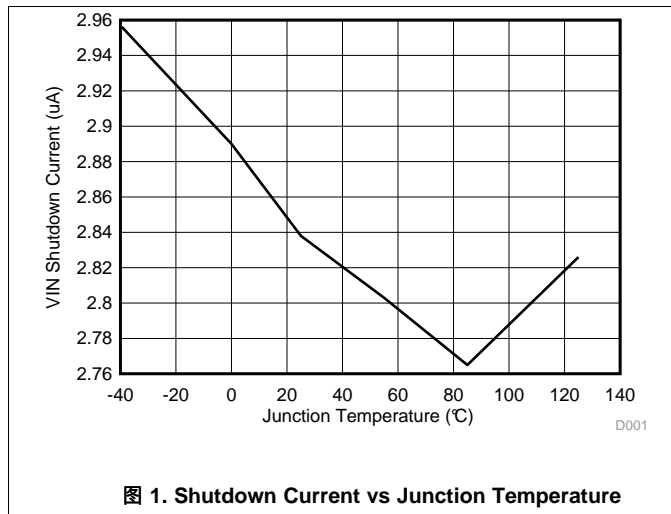

图 3. EN Rising threshold vs Junction Temperature

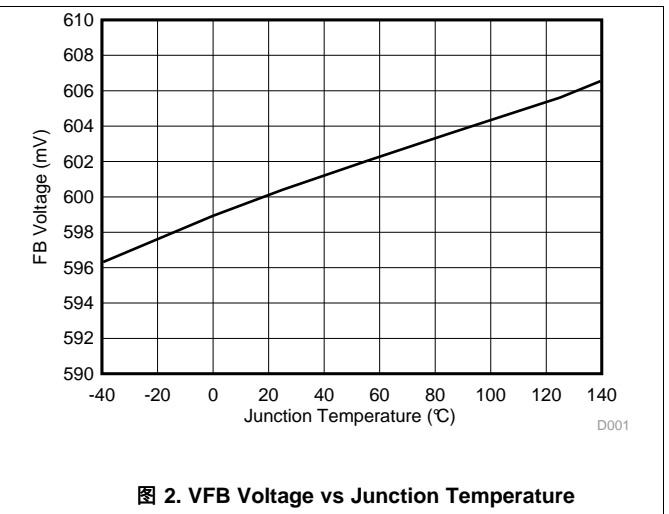

图 4. EN Falling threshold vs Junction Temperature

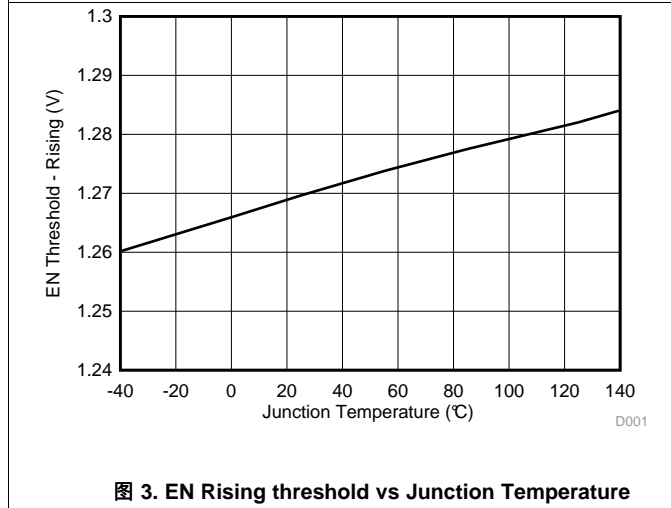

图 5. High-Side $R_{ds(on)}$ vs Junction Temperature

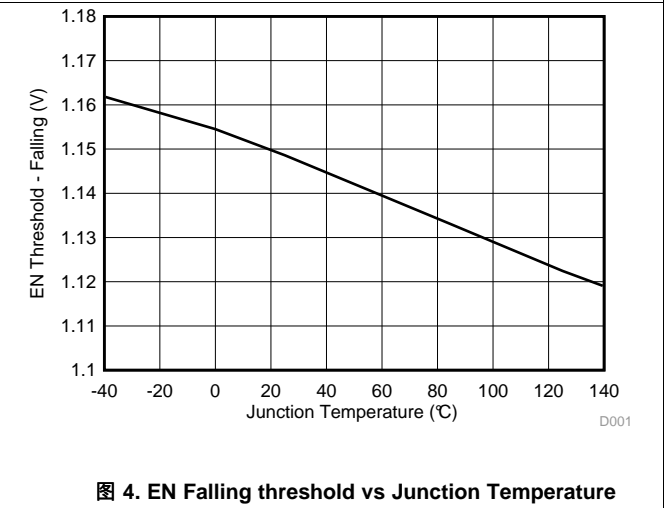

图 6. Low-Side $R_{ds(on)}$ vs Junction Temperature

Typical Characteristics (接下页)

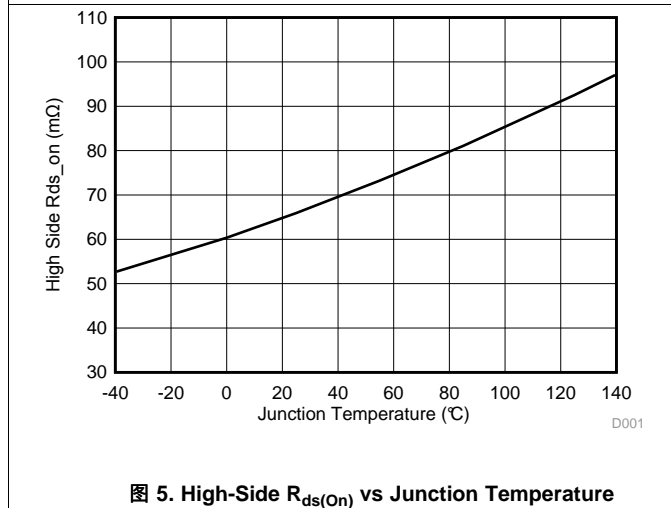
$V_{IN} = 12\text{ V}$ (unless otherwise noted)

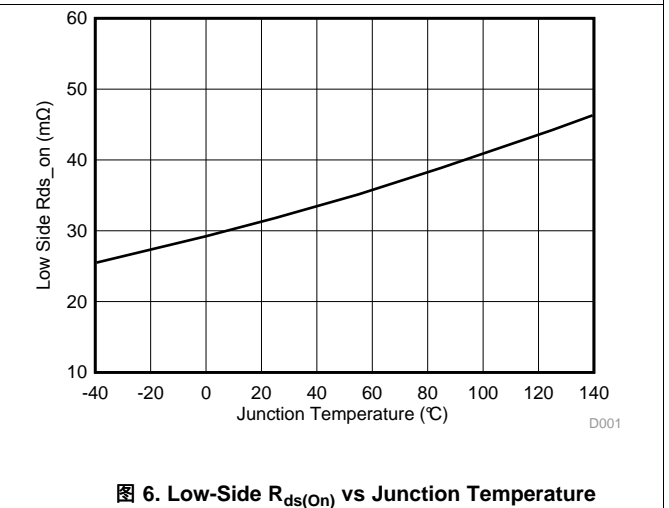

图 7. Dropout for 3.3 V Output Voltage



图 8. Dropout for 5 V Output Voltage

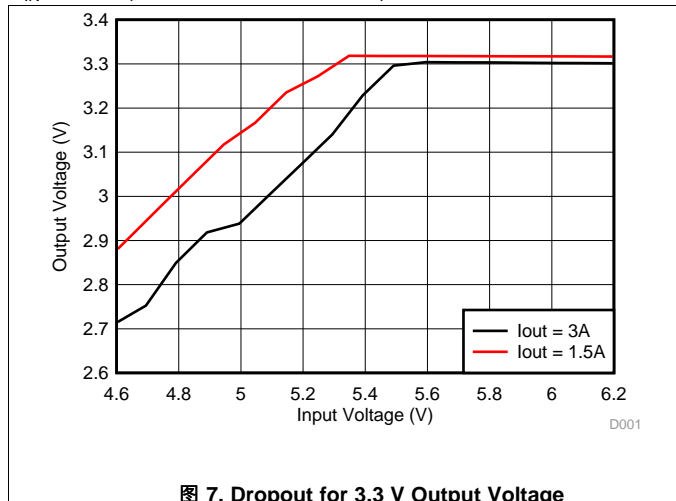

图 9. Efficiency vs Output Current, $V_{OUT} = 0.9\text{ V}$

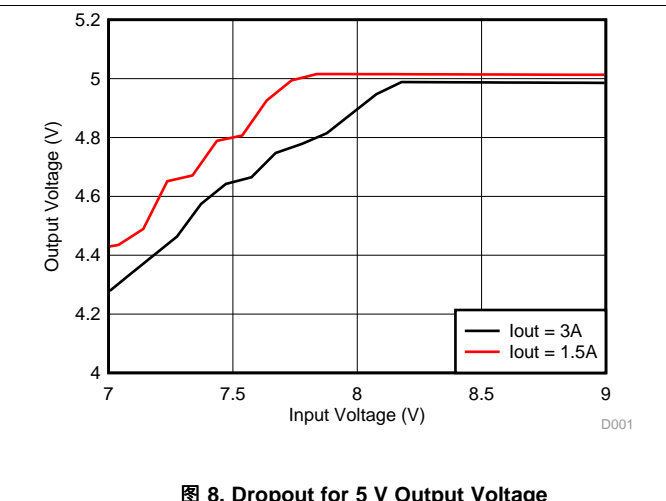

图 10. Efficiency vs Output Current, $V_{OUT} = 1.05\text{ V}$

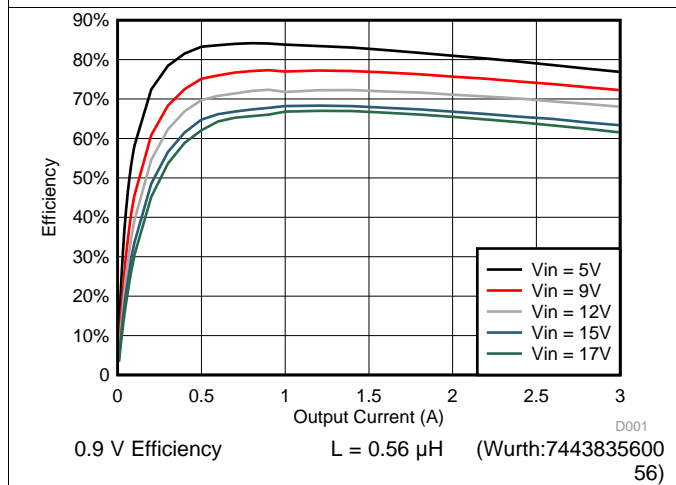

图 11. Efficiency vs Output Current, $V_{OUT} = 1.2\text{ V}$

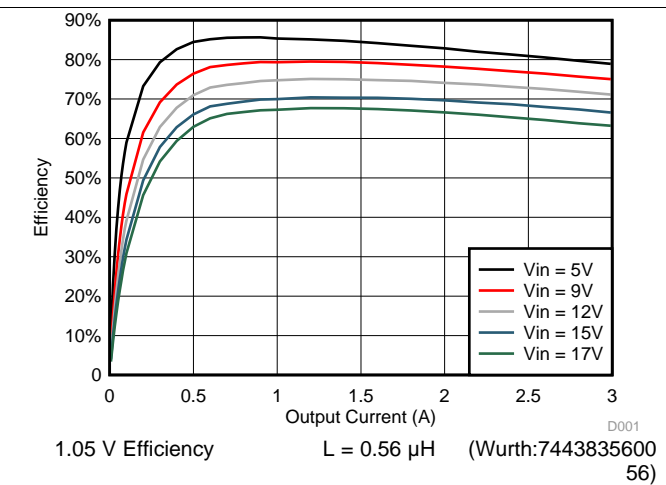

图 12. Efficiency vs Output Current, $V_{OUT} = 1.5\text{ V}$

Typical Characteristics (接下页)

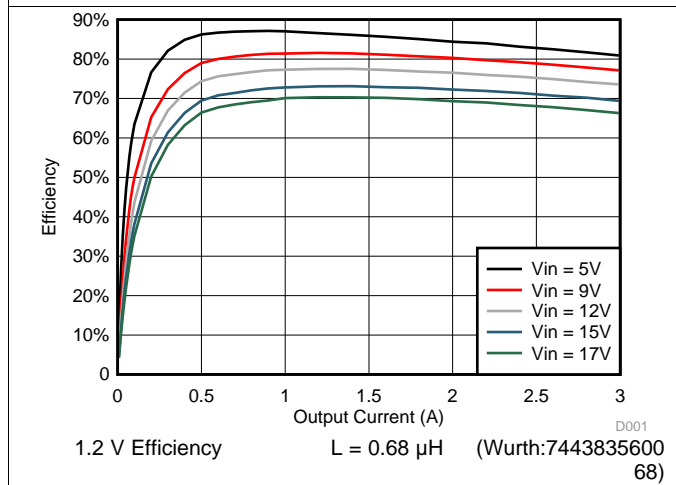
$V_{IN} = 12\text{ V}$ (unless otherwise noted)

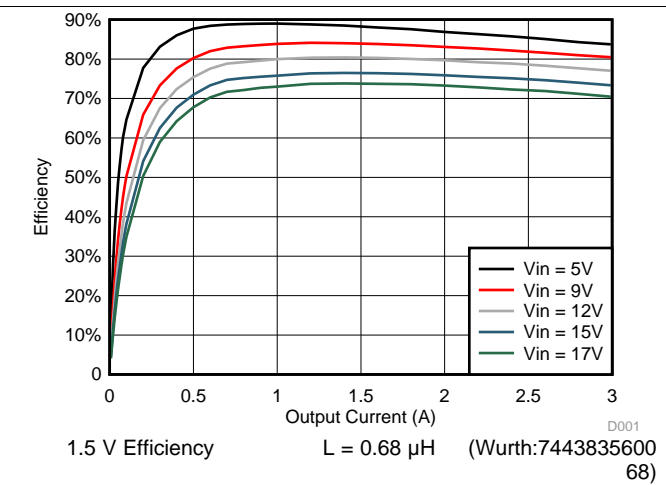

图 13. Efficiency vs Output Current, $V_{OUT} = 1.8\text{ V}$



图 14. Efficiency vs Output Current, $V_{OUT} = 2.5\text{ V}$

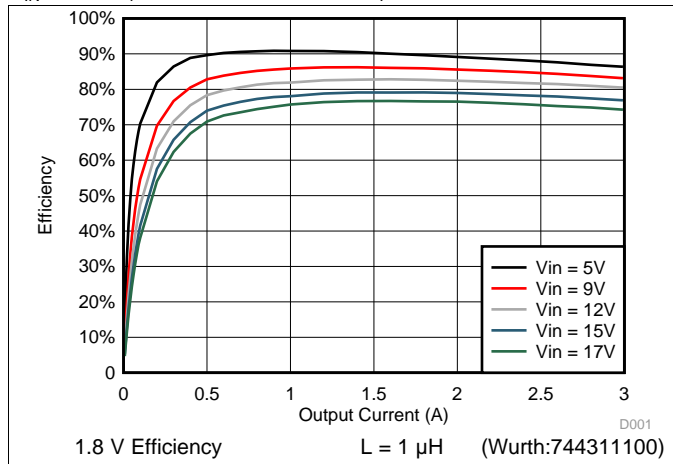

图 15. Efficiency vs Output Current, $V_{OUT} = 3.3\text{ V}$

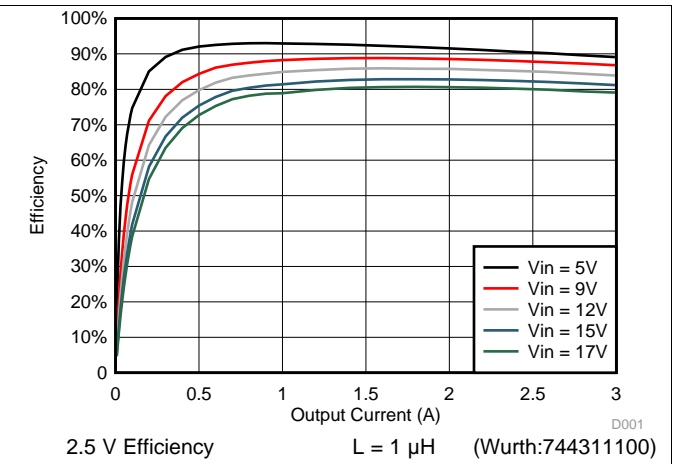

图 16. Efficiency vs Output Current, $V_{OUT} = 5\text{ V}$

7 Detailed Description

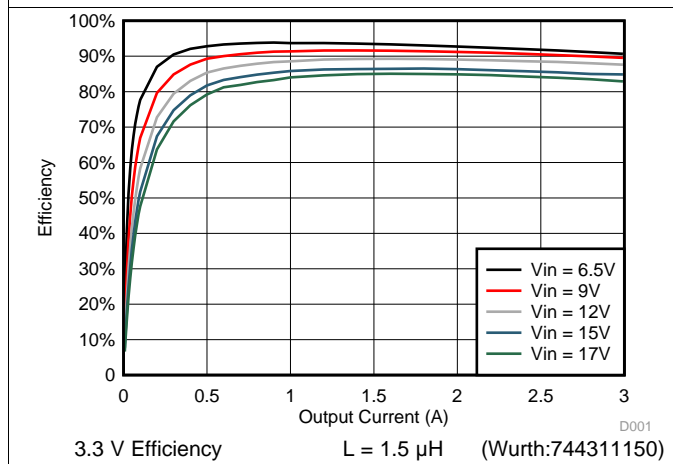
7.1 Overview

The TPS563249 is a 3-A synchronous step-down converter. The proprietary D-CAP3 mode control supports low ESR output capacitors such as specialty polymer capacitors and multi-layer ceramic capacitors without complex external compensation circuits. The fast transient response of D-CAP3 mode control can reduce the output capacitance required to meet a specific level of performance.

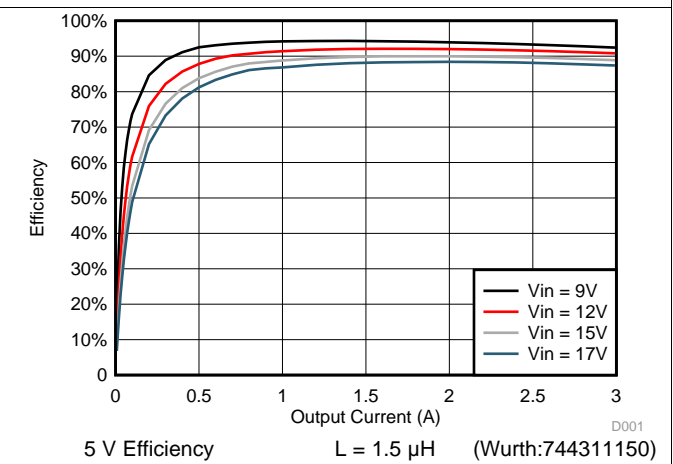
7.2 Functional Block Diagram

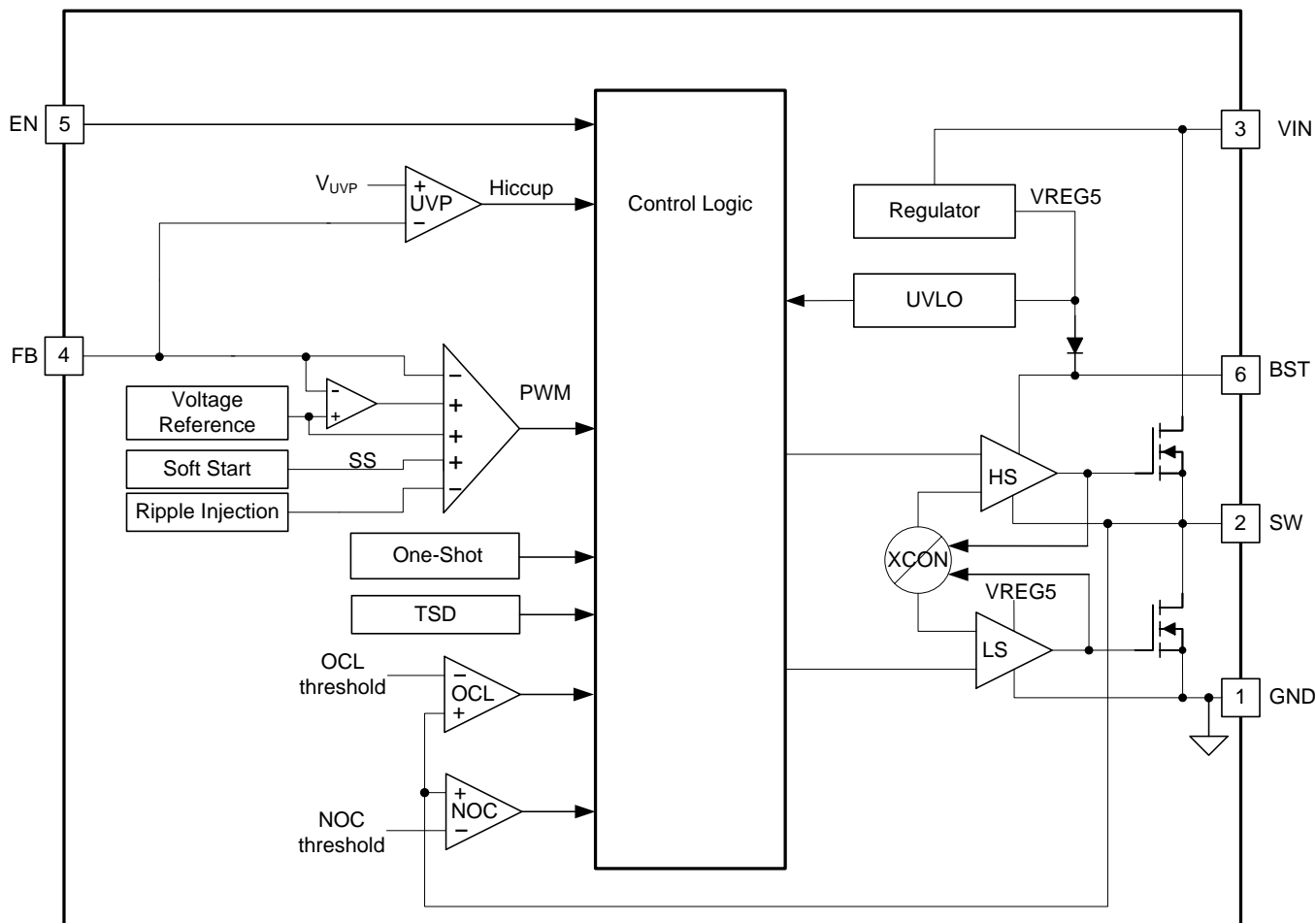

7.3 Feature Description

7.3.1 Adaptive On-Time Control and PWM Operation

The main control loop of the TPS563249 is adaptive on-time pulse width modulation (PWM) controller that supports a proprietary D-CAP3 mode control. The D-CAP3 mode control combines adaptive on-time control with an internal compensation circuit for pseudo-fixed frequency and low external component count configuration with both low-ESR and ceramic output capacitors. It is stable even with virtually no ripple at the output.

At the beginning of each cycle, the high-side MOSFET is turned on. This MOSFET is turned off after internal one shot timer expires. This one shot duration is set proportional to the converter input voltage, V_{IN} , and inversely proportional to the output voltage, V_O , to maintain a pseudo-fixed frequency over the input voltage range, hence it is called adaptive on-time control. The one-shot timer is reset and the high-side MOSFET is turned on again when the feedback voltage falls below the reference voltage. An internal ramp is added to reference voltage to simulate output ripple, eliminating the need for ESR induced output ripple from D-CAP3 mode control.

Feature Description (接下页)

7.3.2 Soft Start and Pre-Biased Soft Start

The TPS563249 has an internal 1.7-ms soft-start. When the EN pin becomes high, the internal soft-start function begins ramping up the reference voltage to the PWM comparator.

If the output capacitor is pre-biased at startup, the devices initiate switching and start ramping up only after the internal reference voltage becomes greater than the feedback voltage V_{FB} . This scheme ensures that the converters ramp up smoothly into regulation point.

7.3.3 Current Protection

There are three kinds of current protection in TPS563249: High-side FET source current limit, low-side FET source current limit, and low-side FET sink current limit.

The output over-current limit (OCL) is implemented using a cycle-by-cycle valley detect control circuit. The switch current is monitored during the OFF state by measuring the low-side FET drain to source voltage. This voltage is proportional to the switch current. To improve accuracy, the voltage sensing is temperature compensated.

During the on time of the low-side FET switch, the inductor current flow through low-side FET and decreases linearly. The average value of the inductor current is the load current I_{OUT} . If the monitored current is above the low-side FET source current limit level, the converter maintains low-side FET on and delays the creation of a new set pulse, even the voltage feedback loop requires one, until the current cross the low-side FET source current limit level. In subsequent switching cycles, the on-time is set to a fixed value and the current is monitored in the same manner.

There are some important considerations for this type of over-current protection. The load current is higher than the over-current threshold by one half of the peak-to-peak inductor ripple current. Also, when the current is being limited, the output voltage tends to fall as the demanded load current may be higher than the current available from the converter. This may cause the output voltage to fall. When the V_{FB} voltage falls below the UVP threshold voltage, the UVP comparator detects it. And then, the device will shut down after the UVP delay time (typically 0.36 ms) and re-start after the hiccup time (typically 25 ms).

When the over current condition is removed, the output voltage returns to the regulated value.

During the on time of the high-side FET switch, the inductor current flow through high-side FET and increases at a linear rate determined by V_{IN} , V_{OUT} , the on-time and the output inductor value. The switch current is compared with high-side FET source current limit after a short blanking time. If the cross-limit event detected before the one shot timer expires, the high-side FET is turn off immediately, and is not allowed on in the following 1 μ S period.

TPS563249 works in Forced Continuous Conduction Mode (FCCM). To support light load operation, the current flowing through low-side FET is allowed to be negative, which means the current flow from drain to source of low-side FET. This negative current is compared with low-side FET sink current limit to prevent device from being over-current damaged. Once the sink current cross limit, the low-side FET is turn off immediately. Both high-side FET and low-side FET will keep off until the V_{FB} voltage falls below reference voltage.

7.3.4 Undervoltage Lockout (UVLO) Protection

UVLO protection monitors the internal regulator voltage. When the voltage is lower than UVLO threshold voltage, the device is shut off. This protection is non-latching.

7.3.5 Thermal Shutdown

The device monitors the temperature of itself. If the temperature exceeds the thermal shutdown threshold value (typically 160°C), the device will shut off. This is a non-latch protection. The device will resume normal working once the temperature return below the recovery threshold value (typically 135°C).

7.4 Device Functional Modes

7.4.1 Normal Operation

When the input voltage is above the UVLO threshold and the EN voltage is above the enable threshold, the TPS563249 can operate in the continuous conduction mode (CCM) at a fixed frequency of 1.4 MHz. If EN pin is driven by a control signal, the required power on sequence is that applying input voltage at VIN pin firstly, then pull EN pin high. Be sure that the EN pin voltage isn't higher than VIN pin voltage. If EN pin is not used, it can be tied to VIN pin directly.

7.4.2 Standby Operation

TPS563249 can be placed in standby by asserting the EN pin low.

8 Application and Implementation

注

Information in the following applications sections is not part of the TI component specification, and TI does not warrant its accuracy or completeness. TI's customers are responsible for determining suitability of components for their purposes. Customers should validate and test their design implementation to confirm system functionality.

8.1 Application Information

The device is a typical step-down DC-DC converter. It is typically used to convert a higher dc voltage to a lower dc voltage with a maximum available output current of 3 A. The following design procedure can be used to select component values for the TPS563249. Alternately, the WEBENCH[®] software may be used to generate a complete design. The WEBENCH software uses an iterative design procedure and accesses a comprehensive database of components when generating a design. This section presents a simplified discussion of the design process.

8.2 Typical Application

The application schematic in 图 17 was developed to meet the previous requirements. This circuit is available as the evaluation module (EVM). The sections provide the design procedure.

图 17 shows the TPS563249 6.5-V to 17-V input, 3.3-V output converter schematic.



图 17. 3.3-V/3-A Reference Design

Typical Application (接下页)

8.2.1 Design Requirements

表 1 shows the design parameters for this application.

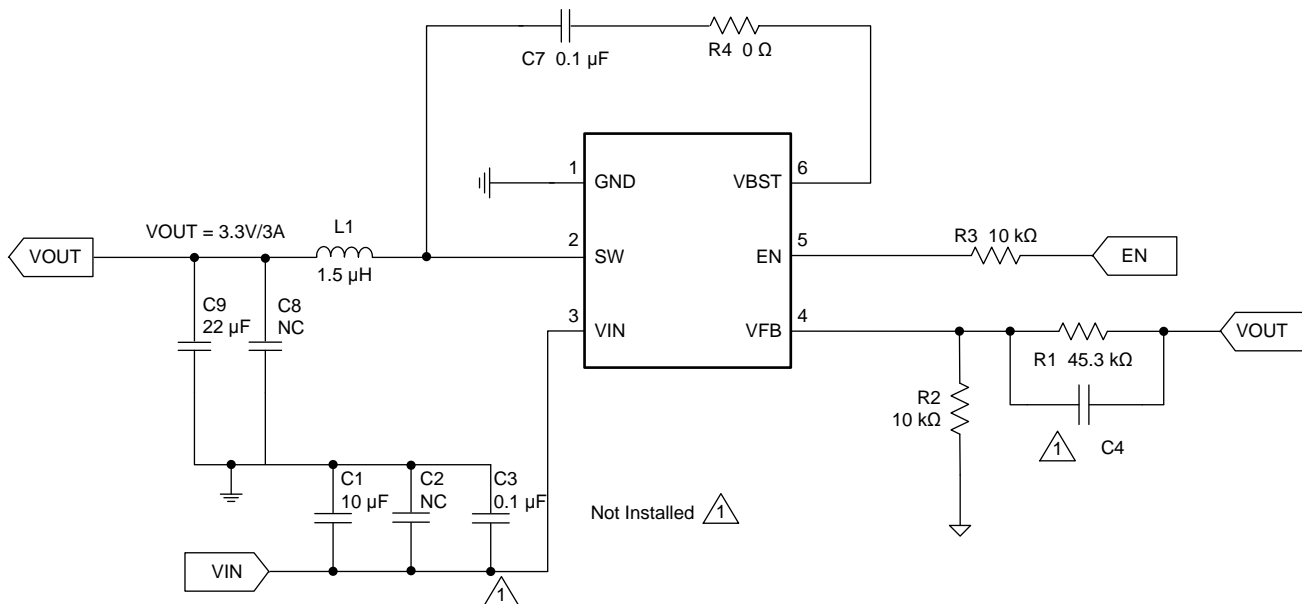
表 1. Design Parameters

PARAMETER	EXAMPLE VALUE
Input voltage range	6.5 to 17 V
Output voltage	3.3 V
Transient response, 1.5-A load step	$\Delta V_{OUT} = \pm 5\%$
Input ripple voltage	400 mV
Output ripple voltage	100 mV
Output current rating	3 A
Operating frequency	1.4 MHz

8.2.2 Detailed Design Procedure

8.2.2.1 Output Voltage Resistors Selection

The output voltage is set with a resistor divider from the output node to the VFB pin. TI recommends to use 1% tolerance or better divider resistors. Start by using 公式 1 to calculate V_{OUT} .

Too high of resistance is more susceptible to noise, and voltage errors from the VFB input current is more noticeable.

$$V_{OUT} = 0.6 \times \left(1 + \frac{R1}{R2}\right) \quad (1)$$

8.2.2.2 Output Filter Selection

The LC filter used as the output filter has double pole at:

$$f_p = \frac{1}{2\pi\sqrt{L_{OUT} \times C_{OUT}}} \quad (2)$$

At low frequencies, the overall loop gain is set by the output set-point resistor divider network and the internal gain of the device. The low frequency phase is 180°. At the output filter pole frequency, the gain rolls off at a –40 dB per decade rate and the phase drops rapidly. D-CAP3 introduces a high frequency zero that reduces the gain roll off to –20 dB per decade and increases the phase to 90° one decade above the zero frequency. The inductor and capacitor for the output filter must be selected so that the double pole of 公式 2 is located below the high frequency zero but close enough that the phase boost provided by the high frequency zero provides adequate phase margin for a stable circuit. To meet this requirement use the values recommended in 表 2.

表 2. Recommended Component Values

OUTPUT VOLTAGE (V)	R1 (k Ω)	R2 (k Ω)	L1 (μ H)			C8 + C9 (μ F)
			MIN	TYP	MAX	
1	6.65	10.0	0.33	0.56	1	10 to 44
1.05	7.5	10.0	0.33	0.56	1	10 to 44
1.2	10	10.0	0.47	0.68	1.5	10 to 44
1.5	15	10.0	0.47	0.82	1.5	10 to 44
1.8	20	10.0	0.56	1	2.2	10 to 44
2.5	31.6	10.0	0.68	1	2.2	10 to 44
3.3	45.3	10.0	0.82	1.5	3.3	10 to 44
5	73.2	10.0	1	1.5	3.3	10 to 44
6.5	97.6	10.0	1	1.5	3.3	10 to 44

The inductor peak-to-peak ripple current, peak current and RMS current are calculated using 公式 3, 公式 4, and 公式 5. The inductor saturation current rating must be greater than the calculated peak current and the RMS or heating current rating must be greater than the calculated RMS current.

$$I_{P-P} = \frac{V_{OUT}}{V_{IN(MAX)}} \times \frac{V_{IN(MAX)} - V_{OUT}}{L_O \times f_{SW}} \quad (3)$$

$$I_{PEAK} = I_O + \frac{I_{P-P}}{2} \quad (4)$$

$$I_{LO(RMS)} = \sqrt{I_O^2 + \frac{1}{12} I_{P-P}^2} \quad (5)$$

For this design example, the calculated peak current is 3.63 A and the calculated RMS current is 3.02 A. The inductor used is a WE 744311150 with a rated current of 11 A.

The capacitor value and ESR determines the amount of output voltage ripple. The TPS563249 is intended for use with ceramic or other low ESR capacitors. Recommended values range from 10 μ F to 44 μ F. Use 公式 6 to determine the required RMS current rating for the output capacitor.

$$I_{CO(RMS)} = \frac{V_{OUT} \times (V_{IN} - V_{OUT})}{\sqrt{12} \times V_{IN} \times L_O \times f_{SW}} \quad (6)$$

For this design one Murata GRM31CR61A226KE19 22- μ F output capacitor is used. The typical ESR is 2 m Ω . The calculated RMS current is 0.365 A and output capacitor is rated for 4 A.

8.2.2.3 Input Capacitor Selection

The TPS563249 requires an input decoupling capacitor and a bulk capacitor is needed depending on the application. TI recommends a ceramic capacitor over 10 μ F for the decoupling capacitor. An additional 0.1- μ F capacitor (C3) from pin 3 to ground is optional to provide additional high frequency filtering. The capacitor voltage rating needs to be greater than the maximum input voltage.

8.2.2.4 Bootstrap Capacitor Selection

A 0.1- μ F ceramic capacitor must be connected between the VBST to SW pin for proper operation. TI recommends to use a ceramic capacitor.

8.2.2.5 Dropout

With a constant 1.4-MHz switching frequency, there is a minimum input voltage limit for a given output voltage to be regulated. This is due to the minimum off time limit. If the input voltage less than the minimum input voltage limit, the output voltage drops accordingly, which is called dropout condition. 图 7 and 图 8 show the typical dropout curve for 3.3 V and 5 V output voltage with 3 A and 1.5 A load respectively. 公式 7 can be used to estimate this minimum input voltage limit.

$$V_{IN(MIN)} = \frac{\frac{V_{OUT}}{F_{SW}} + (R_{dsl} + R_L) \times I_O \times (t_{off(min)} - t_{d1} - t_{d2}) + (V_d + R_L \times I_O) \times (t_{d1} + t_{d2})}{\frac{1}{F_{SW}} - t_{off(min)}} + (R_{dsh} + R_L) \times I_O$$

where

- V_{OUT} = target output voltage
- F_{SW} = maximum switching frequency including tolerance
- $t_{off(min)}$ = minimum off time including tolerance
- R_{dsl} = low side FET on resistance
- R_{dsh} = high side FET on resistance
- R_L = inductor DC resistance
- I_O = maximum load current
- t_{d1} = dead time between high side FET off and low side FET on, 15nS typical
- t_{d2} = dead time between low side FET off and high side FET on, 10nS typical
- V_d = forward voltage of low side FET body diode

(7)

8.2.3 Application Curves

$T_A = 25^\circ\text{C}$, $V_{IN} = 12\text{ V}$ (unless otherwise noted)



图 18. Load Regulation



图 19. Line Regulation

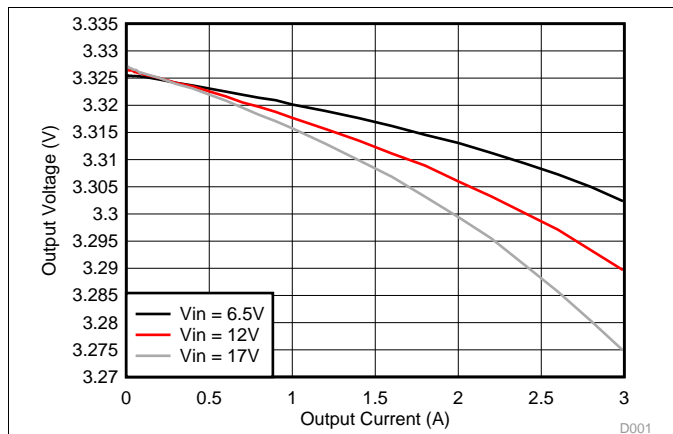

图 20. Efficiency

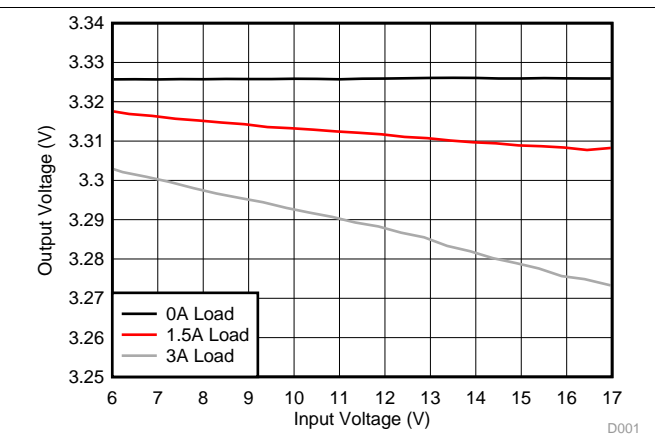

图 21. Input Voltage Ripple

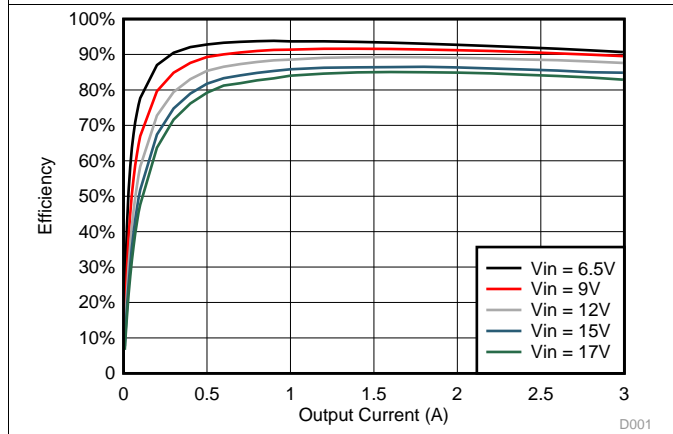

图 22. Output Voltage Ripple

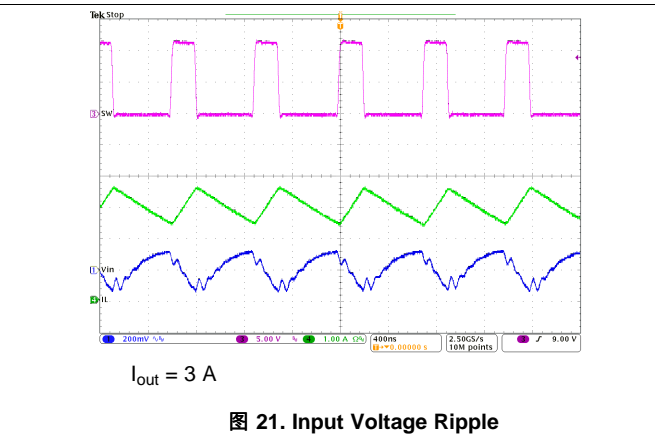

图 23. Output Voltage Ripple

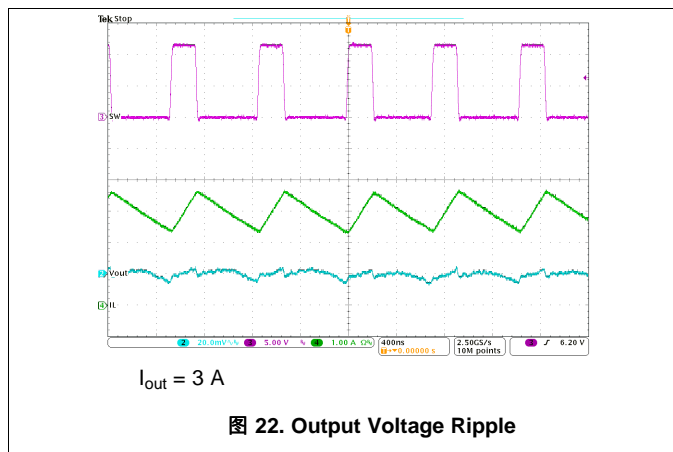

Slew rate is 1.6 A/μs

图 24. Transient Response, 0.6 to 2.4 A

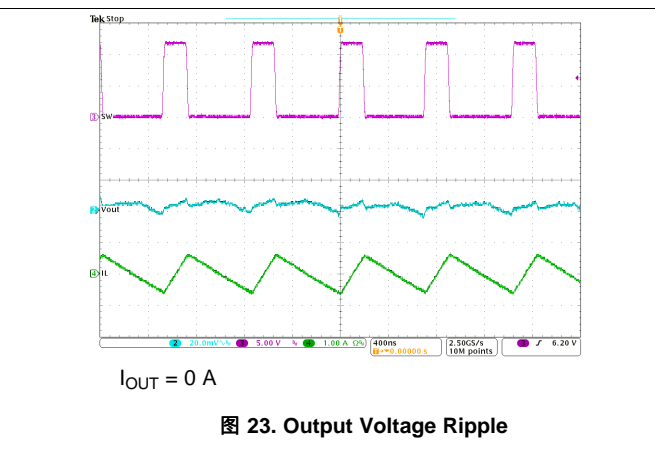
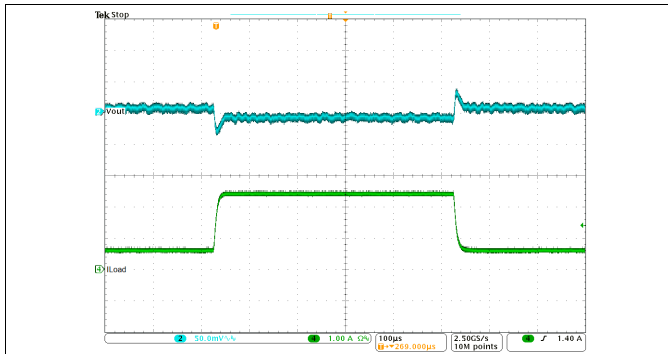
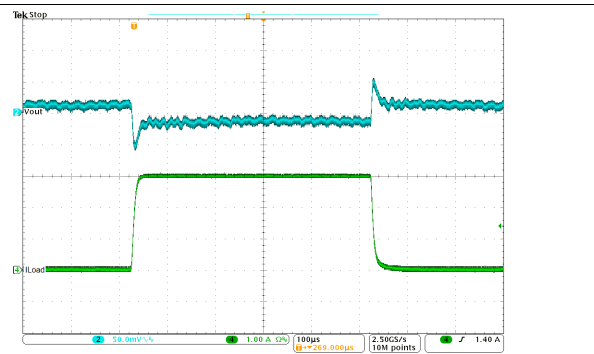

Slew rate is 1.6 A/μs

图 25. Transient Response, 0 to 3 A

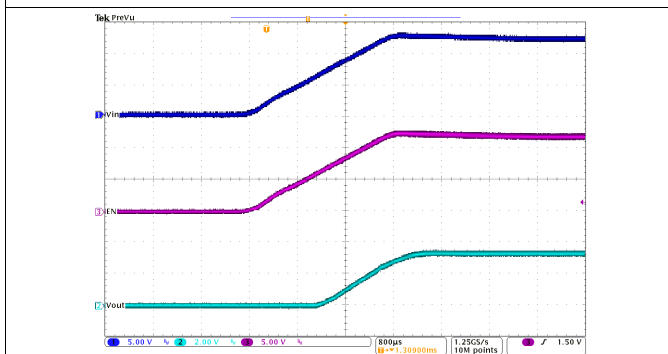

$I_{OUT} = 0 A$

图 26. Start Up Relative to V_{IN}

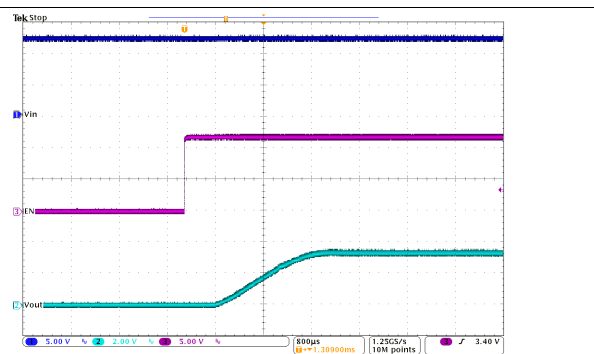

$I_{OUT} = 3 A$

图 27. Start-Up Relative to EN

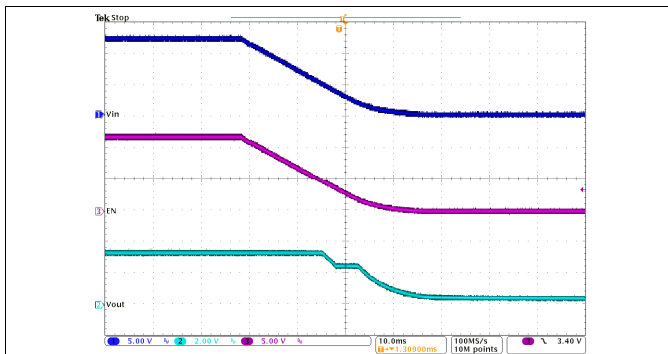

$I_{OUT} = 0 A$

图 28. Shutdown Relative to V_{IN}

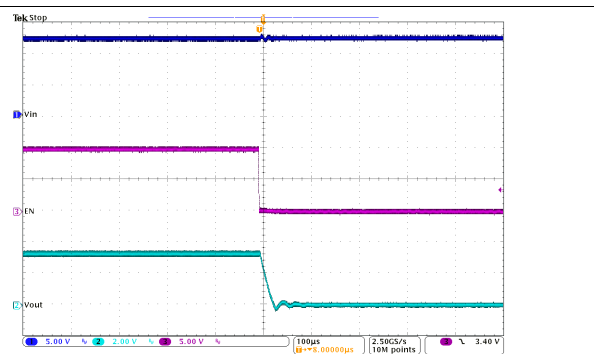

$I_{OUT} = 3 A$

图 29. Shutdown Relative to EN

9 Power Supply Recommendations

TPS563249 is designed to operate from input supply voltage in the range of 4.5 V to 17 V. Buck converters require the input voltage to be higher than the output voltage for proper operation.

10 Layout

10.1 Layout Guidelines

1. VIN and GND traces should be as wide as possible to reduce trace impedance. The wide areas are also of advantage from the view point of heat dissipation.
2. The input capacitor and output capacitor should be placed as close to the device as possible to minimize trace impedance.
3. Provide sufficient vias for the input capacitor and output capacitor.
4. Keep the SW trace as physically short and wide as practical to minimize radiated emissions.
5. Do not suggest routing SW copper under the device.
6. A separate VOUT path should be connected to the upper feedback resistor.
7. Make a Kelvin connection to the GND pin for the feedback path.
8. Voltage feedback loop should be placed away from the high-voltage switching trace, and preferably has ground shield.
9. The trace of the VFB node should be as small as possible to avoid noise coupling.
10. The GND trace between the output capacitor and the GND pin should be as wide as possible to minimize its trace impedance.

10.2 Layout Example



图 30. Example Layout

11 器件和文档支持

11.1 接收文档更新通知

要接收文档更新通知，请导航至 TI.com.cn 上的器件产品文件夹。单击右上角的 [通知我](#) 进行注册，即可每周接收产品信息更改摘要。有关更改的详细信息，请查看任何已修订文档中包含的修订历史记录。

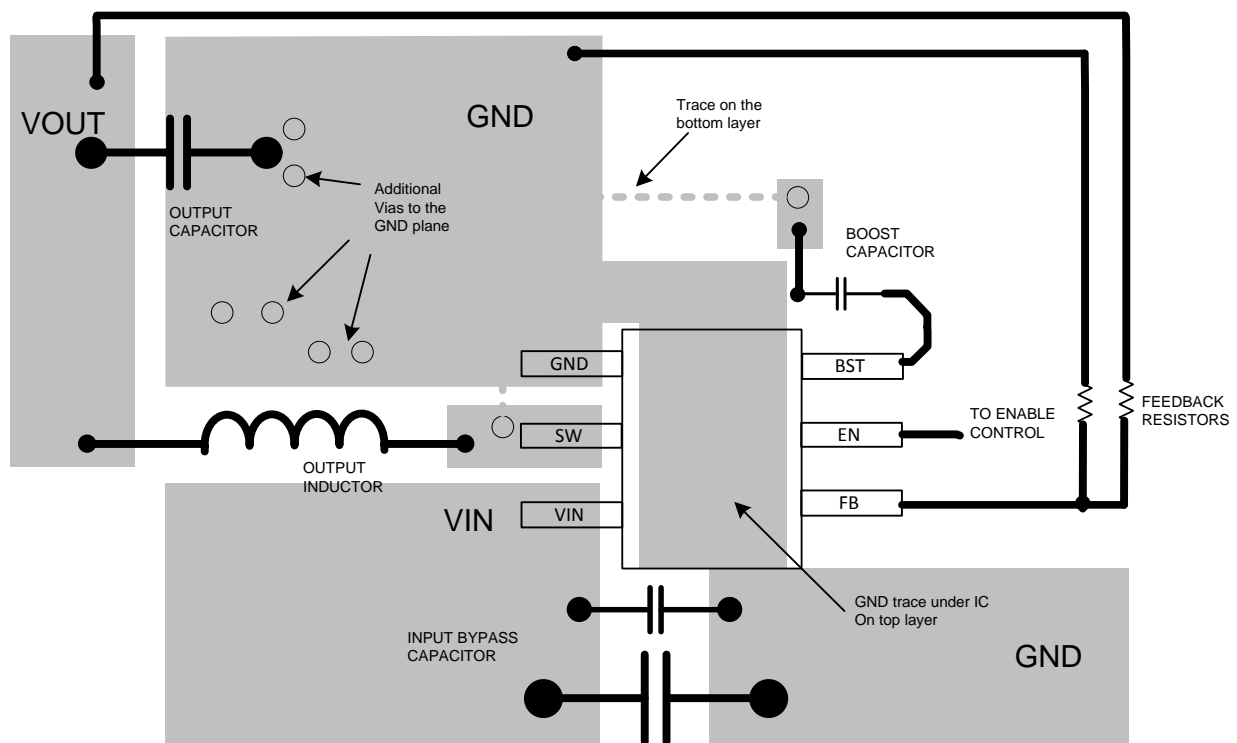
11.2 社区资源

下列链接提供到 TI 社区资源的连接。链接的内容由各个分销商“按照原样”提供。这些内容并不构成 TI 技术规范，并且不一定反映 TI 的观点；请参阅 TI 的 [《使用条款》](#)。

TI E2E™ 在线社区 [TI 的工程师对工程师 \(E2E\) 社区](#)。此社区的创建目的在于促进工程师之间的协作。在 e2e.ti.com 中，您可以咨询问题、分享知识、拓展思路并与同行工程师一道帮助解决问题。

设计支持 [TI 参考设计支持](#) 可帮助您快速查找有帮助的 E2E 论坛、设计支持工具以及技术支持的联系信息。

11.3 商标

D-CAP3, E2E are trademarks of Texas Instruments.
 WEBENCH is a registered trademark of Texas Instruments.
 All other trademarks are the property of their respective owners.

11.4 静电放电警告



这些装置包含有限的内置 ESD 保护。存储或装卸时，应将导线一起截短或将装置放置于导电泡棉中，以防止 MOS 门极遭受静电损伤。

11.5 术语表

SLYZ022 — *TI 术语表*。

这份术语表列出并解释术语、缩写和定义。

12 机械、封装和可订购信息

以下页面包含机械、封装和可订购信息。这些信息是指定器件的最新可用数据。数据如有变更，恕不另行通知，且不会对此文档进行修订。如需获取此数据表的浏览器版本，请查阅左侧的导航栏。

PACKAGING INFORMATION

Orderable Device	Status (1)	Package Type	Package Drawing	Pins	Package Qty	Eco Plan (2)	Lead finish/ Ball material (6)	MSL Peak Temp (3)	Op Temp (°C)	Device Marking (4/5)	Samples
TPS563249DDCR	ACTIVE	SOT-23-THIN	DDC	6	3000	RoHS & Green	Call TI SN	Level-1-260C-UNLIM	-40 to 125	249	Samples
TPS563249DDCT	ACTIVE	SOT-23-THIN	DDC	6	250	RoHS & Green	Call TI SN	Level-1-260C-UNLIM	-40 to 125	249	Samples

(1) The marketing status values are defined as follows:

ACTIVE: Product device recommended for new designs.

LIFEBUY: TI has announced that the device will be discontinued, and a lifetime-buy period is in effect.

NRND: Not recommended for new designs. Device is in production to support existing customers, but TI does not recommend using this part in a new design.

PREVIEW: Device has been announced but is not in production. Samples may or may not be available.

OBSOLETE: TI has discontinued the production of the device.

(2) **RoHS:** TI defines "RoHS" to mean semiconductor products that are compliant with the current EU RoHS requirements for all 10 RoHS substances, including the requirement that RoHS substance do not exceed 0.1% by weight in homogeneous materials. Where designed to be soldered at high temperatures, "RoHS" products are suitable for use in specified lead-free processes. TI may reference these types of products as "Pb-Free".

RoHS Exempt: TI defines "RoHS Exempt" to mean products that contain lead but are compliant with EU RoHS pursuant to a specific EU RoHS exemption.

Green: TI defines "Green" to mean the content of Chlorine (Cl) and Bromine (Br) based flame retardants meet JS709B low halogen requirements of <=1000ppm threshold. Antimony trioxide based flame retardants must also meet the <=1000ppm threshold requirement.

(3) MSL, Peak Temp. - The Moisture Sensitivity Level rating according to the JEDEC industry standard classifications, and peak solder temperature.

(4) There may be additional marking, which relates to the logo, the lot trace code information, or the environmental category on the device.

(5) Multiple Device Markings will be inside parentheses. Only one Device Marking contained in parentheses and separated by a "~" will appear on a device. If a line is indented then it is a continuation of the previous line and the two combined represent the entire Device Marking for that device.

(6) Lead finish/Ball material - Orderable Devices may have multiple material finish options. Finish options are separated by a vertical ruled line. Lead finish/Ball material values may wrap to two lines if the finish value exceeds the maximum column width.

Important Information and Disclaimer:The information provided on this page represents TI's knowledge and belief as of the date that it is provided. TI bases its knowledge and belief on information provided by third parties, and makes no representation or warranty as to the accuracy of such information. Efforts are underway to better integrate information from third parties. TI has taken and continues to take reasonable steps to provide representative and accurate information but may not have conducted destructive testing or chemical analysis on incoming materials and chemicals. TI and TI suppliers consider certain information to be proprietary, and thus CAS numbers and other limited information may not be available for release.

In no event shall TI's liability arising out of such information exceed the total purchase price of the TI part(s) at issue in this document sold by TI to Customer on an annual basis.

TAPE AND REEL INFORMATION

QUADRANT ASSIGNMENTS FOR PIN 1 ORIENTATION IN TAPE

*All dimensions are nominal

Device	Package Type	Package Drawing	Pins	SPQ	Reel Diameter (mm)	Reel Width W1 (mm)	A0 (mm)	B0 (mm)	K0 (mm)	P1 (mm)	W (mm)	Pin1 Quadrant
TPS563249DDCR	SOT-23-THIN	DDC	6	3000	180.0	8.4	3.2	3.2	1.4	4.0	8.0	Q3
TPS563249DDCT	SOT-23-THIN	DDC	6	250	180.0	8.4	3.2	3.2	1.4	4.0	8.0	Q3
TPS563249DDCT	SOT-23-THIN	DDC	6	250	180.0	8.4	3.2	3.2	1.4	4.0	8.0	Q3

TAPE AND REEL BOX DIMENSIONS

*All dimensions are nominal

Device	Package Type	Package Drawing	Pins	SPQ	Length (mm)	Width (mm)	Height (mm)
TPS563249DDCR	SOT-23-THIN	DDC	6	3000	210.0	185.0	35.0
TPS563249DDCT	SOT-23-THIN	DDC	6	250	210.0	185.0	35.0
TPS563249DDCT	SOT-23-THIN	DDC	6	250	210.0	185.0	35.0

EXAMPLE BOARD LAYOUT

DDC0006A

SOT-23 - 1.1 max height

SMALL OUTLINE TRANSISTOR

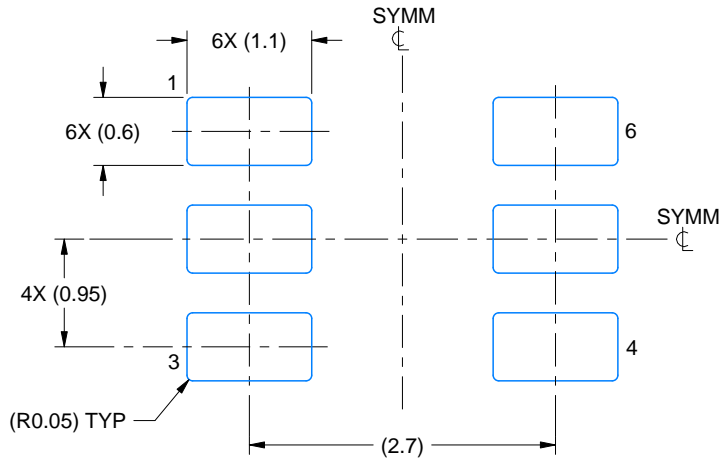

LAND PATTERN EXAMPLE
EXPLODED METAL SHOWN
SCALE:15X



SOLDEMASK DETAILS

4214841/E 08/2024

NOTES: (continued)

- 4. Publication IPC-7351 may have alternate designs.
- 5. Solder mask tolerances between and around signal pads can vary based on board fabrication site.

EXAMPLE STENCIL DESIGN

DDC0006A

SOT-23 - 1.1 max height

SMALL OUTLINE TRANSISTOR

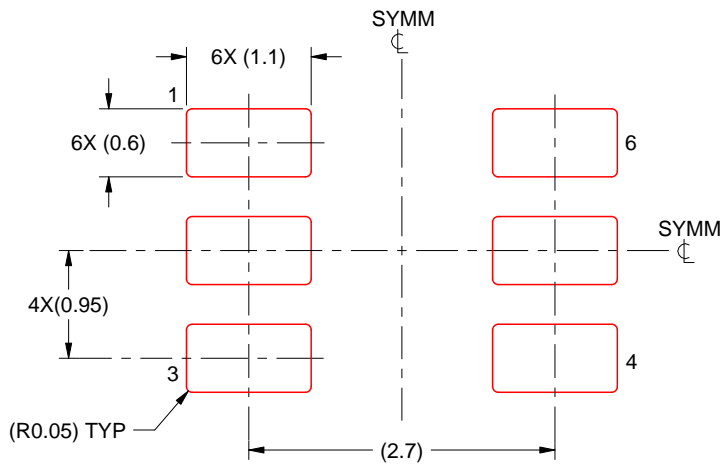

SOLDER PASTE EXAMPLE
BASED ON 0.125 THICK STENCIL
SCALE:15X

4214841/E 08/2024

NOTES: (continued)

6. Laser cutting apertures with trapezoidal walls and rounded corners may offer better paste release. IPC-7525 may have alternate design recommendations.
7. Board assembly site may have different recommendations for stencil design.

重要声明和免责声明

TI“按原样”提供技术和可靠性数据（包括数据表）、设计资源（包括参考设计）、应用或其他设计建议、网络工具、安全信息和其他资源，不保证没有瑕疵且不做任何明示或暗示的担保，包括但不限于对适销性、某特定用途方面的适用性或不侵犯任何第三方知识产权的暗示担保。

这些资源可供使用 TI 产品进行设计的熟练开发人员使用。您将自行承担以下全部责任：(1) 针对您的应用选择合适的 TI 产品，(2) 设计、验证并测试您的应用，(3) 确保您的应用满足相应标准以及任何其他功能安全、信息安全、监管或其他要求。

这些资源如有变更，恕不另行通知。TI 授权您仅可将这些资源用于研发本资源所述的 TI 产品的应用。严禁对这些资源进行其他复制或展示。您无权使用任何其他 TI 知识产权或任何第三方知识产权。您应全额赔偿因在这些资源的使用中对 TI 及其代表造成的任何索赔、损害、成本、损失和债务，TI 对此概不负责。

TI 提供的产品受 [TI 的销售条款](#) 或 [ti.com](#) 上其他适用条款/TI 产品随附的其他适用条款的约束。TI 提供这些资源并不会扩展或以其他方式更改 TI 针对 TI 产品发布的适用的担保或担保免责声明。

TI 反对并拒绝您可能提出的任何其他或不同的条款。

邮寄地址：Texas Instruments, Post Office Box 655303, Dallas, Texas 75265

Copyright © 2024，德州仪器 (TI) 公司