

INA290-Q1 2.7V 至 120V、1.1MHz 超精密电流感应放大器

1 特性

- 符合面向汽车应用的 AEC-Q100 标准：
 - 温度等级 1：-40°C 至 +125°C，T_A
- 提供功能安全
 - 可帮助进行功能安全系统设计的文档
- 宽共模电压：
 - 工作电压：2.7V 至 120V
 - 可承受电压：-20V 至 +122V
- 出色的共模抑制比 (CMRR)：
 - 160dB 直流
 - 85dB 交流 (50kHz 时)
- 精度
 - 增益：
 - 增益误差：±0.1% (最大值)
 - 增益漂移：±5ppm/°C (最大值)
 - 失调电压：
 - 失调电压：±12μV (最大值)
 - 温漂±0.2μV/°C (最大值)
- 可用增益：
 - A1 器件：20V/V
 - A2 器件：50V/V
 - A3 器件：100V/V
 - A4 器件：200V/V
 - A5 器件：500V/V
- 高带宽：1.1MHz
- 压摆率：2V/μs
- 静态电流：370μA

2 应用

- 固态 LiDAR
- 汽车 HVAC 压缩机模块
- 汽车内部加热器模块
- 汽车泊车加热器模块
- 汽车泵

3 说明

INA290-Q1 是一款超精密电流感应放大器，可在 2.7V 至 120V 的宽共模范围内测量分流电阻器上的压降。它采用节省空间的 SC-70 封装，PCB 的空间占用仅为 2.0mm × 2.1mm。该器件在 ±12μV (最大值) 的超低失调电压、±0.1% (最大值) 的小增益误差和 160dB (典型值) 的高直流 CMRR 等特性的综合作用下，可实现超高精度的电流测量精度。INA290-Q1 凭借 1.1MHz (增益为 20V/V) 的高带宽和 85dB (50kHz 时) 的交流 CMRR，不仅适用于直流电流测量，还适用于高速应用 (例如，快速过流保护)。

通过在 2.7V 至 120V 的宽共模范围内检测分流电阻器上的压降，INA290-Q1 可提供进行超精密电流测量的功能。INA290-Q1 采用 SC-70 封装，可更大程度地缩小解决方案的尺寸。

器件信息

器件型号	封装 ⁽¹⁾	封装尺寸 (标称值)
INA290-Q1	SC-70 (5)	2.00mm × 1.25mm

(1) 如需了解所有可用封装，请参阅数据表末尾的封装选项附录。

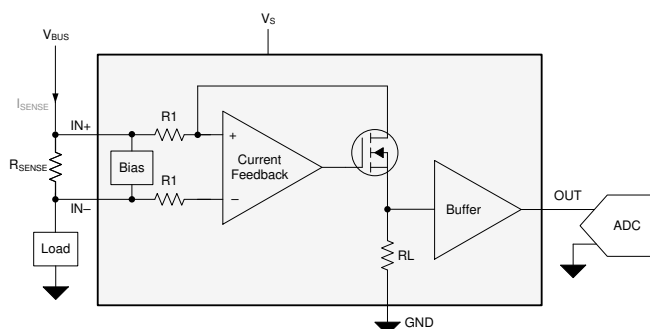

典型应用



Table of Contents

1 特性	1	8 Application and Implementation	16
2 应用	1	8.1 Application Information.....	16
3 说明	1	8.2 Typical Application.....	18
4 Revision History	2	9 Power Supply Recommendations	20
5 Pin Configuration and Functions	3	10 Layout	20
6 Specifications	4	10.1 Layout Guidelines.....	20
6.1 Absolute Maximum Ratings	4	10.2 Layout Example.....	20
6.2 ESD Ratings	4	11 Device and Documentation Support	21
6.3 Recommended Operating Conditions	4	11.1 Documentation Support.....	21
6.4 Thermal Information	4	11.2 接收文档更新通知.....	21
6.5 Electrical Characteristics	5	11.3 支持资源.....	21
6.6 Typical Characteristics.....	6	11.4 Trademarks.....	21
7 Detailed Description	12	11.5 静电放电警告.....	21
7.1 Overview.....	12	11.6 术语表.....	21
7.2 Functional Block Diagram.....	12	12 Mechanical, Packaging, and Orderable Information	21
7.3 Feature Description.....	13		
7.4 Device Functional Modes.....	15		

4 Revision History

注：以前版本的页码可能与当前版本的页码不同

Changes from Revision * (October 2019) to Revision A (November 2020)	Page
• 将数据表状态从“预告信息”更改为“生产数据”	1
• 更新了整个文档中的表格、图和交叉参考的编号格式.....	1

5 Pin Configuration and Functions



图 5-1. DCK Package 5-Pin SC-70 Top View

表 5-1. Pin Functions

PIN		TYPE	DESCRIPTION
NAME	NO.		
GND	2	Ground	Ground
IN -	5	Input	Connect to load side of shunt resistor
IN+	4	Input	Connect to supply side of shunt resistor
OUT	1	Output	Output voltage
VS	3	Power	Power supply

6 Specifications

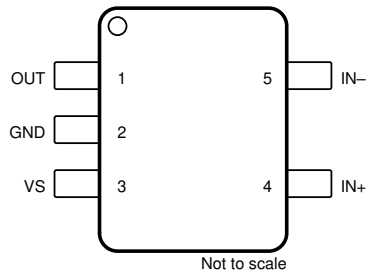
6.1 Absolute Maximum Ratings

over operating free-air temperature range (unless otherwise noted)⁽¹⁾

		MIN	MAX	UNIT
V _S	Supply Voltage	- 0.3	22	V
Analog Inputs, V _{IN+} , V _{IN-} ⁽²⁾	Differential (V _{IN+}) - (V _{IN-})	- 30	30	V
	Common - mode	- 20	122	V
Output		GND - 0.3	V _S + 0.3	V
T _A	Operating Temperature	- 55	150	°C
T _J	Junction temperature		150	°C
T _{stg}	Storage temperature	- 65	150	°C

- (1) Stresses beyond those listed under Absolute Maximum Ratings may cause permanent damage to the device. These are stress ratings only, which do not imply functional operation of the device at these or any other conditions beyond those indicated under Recommended Operating Conditions. Exposure to absolute-maximum-rated conditions for extended periods may affect device reliability.
- (2) V_{IN+} and V_{IN-} are the voltages at the V_{IN+} and V_{IN-} pins, respectively.

6.2 ESD Ratings

			VALUE	UNIT
V _(ESD)	Electrostatic discharge	Human body model (HBM), per AEC Q100-002, all pins ⁽¹⁾ HBM ESD Classification Level 2	±2000	V
		Charged device model (CDM), per AEC Q100-011, all pins CDM ESD Classification Level C6	±1000	

- (1) AEC Q100-002 indicates that HBM stressing shall be in accordance with the ANSI/ESDA/JEDEC JS-001 specification.

6.3 Recommended Operating Conditions

over operating free-air temperature range (unless otherwise noted)

		MIN	NOM	MAX	UNIT
V _{CM}	Common-mode input range ⁽¹⁾	V _S	48	120	V
V _S	Operating supply range	2.7	5	20	V
T _A	Ambient temperature	- 40		125	°C

- (1) Common-mode voltage can go below V_S under certain conditions. See [Figure 7-1](#) for additional information on operating range.

6.4 Thermal Information

THERMAL METRIC ⁽¹⁾		INA290-Q1	UNIT
		DCK (SC-70)	
		5 PINS	
R _{θJA}	Junction-to-ambient thermal resistance	191.6	°C/W
R _{θJC(top)}	Junction-to-case (top) thermal resistance	144.4	°C/W
R _{θJB}	Junction-to-board thermal resistance	69.2	°C/W
Ψ _{JT}	Junction-to-top characterization parameter	46.2	°C/W
Ψ _{JB}	Junction-to-board characterization parameter	69.0	°C/W
R _{θJC(bot)}	Junction-to-case (bottom) thermal resistance	N/A	°C/W

- (1) For more information about traditional and new thermal metrics, see the [Semiconductor and IC Package Thermal Metrics](#) application report.

6.5 Electrical Characteristics

at $T_A = 25\text{ }^\circ\text{C}$, $V_S = 5\text{ V}$, $V_{\text{SENSE}} = V_{\text{IN}+} - V_{\text{IN}-} = 0.5\text{ V}$ / Gain, $V_{\text{CM}} = V_{\text{IN}-} = 48\text{ V}$ (unless otherwise noted)

PARAMETER		TEST CONDITIONS	MIN	TYP	MAX	UNIT
INPUT						
CMRR	Common-mode rejection ratio	$V_{\text{CM}} = 2.7\text{ V to } 120\text{ V}$, $T_A = -40\text{ }^\circ\text{C to } +125\text{ }^\circ\text{C}$ $f = 50\text{ kHz}$	140	160		dB
				85		
V_{os}	Offset voltage, input referred	A1 devices		5	± 25	μV
		A2 devices		3	± 20	
		A3 devices		3	± 15	
		A4, A5 devices		2	± 12	
dV_{os}/dT	Offset voltage drift	$T_A = -40\text{ }^\circ\text{C to } +125\text{ }^\circ\text{C}$			0.2	$\mu\text{V}/^\circ\text{C}$
PSRR	Power supply rejection ratio, input referred	$V_S = 2.7\text{ V to } 20\text{ V}$, $T_A = -40\text{ }^\circ\text{C to } +125\text{ }^\circ\text{C}$		0.05	± 0.5	$\mu\text{V}/\text{V}$
I_B	Input bias current	I_{B+} , $V_{\text{SENSE}} = 0\text{ mV}$	10	20	30	μA
		I_{B-} , $V_{\text{SENSE}} = 0\text{ mV}$	10	20	30	
OUTPUT						
G	Gain	A1 devices		20		V/V
		A2 devices		50		
		A3 devices		100		
		A4 devices		200		
		A5 devices		500		
	Gain error	A1, A2, A3 devices, $\text{GND} + 50\text{ mV} \leq V_{\text{OUT}} \leq V_S - 200\text{ mV}$		0.02	± 0.1	%
		A4, A5 devices, $\text{GND} + 50\text{ mV} \leq V_{\text{OUT}} \leq V_S - 200\text{ mV}$		0.02	± 0.15	
	Gain error drift	$T_A = -40\text{ }^\circ\text{C to } +125\text{ }^\circ\text{C}$		1.5	5	ppm/ $^\circ\text{C}$
	Nonlinearity error			0.01		%
	Maximum capacitive load	No sustained oscillations, no isolation resistor		500		pF
VOLTAGE OUTPUT						
	Swing to V_S power supply rail	$R_{\text{LOAD}} = 10\text{ k}\Omega$, $T_A = -40\text{ }^\circ\text{C to } +125\text{ }^\circ\text{C}$		$V_S - 0.07$	$V_S - 0.2$	V
	Swing to ground	$R_{\text{LOAD}} = 10\text{ k}\Omega$, $V_{\text{SENSE}} = 0\text{ V}$, $T_A = -40\text{ }^\circ\text{C to } +125\text{ }^\circ\text{C}$		0.005	0.025	V
FREQUENCY RESPONSE						
BW	Bandwidth	A1 devices, $C_{\text{LOAD}} = 5\text{ pF}$, $V_{\text{SENSE}} = 200\text{ mV}$		1100		kHz
		A2 devices, $C_{\text{LOAD}} = 5\text{ pF}$, $V_{\text{SENSE}} = 80\text{ mV}$		1100		
		A3 devices, $C_{\text{LOAD}} = 5\text{ pF}$, $V_{\text{SENSE}} = 40\text{ mV}$		900		
		A4 devices, $C_{\text{LOAD}} = 5\text{ pF}$, $V_{\text{SENSE}} = 20\text{ mV}$		850		
		A5 devices, $C_{\text{LOAD}} = 5\text{ pF}$, $V_{\text{SENSE}} = 8\text{ mV}$		800		
SR	Slew rate			2		V/ μs
	Settling time	$V_{\text{OUT}} = 4\text{ V} \pm 0.1\text{ V}$ step, output settles to 0.5%		9		μs
		$V_{\text{OUT}} = 4\text{ V} \pm 0.1\text{ V}$ step, output settles to 1%		5		
NOISE						
V_{e_n}	Voltage noise density			50		nV/ $\sqrt{\text{Hz}}$
POWER SUPPLY						
V_S	Supply voltage	$T_A = -40\text{ }^\circ\text{C to } +125\text{ }^\circ\text{C}$	2.7		20	V
I_Q	Quiescent current, INA290			370	500	μA
		$T_A = -40\text{ }^\circ\text{C to } +125\text{ }^\circ\text{C}$			600	

6.6 Typical Characteristics

All specifications at $T_A = 25\text{ }^\circ\text{C}$, $V_S = 5\text{ V}$, $V_{SENSE} = V_{IN+} - V_{IN-} = 0.5\text{ V} / \text{Gain}$, and $V_{CM} = V_{IN-} = 48\text{ V}$, unless otherwise noted.



图 6-1. Input Offset Production Distribution, A1 Devices



图 6-2. Input Offset Production Distribution, A2 Devices

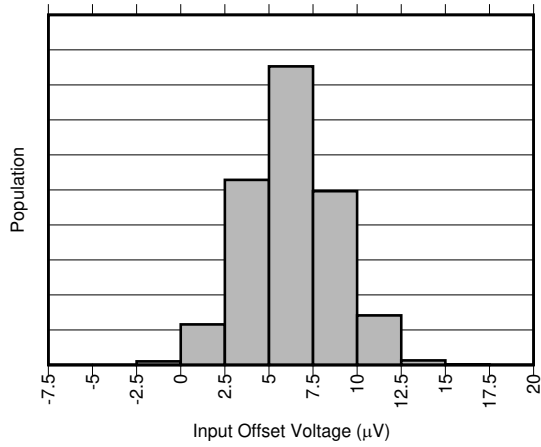

图 6-3. Input Offset Production Distribution, A3 Devices

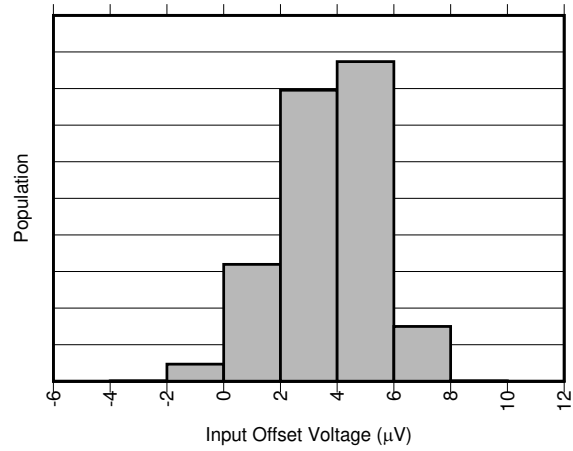

图 6-4. Input Offset Production Distribution, A4 Devices

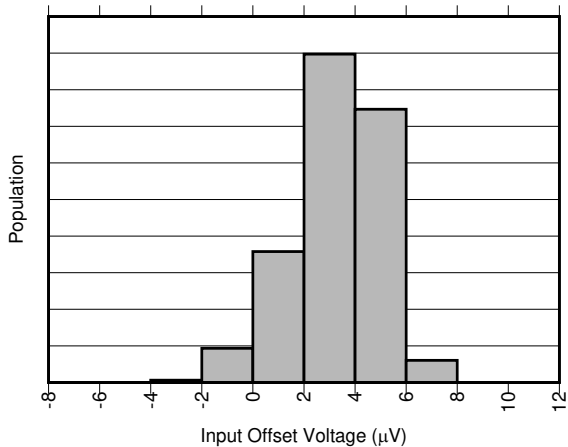

图 6-5. Input Offset Production Distribution, A5 Devices

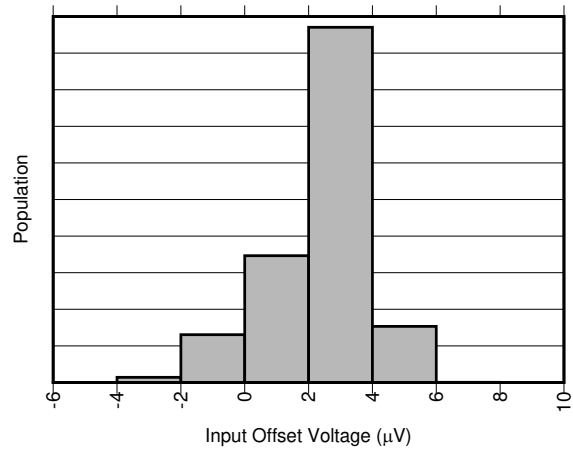

图 6-6. Input Offset Voltage vs Temperature

6.6 Typical Characteristics (continued)

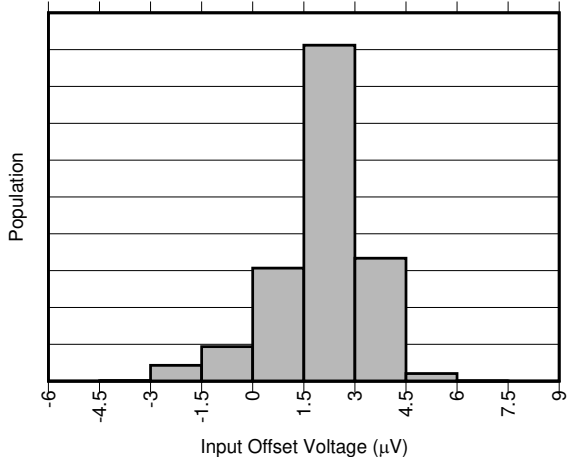
All specifications at $T_A = 25\text{ }^\circ\text{C}$, $V_S = 5\text{ V}$, $V_{SENSE} = V_{IN+} - V_{IN-} = 0.5\text{ V} / \text{Gain}$, and $V_{CM} = V_{IN-} = 48\text{ V}$, unless otherwise noted.

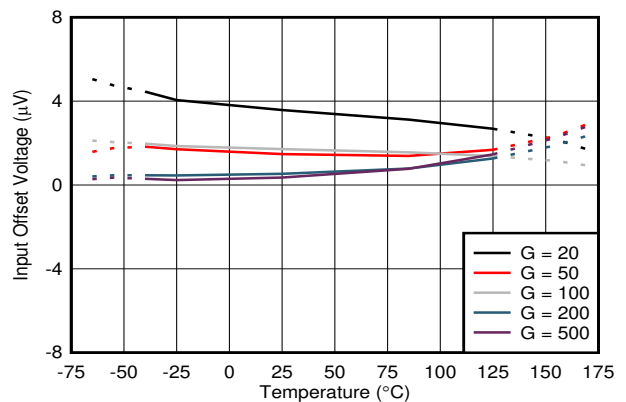

图 6-7. Common-Mode Rejection Ratio vs Temperature



图 6-8. Common-Mode Rejection Ratio vs Frequency

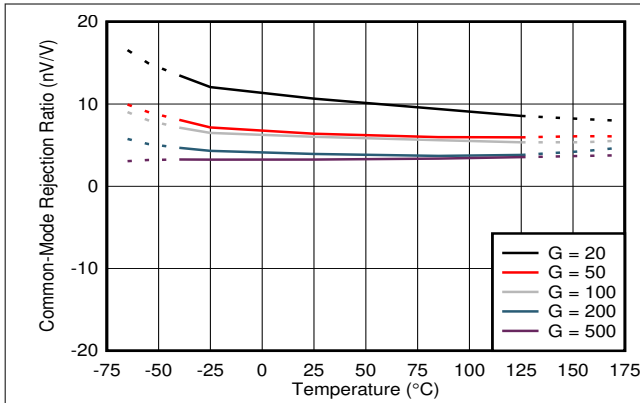

图 6-9. Gain vs Frequency

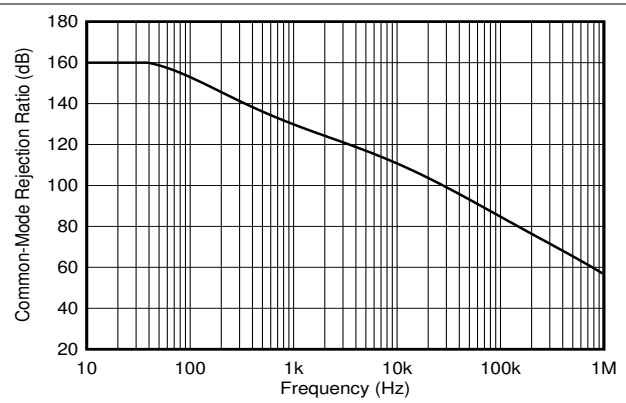

图 6-10. Gain Error vs Temperature

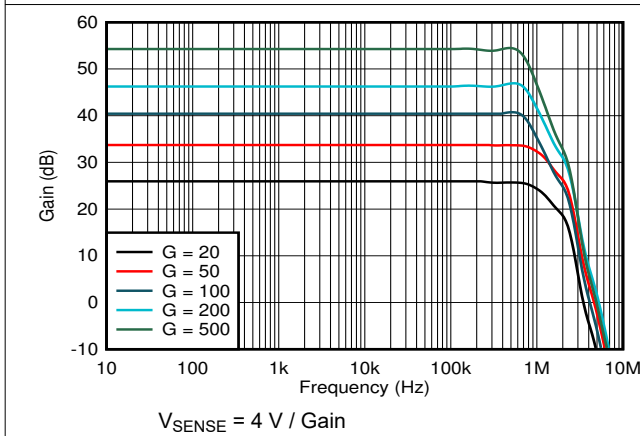

图 6-11. Power-Supply Rejection Ratio vs Temperature

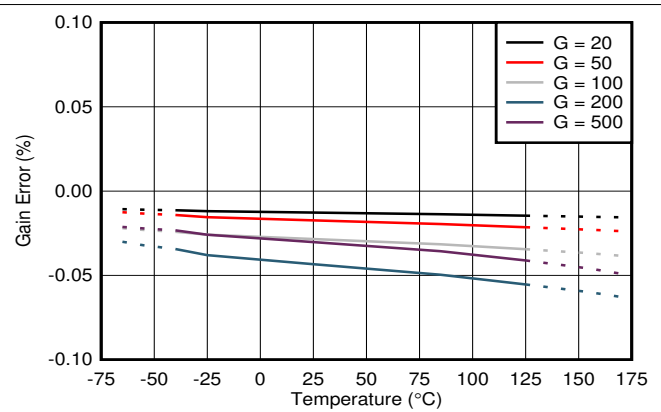

图 6-12. Power-Supply Rejection Ratio vs Frequency

6.6 Typical Characteristics (continued)

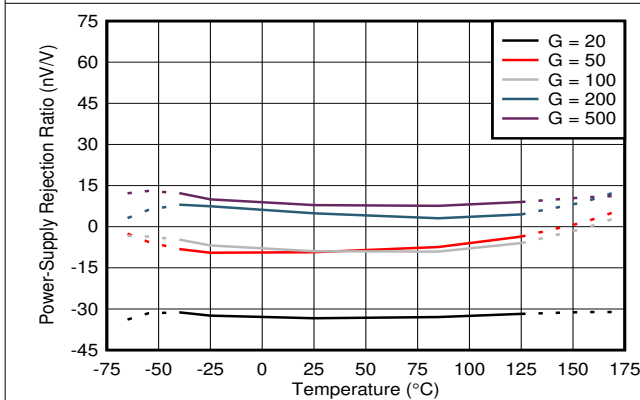
All specifications at $T_A = 25^\circ\text{C}$, $V_S = 5\text{ V}$, $V_{\text{SENSE}} = V_{\text{IN}+} - V_{\text{IN}-} = 0.5\text{ V} / \text{Gain}$, and $V_{\text{CM}} = V_{\text{IN}-} = 48\text{ V}$, unless otherwise noted.

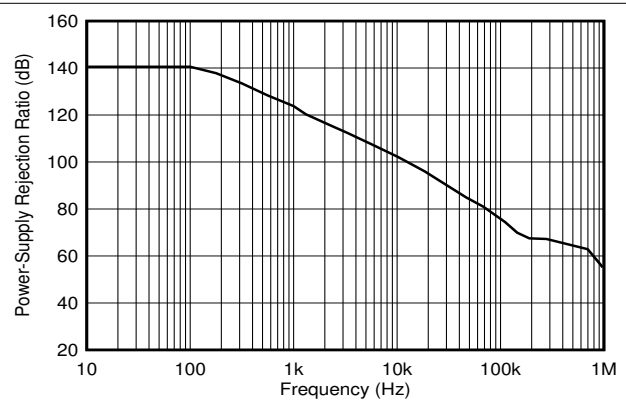

图 6-13. Input Bias Current vs Common-Mode Voltage



图 6-14. Input Bias Current vs Temperature

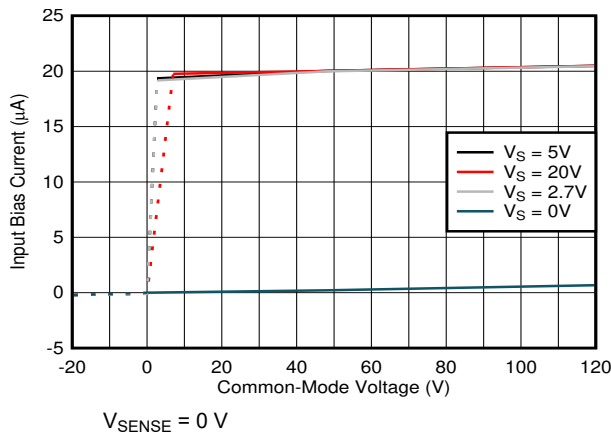

图 6-15. Input Bias Current vs V_{SENSE} , A1 Devices

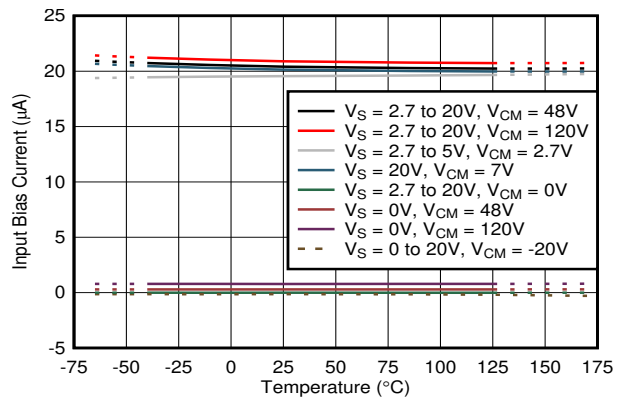

图 6-16. Input Bias Current vs V_{SENSE} , A2 and A3 Devices

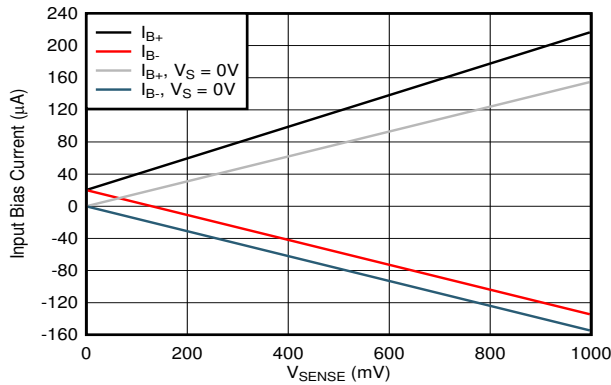

图 6-17. Input Bias Current vs V_{SENSE} , A4 and A5 Devices

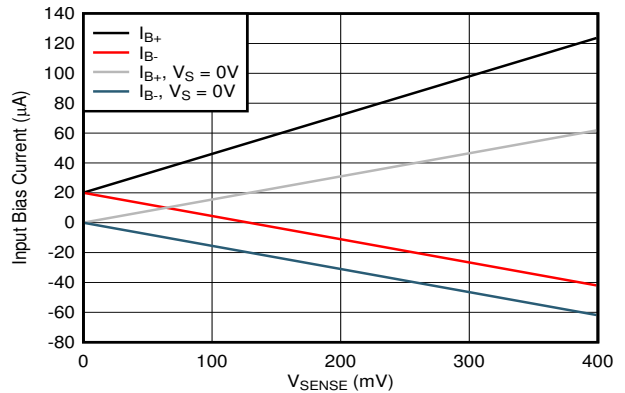

$V_S = 2.7\text{ V}$

图 6-18. Output Voltage vs Output Current

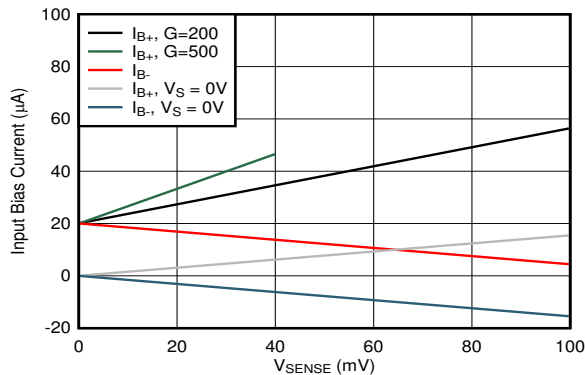
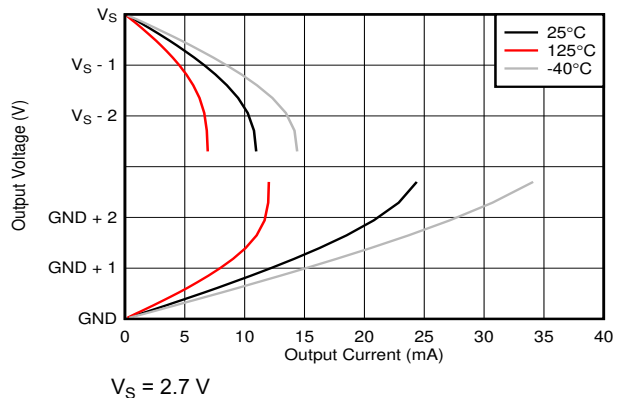
6.6 Typical Characteristics (continued)

All specifications at $T_A = 25^\circ\text{C}$, $V_S = 5\text{ V}$, $V_{\text{SENSE}} = V_{\text{IN}+} - V_{\text{IN}-} = 0.5\text{ V}$ / Gain, and $V_{\text{CM}} = V_{\text{IN}-} = 48\text{ V}$, unless otherwise noted.



图 6-19. Output Voltage vs Output Current



图 6-20. Output Voltage vs Output Current

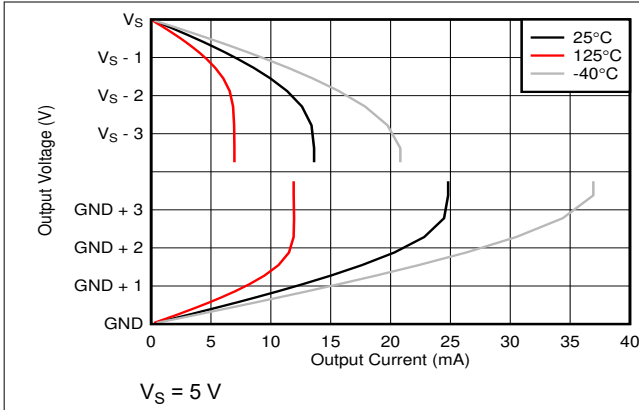

图 6-21. Output Impedance vs Frequency

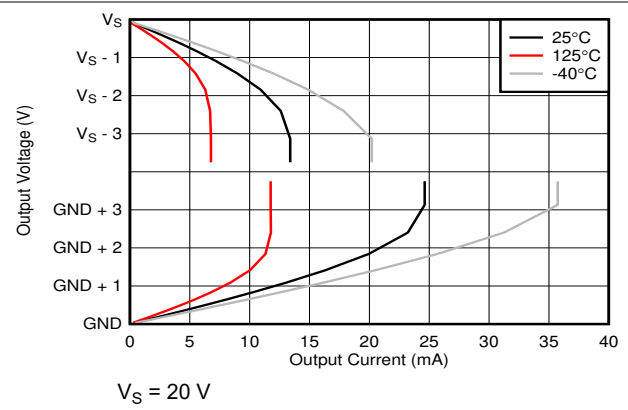

图 6-22. Swing to Supply vs Temperature

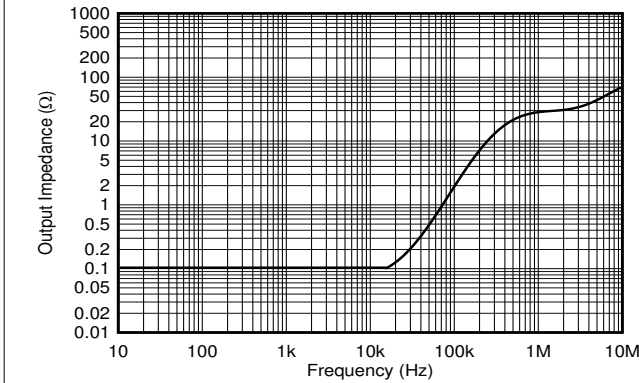

图 6-23. Swing to GND vs Temperature

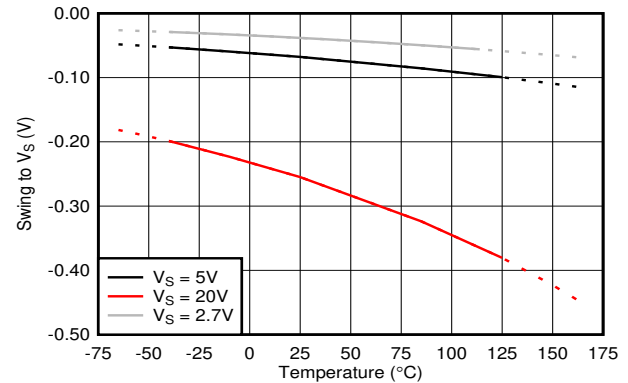

图 6-24. Input Referred Noise vs Frequency

6.6 Typical Characteristics (continued)

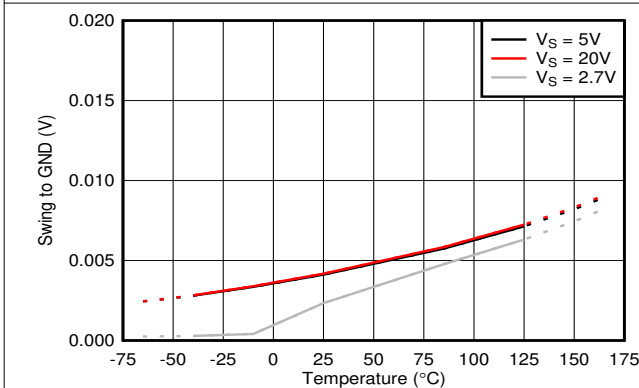
All specifications at $T_A = 25^\circ\text{C}$, $V_S = 5\text{ V}$, $V_{\text{SENSE}} = V_{\text{IN}+} - V_{\text{IN}-} = 0.5\text{ V} / \text{Gain}$, and $V_{\text{CM}} = V_{\text{IN}-} = 48\text{ V}$, unless otherwise noted.

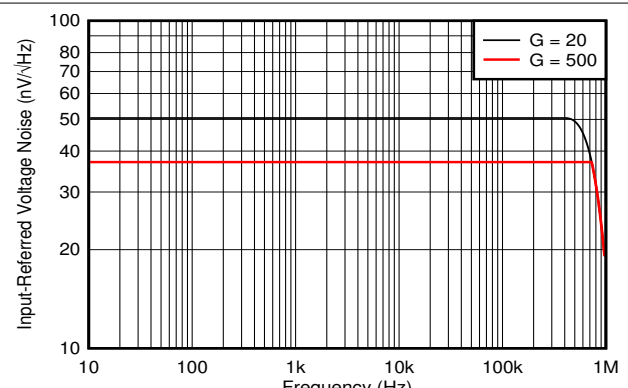

图 6-25. Input Referred Noise



图 6-26. Quiescent Current vs Output Voltage, INA290

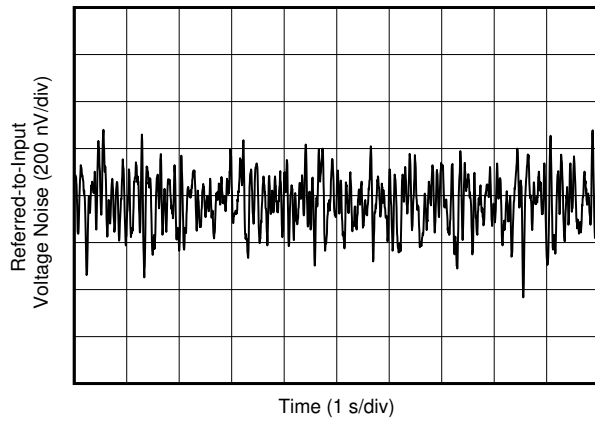

图 6-27. Quiescent Current vs Temperature, INA290

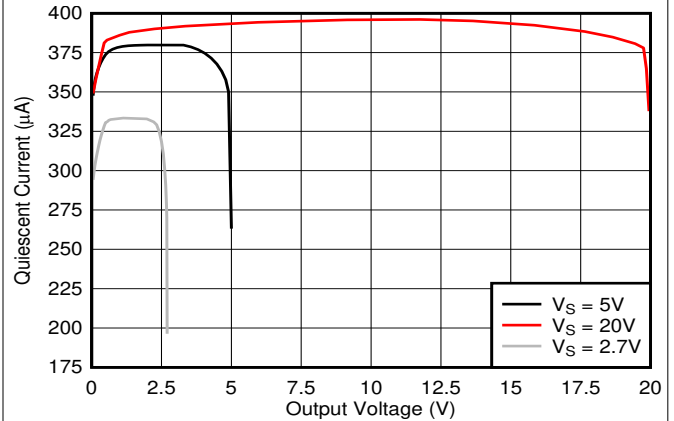

图 6-28. Short-Circuit Current vs Temperature

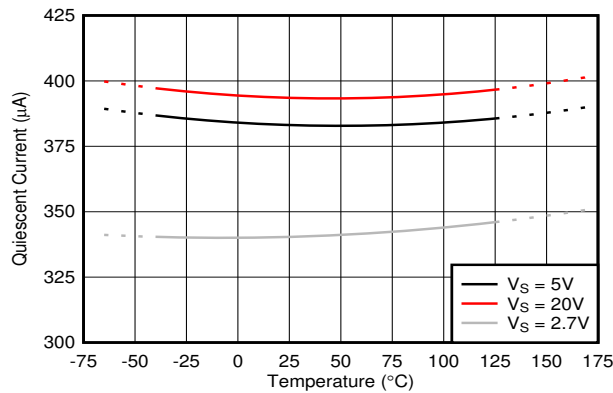

图 6-29. Quiescent Current vs Supply Voltage, INA290

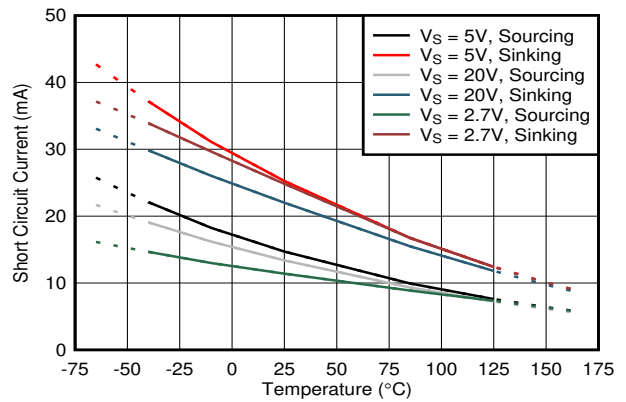

图 6-30. Quiescent Current vs Common-Mode Voltage, INA290

6.6 Typical Characteristics (continued)

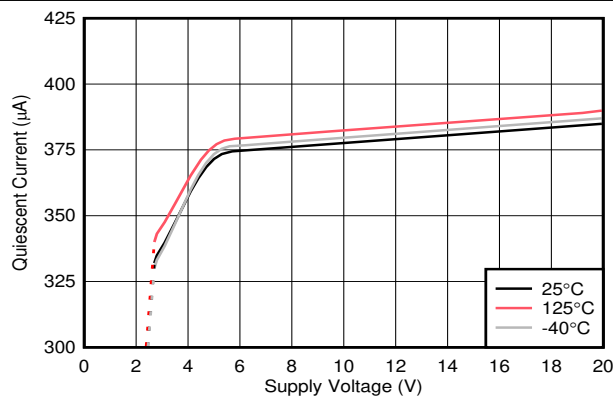
All specifications at $T_A = 25\text{ }^\circ\text{C}$, $V_S = 5\text{ V}$, $V_{SENSE} = V_{IN+} - V_{IN-} = 0.5\text{ V} / \text{Gain}$, and $V_{CM} = V_{IN-} = 48\text{ V}$, unless otherwise noted.

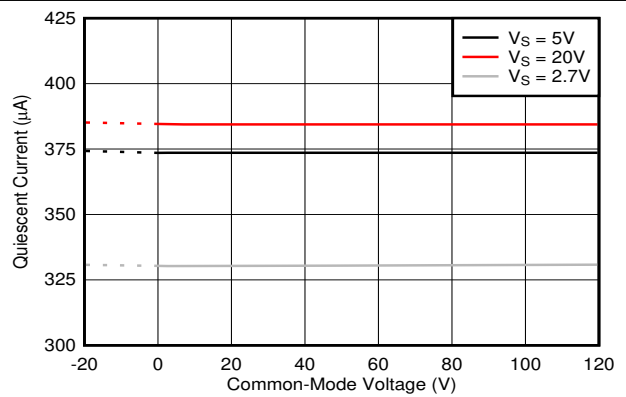
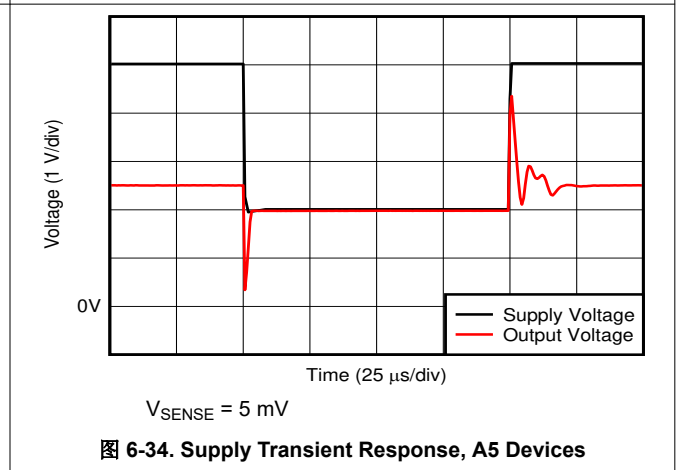
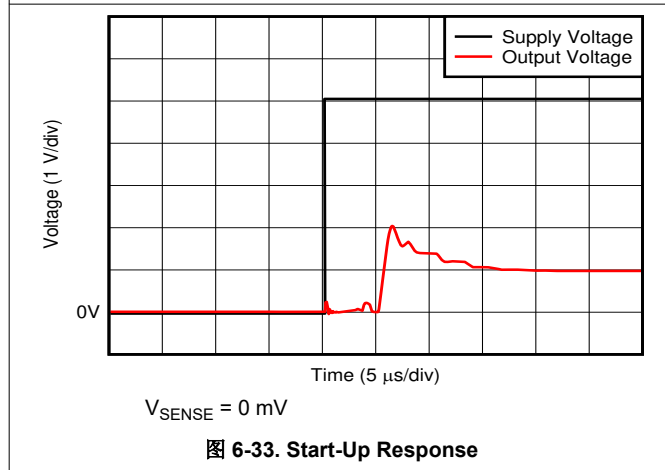
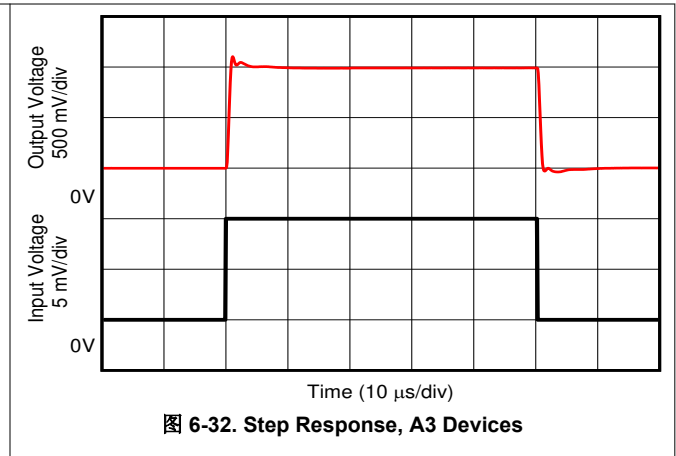
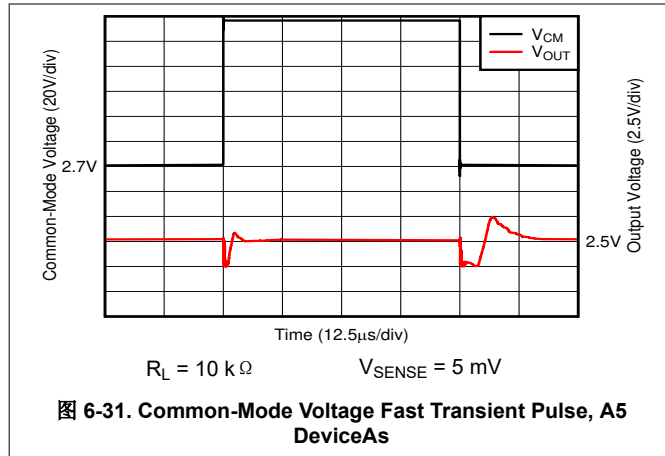

7 Detailed Description

7.1 Overview

The INA290-Q1 is a high-side only current-sense amplifier that offers a wide common-mode range, precision zero-drift topology, excellent common-mode rejection ratio (CMRR), high bandwidth, and fast slew rate. Different gain versions are available to optimize the output dynamic range based on the application. The INA290-Q1 is designed using a transconductance architecture with a current-feedback amplifier that enables low bias currents of 20 μ A and a common-mode voltage of 120 V.

7.2 Functional Block Diagram

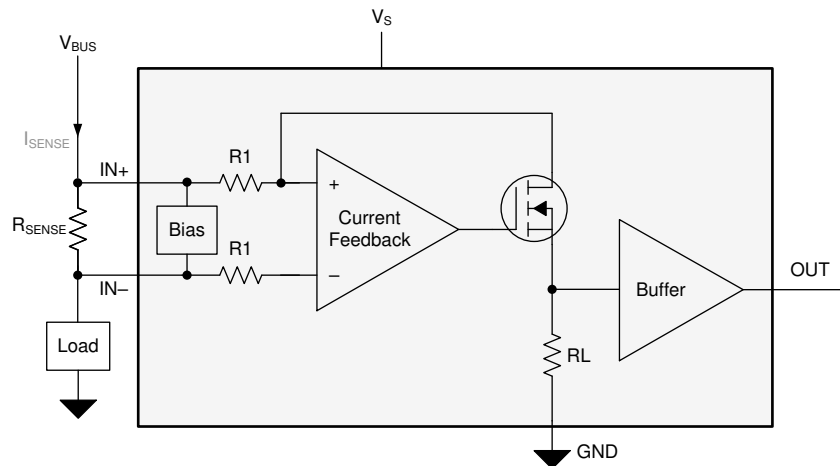

7.3 Feature Description

7.3.1 Amplifier Input Common-Mode Range

The INA290-Q1 supports large input common-mode voltages from 2.7 V to 120 V and features a high DC CMRR of 160 dB (typical) and a 85-dB AC CMRR at 50 kHz. The minimum common-mode voltage is restricted by the supply voltage as shown in [Figure 7-1](#). The topology of the internal amplifiers INA290-Q1 restricts operation to high-side, current-sensing applications.



图 7-1. Minimum Common-Mode Voltage vs Supply

7.3.1.1 Input-Signal Bandwidth

The INA290-Q1 -3-dB bandwidth is gain dependent with several gain options of 20 V/V, 50 V/V, 100 V/V, 200 V/V, and 500 V/V as shown in [Figure 6-8](#). The unique multistage design enables the amplifier to achieve high bandwidth at all gains. This high bandwidth provides the throughput and fast response that is required for the rapid detection and processing of overcurrent events.

The bandwidth of the device also depends on the applied V_{SENSE} voltage. [Figure 7-2](#) shows the bandwidth performance profile of the device over frequency as output voltage increases for each gain variation. As shown in [Figure 7-2](#), the device exhibits the highest bandwidth with higher V_{SENSE} voltages, and the bandwidth is higher with lower device gain options. Individual requirements determine the acceptable limits of error for high-frequency, current-sensing applications. Testing and evaluation in the end application or circuit is required to determine the acceptance criteria and validate whether or not the performance levels meet the system specifications.

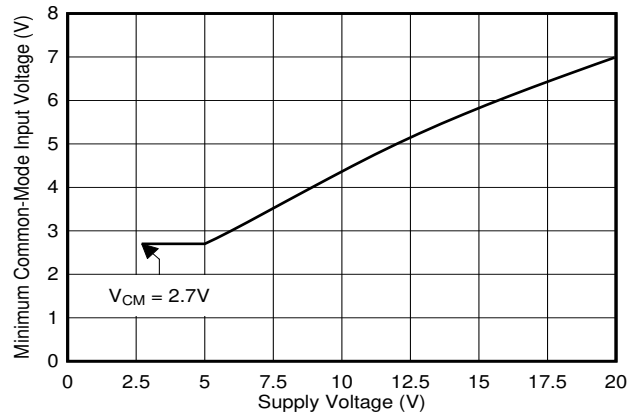

图 7-2. Bandwidth vs Output Voltage

7.3.1.2 Low Input Bias Current

The INA290-Q1 input bias current draws 20 μA (typical) even with common-mode voltages as high as 120 V. This enables precision current sensing in applications where the sensed current is small or applications that require lower input leakage current.

7.3.1.3 Low V_{SENSE} Operation

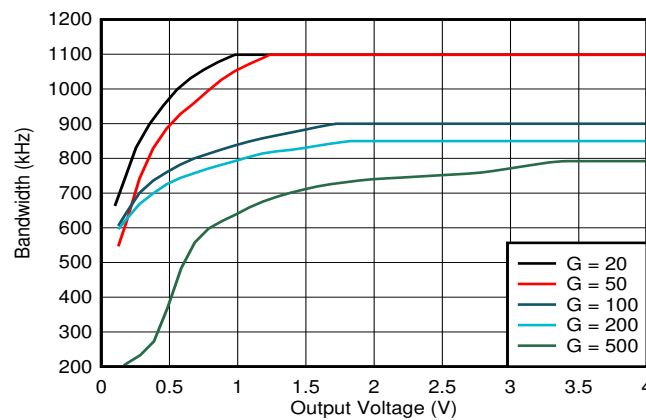
The INA290-Q1 enables accurate current measurement across the entire valid V_{SENSE} range. The zero-drift input architecture of the INA290-Q1 provides the low offset voltage and low offset drift needed to measure low V_{SENSE} levels accurately across the wide operating temperature of $-40\text{ }^{\circ}\text{C}$ to $+125\text{ }^{\circ}\text{C}$. The capability to measure low sense voltages enables accurate measurements at lower load currents, and also allows reduction of the sense resistor value for a given operating current, which minimizes the power loss in the current sensing element.

7.3.1.4 Wide Fixed Gain Output

The INA290-Q1 gain error is $< 0.1\%$ at room temperature for most gain options, with a maximum drift of 5 ppm/ $^{\circ}\text{C}$ over the full temperature range of $-40\text{ }^{\circ}\text{C}$ to $+125\text{ }^{\circ}\text{C}$. The INA290-Q1 is available in multiple gain options of 20 V/V, 50 V/V, 100 V/V, 200 V/V, and 500 V/V, which the system designer should select based on their desired signal-to-noise ratio and other system requirements.

The INA290-Q1 closed-loop gain is set by a precision, low-drift internal resistor network. The ratio of these resistors are excellently matched, while the absolute values may vary significantly. TI does not recommend adding additional resistance around the INA290-Q1 to change the effective gain because of this variation, however. The typical values of the gain resistors are described in [表 7-1](#).

表 7-1. Fixed Gain Resistor

GAIN	R1	RL
20 (V/V)	25 k Ω	500 k Ω
50 (V/V)	10 k Ω	500 k Ω
100 (V/V)	10 k Ω	1000 k Ω
200 (V/V)	5 k Ω	1000 k Ω
500 (V/V)	2 k Ω	1000 k Ω

7.3.1.5 Wide Supply Range

The INA290-Q1 operates with a wide supply range from a 2.7 V to 20 V. The output stage supports a full-scale output voltage range of up to V_{S} . Wide output range can enable very-wide dynamic range current measurements. For a gain of 20 V/V, the maximum differential input acceptable is 1 V.

The offset of the gain of INA290-Q1A1 device is $\pm 25\text{ }\mu\text{V}$, and the INA290-Q1A1 is capable of measuring a wide dynamic range of current up to 92 dB.

7.4 Device Functional Modes

7.4.1 Unidirectional Operation

The INA290-Q1 measures the differential voltage developed by current flowing through a resistor that is commonly referred to as a current-sensing resistor or a current-shunt resistor. The INA290-Q1 operates in unidirectional mode only, meaning it only senses current sourced from a power supply to a system load as shown in 图 7-3.



图 7-3. Unidirectional Application

The linear range of the output stage is limited to how close the output voltage can approach ground under zero-input conditions. The zero current output voltage of the INA290-Q1 is very small, with a maximum of GND + 25 mV. Make sure to apply a sense voltage of (25 mV / Gain) or greater to keep the INA290-Q1 output in the linear region of operation.

7.4.2 High Signal Throughput

With a bandwidth of 1.1 MHz at a gain of 20 V/V and a slew rate of 2 V/ μ s, the INA290-Q1 is specifically designed for detecting and protecting applications from fast inrush currents. As shown in 表 7-2, the INA290-Q1 responds in less than 2 μ s for a system measuring a 75-A threshold on a 2-m Ω shunt.

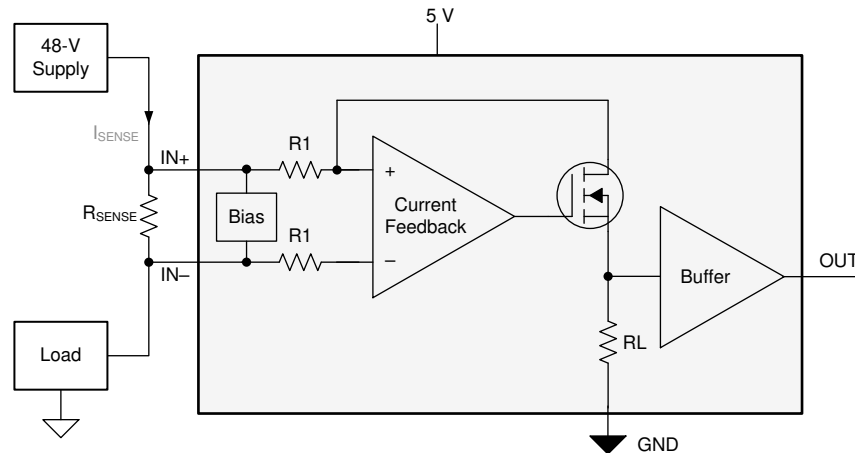
表 7-2. Response Time

PARAMETER		EQUATION	INA290-Q1 AT $V_S = 5$ V
G	Gain		20 V/V
I_{MAX}	Maximum current		100 A
$I_{Threshold}$	Threshold current		75 A
R_{SENSE}	Current sense resistor value		2 m Ω
V_{OUT_MAX}	Output voltage at maximum current	$V_{OUT} = I_{MAX} \times R_{SENSE} \times G$	4 V
V_{OUT_THR}	Output voltage at threshold current	$V_{OUT_THR} = I_{THR} \times R_{SENSE} \times G$	3 V
SR	Slew rate		2 V/ μ s
	Output response time	$T_{response} = V_{OUT_THR} / SR$	< 2 μ s

8 Application and Implementation

Note

以下应用部分的信息不属于 TI 组件规范，TI 不担保其准确性和完整性。客户应负责确定 TI 组件是否适用于其应用。客户应验证并测试其设计，以确保系统功能。

8.1 Application Information

The INA290-Q1 amplifies the voltage developed across a current-sensing resistor as current flows through the resistor to the load. The wide input common-mode voltage range and high common-mode rejection of the INA290-Q1 allows use over a wide range of voltage rails while still maintaining an accurate current measurement.

8.1.1 R_{SENSE} and Device Gain Selection

The accuracy of any current-sense amplifier is maximized by choosing the current-sense resistor to be as large as possible. A large sense resistor maximizes the differential input signal for a given amount of current flow and reduces the error contribution of the offset voltage. However, there are practical limits as to how large the current-sense resistor can be in a given application because of the resistor size and maximum allowable power dissipation. [方程式 1](#) gives the maximum value for the current-sense resistor for a given power dissipation budget:

$$R_{\text{SENSE}} < \frac{PD_{\text{MAX}}}{I_{\text{MAX}}^2} \quad (1)$$

where:

- PD_{MAX} is the maximum allowable power dissipation in R_{SENSE}.
- I_{MAX} is the maximum current that will flow through R_{SENSE}.

An additional limitation on the size of the current-sense resistor and device gain is due to the power-supply voltage, V_S, and device swing-to-rail limitations. To make sure that the current-sense signal is properly passed to the output, both positive and negative output swing limitations must be examined. [方程式 2](#) provides the maximum values of R_{SENSE} and GAIN to keep the device from exceeding the positive swing limitation.

$$I_{\text{MAX}} \times R_{\text{SENSE}} \times \text{GAIN} < V_{\text{SP}} \quad (2)$$

where:

- I_{MAX} is the maximum current that will flow through R_{SENSE}.
- GAIN is the gain of the current-sense amplifier.
- V_{SP} is the positive output swing as specified in the data sheet.

To avoid positive output swing limitations when selecting the value of R_{SENSE}, there is always a trade-off between the value of the sense resistor and the gain of the device under consideration. If the sense resistor selected for the maximum power dissipation is too large, then it is possible to select a lower-gain device in order to avoid positive swing limitations.

The negative swing limitation places a limit on how small the sense resistor value can be for a given application. [方程式 3](#) provides the limit on the minimum value of the sense resistor.

$$I_{\text{MIN}} \times R_{\text{SENSE}} \times \text{GAIN} > V_{\text{SN}} \quad (3)$$

where:

- I_{MIN} is the minimum current that will flow through R_{SENSE}.
- GAIN is the gain of the current-sense amplifier.

- V_{SN} is the negative output swing of the device.

表 8-1 shows an example of the different results obtained from using five different gain versions of the INA290-Q1. From the table data, the highest gain device allows a smaller current-shunt resistor and decreased power dissipation in the element.

表 8-1. R_{SENSE} Selection and Power Dissipation

PARAMETER ⁽¹⁾		EQUATION	RESULTS AT $V_S = 5\text{ V}$				
			INA290A1Q	INA290A2Q	INA290A3Q	INA290A4Q	INA290A5Q
G	Gain		20 V/V	50 V/V	100 V/V	200 V/V	500 V/V
V_{SENSE}	Ideal differential input voltage (Ignores swing limitation and power supply variation.)	$V_{SENSE} = V_{OUT} / G$	250 mV	100 mV	50 mV	25 mV	10 mV
R_{SENSE}	Current sense resistor value	$R_{SENSE} = V_{SENSE} / I_{MAX}$	25 m Ω	10 m Ω	5 m Ω	2.5 m Ω	1 m Ω
P_{SENSE}	Current-sense resistor power dissipation	$R_{SENSE} \times I_{MAX}^2$	2.5 W	1 W	0.5W	0.25 W	0.1 W

(1) Design example with 10-A full-scale current with maximum output voltage set to 5 V.

8.1.2 Input Filtering

Note

Input filters are not required for accurate measurements using the INA290-Q1, and use of filters in this location is not recommended. If filter components are used on the input of the amplifier, follow the guidelines in this section to minimize the effects on performance.

Based strictly on user design requirements, external filtering of the current signal may be desired. The initial location that can be considered for the filter is at the output of the current-sense amplifier. Although placing the filter at the output satisfies the filtering requirements, this location changes the low output impedance measured by any circuitry connected to the output voltage pin. The other location for filter placement is at the current-sense amplifier input pins. This location also satisfies the filtering requirement, but the components must be carefully selected to minimally impact device performance. 图 8-1 shows a filter placed at the input pins.



图 8-1. Filter at Input Pins

External series resistance provides a source of additional measurement error, so keep the value of these series resistors to 10 Ω or less to reduce loss of accuracy. The internal bias network shown in 图 8-1 creates a mismatch in input bias currents (see 图 6-15, 图 6-16, and 图 6-17) when a differential voltage is applied between the input pins. If additional external series filter resistors are added to the circuit, a mismatch is created in the voltage drop across the filter resistors. This voltage is a differential error voltage in the shunt resistor voltage. In addition to the absolute resistor value, mismatch resulting from resistor tolerance can significantly impact the error because this value is calculated based on the actual measured resistance.

The measurement error expected from the additional external filter resistors can be calculated using 方程式 4, where the gain error factor is calculated using 方程式 5.

$$\text{Gain Error (\%)} = 100 \times (\text{Gain Error Factor} - 1) \tag{4}$$

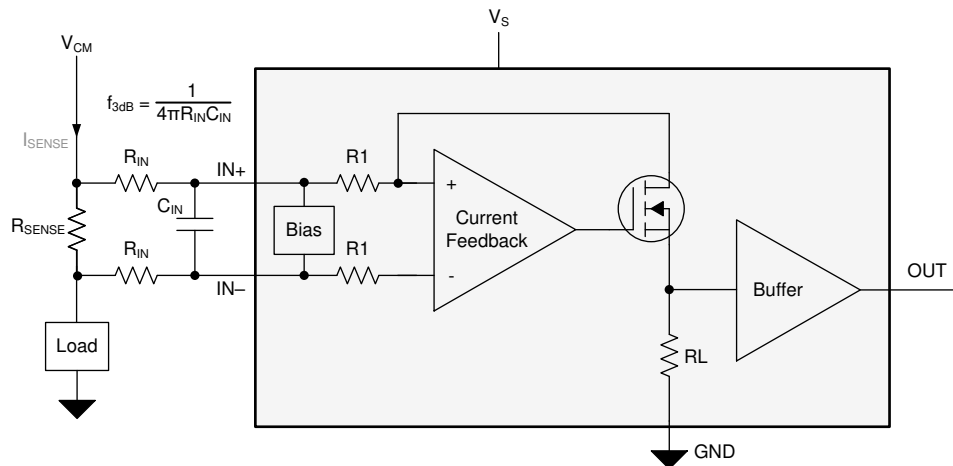
The gain error factor, shown in 方程式 4, can be calculated to determine the gain error introduced by the additional external series resistance. 方程式 4 calculates the deviation of the shunt voltage, resulting from the attenuation and imbalance created by the added external filter resistance. 表 8-2 provides the gain error factor and gain error for several resistor values.

$$\text{Gain Error Factor} = \frac{R_B \times R1}{(R_B \times R1) + (R_B \times R_{IN}) + (2 \times R_{IN} \times R1)} \tag{5}$$

Where:

- R_{IN} is the external filter resistance value.
- R1 is the INA290-Q1 input resistance value specified in 表 7-1.
- R_B in the internal bias resistance, which is $6600 \Omega \pm 20\%$.

表 8-2. Example Gain Error Factor and Gain Error for 10-Ω External Filter Input Resistors

DEVICE (GAIN)	GAIN ERROR FACTOR	GAIN ERROR (%)
A1 devices (20)	0.99658	- 0.34185
A2 devices (50)	0.99598	- 0.40141
A3 devices (100)	0.99598	- 0.40141
A4 devices (200)	0.99499	- 0.50051
A5 devices (500)	0.99203	- 0.79663

8.2 Typical Application

The INA290-Q1 is a unidirectional, current-sense amplifier capable of measuring currents through a resistive shunt with shunt common-mode voltages from 2.7 V to 120 V. The circuit configuration for monitoring current in a high-side pump or motor is shown in 图 8-2 .



图 8-2. Current Sensing in a Automotive Pump

8.2.1 Design Requirements

V_{SUPPLY} is set to 5 V, and the common-mode voltage set to 48 V. 表 8-3 lists the design setup for this application.

表 8-3. Design Parameters

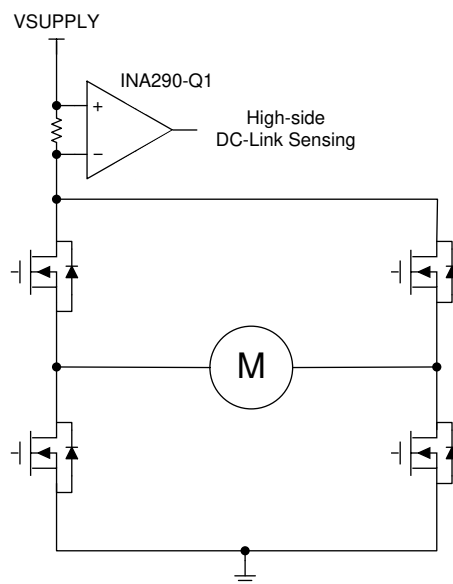
DESIGN PARAMETERS	EXAMPLE VALUE
INA290-Q1 supply voltage	5 V
High-side supply voltage	48 V
Maximum sense current (I_{MAX})	5 A
Gain option	50 V/V

8.2.2 Detailed Design Procedure

The maximum value of the current-sense resistor is calculated based choice of gain, value of the maximum current the be sensed (I_{MAX}), and the power-supply voltage (V_{S}). When operating at the maximum current, the output voltage must not exceed the positive output swing specification, V_{SP} . Under the given design parameters, 方程式 6 calculates the maximum value for R_{SENSE} as 19.2 m Ω .

$$R_{\text{SENSE}} < \frac{V_{\text{SP}}}{I_{\text{MAX}} \times \text{GAIN}} \quad (6)$$

For this design example, a value of 15 m Ω is selected because, while the 15 m Ω is less than the maximum value calculated, 15 m Ω is still large enough to give adequate signal at the current-sense amplifier output.

8.2.2.1 Overload Recovery With Negative V_{SENSE}

The INA290-Q1 is a unidirectional current-sense amplifier that is meant to operate with a positive differential input voltage (V_{SENSE}). If negative V_{SENSE} is applied, the device is placed in an overload condition and requires time to recover once V_{SENSE} returns positive. The required overload recovery time increases with more negative V_{SENSE} .

8.2.3 Application Curve

图 8-3 shows the output response of the device to a high frequency sinusoidal current.



图 8-3. INA290-Q1 Output Response

9 Power Supply Recommendations

The input circuitry of the INA290-Q1 device can accurately measure beyond the power-supply voltage. The power supply can be 20 V, whereas the load power-supply voltage at IN+ and IN – can go up to 120 V. The output voltage range of the OUT pin is limited by the voltage on the V_S pin and the device swing to supply specification.

10 Layout

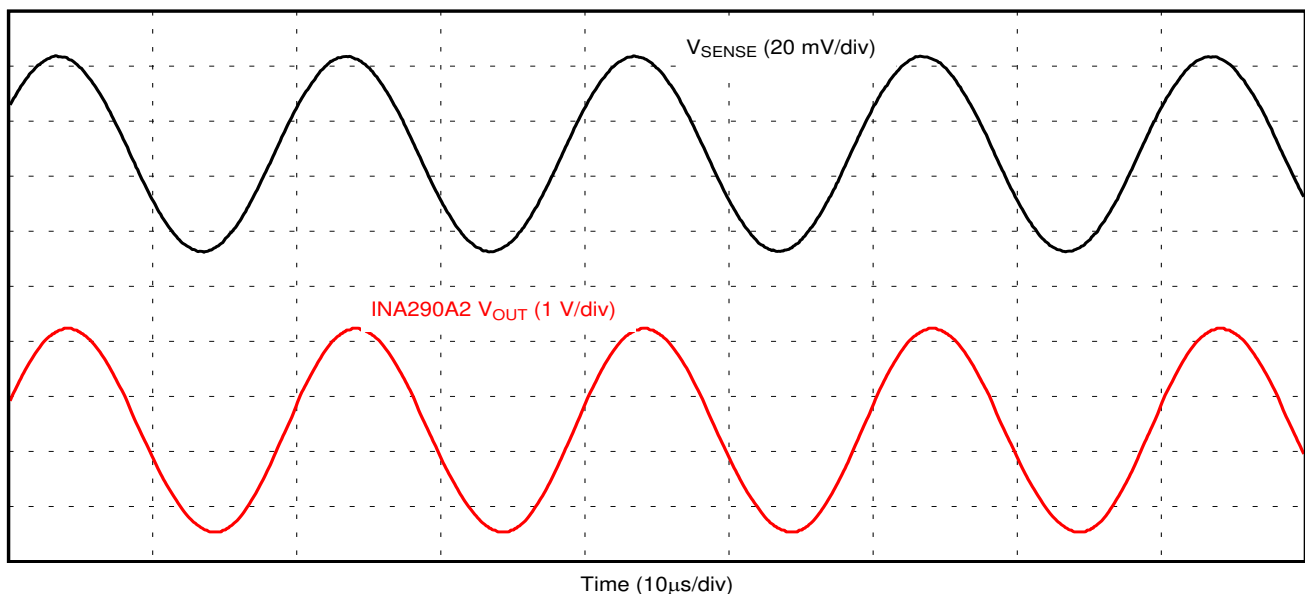
10.1 Layout Guidelines

TI always recommends to follow good layout practices:

- Connect the input pins to the sensing resistor using a Kelvin or 4-wire connection. This connection technique makes sure that only the current-sensing resistor impedance is detected between the input pins. Poor routing of the current-sensing resistor commonly results in additional resistance present between the input pins. Given the very low ohmic value of the current resistor, any additional high-current carrying impedance can cause significant measurement errors.
- Place the power-supply bypass capacitor as close to the device power supply and ground pins as possible. The recommended value of this bypass capacitor is 0.1 μF . Additional decoupling capacitance can be added to compensate for noisy or high-impedance power supplies.
- When routing the connections from the current-sense resistor to the device, keep the trace lengths as short as possible.

10.2 Layout Example



图 10-1. Recommended Layout for INA290-Q1

11 Device and Documentation Support

11.1 Documentation Support

11.1.1 Related Documentation

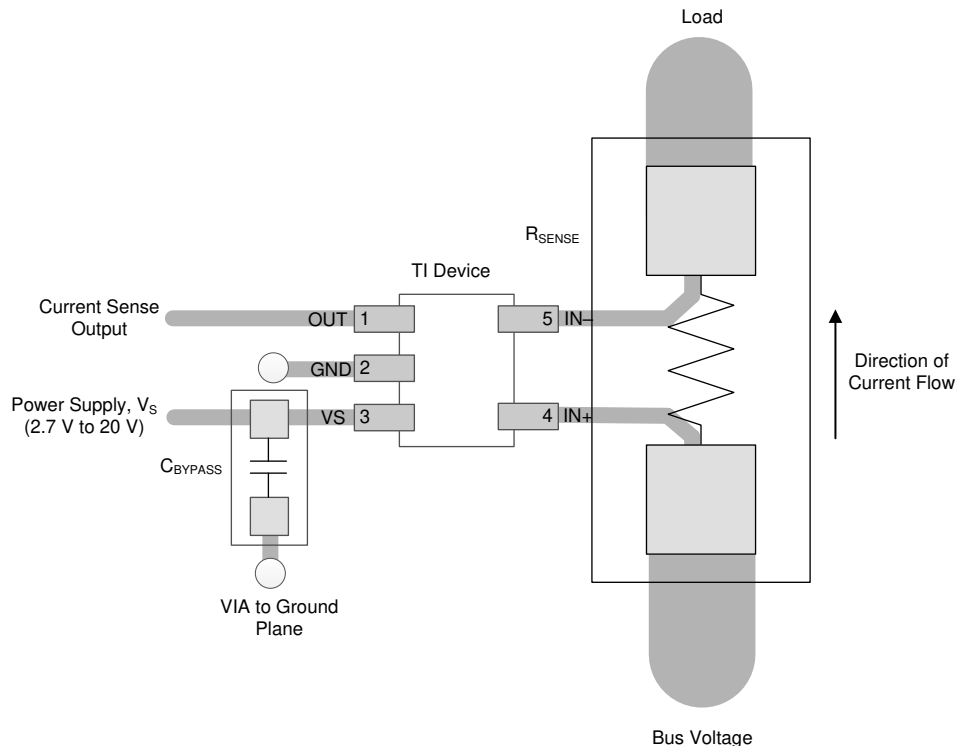
For related documentation, see the following:

Texas Instruments, [INA290EVM User's Guide](#)

11.2 接收文档更新通知

要接收文档更新通知，请导航至 [ti.com](#) 上的器件产品文件夹。点击 [订阅更新](#) 进行注册，即可每周接收产品信息更改摘要。有关更改的详细信息，请查看任何已修订文档中包含的修订历史记录。

11.3 支持资源

[TI E2E™ 支持论坛](#) 是工程师的重要参考资料，可直接从专家获得快速、经过验证的解答和设计帮助。搜索现有解答或提出自己的问题可获得所需的快速设计帮助。

链接的内容由各个贡献者“按原样”提供。这些内容并不构成 TI 技术规范，并且不一定反映 TI 的观点；请参阅 TI 的《[使用条款](#)》。

11.4 Trademarks

TI E2E™ is a trademark of Texas Instruments.

所有商标均为其各自所有者的财产。

11.5 静电放电警告



静电放电 (ESD) 会损坏这个集成电路。德州仪器 (TI) 建议通过适当的预防措施处理所有集成电路。如果不遵守正确的处理和安装程序，可能会损坏集成电路。

ESD 的损坏小至导致微小的性能降级，大至整个器件故障。精密的集成电路可能更容易受到损坏，这是因为非常细微的参数更改都可能会导致器件与其发布的规格不相符。

11.6 术语表

[TI 术语表](#) 本术语表列出并解释了术语、首字母缩略词和定义。

12 Mechanical, Packaging, and Orderable Information

The following pages include mechanical, packaging, and orderable information. This information is the most current data available for the designated devices. This data is subject to change without notice and revision of this document. For browser-based versions of this data sheet, refer to the left-hand navigation.

PACKAGING INFORMATION

Orderable Device	Status (1)	Package Type	Package Drawing	Pins	Package Qty	Eco Plan (2)	Lead finish/ Ball material (6)	MSL Peak Temp (3)	Op Temp (°C)	Device Marking (4/5)	Samples
INA290A1QDCKRQ1	ACTIVE	SC70	DCK	5	3000	RoHS & Green	NIPDAU	Level-1-260C-UNLIM	-40 to 125	1G6	Samples
INA290A2QDCKRQ1	ACTIVE	SC70	DCK	5	3000	RoHS & Green	NIPDAU	Level-1-260C-UNLIM	-40 to 125	1G8	Samples
INA290A3QDCKRQ1	ACTIVE	SC70	DCK	5	3000	RoHS & Green	NIPDAU	Level-1-260C-UNLIM	-40 to 125	1G7	Samples
INA290A4QDCKRQ1	ACTIVE	SC70	DCK	5	3000	RoHS & Green	NIPDAU	Level-1-260C-UNLIM	-40 to 125	1G9	Samples
INA290A5QDCKRQ1	ACTIVE	SC70	DCK	5	3000	RoHS & Green	NIPDAU	Level-1-260C-UNLIM	-40 to 125	1GA	Samples

(1) The marketing status values are defined as follows:

ACTIVE: Product device recommended for new designs.

LIFEBUY: TI has announced that the device will be discontinued, and a lifetime-buy period is in effect.

NRND: Not recommended for new designs. Device is in production to support existing customers, but TI does not recommend using this part in a new design.

PREVIEW: Device has been announced but is not in production. Samples may or may not be available.

OBSELETE: TI has discontinued the production of the device.

(2) **RoHS:** TI defines "RoHS" to mean semiconductor products that are compliant with the current EU RoHS requirements for all 10 RoHS substances, including the requirement that RoHS substance do not exceed 0.1% by weight in homogeneous materials. Where designed to be soldered at high temperatures, "RoHS" products are suitable for use in specified lead-free processes. TI may reference these types of products as "Pb-Free".

RoHS Exempt: TI defines "RoHS Exempt" to mean products that contain lead but are compliant with EU RoHS pursuant to a specific EU RoHS exemption.

Green: TI defines "Green" to mean the content of Chlorine (Cl) and Bromine (Br) based flame retardants meet JS709B low halogen requirements of <=1000ppm threshold. Antimony trioxide based flame retardants must also meet the <=1000ppm threshold requirement.

(3) MSL, Peak Temp. - The Moisture Sensitivity Level rating according to the JEDEC industry standard classifications, and peak solder temperature.

(4) There may be additional marking, which relates to the logo, the lot trace code information, or the environmental category on the device.

(5) Multiple Device Markings will be inside parentheses. Only one Device Marking contained in parentheses and separated by a "~" will appear on a device. If a line is indented then it is a continuation of the previous line and the two combined represent the entire Device Marking for that device.

(6) Lead finish/Ball material - Orderable Devices may have multiple material finish options. Finish options are separated by a vertical ruled line. Lead finish/Ball material values may wrap to two lines if the finish value exceeds the maximum column width.

Important Information and Disclaimer: The information provided on this page represents TI's knowledge and belief as of the date that it is provided. TI bases its knowledge and belief on information provided by third parties, and makes no representation or warranty as to the accuracy of such information. Efforts are underway to better integrate information from third parties. TI has taken and continues to take reasonable steps to provide representative and accurate information but may not have conducted destructive testing or chemical analysis on incoming materials and chemicals. TI and TI suppliers consider certain information to be proprietary, and thus CAS numbers and other limited information may not be available for release.

In no event shall TI's liability arising out of such information exceed the total purchase price of the TI part(s) at issue in this document sold by TI to Customer on an annual basis.

TAPE AND REEL INFORMATION



QUADRANT ASSIGNMENTS FOR PIN 1 ORIENTATION IN TAPE



*All dimensions are nominal

Device	Package Type	Package Drawing	Pins	SPQ	Reel Diameter (mm)	Reel Width W1 (mm)	A0 (mm)	B0 (mm)	K0 (mm)	P1 (mm)	W (mm)	Pin1 Quadrant
INA290A1QDCKRQ1	SC70	DCK	5	3000	180.0	8.4	2.47	2.3	1.25	4.0	8.0	Q3
INA290A2QDCKRQ1	SC70	DCK	5	3000	180.0	8.4	2.47	2.3	1.25	4.0	8.0	Q3
INA290A3QDCKRQ1	SC70	DCK	5	3000	180.0	8.4	2.47	2.3	1.25	4.0	8.0	Q3
INA290A4QDCKRQ1	SC70	DCK	5	3000	180.0	8.4	2.47	2.3	1.25	4.0	8.0	Q3
INA290A5QDCKRQ1	SC70	DCK	5	3000	180.0	8.4	2.47	2.3	1.25	4.0	8.0	Q3

TAPE AND REEL BOX DIMENSIONS



*All dimensions are nominal

Device	Package Type	Package Drawing	Pins	SPQ	Length (mm)	Width (mm)	Height (mm)
INA290A1QDCKRQ1	SC70	DCK	5	3000	183.0	183.0	20.0
INA290A2QDCKRQ1	SC70	DCK	5	3000	183.0	183.0	20.0
INA290A3QDCKRQ1	SC70	DCK	5	3000	183.0	183.0	20.0
INA290A4QDCKRQ1	SC70	DCK	5	3000	183.0	183.0	20.0
INA290A5QDCKRQ1	SC70	DCK	5	3000	183.0	183.0	20.0

DCK0005A



PACKAGE OUTLINE

SOT - 1.1 max height

SMALL OUTLINE TRANSISTOR

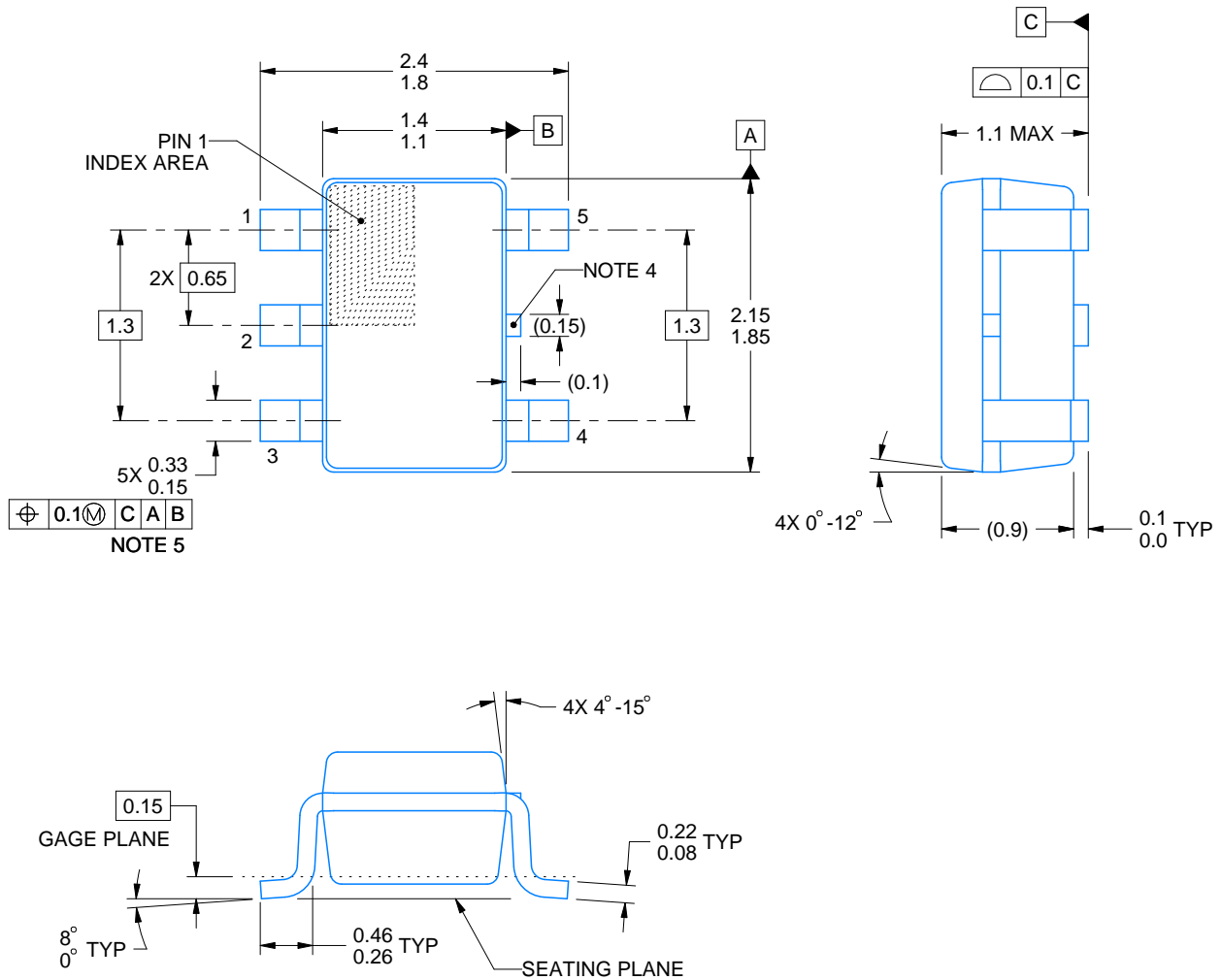

4214834/G 11/2024

NOTES:

1. All linear dimensions are in millimeters. Any dimensions in parenthesis are for reference only. Dimensioning and tolerancing per ASME Y14.5M.
2. This drawing is subject to change without notice.
3. Reference JEDEC MO-203.
4. Support pin may differ or may not be present.
5. Lead width does not comply with JEDEC.
6. Body dimensions do not include mold flash, protrusions, or gate burrs. Mold flash, protrusions, or gate burrs shall not exceed 0.25mm per side

EXAMPLE BOARD LAYOUT

DCK0005A

SOT - 1.1 max height

SMALL OUTLINE TRANSISTOR



LAND PATTERN EXAMPLE
EXPOSED METAL SHOWN
SCALE:18X

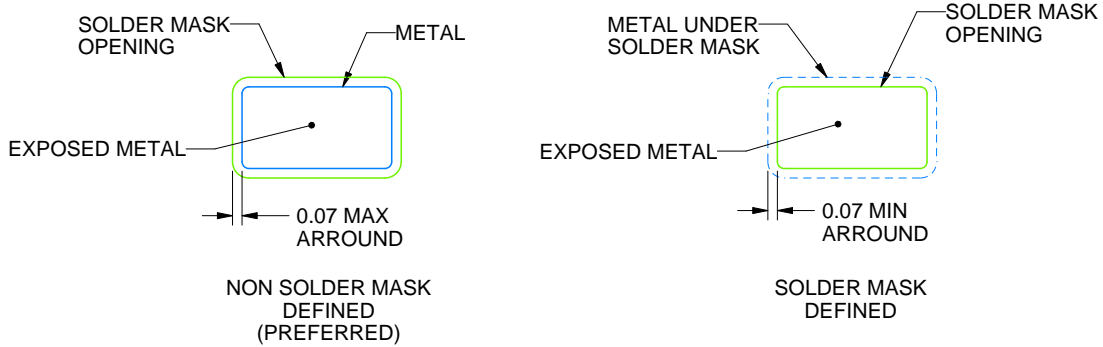

SOLDER MASK DETAILS

4214834/G 11/2024

NOTES: (continued)

- 7. Publication IPC-7351 may have alternate designs.
- 8. Solder mask tolerances between and around signal pads can vary based on board fabrication site.

EXAMPLE STENCIL DESIGN

DCK0005A

SOT - 1.1 max height

SMALL OUTLINE TRANSISTOR



SOLDER PASTE EXAMPLE
BASED ON 0.125 THICK STENCIL
SCALE:18X

4214834/G 11/2024

NOTES: (continued)

9. Laser cutting apertures with trapezoidal walls and rounded corners may offer better paste release. IPC-7525 may have alternate design recommendations.
10. Board assembly site may have different recommendations for stencil design.

重要通知和免责声明

TI“按原样”提供技术和可靠性数据（包括数据表）、设计资源（包括参考设计）、应用或其他设计建议、网络工具、安全信息和其他资源，不保证没有瑕疵且不做任何明示或暗示的担保，包括但不限于对适销性、某特定用途方面的适用性或不侵犯任何第三方知识产权的暗示担保。

这些资源可供使用 TI 产品进行设计的熟练开发人员使用。您将自行承担以下全部责任：(1) 针对您的应用选择合适的 TI 产品，(2) 设计、验证并测试您的应用，(3) 确保您的应用满足相应标准以及任何其他功能安全、信息安全、监管或其他要求。

这些资源如有变更，恕不另行通知。TI 授权您仅可将这些资源用于研发本资源所述的 TI 产品的相关应用。严禁以其他方式对这些资源进行复制或展示。您无权使用任何其他 TI 知识产权或任何第三方知识产权。您应全额赔偿因在这些资源的使用中对 TI 及其代表造成的任何索赔、损害、成本、损失和债务，TI 对此概不负责。

TI 提供的产品受 [TI 的销售条款](#) 或 [ti.com](#) 上其他适用条款/TI 产品随附的其他适用条款的约束。TI 提供这些资源并不会扩展或以其他方式更改 TI 针对 TI 产品发布的适用的担保或担保免责声明。

TI 反对并拒绝您可能提出的任何其他或不同的条款。

邮寄地址：Texas Instruments, Post Office Box 655303, Dallas, Texas 75265
版权所有 © 2025，德州仪器 (TI) 公司