

TI 设计: TIDA-00750

采用 3D 飞行时间 (ToF) 的需求控制通风人数统计参考设计



说明

TIDA-00750 设计是一种子系统解决方案, 它使用 TI 的 3D ToF 影像传感器以及跟踪和检测算法对给定区域中的人进行计数, 可实现高分辨率和高精度。该传感器技术是在标准 CMOS 中开发的, 可使系统能够以低成本实现很高的集成度。由于 ToF 影像传感器以三维处理可视化数据, 因此传感器可以检测到人体的精确形状并以前所未有的精度跟踪人的移动和位置 (包括微小的移动变化)。因此, ToF 摄像头能够比传统监控摄像头和视频分析更加高效地执行实时人数统计和人员跟踪功能。

资源

TIDA-00750	设计文件夹
OPT8241	产品文件夹
OPT9221	产品文件夹
AM437x	产品文件夹
OPT8241-CDK-EVM	工具文件夹
MYIR AM437x Rico 板	工具文件夹



请咨询我们的 E2E 专家

特性

- 精度: > 90%
- 可配置的响应时间、可实时或定期提供的占位数据
- 宽视场: H74.4° x V59.3°
- 3D ToF 摄像头独立于环境光, 能够在黑暗中工作
 - 自动照明
 - 四个 NIR 激光可提供较大的照明区域
 - 短漫射激光脉冲可提供固有的眼睛安全性
- 与 CO2 传感器不同, 性能不受局部高 CO2 浓度、EMI 或任何其他污染物影响
- 在嵌入式平台上运行
- 无活动部件或定期校准

应用

- HVAC: 需求控制通风
- 智能电梯
- 机器视觉
- 对象检测
- 手势检测
- 机器人
- 楼宇安全与安防

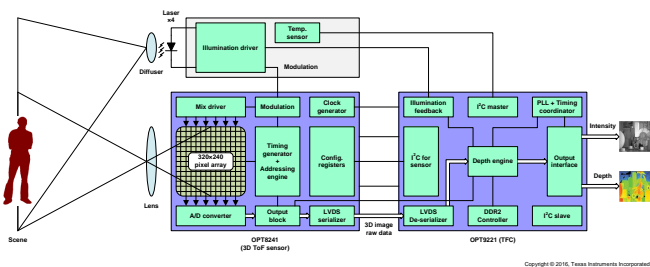

该 TI 参考设计末尾的重要声明表述了授权使用、知识产权问题和其他重要的免责声明和信息。

1 System Description

Locating and tracking groups of people in real time is hard to solve using conventional camera systems in many advanced applications. Tracking approaches can be primarily categorized based on types of devices deployed, whether they are monocular or stereoscopic camera systems. 2D tracking approaches suffer from occlusion and fail to handle close interactions. 3D tracking approaches based on stereoscopic camera have potential for dealing with some major tracking issues. However, the performance of most 3D stereo camera-based tracking systems start dropping quickly when the scene lacks texture due to either poor illumination or homogeneous objects.

Most commonly used passive infrared (PIR) based occupancy sensors indicate only when the room is occupied or unoccupied, but they cannot determine the number of people in a given area. For example, gas sensing techniques such as CO₂-based occupancy detection sensors are subjected to accuracy issues over time and slow in detecting change of events, whereas large-scale deployment of conventional camera systems incurs substantial deployment costs and maintenance overhead. They also bring up privacy issues as they detect more than what is required. What is missing is a precise, economical, compact, and universal imaging sensor that can capture the entire depth map (intensity and range information) of a scene at the same instance in just one image capture. Under all that, the new technology known as time of flight (ToF) 3D imaging technology appears to have significant advantages over traditional surveillance cameras and video analytics in several ways because surveillance cameras only record visual data in 2D, which limits the accuracy and potential sophistication of video analysis software. With additional information such as the distance to each point in the scene, the algorithmic challenges become more controllable.

This TI Design is a subsystem solution that relies on TI's high-performance 320x240 QVGA resolution 3D ToF image sensor combined with tracking and detection algorithms to count the number of occupants present in a given area. The camera sensor with ToF pixels allows 3D imaging with high resolution and accuracy. The sensor technology is developed in standard CMOS, allowing systems to achieve very high integration at low cost. Because ToF image sensor processes visual data in three dimensions, they can detect the exact shape of the human body and track the movement and location of people with exceptional precision, including subtle movement changes. For this reason, ToF cameras are potentially capable of performing real-time people counting and people tracking functions much more effectively than traditional surveillance cameras and video analytics.

This reference design measures occupancy directly (as opposed to the previous inferred methods) and provides a reliable and accurate signal of occupancy levels to the ventilation control system, allowing the ventilation to be adapted instantly based on the fluctuating demand. This helps to optimize the indoor air quality (IAQ), ensure comfort, save energy and energy cost. For privacy sensitive applications, 3D ToF technology provides fast, accurate depth information without the use of higher resolution cameras infringing on privacy. This reference design system is a complete solution that combines a 3D ToF imaging sensor, onboard algorithms, and software, greatly simplifying development of standalone products and integration into existing customer systems.

This reference design subsystem is highly differentiated over existing solutions by offering the following benefits:

- People counting accuracy greater than 90%
- Low latency—occupancy data available in real time
- Wide field of view: H74.4° × V59.3°
- Being independent of ambient light conditions, texture and shadows, 3D ToF sensors can see in the

- dark
- Auto-illumination
 - Four NIR lasers provide large illumination area
 - Short diffused laser pulses inherently safe to eyes
- Unlike CO2 sensors, performance not affected by localized elevated CO2 concentration or presence of any other pollutants
 - Runs on versatile embedded platform
 - Acquisition of the intensity and range data in each pixel at video rates without high computational cost and any moving components as well as the monocular setup.
 - No periodic calibration
 - 3D ToF based approach requires no computation for 3D scene reconstruction
 - Easy integration and use
 - Hardware can be easily upgraded with optional support for wireless interfaces like Sub 1-GHz Radio, WiFi, Zigbee, and *Bluetooth®*
 - Active sensor measuring travel time of near infrared light does not interfere with the scene in visible spectrum
 - Standard CMOS chip reduces manufacturing cost and makes development of compact embedded solution easy

This reference design system uses the OPT8241-CDK-EVM from Texas Instruments and the AM437x Single Board Computer Rico board from MYIR to demonstrate people counting using 3D ToF camera. This reference design provides a complete set of downloadable documents such as a design guide, schematics, layout files, bill of materials (BOM), test results, and firmware that helps system designers in the design and development of their end-equipment systems.

1.1 Key System Specifications

表 1. Key System Specifications

PARAMETER	SPECIFICATION
People counting accuracy	Greater than 90%
ToF sensor	OPT8241
ToF controller	OPT9221
Sensor resolution	320 × 240 (QVGA) array of ToF pixels
Field of view	87° (Diagonal), 74.4° (Horizontal) × 59.3° (Vertical)
Frame rate	30 frames per seconds
Illumination source type	Modulated short diffused LASER pulses (Laser part number: 22045498 from LUMENTUM)
Number of illumination sources	04 LASERS
Illumination source centroid wavelength	855 nm
Modulation frequency	Up to 100-MHz pulsed operation (software configurable)
Average optical output power	1.5 W
Overall power consumption	< 10 W
Operating range	Up to 4 m
Operating temperature	0°C to 40°C (Ambient)
External power supply requirement	Nominal output voltage: 5-V DC Maximum output current: 3 A

表 1. Key System Specifications (continued)

PARAMETER	SPECIFICATION
Embedded platform	AM437x Sitara™ Processor based on ARM® Cortex®-A9 Core (Rico board from MYIR)

2 System Overview

2.1 Block Diagram

The OPT8241 ToF sensor, along with TI's OPT9221 ToF controller, forms a two-chip solution for creating a standalone 3D camera. The block diagram of a complete 3D ToF camera system implementation is shown in [Figure 1](#).

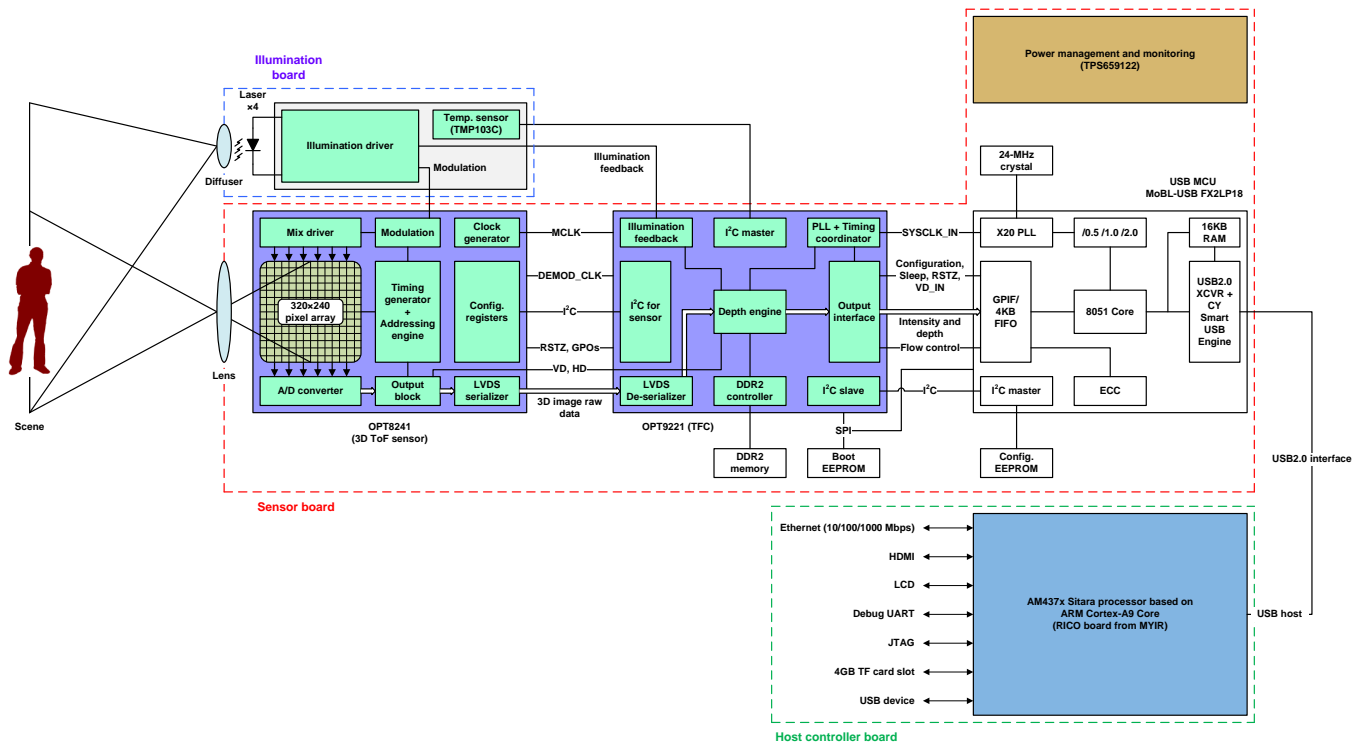

Figure 1. Block Diagram of TIDA-00750

The reference design system mainly consists of two main components:

1. OPT8241-CDK-EVM: Illumination board stacked on top of the sensor board.
2. Host controller board: Rico board (AM437x Sitara Processor Based on ARM® Cortex®-A9 Core).

The 3D ToF camera system is based on the well-known phase measuring optical ToF principle. The core of the camera system is based on the two chipsets OPT8241 and OPT9221. The OPT8241 ToF sensor provides the modulation signal with a few tens of MHz for the internal pixel array as well as for the external illumination circuitry. A modulated near-infrared (NIR) light is emitted through laser diodes from the illumination board. The objects that are located in the field of view reflect light that is projected through the lens onto the OPT8241 depth sensor IC. The phase shift between the light emitted by the source and the light reflected by the objects in the field of view obtained by the OPT8241 sensor is digitized and provided to the OPT9221 ToF Controller (TFC). The TFC then processes and provides the distance output for each pixel. The OPT8241-CDK-EVM located in back top corner of the room uses a Cypress FX2 chip as a USB transceiver that enables the host controller board to acquire data and to control the configuration of the CDK dynamically over USB2.0 interface. The host controller re-constructs the real-time topographic image of the scene by means of 3D information (intensity and data) and sophisticated embedded algorithms, which is then further processed to detect the number of people in a given area.

The principle of operation is described in more detail in *Time-of-Flight Camera — An Introduction* (SLOA190) and *Introduction to the Time-of-Flight (ToF) System Design* (SBAU219).

2.2 Highlighted Products

The People Counting for Demand Controlled Ventilation Using 3D ToF Reference Design features the following devices:

- OPT8241: ToF Sensor
- OPT9221: TFC
- AM437x: Sitara™ processors based on ARM Cortex-A9 core

For more information on each of these devices, see their respective product folders at www.TI.com.

2.2.1 OPT8241

Features

- Imaging array:
 - 320x240 array
 - 1/3" optical format
 - Pixel pitch: 15 μm
 - Up to 120 FPS
- Optical properties:
 - Responsivity: 0.35 A/W at 850 nm
 - Demodulation contrast: 45% at 50 MHz
 - Demodulation frequency: 10 to 100 MHz
- Output data format:
 - 12-bit phase correlation data
 - 4-bit common-mode (ambient)
- Chipset interface:
 - Compatible with TI's TFC [OPT9221](#)
- Sensor output interface:
 - CMOS data interface (50-MHz DDR, 16-lane data, clock, and frame markers)
 - LVDS:
 - 600 Mbps, 3 data pairs
 - 1-LVDS bit clock pair, 1-LVDS sample clock pair
- Timing generator (TG):
 - Addressing engine with programmable region of interest (ROI)
 - Modulation control
 - De-aliasing
 - Master, slave sync operation
- I²C slave interface for control
- Power supply:
 - 3.3-V I/O, analog
 - 1.8-V analog, digital, I/O
 - 1.5-V demodulation (typical)
- Optimized optical package (COG-78):
 - 8.757 mm × 7.859 mm × 0.700 mm
 - Integrated optical band-pass filter (830 nm to 867 nm)
 - Optical fiducials for easy alignment
- Operating temperature: 0°C to 70°C

Applications:

- Depth sensing:
 - Location and proximity sensing
 - 3D scanning
 - 3D machine vision
 - Security and surveillance
 - Gesture controls
 - Augmented and virtual reality
 - People counting

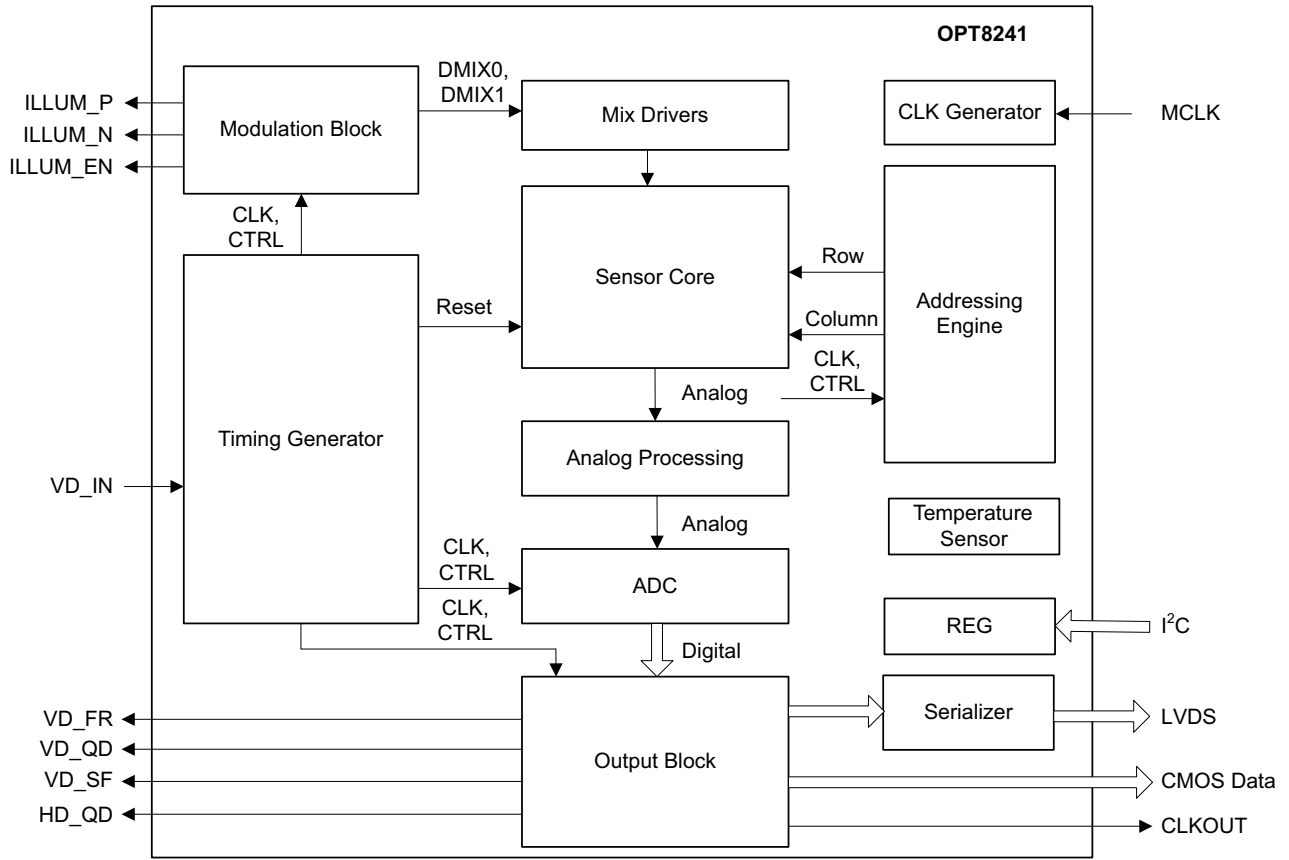

Copyright © 2016, Texas Instruments Incorporated

图 2. OPT8241 Functional Block Diagram

The OPT8241 ToF sensor is part of the TI 3D ToF image sensor family. The device combines ToF sensing with an optimally-designed ADC and a versatile, programmable TG. The device offers quarter video graphics array (QVGA 320×240) resolution data at frame rates up to 120 frames per second (480 readouts per second).

The built-in TG controls the reset, modulation, readout, and digitization sequence. The programmability of the TG offers flexibility to optimize for various depth-sensing performance metrics (such as power, motion robustness, signal-to-noise ratio, and ambient cancellation).

2.2.2 OPT9221

Features:

- QVGA 3D TFC: Up to 120 FPS
- Depth data:
 - 12-bit phase
 - Up to 12-bit amplitude
 - Up to 4-bit ambient
 - Saturation detection
- Chipset interface:
 - Compatible with TI ToF sensor ([OPT8241](#))
- Output (CMOS, 8-lane data, 8 control signals, and clock):
 - Digital video protocol (DVP) compatible:
 - Data, VD, HD, clock
 - Synchronous serial interface (SSI) compatible
- Depth engine:
 - Pixel binning
 - ROI
 - De-aliasing
 - Nonlinearity correction
 - Temperature compensation
 - High dynamic range operation
 - Spatial filter
- Timing coordinator:
 - Sensor control
 - Master and slave sync operation
- I²C slave interface
- Power supply: 1.2-V core, 1.8-V I/O, 3.3-V I/O, 2.5-V analog
- Package: 256-pin, 9-mm×9-mm NFBGA
- Operating temperature: 0°C to 85°C

Applications:

- 3D imaging:
 - Location and proximity sensing
 - 3D scanning and 3D machine vision
 - Security and surveillance
 - Gesture controls

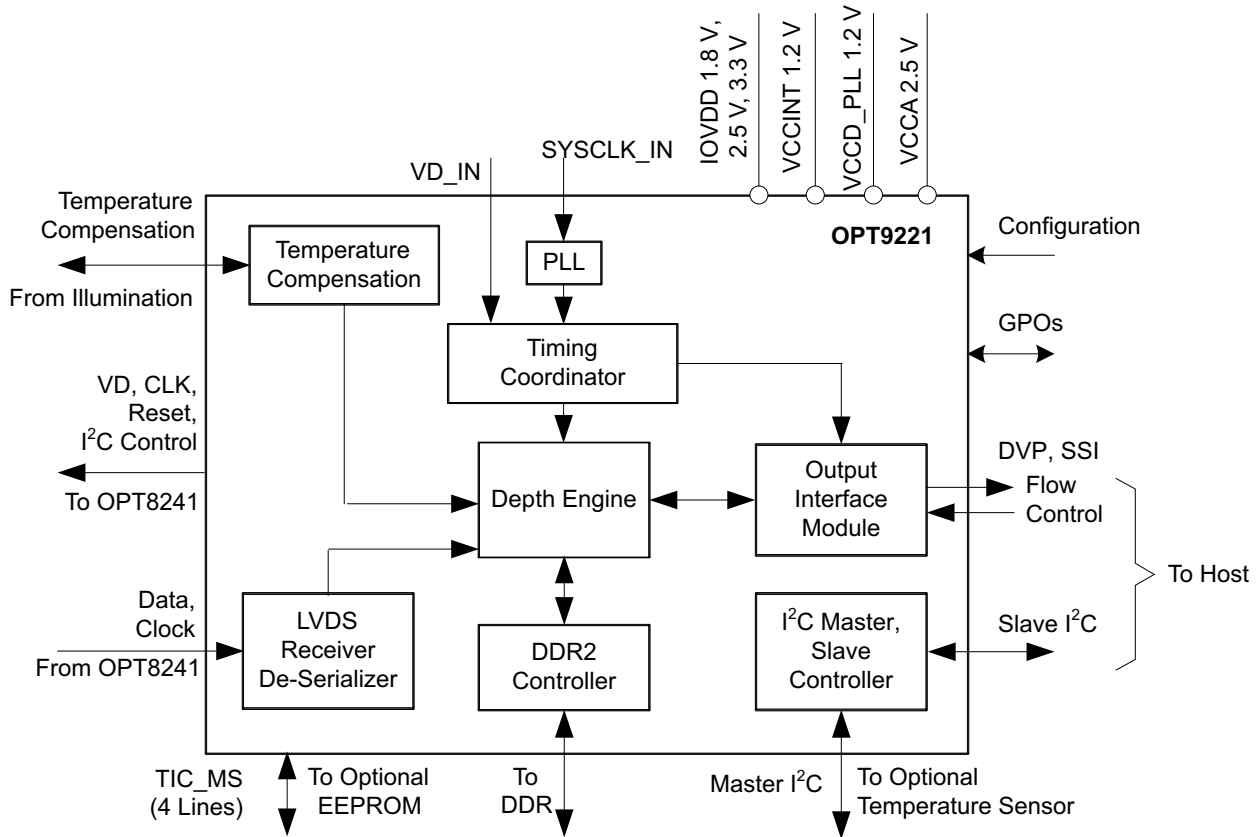

Copyright © 2016, Texas Instruments Incorporated

图 3. OPT9221 Functional Block Diagram

The TFC is a high-performance, 3D ToF sensor companion device that computes the depth data from the digitized sensor data. Depth data are output through a programmable CMOS parallel interface.

In addition to depth data, the TFC provides auxiliary information consisting of amplitude, ambient, and flags for each pixel. This information can be used to implement filters and masks and to dynamically control the system configuration for the intended performance.

The TFC supports a wide range of binning and ROI options that help optimize the data throughput that must be handled.

The 9-mm \times 9-mm NFBGA package enables small form-factor, 3D, ToF systems that can be embedded into a variety of end equipment.

2.2.3 AM437x

Features:

- Sitara ARM Cortex-A9 32-Bit RISC processor with processing speed up to 1000 MHz:
 - NEON™ SIMD coprocessor and vector floating point (VFPv3) coprocessor
 - 32KB of both L1 instruction and data cache
 - 256KB of L2 cache or L3 RAM
- 32-bit LPDDR2, DDR3, and DDR3L support
- General-purpose memory support (NAND, NOR, SRAM) up to 16-bit ECC
- SGX530 graphics engine
- Display subsystem
- Programmable real-time unit subsystem and industrial communication subsystem (PRU-ICSS)
- Real-time clock (RTC)
- Up to two USB 2.0 high-speed dual-role (host or device) ports with integrated PHY
- 10, 100, and 1000 Ethernet switch supporting up to two ports
- Serial interfaces:
 - Two controller area network (CAN) ports
 - Six UARTs, two McASPs, five McSPIs, three I²C ports, one QSPI, and one HDQ or 1-wire
 - Up to two ISO7816 (smart card) interfaces
- Security
 - Crypto hardware accelerators (AES, SHA, RNG, DES, and 3DES)
 - Secure boot
- Two 12-bit successive approximation register (SAR) ADCs
- Up to three 32-bit enhanced capture modules (eCAPs)
- Up to three enhanced quadrature encoder pulse modules (eQEPs)
- Up to Six enhanced high-resolution PWM modules (eHRPWMs)
- MPU subsystem
 - ARM Cortex-A9 32-bit RISC MPU with processing speed up to 1000 MHz
 - 32KB of both L1 instruction and data cache
 - 256KB of L2 cache (option to configure as L3 RAM)
 - 256KB of on-chip boot ROM
 - 64KB of on-chip RAM
 - Secure control module (SCM)
 - Emulation and debug
 - JTAG
 - Embedded trace buffer
 - Interrupt controller
- On-chip memory (shared L3 RAM)
 - 256KB of general-purpose on-chip memory controller (OCMC) RAM
 - Accessible to all masters
 - Supports retention for fast wakeup
 - Up to 512KB of total internal RAM (256KB of ARM memory configured as L3 RAM + 256KB of OCMC RAM)
- External memory interfaces (EMIFs)
 - DDR controllers:
 - LPDDR2: 266-MHz clock (LPDDR2-533 data rate)
 - DDR3 and DDR3L: 400-MHz clock (DDR-800 data rate)
 - 32-bit data bus
 - 2GB of total addressable space
 - Supports one x32, two x16, or four x8 memory device configurations
- GPMC
 - Flexible 8- and 16-bit asynchronous memory interface with up to seven chip selects (NAND, NOR, Muxed-NOR, and SRAM)
 - Uses BCH code to support 4-, 8-, or 16-

- bit ECC
 - Uses hamming code to support 1-bit ECC
- Error locator module (ELM)
 - Used with the GPMC to locate addresses of data errors from syndrome polynomials generated using a BCH algorithm
 - Supports 4-, 8-, and 16-bit per 512-byte block error location based on BCH algorithms
- PRU-ICSS
 - Supports protocols such as EtherCAT®, PROFIBUS®, PROFINET®, EtherNet/IP™, EnDat 2.2, and more
 - Two programmable real-time unit (PRU) subsystems with two PRU cores each:
 - Each core is a 32-bit load and stores an RISC processor capable of running at 200 MHz
 - 12KB (PRU-ICSS1), 4KB (PRU-ICSS0) of instruction RAM with single-error detection (parity)
 - 8KB (PRU-ICSS1), 4KB (PRU-ICSS0) of data RAM With single-error detection (parity)
 - Single-cycle 32-bit multiplier with 64-bit accumulator
 - Enhanced GPIO module provides shift-in and shift-out support and parallel latch on external signal
 - 12KB (PRU-ICSS1 only) of shared RAM with single-error detection (parity)
 - Three 120-byte register banks accessible by each PRU
 - Interrupt controller module (INTC) for handling system input events
 - Local interconnect bus for connecting internal and external masters to the resources inside the PRU-ICSS
 - Peripherals inside the PRU-ICSS
 - One UART port with flow control pins,
- supports up to 12 Mbps
 - One eCAP module
 - Two MII ethernet ports that support industrial Ethernet, such as EtherCAT
 - One MDIO port
 - Industrial communication is supported by two PRU-ICSS subsystems
- Power reset and clock management (PRCM) module
 - Controls the entry and exit of deep-sleep modes
 - Responsible for sleep sequencing, power domain switch-off sequencing, wake-up sequencing, and power domain switch-on sequencing
 - Clocks
 - Integrated high-frequency oscillator used to generate a reference clock (19.2, 24, 25, and 26 MHz) for various system and peripheral clocks
 - Supports individual clock enable and disable control for subsystems and peripherals to facilitate reduced power consumption
 - Five ADPLLs to generate system clocks (MPU subsystem, DDR interface, USB, and peripherals [MMC and SD, UART, SPI, I²C], L3, L4, Ethernet, GFX [SGX530], and LCD pixel clock)
 - Power
 - Two nonswitchable power domains (RTC and wake-up logic [WAKE-UP])
 - Three switchable power domains (MPU subsystem, SGX530 [GFX], peripherals and infrastructure [PER])
 - Dynamic voltage frequency scaling (DVFS)
- RTC
 - Real-time date (day, month, year, and day of week) and time (hours, minutes, and seconds) information

- Internal 32.768-kHz oscillator, RTC logic, and 1.1-V internal LDO
- Independent power-on-reset (RTC_PWRONRSTn) input
- Dedicated input pin (RTC_WAKEUP) for external wake events
- Programmable alarm can generate internal interrupts to the PRCM for wakeup or Cortex-A9 for event notification
- Programmable alarm can be used with external output (RTC_PMIC_EN) to enable the power-management IC to restore non-RTC power domains
- Peripherals
 - Up to two USB 2.0 high-speed dual-role (host or device) ports with integrated PHY
 - Up to two industrial gigabit Ethernet MACs (10, 100, and 1000 Mbps)
 - Integrated switch
 - Each MAC supports MII, RMII, and RGMII and MDIO interfaces
 - Ethernet MACs and switch can operate independent of other functions
 - IEEE 1588v2 Precision Time Protocol (PTP)
 - Up to two CAN ports
 - Supports CAN v2 parts A and B
 - Up to two multichannel audio serial ports (McASPs)
 - Transmit and receive clocks up to 50 MHz
 - Up to four serial data pins per McASP port with independent TX and RX clocks
 - Supports time division multiplexing (TDM), inter-IC sound (I2S), and similar formats
 - Supports digital audio interface transmission (SPDIF, IEC60958-1, and AES-3 formats)
- FIFO buffers for transmit and receive (256 bytes)
- Up to six UARTs
 - All UARTs support IrDA and CIR modes
 - All UARTs support RTS and CTS flow control
 - UART1 supports full modem control
- Up to five master and slave McSPI serial interfaces
 - McSPI0-McSPI2 supports up to four chip selects
 - McSPI3-McSPI4 supports up to two chip selects
 - Up to 48 MHz
- One quad-SPI
 - Supports eExecute in place (XIP) from serial NOR FLASH
- One Dallas 1-Wire® and HDQ serial interface
- Up to three MMC, SD, and SDIO ports
 - 1-, 4-, and 8-bit MMC, SD, and SDIO modes
 - 1.8- or 3.3-V operation on all ports
 - Up to 48-MHz clock
 - Supports card detect and write protect
 - Complies with MMC4.3 and SD and SDIO 2.0 specifications
- Up to three I²C master and slave interfaces
 - Standard mode (up to 100 kHz)
 - Fast mode (up to 400 kHz)
- Up to six banks of general-purpose I/O (GPIO):
 - 32 GPIOs per bank (multiplexed with other functional pins)
 - GPIOs can be used as interrupt inputs (up to two interrupt inputs per

- bank)
 - Up to three external DMA event inputs that can also be used as interrupt inputs
 - Twelve 32-bit general-purpose timers:
 - DMTIMER1 is a 1-ms timer used for operating system (OS) ticks
 - DMTIMER4 to DMTIMER7 are pinned out
 - One public watchdog timer
 - One free-running, high-resolution 32-kHz counter (synctimer32K)
 - SGX530 3D graphics engine:
 - Tile-based architecture delivering up to 20M poly/sec
 - Universal scalable shader engine is a multithreaded engine incorporating pixel and vertex shader functionality
 - Advanced shader feature set in excess of Microsoft® VS3.0, PS3.0, and OGL2.0
 - Industry standard API support of Direct3D mobile, OGL-ES 1.1 and 2.0, and OpenVG 1.0
 - Fine-grained task switching, load balancing, and power management
 - Advanced geometry DMA-driven operation for minimum CPU interaction
 - Programmable high-quality image anti-aliasing
 - Fully virtualized memory addressing for OS operation in a unified memory architecture
 - Display subsystem
 - Display modes
 - Programmable pixel memory formats (palletized: 1, 2, 4, and 8 bits per pixel; RGB 16 and 24 bits per pixel; and YUV 4:2:2)
 - 256x24-bit entries palette in RGB
 - Up to 2048x2048 resolution
 - Display support
 - Four types of displays are supported: Passive and active colors; passive and active monochromes
 - 4- and 8-bit monochrome passive panel interface support (15 grayscale levels supported using dithering block)
 - RGB 8-bit color passive panel interface support (3,375 colors supported for color panel using dithering block)
 - RGB 12-, 16-, 18-, and 24-bit active panel interface support (replicated or dithered encoded pixel values)
 - Remote frame buffer (embedded in the LCD panel) support through the RFBI module
 - Partial refresh of the remote frame buffer through the RFBI module
 - Partial display
 - Multiple cycles output format on 8-, 9-, 12-, and 16-bit interface (TDM)
 - Signal processing
 - Overlay and windowing support for one graphics layer (RGB or CLUT) and two video layers (YUV 4:2:2, RGB16, and RGB24)
 - RGB 24-bit support on the display interface, optionally dithered to RGB 18-bit pixel output plus 6-bit frame rate control (spatial and temporal)
 - Transparency color key (source and destination)
 - Synchronized buffer update
 - Gamma curve support
 - Multiple-buffer support
 - Cropping support
 - Color phase rotation

- Two 12-bit SAR ADCs (ADC0, ADC1)
 - 867K samples per second
 - Input can be selected from any of the eight analog inputs multiplexed through an 8:1 analog switch
 - ADC0 can be configured to operate as a 4-, 5-, or 8-wire resistive touch screen controller (TSC)
- Up to three 32-bit eCAP modules
 - Configurable as three capture inputs or three auxiliary PWM outputs
- Up to six enhanced eHRPWM modules
 - Dedicated 16-bit time-base counter with time and frequency controls
 - Configurable as six single-ended, six dual-edge symmetric, or three dual-edge asymmetric outputs
- Up to three 32-bit eQEP modules
- Device identification
 - Factory programmable electrical fuse farm (FuseFarm)
 - Production ID
 - Device part number (unique JTAG ID)
 - Device revision (readable by host ARM)
 - Feature identification
- Debug interface support
 - JTAG and cJTAG for ARM (Cortex-A9 and PRCM) and PRU-ICSS Debug
 - Supports real-time trace pins (for Cortex-A9)
 - 64-KB embedded trace buffer (ETB)
 - Supports device boundary scan
 - Supports IEEE 1500
- DMA
 - On-chip enhanced DMA controller (EDMA) has three third-party transfer controllers (TPTCs) and one third-party channel controller (TPCC), which supports up to 64 programmable logical channels and eight QDMA channels
 - EDMA is used for:
 - Transfers to and from on-chip memories
 - Transfers to and from external storage (EMIF, GPMC, and slave peripherals)
- Inter-Processor Communication (IPC)
 - Integrates hardware-based mailbox for IPC and Spinlock for process synchronization between the Cortex-A9, PRCM, and PRU-ICSS
- Boot modes
 - Boot mode is selected through boot configuration pins latched on the rising edge of the PWRONRSTn reset input pin
- Camera
 - Dual port 8- and 10-bit BT656 interface
 - Dual port 8- and 10-bit including external syncs
 - Single port 12-bit
 - YUV422/RGB422 and BT656 input format
 - RAW format
 - Pixel clock rate up to 75 MHz
- Package
 - 491-Pin BGA package (17-mm × 17-mm) (ZDN suffix), 0.65-mm ball pitch with via channel array technology to enable low-cost routing

Applications:

- Patient monitoring
- Navigation equipment
- Industrial automation
- Portable data terminals

- Bar code scanners
- Point of service
- Portable mobile radios
- Test and measurement



图 4. AM437x Functional Block Diagram

The TI AM437x high-performance processors are based on the ARM Cortex-A9 core.

The processors are enhanced with 3D graphics acceleration for rich graphical user interfaces, as well as a coprocessor for deterministic, real-time processing including industrial communication protocols, such as EtherCAT, PROFIBUS, EnDat, and others. The devices support high-level operating systems (HLOS). Linux® is available free of charge from TI. Other HLOSs are available from TI's Design Network and ecosystem partners.

These devices offer an upgrade to systems based on lower performance ARM cores and provide updated peripherals, including memory options such as QSPI-NOR and LPDDR2.

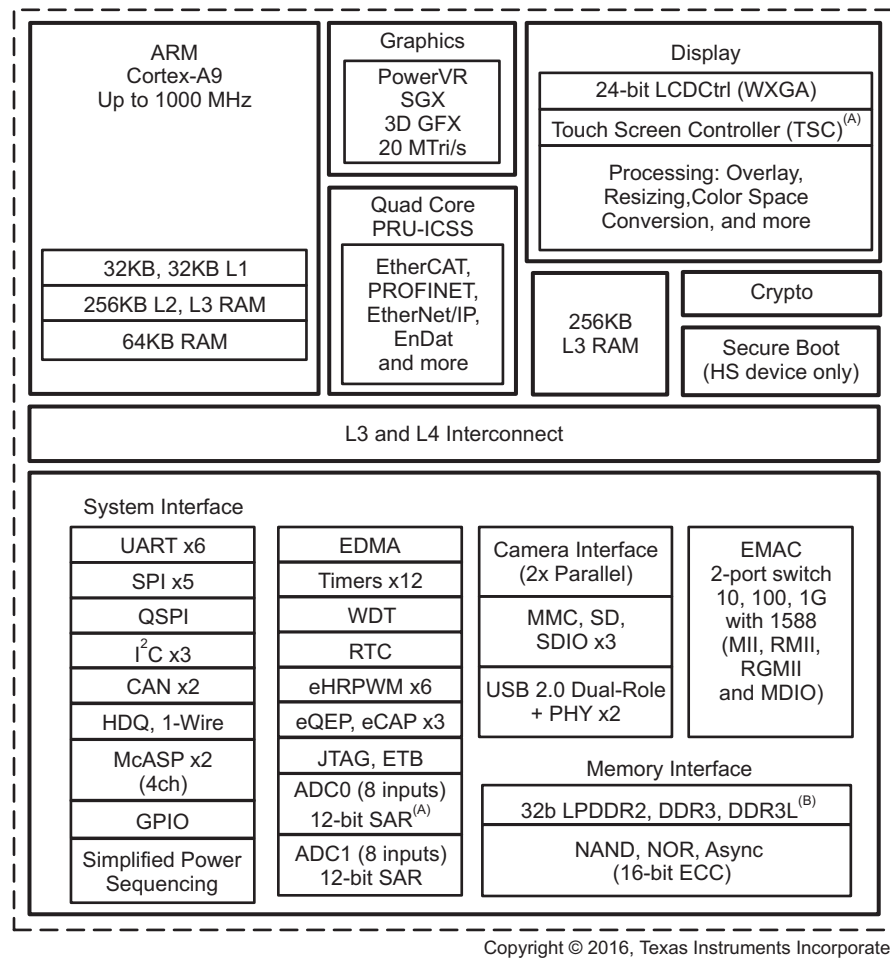
The processors contain the subsystems shown in 图 4, and a brief description of each follows.

The processor subsystem is based on the ARM Cortex-A9 core, and the POWERVR SGX™ graphics accelerator subsystem provides 3D graphics acceleration to support display and advanced user interfaces.

The PRU-ICSS is separate from the ARM core and allows independent operation and clocking for greater efficiency and flexibility. The PRU-ICSS enables additional peripheral interfaces and real-time protocols such as EtherCAT, PROFINET, EtherNet/IP, PROFIBUS, Ethernet Powerlink, Sercos, EnDat, and others. The PRU-ICSS enables EnDat and another industrial communication protocol in parallel. Additionally, the programmable nature of the PRU-ICSS, along with their access to pins, events and all system-on-chip (SoC) resources, provides flexibility in implementing fast real-time responses, specialized data handling operations, custom peripheral interfaces, and in off-loading tasks from the other processor cores of the SoC.

High-performance interconnects provide high-bandwidth data transfers for multiple initiators to the internal and external memory controllers and to on-chip peripherals. The device also offers a comprehensive clock-management scheme.

One on-chip analog to digital converter (ADC0) can couple with the display subsystem to provide an integrated touch-screen solution. The other ADC (ADC1) can combine with the pulse width module to create a closed-loop motor control solution.

The RTC provides a clock reference on a separate power domain. The clock reference enables a battery-backed clock reference.

The camera interface offers configuration for a single- or dual-camera parallel port.

Cryptographic acceleration is available in every AM437x device. Secure boot can also be made available for anticloning and illegal software update protection. For more information about secure boot, contact your TI sales representative.

3 System Design Theory

The working principle is based on the elapsed ToF of a modulated light emitted by the light source and reflected back by the object to the photosensitive receiver. The very high photosensitivity allows operating ranges up to several meters and accuracy down to a few centimeters depending on the receiver optics and the illumination power. Each component of this camera system more or less affects the key parameters as measurement range, field of view, frame rate, and accuracy. Each application has different requirements concerning these parameters.

3.1 Sensor Board

A good place to start is to look at some of the available camera system technologies and weigh the pros and cons of each. 图 5 summarizes some of the popular options available today.

	Time of Flight (ToF)	Stereoscopic vision	Fixed structured light	Programmable structured light (DLP)
Operational principle	IR pulse, measure light transit time	Two 2D sensors emulate human eyes	Single pattern visible or IR illumination, detects distortion	Multiple pattern visible or IR illumination, detects distortion
Point cloud generation	Direct out of chipset	High SW Processing	Medium SW processing	SW processing scales with # of patterns
Latency	Low	Medium	Medium	Medium
Active illumination	Yes	No	Yes	Yes – customizable spectrum
Low light performance	Good	Weak	Good	Good
Bright light performance	Medium	Good	Medium / weak <i>Depends on illumination power</i>	Medium / weak <i>Depends on illumination power</i>
Power consumption	Medium/high <i>Scales w/ distance</i>	Low	Medium	Medium <i>Scales with distance</i>
Range	Short to long range <i>Depends on laser power & modulation</i>	Mid range <i>Depends on spacing between cameras</i>	Very short to mid range <i>Depends on illumination power</i>	Very short to mid range <i>Depends on illumination power</i>
Resolution	QQVGA, QVGA -> Roadmap to VGA	Camera Dependent	Projected pattern dependent	WVGA to 1080p -> Roadmap to WQXGA
Depth accuracy	mm to cm <i>Depends on resolution of sensor</i>	mm to cm <i>Difficulty with smooth surface</i>	mm to cm	μm to cm
Scanning speed	Fast <i>Limited by sensor speed</i>	Medium <i>Limited by software complexity</i>	Medium <i>Limited by SW complexity</i>	Fast / medium <i>Limited by camera speed</i>

图 5. Comparison of 3D Imaging Technology

The ToF camera technology is clearly the best candidate because this is a cost-effective, mechanically compact depth imaging solution, unaffected by varying environmental illumination, delivers depth values for each pixel without the need of complex calculation algorithms, and vastly simplifies the figure-ground separation commonly required in scene understanding.

The ToF camera sensor is the key component of this reference design system. However, the ToF camera sensor is not the only part that affects performance. The number of pixels defines the resolution of the camera. Additionally, each pixel provides the system with depth information of the corresponding point in the scene. For a people counting application where multiple people might be engaged in close interactions, high sensor resolution and high depth accuracy are absolutely necessary to be able to detect and count people accurately. Therefore, to best demonstrate the performance of this TI Design system, the OPT8241 ToF sensor is selected as shown in 图 6. The OPT9221 ToF controller is the ToF sensor's companion device that computes the depth data from the digitized sensor data.

Status	Device Type	Sensor Resolution	Output Format	Interface	Frame Rate (Max) (FPS)	Pixel Pitch (um)	Operating Temperature Range (C)	Rating	Estimated Package Size (WxL) (mm ²)	Package Group
<input type="checkbox"/> ACTIVE	<input type="checkbox"/> Sensor + AFE <input type="checkbox"/> Single Chip <input type="checkbox"/> ToF Controller	<input type="checkbox"/> NA <input type="checkbox"/> 80x60 <input type="checkbox"/> 320 x 240	<input type="checkbox"/> Depth Data <input type="checkbox"/> Raw Sensor Data	<input type="checkbox"/> DVP Compatible <input type="checkbox"/> DVP, SSI <input type="checkbox"/> LVDS <input type="checkbox"/> SSI Compatible	<input type="checkbox"/> 120 <input type="checkbox"/> 1000	<input type="checkbox"/> 15 <input type="checkbox"/> 30	<input type="checkbox"/> 0 to 70	<input type="checkbox"/> Catalog	<input type="checkbox"/> 56COG: 8.06 x 5.321: 43 mm ² <input type="checkbox"/> 78COG: 8.757 x 7.859: 69 mm ² <input type="checkbox"/> 256NFBGA: 9 x 9: 81 mm ²	<input type="checkbox"/> COG <input type="checkbox"/> NFBGA
<input type="checkbox"/> OPT8320 - 80x60 QQVGA Resolution 3D Time of Flight Sensor & Controller	NEW ACTIVE Single Chip	80x60	Depth Data	DVP, SSI	1000	30	0 to 70	Catalog	56COG: 8.06 x 5.321: 43 mm ²	COG
<input checked="" type="checkbox"/> OPT8241 - QVGA-Resolution 3D Time-of-Flight (ToF) Sensor	ACTIVE Sensor + AFE	320 x 240	Raw Sensor Data	LVDS	-	15	0 to 70	Catalog	78COG: 8.757 x 7.859: 69 mm ²	COG
<input checked="" type="checkbox"/> OPT9221 - Time-of-Flight (ToF) Controller for OPT8241	ACTIVE ToF Controller	NA	Depth Data	DVP Compatible SSI Compatible	120	-	0 to 70	Catalog	256NFBGA: 9 x 9: 81 mm ²	NFBGA

图 6. Parametric Table for Selection of 3D ToF Sensor

The sensor board consists of the OPT8241 ToF sensor chip, lens with lens holder, the OPT9221 ToF controller, DDR2 memory, boot EEPROM, USB transceiver, and power management devices. The lens and the lens holder both are custom-designed parts. To use standard off-the-shelf lenses, a standard M12 lens holder footprint has been provided. The sensor board communicates with the host controller board over USB interface. The sensor board carries a 2.1-mm jack for power supply from a 5-V DC adaptor. The sensor board consists of all interconnects and the corresponding connectors. The illumination board is mechanically held to the sensor board using spacers. The electrical connections between the illumination board and sensor board are achieved using a flex cable.

3.2 Illumination Board

The illumination source is equally responsible for system performance as the OPT8241 ToF sensor chip itself. The light power has to be as high as possible while running inside the eye-safety norms. Additionally, the illumination board has to be small, efficient, and match the same field of view as it is captured by the ToF camera. The illumination source could be either a light emitting diode (LED) or laser. The efficiency (electrical to optical power) of modern LEDs is typically up to 30%. The modulation circuitry could be implemented easily due to a linear electro-optical characteristic and beam shaping is done by an integrated LED optics. LEDs were mainly chosen targeting very low system cost at high volumes. ToF systems give better results at higher frequency because higher modulation frequency provides better range measurement precision. However, LEDs usually do not work well beyond 24 to 30 MHz. Therefore, beyond such frequencies, it is recommended to use lasers.

One advantage lasers have over LEDs is that the efficiency of lasers actually increases at higher currents. Laser diodes have efficiencies up to 50%. The TI ToF sensors usually work best in the range of 40 to 60 MHz. Therefore, to best use TI's ToF, lasers can be used. However, the cost of lasers may be higher than LEDs, and eye safety is a concern when operating laser systems.

The OPT8241 always needs an external illumination driver circuitry. The illumination board consists of four NIR laser diodes mounted with diffusers and the laser driver circuitry. The optical output power of the illumination board is controlled using an I²C interface-based digital potentiometer. The modulation control of the illumination is done by the OPT8241 sensor and the corresponding signals from the sensor board to the illumination board through a flex cable.

3.3 Host Controller Board

The Rico board is a Linux-ready single board computer equipped with the newest TI Sitara AM437x processor based on the ARM Cortex-A9 core, 512MB DDR3, 4GB eMMC Flash, 16MB QSPI Flash, and 32KB EEPROM on board. Additionally, it has rich peripherals including a debug serial port, USB 2.0 host and device ports, a Gigabit Ethernet port, TF card slot, HDMI port, dual camera interfaces, LCD interface, and so on. Two 2.54-mm pitch 40-pin expansion connectors allow for more IOs for peripheral signals like two SPI, two I²C, two CAN, four UARTs, one MMC, and an eight-channel ADC.

The Rico board was selected because of its affordable cost, having ready-to-use interfaces, and supports Debian. The entire application software of the 3D ToF camera system runs on the Debian GNU/Linux operating system. The top and bottom views of Rico board are shown in 图 7 and 图 8.



图 7. Rico Board Top View



图 8. Rico Board Bottom View

For more details about Rico board, visit <http://www.myirtech.com/list.asp?id=510>.

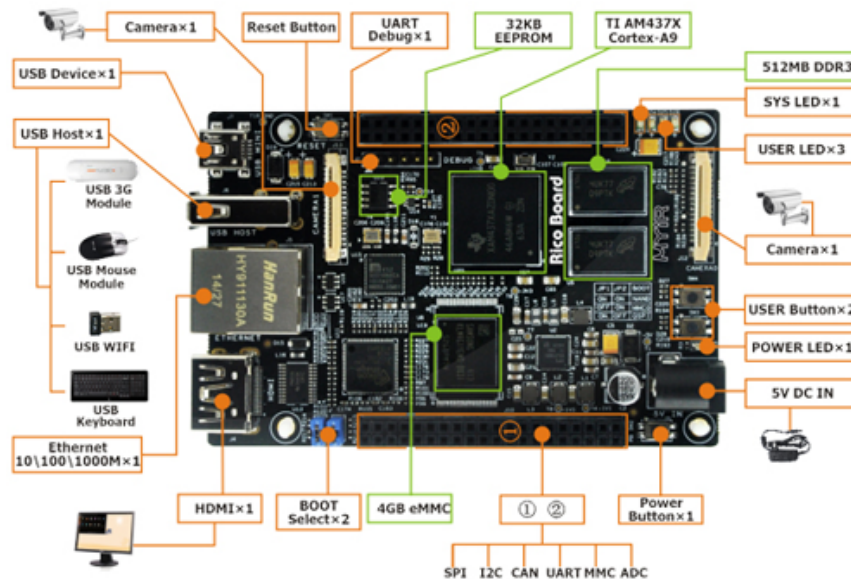
3.4 Demand Controlled Ventilation

Ventilation is a critical component of heating, ventilating, and air conditioning (HVAC) systems; it delivers fresh air to building occupants, maintains building pressurization, provides cooling, and more. In a building, contaminants build up over time. Some contaminants come from outside, some come from inside, and some come from the occupants. The main goal of ventilation is to reduce airborne contaminants by diluting indoor air, which has a higher concentration of contaminants, with outdoor air that has less contaminant to maintain indoor air quality (IAQ) within accepted limits for both the health and comfort of the occupants.

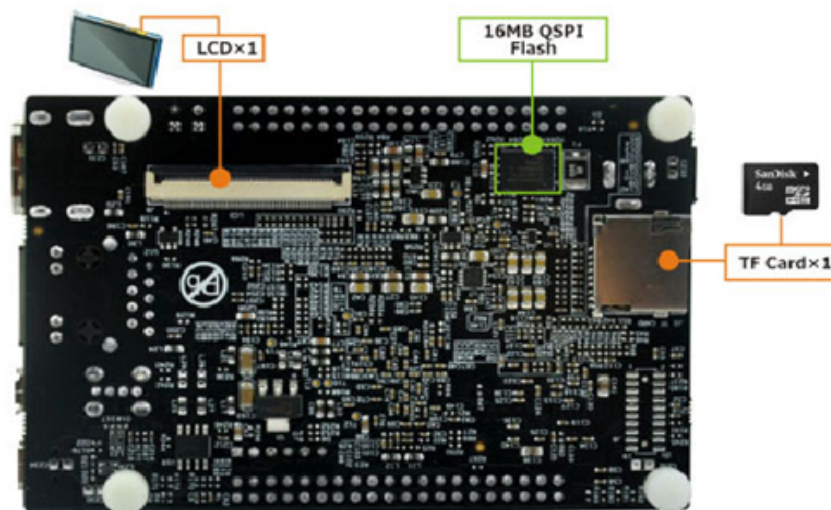
However, in conventional HVAC design, ventilation systems are designed based on the assumption that the building will always be at peak occupancy, the worst-case scenario. Fixed ventilation systems provide a constant intake of fresh air. Whenever the space is nearly empty, conventional ventilation systems are providing more ventilation than what is needed. Overventilation increases heating and cooling loads as well as excessive fan usage, all of which contribute to a significant waste of energy and money. Scheduled ventilation can provide fresh air at the correct rates at the right time, but run at the risk of under- or overventilation if schedule changes are not made at the appropriate times. Much of this energy can be saved through demand control ventilation (DCV).

DCV adjusts outside ventilation air based on the number of occupants and the ventilation demands that those occupants create. This accomplishes two things. First, DCV saves energy by not heating or cooling unnecessary quantities of outside air. Second, DCV can provide assurance that sufficient outside air is being supplied to the occupants.

Historically, CO₂ sensor based DCV system are most popular and widely used sensor. When most people implement a DCV strategy, they think CO₂ sensing in a space will be required automatically. However, CO₂ sensing may not be the best choice for the following reasons:

- The high level of uncertainty between the number of people and CO₂ concentration levels makes predicting the real-time occupancy numbers using CO₂-based systems challenging.
- Lagging indicator of occupancy; by the time sensors detect high levels of CO₂ that trigger ventilation control, occupants may already be in a state of discomfort.
- Subjected to accuracy drift over time.
- Requires proper periodic maintenance such as cleaning and recalibration.
- Their performance is affected by the presence of other gases, humidity, vibration, and air pressure.
- CO₂ concentration levels may be affected by factors other than occupancy, such as passive ventilation, open windows, or air infiltration.
- Locating a CO₂ sensor is difficult because it requires to first understand the dynamics of indoor CO₂ levels and multipoint measurement of CO₂ concentration in an occupied room.

3D ToF based people counting for DCV systems can be much more efficient in controlling and regulating equipment than gas sensor measurement and likely require less maintenance. A 3D ToF camera system provides direct and accurate measurement of an occupancy level to the ventilation control system in real time that timely triggers the controls to achieve the intended ventilation. The 3D ToF camera can be integrated easily to the DCV systems through either a wired or wireless link as shown in 图 9.



图 9. 3D ToF Camera Based DCV System

3.5 People Tracking Algorithm Using a Depth Camera

A key benefit a depth camera has is the ability to use depth to segregate foreground from the background. Once foreground objects are isolated, they can be recognized, tracked, and counted using modern image processing algorithms available in OpenCV. This section describes the theory on how to create a simple people counter and tracking application.

The general strategy of people counting and tracking is as follows:

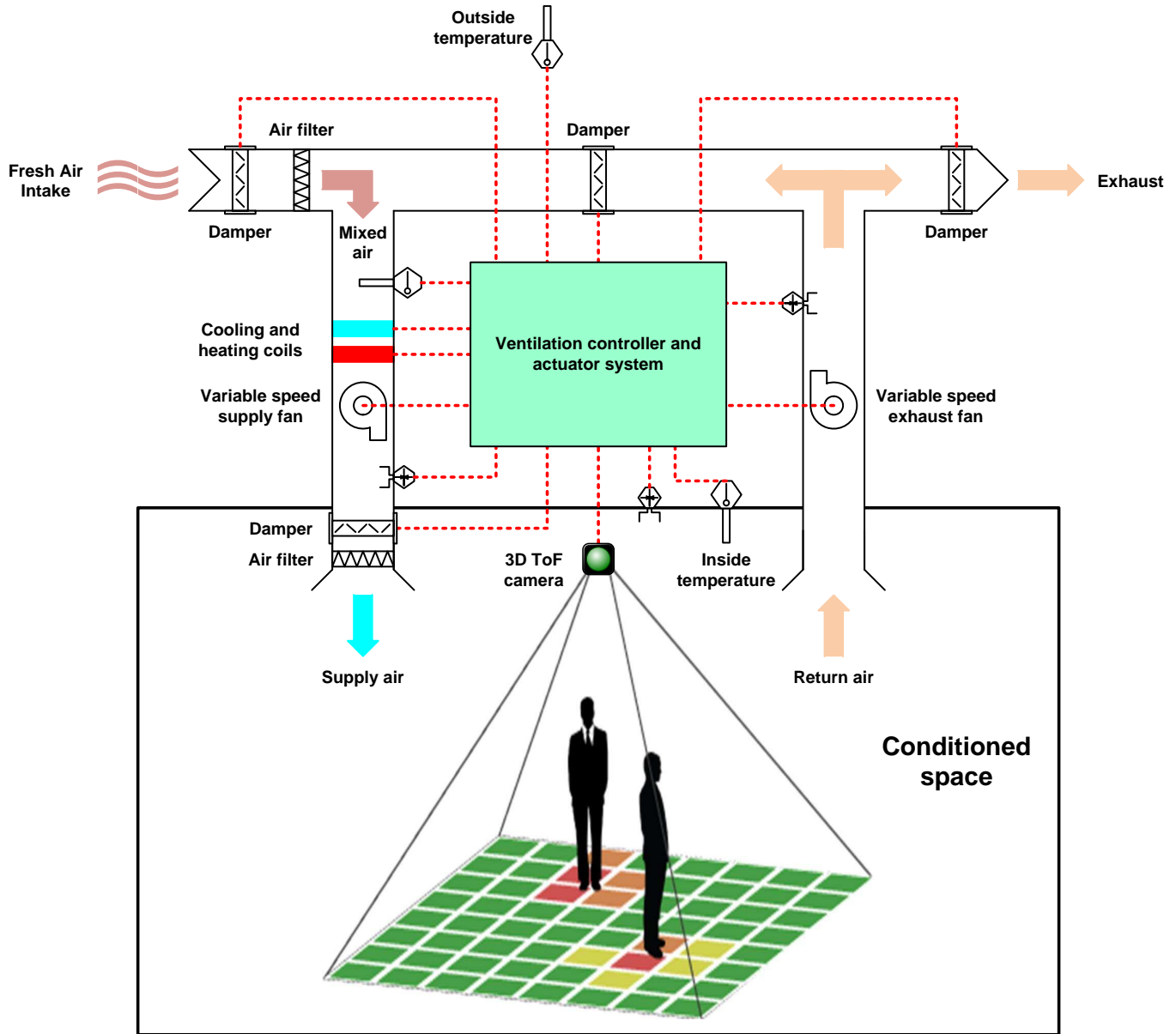
- Foreground-background separation
- Convert to binary image and apply morphology filters
- Shape analysis
- Tracking

3.5.1 Foreground-Background Separation

Foreground-background separation starts with registering the background, which is necessary before one can separate foreground from background through image subtraction. If a depth camera is used, image subtraction would be the difference between two depth images.

3.5.1.1 Simple Approach to Registering Background

Setting the background could be as simple as capturing a frame when the scene is absent of foreground objects. However, the simple approach will detect background objects that may have moved from its original location.

3.5.1.2 Sophisticated Approach to Registering Background

A more sophisticated approach would be to slowly fade in any alteration back into the background. For example, if the change is not a recognized object to be tracked, the alteration can be added to the background. Another example is if the alteration has sustained a period of no change, it can be considered background.

If the sophisticated approach is adopted, the definition of foreground is the fast-changing component of the scene, and background is the slow-changing component. The rate at which the foreground fades into the background should be a programmable parameter that depends on the type of applications.

3.5.1.3 Image Subtraction

After subtraction, the result would be from newly present or absence of objects. To reduce the impact of camera noise, the "foreground" may need to be further qualified by minimum delta depth ("thickness") and minimum amplitude ("brightness").

The code example illustrates a simple case of foreground-background separation:

```
void Horus::clipBackground(Mat &dMat, Mat &iMat, float dThr, float iThr)
{
    for (int i = 0; i < dMat.rows; i++) {
        for (int j = 0; j < dMat.cols; j++) {
            float val = (iMat.at(i,j)>iThr && dMat.at(i,j)>dThr) ? 255.0 : 0.0;
            dMat.at(i,j) = val;
        }
    }
}
```

where $iThr$ is the amplitude (brightness) threshold, and $dThr$ is the depth threshold.

3.5.2 Binary Image and Morphology Filter

The foreground from subtraction may contain speckles to noise, as noise varies from frame to frame. The morphology operators can be applied to remove speckles and fill in small gaps. The open operator first erodes the image using the chosen morphology element, then dilates the result to fill in the gaps and smooth the edges.



图 10. Background Subtraction Binary Image



图 11. Morphology Filter on Binary Image

3.5.3 Shape Analysis

After the foreground is isolated as a binary image, shape analysis can be performed to find individual objects in the foreground. This step is where people counting solutions vary, depending on the application.

Also, people tracking algorithms depend heavily on camera angles. Algorithms for ceiling-mounted camera are generally simpler than those for corner-mounted cameras. Objects from the ceiling view look like well-formed blobs, but from the corner, objects become complex overlapping silhouettes, which are harder to separate.

In the rest of the section, various shape analysis theories are explained that can be relevant to people tracking and counting. Most of the algorithms are available in OpenCV.

3.5.3.1 Blob Analysis

Blob analysis works by connecting joined, self-enclosing regions in the foreground sharing common properties such as area, thresholds, circularity, inertia and convexity. Proper selection of these properties can greatly enhance accuracy. A summary article on blob analysis with example code is available from Satya Mallick.



图 12. Blob Parameters[9]

Blob analysis works best when the camera is ceiling mounted because people will generally look like well-formed blobs from this perspective. However, people in physical contact with one another can cause their blobs to join, leading to a miscount. The erode operator is useful in this case as it can split thinly connected blobs.

3.5.3.2 Contour Analysis

Foreground shapes can also be recognized and tracked by contours, a list of points that form a self-enclosing outline of the foreground object it encloses. Each contour has both a length and an enclosed area property. The contour properties can be analyzed to determine if the contour reflects a "person". With proper settings, the number of contours in the foreground can be the people counter.

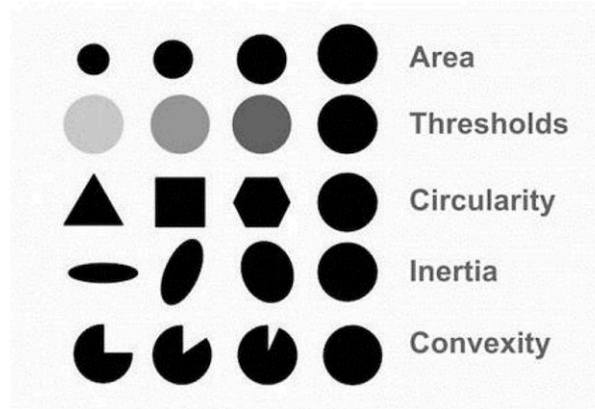
A key benefit of contours is the ability to identify appendages or body parts such as fingers, legs, arms, and shoulders. This ability is available through contour operators like convex hull and convexity defects. In the example shown in 图 13, the convex hull is the vertices of the green convex polygon, and the convexity defects are the red points at the bottom of "valleys". The valleys are called convexity defects because they represent violations of convexity. Once convex hull and convexity defects are identified, along with the contour centroid and some heuristics, an algorithm can be developed to identify head, arms, and legs of a person.



图 13. Convex Hull and Convexity Defects

3.5.3.3 Region Growing

For corner-mounted cameras, people in the foreground may overlap, especially in a crowded room. The point cloud of the foreground pixels should be exploited to group points belonging to the same individual. The region growing algorithm can be applied to group pixels having similar $z\cos(\theta)$ distance from the camera, where θ is the camera pitch angle.

The first step is finding suitable seeding points. One way is to histogram each foreground blob and identify the top two or three local maxima with each maxima meeting some minimum separation requirement. Then, seed the point in each maxima that is closest to the centroid of all points belonging to the same maxima. To grow the region, set each seed as the center, then scan the eight neighbors to qualify or disqualify them into the group based on the $z\cos(\theta)$ distance. Then with each qualified neighbor as the center, repeat the same eight-neighbor scan to expand the group. The result of an example is given in [图 14](#).

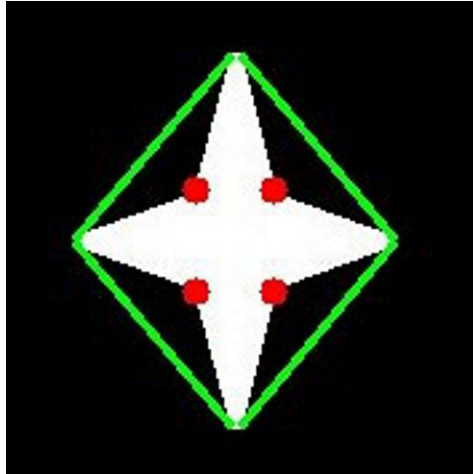

图 14. Region Growing Algorithm in People Counting[8]

3.5.4 Tracking

In some applications, tracking the movement of people in a room is important (for example, monitoring presence of suspicious or unusual activities, or quantifying the interest of a crowd to particular products or showcases). Tracking also enables one to maintain a proper head count in situations where people may be partially or even fully obstructed. In these scenarios, if the tracker has not detected any people leaving the scene from the sides of the camera view, then any disappearing blobs must be due to occlusion; therefore, the head count must remain unchanged.

Tracking requires matching foreground entities in consecutive frames. Matching can be based on multiple criteria such as shortest centroid displacement, similarity of contour shape, and intensity profile. Subtracting consecutive frames will also indicate the direction of motion, enabling prediction of where in the new frame the tracked object is.

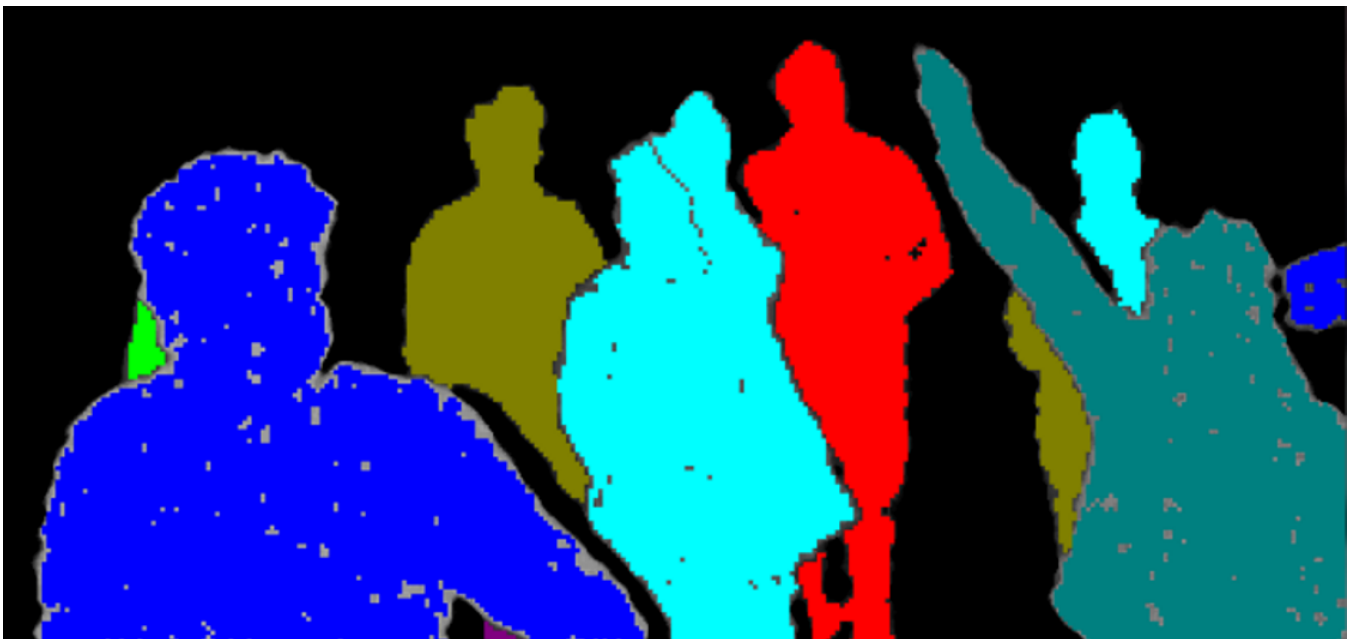
4 Getting Started Hardware

4.1 Hardware Overview

Follow these sets to make hardware connections as shown in [图 15](#).

1. Connect a standard Type A Male Type Micro-B Male USB Cable between J6 connector on the Rico board and U4 on the sensor board of the OPT8241-CDK-EVM.
2. Visualize the AM437x desktop environment in one of two ways:
 - (a) HDMI monitor: Connect the display using an HDMI cable to J4 connector on the Rico board.
 - (b) Remote desktop: Connect an Ethernet cable from the network drop or computer to J5 on the Rico board.
3. Ensure that the power switch (SW2) on the sensor board of the OPT8241-CDK-EVM is in the off position, which is to the left.
4. Apply 5-V DC power to the J1 connector on the Rico board and the J3 connector on the sensor board of the OPT8241-CDK-EVM with the help of 1 male plug to 2 female Jack cable splitter 5.5×2.1-mm adapter.
5. Move the power switch (SW2) on the sensor board of the OPT8241-CDK-EVM to the on position (to the right).
6. Check that the master LED is green and the chipset LED is blue on the sensor board of the OPT8241-CDK-EVM.



图 15. Hardware Setup

5 Getting Started Firmware

The following section describes how to set up Debian and install the TI Voxel SDK on the Rico board built by MYIR. At the time of this writing, the authors have only tested the versions noted in this section. Different hardware platforms and software versions may be used, but the authors have not verified any other options.

The procedure to set up the software contains these major parts:

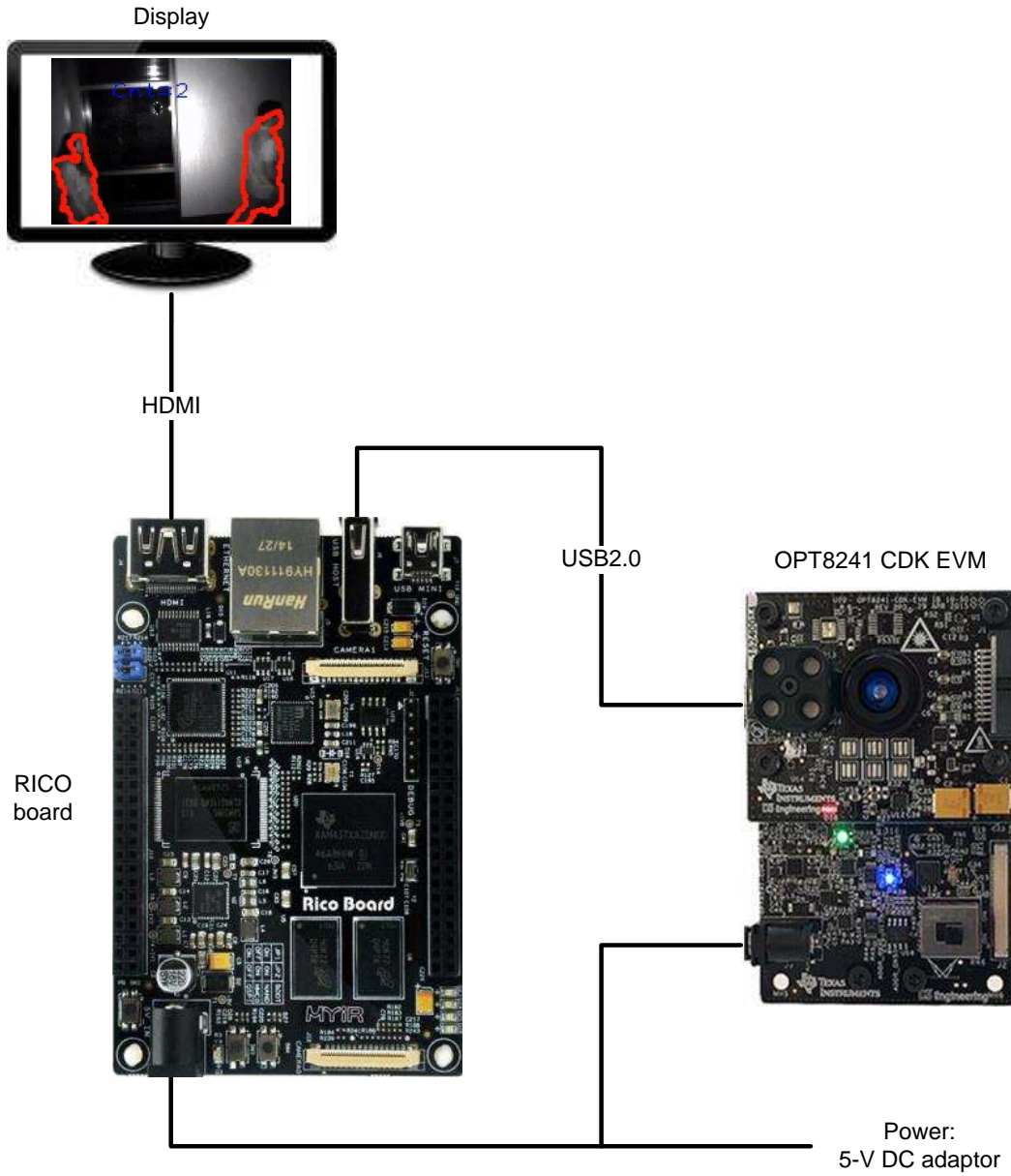
1. Recompile MYIR AM437x kernel image
2. Update kernel image on eMMC
3. Create SD card with Debian filesystem
4. Update U-Boot configuration
5. Expand the file system partition
6. Create swap space
7. Update Debian
8. Install remote desktop protocol (optional)
9. Install dependencies for PCL and Voxel SDK
10. Install Point Cloud Library (PCL)
11. Install Voxel SDK
12. Simple People Tracking Algorithm Example

5.1 Recompile Rico Board Kernel Image

Follow Chapter 2 of the Rico board Linux Development Manual to create a working directory and set up the cross-compiler tool chain. Only the kernel image will need to be recompiled.

Enter the Kernel directory and unzip the Linux Kernel source.

```
$ cd <WORKDIR>/Kernel
$ tar -xvjf linux-3.12.10-ti2013.12.01.tar.bz2
$ cd linux-3.12.10-ti2013.12.01
```

Set default kernel modification.

```
$ make ARCH=arm CROSS_COMPILE=arm-linux-gnueabi-hf- distclean
$ make ARCH=arm CROSS_COMPILE=arm-linux-gnueabi-hf- myir_ricoboard_defconfig
```

Modify kernel configuration.

```
Edit .config
CONFIG_FHANDLE=y
CONFIG_CGROUPS=y
```

Compile kernel.

```
$ make ARCH=arm CROSS_COMPILE=arm-linux-gnueabi-hf- zImage dtbs
Select yes on all prompts
```

When the build is complete, the Kernel image "zImage" is generated in path.

```
arch/arm/boot/zImage
```

The device tree file is generated in path.

```
arch/arm/boot/dts/myir_ricoboard.dtb
```

5.2 Update Kernel Image on eMMC

Follow these steps needed to update the eMMC storage kernel image and device tree file with the newly generated files. This section assumes the Rico board is running the default factory images on the eMMC.

1. Copy the new zImage and myir_ricoboard.dtb to the USB flash drive.
2. Follow the Rico Board Getting Start Guide to connect the UART connector.



图 16. Rico Board UART Connection

3. Open the serial terminal with the following host configuration:
 - Baud Rate: 115200
 - Data bits: 8
 - Stop bits: 1
 - Parity: none
 - Flow control: none
4. Boot the board using QSPI boot.
5. Login using the username "root" with no password.
6. Navigate to the eMMC kernel partition.

```
# cd /var/volatile/run/media/mmcblk0p1
```
7. Delete the current zImage and myir_ricoboard.dtb.
8. Insert the USB flash drive. The USB flash drive will automatically be mounted to /var/volatile/run/media/sda1.
9. Copy zImage and myir_ricoboard.dtb from the USB drive to mmcblk0p1.
10. Flush the cache and save all data to eMMC flash.

```
# sync
```
11. Reboot the board.
12. Keep pressing the Enter key until the terminal stops at the U-Boot prompt.

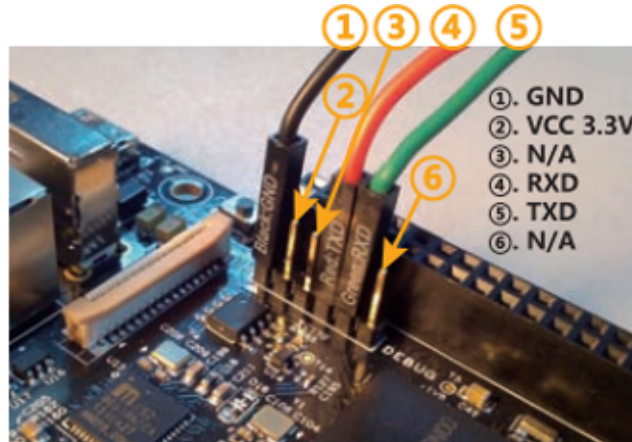
5.3 Create SD Card With Debian Filesystem

This section outlines how to create a SD card with a Debian ARM filesystem on a Windows machine. For instructions on how to perform the same task using a different machine, please refer to the Beagleboard website. At the time of this writing, the recommend image is Debian 8.3 Jessie, created on January 24, 2016.

1. Download the Beaglebone Debian image from <https://debian.beagleboard.org/images/bone-debian-8.3-lxqt-4gb-armhf-2016-01-24-4gb.img.xz>
2. Download and install [7-zip](#).
3. Use 7-zip to decompress the SD card .img file.



图 17. Extract Debian Image

4. Download and install [Image Writer for Windows](#).
5. Connect the SD card to a Windows machine.

注: The recommended SD card size is 16 GB.

- Using Win32 Disk Imager, write the Debian image to the SD card drive.

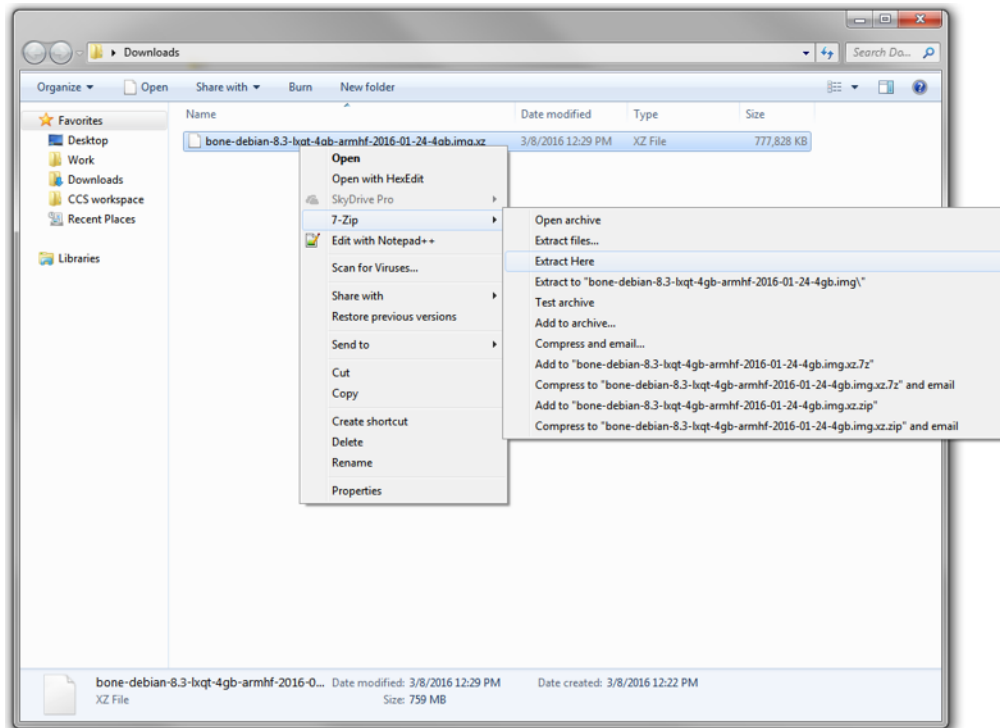

图 18. Writing Debian Image to SD Card

- Eject the SD card.
- Insert the SD card into the Rico board SD card slot.

5.4 Update U-Boot Configuration

The following U-Boot configuration will load zImage and dtb from eMMC and mount the SD card (/dev/mmcblk1p1) as a root filesystem.

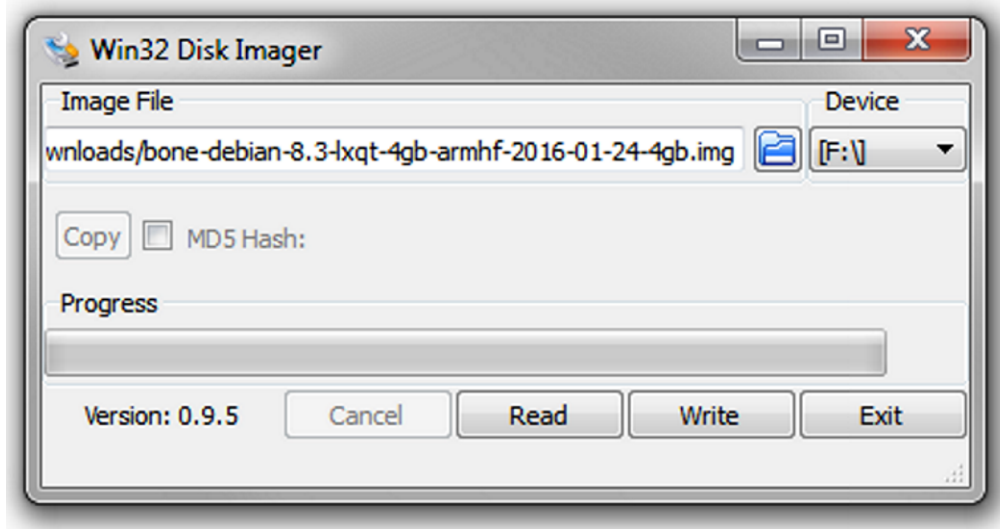
```
U-Boot> setenv bootcmd "mmc dev 1; run emmc_load; bootz ${loadaddr} - ${fdtaddr};"
```

The Debian filesystem also includes a desktop management. This is useful to visualize the captured frame from the TI ToF sensor. The following configures the board for HDMI output.

```
U-Boot> setenv bootargs "console=ttyO0,115200n8 omapdss.def_disp=display1
omapfb.mode=display1:800x600MR-24@60 spi-ti-qspi.enable_qspi=1 root=/dev/
mmcblk1p1 init=/linuxrc rootfstype=ext4"
```

If an external display is not used, the following U-boot configuration will disable the display output. Even though the display output is not active, it is still possible to run either a VNC server or remote desktop protocol on the MYIR M437x board to remotely view the desktop with an external machine.

```
U-Boot> setenv bootargs "console=ttyO0,115200n8 spi-ti-qspi.enable_qspi=1
root=/dev/mmcblk1p1 init=/linuxrc rootfstype=ext4"
```

Once all the configuration is done, save the environment variables.

```
U-Boot> saveenv
```

At this point, the AM437x Debian board setup is complete. Reboot the board and login using the username "debian" with the password "tempwd".

5.5 Expand the File System Partition

By default, the Debian filesystem will only occupy 4 GB of SD card space. Run the following commands on the AM437x to expand the filesystem to use the entire SD card.

Check the current partition size. The filesystem /dev/root is only occupying 4GB of space.

```
debian# df
```

Filesystem	1K-blocks	Used	Available	Use%	Mounted on
/dev/root	3360336	2881868	288056	91%	/
devtmpfs	241036	0	241036	0%	/dev
tmpfs	253496	4	253492	1%	/dev/shm
tmpfs	253496	12744	240752	6%	/run
tmpfs	5120	0	5120	0%	/run/lock
tmpfs	253496	0	253496	0%	/sys/fs/cgroup
tmpfs	50700	0	50700	0%	/run/user/1000

Modify the SD card partition table.

```
debian# sudo fdisk /dev/mmcblk1
```

```
fdisk> p (Print partition table)
fdisk> d (Delete all partitions)
fdisk> n (New partition)
fdisk> p (Create a primary partition)
Use the default parameters for the rest of the options
fdisk> p (Print partition table and verify size)
fdisk> w (Save new partition table)
```

Reboot to use the new partition table and resize the filesystem.

```
debian# sudo reboot
```

```
debian# sudo resize2fs /dev/mmcblk1p1
```

Verify the new partition size. The filesystem /dev/root is now occupying 15 GB of the SD card.

```
debian# df
```

Filesystem	1K-blocks	Used	Available	Use%	Mounted on
/dev/root	15319280	2882760	11762568	20%	/
devtmpfs	241036	0	241036	0%	/dev
tmpfs	253496	4	253492	1%	/dev/shm
tmpfs	253496	4524	248972	2%	/run
tmpfs	5120	0	5120	0%	/run/lock
tmpfs	253496	0	253496	0%	/sys/fs/cgroup
tmpfs	50700	0	50700	0%	/run/user/1000

5.6 Create Swap Space

In the following sections, all software will be built natively on the AM437x board. Since compiling consumes lots of memory, there might be some instances where the RAM becomes full and will cause a build error. Therefore, this section explains how to create a swap space, so when the system needs more memory resources, inactive pages can be moved to the swap space.

1. Turn off the swap space.

```
debian# sudo swapoff -a
```
2. Create a new 2GB swap file.

```
debian# sudo dd if=/dev/zero of=/swapfile bs=2M count=1024
```
3. Make this swap file usable.

```
debian# sudo mkswap /swapfile
```
4. Change swap file permission.

```
debian# sudo chmod 600 /swapfile
```
5. Turn on swap space.

```
debian# sudo swapon /swapfile
```

The following are a few of the commands to verify the size of the swap space:

```
debian# swapon -s
Filename      Type      Size      Used      Priority
/swapfile    file      2097148   0         -1

debian# top
top - 17:31:15 up 14 min,  2 users,  load average: 0.33, 0.55, 0.41
Tasks:  85 total,   2 running,  83 sleeping,   0 stopped,   0 zombie
%Cpu(s):  5.4 us, 13.6 sy,  0.0 ni, 80.3 id,  0.0 wa,  0.0 hi,  0.7 si,  0.0 st
KiB Mem:  506996 total,  484748 used,    22248 free,    10784 buffers
KiB Swap: 2097148 total,      0 used,  2097148 free.  340524 cached Mem

debian# cat /proc/meminfo
...
LowTotal:      506996 kB
LowFree:       21712 kB
SwapTotal:     2097148 kB
SwapFree:     2097148 kB
Dirty:         100 kB
Writeback:     0 kB
...
```

When the AM437x board is rebooted, the swap space does not automatically mount. Modify the `/etc/fstab` and add a line for the swap file to remount the swap space.

```
# vi /etc/fstab
# /etc/fstab: static file system information.
#
# Auto generated by RootStock-NG: setup_sdcard.sh
#
/dev/mmcblk0p1 / ext4 noatime,errors=remount-ro 0 1
debugfs /sys/kernel/debug debugfs defaults 0 0
/swapfile none swap sw 0 0
```

5.7 Update Debian

Before installing any software packages, update and upgrade the current Debian filesystem.

```
debian# sudo apt-get update
debian# sudo apt-get upgrade
```

5.8 Install Remote Desktop Protocol (Optional)

This section describes how to install the remote desktop protocol on the AM437x board. Remote desktop protocol will allow an external Windows machine to use Remote Desktop to remotely view the AM437x desktop. This is useful if an external display (LCD or HDMI monitor) is not available.

1. Remove the prepackaged tightvncserver that came with the Beaglebone Debian package.

```
debian# sudo apt-get remove tightvncserver
```
2. Install the xrdp package.

```
debian# sudo apt-get install xrdp
debian# sync
debian# sudo reboot
```

When installed, xrdp will create a boot-up script. When the AM437x board boots up, the xrdp is automatically started.

3. Plug in an Ethernet cable to the AM437x board and find the AM437x board's IP address.

```
debian# ifconfig
```
4. Run the Windows Remote Desktop Connection program and input the AM437x board's IP address.



图 19. Windows Remote Desktop Connection

- Click on "Show Options" and then the "Display" tab. Adjust "Display configuration" to the desired screen resolution.

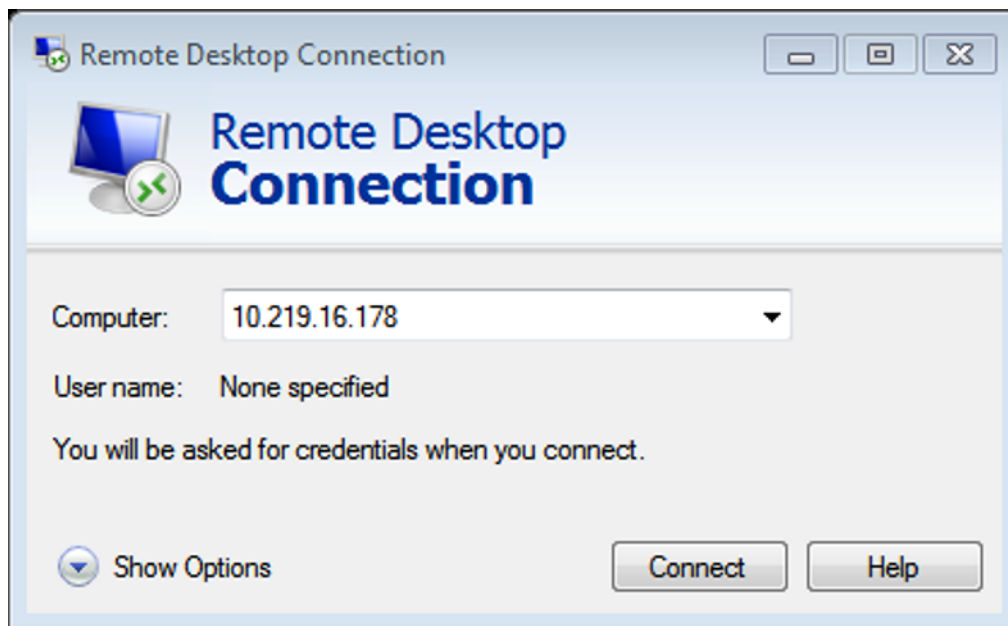

图 20. Remote Desktop Connection Display Configuration

- Click the "Connect" button. Once connected, a login prompt is shown. Login using the username "debian" and password "tempwd".

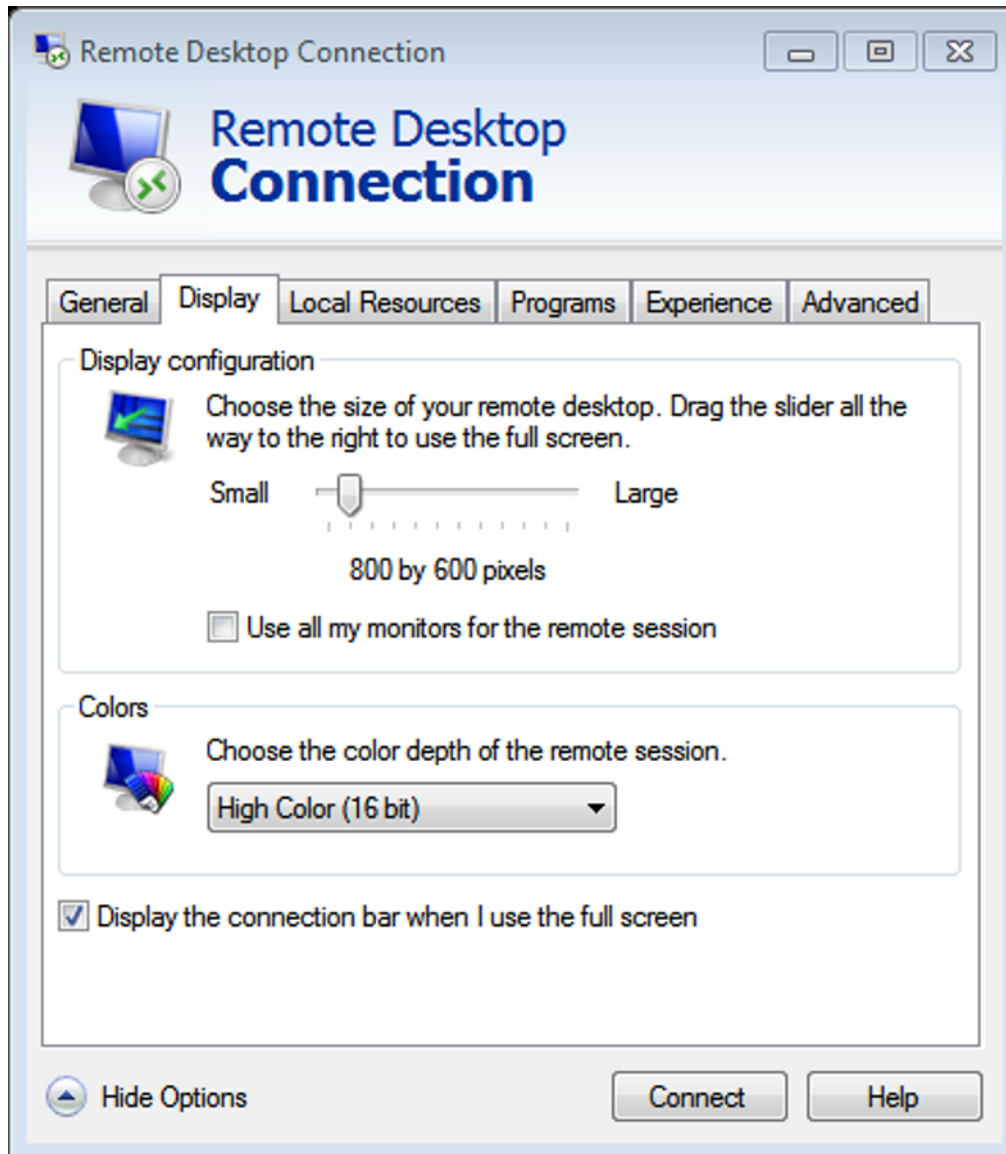

图 21. Remote Desktop Connection Login Prompt

Once logged in, to the user can visualize the AM437x board's desktop.

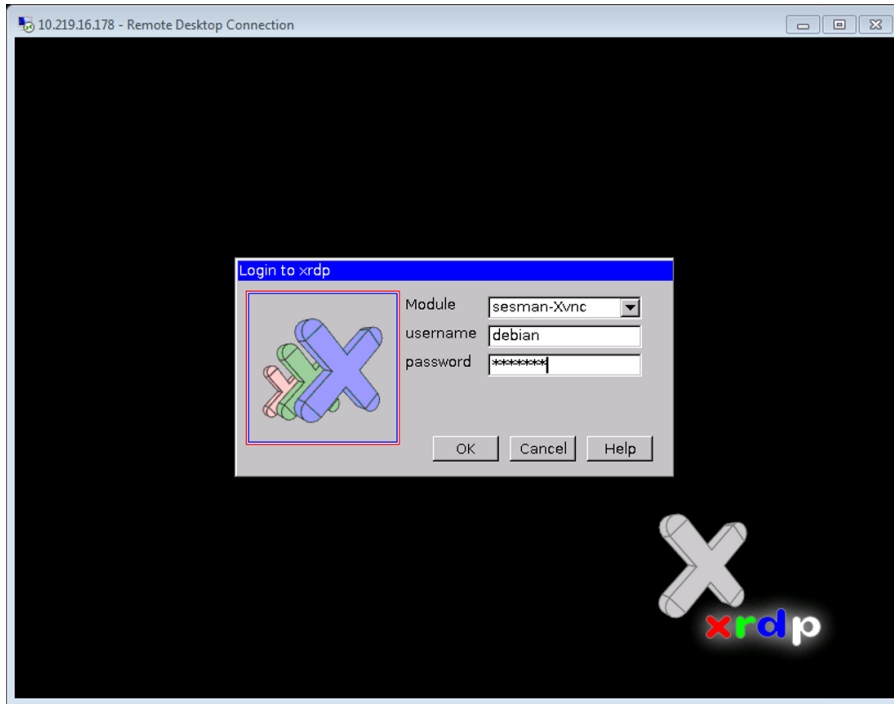

图 22. Remote Desktop Connection AM437x Desktop Environment View

5.9 Install Dependencies for PCL and Voxel SDK

The Point Cloud Library (PCL) and Voxel SDK require additional packages before they can be installed.

1. Clone the 3dtof pre-built repository.

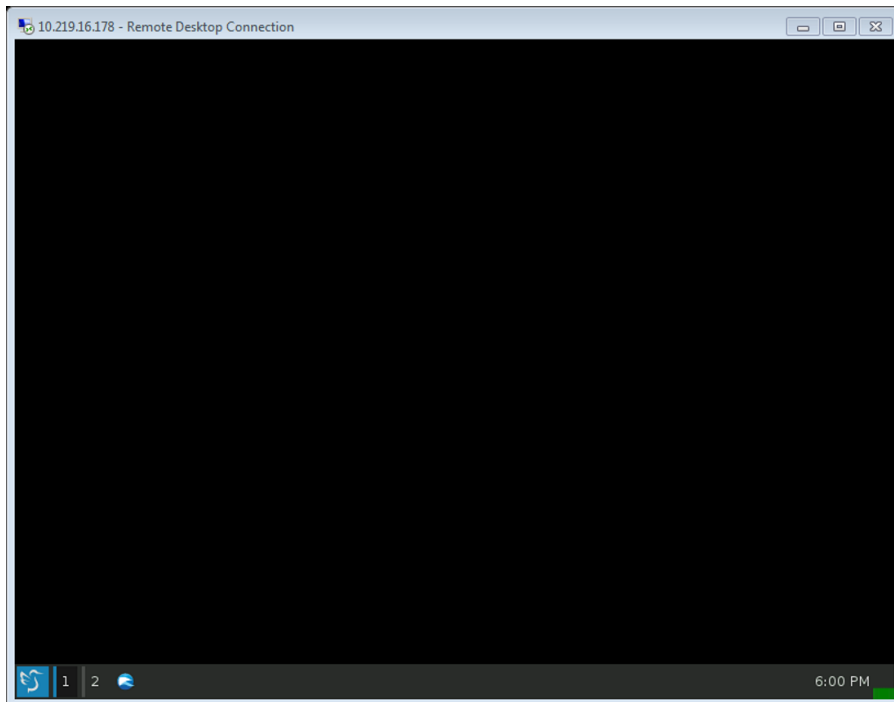
```
debian# cd ~
debian# git clone https://github.com/3dtof/prebuilt.git
```
2. Navigate into the Debian/armhf folder.

```
debian# cd prebuilt/debian/armhf
```
3. Run the install dependency script.

```
debian# ./install_dep.sh
```
4. Download and build the Kinect software.

```
debian# ./install_kinect.sh
```

5.10 Install PCL

The PCL is a standalone, large scale, open project for 2D/3D image and point cloud processing. TI Voxel SDK uses PCL for 3D image processing.

The 3dtof pre-built repository comes with a pre-built PCL package. This PCL package has the following dependencies:

- freeglut3
- libboost-chrono1.55.0
- libboost-date-time1.55.0
- libboost-filesystem1.55.0
- libboost-iostreams1.55.0
- libboost-system1.55.0
- libboost-thread1.55.0
- libc6 (≥ 2.9)
- libgcc1 (≥ 1:4.4.0)
- libgl1-mesa-glx | libgl1
- libgomp1 (≥ 4.9)
- libpng12-0 (≥ 1.2.13-4)
- libqhull6 (≥ 2012.1)
- libstdc++6 (≥ 4.9)
- libusb-1.0-0 (≥ 2:1.0.8)
- libvtk5.8

If all the dependencies are met, install the pre-built PCL package using the following command:

```
debian# sudo dpkg -i PCL-1.7.2-Linux.deb
```

If there are mismatch dependencies, build the PCL from source. Run the following script to build the PCL.

Note: Since this is built natively on the AM437x board, the compile time can take over 16 hours.

```
debian# ./install_pcl.sh
```

Once the script completes, a pre-built PCL package is generated. This package should be saved and can be used as the PCL pre-built package. This will save time by not having to compile PCL again.

5.11 Install Voxel SDK

TI offers an open-source software development kit (SDK), called Voxel SDK, from which one can develop customer 3D ToF applications quickly. Voxel SDK contains sample applications that show how to use the available APIs.

The Voxel SDK build script has been verified to work with Voxel SDK version 0.6.0. The script will patch Voxel SDK, so it can build correctly on the Debian system. If a newer version of Voxel SDK is released, look at the install script to verify the patches will apply cleanly.

Build the Voxel SDK by running the following script from the pre-built folder.

```
debian# ./install_voxelsdk.sh
```

When the script is completed, Voxel SDK libraries will be installed to the `/usr/local/lib` directory. The Voxel SDK included header files are installed to `/usr/local/voxel-0.6.0`. Since applications using Voxel SDK will reference the header files, create a symbolic link to remove the Voxel SDK version number. If a newer Voxel SDK version is installed, the symbolic link can be updated, and the application's cmake files can stay unchanged.

```
debian# cd /usr/local/include
debian# sudo ln -s voxel-0.6.0 voxel
```

Add a new environment variable, `VOXEL_SDK_PATH`, using the following command line:

```
debian# export VOXEL_SDK_PATH=/home/debian/Software/voxelsdk/build
```

To automatically add the environment variable when a new login prompt is opened, modify the `.bashrc` file.

```
debian# vi ~/.bashrc
```

At the end of the `.bashrc` file, add the new line.

```
export VOXEL_SDK_PATH=/home/debian/Software/voxelsdk/build
```

5.12 Simple People Tracking Algorithm Example

A simple people tracking example is provided to illustrate how to read data from the depth camera and use OpenCV algorithms for image processing.



图 23. Simple People Tracking Algorithm Flowchart

As shown in 图 23, this example will perform a simple foreground-background subtraction and use OpenCV contour functions to draw a circle around qualifying foreground objects.

This algorithm also provides an example on how to use basic parameters to quantify if the foreground object is an object of interest. If the contour of the foreground object does not meet the requirements, it will not be counted. The example will try to quantify if the foreground object is a standing person.

1. Contour Area: A person in the camera view will occupy a minimum amount area. A minimum contour area can be used to filter out any small objects that might appear in the foreground.

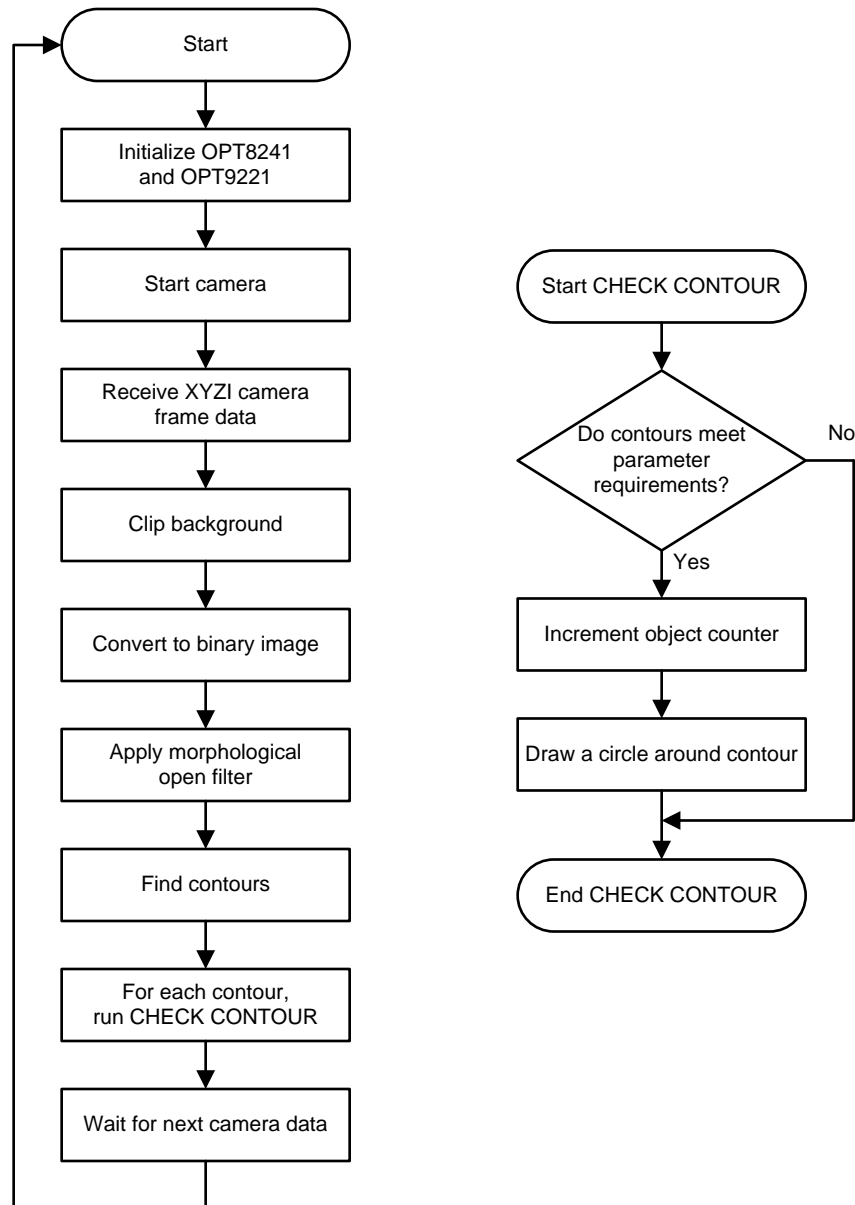
- Aspect Ratio: A standing person is taller than they are wider. Use the contour width and height to calculate the aspect ratio of the foreground object. If the resulting aspect ratio is wider than it is tall, then it will not be counted as a person.

This example does not perform more advanced techniques in object tracking or recognition. It is meant as a starter example so that more complex tracking and algorithm can be added on top. For more information about the people tracking theory, see [3.5 节](#).

Clone the Simple People Tracking example repository.

```
debian# cd ~/Software
debian# git clone https://github.com/3dtof/DemoApplications.git
```

Build the example.

```
debian# cd ~/Software/DemoApplications/TinTin/simple_people_tracking
debian# mkdir build
debian# cd build
debian# cmake ..
debian# make
```

Run the example. By default, the SimplePeopleTracking algorithm will save the first full-captured frame as the background image used for subtraction. Press the 'b' key to update the background image with the current frame.

```
debian# cd ~/Software/DemoApplications/TinTin/simple_people_tracking/build
debian# ./SimplePeopleTracking
```

```
Profile MetrilusLongRange found.
Current video mode: 160X120@30fps
_dealiasedPhaseMask = 2, _dealiasedPhaseMaskInPhaseOffset = 4
```

Updated background

[表 2](#) presents the existing parameters that can be modified in the Simple People Tracking algorithm:

表 2. Simple People Tracking Parameters

PARAMETER	FILE	VARIABLE AND DESCRIPTION
Frame size	SimplePeopleTracking.cpp	Horus variable initialization in main function Horus(int width, int height); For 320x160: Horus eye(320, 240); For 160x120: Horus eye(160, 120);
Frame rate	TOFApp.cpp	_frate _frate.numerator _frate.denominator FPS = numerator/denominator
Illumination power	TOFApp.cpp	_illum_power
Illumination duty cycle	TOFApp.cpp	_intg
Camera profile	TOFApp.cpp	_profile Camera profile contains the calibration data. By default, the firmware will use "MetrilusLongRange" profile. If another or custom profile is desired, update the "_profile" variable with the profile name. To view all profile names that are available on the camera firmware, enable the macro in TOFApp::connect function.
Amplitude gain	Horus.cpp	_ampGain Scale the amplitude output
Amplitude threshold	Horus.cpp	_ampThresh Minimum brightness of object
Depth threshold	Horus.cpp	_depthThresh Minimum thickness of object

表 2. Simple People Tracking Parameters (continued)

PARAMETER	FILE	VARIABLE AND DESCRIPTION
Minimum contour area	Horus.cpp	<code>_minContourArea</code> Minimum contour area required before algorithm will consider the contour area as a person
Aspect ratio	Horus.cpp	<code>_aspectRatio</code> Minimum aspect ratio of contour area before algorithm will consider the contour area as a person

5.13 Solutions to Common Errors During Software Development

This section describes the solution to commonly seen errors when bringing up the software on this development platform.

5.13.1 QTerminal Has Wrong Keyboard Layout, but Xterm Keyboard Works Correctly

Verify that `tightvncserver` is removed before installing `xrdp`. When `xrdp` is installed, it will also include the newer `vnc4server` and will configure the system accordingly. If `tightvncserver` is not removed, it will use `tightvncserver` instead. See [5.8 节](#) on how to remove `tightvncserver` and install `xrdp`.

5.13.2 "Randr extention missing on display" Error Message

Verify that `tightvncserver` is removed before installing `xrdp`. When `xrdp` is installed, it will also include the newer `vnc4server` and will configure the system accordingly. If `tightvncserver` is not removed, it will use `tightvncserver` instead. See [5.8 节](#) on how to remove `tightvncserver` and install `xrdp`.

5.13.3 Voxel SDK Header "<filename.h>: No such file or directory" Error Message

When building the Simple People Tracking example application and a build error message that says a VoxelSDK header file is not found, verify that the voxel header symbolic link was created as mentioned in [5.11 节](#).

5.13.4 "No depth camera library or loaded" Error Message

If you see the following error message when running an example based on Voxel SDK, verify that `VOXEL_SDK_PATH` is set up correctly. See [5.11 节](#) for more information.

```
debian#./SimplePeopleTracking
WARNING: CameraSystem: No depth camera library found or loaded.
Cannot connect
```

5.13.5 "Cannot connect" Error Message

This error message means that the AM437x cannot find the OPT8241 camera. Verify that the AM437x has successfully enumerated the camera's USB interface.

Verify that the OPT8241 USB connection has successfully enumerated on the AM437x.

```

debian# dmesg | grep usb
[ 2.046565] usb 1-1: new high-speed USB device number 2 using xhci-hcd
[ 2.053792] usbcore: registered new interface driver usbhid
[ 2.058386] usbhid: USB HID core driver
[ 2.075341] usb 1-1: New USB device found, idVendor=0451, idProduct=9105
[ 2.081099] usb 1-1: New USB device strings: Mfr=1, Product=2, SerialNumber=3
[ 2.087347] usb 1-1: Product: CDK-OPT8241
[ 2.090229] usb 1-1: Manufacturer: TI
[ 2.092759] usb 1-1: SerialNumber: 1524000615250006

```

Check that the OPT8241 is listed as an available USB device under the name "Texas Instruments, Inc."

```

debian# lsusb
Bus 002 Device 001: ID 1d6b:0003 Linux Foundation 3.0 root hub
Bus 001 Device 002: ID 0451:9105 Texas Instruments, Inc.
Bus 001 Device 001: ID 1d6b:0002 Linux Foundation 2.0 root hub

```

If the OPT8241 did not enumerate successfully or is not listed as an available USB device, restart the OPT8241 CDK.

5.13.6 "MetriulusLongRange not found" Error Message

If you do see the "MetriulusLongRange not found" error message when running the Simple People Tracking application, the OPT8241 CDK does not currently support the MetriulusLongRange camera profile. See the "Camera profile" parameter in [表 2](#) for information on how to find the supported camera profiles and where to modify the variable in the application.

5.13.7 "USBBulkStreamer: Dropping a frame because of slow forward pipeline" Error Message

The Voxel SDK will drop incomplete camera frame. When an application starts, it might receive partial frames until the USB packets get in sync. It is expected to receive a few of these error messages when the application starts. However, if the error messages are persistently printed, then there might be an issue with the USB communication.

The following are some possible solutions:

- Directly connect USB cable from OPT8241 CDK to AM437x with no hub.
- Use a shorter micro USB cable.
- Reduce the camera frame size or frame rate.

5.13.8 "ERROR: USBIO: Bulk transfer failed." Error Message

This error message is related to the "USBBulkStreamer: Dropping a frame because of slow forward pipeline" error message. If the Voxel SDK receives too many partial frames, it will try to reset the bulk endpoint. If the error message is persistent, then try the following solutions:

- Directly connect USB cable from OPT8241 CDK to AM437x with no hub.
- Use a shorter micro USB cable.
- Reduce the camera frame size or frame rate.

6 Test Setup

6.1 Power Consumption

To accurately measure supply current, the transformer was cut off from the power supply (leaving only the cable) and replaced with a bench power supply and digital multimeter. This provides the ability to measure the supply current without performing any board modifications. The test setup for the supply current measurements is illustrated in 图 24. The modified power cable used to connect to the bench meter is shown in 图 25.

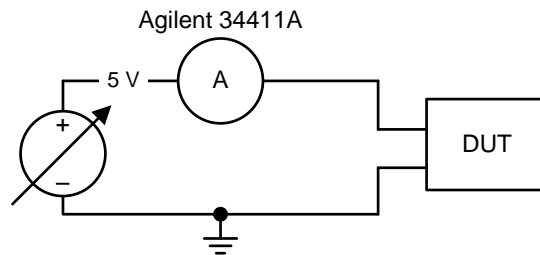

Copyright © 2016, Texas Instruments Incorporated

图 24. Test Circuit Used for Measuring Supply Current



图 25. Power Cable Connection to Bench Meter

6.2 Functional

In this setup, the OPT8241 CDK was mounted on top of a tripod, which was placed on top of the table for a combined height of 8 feet. This simulates if the camera was mounted closer to the ceiling for a top-down view. The camera was viewing an area that was 12 feet wide by 12 feet deep. A micro USB cable from the camera is directly connected (with no hub) to the Rico board.

The Rico board was connected to a tripod leg. An Ethernet cable was connected from the Rico board to a laptop, which used remote desktop protocol to visualize the Rico board's desktop environment.

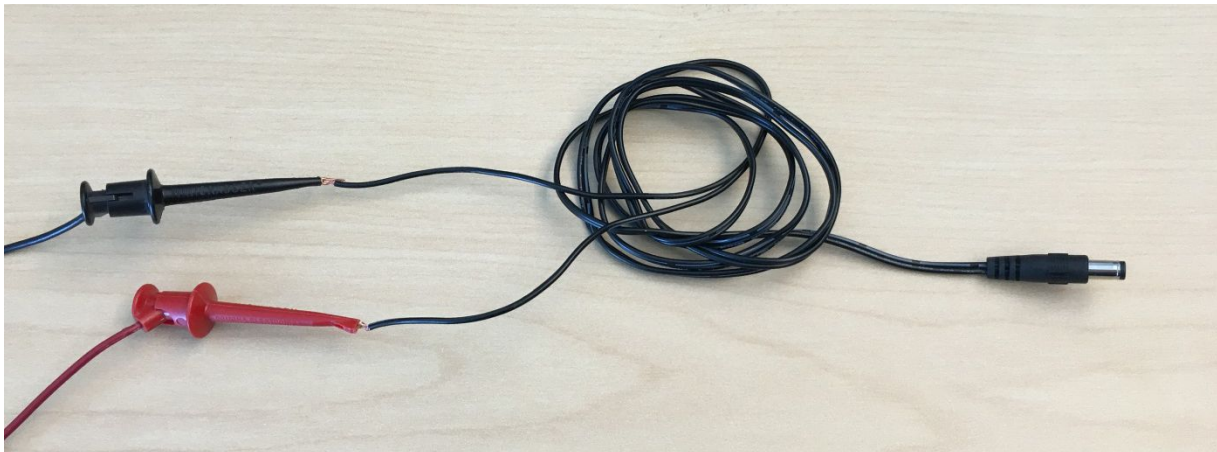
In this test setup, only the remote desktop was used to visualize the desktop. However, an HDMI monitor can also be used. Since the camera occupied the only USB port on the Rico board, it is not possible to connect a USB keyboard or mouse to the board. The following steps outline how to display the application output video without an external keyboard and mouse:

1. Open the board terminal.
2. Set the following variable. This will direct all video output to the HDMI monitor.

```
debian# export DISPLAY=:0
```
3. Run the application. At this point, any application's video output will be rendered on the HDMI monitor.
4. If there is a situation where the login prompt is shown in the desktop, restart the desktop monitor to automatically log in again.

```
debian# sudo /etc/init.d/lightdm restart
```



图 26. OPT8241 CDK and Rico Board on Tripod



图 27. 3D ToF Functional Test Setup



图 28. Top-Down View of 3D ToF Camera

7 Test Data

注: Unless otherwise noted, the test data in the following sections were measured with the system at room temperature.

All of the measurements in this section were measured with calibrated lab equipment.

7.1 Frame Size and Frame Rate Performance

Depending on the image processing algorithm, the processor will require a certain amount of time to process and compute each frame. However, if the time needed to read in the frame and run the algorithm requires a long time, the processor will either miss the next frame or read the next frame at a delayed time. Both options are not a desired effect when it comes to real-time people tracking.

For this test, the frame size and frame rate were set to different values in the Simple People Tracking algorithm. The Simple People Tracking terminal output was monitored for 10 seconds to determine if any frames were dropped by the presence of continuous USB error messages. For more information on the USB error messages, see 节 5.13.7 and 节 5.13.8.

表 3. Error Messages Shown in Simple People Tracking at Different Frame Size and Frame Rate

RESOLUTION	30 FPS	20 FPS	10 FPS
320 × 240	Continuous "USBBulkStreamer: Dropping a frame" error	No continuous error messages	No continuous error messages
320 × 120	No continuous error messages	No continuous error messages	No continuous error messages
160 × 240	No continuous error messages	No continuous error messages	No continuous error messages
160 × 120	No continuous error messages	No continuous error messages	No continuous error messages
160 × 60	No continuous error messages	No continuous error messages	No continuous error messages
80 × 120	No continuous error messages	No continuous error messages	No continuous error messages
80 × 60	No continuous error messages	No continuous error messages	No continuous error messages

The results are seen in 表 3. When the camera sensor was configured for a 320×240 frame size at 30 frames per second, many camera frames were being dropped. All other frame size and rate parameters did not show any errors.

Since the data was captured by running the Simple People Tracking algorithm, a different or more complex algorithm may cause different results. If the frame size or frame rate is causing video performance issues, the frame rate or frame size can be reduced to lower the time spent during data read.

If a frame rate and frame size is a fixed requirement, there are multiple methods to improve the performance. One method is to bypass the OPT8241 CDK's camera interface to the USB bridge and directly connect the camera interface to the AM437x. However, this requires multiple software changes, which this design guide does not cover. Another method is to select a higher performance processor.

7.2 Power Characterization

7.2.1 OPT8241 CDK Power Profile

The test setup for the supply current measurements is illustrated in [图 24](#). The OPT8241 CDK is running with the following conditions:

- 5-V power input
- 60% illumination power
- 20% illumination duty cycle
- Simple People Tracking algorithm

When the OPT8241 CDK is first powered on, the illumination circuit is not on. The initial power consumption is 355 mA.

When the Simple People Tracking algorithm starts, it will initialize the illumination circuit with the parameters defined above. The supply current data is shown in [表 4](#).

表 4. OPT8241 CDK Active Supply Current

FRAME SIZE	FRAME RATE	MEASURED CURRENT
320 × 240	30 fps	972 mA
320 × 240	20 fps	949 mA
320 × 240	10 fps	945 mA
160 × 120	30 fps	963 mA
160 × 120	20 fps	944 mA
160 × 120	10 fps	938 mA
80 × 60	30 fps	958 mA
80 × 60	20 fps	938 mA
80 × 60	10 fps	937 mA

The measured active current is relatively higher than initial power consumption. This is due to the illumination circuit and laser being off by default. The power consumption of the illumination circuit can be lessened by reducing the illumination power and duty cycle. However, this will cause a tradeoff in performance, since the laser will not be on as often.

7.2.2 Rico Board Power Profile

The test setup for the supply current measurements is illustrated in 图 24. The Rico board is running with the following conditions:

- 5-V power input
- On-demand CPU governor, which will scale the frequency depending on the CPU utilization

When the Rico board is powered on but not running any applications, the CPU governor will configure the CPU frequency to 300 MHz. Additionally, only the Ethernet cable with a SSH terminal prompt and SD card is connected. All other interfaces are disconnected. At this point, the supply current is at 357 mA.

Prior to running the Simple People Tracking application, the USB cable to the OPT8241 CDK is connected. When the Simple People Tracking application is running, the CPU governor will scale the CPU frequency between 600 to 1000 MHz. The amount of time the CPU is running at 1000 MHz depends on how long it takes the CPU to read the camera data and process the frame using the Simple People Tracking algorithm. Once the CPU has completed the image processing and before the next camera frame arrives, the CPU governor will reduce the CPU frequency down to 600 MHz to conserve power. The supply current data is shown in 表 5.

表 5. AM437x Active Supply Current

FRAME SIZE	FRAME RATE	MEASURED CURRENT
320 × 240	30 fps	555 mA
320 × 240	10 fps	550 mA
160 × 120	30 fps	531 mA
160 × 120	10 fps	500 mA
80 × 60	30 fps	510 mA
80 × 60	10 fps	493 mA

Different image processing algorithms may cause different results. As previously mentioned, the longer it takes the CPU to read and process the camera frame, the longer the CPU will stay in the higher power consuming but faster CPU frequency.

7.2.3 Alternative Methods to Reduce Power Consumption

Additional sensors can be added to the system as a first level detection and to help reduce the overall power consumption. In this scenario, the higher power consuming TFC and host processor can be placed in its lowest power state. The low power external sensor is always on and will trigger the higher power devices to wake up whenever a condition is met. Within the algorithm, a routine can be defined to return the higher power devices back into low power mode whenever it detects no additional objects or see no activity after a predetermined set of time.

Depending on your application, there are multiple low power external sensors that can be added to the system. There are two options. One low power sensor option is the PIR motion detector. Whenever the PIR sensor detects the first motion, it will wake up the higher power devices and start the algorithm to get an accurate count on the number of people. Another option is an ambient light sensor. This sensor is useful in office situations where the lights are usually on when a person is present. The ambient light sensor will monitor when the light reaches a certain brightness threshold. When that occurs, the light sensor will wake up the higher power devices.

7.3 Functional

7.3.1 Ambient Light Immunity

The system was tested against three ambient light conditions: full brightness (1100 lux), half brightness (400 lux) and no light (0 lux). The test subject stood 12 feet away from the camera. While the Simple People Tracking algorithm is running, the ambient light was changed using the room's wall light dimmer switch. The brightness was measured by placing an Extech light meter (model 407026) near the camera. As seen in the output below, the light levels do not affect the performance of the ToF system.



图 29. Traditional Camera View



图 30. Full Brightness at 1100 Lux

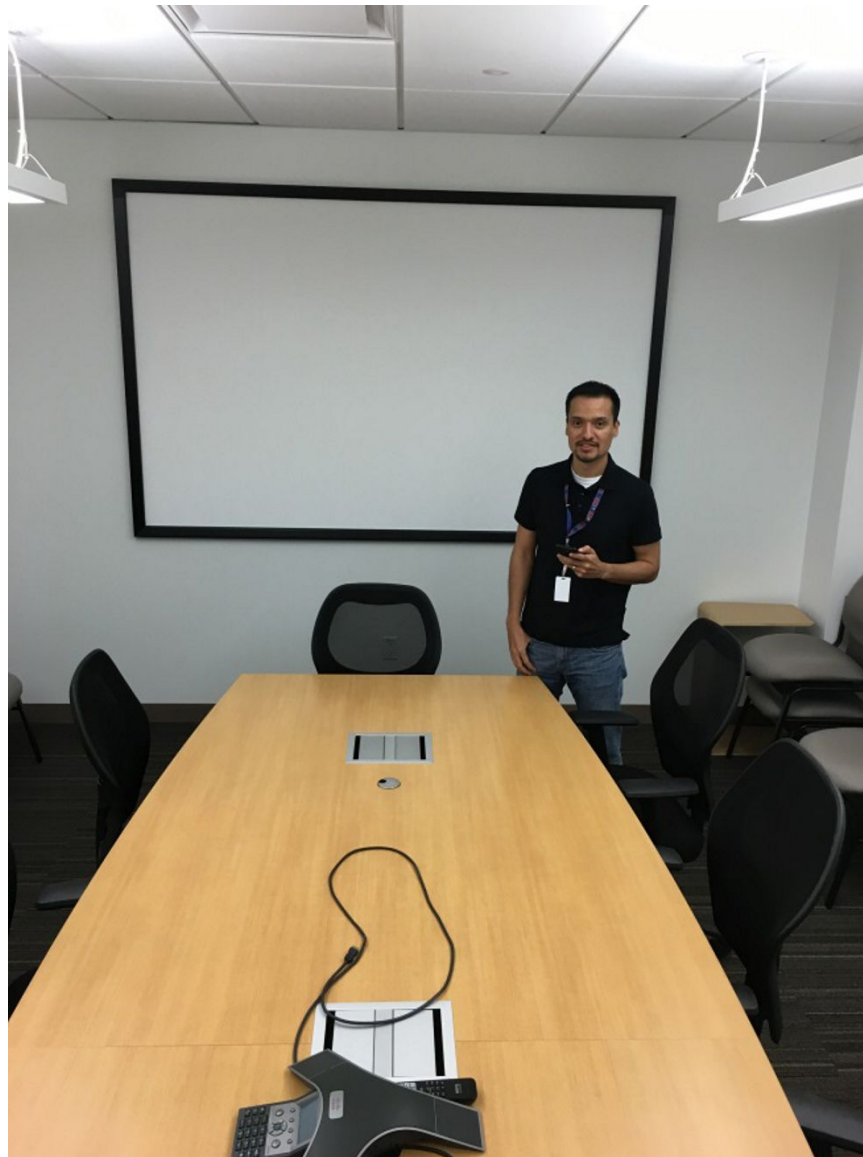

图 31. Half Brightness at 400 Lux

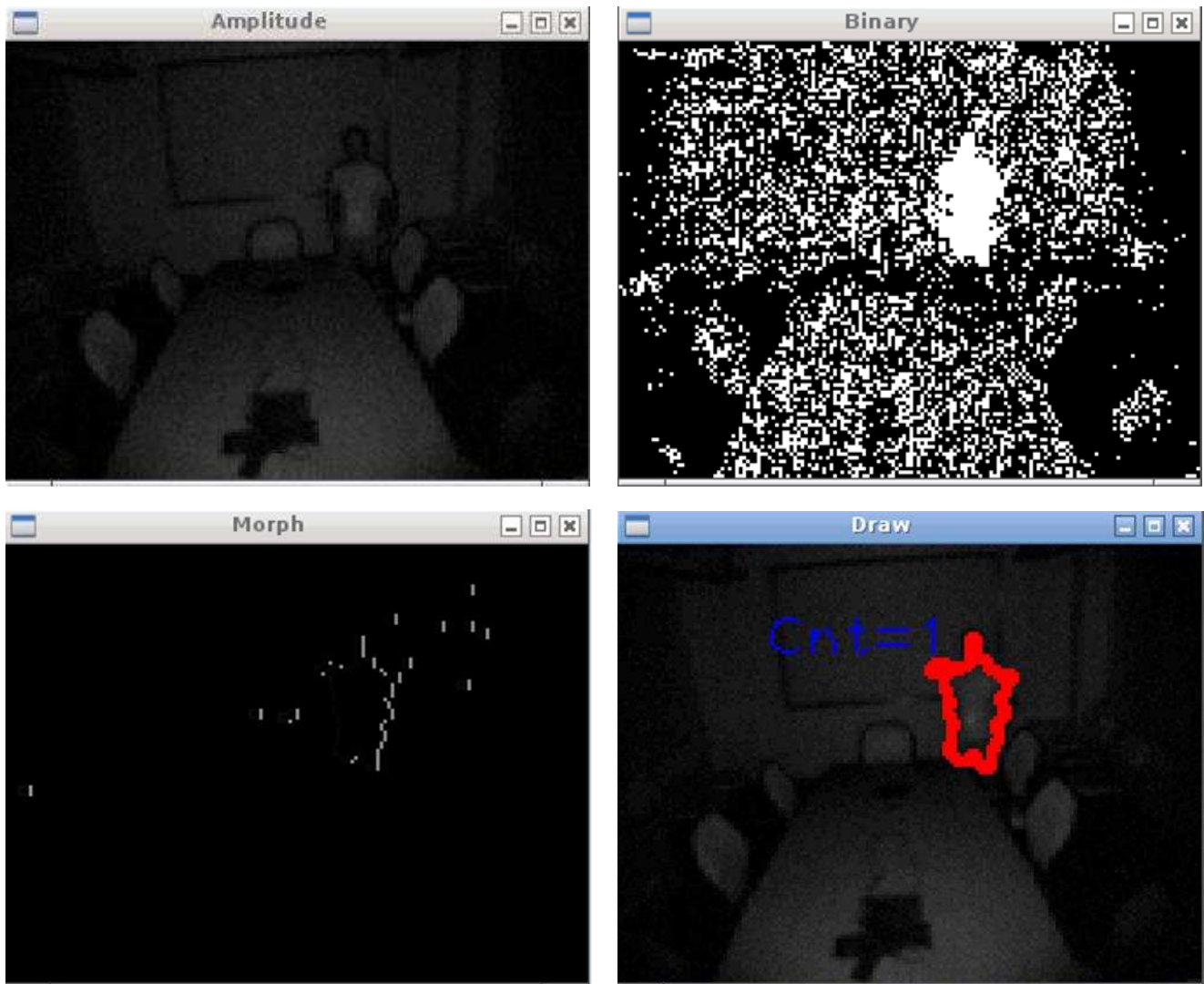

图 32. No Light at 0 Lux

7.3.2 Multiple People

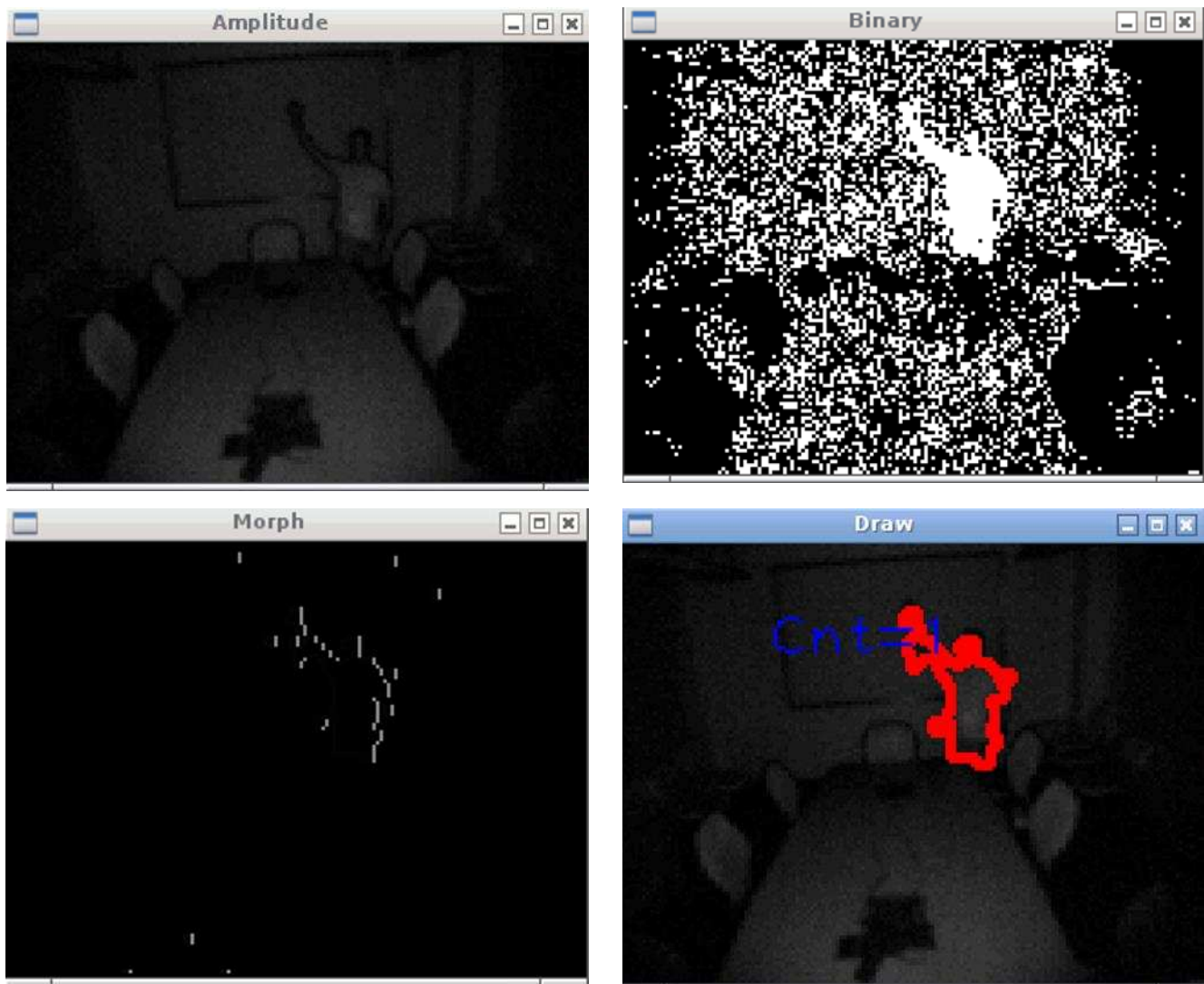
This test shows the Simple People Tracking algorithm ability to detect multiple people. The test setup is described in 6.2 节. Six test subjects were asked to sit or stand in the conference room, but they must not overlap or block another test subject.

注: The traditional camera has a smaller field of view compared to the OPT8241 CDK. Therefore, the traditional camera picture clipped the outer edges of the picture.

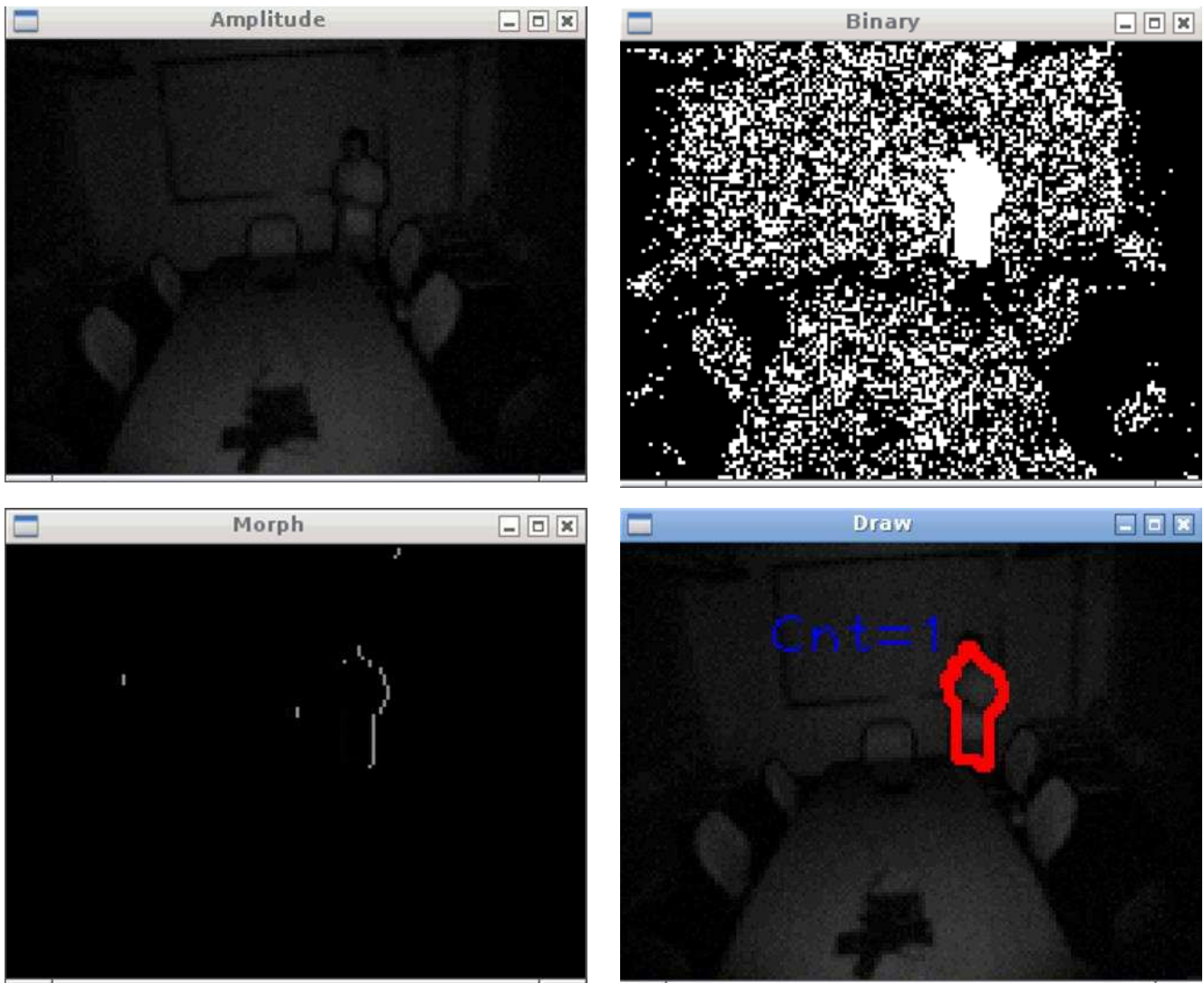

图 33. Traditional Camera View



图 34. Simple People Tracking Algorithm Output

The Simple People Tracking algorithm was able to detect all six people in the room. However, while people were moving in the room, a chair was displaced from its original background location. Therefore, the chair was counted as a foreground object. The blue boxes below show the location of the chair.

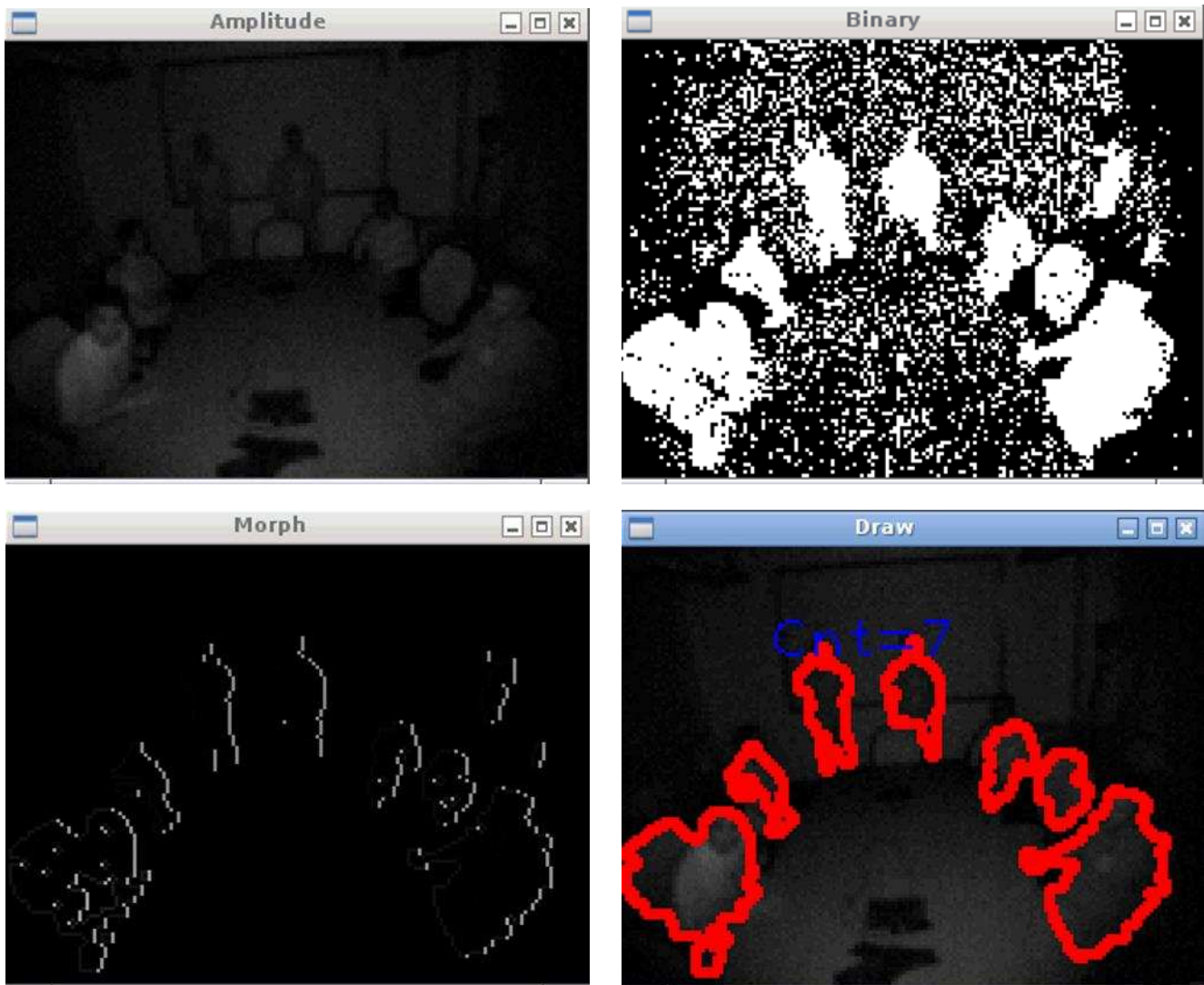

图 35. Displaced Chair From Simple People Tracking Algorithm Output

The Simple People Tracking algorithm can successfully detect the foreground objects, but the algorithm also has room for improvement. For example, a more sophisticated foreground-background subtraction (节 3.5.1) or tracking of people entering and exiting the camera view (节 3.5.4) will be able to improve the algorithm by filtering out displaced background objects, as seen by the chair in the above pictures.

Another area of improvement is how to accurately count objects that are overlapping or blocked by another object. In this test setup, each subject was asked not to overlap or block another test subject. This is due to the implementation of the Simple People Tracking algorithm. As mentioned in Simple People Tracking Algorithm Example, the algorithm uses OpenCV contour functions to draw around the foreground objects. However, if two objects overlap, there will only be one contour that circles both objects. The algorithm does not take into account how to distinguish multiple objects within one contour.

8 Design Files

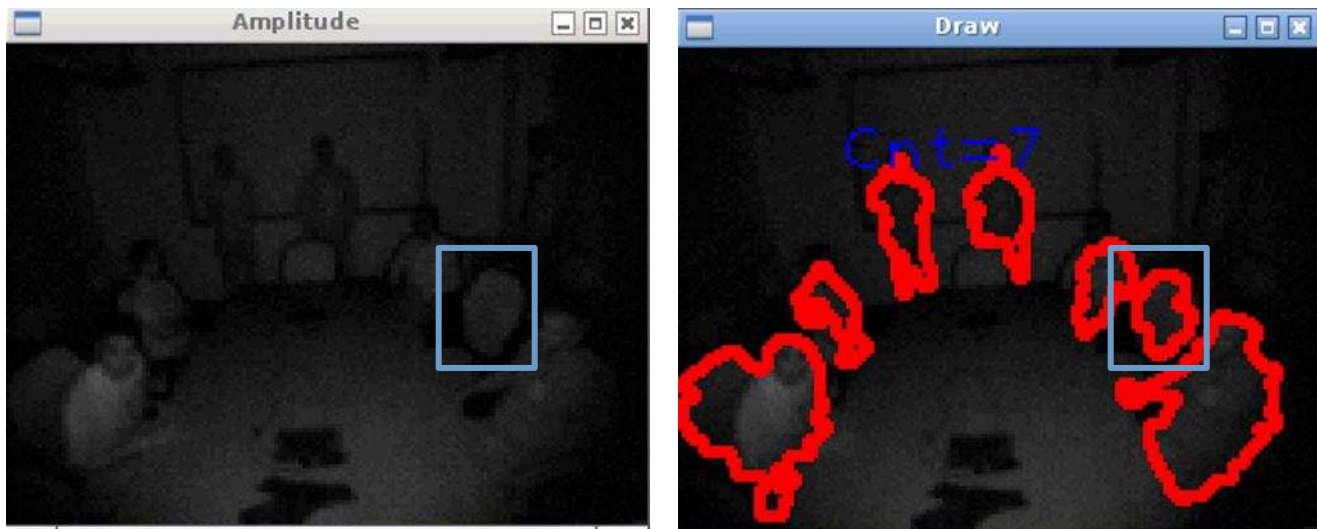
8.1 OPT8241-CDK-EVM

Download the design files from <http://www.ti.com/tool/opt8241-cdk-evm>.

8.2 RICO Board

Download the design resources from <http://www.myirtech.com/list.asp?id=510>.

9 Software Files

For the Rico board kernel files, contact MYIR or reference the CD included in the AM437x Rico board kit.

For the Voxel SDK and Simple People Tracking algorithm, download the source from <https://github.com/3dtof>. See 5 节 for more information on the correct repository to access.

10 References

1. Texas Instruments, *Introduction to the Time-of-Flight (ToF) System Design*, ToF User's Guide (SBAU219).
2. Texas Instruments, *Time-of-Flight Camera — An Introduction*, Technical White Paper (SLOA190).
3. Texas Instruments, *OPT8241 Evaluation Module*, OPT8241 User's Guide (SBOU155).
4. Texas Instruments, *OPT8241 Evaluation Module*, OPT8241 Quick Start Guide (SBOU156).
5. Texas Instruments, *OPT8241 3D Time-of-Flight Sensor*, OPT8241 Datasheet (SBAS704).
6. Texas Instruments, *OPT9221 Time-of-Flight Controller*, OPT9221 Datasheet (SBAS703).
7. Texas Instruments, *AM437x Sitara™ Processors*, AM437x Datasheet (SPRS851).
8. Watson, Robin, *Method for Segmentation of Articulated Structures Using Depth Images for Public Displays* (PDF)
9. Learn OpenCV, *Blob Detection Using OpenCV (Python, C++)* (<http://www.learnopencv.com/blob-detection-using-opencv-python-c/>)

10.1 商标

All trademarks are the property of their respective owners.

11 About the Authors

CHRISTINA S. LAM is a Systems Architect at Texas Instruments where she is responsible for developing firmware for reference design solutions in the industrial segment. Christina has broad experience with applications processors, microcontrollers, and digital-signal processors with specialties in embedded firmware. Christina earned her bachelor of science (BS) in electrical and computer engineering from the University of Texas at Austin.

SHARAD YADAV is a Systems Engineer at Texas Instruments India where he is responsible for developing reference design solutions for the industrial segment. Sharad has eight years of experience in high-speed digital, mixed-signal boards, low-noise analog, and EMC protection circuit design.

修订版本 A 历史记录

注：之前版本的页码可能与当前版本有所不同。

Changes from Original (April 2016) to A Revision	Page
• 已添加 FILE column to 表 2	43
• 已添加 FILE column to 表 2	44

有关 TI 设计信息和资源的重要通知

德州仪器 (TI) 公司提供的技术、应用或其他设计建议、服务或信息，包括但不限于与评估模块有关的参考设计和材料（总称“TI 资源”），旨在帮助设计人员开发整合了 TI 产品的应用；如果您（个人，或如果是代表贵公司，则为贵公司）以任何方式下载、访问或使用了任何特定的 TI 资源，即表示贵方同意仅为该等目标，按照本通知的条款进行使用。

TI 所提供的 TI 资源，并未扩大或以其他方式修改 TI 对 TI 产品的公开适用的质保及质保免责声明；也未导致 TI 承担任何额外的义务或责任。TI 有权对其 TI 资源进行纠正、增强、改进和其他修改。

您理解并同意，在设计应用时应自行实施独立的分析、评价和判断，且应全权负责并确保应用的安全性，以及您的应用（包括应用中使用的 TI 产品）应符合所有适用的法律法规及其他相关要求。您就您的应用声明，您具备制订和实施下列保障措施所需的一切必要专业知识，能够 (1) 预见故障的危险后果，(2) 监视故障及其后果，以及 (3) 降低可能导致危险的故障几率并采取适当措施。您同意，在使用或分发包含 TI 产品的任何应用前，您将彻底测试该等应用和该等应用所用 TI 产品的功能。除特定 TI 资源的公开文档中明确列出的测试外，TI 未进行任何其他测试。

您只有在为开发包含该等 TI 资源所列 TI 产品的应用时，才被授权使用、复制和修改任何相关单项 TI 资源。但并未依据禁止反言原则或其他法律授予您任何 TI 知识产权的任何其他明示或默示的许可，也未授予您 TI 或第三方的任何技术或知识产权的许可，该等产权包括但不限于任何专利权、版权、屏蔽作品权或与使用 TI 产品或服务的任何整合、机器制作、流程相关的其他知识产权。涉及或参考了第三方产品或服务的信息不构成使用此类产品或服务的许可或与其相关的保证或认可。使用 TI 资源可能需要您向第三方获得对该等第三方专利或其他知识产权的许可。

TI 资源系“按原样”提供。TI 兹免除对 TI 资源及其使用作出所有其他明确或默认的保证或陈述，包括但不限于对准确性或完整性、产权保证、无复发故障保证，以及适销性、适合特定用途和不侵犯任何第三方知识产权的任何默认保证。

TI 不负责任何申索，包括但不限于因组合产品所致或与之有关的申索，也不为您辩护或赔偿，即使该等产品组合已列于 TI 资源或其他地方。对因 TI 资源或其使用引起或与之有关的任何实际的、直接的、特殊的、附带的、间接的、惩罚性的、偶发的、从属或惩戒性损害赔偿，不管 TI 是否获悉可能会产生上述损害赔偿，TI 概不负责。

您同意向 TI 及其代表全额赔偿因您不遵守本通知条款和条件而引起的任何损害、费用、损失和/或责任。

本通知适用于 TI 资源。另有其他条款适用于某些类型的材料、TI 产品和服务的使用和采购。这些条款包括但不限于适用于 TI 的半导体产品 (<http://www.ti.com/sc/docs/stdterms.htm>)、[评估模块](http://www.ti.com/sc/docs/sampters.htm)和样品 (<http://www.ti.com/sc/docs/sampters.htm>) 的标准条款。

邮寄地址：上海市浦东新区世纪大道 1568 号中建大厦 32 楼，邮政编码：200122
Copyright © 2017 德州仪器半导体技术（上海）有限公司