

TI 设计: TIDC-DSSS868WMBUS-DC

用于 wM-Bus T 模式/C 模式和扩频编码远距离模式的数据收集器



说明

智能燃气表、水表、耗热分配器和某些电子式电表可将数据传送到固定或移动数据收集器，然后数据收集器再将这些数据转发给后端系统进行进一步处理。wM-Bus T 模式是一种非常流行的解决方案，可用于以 868.95MHz 的频率周期性地发送仪表数据，如今已被应用于数以百万计的智能仪表。数据收集器器件要求出色的灵敏度和阻断性，并且必须容忍较大的频率偏移以接收尽可能多的数据包。通过扩频编码可获得额外的 4dB 链路预算，这一链路预算足以用于读取器件，而这在 T 模式或 C 模式下是不可能实现的。基于随附的软件示例，用户可以快速设计出数据收集器或移动读取器装置，并可利用它们来同时接收来自支持 T 模式或 C 模式的器件或专有数据包的数据。

资源

TIDC-DSSS868WMBUS-DC	设计文件夹
MSP430F5438A	产品文件夹
CC1125	产品文件夹
TPS62745	产品文件夹
CC1125EM-868-915-RD	工具文件夹



咨询我们的 E2E 专家
WEBENCH® 设计中心

特性

- wM-Bus T 模式下可提供最佳灵敏度、选择度和阻断性，具有 $\pm 12\%$ 数据速率容差（包括在 868.95MHz 的频率下支持 C 模式）
- 具有适用于数据收集器和移动读取器的扩频 RF 链路
- 提供了在 868.95MHz 的频率下用于同时接收 wM-Bus T 模式和 C 模式的示例源代码及其它数据包
- 超低 IQ、高达 90% 的 DC/DC 效率，具有可调节输出电压，适用于多电池技术和拓扑

应用

- 采用 wM-Bus 和专有远距离模式的数据收集器
- 采用 wM-Bus 的家用/消费类显示器（频段为 868MHz）
- 采用 wM-Bus 的移动阅读器

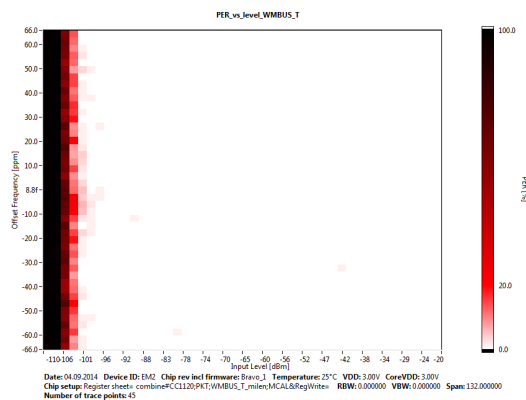
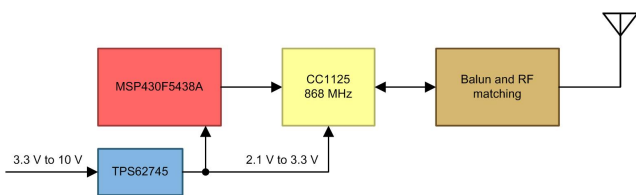
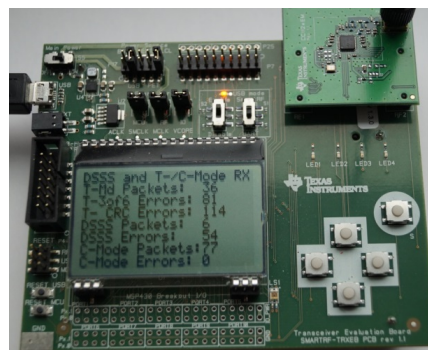



该 TI 参考设计末尾的重要声明表述了授权使用、知识产权问题和其他重要的免责声明和信息。

1 Key System Specifications

The CC1125 transceiver is the leading performing device in the CC112x performance line family. The CC1125 transceiver has the option to set narrower receiver filter bandwidths than the rest of the family (down to 3 kHz), making the transceiver suitable for 6.25-KHz channel spacing solutions and below. The CC1125 transceiver was released to market in 2011 and is the world's first integrated transceiver to achieve a European Telecommunications Standards Institute (ETSI) Category 1 receiver compliance in the 868-MHz band. The maximum receive filter bandwidth of 250 KHz for the CC1125 enables market-leading selectivity and blocking performance, as well as receiver sensitivity in T- and C-Modes of -105.6 dBm at PER = 80% and a payload of 20 bytes [7].

The TI MSP430F5438A™ microcontroller operates between 1.8 V and 3.6 V and is a 16-bit ultra-low power microcontroller (MCU) with a 256-KB flash, 16-KB of RAM, and with up to a 25-MHz system clock. These resources are sufficient for implementing a simple data collector unit, which can be battery-powered and run for many years depending on the battery capacity used. The digitally controlled oscillator (DCO) allows the device to wake up from low-power modes to active mode in 3.5 μ s (typical).

The four universal serial communication interfaces (USCI) enable up to eight serial peripheral interfaces (SPIs) or four UART; and four SPI or I²C communication links. A low-cost and low-power graphical liquid-crystal display (LCD) displays the user information, enabling multiple applications such as mobile (or handheld) reader units and in-home customer displays.

The TPS62745 is a synchronous step down converter with up to 90% efficiency and is optimized for low-power wireless applications, delivering a regulated output voltage while consuming a 400-nA quiescent current. The device operates from two rechargeable lithium-ion (Li-Ion) batteries, Li-primary battery chemistries such as Li-SOCl₂, Li-SO₂, Li-MnO₂, or four-cell to six-cell alkaline batteries.

The operating ambient temperature for the MSP430F5438A, CC1125, and TPS62745 devices is $T_A = -40^\circ\text{C}$ to 85°C .

2 System Description

The CC1125 device targets systems with an ETSI Category 1 compliance in all European sub-1GHz bands, namely 169-, 433-, and 868-MHz Bands. The other device family members, CC1120 and CC1200, can also achieve an ETSI Category 1 receiver compliance for the two lower frequency bands, but only the CC1125 transceiver achieves that in the 868-MHz band.

Note that adding an external surface acoustic wave (SAW) component is a good practice for situations when a global system for mobile communications (GSM), general packet radio service (GPRS), 3G modem, or 4G modem is being used in the same system, which is often the case in data collectors or in e-meters with data collecting functions. In addition to low-cost XTAL devices, the CC1125 transceiver also supports temperature compensated crystal oscillator (TCXO) components, which are popular in narrow-band (< 25 KHz) RF applications.

Using a supply voltage of up to 3.6 V delivers excellent RF results but this is at the cost of an increased power loss in the internal low-dropout regulators (LDOs) of the CC1125 transceiver. To reduce these power efficiency losses and extend the battery life in such RF systems, TI recommends using the lowest possible supply voltage for both MCU and RF devices. Another important point to consider is that the supply voltage must be the same for both the MSP430F5438A device running the wM-Bus protocol example code and the CC1125 transceiver to avoid voltage level issues on the SPI and the control signals between those two devices. The adjustable output voltage of the TPS62745 is an excellent fit here and provides 3.3 V in transmit mode or 2.1 V in sleep or receive operation modes.

Using the system power budget of the current consumption for receive and transmit operations it is possible to calculate the most efficient power scheme for any radio-enabled system. The transmit current for a 500-mW RF system can be up to 20 times higher compared to a 25-mW RF system, such as an wM-Bus T- or C-Mode smart meter.

To enable transmission with 500 mW in the 869.525-MHz ETSI sub-band, an external power amplifier is necessary. In the receive direction, adding an external low-noise amplifier (LNA) can further improve the RX sensitivity. The CC1190 device is the recommended solution that combines both the PA and LNA functions for 868 MHz. TI's AN112 [8] describes in detail the performance of a combined CC1120 and CC1190 RF module. The designer can also use the CC1125 device to build an 868-MHz compliant wM-Bus 500-mW transmit power module, which can handle S2, T2, and C2-modes in the data collector (or so called "Other" wM-Bus device).

Low-power modes for the MCU and radio are relevant because data collectors and mobile reader units are continuously in receive mode, during which, the MCU core can mostly remain in "sleep" mode. The MSP430F5438A device remains in "sleep" mode while the CC1125 transceiver searches for a synchronous word to detect a valid data packet. If the transceiver detects a data packet, the CC1125 starts filling up its receive first-in first-out buffer (RX FIFO) and wakes the MSP430 device up as soon as the preset FIFO threshold level has been reached.

In transmit mode, the data collector unit can create a data packet and if required by the wM-Bus protocol, the data collector starts a two-way communication to the end device (such as a meter).

The combination of a CC1125 transceiver and an MSP430F5438A MCU delivers a market-leading solution in terms of both RF performance and also ultra-low power consumption, enabling battery-powered data collectors or mobile reader units. The addition of the TPS62745 converter enables a wide variety of battery topologies and chemistries and also supports both primary and rechargeable battery types.

2.1 MSP430F5438A—Ultra-Low Power MCU With 256-KB FLASH and 16-KB RAM

图 1 shows the MSP430F5438A, which is a 16-bit embedded MCU with optimized low-power modes, an active current of 230 μ A/MHz (flash operation), and a standby mode of 1.7 μ A with a real-time clock (RTC) counter, watchdog, supply supervisor active, and full RAM retention with fast wake-up.



图 1. MSP430F5438A Functional Block Diagram

2.2 CC1125—Highest-Performance RF Transceiver for Narrowband Systems

The CC1125 transceiver features an adjacent channel selectivity of 64 dB at the 12.5-kHz offset and a blocking performance of 91 dB at a 10-MHz offset with the combination of an excellent receiver sensitivity of -123 dBm at 1.2 kbps. In transmit mode the CC1125 transceiver converts the wM-Bus data packets as per EN13757-4 (created by the code in the MSP430F5438A), into an RF signal and passes this RF signal to the antenna. In receive mode, the CC1125 receives the RF signal from the antenna detects the bit stream and converts the bits into data bytes, which are passed to the MSP430F5438A over SPI for further wM-Bus protocol processing. 图 2 shows the functional block diagram of the CC125 transceiver.

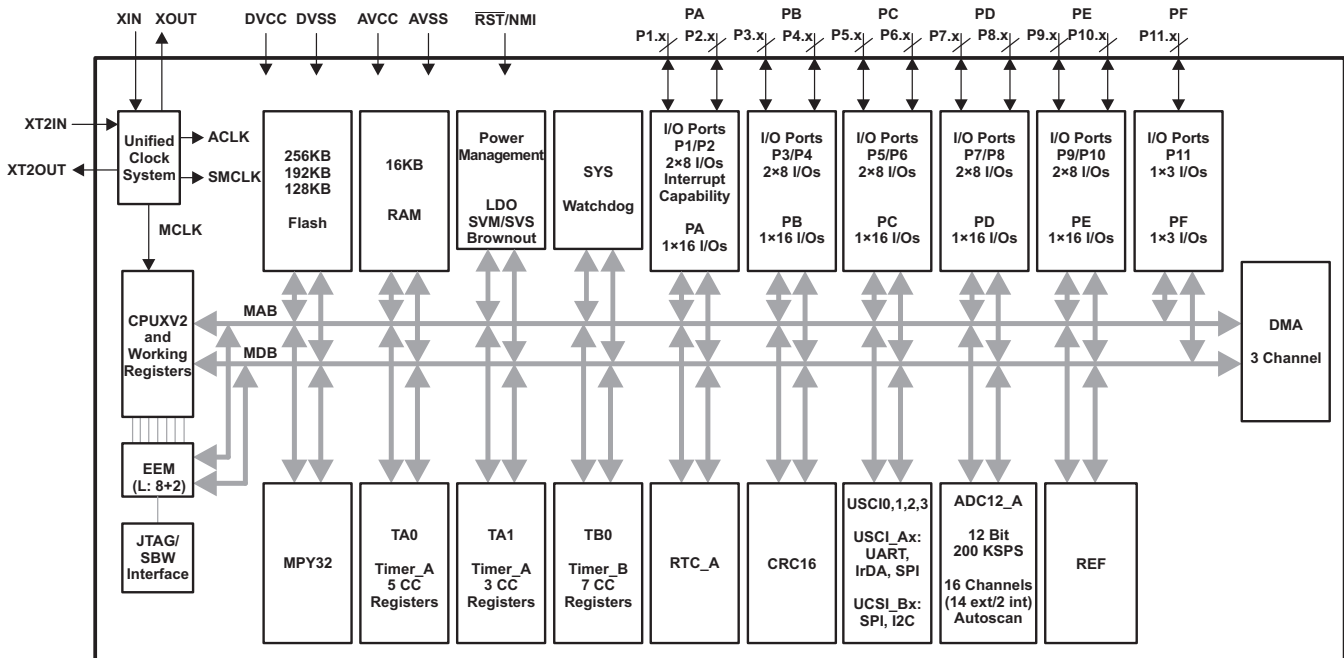

图 2. CC1125 Functional Block Diagram

2.3 TPS62745—Dual-Cell Ultra-Low IQ Step Down Converter for Low Power Wireless Applications

The TPS62745 devices are a step down converter family typically featuring a 400-nA quiescent current and operating with a tiny 4.7- μ H inductor and a 10- μ F output capacitor. These DCS-Control™ based devices extend the light load efficiency range below 10- μ A load currents. The TPS62745 converter supports output currents up to 300 mA. 图 3 shows a block diagram of the TPS62745 device.

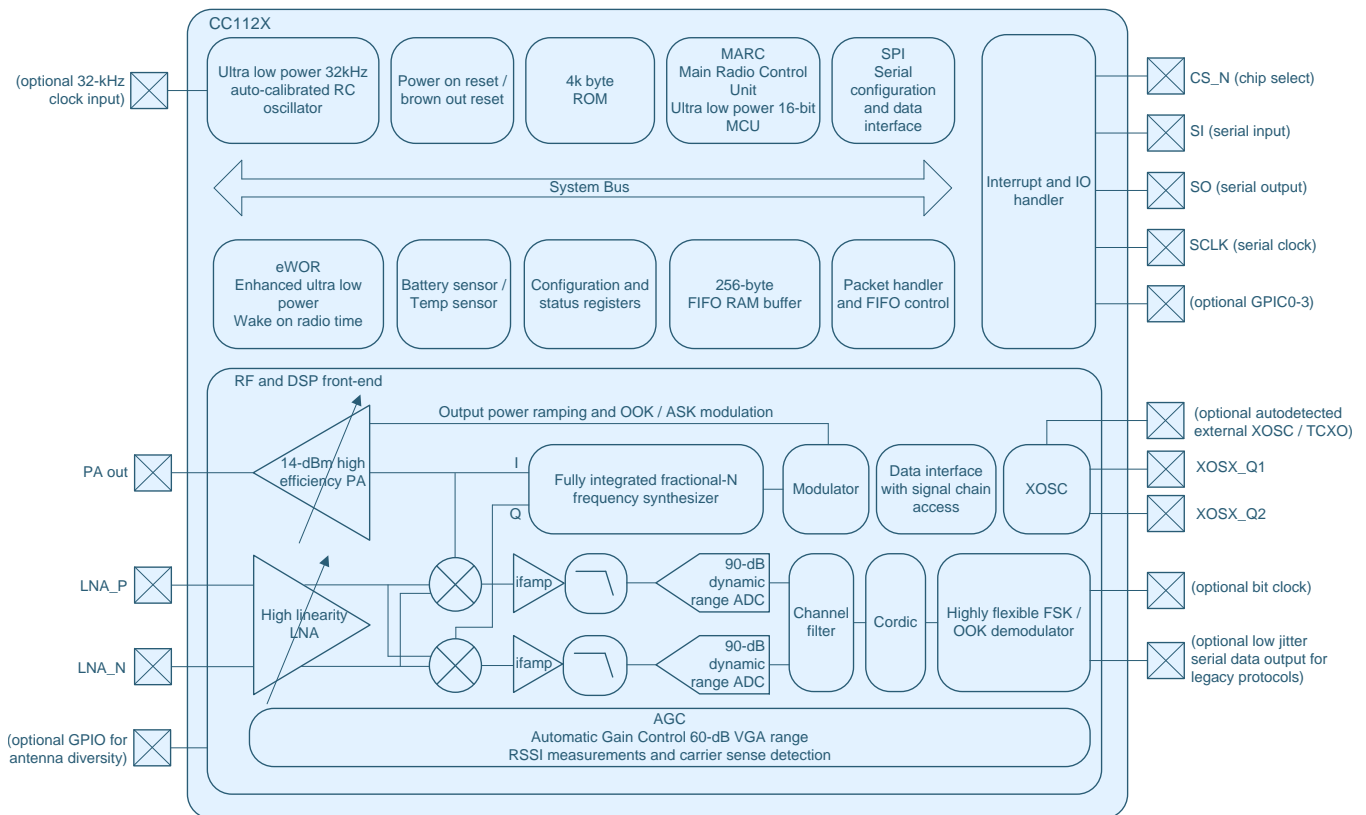

图 3. TPS62745 Block Diagram

3 Block Diagram

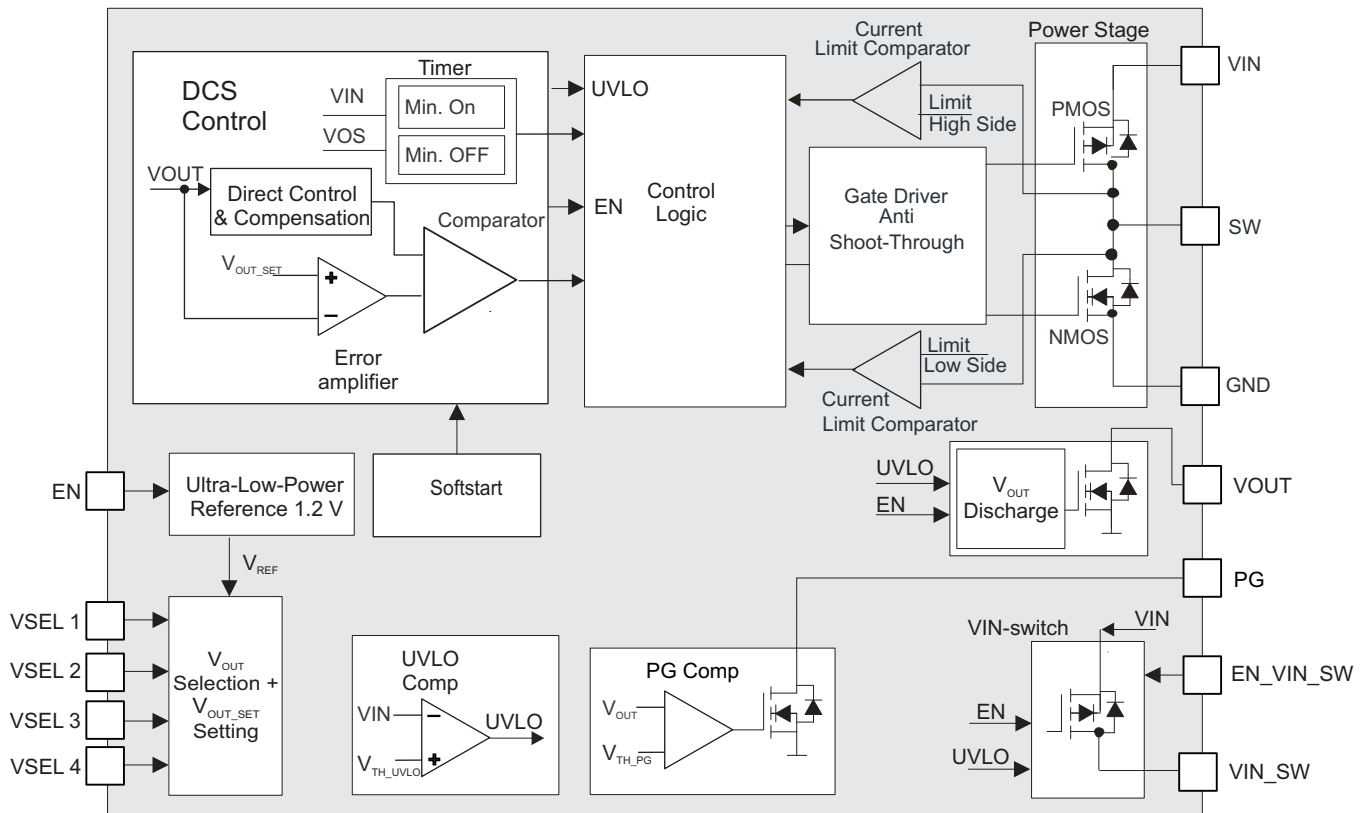

图 4. TIDC-DSSS868WMBUS-DC Block Diagram

3.1 Highlighted Products

There are three key devices in this application:

- An ultra-low power MCU MSP430F5438A
- A high-performance transceiver CC1125
- An ultra-low quiescent, current step-down converter TPS62745 with an adjustable output voltage

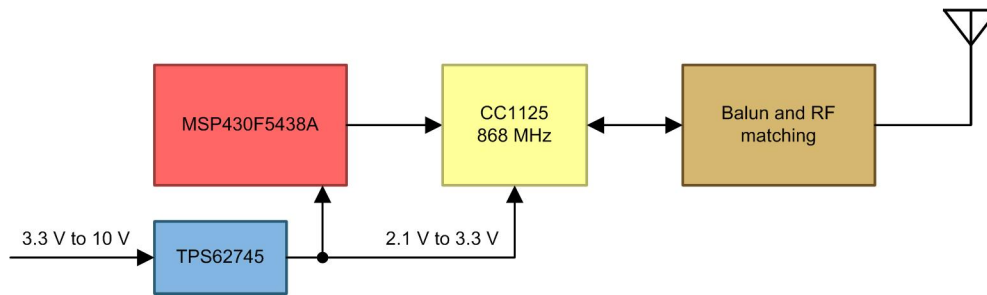
3.1.1 MSP430F5438A

The MSP430F5438A is a general purpose ultra-low-power MCU that offers multiple serial communications interfaces, combined with a reasonable amount of FLASH and RAM resources. The digitally-controlled oscillator (DCO) allows the device to wake up from low-power modes to active mode in 3.5 μ s (typical).

3.1.2 CC1125

The CC1125 device is a fully integrated single-chip radio transceiver designed for high performance at very low-power and low-voltage operation in wM-Bus enabled wireless systems. All filters are integrated, which removes the need for a costly external IF filter. The device supports the ISM (industrial, scientific, and medical) and SRD (short-range device) frequency bands at 164 MHz to 192 MHz, 274 MHz to 320 MHz, 410 MHz to 480 MHz, and 820 MHz to 960 MHz. The CC1125 transceiver is compatible with the M-Bus standard; defined in the 169-, 433-, and 868-MHz sub-bands; and is a perfect solution for receiving T-Mode packets at 100 kcps as in the EN13757-4 standard [5].

The separate 128-Byte FIFOs in TX and RX direction inside the CC1125 transceiver enable an easy processing of the wM-Bus packets and sufficient time for handling the data bytes over SPI, avoiding FIFO overflow or underflow conditions while transmitting or receiving data over the air. The Manchester hardware encoder and decoder process the S-mode or T2-mode (data collector to meter) data packets automatically, which eliminates the need of Manchester coding and decoding in the software. The main operating parameters of the CC1125 device are controlled through a set of registers. An SPI directly connected to the MSP430F5438A writes or read outs the main operating parameters through this set of registers.

3.1.3 TPS62745

The TPS62745 is the first dual-cell, ultra-low power step down converter combining TI's DCS-Control™ topology and ultra-low quiescent current consumption (400 nA typical) while maintaining a regulated output voltage. The device extends high efficiency operation to output currents down to a few micro amperes. The TPS62745 does not require an external resistor divider network to program the output voltage. The device integrates a high impedance (typical 50-M Ω) feedback resistor divider network which is programmed by the pins VSEL1-4. TPS62745 supports an output voltage range of 1.8 V to 3.3 V in 100-mV steps. The output voltage can be changed during operation and supports simple dynamic output voltage scaling.

There is an internal switch that connects the input voltage applied at the VIN pin to the VIN_SW output. The switch can be used to connect an external voltage divider for an ADC monitoring the input voltage (for example, from the battery pack). An enable pin EN_VIN_SW turns the switch on and off, making sure there is no current through that external voltage divider when not required. A logic high level on EN_VIN_SW turns the switch on once the input voltage is above the undervoltage lockout threshold and the device is enabled.

4 System Design Theory

The TrxEB main board with the MSP430F5438A MCU runs the data collector firmware for wM-Bus and spread spectrum-coded data packets. The CC1125 transceiver is in continuous receive mode, searching for two different valid SYNC words that precede either a T-Mode or a spread spectrum-coded data packet. T-Mode and C-Mode-enabled transmitter units periodically transmit T-Mode packets and a spread spectrum-Mode transmitter device periodically sends out spread spectrum-coded packets, both on 868.95 MHz.

This example code can be used for further modifications and improvements because the focus of the code development has been to implement the correct reception for the wM-Bus protocol T- and C-Modes physical layer and in parallel to the spread spectrum packet reception. All three types of data packets can be received and decoded simultaneously at the data collector.

A data collector or mobile reader unit continuously searches for a valid SYNC word. After finding a match, the firmware checks which type of packet it is. Afterward, the packet is received and the proper decoding (wM-Bus or spread spectrum) of the data packet is done. Both T- and C-Mode wM-Bus packets are decoded and only a full packet with a cyclic redundancy check (CRC) checked as correct increments the packet counter shown on the LCD.

If a “3-of-6” decoding error is found, or if the CRC16 field is not equal to the calculated CRC16 by the firmware, then the respective error counter (either for coding errors or for CRC errors) is incremented and updated on the LCD.

The C-Mode uses two counters that count either the correct packets or CRC16 errors, as the data is non-return-to-zero (NRZ) coded.

Spread spectrum-Mode also implements two counters: either for correctly decoded Spread spectrum packets (CRC16 field was correct) or for packets with CRC16 errors.

The software code examples are based on the TI-released code from the AN067 Application Note [4] and the CC1125 code examples in [17].

5 Getting Started Hardware

The hardware kit comprises two boards:

- Two TrxEB from CC1125DK [10]
- Two CC1125EM-868-915-RD RF modules with a 40-MHz XTAL

All measurements are conducted at room temperature. 图 12 shows the packet error rate (PER) plot that was created using an automated test RF system with a signal generator at room temperature.

5.1 Setting Up HW System

The external power transfers either through the USB cable from a PC to the TrxEB, or through the bench power supply connected to the TPS62745EVM board with jumpers set for an output voltage of 2.7 V.



图 5. TIDC-DSSS868WMBUS-DC



6 Getting Started Firmware

The provided software code example is open source and was developed for the IAR Embedded Workbench MSP430 tool chain. The source code implements receiver functionality only for both T- and C-Mode compliant data packets and for a spread spectrum-coded proprietary communication link with an 11-bit spreading sequence. Additionally, the CC1125 device also offers a 16-bit spreading capability [3], which can deliver even higher link budget gain.

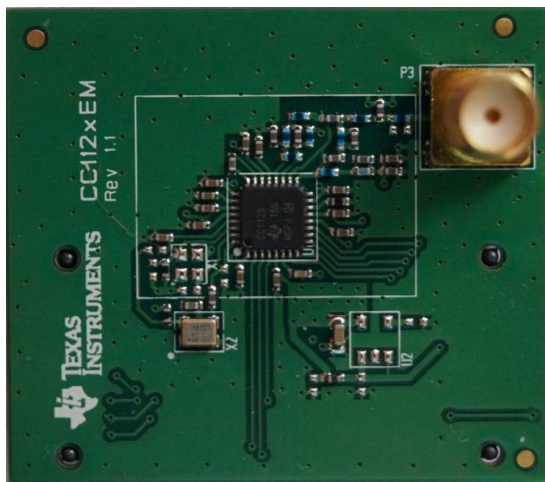
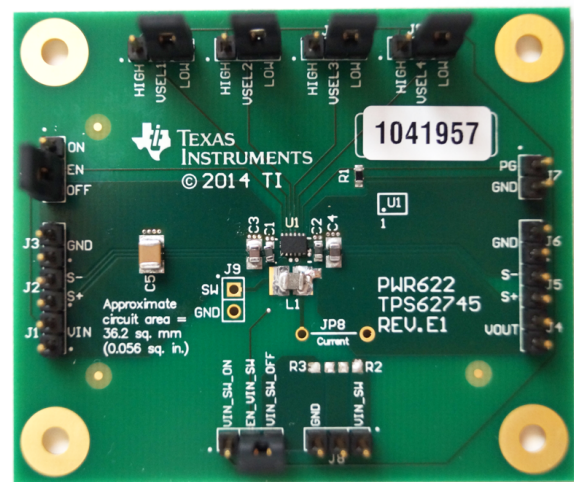
The code project can be compiled and downloaded into the TrxEB board using a flash emulation tool (MSP-FET) and IAR for MSP430 version 6.30 or later (a full IAR Workbench license for the MSP430 is required).

6.1 wM-Bus Data Packets

The code supports regular wM-Bus data packets, which are transmittable by any means, such as off-the-shelf wM-Bus enabled metering devices. For the sake of simplicity, use the example in the EN13757-4 document [5] (the DIN EN number is 13757-4:2014-02) and the TIDC-Multiband-WMBUS [16] hardware as a transmitting device. The data packets in T-Mode use the legacy Format A, with multiple CRC16 fields in between each 16 data bytes and after the first data block of 9 bytes (excluding the L-field, which is always the first byte of any wM-Bus packet).

The C-Mode packets use the newer packet Format B, which reduces the CRC16 field to a maximum of two per packet, minimizing the number of overhead bytes. In addition, NRZ coding is used, which further reduces the number of bytes transmitted over the air.

Format B offers a few important improvements over Format A:

1. Shorter transmission times (so that less energy drains from the battery for each transmission and reception)
2. Reduced probability of RF interference that can disturb the reception of a data packet (due to shorter time over the air)
3. Higher data throughput due to the use of NRZ coding (no more "3-of-6" coding or Manchester coding)
4. L-field also includes the CRC16 bytes, which simplifies the decoding of received packets (as the CC1125 packet engine can detect the packet length)

注: The maximum packet length when using the "fixed length" format for the CC1125's packet engine is 256 bytes, which is sufficient for most T-Mode and C-Mode data packets. The longer the data packet is the higher is the probability of interference, causing a complete packet loss due to bit errors.

6.1.1 T-Mode Packet Format—Data Format (Source EN13757-4)

表 1. Byte Content of Example wM-Bus T-Mode Data Packets (Format A)

Packet T-Mode (Meter to Other, Frame Format A):

0F 44 AE 0C 78 56 34 12 01 07 44 47 78 0B 13 43 65 87 1E 6D (20 bytes)

6.1.2 C-Mode Packet Format—Data Format (Source EN13757-4)

表 2. Byte Content of Example wM-Bus C-Mode Data Packets (Format B)

Packet C2 (Meter to Other, Frame Format B):

14 44 AE 0C 78 56 34 12 01 07 8C 20 27 78 0B 13 43 65 87 7A C5 (21 bytes)

Note for this format that:

1. The manufacturer ID of CEN (0xAE 0C) and the manufacturer number 0x12345678 are highlighted in yellow.
2. The two CRC16 fields for Frame Format A (packet S2) and a single CRC16 field for Format B (packet C2) are highlighted in green.

6.2 Spread Spectrum-Coded Packets

The spread spectrum-coded packets are transmitted at the same frequency as T- or C-Mode meter packets but are much longer, as each bit is coded into one of two 11-bit strings, each representing a “0” or “1”. The following 表 3 lists the format of this packet; a 11-bit spreading sequence is used in this example, but 16-bit spreading is also supported by the CC1125 device.

表 3. Packet Format of Spread Spectrum-Coded Packet

Spread spectrum-coded packet

Preamble: 010101010101010101010101 (not coded → 22 chips or bits of 0x55 preamble)

Header: 0xAAA (spread spectrum-coded → 132 chips)

Sync: 0xDE (spread spectrum-coded → 88 chips)

Payload: 15 bytes (spread spectrum-coded → 1320 chips)

CRC: 2 bytes, same CRC16 format as per the wM-Bus T-Mode (spread spectrum-coded → 176 chips)

This code example uses the Barker code spreading sequence with 11 bits [14] for “1” and its inverted form for “0”.

“1”: 111 0001 0010 (0x0712)

“0”: 000 1110 1101 (0x00ED)

The CC1125 device supports one spread-spectrum encoding implementation in hardware using the “DSSS Repeat mode”, where the preamble bits are left unchanged but the payload data bits are spread using the SYNC word. That process means that the complete SYNC word (either 11-bits or 16-bits of SYNC1 and SYNC0 registers) is sent for every “1” in the payload and the inverted SYNC word is sent for every “0” in the payload. Only the SYNC_CFG0.SYNC_MODE = 1 and 010b are supported (11 or 16 bits).

The Spread spectrum-coded packet format used in 表 3 is merely an example to show how spreading works. Users may choose another payload length, a different type, no CRC at all, or another SYNC pattern to create a customized spread-spectrum long range solution that utilizes their own 11- or 16-bit spreading sequence.

6.3 SmartRF7 Studio Files

Two configuration files for SmartRF7 have been tested and are provided as a reference; the TIDC-DSSS868WMBUS-DC board is mounted onto a TrxEB board, which is connected to a Microsoft® Windows® PC running TI’s SmartRF7™ Studio (SRF7) software [11]. The required wM-Bus mode (T- or C-Mode) configuration file is loaded into SRF7 and the SRF7 studio GUI starts the Packet TX.

6.4 Data Collector Source Code Example for Spread Spectrum and T-Mode

The code example for the data collector function uses the dual-sync feature of the CC1125 device, where two different 16-bit SYNC words are preprogrammed and simultaneously detectable. The Firmware remains in continuous receive mode, trying to detect either spread spectrum-coded or wM-Bus T-Mode (or C-Mode) packets. Whenever such a packet is detected (indicating that a valid 16-bit SYNC word pattern was found), then the firmware checks which of the SYNC words it is.

The name of the IAR project (see 图 7) is “DSSS Mode and T-Mode” (with or without the timeout of the one-minute receive operation).



图 7. IAR Project for Data Collector Firmware

Based on the wM-Bus definition for T-Mode (with C-Mode as a special sub-case), SYNC3 and SYNC2 are programmed with the SYNC word **0x543D** (6-bit preamble and a 10-bit sync) in T-Mode.

The CC1125 device registers SYNC1 and SYNC0 contain the SYNC word **0xAF12** for detecting DSSS-coded packets (see 表 3). This 2-byte SYNC word consists of the five least significant bits (LSBs) of the preamble (0x55) and the 11-bits (after spreading) of the first bit (which is “1”) of the header (0xAAA), which equals 0xAF12. See the yellow-highlighted 16 bits in 表 4.

表 4. DSSS-Coded Data Packets (16-Bit SYNC Word)

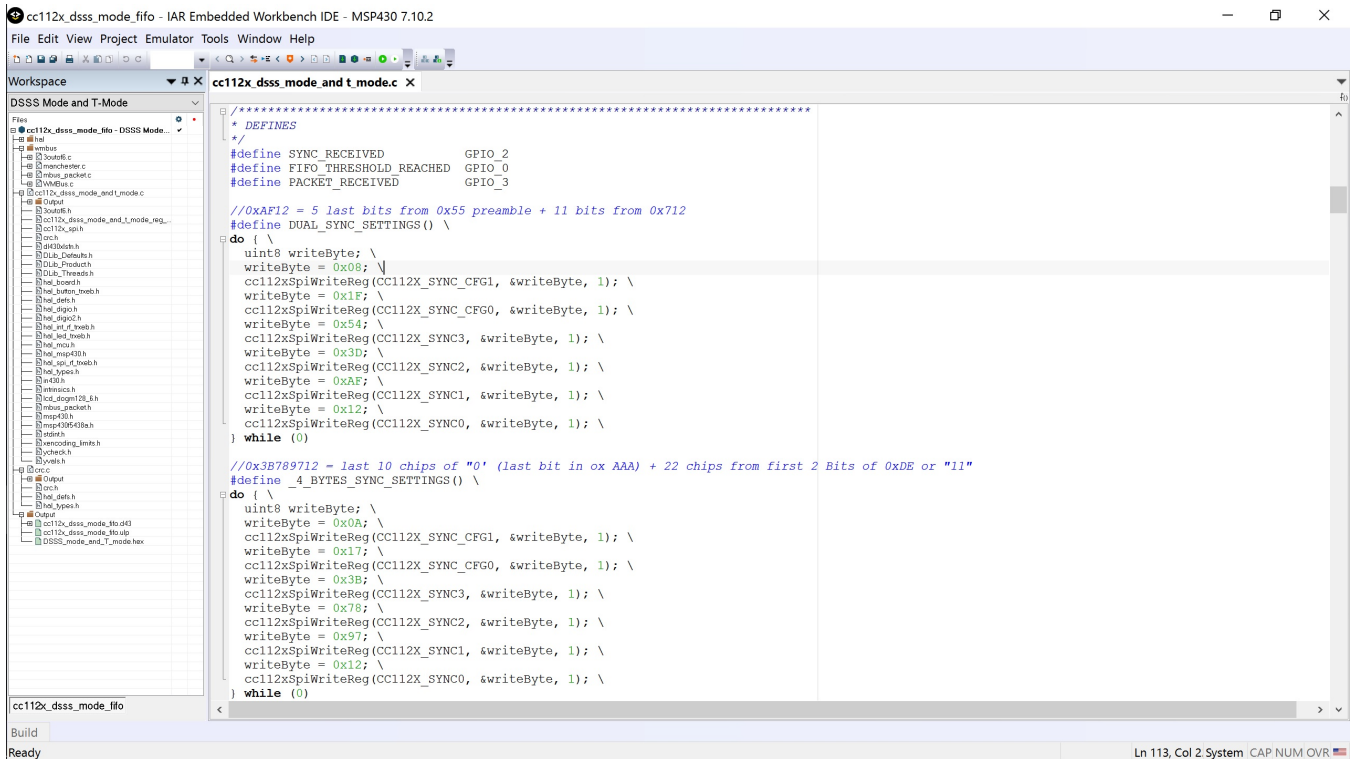
Preamble	4 MSB of 0xAAA Header = 0x1010				
01010101010101010	5 last preamble bits + DSSS coded first bit "1" of the 0xAAA header	11100010010	0001101101	11100010010	0001101101

6.4.1 T-Mode and C-Mode Receive Operation

When a SYNC word is received, the MCU processes a SYNC received interrupt and checks whether the T-Mode or DSSS SYNC word has been found.

In the T-Mode case, the first 3 bytes of the RX FIFO are read out, because these are equal to two “regular” (after 3-of-6 decoding) data bytes in the T-Mode. The first byte is the L-field and the second byte is the C-field. Alternatively, the T-Mode SYNC word can indicate a C-Mode data packet. In this case, the first byte identifies the received packet as a C-Mode data packet, the second byte codes whether Frame Format A or Frame Format B is used, and the third byte is the length byte (un-coded) for the wM-Bus packet, including all subsequent bytes (also CRC16).

For the T-Mode, the first of the two decoded bytes is the L-field of the wM-Bus packet, which must be converted into a packet length field. This conversion requires adding the number of CRC16 fields and the total number incremented by 1, as the L-field itself is not counted. The next step is reprogramming the RX FIFO is with the calculated packet length field number that shows how many bytes must be received over the air until the packet is complete.

This example implementation assumes that the wM-Bus packets are at a maximum total of 256 bytes, which is approximately 170 bytes of data payload in T-Mode ($256 \times 2 / 3$) and 251 Bytes of payload in C-Mode.

The 170 regular (before 3-of-6 coding) bytes in T-Mode also include the required CRC16 fields such that a 138-byte payload is available (excluding the CRC16). These 138-byte payloads can be sufficient in most applications, even though they are much less than the maximum allowed 256 bytes in T-Mode.

Remember that the probability of packet error is a function of the bit length of the packet, this means that very long packets are subject to complete corruption due to interference causing just a few bit errors.

To reiterate, using data packets that are too long is counterproductive, as the probability of data corruption and complete packet loss due to bit errors increases fast.

6.4.2 Spread Spectrum-Mode Operation

If the detected SYNC word equals **0xAF12** the firmware enters IDLE mode and reconfigures the radio to look for a 4-byte SYNC word, instead. The reason for using a 32-bit SYNC is that it makes the detection more robust, as a 16-bit SYNC word is a short pattern and not an optimal choice when 11-bits (or 11-bits inverted) are transmitted for each payload bit.

The new 4-byte SYNC word is **0x3B789712** and is made up of the last 10 chips in the header (0xAAA) and the first 2 bits (22 chips) of the SYNC word (0xDE) of the DSSS-coded packet. This configuration means that the last bit of the 0xAAA header is “0” and the two most significant bits (MSB) “1” = of the 0xD (= 0x1101) are DSSS-coded using the 11-bit Barker code sequences, as 表 5 highlights in yellow and blue:

表 5. 32-Bit SYNC Pattern for Robust DSSS-Coded Packet Detection

0 0011101101 11100010010 11100010010

After removing these chips, calculate how many remain to be stored in the RX FIFO:

$$88 - 22 + 1320 + 176 = 1562 \text{ chips} \rightarrow 195 \text{ bytes and 2 bits (= chips).}$$

The radio is configured for fixed packet length and the packet length is set to 196 (length in bytes). 图 8 shows the flow chart for the code:



图 8. Flow Chart of main() Function in TIDC-DSSS868WMBUS-DC Firmware

The example firmware is interrupt driven and there are three interrupt functions required for proper packet processing. The first interrupt function serves the RX FIFO threshold interrupt, which occurs as soon as the 100-byte limit has been reached and indicates that 100 bytes are now available in the RX FIFO.

The second interrupt function is handling the packet received interrupt, which happens after the predefined number of bytes has been received. Thus the packet processing can be finished and the SYNC search algorithm starts again (using the Dual SYNC settings) for T-/C-Mode and DSSS packets.

The third interrupt function is much more complex and handles the SYNC received interrupt case.

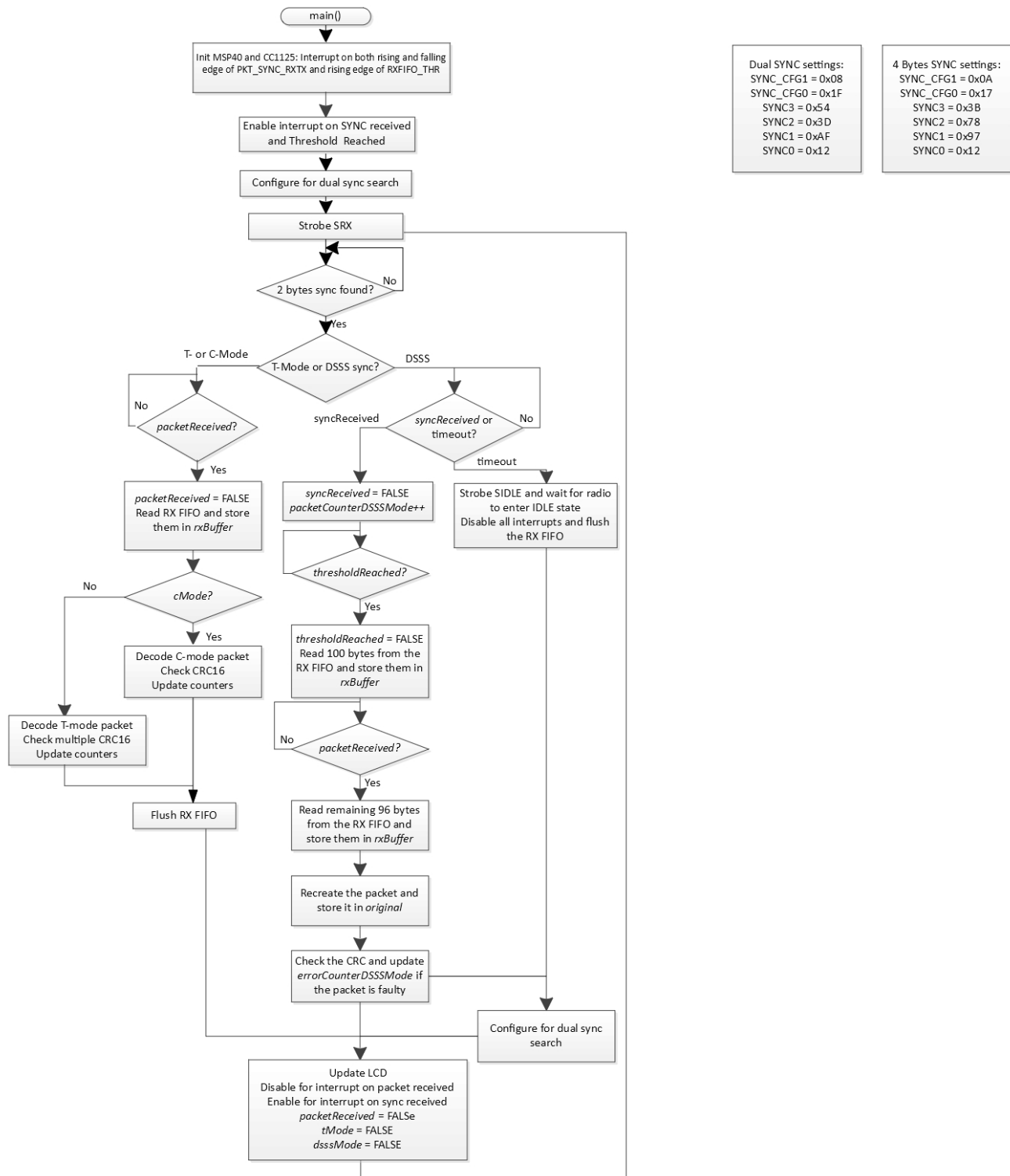
图 9 shows all three Interrupt functions in the following flow chart:



图 9. Flow Chart of Interrupt Functions in TIDC-DSSS868WMBUS-DC Firmware

The function `recreatePacket()` ensures that the chips are partitioned into exactly 142 groups of 11 chips, stored in the array `dataOut` ($1562 / 11 = 142$).

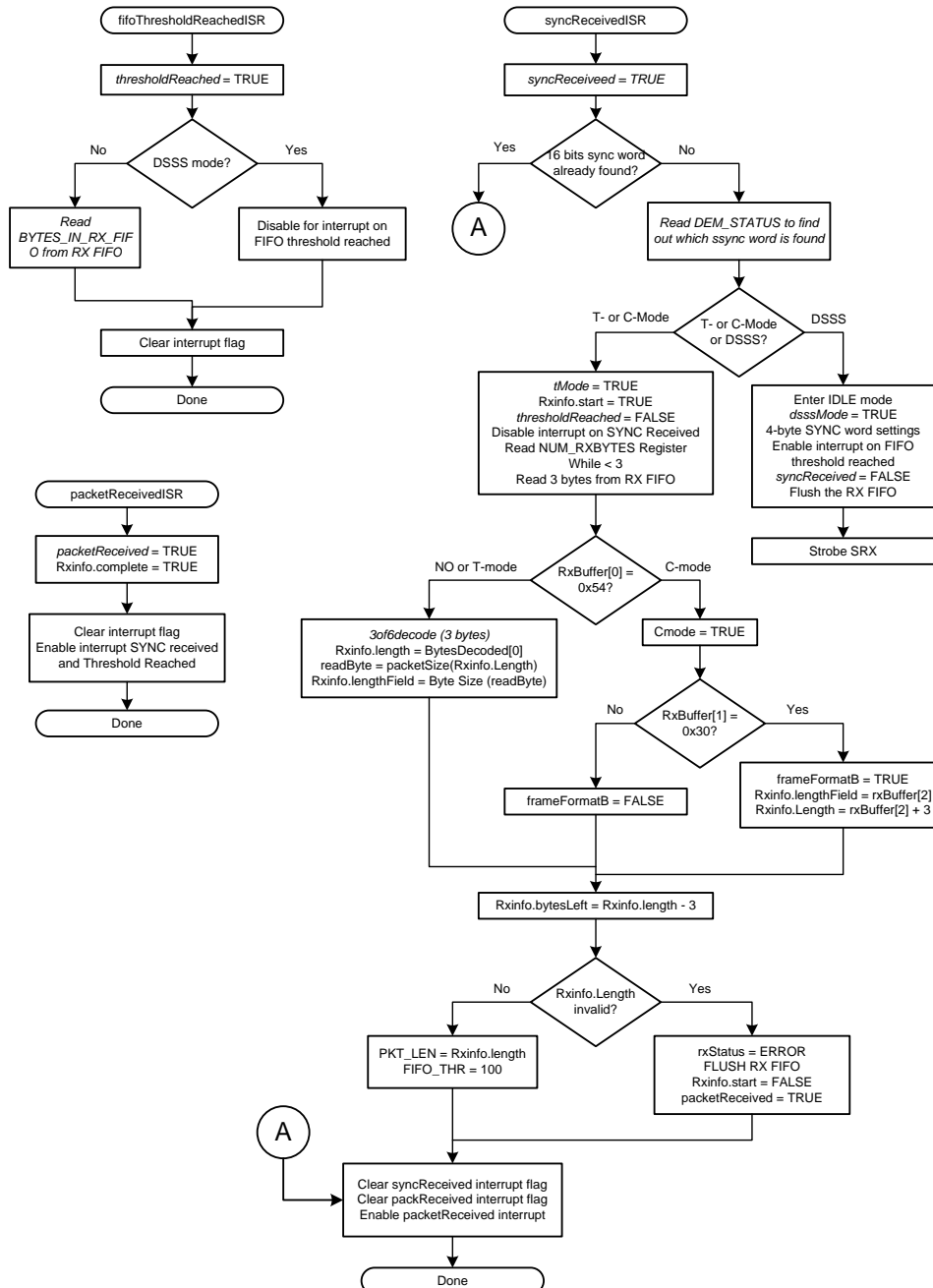

图 10. DataOut[] Buffer Filled Up With 11-Bit Spreading Sequence

For each entry in the `dataOut` array the 11 LSB are compared to `0x00ED`, which represents “0”. If there are five or less chips that match the `0x00ED` string, the chips are interpreted as a “1”, otherwise as a “0”.

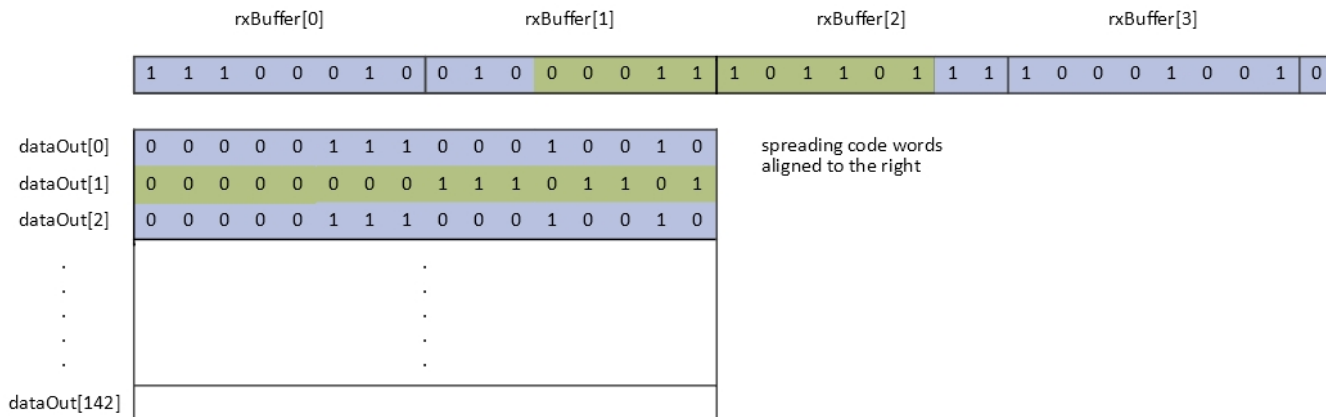

图 11. DataOut[] Buffer Converted into “0” or “1” for all 142 Groups

The final step is recreating the original packet and storing it in the original data buffer.

`Original` has 20 entries and contains the Header, SYNC, payload, and CRC field (or 19.5 bytes in total).

`original[0]` = `0xAA`: This data is not received as this is on the air while the radio is being reconfigured for the 4-byte SYNC search pattern. The SYNC word is the last 10 chips in the header (`0xAAA`) and the first 2 bits (22 chips) of the SYNC word (`0xDE`), which means:

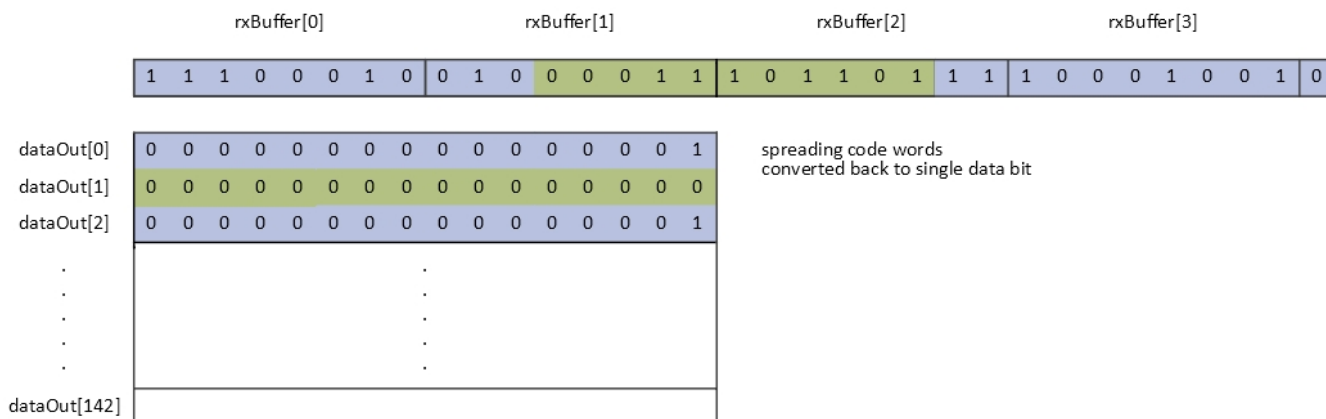
$$original[1] = 0xDE | (dataOut[0] \ll 1 | (dataOut[1] \ll 0));$$

7 Test Data

表 6 summarizes the test conditions used for T-Mode performance testing:

表 6. T-Mode Test Conditions

PARAMETERS	VALUES
TX/RX center frequency [MHz]	868.95
Modulation	2-FSK
Frequency deviation [KHz]	±50 (min.±40 ; max. ±80)
Chip rate [kcps]	100 ±12% (min. 88 kcps or max. 112 kcps)
RX filter bandwidth [KHz]	250

The test is conducted in an automated environment where the same numbers of data packets are transmitted at different signal levels. The test steps through the frequency offset values and counts the correctly received packets (CRC is correct) (see 表 7).

表 7. T-Mode RX Sensitivity Numbers for CC1125 at 20% PER and 10-Byte Payload

FREQUENCY [MHz]	TYPICAL SENSITIVITY [dBm]	PER	P = PAYLOAD BYTES	PARAMETER IN EN13757-4
868.95	-104	20	10	100 kcps, 50-kHz deviation
	-104.25	20	10	Max deviation = 80 KHz
	-102.75	20	10	Min deviation = 40 KHz
	-102.50	20	10	Max. data rate = 112 kcps
	-104.25	20	10	Min. data rate = 88 kcps

The sensitivity numbers that 表 7 show correspond to the CC1125 device numbers for the T-Mode published in the AN121 Application Note [7]. 表 7 shows 20% PER with 10-byte packet length compared to 80% PER and 20-byte packet length in [7].

7.1 Battery Power

The TrxEB and the TIDC-DSSS868WMBUS-DC board were connected to the TPS62745-EVM, which was powered by two lithium manganese dioxide (LiMnO₂) batteries of type FDK CR17450E-R(3V). These batteries are AA-sized with a 2400-mAh capacity each in series, resulting in a 6-V input voltage. The output voltage was adjusted to 3.0 V and 2.7 V to document the TPS62745 performance.

The TrxEB board operates between 2.7 V and 3.6 V; 表 8 lists the current values measured at $V_{OUT} = 3.0\text{ V}$ and $V_{OUT} = 2.7\text{ V}$ in the battery configuration 2s1p.

表 8. Battery Current I_{BAT} for Full System (Including LCD and Other Components)

V_{IN} (SUPPLY VOLTAGE) [V]	INPUT CURRENT [mA]	V_{OUT} from TPS62745 = 3.0 V [mA]; CURRENT [mA]	V_{OUT} from TPS62745 = 2.7 V; CURRENT [mA]
2.7	41.8	—	—
2.9	42.8	—	—
3	43	—	—
3.1	43.6	—	—
3.3	43.8	—	—
3.5	44.3	—	—
3.7	—	—	—
5.1	—	28.1	26.4
5.3	—	27	25.5
5.5	—	26.1	24.5
5.7	—	25.2	23.8
5.9	—	24.4	23
6.1	—	23.8	22.3
6.3	—	23	21.6

The MSP430F5438A and the CC1125 devices can operate down to 2.1 V, but as other components on the TrxEB do not, 2.7 V is the minimum possible system supply voltage.

TPS62745 offers up to 90% efficiency and provides output currents up to 300 mA and thus can supply an additional external power amplifier. This addition is required for application in the 250-kHz ISM sub-band centered around 869.535 MHz. For this sub-band 500 mW (or +27 dBm) with 10% duty cycle are allowed, which led to the definition of the wM-Bus C2-other mode from the data collector to the meters at 869.525 MHz.

The TPS62745 device at a 3.3-V V_{OUT} and 300-mA output current is equal to 990 mW of output power. Assuming a 60% efficient PA device at 869MHz, the current required to achieve 500 mW of net output power is:

$$500\text{ mW} / 3.3\text{ V} = 152\text{ mA}$$

$$152\text{ mA} / 0.60 = 252\text{ mA (input current to the PA with 60% efficiency)}$$

The 252 mA for the PA still leaves a 48-mA current budget for the rest of the data collector system, which is sufficient to supply both MSP430 and CC1125 devices along with an LCD (see 表 8).

7.2 T-Mode Reception Performance at 100 kcps

By automatically running hundreds of thousands of packet transmissions, a complex PER plot is created using a color coding scheme for the PER levels. The PER plot is showing the combination of frequency offset variation and the different input signal levels and is sometimes referred to as a “bathtub” plot (see 图 12).

The input signal level is varied from below the RX sensitivity limit starting at -110 dBm up to very strong signals with a -20-dBm level. The user must consider the importance of using a single optimized register setting that covers the full range of input level and frequency offset variations, because the input level and the frequency offset of the next data packet are unknown.

The data collector unit does not know the specific data packet it is to receive and with what signal level – so having a single optimized register set of values is mandatory. The PER plot in 图 12 shows levels of up to -20 dBm, which correspond to around 2 m to 3 m of distance at 868 MHz, assuming a +10-dBm transmit power (radiated) for the meter device. This distance is easy to guarantee in a field deployment, placing devices in the apartments with a data collector unit sitting outside gathering data from multiple apartments. Another key requirement for T-Mode [5] is the frequency offset tolerance of ± 60 ppm in the data collector device (or similar device). To achieve this frequency offset balance, enable the “Feedback-to-PLL” feature of the CC1125 device by setting the register to `FREQOFF_CFG=0x31`.

图 12 shows that for any frequency offset of ± 66 ppm between the meter and data collector devices (and any input signal level from -110 dBm to -20 dBm) there is a 0% PER loss, as the “white” area indicates. The few “pink” coded squares indicate an error of 1 packet out of 100 transmitted, which is still an excellent result.



图 12. T-Mode Receive Operation With CC1125 With 10-Byte Payload, 100 kcps, 2-FSK, and Frequency = 868.95 MHz

7.3 Recommended Register Settings for T-Mode

The following CC1125 registers were used for the PER plot measurements:

表 9. CC1125 Register Values for T-Mode Receive With 40-MHz XTAL

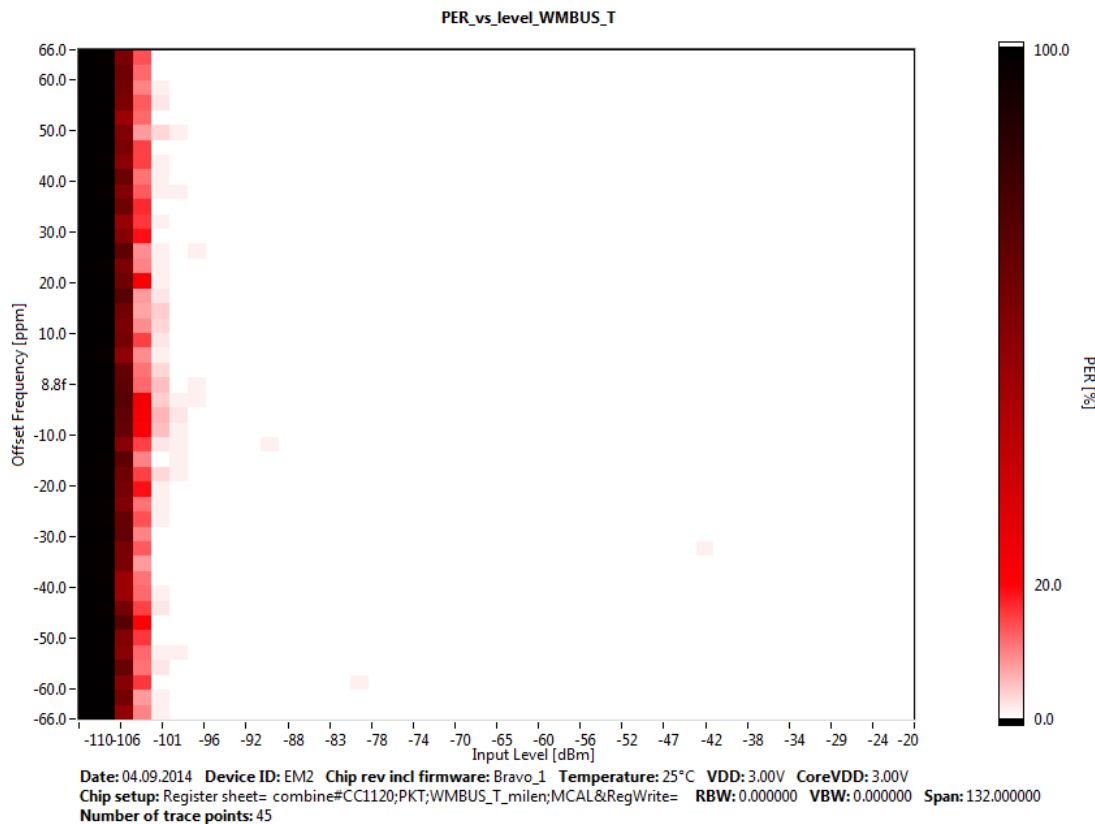
VALUE	REGISTER
0	SYNC3
55	SYNC2
54	SYNC1
3D	SYNC0
9	SYNC_CFG1
B	SYNC_CFG0
DE	DEVIATION_M
E	MODCFG_DEV_E
C	DCFILT_CFG
19	PREAMBLE_CFG1
17	PREAMBLE_CFG0
0	FREQ_IF_CFG
0	IQIC
1	CHAN_BW
C6	MDMCFG1
5	MDMCFG0
A4	DRATE2
7A	DRATE1
E1	DRATE0
40	AGC_REF
FD	AGC_CS_THR
0	AGC_GAIN_ADJUST
3	AGC_CFG3
20	AGC_CFG2
A9	AGC_CFG1
C0	AGC_CFG0
7F	PA_CFG2
56	PA_CFG1
78	PA_CFG0
0	IF_MIX_CFG
31	FREQOFF_CFG
CB	TOC_CFG
0	SOFT_TX_DATA_CFG
12	FS_CFG
3	LNA
3	SETTLING_CFG

7.4 Comparison Between T-Mode and Spread Spectrum-Coded Packets

Using a modified test firmware, a comparison for Spread spectrum-coded Mode and T-Mode has been done. For the plot in [图 13](#) 2000 packets were transmitted for each mode.

In the comparison, a 20-byte payload with an additional CRC16 was used (field attached at the end). This CRC16 field is in the native format of the CC1125 allowing auto-checking by the CC1125 in receive mode to enable PER calculations. The DSSS-coded data packet was 15.5 bytes long, which is less than the 20 bytes in addition to CRC16 in T-Mode.

The DSSS-coded data packet was generated by a signal generator. Even though the T-Mode packets were several bytes longer the effect is obvious; spread spectrum-coded packets add around 4 dB to the RF link budget, which is a nice improvement in range at the expense of much lower effective data throughput. Note that in theory adding 6 dB to the RF link budget means doubling the achievable RF link range.



图 13. RX Sensitivity Comparison for DSSS-coded Mode With 15.5 Bytes versus wM-Bus T-Mode With 20 Bytes

8 Summary

Using a proprietary spread spectrum coding algorithm with an 11- or 16-bit spreading sequence adds up approximately 4dB to the RF link budget. This increase is significant and can help increase the achievable range in real world wireless applications. Due to European regulation, the transmit power in T-/C-Mode (meter to other) is limited to +25 mW at 868.95 MHz. Spread spectrum-coded data packets with the same transmit power achieve significantly improved range but with much less data throughput. The CC1125 device is an excellent device for such an application because it supports DSSS spreading in hardware and delivers a market-leading T-Mode performance at 100 kcps with a $\pm 12\%$ data rate variation.

The TIDC-DSSS868WMBUS-DC design guide presents an example software solution for a data collector unit. The data collector firmware allows simultaneous operation of both T- and C-Mode as well as proprietary packets for increased range.

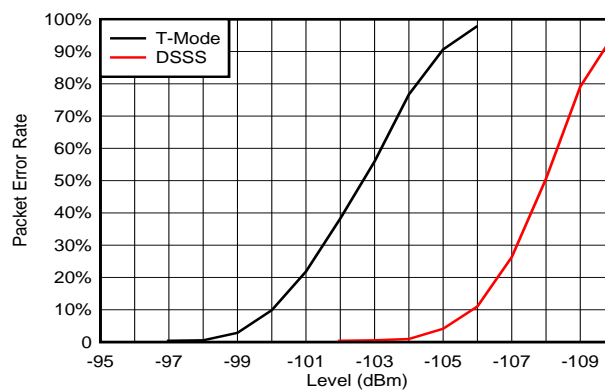
9 Design Files

9.1 Schematics

To download the schematics, see the design files at [TIDC-DSSS868WMBUS-DC](https://www.ti.com/tool/TIDC-DSSS868WMBUS-DC).

L1 is a Bead to be mounted if the regulator U2 is not mounted,
 CC1120 ref des will default not use regulator,
 CC1120/CC1125: do not mount: U2, C12, C41, C53
 TG5021CG is optional: do not mount L1 if regulator is mounted



图 14. TIDC-DSSS868WMBUS-DC Schematic

9.2 Bill of Materials

To download the bill of materials (BOM), see the design files at [TIDC-DSSS868WMBUS-DC](#).

9.3 PCB Layout Recommendations

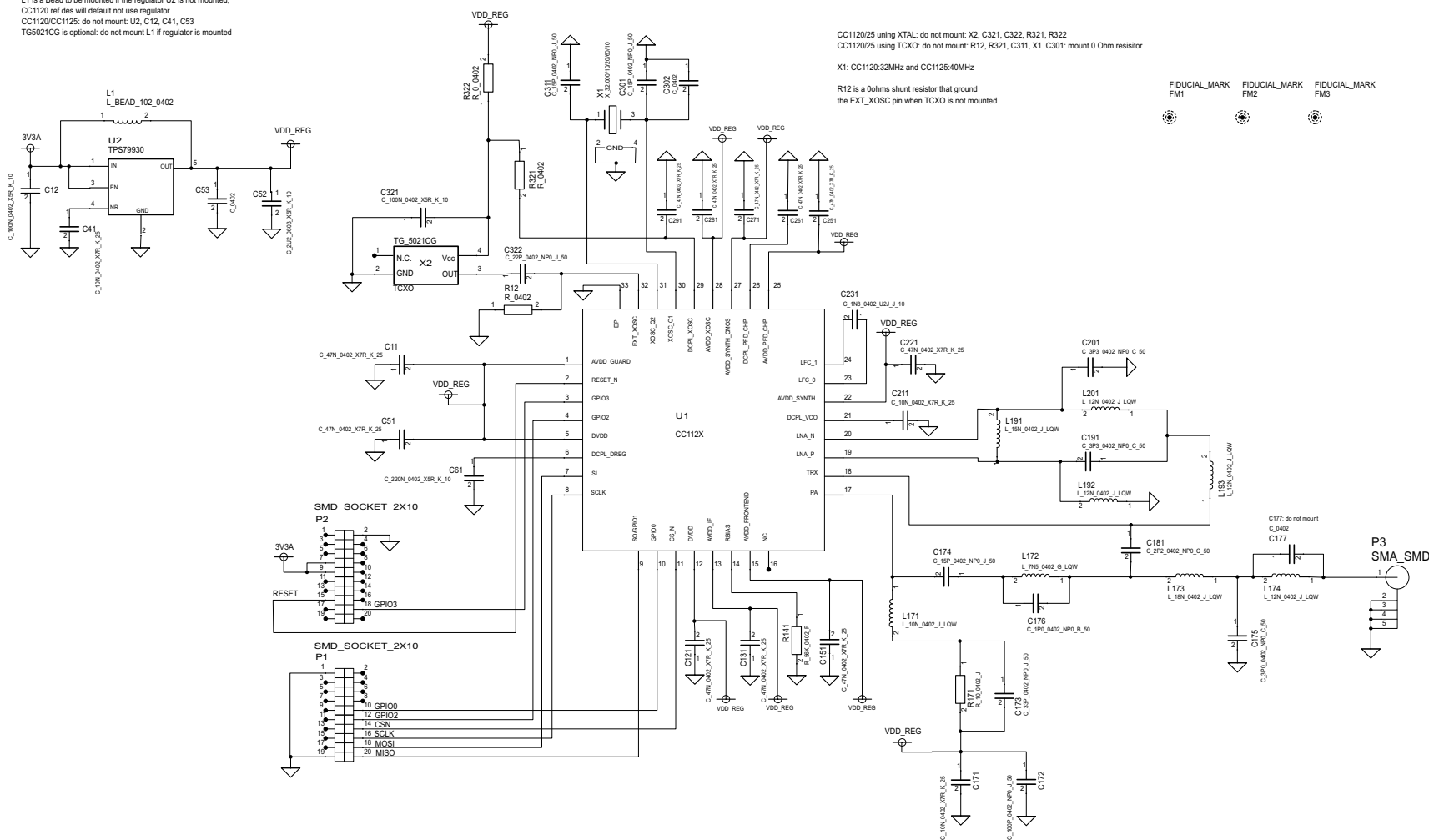
Copy the four-layer PCB layout exactly as shown in the Gerber files, as it has been optimized for the best RF performance.

9.3.1 Layout Prints

To download the layout prints, see the design files at: www.ti.com/tool/CC1125EM-868-915-RD.

9.4 Gerber Files

To download the Gerber files, see the design files at [TIDC-DSSS868WMBUS-DC](#).

10 Software Files

To download the software files, see the design files at [TIDC-DSSS868WMBUS-DC](#).

11 Related Documentation

1. Texas Instruments, [Mixed Signal Microcontroller](#), MSP430F5438A Data Sheet (SLAS655)
2. Texas Instruments, [CC1125 Ultra-High Performance RF Narrowband Transceiver](#), CC1125 Data Sheet (SWRS120)
3. Texas Instruments, [CC112X/CC1175 Low - Power High Performance Sub - 1 GHz RF Transceiver s /Transmitter](#), CC112x/CC1175 User's Guide (SWRU295)
4. Texas Instruments, [Wireless M-BUS Implementation with CC1101 and MSP430](#), AN067 Application Note (SWRA234)
5. Beuth.de, [Communication systems for meters and remote reading of meters - Part 4: Wireless meter readout \(Radio meter reading for operation in SRD bands\)](#), Document Standard DIN EN 13757-4:2013 (<http://bit.ly/1Qrx40x>)
6. Texas Instruments, [CC1125 Operating in 25 kHz Channels at 869 MHz, ETSI Category 1](#), AN122 Application Note (SWRA424)
7. Texas Instruments, [Wireless M-Bus Implementation with CC112x / CC120x High Performance Transceiver Family](#), AN121 Application Note (SWRA423)
8. Texas Instruments, [AN112 - Using the CC1190 Front End With CC112x and CC120x Under EN 300 220](#), AN112 Application Report (SWRA393)
9. ESTI, [ETSI EN 300 220-1 V2.4.1 \(2012-05\) Electromagnetic compatibility and Radio spectrum Matters \(ERM\); Short Range Devices \(SRD\); Radio equipment to be used in the 25 MHz to 1 000 MHz frequency range with power levels ranging up to 500 mW; Part 1: Technical characteristics and test methods](#), ETSI EN 300 220-1 V2.4.1 Standard (<http://bit.ly/1JMqKX2>)
10. Texas Instruments, [CC1125EM 868/915MHz Reference Design](#), CC1125EM-868-915-RD Tool Folder (www.ti.com/tool/CC1125EM-868-915-RD)
11. Texas Instruments, [CC1125 Development Kit](#), CC1125DK Tool Folder (www.ti.com/tool/cc1125dk)
12. Texas Instruments, [SmartRF Studio](#), SmartRF Studio Tool Folder (<http://bit.ly/1FbvZ0Y>)
13. Texas Instruments, [CC1125 Development Kit](#), CC1125DK Tool Folder (www.ti.com/tool/CC1125DK)
14. Texas Instruments, [MSP430 Flash Emulation Tool](#), MSP-FET Tool Folder (www.ti.com/tool/msp-fet)
15. Wikipedia.org, [Barker code](#), Wikipedia.org Entry
16. Texas Instruments, [Multiband \(169, 433 and 868MHz\) wM-Bus RF sub-system with Segmented LCD Reference Design](#), TIDC-MULTIBAND-WMBUS Tool Folder (www.ti.com/tool/TIDC-MULTIBAND-WMBUS)
17. Texas Instruments, [CC112x Software Examples](#), SWRC253 Manifest (SWRC253)

11.1 商标

Microsoft, Windows are registered trademarks of Microsoft Corporation.

12 Terminology

wM-Bus— the European RF Metering standard, providing solutions for 169, 433, and 868-MHz bands

ETSI Category 1 Receiver— definition for most stringent set of RF parameters to be met in EN300 220 v2.4.1

T-Mode— wM-Bus mode at 868.95 MHz, used in the Open Metering System (OMS) specification and thus in many EU countries

C-Mode— “compact” wM-Bus mode at 868.95 MHz, can be used in conjunction with T-Mode (same receiver is able to receive both T- and C-frames)

DSSS-Mode— Direct sequence spread spectrum converts 1 data bit into a sequence of bits (chips) before transmitting; the CC1125 supports 11-bit and 16-bit DSSS coding per the hardware in transmit mode, DSSS decoding in receive operation is done per software (see included code example)

13 About the Author

MILEN STEFANOV is a System Applications engineer at Texas Instruments where he is responsible for Sub-1GHz RF communications solutions in Smart Grid applications. Milen is working on further improving TI's full wM-Bus system solution, consisting of either SoC or MCU + Radio chipset, a complete wM-Bus protocol stack, and a dedicated power management solution.

Milen has a system-level expertise on Smart Metering and RF communications and 16+ years of experience working with customers. He has published several technical articles on wM-Bus-related topics in the past 4 years. He earned his Master of Science in Electrical Engineering (MSEE) from Technical University in Chemnitz, Germany.

修订历史记录 A

注：之前版本的页码可能与当前版本有所不同。

Changes from Original (June 2015) to A Revision	Page
• 已更改 11-bit spreading codeword	12
• 已更改 图 7 to updated image to reflect updated codeword in the firmware.....	13
• 已更改 表 4 to updated information to reflect updated codeword in the firmware.....	13
• 已更改 表 5 to updated information to reflect updated codeword	14
• 已更改 图 8 to updated image to reflect updated codeword	15
• 已更改 图 10 to updated image to reflect updated codeword.....	17
• 已更改 图 11 to updated image to reflect updated codeword.....	17

有关 TI 设计信息和资源的重要通知

德州仪器 (TI) 公司提供的技术、应用或其他设计建议、服务或信息，包括但不限于与评估模块有关的参考设计和材料（总称“TI 资源”），旨在帮助设计人员开发整合了 TI 产品的应用；如果您（个人，或如果是代表贵公司，则为贵公司）以任何方式下载、访问或使用了任何特定的 TI 资源，即表示贵方同意仅为该等目标，按照本通知的条款进行使用。

TI 所提供的 TI 资源，并未扩大或以其他方式修改 TI 对 TI 产品的公开适用的质保及质保免责声明；也未导致 TI 承担任何额外的义务或责任。TI 有权对其 TI 资源进行纠正、增强、改进和其他修改。

您理解并同意，在设计应用时应自行实施独立的分析、评价和判断，且应全权负责并确保应用的安全性，以及您的应用（包括应用中使用的 TI 产品）应符合所有适用的法律法规及其他相关要求。就您的应用声明，您具备制订和实施下列保障措施所需的一切必要专业知识，能够 (1) 预见故障的危险后果，(2) 监视故障及其后果，以及 (3) 降低可能导致危险的故障几率并采取适当措施。您同意，在使用或分发包含 TI 产品的任何应用前，您将彻底测试该等应用和该等应用所用 TI 产品的功能。除特定 TI 资源的公开文档中明确列出的测试外，TI 未进行任何其他测试。

您只有在为开发包含该等 TI 资源所列 TI 产品的应用时，才被授权使用、复制和修改任何相关单项 TI 资源。但并未依据禁止反言原则或其他法律授予您任何 TI 知识产权的任何其他明示或默示的许可，也未授予您 TI 或第三方的任何技术或知识产权的许可，该等产权包括但不限于任何专利权、版权、屏蔽作品权或与使用 TI 产品或服务的任何整合、机器制作、流程相关的其他知识产权。涉及或参考了第三方产品或服务的信息不构成使用此类产品或服务的许可或与其相关的保证或认可。使用 TI 资源可能需要您向第三方获得对该等第三方专利或其他知识产权的许可。

TI 资源系“按原样”提供。TI 兹免除对 TI 资源及其使用作出所有其他明确或默认的保证或陈述，包括但不限于对准确性或完整性、产权保证、无复发故障保证，以及适销性、适合特定用途和不侵犯任何第三方知识产权的任何默认保证。

TI 不负责任何申索，包括但不限于因组合产品所致或与之有关的申索，也不为您辩护或赔偿，即使该等产品组合已列于 TI 资源或其他地方。对因 TI 资源或其使用引起或与之有关的任何实际的、直接的、特殊的、附带的、间接的、惩罚性的、偶发的、从属或惩戒性损害赔偿，不管 TI 是否获悉可能会产生上述损害赔偿，TI 概不负责。

您同意向 TI 及其代表全额赔偿因您不遵守本通知条款和条件而引起的任何损害、费用、损失和/或责任。

本通知适用于 TI 资源。另有其他条款适用于某些类型的材料、TI 产品和服务的使用和采购。这些条款包括但不限于适用于 TI 的半导体产品 (<http://www.ti.com/sc/docs/stdterms.htm>)、[评估模块](http://www.ti.com/sc/docs/sampters.htm)和样品 (<http://www.ti.com/sc/docs/sampters.htm>) 的标准条款。

邮寄地址：上海市浦东新区世纪大道 1568 号中建大厦 32 楼，邮政编码：200122
Copyright © 2017 德州仪器半导体技术（上海）有限公司