

# TI 参考设计: TIDA-01415

# 100W、高分辨率、16 位颜色可调、0.15% 可调光 RGBW LED 驱动器参考设计



## 说明

TIDA-01415 设计适用于舞台灯和建筑灯等应用全彩可调 LED 驱动器。此 TI 参考设计支持三种不同的 LED 电流控制方法，例如模拟、对降压电流控制器进行基于 PWM 的启用和禁用，以及在 LED 之间使用 MOSFET 对 LED 进行基于 PWM 的分流。

此 TI 参考设计演示了精细入微的各个 RGBW LED 灯串颜色控制范围，有助于开发高效的直流/直流 LED 灯具，支持生成数万亿种宽色域颜色，同时无法由高端摄像机和视频广播设备察觉。

## 资源

<a href="#">TIDA-01415</a>	设计文件夹
<a href="#">LM3409</a>	产品文件夹
<a href="#">DAC7564</a>	产品文件夹
<a href="#">UCC27511</a>	产品文件夹
<a href="#">LAUNCHXL-F28027</a>	产品文件夹
<a href="#">CSD19538Q2</a>	产品文件夹
<a href="#">LMR16006</a>	产品文件夹
<a href="#">LM5165</a>	产品文件夹
<a href="#">LP5907</a>	产品文件夹

## 特性

- 由四个降压电流控制器驱动 RGBW LED 灯串，电压为 30V 且灯串电流高达 0.75A（也通过了高达 1.25A 的测试）
- LED 降压电流控制器在满载时的效率超过 96%，且最大工作频率高达 600kHz
- 在 30kHz 和 50kHz 频率下，对于 PWM 调光方法，可实现 100% 至 0.2% 的对比度设置
- 在 30kHz 和 50kHz 频率下，对于分流调光模式，可实现 100% 至 0.15% 的对比度设置和更优的线性度
- 凭借 C2000™ 步长高达 180ps 的高分辨率 PWM 特性，即使在 50kHz 调光频率下，PWM 和分流 FET 方法均可实现分辨率大于 16 位的电流调节
- 使用四通道 12 位 DAC 对各个 LED 灯串进行 I<sub>ADJ</sub> 设置，从而实现模拟调光

## 应用

- 舞台照明
- 室内外 LED 建筑照明
- 洗墙灯
- 适用于教育和医疗保健应用的全彩可调室内灯具

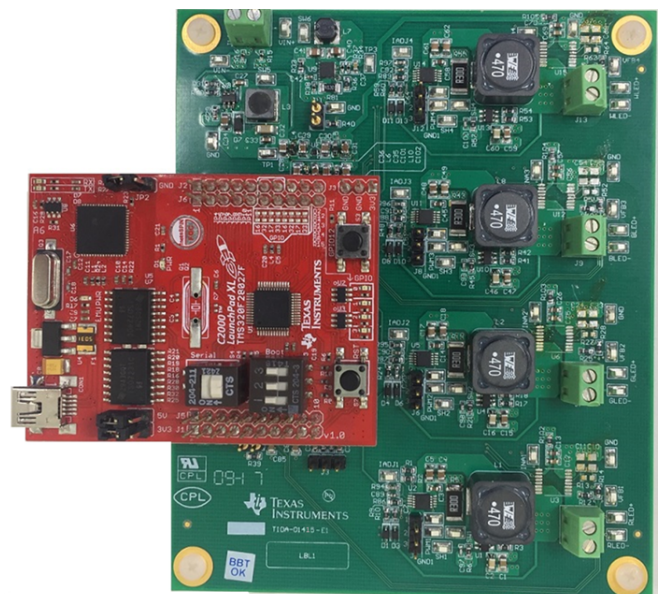
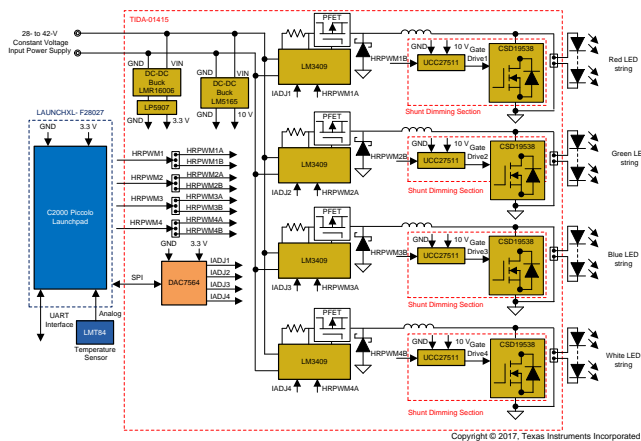
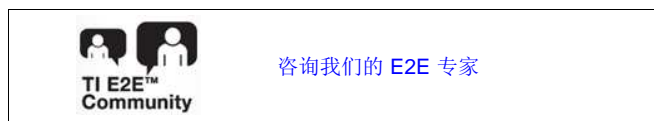



该 TI 参考设计末尾的重要声明表述了授权使用、知识产权问题和其他重要的免责声明和信息。

## 1 System Description

Stage lights have gone far beyond their primary purpose of enhancing visibility for the audience to creating an overall immersive experience. They are increasingly being used to create a certain mood and ambience, which would be conducive in directing the audiences' emotions as desired by the producers. On the other hand, architectural lighting has become extremely popular for lighting up buildings and monuments to enhance their aesthetics. For these purposes, the lights must have a wide color spectrum for creating the precise color as required. These lights must also support a wide range of intensities to give stage lighting and architecture lighting its dramatic look and feel while at the same time the PWM dimming frequency being imperceptible to the high end video equipments to avoid any undesirable video banding during filming. 图 1 shows a typical implementation of the TIDA-01415 design in a stage light emitting diode (LED) lighting application.

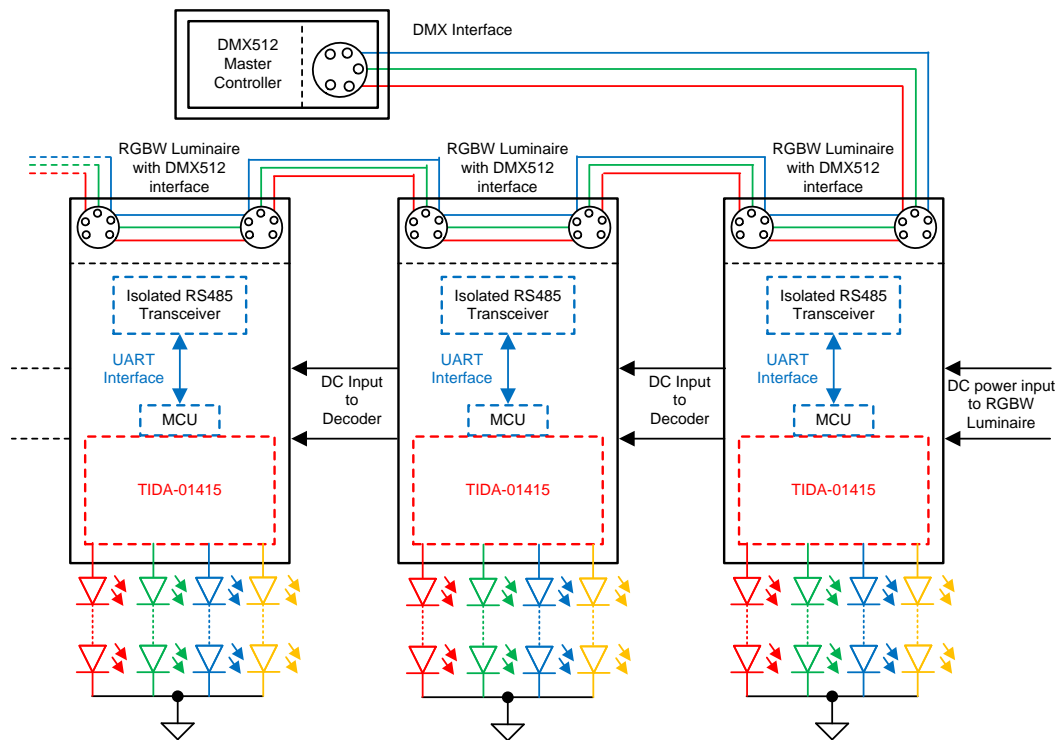

Copyright © 2017, Texas Instruments Incorporated

图 1. TIDA-01415 End Application in Stage Lighting

Using LEDs for these applications has been steadily on the rise because of their advantages such as energy savings of more than 50%, longer life times, smaller form factor, and extremely low recurring maintenance costs. One other significant advantage that RGBW LEDs offer is their ability to generate a very large gamut of colors by mixing different lights together in different proportions. Along with this, LEDs also have a very high contrast ratio, thereby supporting a wide range of intensities. 图 2 和 图 3 show examples of multicolor LED lighting applications.



图 2. RGBY LED Lighting



图 3. Stage Lighting

## 1.1 Key System Specifications

表 1. Key System Specifications

PARAMETERS	TEST CONDITIONS	MIN	TYP	MAX	UNIT
<b>INPUT CHARACTERISTICS</b>					
Input voltage <sup>(1)</sup>		27	28	42	V
Input UVLO setting for LM3409		—	12	—	V
<b>OUTPUT CHARACTERISTICS</b>					
LED current per string	$V_{IN} = 28\text{ V}$ , at full load	0	1.25 <sup>(2)</sup>	—	A
Inductor ripple current or LED current per string <sup>(3)</sup>	Peak-to-peak	—	—	265 <sup>(4)</sup>	mA
<b>LOAD CHARACTERISTICS<sup>(5)</sup></b>					
Red LED string forward voltage	Forward current = 700 mA	12.6	15 <sup>(6)</sup>	17.4	V
Green LED string forward voltage	Forward current = 700 mA	19.2	21.6 <sup>(6)</sup>	25.2	V
Blue LED string forward voltage	Forward current = 700 mA	16.8	19.2 <sup>(6)</sup>	22.8	V
White LED string forward voltage	Forward current = 700 mA	19.6	22.4 <sup>(6)</sup>	26.6	V
Forward current	—	—	700	1000	mA
<b>SYSTEMS CHARACTERISTICS</b>					
Switching frequency for red LED string	$V_{IN} = 28\text{ V}$ , at full load	—	630 <sup>(7)</sup>	—	kHz
Switching frequency for green LED string	$V_{IN} = 28\text{ V}$ , at full load	—	570 <sup>(7)</sup>	—	kHz
Switching frequency for blue LED string	$V_{IN} = 28\text{ V}$ , at full load	—	600 <sup>(7)</sup>	—	kHz
Switching frequency for white LED string	$V_{IN} = 28\text{ V}$ , at full load	—	530 <sup>(7)</sup>	—	kHz

<sup>(1)</sup> The minimum input voltage to the buck LED driver circuit is dependent on the LED string voltage requirement. However, the LM3409 device is capable of operating up to 42 V, and the LM3409HV can operate up to 75 V.

<sup>(2)</sup> The output LED current for all the strings at full load

<sup>(3)</sup> The inductor or LED ripple current is dependent on the inductor value chosen. This inductor value can be increased to decrease the peak-to-peak ripple current.

<sup>(4)</sup> The inductor or LED ripple current mentioned for the red LED string, which is the maximum among all the strings.

<sup>(5)</sup> LED COB part number: 897-LZPL0MD000000

<sup>(6)</sup> Forward voltage at 25°C

<sup>(7)</sup> The switching frequency is dependent upon the actual operating point ( $V_{IN}$  and  $V_O$ )

## 2 System Overview

### 2.1 Block Diagram



图 4. TIDA-01415 Block Diagram

## 2.2 Highlighted Products

### 2.2.1 LM3409

The LM3409, LM3409-Q1, LM3409HV, and LM3409HV-Q1 are P-channel MOSFET (PFET) controllers for step-down (buck) current regulators. They offer a wide input voltage range, high-side differential current sense with low adjustable threshold voltage, fast output enable and disable function, and a thermally enhanced 10-pin, HVSSOP package. These features combine to make the LM3409 family of devices ideal for use as constant current sources for driving LEDs where forward currents up to 5 A are easily achievable.

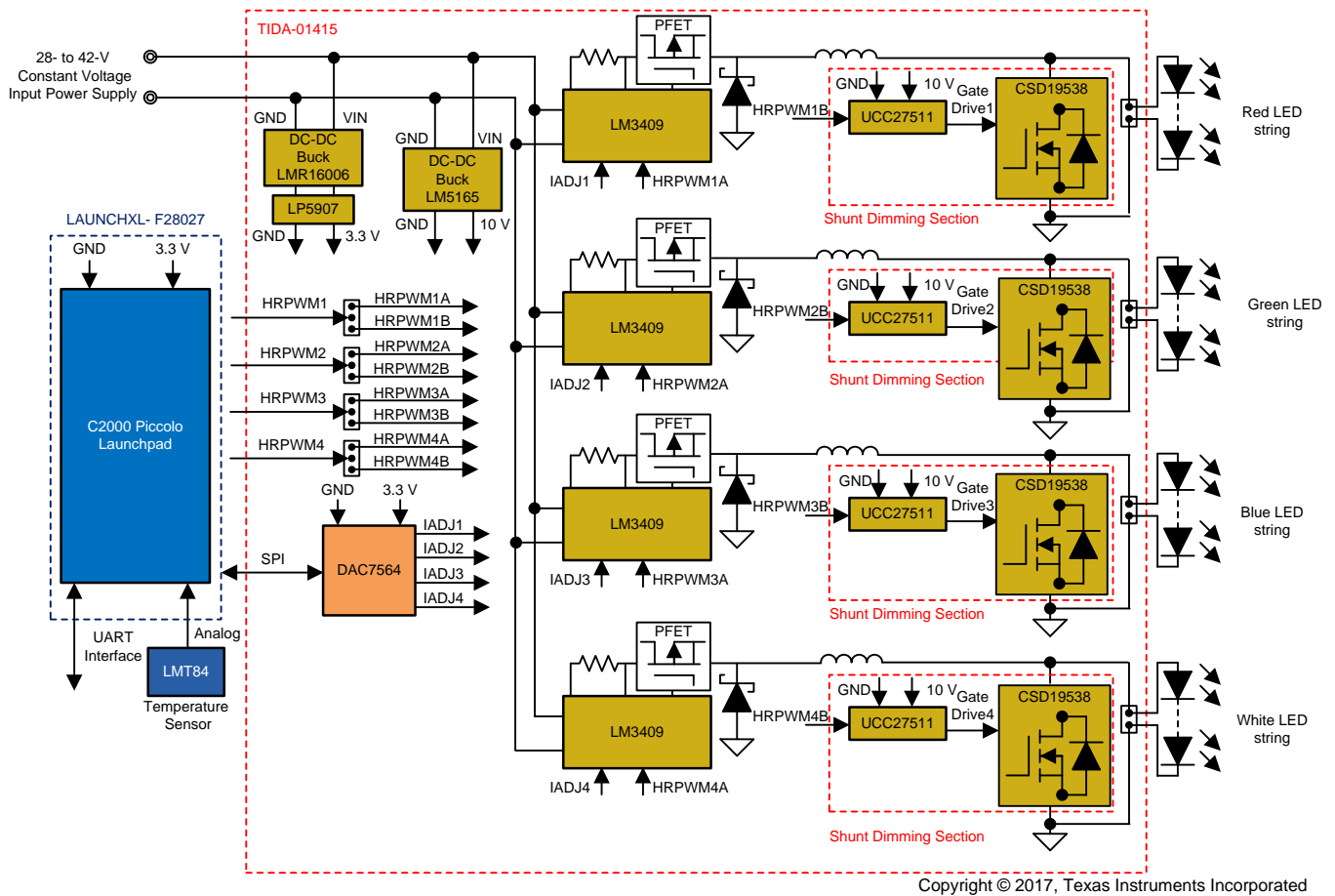
The LM3409 devices use constant off-time (COFT) control to regulate an accurate constant current without the need for external control loop compensation. Analog and PWM dimming are easy to implement and result in a highly linear dimming range with excellent achievable contrast ratios. Programmable UVLO, low-power shutdown, and thermal shutdown complete the feature set.

Features:

- 2- $\Omega$ , 1-A peak MOSFET gate drive
- $V_{IN}$  range: 6 to 42 V (LM3409, LM3409-Q1)
- $V_{IN}$  range: 6 to 75 V (LM3409HV, LM3409HVQ1)
- Differential, high-side current sense
- Cycle-by-cycle current limit
- No control loop compensation required
- 10,000:1 PWM dimming range
- 250:1 analog dimming range
- Supports all-ceramic output capacitors and capacitor-less outputs
- Low-power shutdown and thermal shutdown
- Thermally enhanced 10-pin, HVSSOP package

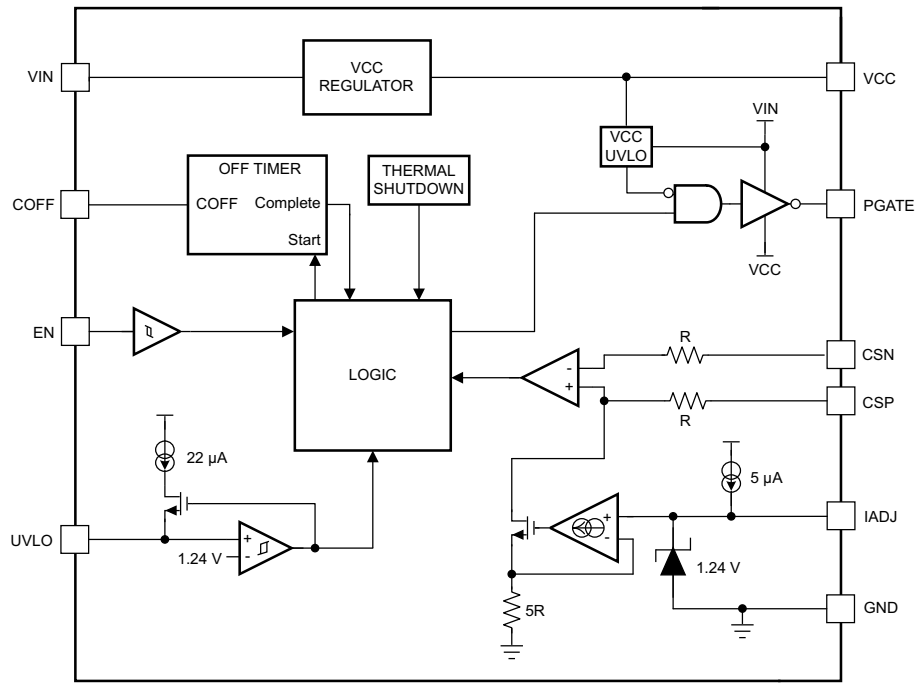

Copyright © 2017, Texas Instruments Incorporated

图 5. Functional Block Diagram of LM3409

### 2.2.2 DAC7564

The DAC7564 is a low-power, voltage-output, four-channel, 12-bit digital-to-analog converter (DAC). The device includes a 2.5-V, 2-ppm/°C internal reference (enabled by default), giving a full-scale output voltage range of 2.5 V. The internal reference has an initial accuracy of 0.02% and can source up to 20 mA at the VREFH/VREFOUT pin. The device is monotonic, provides very good linearity, and minimizes undesired code-to-code transient voltages (glitch). The DAC7564 uses a versatile three-wire serial interface that operates at clock rates up to 50 MHz. The interface is compatible with standard SPI, Quad-SPI™ (QSPI), Microwire™, and digital signal processor (DSP) interfaces.

The DAC7564 incorporates a power-on-reset circuit that ensures the DAC output powers up at zero-scale and remains there until a valid code is written to the range (FSR) device. The device contains a power-down feature, accessed over the serial interface, that reduces the current consumption of the device to 1.3  $\mu$ A at 5 V. Power consumption is 2.9 mW at 3 V, reducing to 1.5  $\mu$ W in power-down mode. The low-power consumption, internal reference, and small footprint make this device ideal for portable, battery-operated equipment.

Features:

- Relative accuracy: 0.5 LSB
- Glitch energy: 0.15 nV-s
- Internal reference:
  - 2.5-V reference voltage (enabled by default)
  - 0.004% initial accuracy (typ)
  - 2-ppm/°C temperature drift (typ)
  - 5-ppm/°C temperature drift (max)
  - 20-mA sink/source capability
- Power-on reset to zero-scale
- Ultra-low-power operation: 1 mA at 5 V
- Wide power supply range: 2.7 to 5.5 V
- 12-bit monotonic over-temperature range
- Settling time: 10  $\mu$ s to  $\pm$ 0.024% full-scale and remains there until a valid code is written to the range (FSR)
- Low-power serial interface with Schmitt-triggered inputs: Up to 50 MHz
- On-chip output buffer amplifier with rail-to-rail operation
- 1.8- to 5.5-V logic compatibility
- Temperature range:  $-40^{\circ}$ C to  $105^{\circ}$ C



图 6. Functional Block Diagram of DAC7564

### 2.2.3 UCC27511

The UCC27511 single-channel, high-speed, low-side gate driver device can effectively drive MOSFET and IGBT power switches. Using a design that inherently minimizes shoot-through current, The UCC27511 is capable of sourcing and sinking high peak-current pulses into capacitive loads offering rail-to-rail drive capability and extremely small propagation delay, typically 13 ns.

Features:

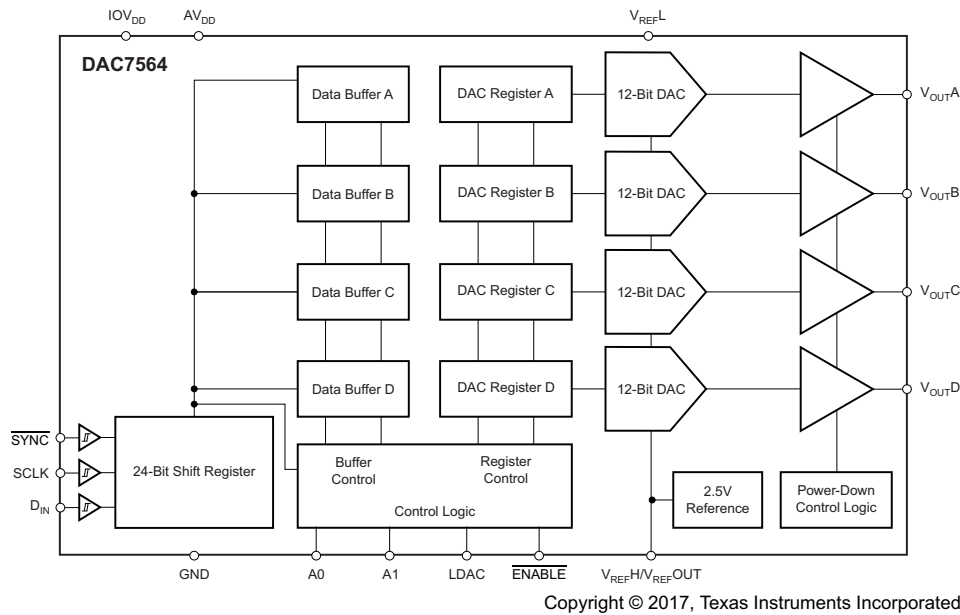
- Low-cost gate driver device offering superior replacement of NPN and PNP discrete solutions
- 4-A peak source and 8-A peak sink asymmetrical drive
- Strong sink current offers enhanced immunity against Miller turnon
- Fast propagation delays (13-ns typical)
- Fast rise and fall times (9-ns and 7-ns typical)
- 4.5- to 18-V single supply range
- Split output configuration (allows easy and independent adjustment of turnon and turnoff speeds) in the UCC27511 saves 1 diode
- Outputs held low during VDD UVLO (ensures glitch-free operation at power up and power down)
- TTL and CMOS compatible input-logic threshold (independent of supply voltage)
- Hysteretic-logic thresholds for high-noise immunity
- Dual-input design (choice of an inverting (IN<sup>-</sup> pin) or non-inverting (IN<sup>+</sup> pin) driver configuration)
- Output held low when input pins are floating
- Input pin absolute maximum voltage levels not restricted by VDD pin bias supply voltage
- Operating temperature range of -40°C to 140°C
- 6-pin DBV (SOT-23) and 6-pin DRS (3-mm × 3-mm WSON with exposed thermal pad) package options



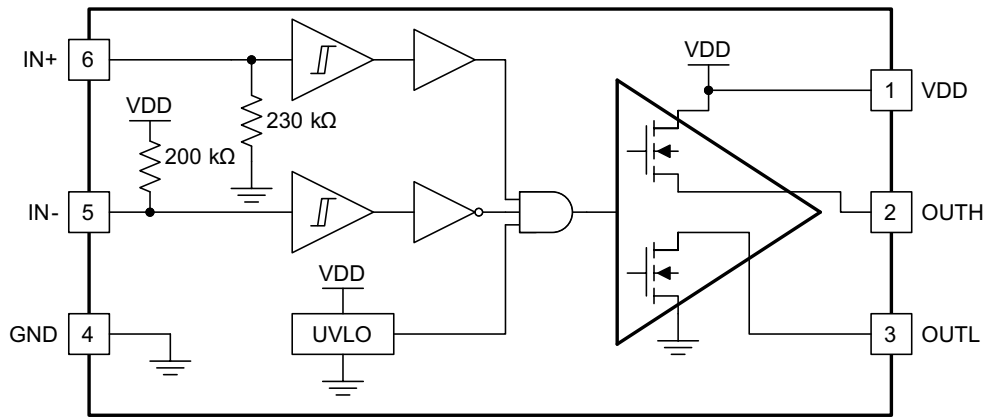

Copyright © 2017, Texas Instruments Incorporated

图 7. Functional Block Diagram of UCC27511

#### 2.2.4 CSD19538Q2

This 100-V, 49-mΩ, SON 2-mm × 2-mm NexFET™ power MOSFET is designed to minimize losses in power conversion applications.

Features:

- Ultra-low  $Q_g$  and  $Q_{gd}$
- Low thermal resistance
- Avalanche rated
- SON 2-mm × 2-mm plastic package
- Lead and halogen free
- RoHS compliant

### 2.2.5 TMS320F2802x

The F2802x Piccolo™ family of microcontrollers provides the power of the C28x core coupled with highly integrated control peripherals in low pin-count devices. This family is code-compatible with previous C28x-based code, and also provides a high level of analog integration.

An internal voltage regulator allows for single-rail operation. Enhancements have been made to the high resolution pulse width modulation (HRPWM) to allow for dual-edge control (frequency modulation). Analog comparators with internal 10-bit references have been added and can be routed directly to control the PWM outputs. The ADC converts from 0- to 3.3-V fixed full-scale range and supports ratio-metric VREFHI/VREFLO references. The ADC interface has been optimized for low overhead and latency.

Features:

- High-efficiency 32-bit CPU (TMS320C28x)
- Up to 22 individually programmable, multiplexed GPIO pins with input filtering
- Peripheral interrupt expansion (PIE) block that supports all peripheral interrupts
- Three 32-bit CPU timers
- Independent 16-bit timer in each enhanced pulse width modulator (ePWM)
- On-chip memory
  - Flash, SARAM, OTP, boot ROM available
- Code security module
- 128-bit security key and lock
- Serial port peripherals
  - One serial communications interface (SCI) universal asynchronous receiver/transmitter (UART) module
  - One SPI module
  - One inter-integrated circuit (I2C) module
- Enhanced control peripherals
  - ePWM
  - High-resolution PWM (HRPWM)
  - Enhanced capture (eCAP) module
  - Analog-to-digital converter (ADC)
  - On-chip temperature sensor
  - Comparator
- Advanced emulation features
  - Analysis and breakpoint functions
  - Real-time debug through hardware

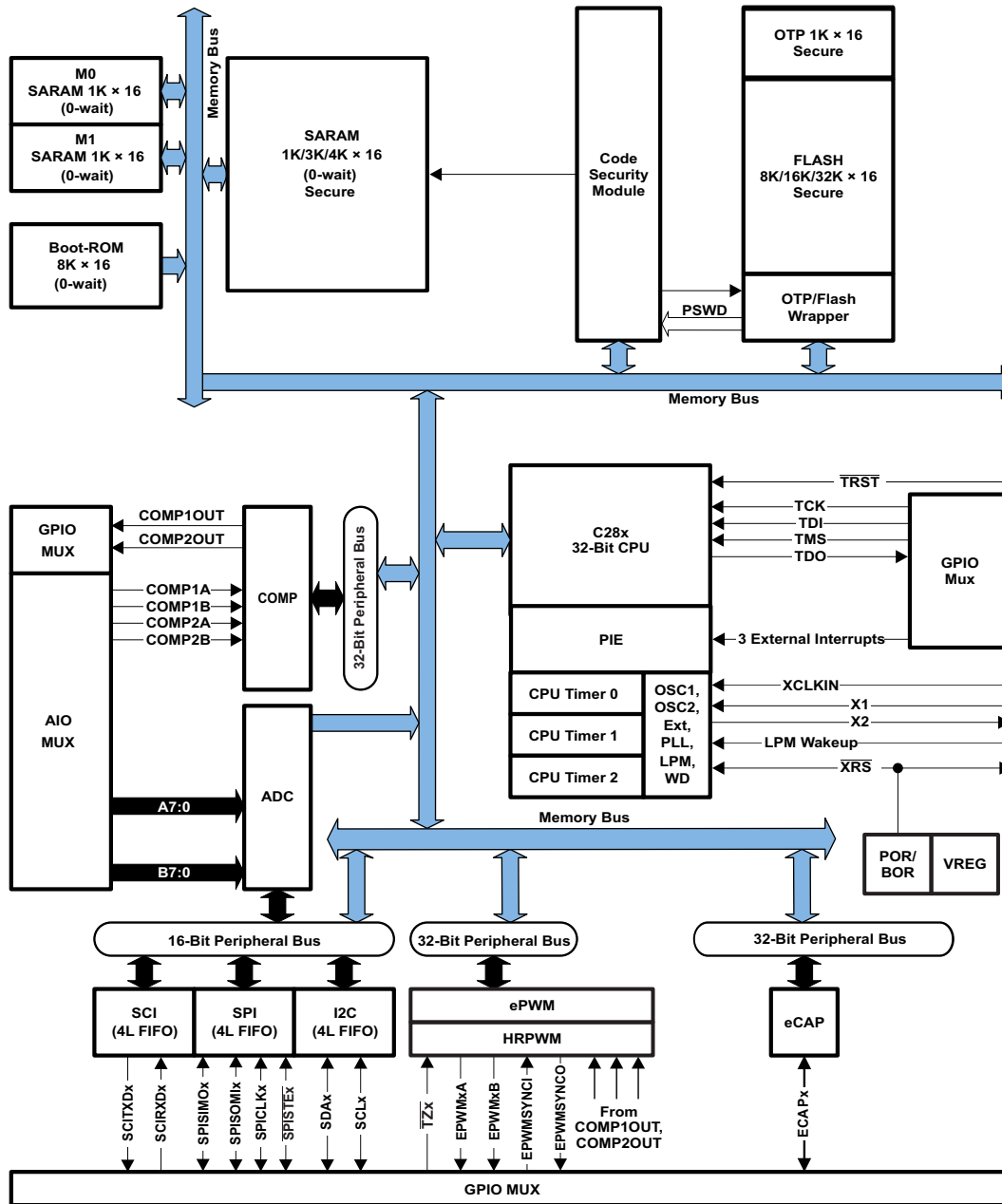

Copyright © 2017, Texas Instruments Incorporated

图 8. Functional Block Diagram of C2000

## 2.2.6 LMR16006

The LMR16006 is a PWM DC/DC buck (step-down) regulator. With a wide input range of 4 to 60 V, it is suitable for a wide range of application from industrial to automotive for power conditioning from an unregulated source. The regulator's standby current is 28  $\mu$ A in ECO mode, which is suitable for battery operating systems. An ultra-low 1- $\mu$ A shutdown current can further prolong battery life. Operating frequency is fixed at 0.7 MHz (X version) and 2.1 MHz (Y version), allowing the use of small external components while still being able to have low output ripple voltage. Soft-start and compensation circuits are implemented internally, which allows the device to be used with minimized external components. The LMR16006 is optimized for up to 600-mA load currents. It has a 0.765-V typical feedback voltage. The device has built-in protection features such as pulse-by-pulse current limit, thermal sensing, and shutdown due to excessive power dissipation. The LMR16006 is available in a low profile SOT-6L package.

Features:

- Ultra-low 28- $\mu$ A standby current in ECO mode
- Input voltage range of 4 to 60 V
- 1- $\mu$ A shutdown current
- High duty cycle operation supported
- Output current up to 600 mA
- 0.7 and 2.1 MHz switching frequency
- Internal compensation
- High-voltage enable input
- Internal soft start
- Overcurrent protection
- Over-temperature protection
- Small overall solution size (SOT-6L package)

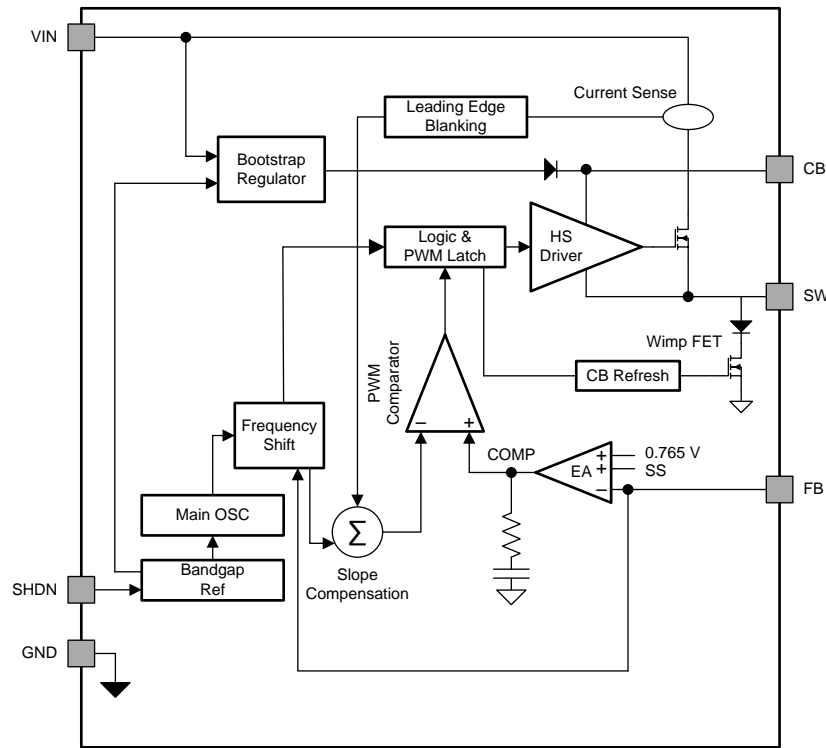

Copyright © 2017, Texas Instruments Incorporated

图 9. Functional Block Diagram of LMR16006

### 2.2.7 LM5165

The LM5165-Q1 device is a compact, easy-to-use, 3- to 65-V, ultra-low  $I_Q$  synchronous buck converter with high efficiency over wide input voltage and load current ranges. With integrated high-side and low-side power MOSFETs, up to 150-mA of output current can be delivered at either fixed output voltages of 3.3 V, 5 V, or at an adjustable output. The converter is designed to simplify implementation while providing options to optimize the performance for the target application. Pulse frequency modulation (PFM) mode is selected for optimal light-load efficiency or constant on-time (COT) control for nearly constant operating frequency. Both control schemes do not require loop compensation while providing excellent line and load transient response and short PWM on-time for large step-down conversion ratios.

The high-side P-channel MOSFET can operate at a 100% duty cycle for the lowest dropout voltage and does not require a bootstrap capacitor for the gate drive. Also, the current limit set point is adjustable to optimize inductor selection for a particular output current requirement. Selectable and adjustable start-up timing options include minimum delay (no soft start), internally fixed (900  $\mu$ s), and externally programmable soft start using a capacitor. An open-drain PGOOD indicator can be used for sequencing, fault reporting, and output voltage monitoring. The LM5165-Q1 is qualified to automotive AEC-Q100 grade 1 and is available in 10-pin VSON and VSSOP packages with a 0.5-mm pin pitch.

Features:

- Wide input voltage range of 3 to 65 V
- Fixed (3.3-V, 5-V) or adjustable output voltages
- Maximum output current as high as 150 mA
- 10.5- $\mu$ A no-load quiescent current
- $-40^{\circ}\text{C}$  to  $150^{\circ}\text{C}$  junction temperature range
- Selectable PFM or COT mode operation
- Active slew rate control for low EMI
- Integrated 2- $\Omega$  PMOS buck switch
  - Supports 100% duty cycle for low dropout
- Integrated 1- $\Omega$  NMOS synchronous rectifier
  - Eliminates external rectifier diode
- Programmable current limit set point (four levels)
- 1.223-V internal voltage reference
- 900- $\mu$ s internal or programmable soft start
- Monotonic start-up into pre-biased output
- No loop compensation or bootstrap components
- Precision enable and input UVLO with hysteresis
- Thermal shutdown protection with hysteresis
- 10-pin VSON and VSSOP packages

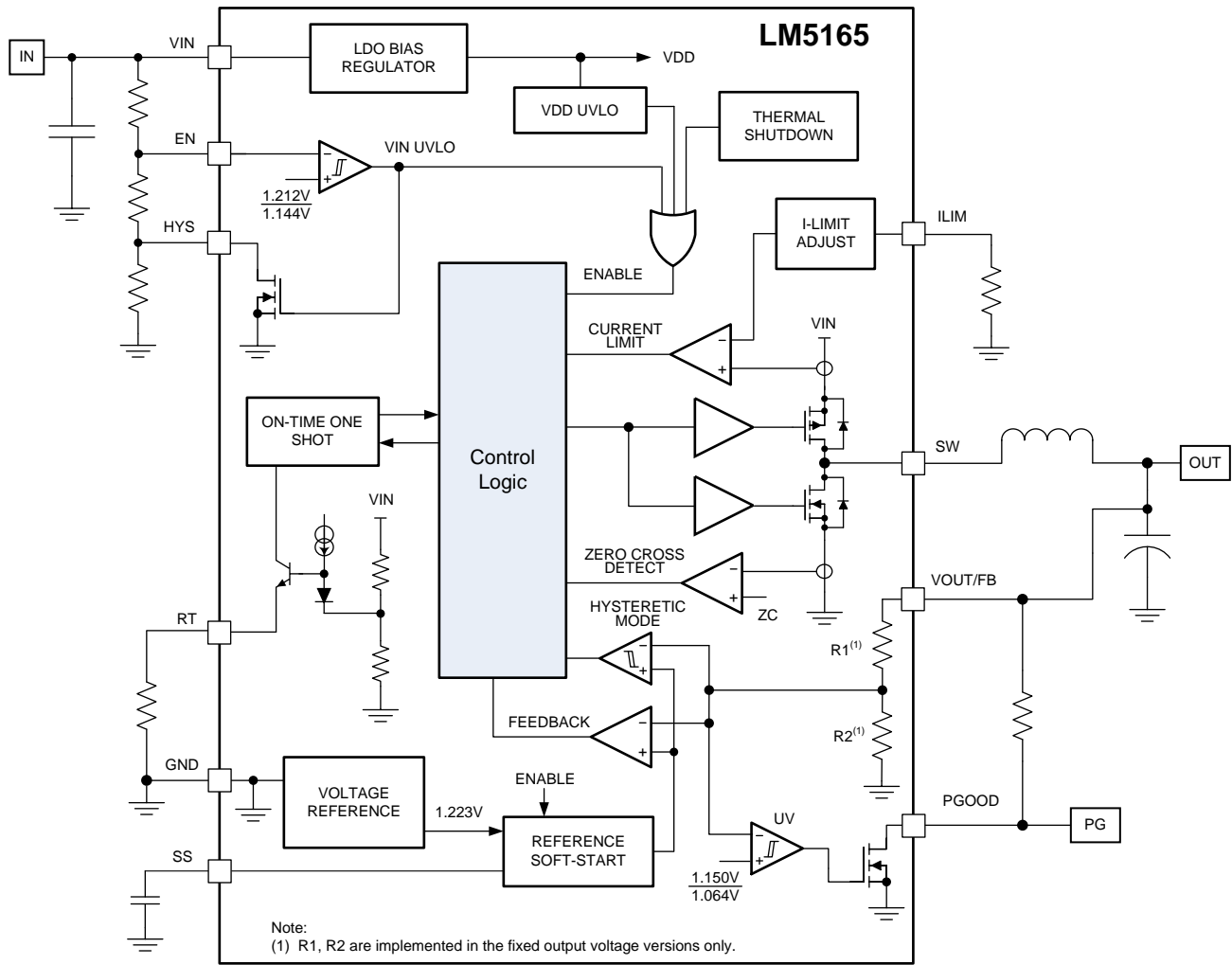

Copyright © 2017, Texas Instruments Incorporated

图 10. Functional Block Diagram of LM5165

### 2.2.8 LP5907

The LP5907 is a low-noise LDO that can supply up to a 250-mA output current. Designed to meet the requirements of RF and analog circuits, the LP5907 device provides low noise, high PSRR, low quiescent current, and low line or load transient response figures. Using new innovative design techniques, the LP5907 offers class-leading noise performance without a noise bypass capacitor and the ability for remote output capacitor placement. The device is designed to work with a 1- $\mu$ F input and a 1- $\mu$ F output ceramic capacitor (no separate noise bypass capacitor is required). This device is available with fixed output voltages from 1.2 to 4.5 V in 25-mV steps. Contact Texas Instruments Sales for specific voltage option needs.

#### Features:

- Input voltage range: 2.2 to 5.5 V
- Output voltage range: 1.2 to 4.5 V
- Output current: 250 mA
- Stable with 1- $\mu$ F ceramic input and output capacitors
- No noise bypass capacitor required
- Remote output capacitor placement
- Thermal-overload and short-circuit protection
- $-40^{\circ}\text{C}$  to  $125^{\circ}\text{C}$  junction temperature range for operation
- Low output voltage noise:  $< 6.5 \mu\text{V}_{\text{RMS}}$
- PSRR: 82 dB at 1 kHz
- Output voltage tolerance:  $\pm 2\%$
- Virtually zero  $I_{\text{Q}}$  (disabled):  $< 1 \mu\text{A}$
- Very low  $I_{\text{Q}}$  (enabled):  $12 \mu\text{A}$



## 2.3 System Design Theory

High-power LEDs require a constant-current drive, and the LED driver should be capable of adjusting the current (illuminance) of the LED to enable dimming. For DC lighting systems, low-voltage DC will be directly available, which means a current controller with dimming capability is adequate. To enable dimming and control, one would need a wireless control or wired control system.

The TIDA-01415 uses the LM3409 P-FET Buck Controller for driving high-power LEDs. The device requires one external PFET that need to be sized based on the power requirements. The LM3409 has a wide input voltage range, allowing the design to regulate a variety of LED loads. The high-side differential current sense with a low adjustable threshold voltage provides an excellent method for regulating output current while maintaining high system efficiency. The LM3409/LM3409HV uses a controlled off-time (COFT) architecture that allows the converter to be operated in both continuous conduction mode (CCM) and discontinuous conduction mode (DCM) with no external control loop compensation, while providing an inherent cycle-by-cycle current limit. The adjustable current sense threshold provides the capability to amplitude (analog) dim the LED current over the full range, and the fast output enable/disable function allows for high-frequency PWM dimming using no external components.

The LM3409 is a good candidate for parallel FET dimming because high slew rates are achievable because no output capacitance is required. This allows for much higher dimming frequencies than are achievable using the EN pin with linear operation of the LED driver stage. The UCC27511 and CSD19538 (used as gate driver and shunt dimming FET in this TI Design, respectively) have very low rise time, fall time, and propagation delays, allowing for linear dimming at frequencies much higher than 30 kHz.

TIDA-01415 PCB is designed to be compatible with C2000 PICCOLO Launch pad "LAUNCHXL-F28027" hardware that uses the MCU TMS320F28027. The MCU generates four channels of high resolution PWM signals which is used as a direct dimming input for either LM3409 ICs or as shunt dimming signal via the jumper selection. So, one can use LM3409 dimming function directly for PWM dimming frequencies up to 30kHz or in case if PWM frequencies more than 30kHz is needed with linear dimming then, the shunt dimming feature can be utilized. The 4 Channel 12 bit DAC DAC7564 is interfaced with the TMS320F28027 MCU via SPI interface and this arrangement can generate variable Iref signals to facilitate analog dimming of LM3409 drivers for individual LED strings. Thus the platform enables one to use either Analog or PWM dimming or Shunt FET dimming.

DC-DC buck regulator LMR16006 that has a wide input range (4 to 60 V), high switching frequency (700 kHz), and very low standby current (28  $\mu$ A) is used to power C2000 Launchpad and is configured to provide 3.4V output. The low-noise LDO LP5907 is used to provide 3.3V to the 12 bit DAC. The synchronous buck regulator LM5165 is used to generate 10V for the gate driver ICs UCC27511.

The LMT84 (1.5-V Capable, 10- $\mu$ A Analog Output Temperature Sensor in a TO-92 package) allows the user to measure the temperature of the LED heat sink, which can in turn enable automatic fold-back dimming implementation in software in case of over temperature.

## 2.3.1 Design Equations

### 2.3.1.1 Input Undervoltage Lockout (UVLO)

UVLO is set with a resistor divider from  $V_{IN}$  to GND and is compared against a 1.24-V threshold as shown in 图 11.



图 11. UVLO Circuit of LM3409

Once the input voltage is above the preset UVLO rising threshold (and assuming the part is enabled), the internal circuitry becomes active, and a 22- $\mu$ A current source at the UVLO pin is turned on. This extra current provides hysteresis to create a lower UVLO falling threshold. The resistor divider is chosen to set both the UVLO rising and falling thresholds.

To set hysteresis of 1.1 V,  $R_{UV2}$  can be chosen based on 公式 1:

$$R_{UV2} = \frac{V_{HYS}}{22 \mu A} \quad (1)$$

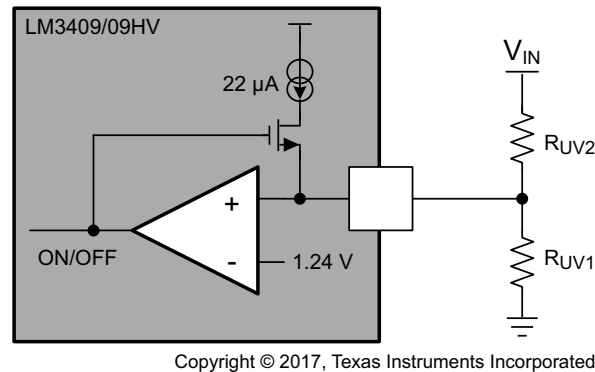
To set a turnon threshold of 12 V (typical),  $R_{UV1}$  can be chosen based on 公式 2:

$$R_{UV1} = \frac{1.24 \times R_{UV2}}{V_{TURNON} - 1.24} \quad (2)$$

### 2.3.1.2 Nominal Switching Frequency

The switching frequency can be set by an off-time resistor and capacitor where the off-time resistor ( $R_{OFF}$ ) can be calculated based on nominal input and required output voltage using 公式 3 from the device datasheet as follows:

$$R_{OFF} = \frac{-\left(1 - \frac{V_{OUT}}{\eta \times V_{IN}}\right)}{(C_{OFF} + 20 \text{ pF}) \times f_{SW} \times \ln\left(1 - \frac{1.24}{V_{OUT}}\right)} \quad (3)$$

Assuming  $C_{OFF} = 470 \text{ pF}$ , the following values for the off-time resistor ( $R_{OFF}$ ) can be found:

- For setting  $f_{SW} = 630 \text{ kHz}$  for the red LED string, the value for  $R_{OFF}$  is 16.4 k $\Omega$ .
- For setting  $f_{SW} = 570 \text{ kHz}$  for the green LED string, the value for  $R_{OFF}$  is 15.8 k $\Omega$ .
- For setting  $f_{SW} = 600 \text{ kHz}$  for the blue LED string, the value for  $R_{OFF}$  is 16.4 k $\Omega$ .
- For setting  $f_{SW} = 530 \text{ kHz}$  for the white LED string, the value for  $R_{OFF}$  is 7.8 k $\Omega$ .

Switching frequency during normal operation is both the function of output voltage and the off-time resistor used. The off-time resistor for individual strings is selected different since the forward voltage of R, G, B and W LED strings is different.

注: Typically, there is a 20-pF parasitic capacitance at the off-timer pin of the LM3409 in parallel with  $C_{OFF}$ , which is accounted for in the calculation of  $f_{SW}$  and  $t_{OFF}$ . So, assume  $C_{OFF} = 490$  pF to take parasitic capacitance of the off-timer pin into account.

### 2.3.1.3 Off-Time and Inductor Ripple Current

At the start of off-time ( $t_{OFF}$ ), the voltage across  $C_{OFF}$  ( $V_{COFF}(t)$ ) is zero and the capacitor begins charging according to the time constant provided by  $R_{OFF}$  and  $C_{OFF}$ . The off-time control circuitry is shown in 图 12:



图 12. Off-Time Control Circuit

When  $V_{COFF}(t)$  reaches the off-time threshold ( $V_{COFT} = 1.24$  V), then the off-time is terminated and  $V_{COFF}(t)$  is reset to zero. Calculate  $t_{OFF}$  using 公式 4:

$$t_{OFF} = -(C_{OFF} + 20 \text{ pF}) \times R_{OFF} \times \ln \left( 1 - \frac{1.24}{V_{OUT}} \right) \quad (4)$$

Calculate the inductor value using 公式 5:

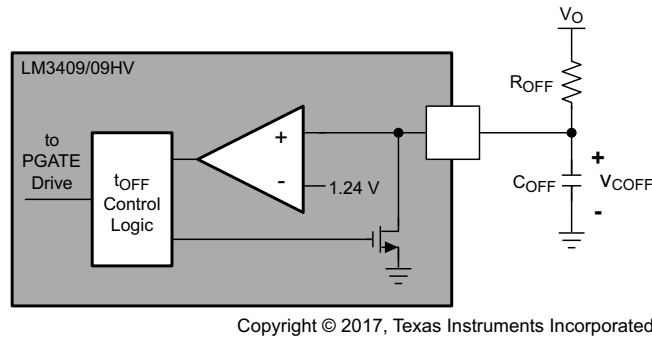
$$L = \frac{V_{OUT} \times t_{OFF}}{\Delta i_{L-PP}} \quad (5)$$

The inductor value chosen for all strings is 47  $\mu$ H.

Calculate the peak-to-peak ripple current based on the inductor value chosen using 公式 6:

$$\Delta i_{L-PP} = \frac{V_{OUT} \times t_{OFF}}{L} \quad (6)$$

### 2.3.1.4 Average LED Current and Current Sense ( $I_{ADJ}$ )

For a buck converter, the average LED current is simply the average inductor current. Using the  $C_{OFF}$  architecture, the peak transistor current ( $I_{T-MAX}$ ) is sensed, which is equal to the peak inductor current ( $I_{L-MAX}$ ) given by 公式 7:

$$I_{L-MAX} = I_{LED} + \frac{\Delta i_{L-PP}}{2} \quad (7)$$

The threshold voltage seen by the high-side sense comparator is affected by the comparator's input offset voltage, which causes an error in the calculation of  $I_{L-MAX}$  and ultimately  $I_{LED}$ . To mitigate this problem, the polarity of the comparator inputs is swapped every cycle, which causes the actual  $I_{L-MAX}$  to alternate between two peak values ( $I_{L-MAXH}$  and  $I_{L-MAXL}$ ), equidistant from the theoretical  $I_{L-MAX}$  as shown in 图 13.  $I_{LED}$  remains accurate through this averaging.

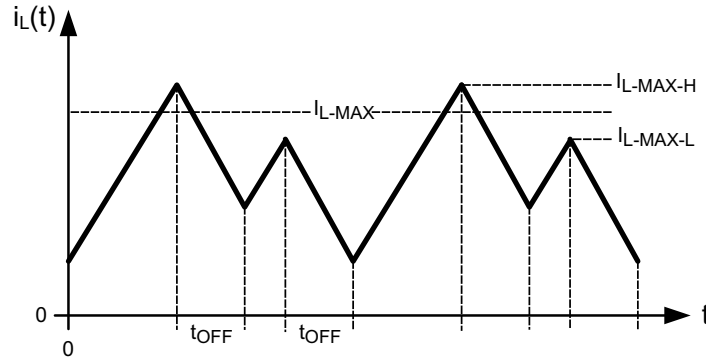

Copyright © 2017, Texas Instruments Incorporated

图 13. Inductor Current  $i_L(t)$  Showing  $I_{L-MAX}$  Offset

Assuming  $V_{ADJ} = 1.24$  V, calculate the high-side sense resistor using 公式 8:

$$R_{SNS} = \frac{V_{ADJ}}{5 \times I_{L-MAX}} \quad (8)$$

The chosen sense resistor ( $R_{SNS}$ ) value for all strings is 0.3  $\Omega$ .

Because the LM3409/LM3409HV swaps the polarity of the differential current sense comparator every cycle, a minimum inductor current ripple ( $\Delta i_{L-PP}$ ) is necessary to maintain accurate  $I_{LED}$  regulation. The minimum inductor current ripple ( $\Delta i_{L-PP-MIN}$ ) should adhere to 公式 9 to ensure accurate  $I_{LED}$  regulation:

$$\Delta i_{L-PP-MIN} > \frac{24 \text{ mV}}{R_{SNS}} \quad (9)$$

### 2.3.1.5 Input Capacitance

The minimum input capacitance ( $C_{IN-MIN}$ ) is selected using the maximum input voltage ripple ( $\Delta V_{IN-MAX}$ ), which can be tolerated.  $\Delta V_{IN-MAX}$  is equal to the change in voltage across  $C_{IN}$  during  $t_{ON}$  when it supplies the load current. A good starting point for selection of  $C_{IN}$  is to use  $\Delta V_{IN-MAX}$  of 2% to 10% of  $V_{IN}$ . First,  $t_{ON}$  can be calculated using 公式 10:

$$t_{ON} = \frac{1}{f_{SW}} - t_{OFF} \quad (10)$$

Now, assuming  $\Delta V_{IN-MAX}$  is 720 mV,  $C_{IN-MIN}$  can be calculated using 公式 11:

$$C_{IN-MIN} = \frac{I_{LED} \times t_{ON}}{\Delta V_{IN-PP}} \quad (11)$$

注: An input capacitance at least 75% greater than the calculated  $C_{IN-MIN}$  value is recommended.

### 2.3.1.6 P-Channel MOS-FET Selection

The LM3409/LM3409HV requires an external PFET as the main power MOSFET for the switching regulator. The PFET should have a voltage rating at least 15% higher than the maximum input voltage to ensure safe operation during the ringing of the switch node. In practice, all switching converters have some ringing at the switch node due to the diode parasitic capacitance and the lead inductance. The PFET should also have a current rating at least 10% higher than the average transistor current ( $I_T$ ) given using 公式 12:

$$I_T = D \times I_{LED} = \frac{V_{OUT} \times I_{LED}}{\eta \times V_{IN}} \quad (12)$$

The power rating is verified by calculating the power loss ( $P_T$ ) using the RMS transistor current ( $I_{T-RMS}$ ) and the PFET on-resistance ( $R_{DS-ON}$ ) using 公式 13 and 公式 14, respectively:

$$I_{T-RMS} = I_{LED} \times \sqrt{D \times \left( 1 + \frac{1}{12} \times \left( \frac{\Delta i_{L-PP}}{I_{LED}} \right)^2 \right)} \quad (13)$$

$$P_T = I_{T-RMS}^2 \times R_{DS-ON} \quad (14)$$

The dominant switching losses are determined by input voltage, switching frequency, and PFET total gate charge ( $Q_G$ ). For a given range of operating points, the only effective way to reduce these switching losses is to minimize  $Q_G$ . A good rule of thumb is to limit  $Q_G < 30$  nC (if the switching frequency remains below 300 kHz for the entire operating range, then a larger  $Q_G$  can be considered). If a PFET with small  $R_{DS-ON}$  and a high voltage rating is required, there may be no choice but to use a PFET with  $Q_G > 30$  nC.

---

注: PFET should be chosen to meet the  $Q_G$  specification whenever possible, while minimizing  $R_{DS-ON}$ . This will minimize power losses while ensuring the part functions correctly over the full operating range.

---

### 2.3.1.7 Recirculating Diode Selection

A recirculating diode is required to carry the inductor current during  $t_{OFF}$ . The most efficient choice is a Schottky diode due to low forward voltage drop and near-zero reverse recovery time. Similar to PFET, a Schottky diode must have a voltage rating at least 15% higher than the maximum input voltage to ensure safe operation during the ringing of the switch node and a current rating at least 10% higher than the average diode current ( $I_D$ ). The required diode current can be calculated using 公式 15:

$$I_D = (1-D) \times I_{LED} = \left( 1 - \frac{V_{OUT}}{\eta \times V_{IN}} \right) \quad (15)$$

The power rating is verified by calculating the power loss through the diode. This is accomplished by checking the typical diode forward voltage ( $V_D$ ) from the I-V curve on the product datasheet and calculating using 公式 16 as follows:

$$P_D = V_D \times I_D \quad (16)$$

In general, higher current diodes have a lower  $V_D$  and come in better performing packages minimizing both power losses and temperature rise.

### 2.3.1.8 External Parallel FET Dimming

When using external parallel FET dimming, a situation can arise where maximum off-time occurs due to a shorted output. To mitigate this situation, a secondary voltage ( $V_{DD}$ ) should be used as shown in 图 14.

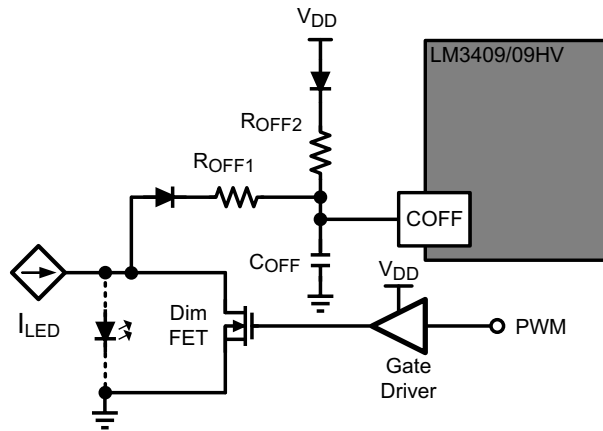

Copyright © 2017, Texas Instruments Incorporated

图 14. External Parallel FET Dimming Circuit

A small diode is connected in series with the off-time resistor calculated for nominal operation from the output,  $R_{OFF1}$ . Then connect a small diode from the secondary voltage along with another resistor,  $R_{OFF2}$ . The secondary voltage can be any voltage as long as it is greater than 2 V. The value of  $R_{OFF2}$  can be calculated using 公式 17:

$$R_{OFF2} = \frac{R_{OFF1} \times V_{DD}}{I_{LED} \times R_{DS-ON}} \quad (17)$$

## 2.3.2 Dimming Techniques

### 2.3.2.1 Analog Dimming Using $I_{ADJ}$

The LED current can be set, and controlled dynamically, by using the  $I_{ADJ}$  setting of the LM3409. In this TI Design, the  $V_{ADJ}$  voltage can be varied from 1.24 V to 0 V for linearly scaling the peak current threshold. Analog dimming will eventually push the converter in to DCM and the inductor current ripple will no longer be constant, causing a divergence from linear dimming at low levels. The LED current is related to  $V_{ADJ}$  using 公式 18:

$$I_{LED} = \frac{V_{ADJ}}{5 \times R_{SNS}} - \frac{\Delta i_{L-PP}}{2} \quad (18)$$

The DAC7564 is used to convert data incoming from the C2000 LaunchPad to analog voltage. See 节 3.3.3 for the set of measurements taken using this feature.

### 2.3.2.2 PWM Dimming Using EN Pin

The EN pin can be driven with a PWM signal, which controls the external PFET operation. The duty cycle of the incoming PWM signal from C2000 can be modulated to vary the illuminance of an LED. The enable pin (EN) is a TTL-compatible input for PWM dimming of the LED. A logic low (below 0.5 V) at EN disables the internal driver and shuts off the current flow to the LED string. While the EN pin is in a logic low state, the support circuitry (driver, band gap, VCC regulator) remains active to minimize the time needed to turn the LED string back on when the EN pin sees a logic high (above 1.74 V). 图 15 shows the LED current ( $i_{LED}(t)$ ) during PWM dimming where the duty cycle ( $D_{DIM}$ ) is the percentage of the dimming period ( $T_{DIM}$ ) that the PFET is switching. For the remainder of  $T_{DIM}$ , the PFET is disabled.

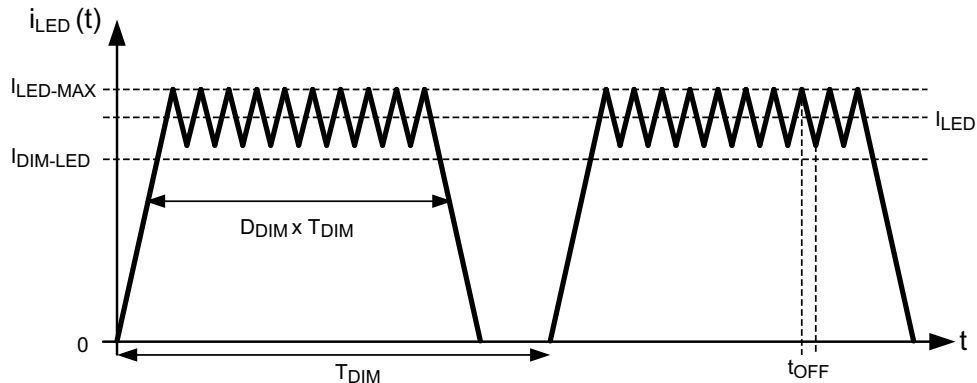

Copyright © 2017, Texas Instruments Incorporated

图 15. LED Current  $i_{LED}(t)$  During EN Pin PWM Dimming

The resulting dimmed LED current ( $I_{DIM\_LED}$ ) is given using 公式 19:

$$I_{DIM\_LED} = D_{DIM} \times I_{LED} \tag{19}$$

This PWM is generated using the C2000 MCU and the operation of this feature has been tested for PWM frequency of 30 and 50 kHz. In the application area of stage lighting, high frequency dimming ensures imperceptible operation of LEDs when captured using high-end cameras. See 节 3.3.3 for the set of measurements taken using this feature.

### 2.3.2.3 Shunt FET Dimming

Shunt FET dimming allows for much faster linear PWM dimming that can be attained with the EN pin. No capacitance at the output of the LED driver stage allows one to achieve high slew rates, which makes the LM3409 a good candidate for shunt FET dimming.

Low rise time, fall time, and propagation delays of the CSD19532 (shunt FET) and UCC27511 (gate driver) enable this TI Design to achieve a wide contrast ratio and linearity at dimming frequency even greater than 30 kHz. Small packaging with low thermal resistance leads to better thermal management of shunt FET on the board and save area as well. See 节 3.3.3 for the set of measurements taken using this feature.

### 2.3.3 C2000 and HRPWM

When using the PWM or shunt dimming method to control the LED brightness, the frequency and the resolution of the PWM pulse being used is of prime importance. High resolution allows the user to generate a wide spectrum of colors by precisely varying the current through the LED strings and the frequency of switching makes it imperceptible when viewed by naked eyes or through a high-end camera.

Using traditional methods of PWM generation using an MCU, there is always a trade-off between these two important factors for increasing the frequency leads to a compromise in the resolution and vice versa. For example, with the MCU operating with a clock of 60MHz and with a 16 bit PWM module, the effective PWM resolution achievable will be around 12 bits when the PWM frequency is 2kHz. For the same clock if the PWM frequency is increased to 30kHz, then the effective PWM resolution falls to around 10 bits. To mitigate this problem and to achieve a higher effective PWM resolution together with fast switching, this TI Design uses the HRPWM feature of the C2000 MCU.

The HRPWM is based on micro edge positioner (MEP) technology. Using this logic, the MCU is capable of placing an edge of the PWM very finely by sub-dividing one coarse system clock of a conventional PWM generator. 图 16 shows the placement of the conventional PWM steps and the enhancement offered by HRPWM.



图 16. Conventional PWM and HRPWM Timing Diagram

The maximum MEP steps of HRPWM for a particular MCU frequency and PWM frequency can be calculated as follows:

- MCU clock period = 16.66 ns (60 MHz)
- Maximum number of MEP steps per coarse step at 180 ps = MCU clock period / 180 ps = 16.66 ns / 180 ps
- Maximum number of MEP steps = 92.5

Therefore, when operating at a system clock of 60 MHz and a PWM frequency of 30 kHz, one can accurately position the edge of the PWM accurately in one of the 92 steps between two system clock cycles. Not only does this reduce the error in selecting any arbitrary duty cycle of operation, but also results in a significant increase in resolution (16 bits) without any trade-off in the frequency of operation. The TIDA-01415 is also tested with the C2000 HRPWM feature to monitor the change in LED current with a change of 10 MEP steps. The falling edge of PWM signal is controlled to change the duty cycle minutely through changing MEP steps. 表 2 shows the data captured for the change in LED current with changing the MEP steps for a PWM dimming frequency of 30 kHz.

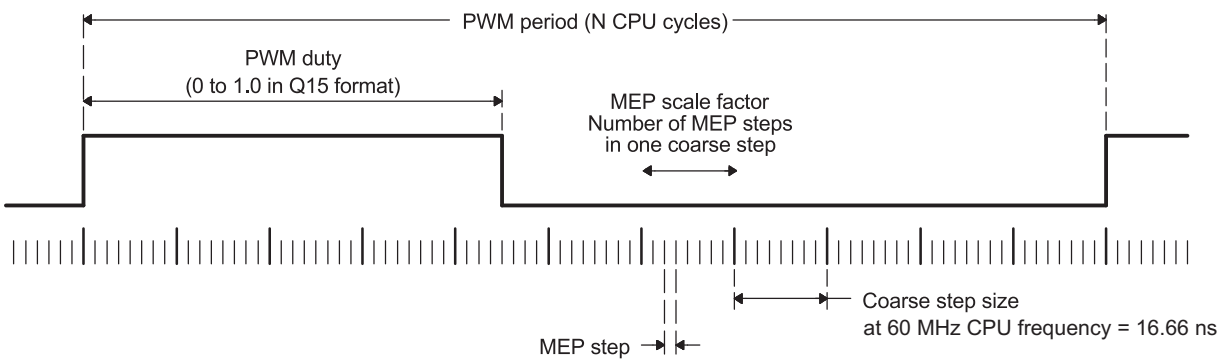
表 2. Change in LED Current With HRPWM Steps for PWM Dimming at 30 kHz at 28-V Input Voltage for Green LED String

MEP STEPS	EXACT DUTY CYCLE	I <sub>LED</sub> (mA)	ΔI <sub>LED</sub> (mA)
1	50.001%	334.7993	—
11	50.006%	334.8280	0.0287
21	50.011%	334.8647	0.0367
31	50.017%	334.9031	0.0384



**表 2. Change in LED Current With HRPWM Steps for PWM Dimming at 30 kHz at 28-V Input Voltage for Green LED String (continued)**

MEP STEPS	EXACT DUTY CYCLE	$I_{LED}$ (mA)	$\Delta I_{LED}$ (mA)
41	50.022%	334.9412	0.0381
51	50.028%	334.9827	0.0415
61	50.033%	335.0220	0.0393
71	50.039%	335.0678	0.0458
81	50.044%	335.0969	0.0291
91	50.049%	335.1416	0.0447



**图 17.  $I_{LED}$  versus MEP Steps for Green LED String at 30-kHz PWM Dimming Frequency**

表 3 shows the data captured for the change in LED current when changing the MEP steps for a shunt dimming frequency of 30 kHz.

**表 3. Change in LED Current With HRPWM Steps for Shunt Dimming at 30 kHz at 28-V Input Voltage for Green LED String**

MEP STEPS	EXACT DUTY CYCLE (%)	$I_{LED}$ (mA)	$\Delta I_{LED}$ (mA)
1	50.001	349.6353	—
11	50.006	349.6610	0.0257
21	50.011	349.6850	0.0240
31	50.017	349.7061	0.0211
41	50.022	349.7293	0.0232
51	50.028	349.7524	0.0231
61	50.033	349.7777	0.0253
71	50.039	349.7948	0.0171
81	50.044	349.8206	0.0258
91	50.000	349.8493	0.0287

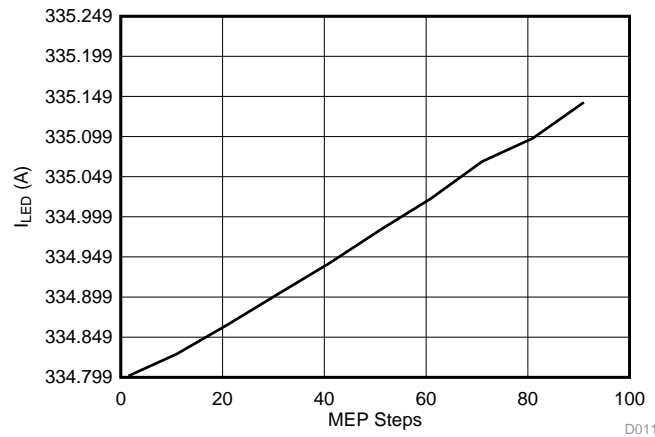

图 18.  $I_{LED}$  versus MEP Steps for Green LED String at 30-kHz Shunt Dimming Frequency

Similarly, LED current for other strings also can be varied with a change in MEP steps to achieve a 16-bit resolution for the entire system.

## 3 Hardware, Software, Testing Requirements, and Test Results

### 3.1 Hardware

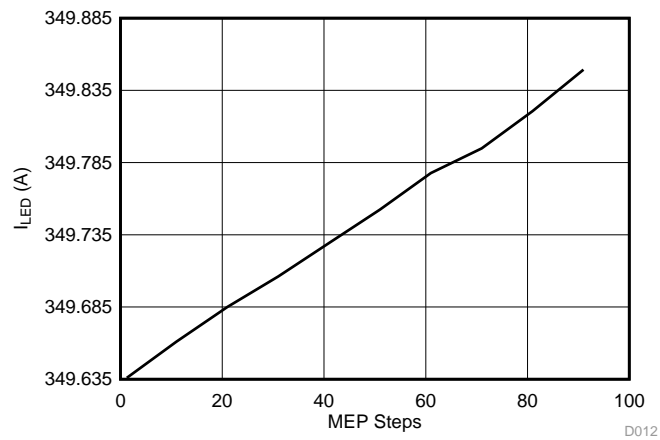
To test and obtain the results for this TI Design, the following hardware tools were used:

- DC power supply (0V to 42V and 0A to 2.8A)
- 6½ digit multimeter (x2)
- Isolated oscilloscope (4 channels)
- [TIDA-01415 PCB](#)
- [LAUNCHXL-F28027](#)

### 3.2 Software

To test and obtain the results for this TI Design, the following software tools were used:

- [Code Composer Studio™ version 6.1.2.00015 or higher](#)
- [controlSUITE™ for C2000](#)
- [GUI Composer](#)

#### 3.2.1 Setting up Firmware With TIDA-01415 and Detailed Test Procedure

The following instructions assume that CCS and GUI Composer are installed in the PC:

1. Download the firmware from the [TIDA-01415 product page](#). The firmware contains output files for analog, PWM, or shunt dimming, and an archive file of the GUI.
2. Open CCS and connect the LaunchPad to PC and turn on the power supply of TIDA-01415 PCB to input voltage above 15 V.

---

注: Remove jumpers JP1, JP2, and JP3 from the LaunchPad.

---

3. Click on the "View" option in main toolbar and open "GUI Composer".
4. In the GUI Composer Console window, go to Project and click on "Import project".
5. Browse to select the GUI.zip folder within the downloaded firmware and click "OK".
6. Click on "Preview" at the upper-right corner within the GUI Composer Console window.



图 19. Preview of GUI for TIDA-01415

7. Create a new target configuration with "User Defined File Name.ccxml" through following path: File → New → Target Configuration File.
8. Select "Texas Instruments XDS100v2 USB Debug Probe" in the "Connection" drop-down menu.
9. Select "TMS320F28027" in the "Board or Device" menu and save the file.
10. Click on "View" in the main CCS toolbar and open "Target Configurations".
11. In the Target Configurations window, select "User Defined File Name.ccxml" under the "User Defined" menu and run the debugger.
12. In the Debug Console window, right click on "User Defined File Name.ccxml" and select "Connect Target".
13. Click on the "Run" option in the main toolbar and go to Load → Load Program.

For analog dimming:

- a. After Step 14, browse for the "Analog Dimming.out" file for analog dimming and click on the "Resume" option in main CCS toolbar.
- b. Enable the " $V_{IADJ}$ ", "Channel Sel", and "Send Command" integer boxes in the GUI Preview window for analog dimming.
- c. Enter the  $V_{IADJ}$  voltage between 0 and 1.24 V depending on the desired dimming and enter the channel number in "Channel Sel" and set "Send Command" box to "1" after every change in  $V_{IADJ}$  voltage.
- d. Increase the input voltage to desired level (< 42 V for LM3409) for normal operation.

---

注: The default value for "Send Command" is set to "0", and after every successful change in  $V_{IADJ}$  voltage, the send command is automatically reset to "0".

---

For PWM or shunt dimming:

- a. Set the  $V_{IADJ}$  voltage of all strings or channels to 1.24 V before PWM or shunt dimming by following the steps in the analog dimming section.
- b. Set jumpers J1, J6, J8, and J12 in position 1 and 2 to perform PWM dimming or in position 2 and 3 on the TIDA-01415 board to perform shunt dimming.
- c. Browse for the "PWM or Shunt Dimming.out" file and click on the "Resume" option in the main CCS toolbar.
- d. For PWM or shunt dimming, the "PWM frequency", "Duty cycle" and "HRPWM steps" inputs are enabled for all the strings in GUI preview.
- e. Increase the input voltage to desired level (< 42 V for LM3409) for normal operation.
- f. Vary the duty cycle from 0% to 100% (no brightness to full brightness) to perform PWM dimming and change the HRPWM steps to achieve a 16-bit resolution for dimming.
- g. Vary the duty cycle from 0% to 100% (full brightness to no brightness) to perform shunt dimming and change the HRPWM steps to achieve a 16-bit resolution for dimming.

### 3.3 Testing and Results

An RGBW LED load with the part number 897-LZPL0MD000000 is connected at the output of the TIDA-01415 for characterization and capturing waveforms.

#### 3.3.1 Test Setup

图 20 shows the hardware interconnections needed for the proper functioning of the TIDA-01415 design.

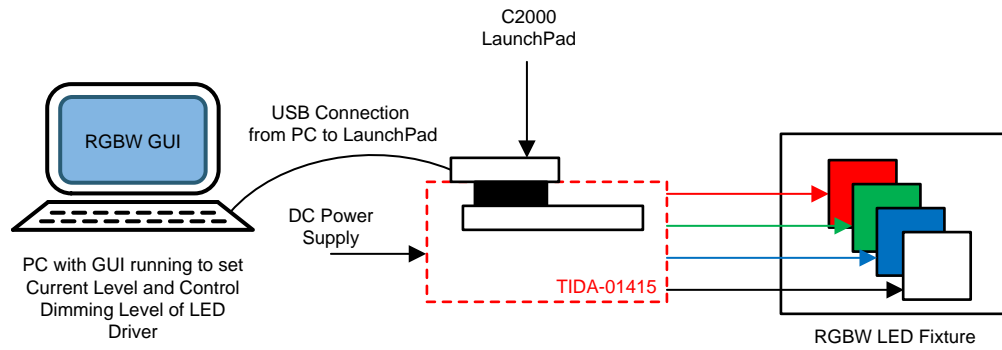

Copyright © 2017, Texas Instruments Incorporated

图 20. Hardware Interconnections of TIDA-01415

The TIDA-01415 connects as a BoosterPack™ upon the C2000 LaunchPad. Both of these boards should be assembled as shown in 图 21:



图 21. C2000 LaunchPad Mounted on TIDA-01415 LED Driver Board

### 3.3.2 Test Procedure

图 22 shows the test flow followed to perform analog, PWM, or shunt dimming:

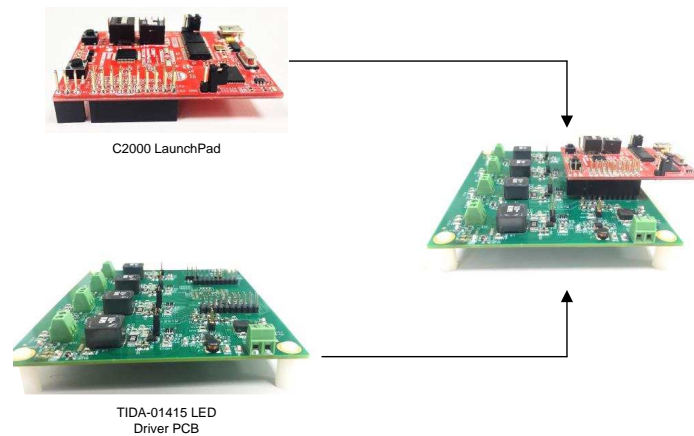

图 22. Test Flow to Perform Analog Dimming and PWM or Shunt Dimming Through TIDA-01415

### 3.3.3 Test Results

This section provides characterization data and waveforms for Current control/dimming based on 1) Analog, 2) PWM and 3) Shunt FET methods

#### 3.3.3.1 Efficiency and Output LED Current With $I_{ADJ}$ Pin (Analog Dimming)

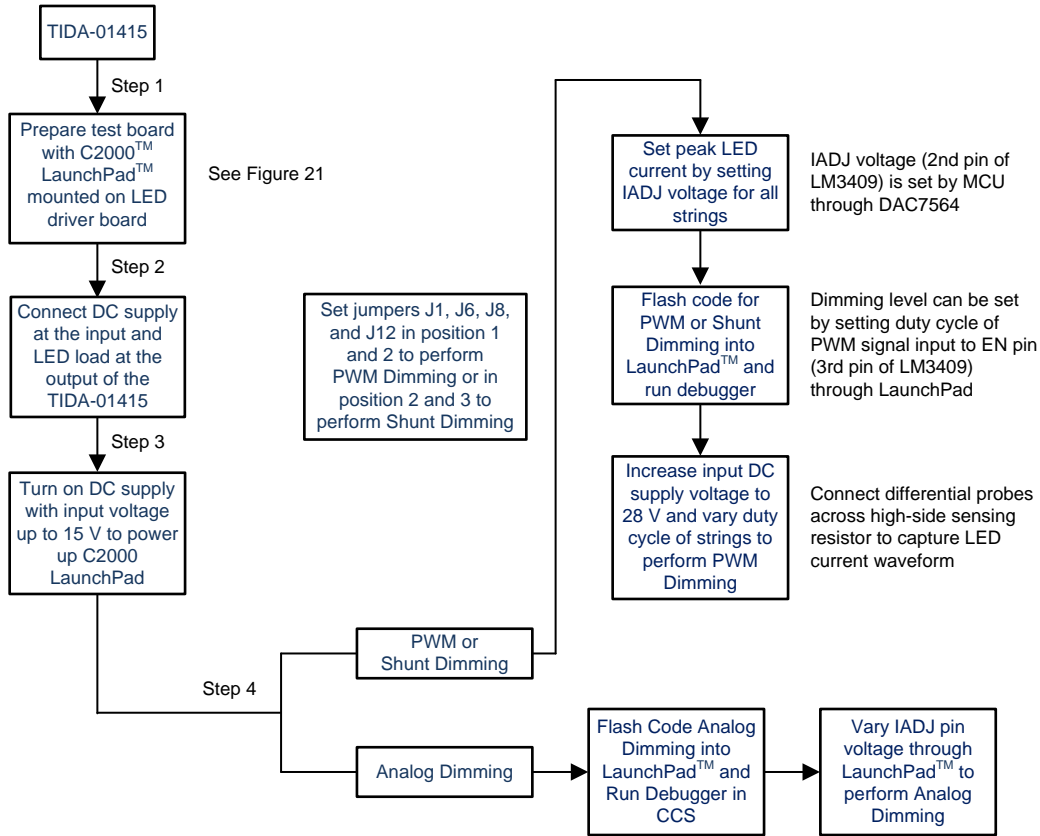
This section provides test data for variations in LED current with a change in  $I_{ADJ}$  voltage (second pin of LM3409) to perform analog dimming for all strings.

表 4. Analog Dimming Data for Red LED String

$I_{ADJ}$ (V)	$V_{IN}$ (V)	$I_{IN}$ (A)	$V_{OUT}$ (V)	$I_{LED}$ (A)	$P_{OUT}$ (W)	$P_{IN}$ (W)	EFF
1.240	27.67	0.4740	15.30	0.71500	10.93	13.11	83.41%
1.130	27.70	0.4250	14.95	0.64700	9.67	11.77	82.16%
1.030	27.73	0.3780	14.55	0.57800	8.40	10.48	80.23%
0.950	27.75	0.3430	14.25	0.52400	7.46	9.51	78.45%
0.820	27.78	0.2850	13.69	0.43500	5.95	7.91	75.22%
0.713	27.77	0.2370	13.21	0.37548	4.96	6.58	75.36%
0.712	27.77	0.2370	13.22	0.37489	4.95	6.58	75.30%
0.710	27.80	0.2500	13.33	0.37000	4.93	6.95	70.97%
0.610	27.82	0.2110	12.91	0.30500	3.93	5.87	67.08%
0.500	27.68	0.1760	12.48	0.23700	2.95	4.80	60.71%
0.400	27.73	0.1420	12.02	0.17000	2.04	3.93	51.89%
0.290	27.78	0.1100	11.39	0.10500	1.19	3.05	39.14%
0.189	27.78	0.0740	9.63	0.05328	0.51	2.05	24.96%
0.188	27.82	0.0875	9.72	0.05500	0.53	2.43	21.80%
0.100	27.84	0.0744	8.71	0.02700	0.23	2.07	11.35%
0.080	27.84	0.0712	8.21	0.02100	0.17	1.98	8.62%
0.040	27.84	0.0694	7.89	0.01700	0.13	1.93	6.78%
0.010	27.84	0.0695	7.89	0.01700	0.13	1.93	6.77%



图 23.  $I_{LED}$  (A) versus  $I_{ADJ}$  (V) for Red LED String



**表 5. Analog Dimming Data for Green LED String**

$I_{ADJ}$ (V)	$V_{IN}$ (V)	$I_{IN}$ (A)	$V_{OUT}$ (V)	$I_{LED}$ (A)	$P_{OUT}$ (W)	$P_{IN}$ (W)	EFF
1.240	27.84	0.5900	20.89	0.708000	14.79	16.42	90.04%
1.130	27.64	0.5290	20.62	0.638000	13.15	14.62	89.97%
1.030	27.67	0.4710	20.34	0.570000	11.59	13.03	88.96%
0.920	27.70	0.4140	20.05	0.502000	10.06	11.46	87.77%
0.820	27.74	0.3580	19.75	0.433000	8.55	9.93	86.11%
0.711	27.70	0.3050	19.42	0.366080	7.10	8.44	84.15%
0.710	27.77	0.3040	19.42	0.365000	7.08	8.44	83.96%
0.610	27.80	0.2510	19.07	0.296000	5.64	6.97	80.90%
0.500	27.83	0.2010	18.68	0.228000	4.25	5.59	76.14%
0.400	27.72	0.1530	18.22	0.161000	2.93	4.24	69.17%
0.290	27.78	0.1100	17.31	0.099000	1.71	3.05	56.08%
0.188	27.83	0.0790	15.02	0.054600	0.82	2.19	37.30%
0.100	27.85	0.0662	14.09	0.028300	0.39	1.84	21.63%
0.080	27.85	0.0620	13.80	0.020800	0.28	1.72	16.62%
0.040	27.86	0.0610	13.59	0.016700	0.22	1.69	13.35%
0.011	27.84	0.0690	7.87	0.013883	0.10	1.92	5.69%
0.010	27.84	0.0690	7.87	0.013920	0.10	1.92	5.70%
0.009	27.84	0.0690	7.87	0.013920	0.10	1.92	5.70%

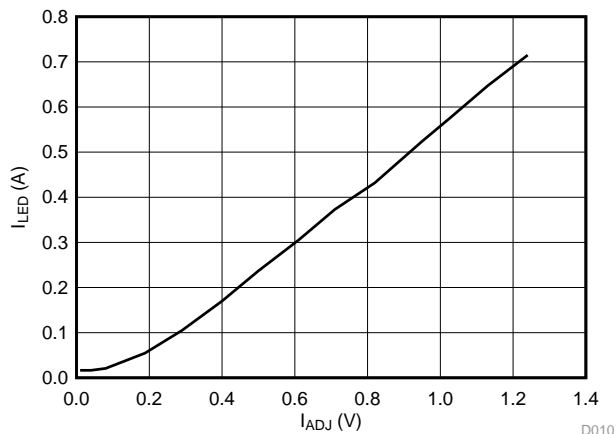
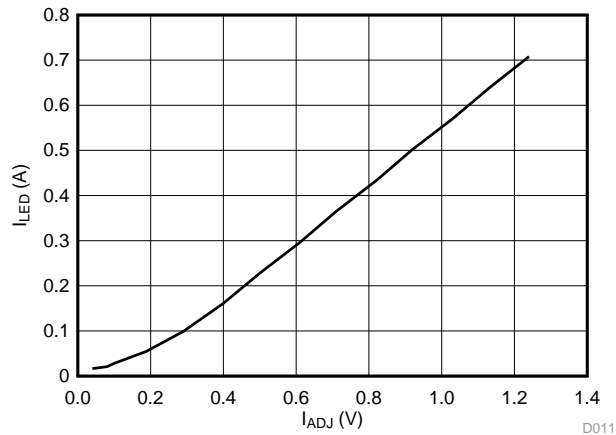
**图 24.  $I_{LED}$  (A) versus  $I_{ADJ}$  (V) for Green LED String**

**表 6. Analog Dimming Data for Blue LED String**

$I_{ADJ}$ (V)	$V_{IN}$ (V)	$I_{IN}$ (A)	$V_{OUT}$ (V)	$I_{LED}$ (A)	$P_{OUT}$ (W)	$P_{IN}$ (W)	EFF
1.240	27.62	0.5550	18.91	0.70500	13.30	15.32	86.97%
1.130	27.65	0.5030	18.65	0.63500	11.84	13.90	85.15%
1.030	27.68	0.4490	18.38	0.56700	10.42	12.42	83.85%
0.920	27.71	0.3970	18.11	0.49800	9.01	11.00	81.98%
0.820	27.74	0.3470	17.84	0.43000	7.67	9.62	79.69%
0.710	27.77	0.2880	17.56	0.36451	6.40	7.99	80.03%
0.708	27.70	0.2870	17.52	0.36385	6.37	7.94	80.19%
0.707	27.71	0.2870	17.52	0.36348	6.36	7.95	80.07%
0.610	27.80	0.2520	17.26	0.29400	5.07	7.00	72.43%
0.500	27.83	0.2070	16.94	0.22700	3.84	5.76	66.75%
0.400	27.70	0.1640	16.59	0.16100	2.67	4.54	58.80%
0.290	27.76	0.1240	16.02	0.09770	1.56	3.44	45.47%
0.188	27.80	0.0958	14.02	0.05380	0.75	2.66	28.32%
0.100	27.82	0.0843	13.27	0.02660	0.35	2.34	15.05%
0.080	27.82	0.0827	13.19	0.02280	0.30	2.30	13.07%
0.040	27.83	0.0807	13.02	0.01780	0.23	2.24	10.32%
0.010	27.83	0.0805	13.00	0.01720	0.22	2.24	9.98%



**图 25.  $I_{LED}$  (A) versus  $I_{ADJ}$  (V) for Blue LED String**

表 7. Analog Dimming Data for White LED String

$I_{ADJ}$ (V)	$V_{IN}$ (V)	$I_{IN}$ (A)	$V_{OUT}$ (V)	$I_{LED}$ (A)	$P_{OUT}$ (W)	$P_{IN}$ (W)	EFF
1.240	27.52	0.7340	23.76	0.76881	18.26	20.199680	90.43%
1.130	27.56	0.6600	23.68	0.69776	16.52	18.189600	90.84%
1.030	27.61	0.5880	23.34	0.62695	14.63	16.234680	90.13%
0.920	27.64	0.5220	23.00	0.55903	12.85	14.428080	89.12%
0.820	27.68	0.4580	22.65	0.49220	11.14	12.677440	87.94%
0.710	27.72	0.3958	22.28	0.42370	9.44	10.971576	86.04%
0.610	27.75	0.3391	21.96	0.36019	7.90	9.410025	84.06%
0.500	27.79	0.2760	21.42	0.28731	6.15	7.670040	80.24%
0.400	27.82	0.2210	20.98	0.22073	4.63	6.148220	75.32%
0.290	27.70	0.1690	20.35	0.15473	3.14	4.680000	67.26%
0.188	27.77	0.1235	19.49	0.09115	1.77	3.420000	51.80%
0.100	27.81	0.9330	17.28	0.04643	0.82	2.590000	30.09%
0.080	27.82	0.0885	16.46	0.03744	0.61	2.460000	25.03%
0.040	27.82	0.0896	15.39	0.02539	0.39	2.490000	15.68%
0.010	27.83	0.0905	15.29	0.02530	0.38	2.510000	15.36%

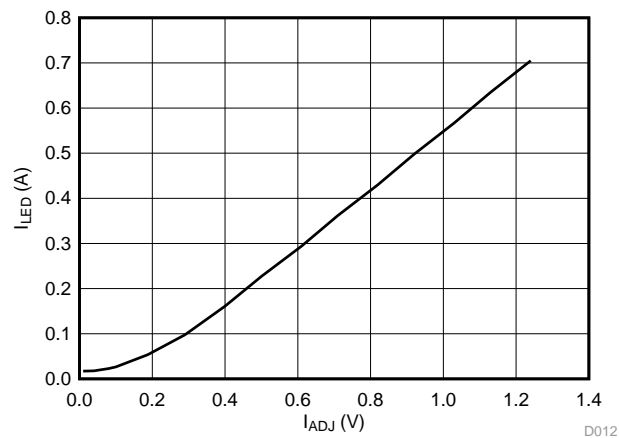

图 26.  $I_{LED}$  (A) versus  $I_{ADJ}$  (V) for White LED String

### 3.3.3.2 Efficiency and Output LED Current for PWM or Shunt Dimming at 30 kHz

This section provides test data for variations in LED current with changes in the duty cycle of the PWM input of 30 kHz to EN pin (third pin of LM3409) and the gate driver (UCC27511) to perform PWM or shunt dimming, respectively, for all strings.

**3.3.3.2.1 PWM or Shunt Dimming at 30 kHz**
**表 8. PWM Dimming Data for Red LED String at 30-kHz PWM Frequency**

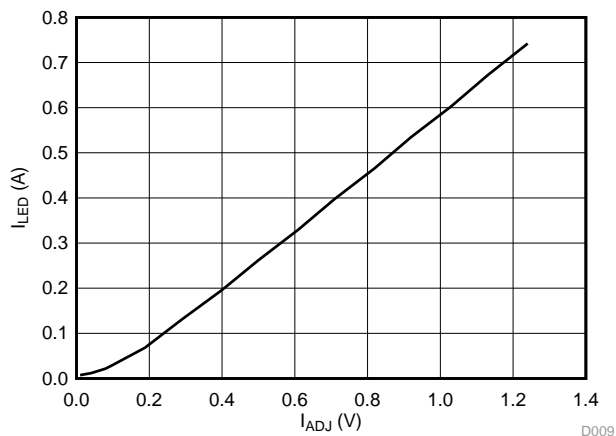
DUTY CYCLE	V <sub>IN</sub> (V)	I <sub>IN</sub> (A)	V <sub>OUT</sub> (V)	I <sub>LED</sub> (A)	P <sub>OUT</sub> (W)	P <sub>IN</sub> (W)	EFF
100.0%	28	0.4420	16.7	0.71800	11.991	12.38	96.89%
90.0%	28	0.4010	16.7	0.65100	10.872	11.23	96.83%
80.0%	28	0.3590	16.7	0.57800	9.653	10.05	96.03%
70.0%	28	0.3160	16.7	0.50300	8.400	8.85	94.94%
60.0%	28	0.2730	16.7	0.42900	7.164	7.64	93.72%
50.0%	28	0.2310	16.7	0.35500	5.929	6.47	91.66%
40.0%	28	0.1880	16.7	0.28300	4.726	5.26	89.78%
30.0%	28	0.1470	16.7	0.21200	3.540	4.12	86.02%
20.0%	28	0.1040	16.7	0.14100	2.355	2.91	80.86%
15.0%	28	0.0852	16.7	0.10500	1.754	2.39	73.50%
10.0%	28	0.0673	16.7	0.06880	1.149	1.88	60.97%
5.0%	28	0.0384	16.7	0.02980	0.498	1.08	46.29%
3.0%	28	0.0297	15.7	0.01250	0.196	0.83	23.60%
1.0%	28	0.0247	15.5	0.00200	0.031	0.69	4.48%
0.8%	28	0.0244	15.3	0.00144	0.022	0.68	3.22%
0.6%	28	0.0242	15.1	0.00096	0.014	0.68	2.14%
0.4%	28	0.0241	14.9	0.00058	0.009	0.67	1.28%
0.1%	28	0.0237	14.1	0.00020	0.003	0.66	0.42%

**表 9. Shunt Dimming Data for Red LED String at 30-kHz Shunt PWM Frequency**

DUTY CYCLE	V <sub>IN</sub> (V)	I <sub>IN</sub> (A)	V <sub>OUT</sub> (V)	I <sub>LED</sub> (A)	P <sub>OUT</sub> (W)	P <sub>IN</sub> (W)	EFF
100.00%	28	0.4700	16.7	0.71700	11.97	13.1600	90.99%
90.00%	28	0.4310	16.7	0.64600	10.79	12.0700	89.40%
80.00%	28	0.3900	16.7	0.57300	9.57	10.9200	87.63%
70.00%	28	0.3490	16.7	0.50000	8.35	9.7700	85.45%
60.00%	28	0.3080	16.7	0.42800	7.15	8.6200	82.88%
50.00%	28	0.2650	16.7	0.35600	5.95	7.4200	80.12%
40.00%	28	0.2240	16.7	0.28100	4.69	6.2700	74.82%
30.00%	28	0.1830	16.7	0.20900	3.49	5.1200	68.12%
20.00%	28	0.1410	16.7	0.13500	2.25	3.9500	57.10%
10.00%	28	0.1010	16.7	0.06180	1.03	2.8300	36.49%
8.00%	28	0.0929	16.7	0.04900	0.82	2.6000	31.46%
5.00%	28	0.0785	16.7	0.02570	0.43	2.2000	19.53%
3.00%	28	0.0709	16.7	0.01260	0.21	1.9900	10.60%
2.00%	28	0.0682	16.7	0.00784	0.13	1.9100	6.86%
1.00%	28	0.0662	16.7	0.00552	0.09	1.8500	4.97%
0.80%	28	0.0629	16.7	0.00383	0.06	1.7600	3.63%
0.50%	28	0.0603	16.7	0.00093	0.02	1.6900	0.92%
0.30%	28	0.6020	16.7	0.00083	0.01	16.8600	0.08%
0.11%	28	0.0591	16.7	-0.00008	—	1.6548	—



图 27.  $I_{LED}$  (A) versus Duty Cycle (%) for PWM or Shunt Dimming at 30 kHz for Red LED String

表 10. PWM Dimming Data for Green LED String at 30-kHz PWM Frequency

DUTY CYCLE	$V_{IN}$ (V)	$I_{IN}$ (A)	$V_{OUT}$ (V)	$I_{LED}$ (A)	$P_{OUT}$ (W)	$P_{IN}$ (W)	EFF
100.0%	28	0.5840	22.2	0.70800	15.718	16.35	96.12%
90.0%	28	0.5120	22.2	0.62700	13.919	14.34	97.09%
80.0%	28	0.4600	22.2	0.55100	12.232	12.88	94.97%
70.0%	28	0.4080	22.2	0.48300	10.723	11.42	93.86%
60.0%	28	0.3480	22.2	0.40900	9.080	9.74	93.18%
50.0%	28	0.2970	22.2	0.34200	7.592	8.32	91.30%
40.0%	28	0.2350	22.2	0.26500	5.883	6.58	89.41%
30.0%	28	0.1840	22.2	0.19600	4.351	5.15	84.46%
20.0%	28	0.1210	22.2	0.12200	2.708	3.39	79.94%
15.0%	28	0.0885	22.2	0.09000	1.998	2.48	80.63%
10.0%	28	0.0569	22.2	0.04780	1.061	1.59	66.61%
5.0%	28	0.0343	22.2	0.01560	0.346	0.96	36.06%
3.0%	28	0.0284	22.2	0.00666	0.148	0.80	18.59%
1.0%	28	0.0246	22.1	0.00115	0.025	0.69	3.69%
0.8%	28	0.0244	21.7	0.00080	0.017	0.68	2.54%
0.6%	28	0.0242	21.1	0.00050	0.011	0.68	1.56%
0.4%	28	0.0240	19.7	0.00025	0.005	0.67	0.73%
0.3%	28	0.0239	18.7	0.00015	0.003	0.67	0.42%
0.2%	28	0.0239	18.1	0.00009	0.002	0.67	0.24%

表 11. Shunt Dimming Data for Green LED String at 30-kHz Shunt PWM Frequency

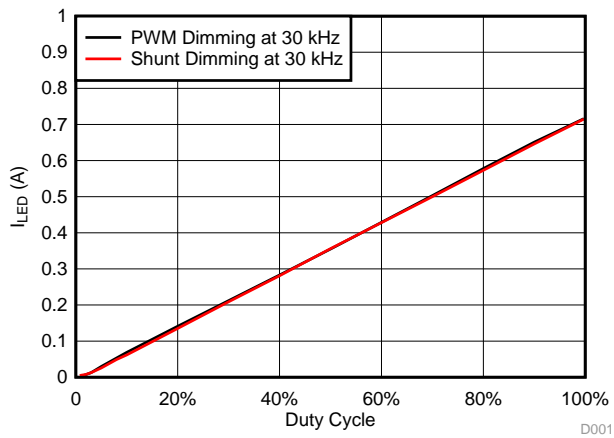
DUTY CYCLE	$V_{IN}$ (V)	$I_{IN}$ (A)	$V_{OUT}$ (V)	$I_{LED}$ (A)	$P_{OUT}$ (W)	$P_{IN}$ (W)	EFF
100.00%	28	0.6140	22.2	0.711000	15.784	17.19	91.81%
90.00%	28	0.5600	22.2	0.638000	14.164	15.68	90.33%
80.00%	28	0.5060	22.2	0.567000	12.587	14.17	88.84%
70.00%	28	0.4510	22.2	0.494000	10.967	12.63	86.85%
60.00%	28	0.3950	22.2	0.420000	9.324	11.06	84.30%
50.00%	28	0.3400	22.2	0.350000	7.770	9.52	81.62%
40.00%	28	0.2820	22.2	0.275000	6.105	7.90	77.32%
30.00%	28	0.2250	22.2	0.203000	4.507	6.30	71.53%
20.00%	28	0.1670	22.2	0.130000	2.886	4.68	61.72%

表 11. Shunt Dimming Data for Green LED String at 30-kHz Shunt PWM Frequency (continued)

DUTY CYCLE	V <sub>IN</sub> (V)	I <sub>IN</sub> (A)	V <sub>OUT</sub> (V)	I <sub>LED</sub> (A)	P <sub>OUT</sub> (W)	P <sub>IN</sub> (W)	EFF
10.00%	28	0.1080	22.2	0.057900	1.285	3.02	42.51%
8.00%	28	0.0950	22.2	0.041800	0.928	2.66	34.89%
5.00%	28	0.0800	22.2	0.021700	0.482	2.24	21.51%
3.00%	28	0.0720	22.2	0.011100	0.246	2.02	12.22%
2.00%	28	0.0690	22.2	0.006740	0.150	1.93	7.74%
1.00%	28	0.0660	22.2	0.002930	0.065	1.85	3.52%
0.80%	28	0.0662	22.2	0.003870	0.086	1.85	4.63%
0.50%	28	0.0605	22.2	0.000220	0.005	1.69	0.29%
0.30%	28	0.0604	22.2	-0.000115	—	1.69	—
0.11%	28	0.0591	22.2	-0.000300	—	1.65	—



图 28. I<sub>LED</sub> (A) versus Duty Cycle (%) for PWM or Shunt Dimming at 30 kHz for Green LED String

表 12. PWM Dimming Data for Blue LED String at 30-kHz PWM Frequency

DUTY CYCLE	V <sub>IN</sub> (V)	I <sub>IN</sub> (A)	V <sub>OUT</sub> (V)	I <sub>LED</sub> (A)	P <sub>OUT</sub> (W)	P <sub>IN</sub> (W)	EFF
100.0%	28	0.5320	19.9	0.70900	14.109	14.90	94.72%
90.0%	28	0.4760	19.9	0.63200	12.577	13.33	94.36%
80.0%	28	0.4220	19.9	0.55600	11.064	11.82	93.64%
70.0%	28	0.3700	19.9	0.48100	9.572	10.36	92.39%
60.0%	28	0.3210	19.9	0.41200	8.199	8.99	91.22%
50.0%	28	0.2720	19.9	0.34400	6.846	7.62	89.88%
40.0%	28	0.2230	19.9	0.27700	5.512	6.24	88.28%
30.0%	28	0.1700	19.9	0.20300	4.040	4.76	84.87%
20.0%	28	0.1140	19.9	0.12600	2.507	3.19	78.55%
10.0%	28	0.0621	19.9	0.06000	1.194	1.74	68.67%
5.0%	28	0.0354	19.9	0.01860	0.370	0.99	37.34%
3.0%	28	0.0287	19.1	0.00782	0.149	0.80	18.59%
2.0%	28	0.0263	18.7	0.00397	0.074	0.74	10.08%
1.0%	28	0.0246	18.6	0.00127	0.024	0.69	3.43%
0.8%	28	0.0244	18.5	0.00089	0.016	0.68	2.41%
0.5%	28	0.0241	18.3	0.00041	0.008	0.67	1.11%
0.3%	28	0.0240	17.9	0.00019	0.003	0.67	0.51%
0.2%	28	0.0239	17.1	0.00012	0.002	0.67	0.31%

表 13. Shunt Dimming Data for Blue LED String at 30-kHz Shunt PWM Frequency

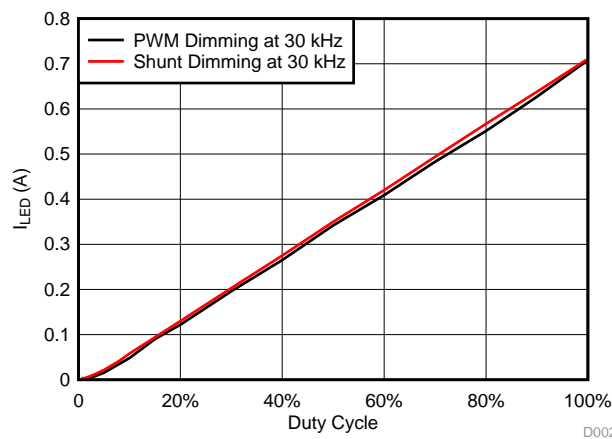
DUTY CYCLE	V <sub>IN</sub> (V)	I <sub>IN</sub> (A)	V <sub>OUT</sub> (V)	I <sub>LED</sub> (A)	P <sub>OUT</sub> (W)	P <sub>IN</sub> (W)	EFF
100.00%	28	0.5610	19.9	0.70900	14.11	15.71	89.82%
90.00%	28	0.5110	19.9	0.63700	12.68	14.31	88.60%
80.00%	28	0.4620	19.9	0.56500	11.24	12.94	86.92%
70.00%	28	0.4120	19.9	0.49200	9.79	11.54	84.87%
60.00%	28	0.3610	19.9	0.41900	8.34	10.11	82.49%
50.00%	28	0.3110	19.9	0.34700	6.91	8.71	79.30%
40.00%	28	0.2600	19.9	0.27600	5.49	7.28	75.45%
30.00%	28	0.2090	19.9	0.20400	4.06	5.85	69.37%
20.00%	28	0.1560	19.9	0.13300	2.65	4.37	60.59%
10.00%	28	0.1060	19.9	0.05920	1.18	2.97	39.69%
5.00%	28	0.0800	19.9	0.02240	0.45	2.24	19.90%
3.00%	28	0.0720	19.9	0.01070	0.21	2.02	10.56%
2.00%	28	0.0680	19.9	0.00615	0.12	1.90	6.43%
1.00%	28	0.0663	19.9	0.00216	0.04	1.86	2.32%
0.50%	28	0.0602	19.9	0.00061	0.01	1.69	0.72%
0.30%	28	0.0601	19.9	0.00060	0.01	1.68	0.71%
0.11%	28	0.0591	19.9	-0.00044	—	1.65	—



图 29. I<sub>LED</sub> (A) versus Duty Cycle (%) for PWM or Shunt Dimming at 30 kHz for Blue LED String

表 14. PWM Dimming Data for White LED String at 30-kHz PWM Frequency

DUTY CYCLE	V <sub>IN</sub> (V)	I <sub>IN</sub> (A)	V <sub>OUT</sub> (V)	I <sub>LED</sub> (A)	P <sub>OUT</sub> (W)	P <sub>IN</sub> (W)	EFF
100.0%	28	0.6960	25.1	0.710000	17.821	19.49	91.45%
90.0%	28	0.5920	25.1	0.631000	15.838	16.58	95.55%
80.0%	28	0.5290	25.1	0.559000	14.031	14.81	94.73%
70.0%	28	0.4600	25.1	0.481000	12.073	12.88	93.74%
60.0%	28	0.3920	25.1	0.404000	10.140	10.98	92.39%
50.0%	28	0.3270	25.1	0.333000	8.358	9.16	91.29%
40.0%	28	0.2570	25.1	0.256000	6.426	7.20	89.29%
30.0%	28	0.1860	25.1	0.180000	4.518	5.21	86.75%
20.0%	28	0.0988	25.1	0.098700	2.477	2.77	89.55%
10.0%	28	0.0494	25.1	0.034900	0.876	1.38	63.33%
5.0%	28	0.0324	23.7	0.011300	0.268	0.91	29.52%
3.0%	28	0.0277	22.9	0.005000	0.115	0.78	14.76%

表 14. PWM Dimming Data for White LED String at 30-kHz PWM Frequency (continued)

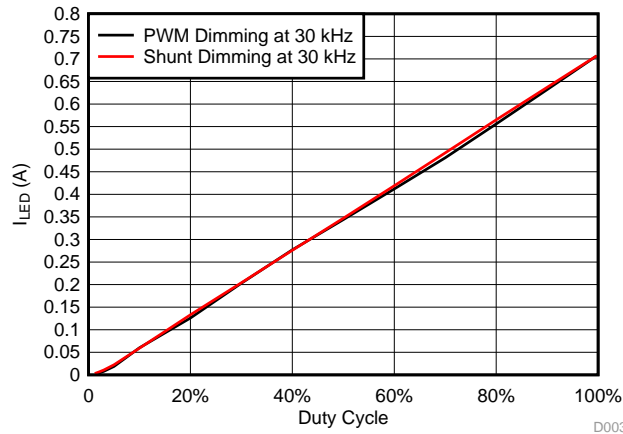
DUTY CYCLE	V <sub>IN</sub> (V)	I <sub>IN</sub> (A)	V <sub>OUT</sub> (V)	I <sub>LED</sub> (A)	P <sub>OUT</sub> (W)	P <sub>IN</sub> (W)	EFF
2.0%	28	0.0259	22.7	0.002700	0.061	0.73	8.45%
1.0%	28	0.0246	22.6	0.000920	0.021	0.69	3.02%
0.8%	28	0.0244	22.4	0.000650	0.015	0.68	2.13%
0.6%	28	0.0242	22.2	0.000400	0.009	0.68	1.31%
0.4%	28	0.0240	22.0	0.000190	0.004	0.67	0.62%
0.2%	28	0.0239	20.7	0.000065	0.001	0.67	0.20%

表 15. Shunt Dimming Data for White LED String at 30-kHz Shunt PWM Frequency

DUTY CYCLE	V <sub>IN</sub> (V)	I <sub>IN</sub> (A)	V <sub>OUT</sub> (V)	I <sub>LED</sub> (A)	P <sub>OUT</sub> (W)	P <sub>IN</sub> (W)	EFF
100.00%	28	0.7240	25.1	0.74500	18.700	20.27	92.24%
90.00%	28	0.6590	25.1	0.66800	16.767	18.45	90.87%
80.00%	28	0.5950	25.1	0.59200	14.859	16.66	89.19%
70.00%	28	0.5270	25.1	0.51500	12.927	14.76	87.60%
60.00%	28	0.4620	25.1	0.44000	11.044	12.94	85.37%
50.00%	28	0.3930	25.1	0.36200	9.086	11.00	82.57%
40.00%	28	0.3240	25.1	0.28500	7.154	9.07	78.85%
30.00%	28	0.2540	25.1	0.20900	5.246	7.11	73.76%
20.00%	28	0.1830	25.1	0.13100	3.288	5.12	64.17%
10.00%	28	0.1080	25.1	0.05220	1.310	3.02	43.33%
5.00%	28	0.0830	25.1	0.02120	0.532	2.32	22.90%
3.00%	28	0.0745	25.1	0.01100	0.276	2.09	13.24%
2.00%	28	0.0707	25.1	0.00638	0.160	1.98	8.09%
1.00%	28	0.0671	25.1	0.00210	0.053	1.88	2.81%
0.80%	28	0.0663	25.1	0.00168	0.042	1.86	2.27%
0.50%	28	0.0653	25.1	0.00105	0.026	1.83	1.44%
0.30%	28	0.0632	25.1	0.00014	0.004	1.77	0.20%
0.11%	28	0.0591	25.1	-0.00035	—	1.65	—



图 30. I<sub>LED</sub> (A) versus Duty Cycle (%) for PWM or Shunt Dimming at 30 kHz for White LED String

注: The test results for shunt dimming shows better deep dimming capability and linear characteristics as compared to PWM dimming at a 30-kHz dimming frequency.

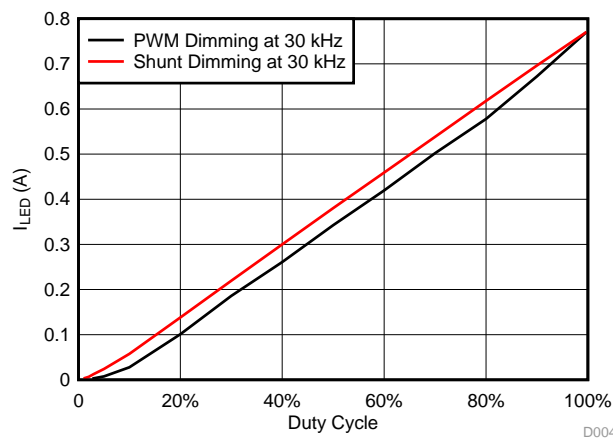

**3.3.3.2.2 PWM or Shunt Dimming at 50 kHz**
**表 16. PWM Dimming Data for Red LED String at 50-kHz PWM Frequency**

DUTY CYCLE	V <sub>IN</sub> (V)	I <sub>IN</sub> (A)	V <sub>OUT</sub> (V)	I <sub>LED</sub> (A)	P <sub>OUT</sub> (W)	P <sub>IN</sub> (W)	EFF
100.00%	28	0.4470	16.7	0.71800	11.991	12.52	95.80%
90.00%	28	0.4090	16.7	0.66200	11.055	11.45	96.54%
80.00%	28	0.3610	16.7	0.59000	9.853	10.11	97.48%
70.00%	28	0.3270	16.7	0.52000	8.684	9.16	94.84%
60.00%	28	0.2790	16.7	0.43500	7.265	7.81	92.99%
50.00%	28	0.2320	16.7	0.35300	5.895	6.50	90.75%
40.00%	28	0.1970	16.7	0.29500	4.927	5.52	89.31%
30.00%	28	0.1600	16.7	0.23000	3.841	4.48	85.74%
20.00%	28	0.1100	16.7	0.14600	2.438	3.08	79.16%
10.00%	28	0.0630	16.7	0.06740	1.126	1.76	63.81%
8.00%	28	0.0510	16.7	0.04630	0.773	1.43	54.15%
5.00%	28	0.0370	16.7	0.02070	0.346	1.04	33.37%
3.00%	28	0.0319	16.7	0.00868	0.145	0.89	16.23%
2.00%	28	0.2990	16.7	0.00445	0.074	8.37	0.89%
1.00%	28	0.2860	16.7	0.00160	0.027	8.01	0.33%
0.80%	28	0.2840	16.7	0.00125	0.021	7.95	0.26%
0.50%	28	0.0280	16.7	0.00074	0.012	0.78	1.58%
0.30%	28	0.0281	16.7	0.00056	0.009	0.79	1.19%
0.20%	28	0.0281	16.7	0.00050	0.008	0.79	1.06%
0.15%	28	0.0270	16.7	0.00041	0.007	0.76	0.91%
0.10%	28	0.0270	16.7	0.00040	0.007	0.76	0.88%

**表 17. Shunt Dimming Data for Red LED String at 50-kHz Shunt PWM Frequency**

DUTY CYCLE	V <sub>IN</sub> (V)	I <sub>IN</sub> (A)	V <sub>OUT</sub> (V)	I <sub>LED</sub> (A)	P <sub>OUT</sub> (W)	P <sub>IN</sub> (W)	EFF
100.0%	28	0.482	16.7	0.71800	11.99	13.50	88.85%
90.0%	28	0.443	16.7	0.64700	10.80	12.40	87.11%
80.0%	28	0.402	16.7	0.57500	9.60	11.26	85.31%
70.0%	28	0.361	16.7	0.50100	8.37	10.11	82.77%
60.0%	28	0.320	16.7	0.42700	7.13	8.96	79.59%
50.0%	28	0.277	16.7	0.35600	5.95	7.76	76.65%
40.0%	28	0.238	16.7	0.28200	4.71	6.66	70.67%
30.0%	28	0.196	16.7	0.20700	3.46	5.49	62.99%
20.0%	28	0.153	16.7	0.13600	2.27	4.28	53.02%
15.0%	28	0.133	16.7	0.09860	1.65	3.72	44.22%
10.0%	28	0.110	16.7	0.06420	1.07	3.08	34.81%
5.0%	28	0.091	16.7	0.02610	0.44	2.55	17.11%
3.0%	28	0.085	16.7	0.01490	0.23	2.38	9.83%
1.0%	28	0.073	16.7	0.00261	0.04	2.04	1.98%
0.8%	28	0.072	16.7	0.00181	0.03	2.02	1.37%
0.6%	28	0.072	16.7	0.00176	0.03	2.02	1.32%
0.4%	28	0.072	16.7	0.00130	0.02	2.02	0.96%
0.3%	28	0.070	16.7	0.00120	0.02	1.96	0.89%
0.2%	28	0.070	16.7	-0.00011	—	1.96	—



图 31.  $I_{LED}$  (A) versus Duty Cycle (%) for PWM or Shunt Dimming at 50 kHz for Red LED String

表 18. PWM Dimming Data for Green LED String at 50-kHz PWM Frequency

DUTY CYCLE	$V_{IN}$ (V)	$I_{IN}$ (A)	$V_{OUT}$ (V)	$I_{LED}$ (A)	$P_{OUT}$ (W)	$P_{IN}$ (W)	EFF
100.00%	28	0.589	22.2	0.71000	15.762000	16.49	95.57%
90.00%	28	0.513	22.2	0.61700	13.697000	14.36	95.36%
80.00%	28	0.459	22.2	0.54700	12.143000	12.85	94.49%
70.00%	28	0.406	22.2	0.47900	10.634000	11.37	93.54%
60.00%	28	0.345	22.2	0.40100	8.902000	9.66	92.16%
50.00%	28	0.284	22.2	0.32300	7.171000	7.95	90.17%
40.00%	28	0.224	22.2	0.24600	5.461000	6.27	87.07%
30.00%	28	0.167	22.2	0.17500	3.885000	4.68	83.08%
20.00%	28	0.110	22.2	0.10600	2.353000	3.08	76.40%
15.00%	28	0.078	22.2	0.06630	1.472000	2.18	67.39%
10.00%	28	0.053	22.2	0.03390	0.753000	1.48	50.71%
5.00%	28	0.035	22.2	0.01070	0.238000	0.98	24.24%
3.00%	28	0.031	22.2	0.00470	0.104000	0.87	12.02%
1.00%	28	0.028	22.1	0.00081	0.018000	0.78	2.28%
0.80%	28	0.028	21.7	0.00060	0.013000	0.78	1.66%
0.60%	28	0.028	21.1	0.00042	0.009000	0.78	1.13%
0.40%	28	0.028	19.7	0.00022	0.004000	0.78	0.55%
0.30%	28	0.028	18.7	0.00017	0.003000	0.78	0.41%
0.20%	28	0.028	18.1	0.00013	0.002000	0.78	0.30%
0.15%	28	0.027	18.1	0.00004	0.001000	0.76	0.10%
0.10%	28	0.027	18.1	0.00004	0.000724	0.76	0.10%

表 19. Shunt Dimming Data for Green LED String at 50-kHz Shunt PWM Frequency

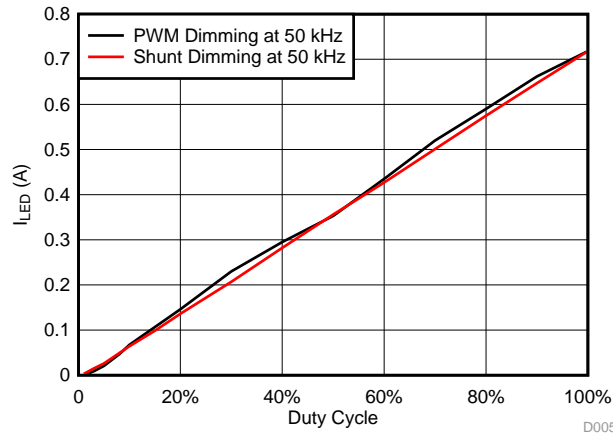
DUTY CYCLE	$V_{IN}$ (V)	$I_{IN}$ (A)	$V_{OUT}$ (V)	$I_{LED}$ (A)	$P_{OUT}$ (W)	$P_{IN}$ (W)	EFF
100.00%	28	0.627	22.2	0.71100	15.784	17.560	89.91%
90.00%	28	0.572	22.2	0.63700	14.141	16.020	88.30%
80.00%	28	0.517	22.2	0.56500	12.543	14.480	86.65%
70.00%	28	0.463	22.2	0.49300	10.945	12.960	84.42%
60.00%	28	0.410	22.2	0.42100	9.346	11.480	81.41%
50.00%	28	0.354	22.2	0.34800	7.726	9.910	77.94%
40.00%	28	0.297	22.2	0.27400	6.083	8.320	73.15%

**表 19. Shunt Dimming Data for Green LED String at 50-kHz Shunt PWM Frequency (continued)**

DUTY CYCLE	V <sub>IN</sub> (V)	I <sub>IN</sub> (A)	V <sub>OUT</sub> (V)	I <sub>LED</sub> (A)	P <sub>OUT</sub> (W)	P <sub>IN</sub> (W)	EFF
30.00%	28	0.239	22.2	0.20100	4.462	6.690	66.68%
20.00%	28	0.181	22.2	0.12800	2.842	5.070	56.07%
10.00%	28	0.123	22.2	0.05580	1.239	3.440	35.97%
8.00%	28	0.112	22.2	0.04190	0.930	3.140	29.66%
5.00%	28	0.098	22.2	0.02340	0.519	2.740	18.93%
3.00%	28	0.090	22.2	0.01330	0.295	2.520	11.72%
2.00%	28	0.086	22.2	0.00870	0.193	2.410	8.02%
1.00%	28	0.078	22.2	0.00270	0.060	2.180	2.74%
0.80%	28	0.074	22.2	0.00022	0.005	2.070	0.24%
0.50%	28	0.074	22.2	-0.00015	—	2.072	—
0.30%	28	0.073	22.2	-0.00048	—	2.044	—
0.25%	28	0.073	22.2	-0.00047	—	2.044	—
0.20%	28	0.071	22.2	-0.00036	—	1.988	—

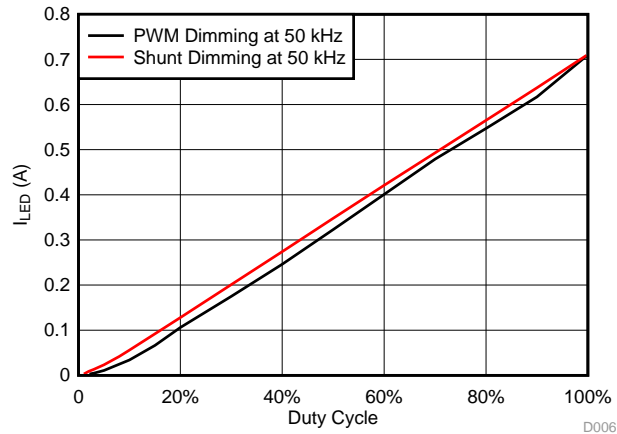
**图 32. I<sub>LED</sub> (A) versus Duty Cycle (%) for PWM or Shunt Dimming at 50 kHz for Green LED String**
**表 20. PWM Dimming Data for Blue LED String at 50-kHz PWM Frequency**

DUTY CYCLE	V <sub>IN</sub> (V)	I <sub>IN</sub> (A)	V <sub>OUT</sub> (V)	I <sub>LED</sub> (A)	P <sub>OUT</sub> (W)	P <sub>IN</sub> (W)	EFF
100.0%	28	0.540000	19.9	0.70900	14.109	15.12	93.31%
90.0%	28	0.471000	19.9	0.61700	12.278	13.19	93.10%
80.0%	28	0.417000	19.9	0.54100	10.766	11.68	92.21%
70.0%	28	0.366000	19.9	0.47000	9.353	10.25	91.27%
60.0%	28	0.315000	19.9	0.40000	7.960	8.82	90.25%
50.0%	28	0.268000	19.9	0.33500	6.667	7.50	88.84%
40.0%	28	0.219000	19.9	0.26600	5.293	6.13	86.32%
30.0%	28	0.171000	19.9	0.20100	4.000	4.79	83.54%
20.0%	28	0.120000	19.9	0.13100	2.607	3.36	77.59%
10.0%	28	0.055000	19.9	0.04100	0.816	1.54	52.98%
5.0%	28	0.036100	19.9	0.01200	0.239	1.01	23.62%
3.0%	28	0.031300	19.1	0.00536	0.102	0.88	11.68%
2.0%	28	0.029690	18.7	0.00272	0.051	0.83	6.12%
1.0%	28	0.028540	18.6	0.00089	0.017	0.80	2.07%
0.8%	28	0.028400	18.5	0.00065	0.012	0.80	1.51%
0.5%	28	0.028180	18.3	0.00030	0.005	0.79	0.70%

表 20. PWM Dimming Data for Blue LED String at 50-kHz PWM Frequency (continued)

DUTY CYCLE	V <sub>IN</sub> (V)	I <sub>IN</sub> (A)	V <sub>OUT</sub> (V)	I <sub>LED</sub> (A)	P <sub>OUT</sub> (W)	P <sub>IN</sub> (W)	EFF
0.3%	28	0.028110	17.9	0.00020	0.004	0.79	0.45%
0.2%	28	0.028074	17.1	0.00015	0.003	0.79	0.33%

表 21. Shunt Dimming Data for Blue LED String at 50-kHz Shunt PWM Frequency

DUTY CYCLE	V <sub>IN</sub> (V)	I <sub>IN</sub> (A)	V <sub>OUT</sub> (V)	I <sub>LED</sub> (A)	P <sub>OUT</sub> (W)	P <sub>IN</sub> (W)	EFF
100.00%	28	0.5723	19.9	0.70897	14.109	16.02	88.04%
90.00%	28	0.5230	19.9	0.63500	12.637	14.64	86.29%
80.00%	28	0.4730	19.9	0.56300	11.204	13.24	84.59%
70.00%	28	0.4230	19.9	0.49100	9.771	11.84	82.50%
60.00%	28	0.3730	19.9	0.41800	8.318	10.44	79.65%
50.00%	28	0.3211	19.9	0.34700	6.905	8.99	76.80%
40.00%	28	0.2688	19.9	0.27610	5.494	7.53	73.00%
30.00%	28	0.2190	19.9	0.20230	4.026	6.13	65.65%
20.00%	28	0.1683	19.9	0.12970	2.581	4.71	54.77%
10.00%	28	0.1160	19.9	0.05700	1.134	3.25	34.92%
5.00%	28	0.0922	19.9	0.02248	0.447	2.58	17.33%
3.00%	28	0.0845	19.9	0.01233	0.245	2.37	10.37%
2.00%	28	0.0814	19.9	0.00795	0.158	2.28	6.94%
1.00%	28	0.0734	19.9	0.00210	0.042	2.06	2.03%
0.70%	28	0.0730	19.9	0.00170	0.034	2.04	1.66%
0.50%	28	0.0699	19.9	-0.00089	—	1.96	—
0.30%	28	0.0689	19.9	-0.00128	—	1.93	—
0.25%	28	0.0690	19.9	-0.00126	—	1.93	—
0.20%	28	0.0640	19.9	-0.00066	—	1.79	—



图 33. I<sub>LED</sub> (A) versus Duty Cycle (%) for PWM or Shunt Dimming at 50 kHz for Blue LED String

表 22. PWM Dimming Data for White LED String at 50-kHz PWM Frequency

DUTY CYCLE	V <sub>IN</sub> (V)	I <sub>IN</sub> (A)	V <sub>OUT</sub> (V)	I <sub>LED</sub> (A)	P <sub>OUT</sub> (W)	P <sub>IN</sub> (W)	EFF
100.0%	28	0.7392	25.1	0.77360	19.417	20.70	93.81%
90.0%	28	0.5960	25.1	0.62670	15.730	16.69	94.26%
80.0%	28	0.5215	25.1	0.54350	13.642	14.60	93.42%
70.0%	28	0.4512	25.1	0.46550	11.684	12.63	92.48%

**表 22. PWM Dimming Data for White LED String at 50-kHz PWM Frequency (continued)**

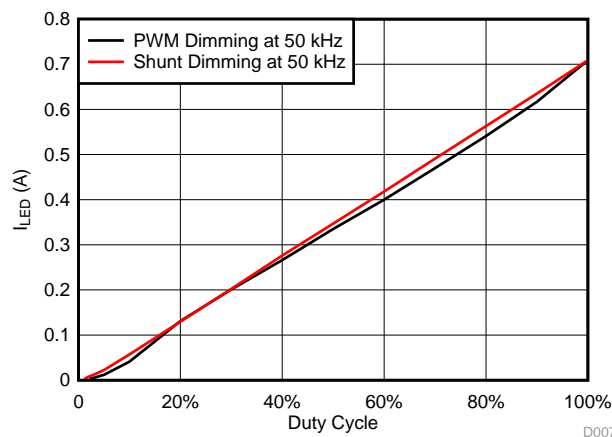
DUTY CYCLE	V <sub>IN</sub> (V)	I <sub>IN</sub> (A)	V <sub>OUT</sub> (V)	I <sub>LED</sub> (A)	P <sub>OUT</sub> (W)	P <sub>IN</sub> (W)	EFF
60.0%	28	0.3791	25.1	0.38600	9.689	10.61	91.27%
50.0%	28	0.3074	25.1	0.30730	7.713	8.61	89.61%
40.0%	28	0.2344	25.1	0.22810	5.725	6.56	87.23%
30.0%	28	0.1592	25.1	0.14580	3.660	4.46	82.10%
20.0%	28	0.0889	25.1	0.06030	1.514	2.49	60.80%
10.0%	28	0.0519	25.1	0.02130	0.535	1.45	36.79%
5.0%	28	0.0394	23.7	0.00760	0.180	1.10	16.33%
3.0%	28	0.0359	22.9	0.00350	0.080	1.01	7.97%
2.0%	28	0.0346	22.7	0.00190	0.043	0.97	4.45%
1.0%	28	0.0335	22.6	0.00060	0.014	0.94	1.45%
0.8%	28	0.0334	22.4	0.00046	0.010	0.94	1.10%
0.6%	28	0.0333	22.2	0.00031	0.007	0.93	0.74%
0.4%	28	0.0331	22.0	0.00014	0.003	0.93	0.33%
0.2%	28	0.0330	20.7	0.00007	0.001	0.92	0.16%

**表 23. Shunt Dimming Data for White LED String at 50-kHz Shunt PWM Frequency**

DUTY CYCLE	V <sub>IN</sub> (V)	I <sub>IN</sub> (A)	V <sub>OUT</sub> (V)	I <sub>LED</sub> (A)	P <sub>OUT</sub> (W)	P <sub>IN</sub> (W)	EFF
100.0%	28	0.7446	25.1	0.77280	19.40	20.85	93.04%
90.0%	28	0.6793	25.1	0.69680	17.49	19.02	91.95%
80.0%	28	0.6091	25.1	0.61850	15.52	17.05	91.03%
70.0%	28	0.5393	25.1	0.53920	13.53	15.10	89.63%
60.0%	28	0.4697	25.1	0.46010	11.55	13.15	87.81%
50.0%	28	0.3994	25.1	0.38060	9.55	11.18	85.42%
40.0%	28	0.3286	25.1	0.30080	7.55	9.20	82.06%
30.0%	28	0.2520	25.1	0.21810	5.47	7.06	77.58%
20.0%	28	0.1841	25.1	0.14170	3.56	5.15	69.00%
10.0%	28	0.1093	25.1	0.06140	1.54	3.06	50.36%
5.0%	28	0.0784	25.1	0.02720	0.68	2.20	31.10%
3.0%	28	0.0675	25.1	0.01460	0.37	1.89	19.39%
2.0%	28	0.0620	25.1	0.00880	0.22	1.74	12.72%
1.0%	28	0.0573	25.1	0.00330	0.08	1.60	5.16%
0.8%	28	0.0554	25.1	0.00178	0.04	1.55	2.88%
0.5%	28	0.0557	25.1	0.00161	0.04	1.56	2.59%
0.3%	28	0.0482	25.1	-0.00040	—	1.35	—
0.2%	28	0.0457	25.1	-0.00027	—	1.28	—



图 34.  $I_{LED}$  (A) versus Duty Cycle (%) for PWM or Shunt Dimming at 50 kHz for White LED String

注: The test results for shunt dimming shows better deep dimming capability and linear characteristics as compared to PWM dimming at a 50-kHz dimming frequency.

### 3.3.3.3 Waveforms

This section contains various current and switch node waveforms of the TIDA-01415 board for analog dimming and PWM or shunt dimming.

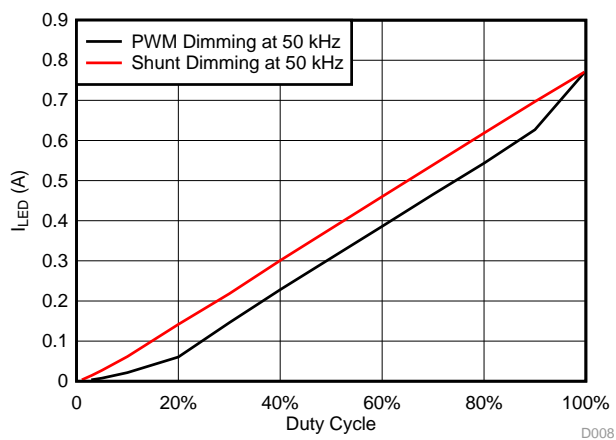
#### 3.3.3.3.1 Analog Dimming Waveforms



图 35. P-FET Current During On-Time at  $I_{ADJ} = 1.24\text{ V}$  for Red String



图 36. P-FET Current During On-Time at  $I_{ADJ} = 1.24\text{ V}$  for Green String

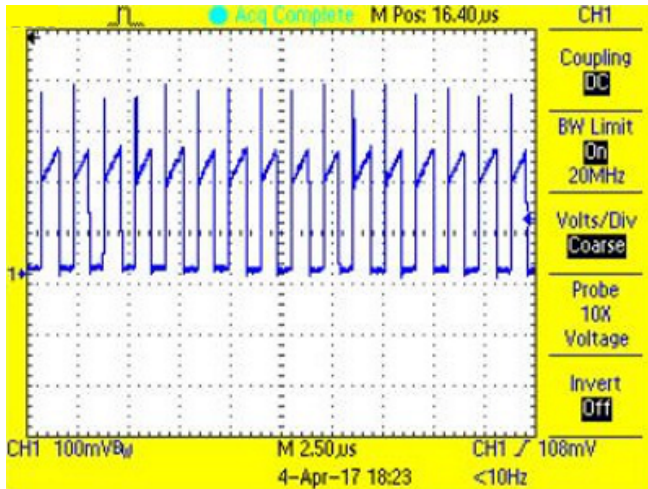

图 37. P-FET Current During On-Time at  $I_{ADJ} = 1.24\text{ V}$  for Blue String

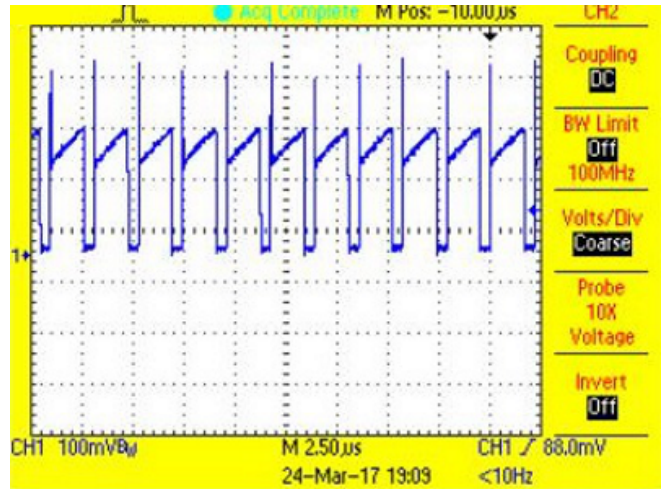

图 38. P-FET Current During On-Time at  $I_{ADJ} = 1.24\text{ V}$  for White String

注: The inductor current waveforms are captured across the high-side sensing resistor(0.3 Ω), which is connected across pin 7 and 8 of the LM3409.

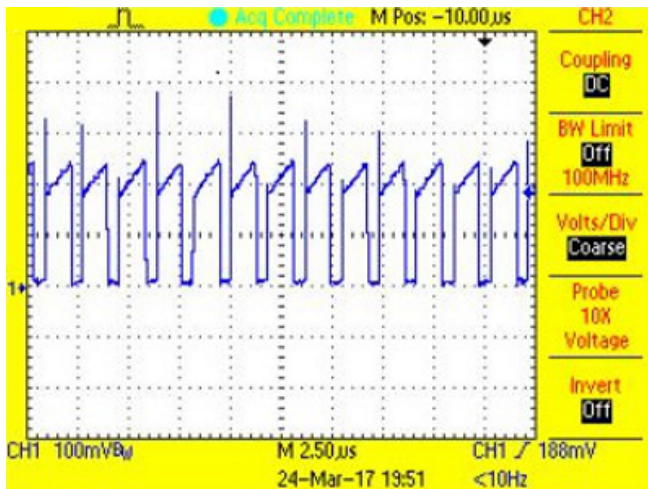
3.3.3.3.2 PWM Dimming Waveforms at 30 kHz

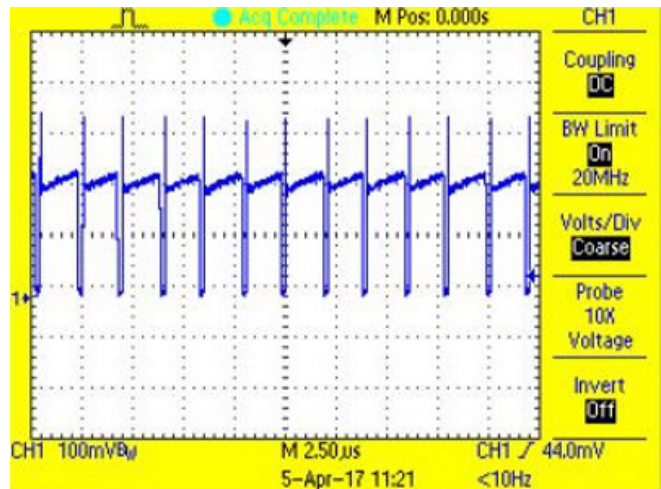

图 39. Switch Node and PWM Waveform for Red LED String at 50% Duty Cycle



图 40. P-FET Current During On-Time and PWM Waveform for Red LED String at 50% Duty Cycle

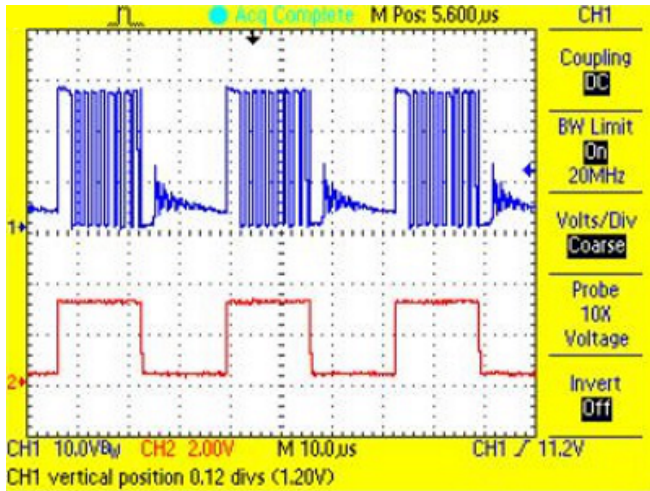

图 41. Switch Node and PWM Waveform for Green LED String at 50% Duty Cycle

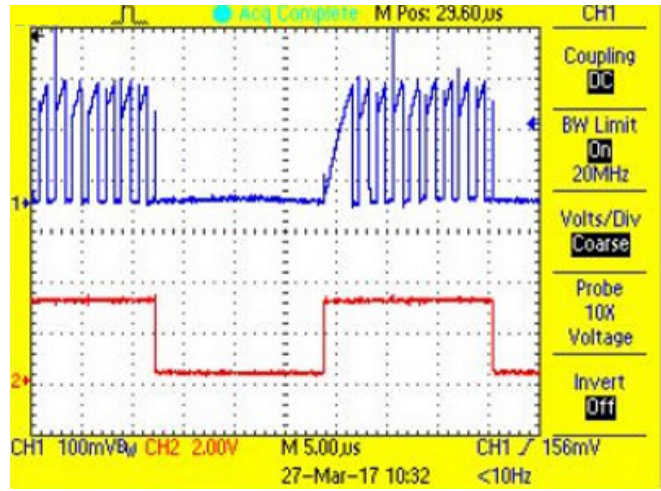

图 42. P-FET Current During On-Time and PWM Waveform for Green LED String at 50% Duty Cycle



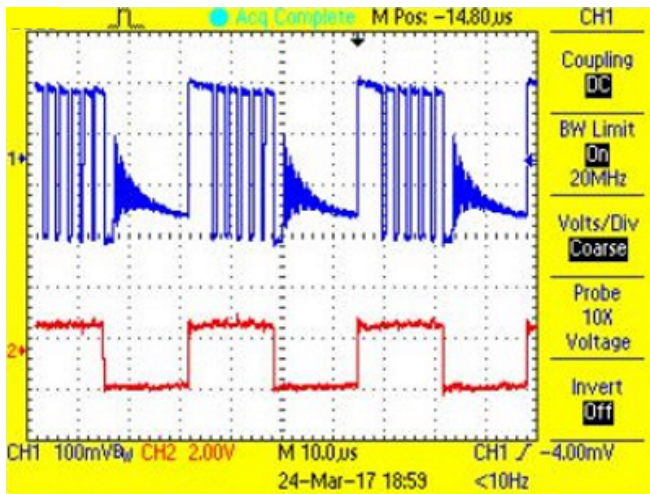

图 43. Switch Node and PWM Waveform for Blue LED String at 50% Duty Cycle

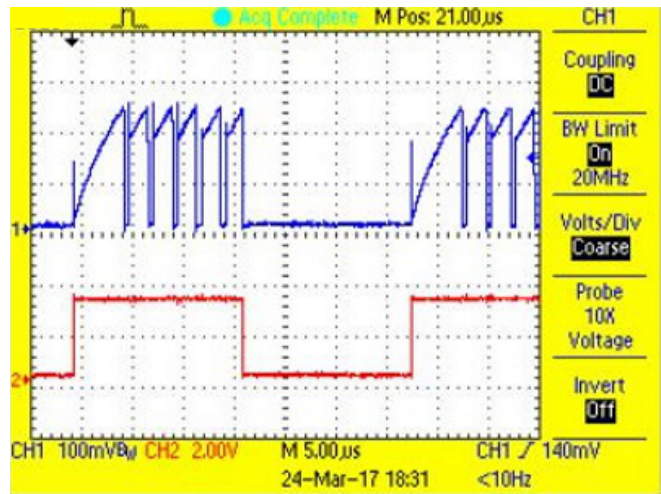

图 44. P-FET Current During On-Time and PWM Waveform for Blue LED String at 50% Duty Cycle

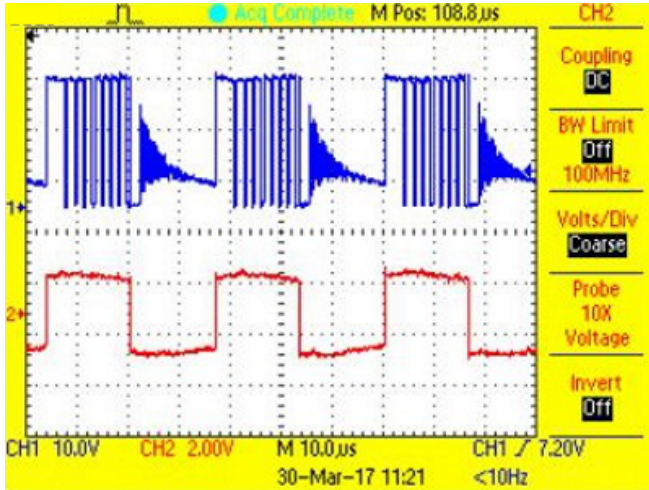

图 45. Switch Node and PWM Waveform for White LED String at 50% Duty Cycle

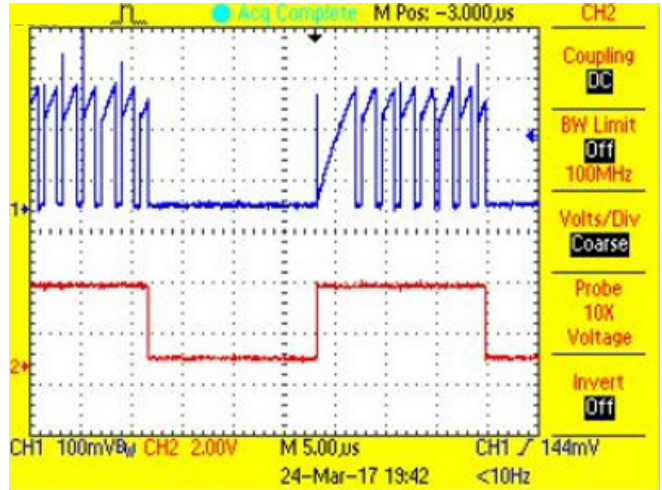

图 46. P-FET Current During On-Time and PWM Waveform for White LED String at 50% Duty Cycle

注: The inductor current waveforms are captured across the high-side sensing resistor(0.3 Ω), which is connected across pin 7 and 8 of the LM3409.

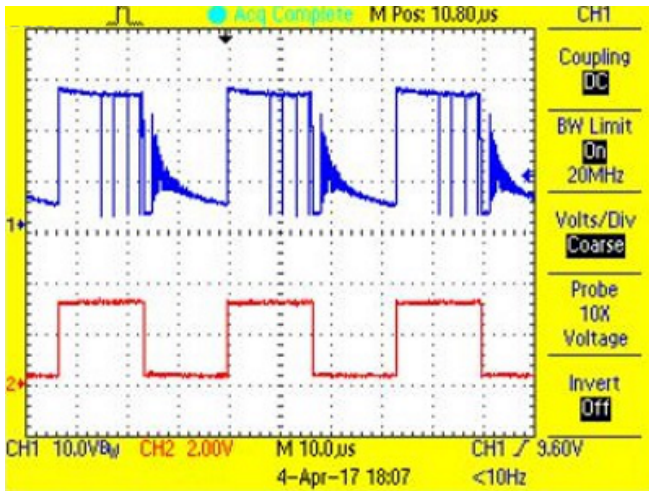
3.3.3.3.3 Shunt Dimming Waveforms at 30 kHz

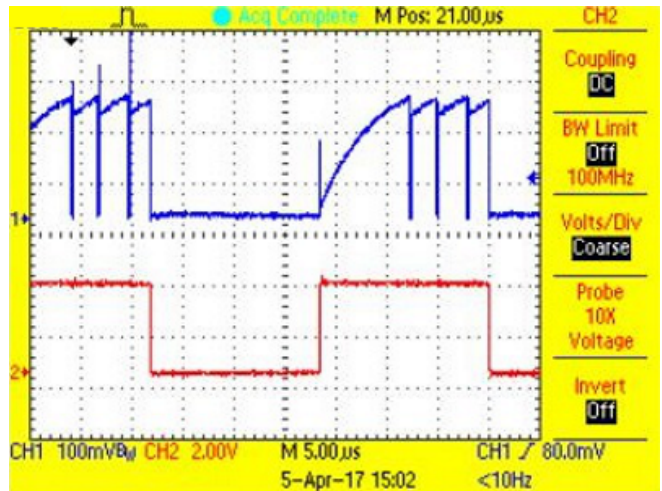

图 47. Switch Node and Shunt PWM Waveform for Red LED String at 50% Duty Cycle



图 48. P-FET Current During On-Time and Shunt PWM Waveform for Red LED String at 50% Duty Cycle

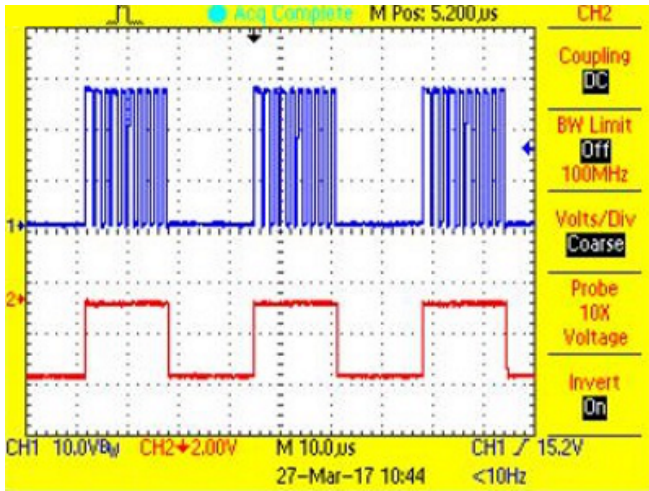

图 49. Switch Node and Shunt PWM Waveform for Green LED String at 50% Duty Cycle

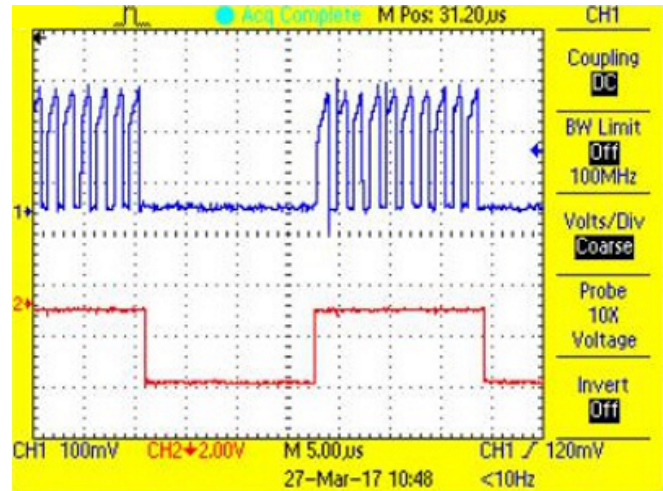

图 50. P-FET Current During On-Time and Shunt PWM Waveform for Green LED String at 50% Duty Cycle

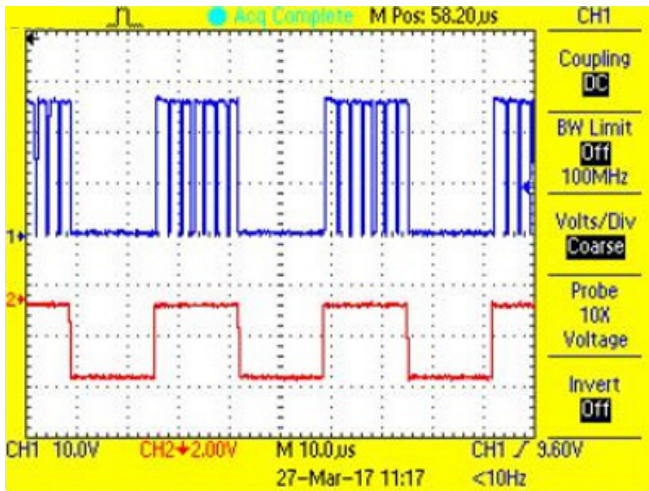

图 51. Switch Node and Shunt PWM Waveform for Blue LED String at 50% Duty Cycle

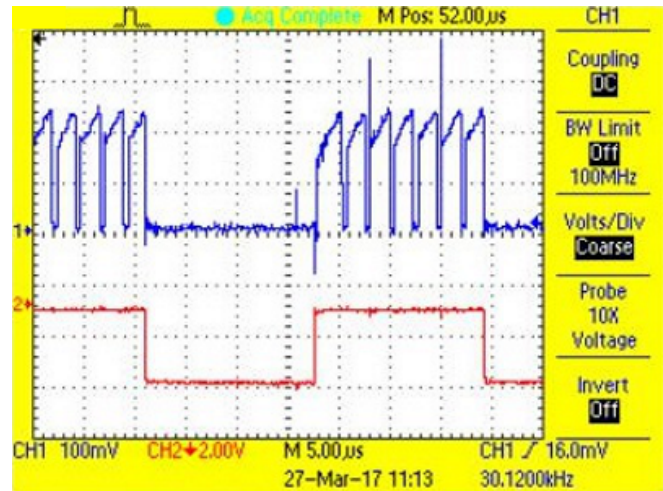

图 52. P-FET Current During On-Time and Shunt PWM Waveform for Blue LED String at 50% Duty Cycle

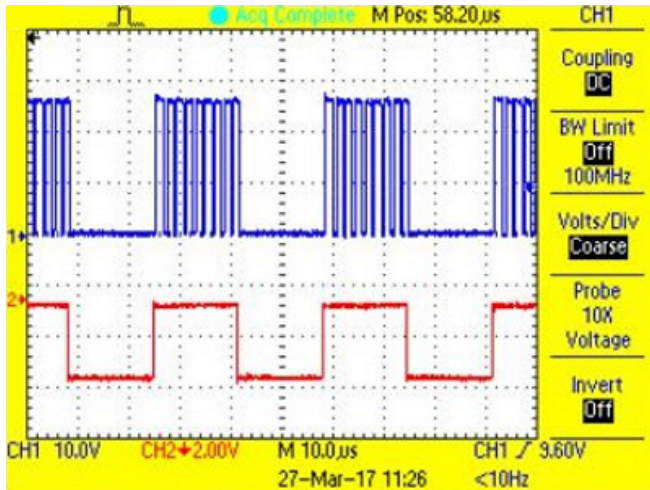

图 53. Switch Node and Shunt PWM Waveform for White LED String at 50% Duty Cycle

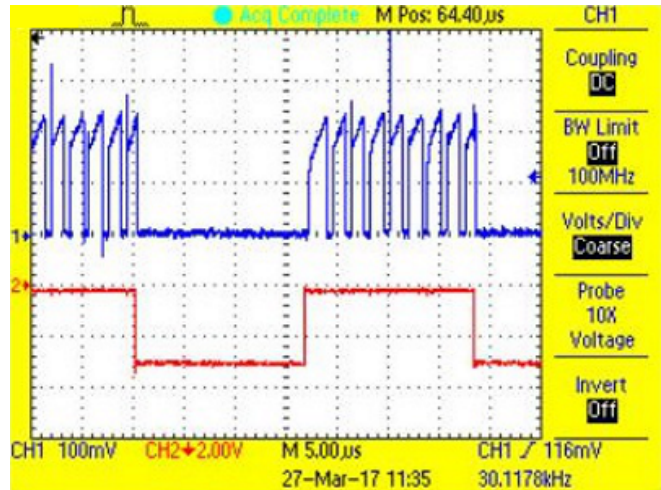

图 54. P-FET Current During On-Time and Shunt PWM Waveform for White LED String at 50% Duty Cycle

注: The inductor current waveforms are captured across the high-side sensing resistor(0.3 Ω), which is connected across pin 7 and 8 of the LM3409.

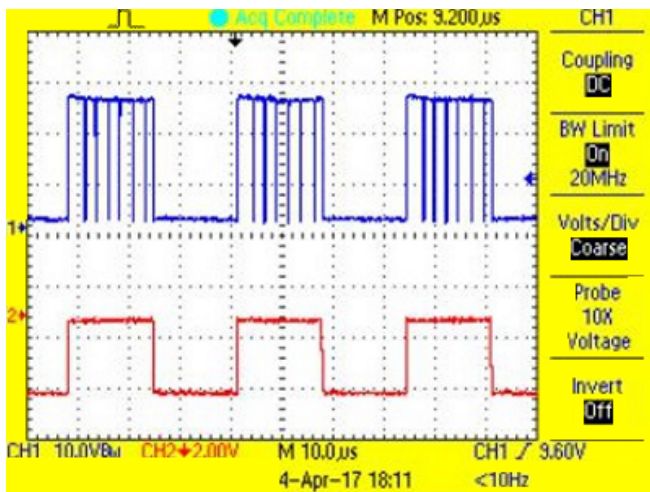
### 3.3.3.4 TINA Simulation for TIDA-01415

This section highlights the simulation done for PWM or shunt dimming with the LM3409 LED driver. 图 55 shows the simulation circuit for the LM3409 LED driver stage with PWM dimming at 30 kHz. 图 56 shows the LED current and switch node waveforms for PWM dimming at 30 kHz.

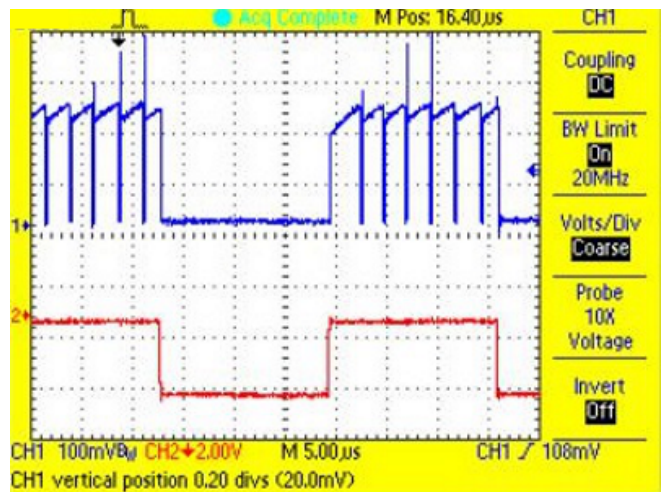

图 55. Simulation Circuit for PWM Dimming With LM3409



图 56. Simulation Results for PWM Dimming at 30 kHz

图 57 shows the simulation circuit for the LM3409 LED driver stage with PWM dimming at 30 kHz. 图 58 shows the LED current and switch node waveforms for shunt dimming at 30 kHz.

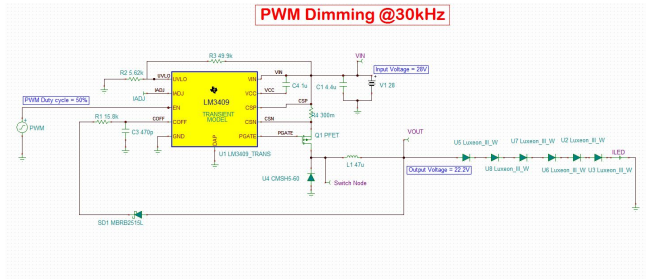

图 57. Simulation Circuit for Shunt Dimming at 30 kHz With LM3409

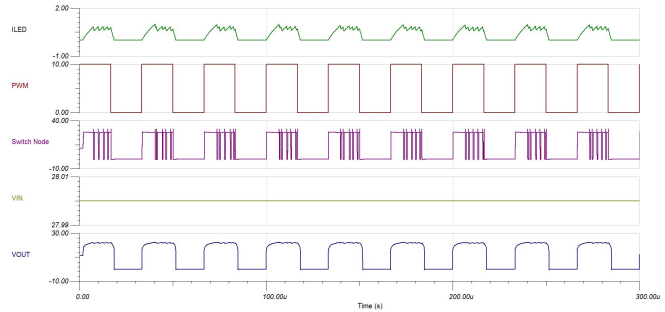

图 58. Simulation Results for Shunt Dimming at 30 kHz

### 3.3.3.5 Thermal Images at Full Load

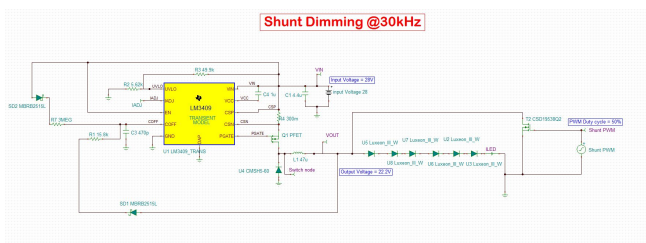
This section contains thermal images of the top and bottom side of the TIDA-01415 board with all strings running at full load.

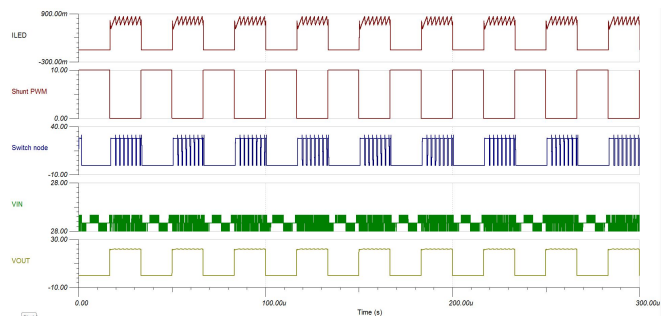

图 59. Thermal Image of Top Side of TIDA-01415 Board for PWM Dimming at 2.9-A Total LED Current (100% Duty Cycle for All Strings)

表 24. Temperature Details for 图 59

TEMPERATURE (°C)	DEVICE NAME	LED STRING
45.5	LM3409 (U2)	Red
45.5	High-side current sensing resistor (R5)	
49.3	LM3409 (U5)	Green
46.8	High-side current sensing resistor (R19)	
50.6	LM3409 (U11)	Blue
49.6	High-side current sensing resistor (R43)	
50.4	LM3409 (U14)	White
50.8	High-side current sensing resistor (U55)	

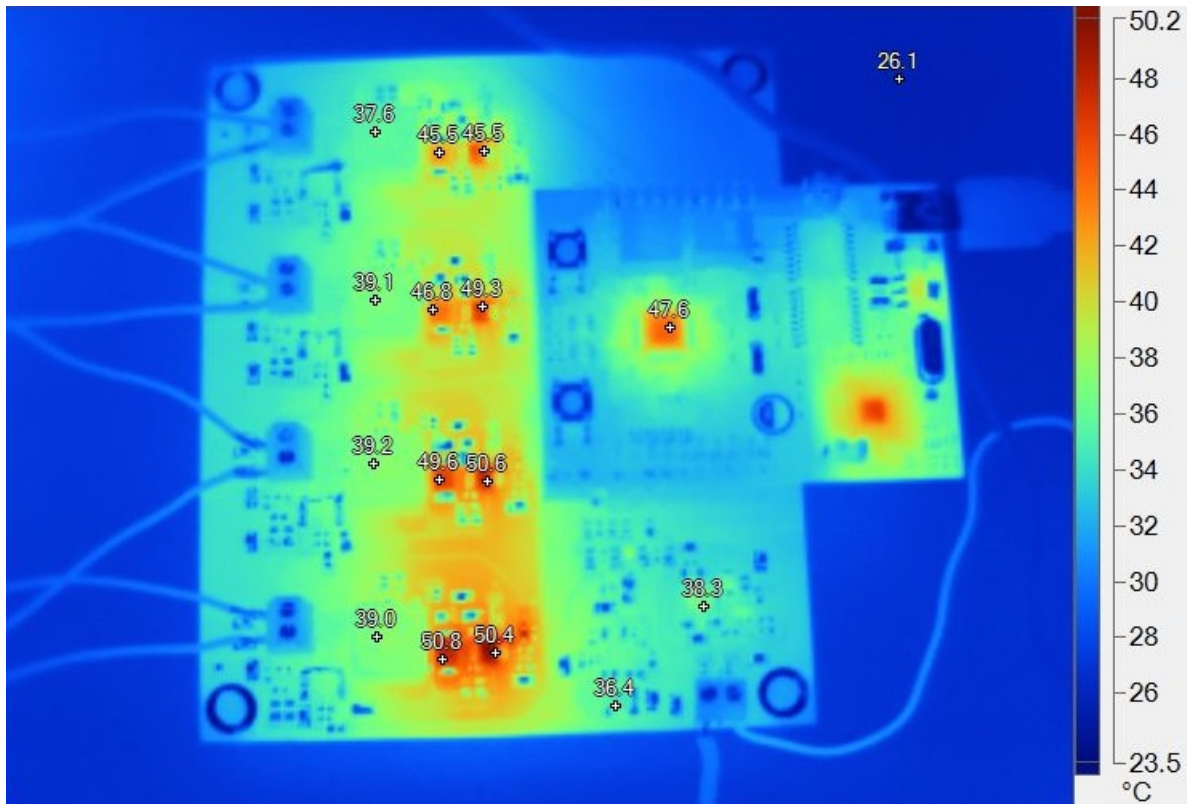

图 60. Thermal Image of Bottom Side of TIDA-01415 Board for PWM Dimming at 2.9-A Total LED Current (100% Duty Cycle for All Strings)

表 25. Temperature Details for 图 60

TEMPERATURE (°C)	DEVICE NAME	LED STRING
43.3	PFET (Q2)	Red
42.8	Schottky diode (D2)	
44.4	PFET (Q4)	Green
43.1	Schottky diode (D5)	
45.2	PFET (Q6)	Blue
43.8	Schottky diode (D9)	
48.0	PFET (Q8)	White
44.0	Schottky diode (D12)	

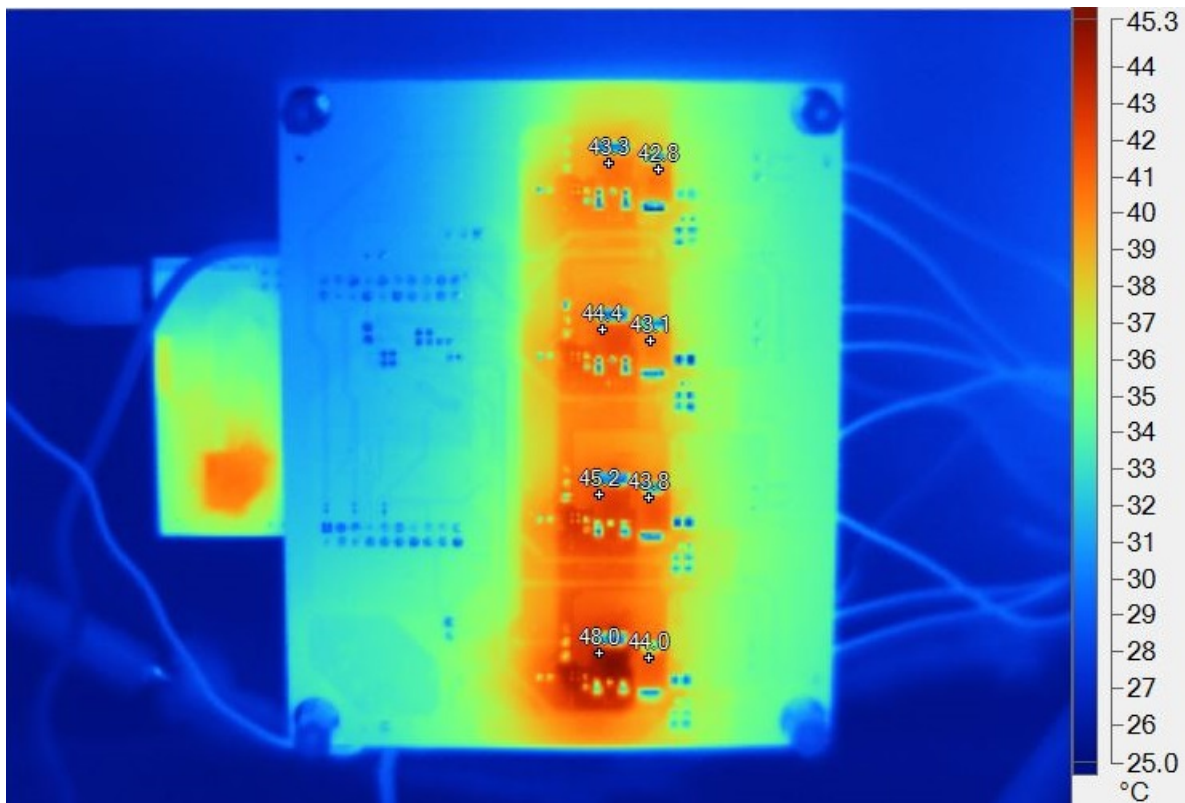

图 61. Thermal Image of Top Side of TIDA-01415 Board for Shunt Dimming at 2.9-A Total LED Current (100% Duty Cycle for All Strings)

表 26. Temperature Details for 图 61

TEMPERATURE (°C)	DEVICE NAME	LED STRING
44.2	LM3409 (U2)	Red
41.7	High-side current sensing resistor (R5)	
45.7	LM3409 (U5)	Green
42.8	High-side current sensing resistor (R19)	
43.5	LM3409 (U11)	Blue
45.1	High-side current sensing resistor (R43)	
48.3	LM3409 (U14)	White
46.8	High-side current sensing resistor (U55)	

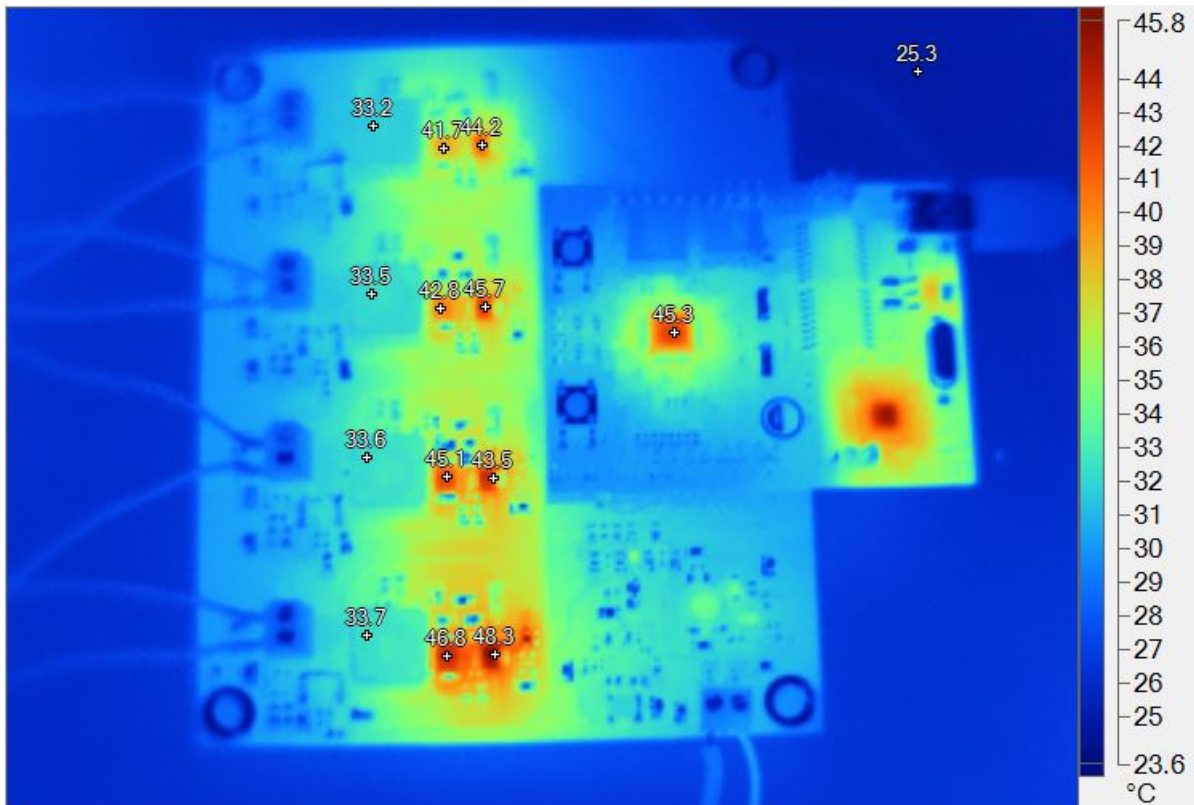

图 62. Thermal Image of Bottom Side of TIDA-01415 Board for Shunt Dimming at 2.9-A Total LED Current (100% Duty Cycle for All Strings)

表 27. Temperature Details for 图 62

TEMPERATURE (°C)	DEVICE NAME	LED STRING
44.2	PFET (Q2)	Red
43.5	Schottky diode (D2)	
38.8	Shunt dimming FET (Q1)	
45.2	PFET (Q4)	Green
42.9	Schottky diode (D5)	
39.3	Shunt dimming FET (Q3)	
45.7	PFET (Q6)	Blue
44.3	Schottky diode (D9)	
40.5	Shunt dimming FET (Q5)	
49.1	PFET (Q8)	White
43.7	Schottky diode (D12)	
40.5	Shunt dimming FET (Q7)	

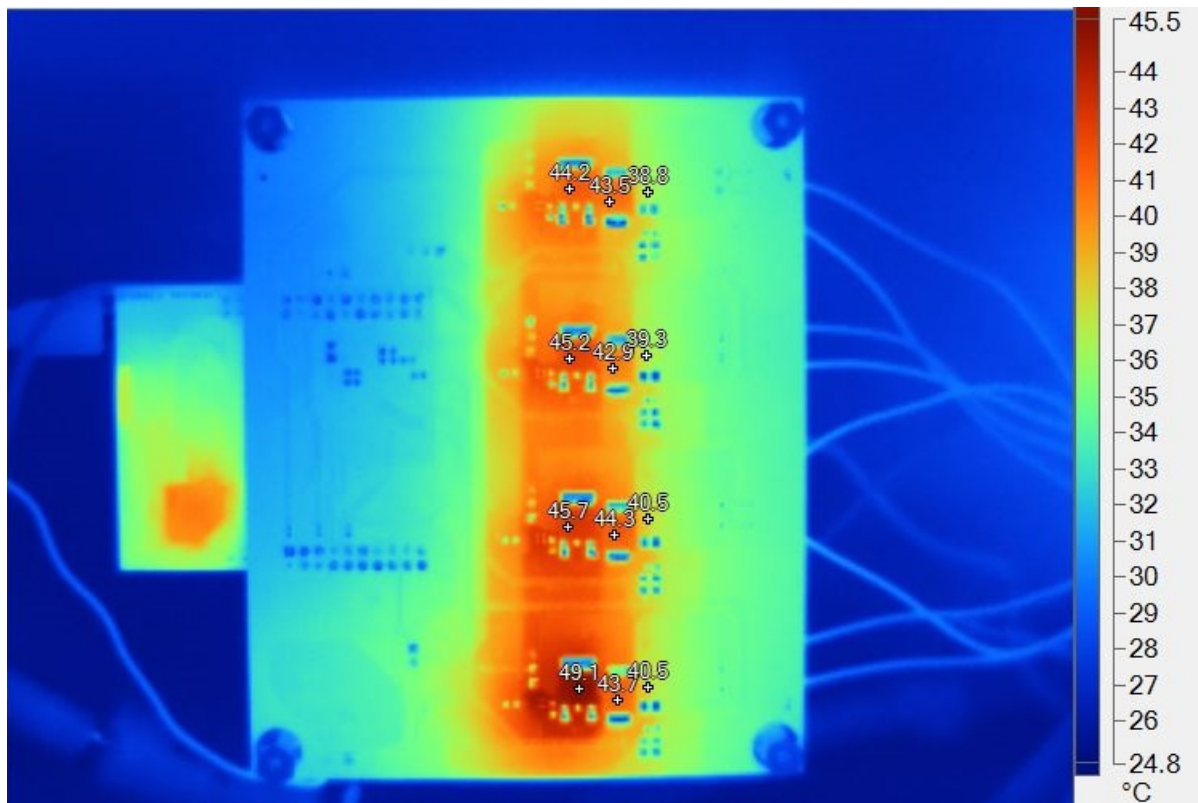

## 4 Design Files

### 4.1 Schematics

To download the schematics, see the design files at [TIDA-01415](#).

### 4.2 Bill of Materials

To download the bill of materials (BOM), see the design files at [TIDA-01415](#).

### 4.3 PCB Layout Recommendations

#### 4.3.1 Layout Prints

To download the layer plots, see the design files at [TIDA-01415](#).

### 4.4 Altium Project

To download the Altium project files, see the design files at [TIDA-01415](#).

### 4.5 Gerber Files

To download the Gerber files, see the design files at [TIDA-01415](#).

### 4.6 Assembly Drawings

To download the assembly drawings, see the design files at [TIDA-01415](#).

## 5 Software Files

To download the software files, see the design files at [TIDA-01415](#).

## 6 Related Documentation

1. Texas Instruments, [TMS320x280x, 2801x, 2804x High Resolution Pulse Width Modulator \(HRPWM\)](#), HRPWM Reference Guide (SPRU924)
2. Mike Wood Consulting, [Rolling, rolling, rolling... Camera light sensors react differently to images lit with PWM-dimmed LEDs](#), Out of the Wood (<http://www.mikewoodconsulting.com/articles/Protocol%20Summer%202011%20-%20Rolling%20Shutters.pdf>)

### 6.1 商标

C2000, Microwire, NexFET, Piccolo, Code Composer Studio, controlSUITE, BoosterPack are trademarks of Texas Instruments.

Quad-SPI is a trademark of Motorola, Inc.

All other trademarks are the property of their respective owners.

## 7 About the Authors

**SEETHARAMAN DEVENDRAN** is a systems architect at Texas Instruments, where he is responsible for developing reference design solutions for the industrial segment. Seetharaman brings to this role his extensive experience in analog and mixed signal system-level design expertise. Seetharaman earned his bachelor's degree in electrical engineering (BE, EEE) from Thiagarajar College of Engineering, Madurai, India.

**SURYA MISHRA** is a systems engineer at Texas Instruments, where he is responsible for developing reference design solutions for the Lighting, Industrial Segment. Surya earned his bachelor of electronics and communication engineering from the Motilal Nehru National Institute of Technology (MNNIT), Allahabad.

**ADITYA PANDEY** is an undergraduate student from the Birla Institute of Technology and Sciences (BITS-Pilani) where he is pursuing his bachelors in electrical and electronics engineering (EEE). He is currently working as an intern and is responsible for the design and debug of circuits and systems for the lighting team.

## 有关 TI 设计信息和资源的重要通知

德州仪器 (TI) 公司提供的技术、应用或其他设计建议、服务或信息，包括但不限于与评估模块有关的参考设计和材料（总称“TI 资源”），旨在帮助设计人员开发整合了 TI 产品的应用；如果您（个人，或如果是代表贵公司，则为贵公司）以任何方式下载、访问或使用了任何特定的 TI 资源，即表示贵方同意仅为该等目标，按照本通知的条款进行使用。

TI 所提供的 TI 资源，并未扩大或以其他方式修改 TI 对 TI 产品的公开适用的质保及质保免责声明；也未导致 TI 承担任何额外的义务或责任。TI 有权对其 TI 资源进行纠正、增强、改进和其他修改。

您理解并同意，在设计应用时应自行实施独立的分析、评价和判断，且应全权负责并确保应用的安全性，以及您的应用（包括应用中使用的 TI 产品）应符合所有适用的法律法规及其他相关要求。您就您的应用声明，您具备制订和实施下列保障措施所需的一切必要专业知识，能够 (1) 预见故障的危险后果，(2) 监视故障及其后果，以及 (3) 降低可能导致危险的故障几率并采取适当措施。您同意，在使用或分发包含 TI 产品的任何应用前，您将彻底测试该等应用和该等应用所用 TI 产品的功能。除特定 TI 资源的公开文档中明确列出的测试外，TI 未进行任何其他测试。

您只有在为开发包含该等 TI 资源所列 TI 产品的应用时，才被授权使用、复制和修改任何相关单项 TI 资源。但并未依据禁止反言原则或其他法律授予您任何 TI 知识产权的任何其他明示或默示的许可，也未授予您 TI 或第三方的任何技术或知识产权的许可，该等产权包括但不限于任何专利权、版权、屏蔽作品权或与使用 TI 产品或服务的任何整合、机器制作、流程相关的其他知识产权。涉及或参考了第三方产品或服务的信息不构成使用此类产品或服务的许可或与其相关的保证或认可。使用 TI 资源可能需要您向第三方获得对该等第三方专利或其他知识产权的许可。

TI 资源系“按原样”提供。TI 兹免除对 TI 资源及其使用作出所有其他明确或默示的保证或陈述，包括但不限于对准确性或完整性、产权保证、无复发故障保证，以及适销性、适合特定用途和不侵犯任何第三方知识产权的任何默认保证。

TI 不负责任何申索，包括但不限于因组合产品所致或与之有关的申索，也不为您辩护或赔偿，即使该等产品组合已列于 TI 资源或其他地方。对因 TI 资源或其使用引起或与之有关的任何实际的、直接的、特殊的、附带的、间接的、惩罚性的、偶发的、从属或惩戒性损害赔偿，不管 TI 是否获悉可能会产生上述损害赔偿，TI 概不负责。

您同意向 TI 及其代表全额赔偿因您不遵守本通知条款和条件而引起的任何损害、费用、损失和/或责任。

本通知适用于 TI 资源。另有其他条款适用于某些类型的材料、TI 产品和服务的使用和采购。这些条款包括但不限于适用于 TI 的半导体产品 (<http://www.ti.com/sc/docs/stdterms.htm>)、[评估模块](http://www.ti.com/sc/docs/sampters.htm)和样品 (<http://www.ti.com/sc/docs/sampters.htm>) 的标准条款。

邮寄地址：上海市浦东新区世纪大道 1568 号中建大厦 32 楼，邮政编码：200122  
Copyright © 2017 德州仪器半导体技术（上海）有限公司