

TI Designs

此三维 (3D) 机器视觉设计说明了一种嵌入式扫描仪，这种扫描仪可以根据结构光原理生成物理实体的 3D 数字表示形式。此设计使用数码相机以及 Sitara™AM57xx 片上系统 (SoC) 采集基于 DLP4500 的投影仪发出的反射光图案。采集图案的后续处理、物体的 3D 点云计算及其 3D 可视化全都在 AM57xx 处理器内执行。

此设计提供了一款嵌入式解决方案，相对于基于主机 PC 的实施方案具有功耗、简洁性、成本和尺寸方面的优势。借助 AM57xx 处理器的内置 DSP，此嵌入式解决方案可实现与 2GHz 双核 i5 类处理器相似的处理时间，而功耗和成本仅仅是这类处理器的几分之一。

设计资源

- TIDEP0076 设计文件夹
- TIDA-00254 产品文件夹
- TIDA-00361 产品文件夹
- AM57x 软件开发套件 (SDK) 产品文件夹

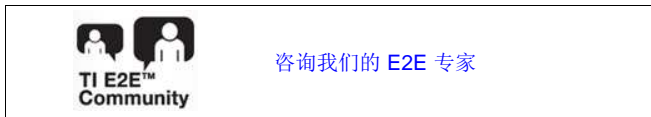

特性

- 现场演示使用基于 DLP®技术的结构光技术进行 3D 机器检查
- 基于 Sitara AM57xx SOC 和 DLP LightCrafter™4500 的完全嵌入式 3D 机器视觉系统。无需 PC
- 即可提供 3D 物体点云
- 演示高达 130 万像素摄像头采集 (60 fps)
- 支持高达 4K fps 的结构光图案显示
- 演示在 AM572x SoC 中利用集成型处理器内核和图形处理器来组织和呈现 3D 点云
- 支持在高清显示器中显示测量的 3D 物体
- 演示 TI 软件框架和库的集成简便性

应用

- 流水检查 (AOI、SPI)
- 度量
- 工业工厂自动化
- 牙科扫描仪

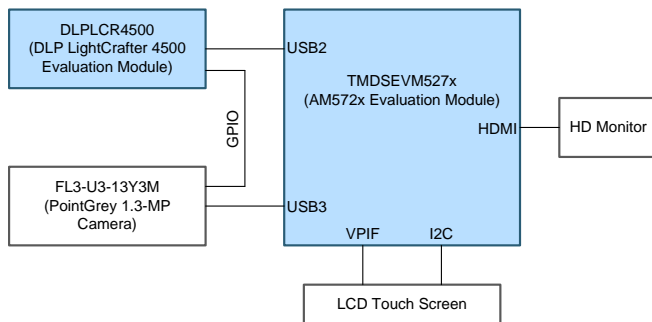

Copyright © 2017, Texas Instruments Incorporated

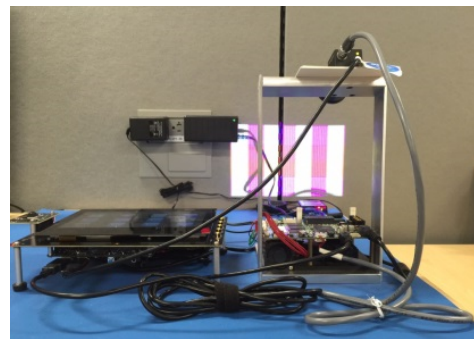

该 TI 参考设计末尾的重要声明表述了授权使用、知识产权问题和其他重要的免责声明和信息。

1 Introduction

This design is based on principles and algorithms described in the TI Design [TIDA-00254](#). Instead of a host PC, this design uses an AM5728-class embedded application processor to process captured images and display a generated 3D point cloud model.

Structured light is an optical method of 3D scanning where a set of patterns is projected upon an object, and the resulting image is captured with an imaging sensor that is offset from the projector. Structured light is an effective method to obtain accurate dimensional measurements. Structured light is widely used in applications where surface defects are detected and classified, as well as in conditions where objects or surfaces of objects do not have geometric features to extract. Typical examples of structured light-based 3D scanner systems are:

- Factory automation
- In-line inspection
- Metrology
- Surface inspection
- Metrology and parts measurement
- Agricultural produce inspection
- Dental oral scanner

Related technologies for 3D measurements are:

- Stereo vision
- Time-of-flight (TOF)

表 1 lists a comparison of 3D scanning technologies for different areas of applications, as well as advantages and restrictions when used. Cost comparisons are relative to each other, based on typical implementations on TI devices.

表 1. Methods for 3D Scanning and Measurement



	STEREO VISION	3D TOF	3D DLP
Key Principles	Stereo disparity	TOF	Structured light
Typical Application	Broad range – ADAS, industrial, consumer, UAV	RGBZ, RGBD camera Industrial, consumer, robotics	Industrial inspection, metrology
Example Systems			
Depth Accuracy	mm to cm Difficult with smooth surface	mm to cm Variable patterns and different light sources improve accuracy	µm to cm Depends on resolution of sensor
Scanning Speed	Medium Limited by software complexity	Medium to fast Limited by camera speed	Fast Limited by image acquisition speed
Distance Range	Mid-range	Short to long range	Very short to mid-range

表 1. Methods for 3D Scanning and Measurement (continued)

	STEREO VISION	3D TOF	3D DLP
Low Light Performance	Weak	Good	Light source dependent
Outdoor Performance	Good	Fair Depends on illumination power	Weak to fair Depends on illumination power
Software Complexity	High	Low	Medium to high
Pros	<ul style="list-style-type: none"> Widely used across various applications Wide range of software and hardware components available Can be easily implemented on a mobile processor 	<ul style="list-style-type: none"> Better spatial resolution than stereo vision Can design light sources for the specific scenarios and field of view Can be used day or night, rain or shine Lower power for applications that requires an Always-ON vision sensor, similar to Siri® or Cortana® in the voice side The computing is significantly simpler than stereo vision 	<ul style="list-style-type: none"> Can identify anomalies in a flat surface Can design light source to optimize reflection for the targeted objects No interference Allows projection of multiple patterns on the same object to extract features Allows creation of complex patterns Allows adaptive pattern generation
Cons	<ul style="list-style-type: none"> Not usable in dark environment or adverse weather conditions Objects required to have identifiable geometric features May give erroneous depth if background and object mix colors 	<ul style="list-style-type: none"> Interference between multiple units Needed lenses for both the sensor and light sources Power of the light sources usually exceeds processor power significantly 	<ul style="list-style-type: none"> Specialized system typically targeted for inspection of defects, shapes, size
Material Cost	Low	Middle	Middle to high

A structured light 3D scanner captures images of a structure-light illuminated object then calculates depth information of the object based on the distortion of the pattern by the object. Objects in view of both the camera and projector cause different rays from the camera and projector to intersect each other. This intersection can be calculated by using the gray-coded and phase-shifted ray information from the projector along with the detected ray information from the captured images. This intersection of rays determines the real point of an object in space. The geometrical ray intersection calculations are performed by a geometry module in the software for each intersecting point.

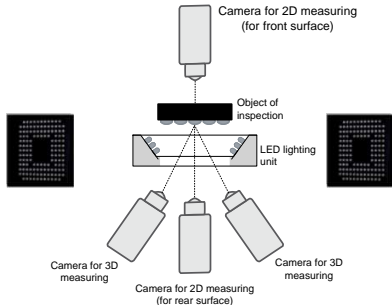
The points generated by the geometry module are stored in a collection called a point cloud. The point cloud is all of the known points from a captured scene. Software tools and algorithms can be produced to use point clouds to create solid surfaces. The point cloud can be viewed on the display device connected to the AM57x board. The MeshLab software tool can also be used for offline viewing of point clouds.

图 1 shows a high-level overview of principles of depth measurement based on structured light illumination. The basic steps are:

1. A structured light pattern is pre-designed or adaptively generated and projected on an object.
2. A camera captures the image, where the position and angles of the camera relative to the object and light source are calibrated.
3. A processor calculates depths of the object features based on reflected light.

Light patterns can be simple vertical or horizontal binary color lines, sinusoidal intensity lines, or with more complex color spectrum, depending on expected shapes and reflective characteristics of the object.



图 1. Principles of Depth Measurement Based on Structured Light

1.1 System Overview

1.1.1 System Description

图 2 shows the major components of the 3D DLP scanner design. The system is based on the following key component modules:

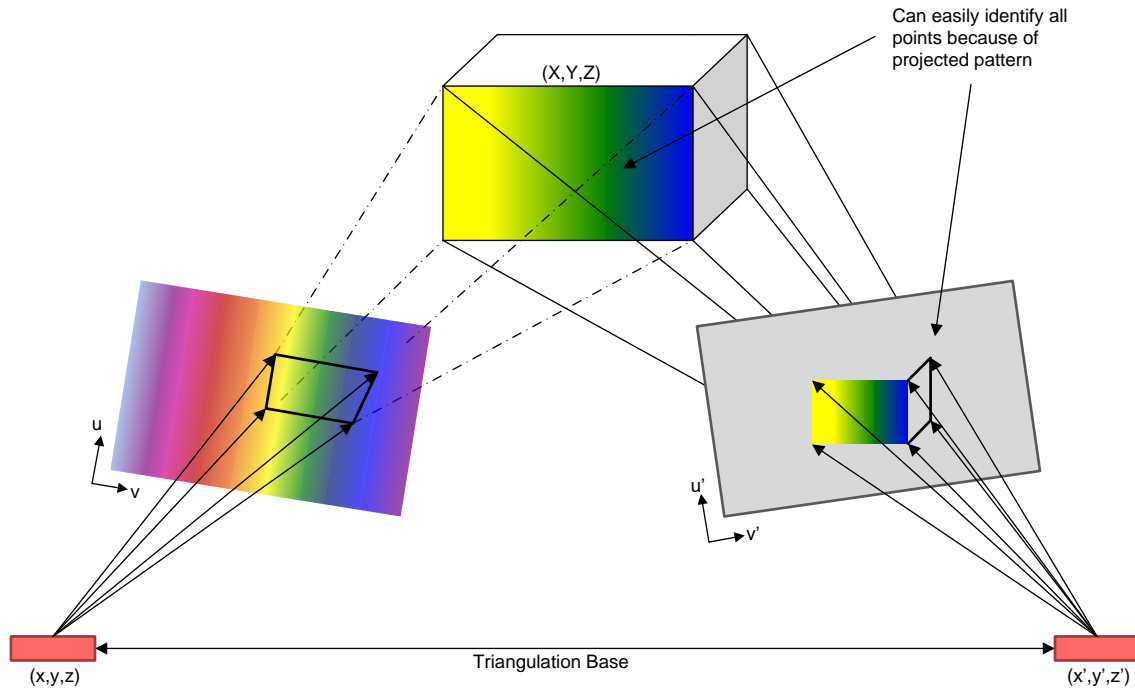
- Light source: projected from a DLP LCR4500 projector module
- Camera: Point Grey® 1.3 MP industrial camera, FL3-U3-13S2C or FL3-U3-13Y3M
- Processor: AM572x application processor EVM module
- Display (optional): a standard HDMI monitor driven directly from the AM5728 EVM

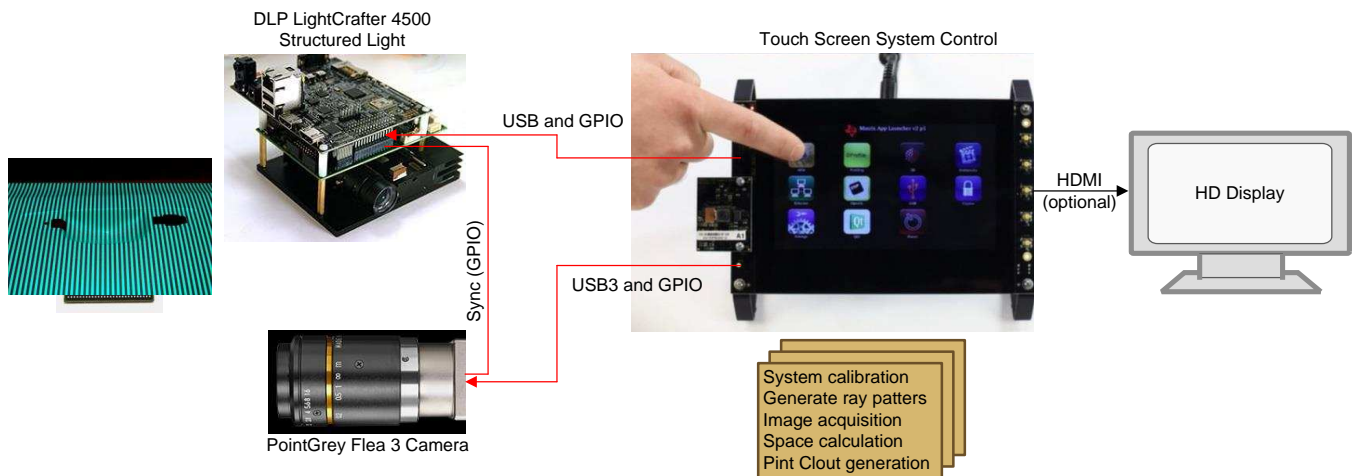

Copyright © 2017, Texas Instruments Incorporated

图 2. System Components of 3D DLP® Scanner

图 3 shows the internal data flow and processing functions of the design, based on a generic AM57xx application processor, with activated functions in this design highlighted. The CSI-2 interface is available only on the AM571x family of devices.

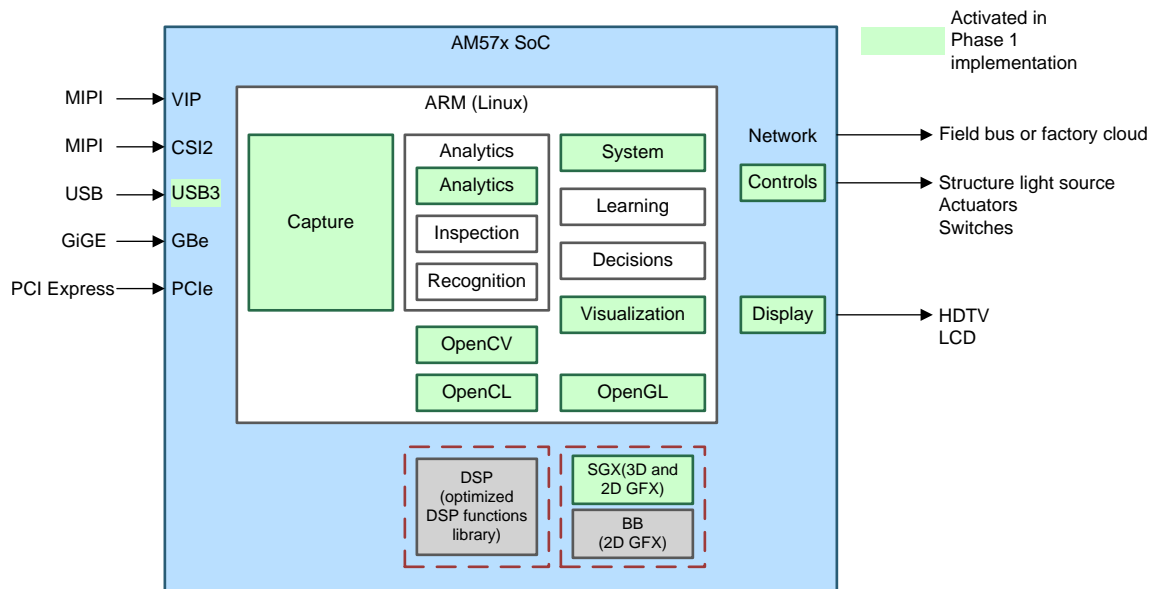

Copyright © 2017, Texas Instruments Incorporated

图 3. Internal Data Processing of 3D Scanner

1.1.2 Key System Specifications

The system enables a fully embedded design, while maximizing software reuse from equivalent PC-based systems. Key features of the system components include:

- **AM5728 Application Processor**
 - Dual-core ARM® Cortex®-A15 processors up to 1.5 GHz
 - Dual-core C66x DSP processors up to 750 MHz
 - Accelerated 3D graphics
 - Versatile image capturing capability from VIP, USB3, Gbe, or PCIe
 - Built-in HDMI transmit with PHY
 - Touch screen support
- **DLP LightCrafter 4500**
 - 18 vertical, 18 horizontal patterns, prestored
 - Projected resolution: 912 × 1140 (diamond shape)
 - Effective area after cropping: 912 × 570 (rectangular)
 - 4-KHz switching capability of light pattern generation
- **Point Grey 1.3-MP Camera [FL3-U3-13S2C or FL3-U3-13Y3M]**
 - 1280 × 1024, 60 fps mono
 - Sends out one GPIO strobe per image
- **Triggering and Synchronization**

- GPIO-based hardware triggering from camera to the DLP projector

2 Getting Started Hardware and Software

This reference design may be recreated by acquiring the following hardware components and software modules.

2.1 Software

The 3D DLP scanner software suite performs capturing, processing, point-cloud generation, and 3D object visualization functions of the system. The development adopts a phased approach as shown in 表 2. Current revision of this design guide reflects Phase 2.

表 2. Software Development Phases

PHASE	ARM (A15)	DSP (C66x)	DATA FLOW
Phase 1	All on A15	No DSP offloading	Sequential
Phase 2	System on A15	Partial DSP offload	Parallel camera acquisition with processing
Phase 3	System on A15	DSP offloading	Parallel

图 4 shows the software processing flow of Phase 1 development, where all processing is performed on the embedded A15 processor cores, except for 3D rendering which is performed on the SGX544 graphics core.

图 5 shows the processing flow of Phase 2 where parts of postprocessing and depth calculation are offloaded to DSP.



图 4. Phase 1 Software Processing Data Flow



图 5. Phase 2 Software Processing Data Flow

2.1.1 Preparation and Control of Project Light Patterns

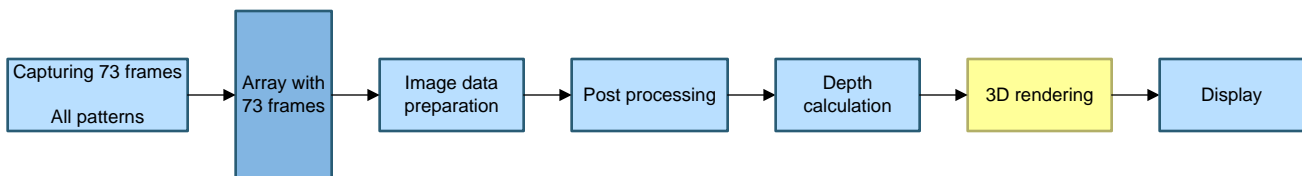
Pattern projection is performed by a structured light module in the DLP ALC SDK. The module generates vertical and horizontal gray-coded patterns or phase-shifted patterns which are sent to a LightCrafter 4500 projector. A firmware file with prestored patterns is prepared and statically uploaded to the projector using the LightCrafter 4500 module. For further details of how to use the DLP ALC SDK and prepare prestored light patterns see TIDA-00254.

2.1.2 Capture

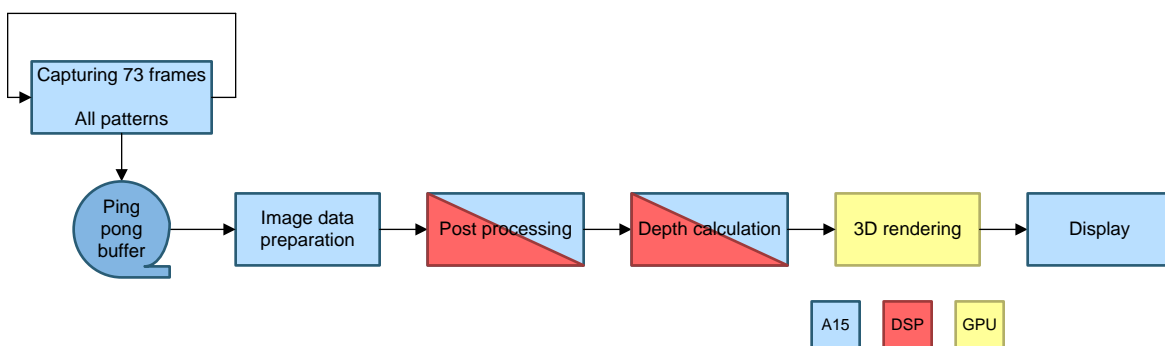
Standard Point Grey driver APIs are called to capture a set of images based on a set of prestored light patterns in the DLP projector. The camera module triggers DLP light switching through a GPIO cable, and then stores all N captured frames through the USB3 to the AM57x.

2.1.3 Image Data Preparation

The Point Grey Flea3[®] driver API is called to convert native camera file format to standard Linux[®] image file format.

2.1.4 Post Processing

Captured frames are cropped and clean images are identified, matching the prestored light patterns.

2.1.5 Depth Calculation

Trigonometry and geometric functions are performed to calculate depths of the objects.

2.1.6 3D Point Cloud Generation

A 3D mesh file is generated based on the calculated depth information.

2.1.7 Display

A generated 3D mesh file is rendered by the integrated SGX544 graphics processor core, and played out on connected LCD or HDMI display monitors.

2.1.8 System Calibration

The system must be calibrated to model correct position and angles for a fixed setup. The DLP 3D Scanner SDK contains a calibration module to estimate intrinsic and extrinsic parameters of both the camera and projector. Examples of estimated parameters include focal point, lens distortion, and spatial orientation of the camera to the projector. The calibration routine must be performed any time the projector and camera change orientation with each other, or the devices are replaced.

2.2 Hardware Components

The following hardware modules are required:

- DLP LightCrafter 4500 EVM module (TI Part No. DLPLCR4500EVM), available from <http://www.ti.com/tool/dlplcr4500evm>
- AM572x Evaluation module (TI Part No. TMDSEVM572X), available from <http://www.ti.com/tool/TMDSEVM572X>
- Standard HD display monitor with HDMI port, if the optional LCD module is not available
- USB3 Industrial Camera module. In this implementation, a Flea3 camera module from Point Grey is used (<https://www.ptgrey.com/flea3-usb3-vision-cameras>). Specific models of FL3-U3-13S2C and FL3-U3-13Y3M are tested. A standard M0814-MP2 c-mount fixed lens from Computar[®] is used for the camera module. Other camera modules may be used (though they have not been tested in this design), as long as standard ARM-Linux USB3 drivers are provided.
- Mini-USB cable to connect the AM57x EVM to the DLP projector
- Micro-USB 3.0 cable to connect the AM57x EVM to the camera module

- Trigger cable, which can be assembled using instructions from the [TIDA-00254 Camera Trigger Cable Assembly Guide](#): (Drawing No. 2514095)

2.3 Assembling Hardware Setup

Connect the hardware as follows:

1. Connect the LightCrafter 4500 to the AM57x EVM USB port (either USB 2.0 or USB 3.0 port is valid) using the USB 2.0 cable.
2. Connect the Point Grey camera to the AM57x EVM USB 3.0 port using the USB 3.0 cable.
3. Connect the HDMI cable to the AM57x EVM, and power on the EVM and monitor.
4. Connect the camera trigger cable to the GPIO port of the Point Grey camera and the input trigger connector J11 of the LightCrafter 4500.
5. Power the LightCrafter 4500.
6. Power the AM572x EVM.
7. See [图 6](#) for hardware setup.



图 6. Hardware Setup of 3D Machine Vision Reference Design

2.4 Obtaining and Installing Software Modules

The system requires TI Processor SDK version 4.04 and later, the AM57x 3D scanner software package, as well as the camera module driver software. Follow these steps for obtaining processor SDK version 4.04 and later:

1. Download the *AM57xx Linux SDK Essentials* of PROCESSOR-SDK-LINUX-AM57X 04_00_00_04 from: http://software-dl.ti.com/processor-sdk-linux/esd/AM57X/latest/index_FDS.html.
2. Follow the *AM57xx Linux SDK SD Card Creation* link from the previous link to create an SD card file system for the EVM.
3. Download and install the USB3 camera driver from the camera vendor. If the Point Grey camera module is used, a standard Linux ARM driver software can be obtained from: <https://www.ptgrey.com/support/downloads>.

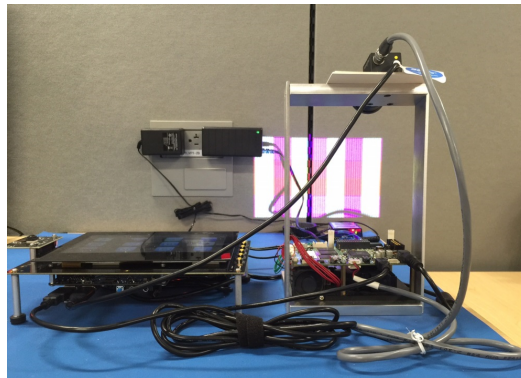
- o [] [v] FlyCapture 2.10 - Release Notes — 07/12/2016 - 43.44KB
- o [] [v] FlyCapture 2.9 - Release Notes — 07/11/2016 - 76.274KB
- o [] [v] FlyCapture 2.10.3.169 SDK - Windows (64-bit) — 07/06/2016 - 350.1416MB
- o [] [v] FlyCapture 2.10.3.169 SDK - Windows (32-bit) — 07/05/2016 - 347.1416MB
- o [] [v] FlyCapture 2.10.3.169 - Windows GTK Runtimes (64-bit) — 06/30/2016 - 63.896MB
- o [] [v] FlyCapture 2.10.3.169 - Windows GTK Runtimes (32-bit) — 06/30/2016 - 63.1408MB
- o [] [v] FlyCapture 2.10.3.169 SDK - Linux Ubuntu 16.04 (64-bit) — 06/28/2016 - 14.310MB
- o [] [v] FlyCapture 2.10.3.169 SDK - Linux Ubuntu 16.04 (32-bit) — 06/27/2016 - 14.1390MB
- o [] [v] FlyCapture 2.9.3.43 SDK - Linux Ubuntu 14.04 (64-bit) — 04/27/2016 - 11.1706MB
- o [] [v] FlyCapture 2.9.3.43 SDK - Linux Ubuntu 14.04 (32-bit) — 04/27/2016 - 11.280MB
- o [] [v] FlyCapture 2.9.3.43 SDK - ARM64 - Ubuntu 14.04 (64-bit) — 04/26/2016 - 2.1996MB
- o [] [v] FlyCapture 2.9.3.43 SDK - ARMHF - Ubuntu 14,04 (32-bit) — 04/26/2016 - 17.308MB

图 7. Available Drivers for Point Grey® Camera Module

- Follow the README file inside the FlyCapture® package to install the package on the target AM57x file system. The FlyCapture 2.9.3.43 README file directs users to the link <http://www.ptgrey.com/KB/10357> for README instructions. Go to the section *Installing the FlyCapture SDK* and follow the steps documented there. In Step 4 of the instruction set, copy the lib from the lib/C section to the system folders of the AM57x file system on target.

Copy all libraries to system folders:

```
cd flycapture-<version>_arm/lib/C
sudo cp libflycapture* /usr/lib
cd flycapture-<version>_arm/lib
sudo cp libflycapture* /usr/lib/
```

Also, FLIR (Point Grey) Flea 3.0 camera firmware version must be 2.14 or higher. If the firmware is older, the camera is not detected on USB3.0 port and is only detected as the USB2.0 device. Please contact FLIR (Point Grey) if the camera has older firmware.

- Download and install the AM57x 3D Machine Vision Software Package from here: <http://www.ti.com/tool/TIDEP0076>.
- Follow the README file in the package to install the application binaries. The steps are also mentioned in this guide.
- Download and copy dlp-sdk_2.0-r11.0_armv7ahf-neon.ipk to the AM5728 file system.
- Install (on the target) the package using `opkg install dlp-sdk_2.0-r11.0_armv7ahf-neon.ipk` (users may need to use options `--force-depends` or `--force-reinstall`). Files are installed to `/usr/share/ti/dlp-sdk` on the target file system.

[Optional step] The previous package comes with the prebuilt binary for the dlp-sdk application. The application can be recompiled by following these steps:

- Refer to *Processor SDK - Building the SDK* at http://processors.wiki.ti.com/index.php/Processor_SDK_Building_The_SDK, to set up the build environment and get familiar with how to use Bitbake. Ensure to build `arago-core-tisdk-image` (`MACHINE=am57xx-evm bitbake arago-core-tisdk-image`);
- Download the DLP-SDK source tarball (`dlp-sdk-2.0.tar.gz`) of this design guide from: <http://www.ti.com/tool/TIDEP0076>.
- Place this tarball under the `oe-layersetup/downloads` directory, and touch `oe-layersetup/downloads/dlp-sdk-2.0.tar.gz.done`.
- The recipe (`dlp-sdk_2.0.bb`) for building the DLP-SDK from the release tarball is also located under the design file folder at: (<http://www.ti.com/tool/TIDEP0076>). Create the folder `oe-layersetup/sources/meta-processor-sdk/recipes-ee/dlp-sdk`, and place the recipe above there.
- The DLP-SDK has dependency on FlyCapture (Point Grey or FLIR ARMv7 Linux shared libraries). They are released under commercial license and can be obtained from Point Grey only. Download `FlyCapture.2.9.3.43_armhf.tar.gz` from <https://www.ptgrey.com/support/downloads>.
- Place the tarball under the `oe-layersetup/downloads` directory, and touch `oe-layersetup/downloads/flycapture.2.9.3.43_armhf.tar.gz.done`
- Bitbake the dlp-sdk recipe: `MACHINE=am57xx-evm bitbake dlp-sdk`
- After the Bitbake command is successful, `./build/build/arago-tmp-external-linaro-toolchain/work/armv7ahf-neon-linux-gnueabi/dlp-sdk/<pv>-r<pr>` is created with the source code under the *example-applications* folder, and ipks under the *deploy-ipks* folder.
- Install the rebuilt DLP-SDK package (`dlp-sdk_2.0-r11.0_armv7ahf-neon.ipk`) on the target file system referring to http://processors.wiki.ti.com/index.php/Processor_SDK_Building_The_SDK#Installing_Package.

2.5 Preparation, Calibration, and Execution

Once the hardware is connected and powered up, the system is required to perform a set of calibration functions to initialize parameters based on positions, distances, and ambient light conditions of a specific setup. These steps are identical to the steps in [TIDA-00254](#), summarized as follows.

2.5.1 Configuring Camera and Scan Type

These steps are identical to Section 3.3, *Configuration the Camera and Scan Type* in [TIDA-00254](#). This design features two methods of scanning: binary gray code scanning and hybrid 3-phase scanning. The design also lets the user use the native Point Grey interface. To change the scan type, do the following (3-phase scanning implementation is alpha release):

1. After installing or building the design, find `DLP_LightCrafter_4500_3D_Scann_Application_Config.txt` in the Build or Install folder for the reference design.
2. Open the text file.

```

DLP_LightCrafter_4500_3D_Scann_Application_Config.txt - Notepad
File Edit Format View Help
#Camera type
# 0 - Uses OpenCV camera interface
# 1 - Native camera interface - PointGrey
CAMERA_TYPE = 1

# Algorithm type
# 0 - GrayCode
# 1 - Hybrid Three Phase Shift
ALGORITHM_TYPE = 0

CONNECT_ID_PROJECTOR = 0
CONNECT_ID_CAMERA = 0

CONFIG_FILE_PROJECTOR = config/config_projector.txt
CONFIG_FILE_CAMERA = config/config_camera.txt
CONFIG_FILE_CALIBRATION_PROJECTOR = config/calibration_projector.txt
CONFIG_FILE_CALIBRATION_CAMERA = config/calibration_camera.txt
CONFIG_FILE_GEOMETRY = config/geometry.txt
CONFIG_FILE_STRUCTURED_LIGHT_1 = config/algorithm_vertical.txt
CONFIG_FILE_STRUCTURED_LIGHT_2 = config/algorithm_horizontal.txt

CONTINUOUS_SCANNING = 0

CALIBRATION_DATA_FILE_PROJECTOR = calibration/data/projector.xml
CALIBRATION_DATA_FILE_CAMERA = calibration/data/camera.xml

DIRECTORY_CAMERA_CALIBRATION_IMAGE_OUTPUT = calibration/camera_images/
DIRECTORY_SYSTEM_CALIBRATION_IMAGE_OUTPUT = calibration/system_images/
DIRECTORY_CALIBRATION_DATA = calibration/data/
DIRECTORY_SCAN_DATA_OUTPUT = output/scan_data/
DIRECTORY_SCAN_IMAGES_OUTPUT = output/scan_images/

OUTPUT_NAME_IMAGE_CAMERA_CALIBRATION_BOARD = camera_calibration_board
OUTPUT_NAME_IMAGE_CAMERA_CALIBRATION = camera_calibration_capture_
OUTPUT_NAME_IMAGE_SYSTEM_CALIBRATION = system_calibration_capture_
OUTPUT_NAME_IMAGE_DEPTHMAP = _depthmap
OUTPUT_NAME_XYZ_POINTCLOUD = _pointcloud
    
```

图 8. Application Configuration File: ALGORITHM_TYPE

3. To perform a gray code scan, `ALGORITHM_TYPE` must be set to 1. To perform a hybrid 3-phase shift scan, `ALGORITHM_TYPE` must be 0. [图 8](#) shows where the value must be changed.
4. Once a selection is made save the file, then close and reopen the reference design executable (if it was running) for the changes to take effect.

注: For untriggered cameras such as a webcam, 3-phase hybrid scanning does not work due to the precise timing required. In general, any unsynchronized camera does not work with 3-phase hybrid scanning.

To change the camera interface type, do the following:

1. Follow Steps 1 and 2 for changing the scan type.
2. To change the camera type, CAMERA_TYPE, as shown in 图 9, must be edited. Enter 0 to use the OpenCV interface and 1 to use the native camera interface. Only native camera interface is supported in this design.

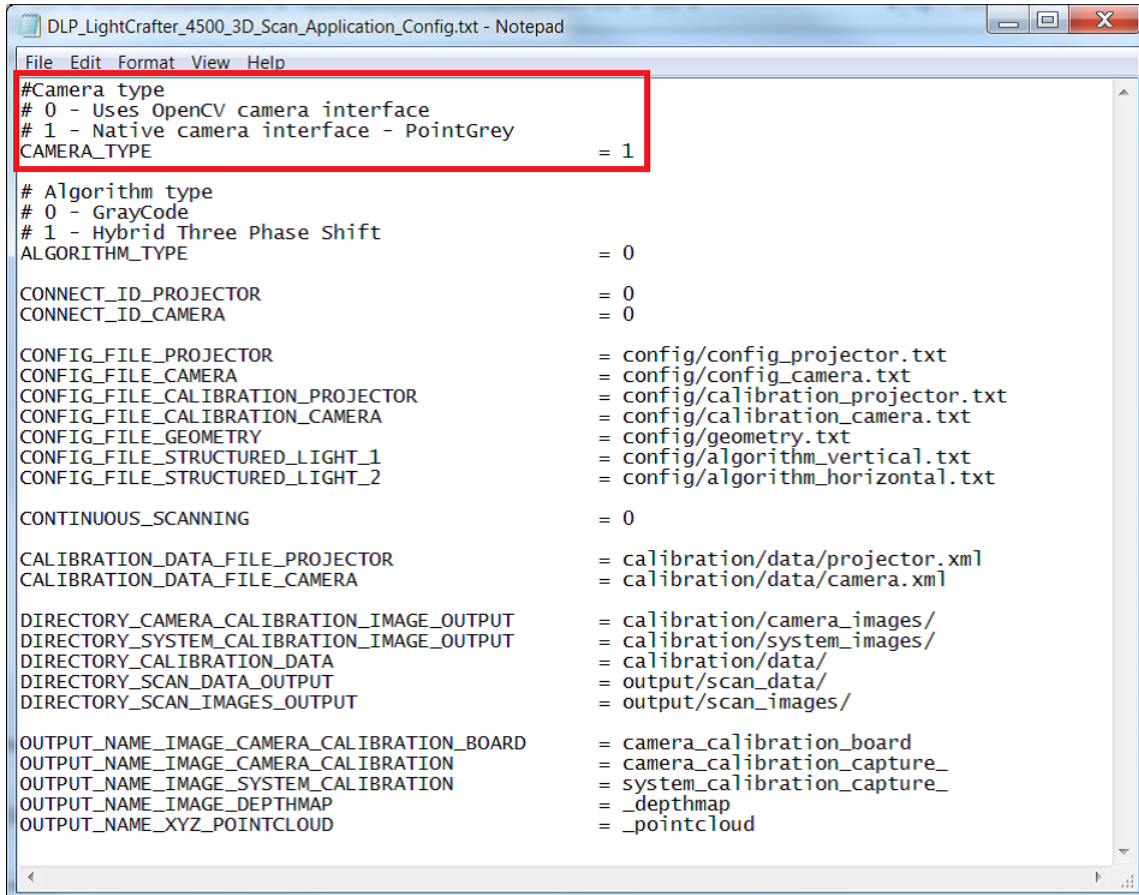

```

DLP_LightCrafter_4500_3D_Scan_Application_Config.txt - Notepad
File Edit Format View Help
#Camera type
# 0 - Uses OpenCV camera interface
# 1 - Native camera interface - PointGrey
CAMERA_TYPE = 1

# Algorithm type
# 0 - GrayCode
# 1 - Hybrid Three Phase Shift
ALGORITHM_TYPE = 0

CONNECT_ID_PROJECTOR = 0
CONNECT_ID_CAMERA = 0

CONFIG_FILE_PROJECTOR = config/config_projector.txt
CONFIG_FILE_CAMERA = config/config_camera.txt
CONFIG_FILE_CALIBRATION_PROJECTOR = config/calibration_projector.txt
CONFIG_FILE_CALIBRATION_CAMERA = config/calibration_camera.txt
CONFIG_FILE_GEOMETRY = config/geometry.txt
CONFIG_FILE_STRUCTURED_LIGHT_1 = config/algorithm_vertical.txt
CONFIG_FILE_STRUCTURED_LIGHT_2 = config/algorithm_horizontal.txt

CONTINUOUS_SCANNING = 0

CALIBRATION_DATA_FILE_PROJECTOR = calibration/data/projector.xml
CALIBRATION_DATA_FILE_CAMERA = calibration/data/camera.xml

DIRECTORY_CAMERA_CALIBRATION_IMAGE_OUTPUT = calibration/camera_images/
DIRECTORY_SYSTEM_CALIBRATION_IMAGE_OUTPUT = calibration/system_images/
DIRECTORY_CALIBRATION_DATA = calibration/data/
DIRECTORY_SCAN_DATA_OUTPUT = output/scan_data/
DIRECTORY_SCAN_IMAGES_OUTPUT = output/scan_images/

OUTPUT_NAME_IMAGE_CAMERA_CALIBRATION_BOARD = camera_calibration_board
OUTPUT_NAME_IMAGE_CAMERA_CALIBRATION = camera_calibration_capture_
OUTPUT_NAME_IMAGE_SYSTEM_CALIBRATION = system_calibration_capture_
OUTPUT_NAME_IMAGE_DEPTHMAP = _depthmap
OUTPUT_NAME_XYZ_POINTCLOUD = _pointcloud
    
```

图 9. Application Configuration File: CAMERA_TYPE

To change between using a global shutter monochrome camera and a rolling shutter color camera, edit the following:

1. Open config_camera.txt.
2. 图 10 highlights the parameters that must be changed depending on the type of camera used. For a rolling shutter color camera, ensure PG_FLYCAP_PARAMETERS_PIXEL_FORMAT is set to MONO8. If the camera is a global shutter monochrome camera, set PG_FLYCAP_PARAMETERS_PIXEL_FORMAT to RAW8.
3. Similarly, set PG_FLYCAP_PARAMETERS_STROBE_DELAY to 5.0 for rolling shutter color cameras and 0.0 for global shutter mono-chrome cameras.



图 10. Camera Shutter and Color Settings

注: To perform a hybrid 3-phase scan with both vertical and horizontal patterns, the exposure time of the projector and the camera must be increased to allow the frame buffer time to load. TI recommends setting the projector sequence exposure to more than 50 ms. 图 11 和 图 12 show some example exposure settings for the camera and projector which allow the system to perform both horizontal and vertical 3-phase scans.



图 11. Projector Exposure Settings for Vertical and Horizontal 3-Phase Scanning

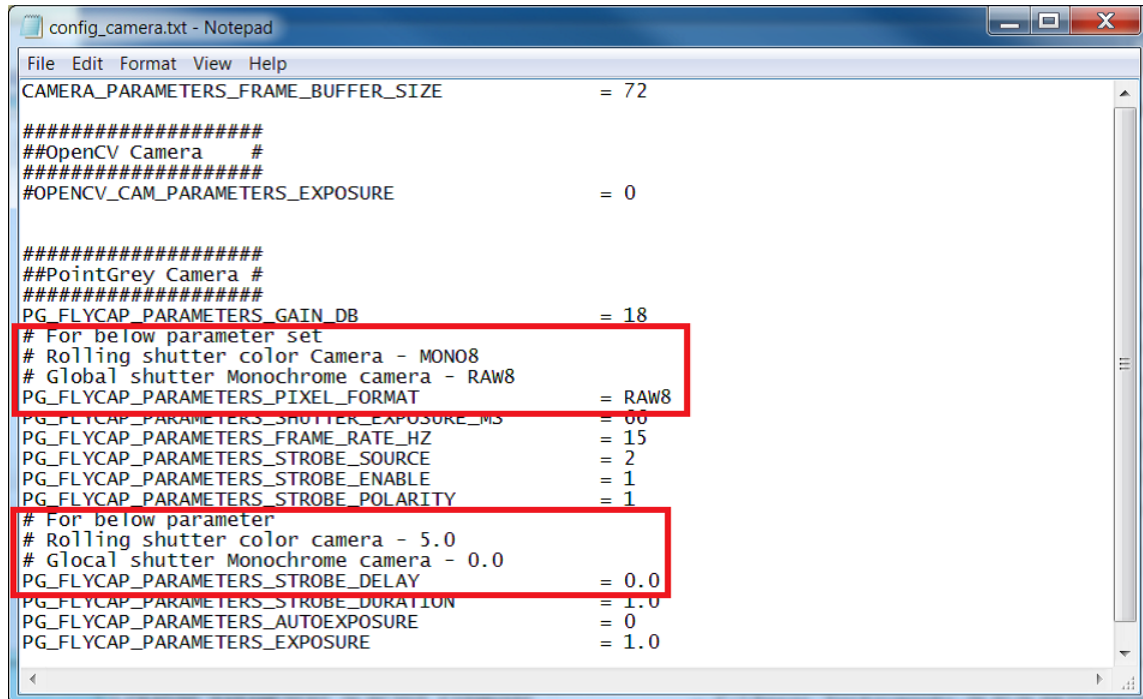

图 12. Camera Exposure Settings for Vertical and Horizontal 3-Phase Scanning

2.5.2 Preparing Projector

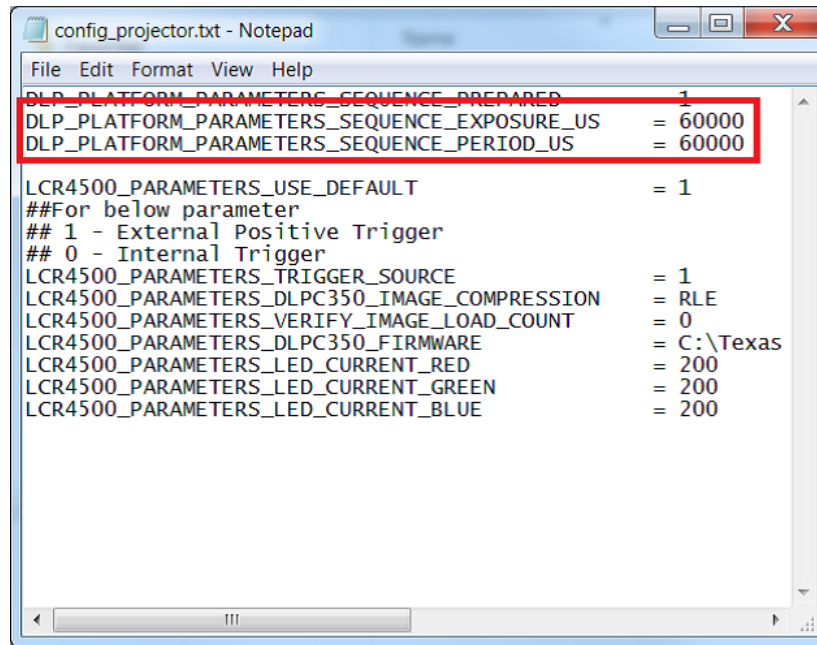
The following steps are identical to Section 3.4, *Preparing the Projector*, in [TIDA-00254](#). The LightCrafter 4500 must be prepared with the calibration images and structured light patterns for calibration and object scanning, respectively.

1. Before preparing the projector, download and install the firmware for the DLPC350.
2. In /config, open config_projector.txt, find the file path for the DLPC350 firmware, and then copy the whole path into the LCR4500_PARAMETERS_DLPC350_FIRMWARE parameter, as shown in [图 13](#).

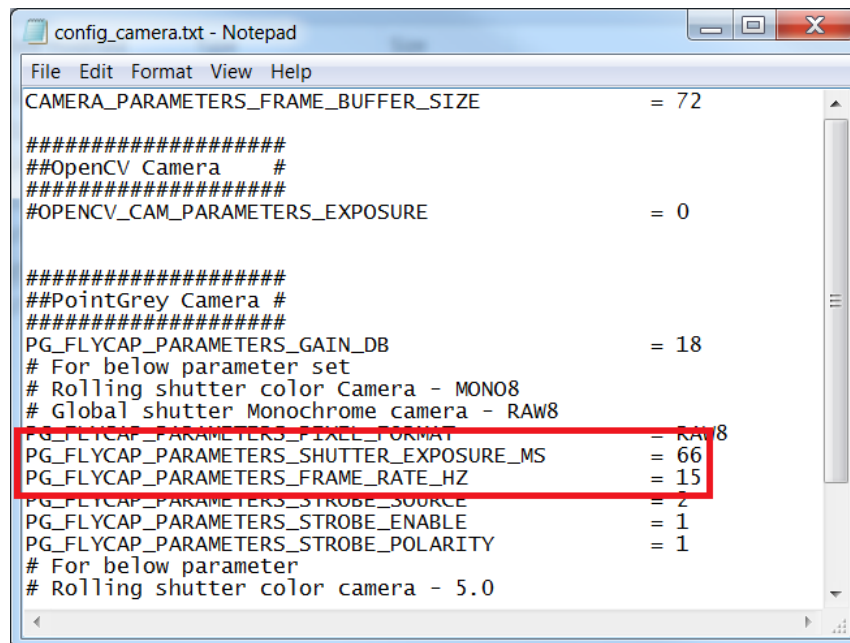
An example file path is: ./DLPR650PROM- 3.0.0/DLPR350PROM_v3.0.0.bin. The 3D Scanner Command Line program prepares the projector with the necessary images using menu option 2: *Prepare DLP LightCrafter 4500 (once per projector)*. Enter 2 in the command line, as shown in [图 14](#). A projector must be prepared only once.



图 13. DLPC350 Firmware Parameter



图 14. Prepare DLP LightCrafter™ 4500 Menu Selection

3. Once the command is entered, the program generates the calibration board. Print the camera calibration board image found in the location indicated in the prompt (calibration/camera_images/camera_calibration_board.bmp). The camera calibration board is approximately half the size of the total projection area.
4. Attach the printed calibration board to a flat, white surface that is larger than the projection area, as shown in [图 17](#). The number of squares on the grid can be changed in the configuration files for the program. The default grid is 7 × 10.

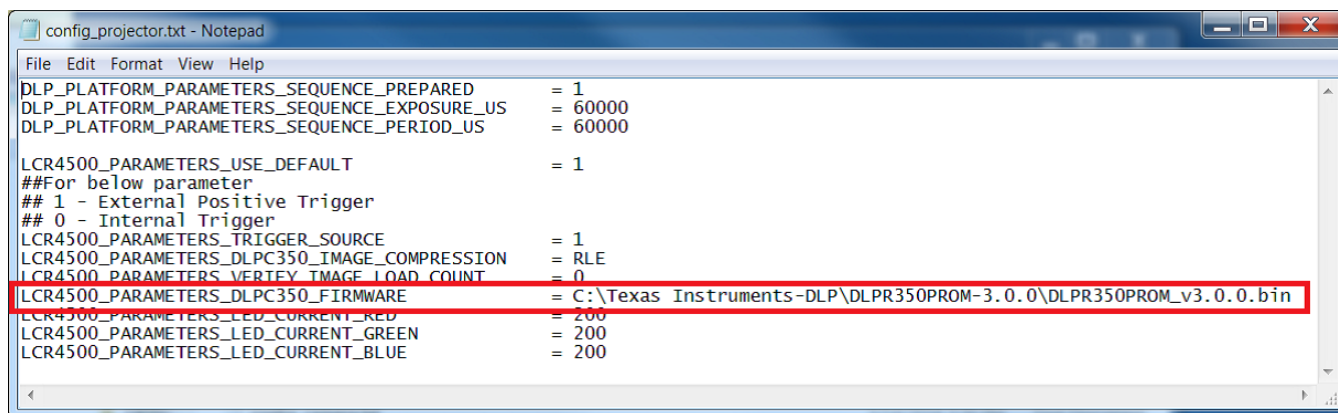

图 17. Calibration Board Attached to Flat Calibration Surface

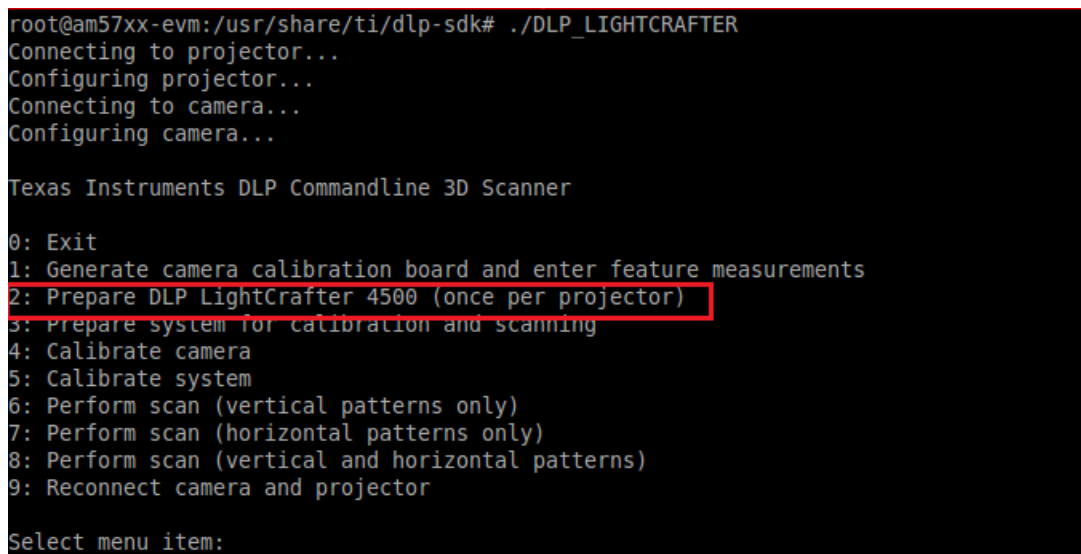
5. After attaching the camera calibration board to the calibration surface, measure the length of one side of one of the squares on the grid, and type the number into the command prompt as shown in [图 16](#). Do not enter any units in the command line and press the Enter button to continue.

注: The generated point clouds show unit-less distances. The actual units depend on how the user measured their calibration board. For example, if each square is 2 cm wide, enter 2 into the prompt. The generated point clouds show distances which appear unit-less but are actually in centimeters.

2.5.4 Calibrating Camera

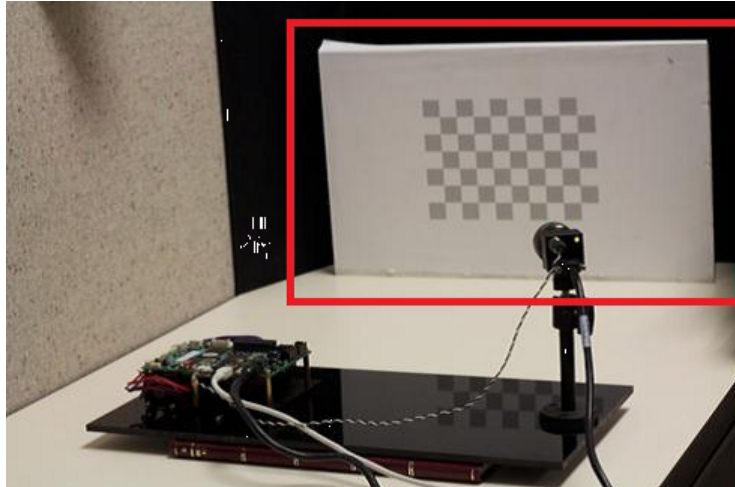
The following steps are identical to Section 3.6, *Calibrating the Camera*, in [TIDA-00254](#). This section guides the user through the process of creating the physical connections between the LightCrafter 4500, the host PC, and the Point Grey Flea3 camera, and then calibrating the camera.

注: [节 2.5.3](#) must be completed before the camera can be calibrated.

1. Connect the GPIO output trigger from the camera to the input trigger of the projector using the cable detailed in the TIDA-00254-CAMERA_TRIGGER_CABLE_ASSEMBLY.pdf file, as shown in [图 18](#).



图 18. Connecting Camera to Host EVM

2. Connect the Point Grey Flea3 camera to the host EVM USB port.
3. Connect the LightCrafter 4500 to the host EVM USB 2.0 port.
4. Ensure there is sufficient distance between the camera and the projector. The camera and projector should be separated by a 20° to 45° angle as formed by the object being scanned, as shown in [图 19](#).

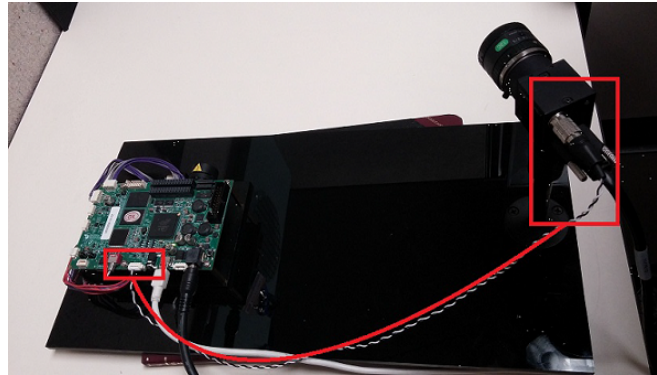

图 19. Projector, Camera, and Object Spatial Orientation

5. Enter menu option 4 to start the camera calibration. Follow the prompts and directions on the screen during the entire process.

6. A live camera view window appears on the host PC. Position the camera calibration board entirely in the frame, as shown in 图 20.

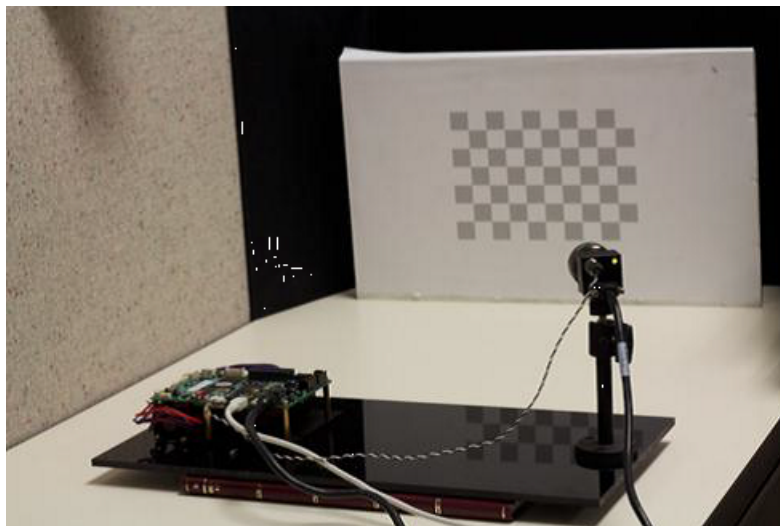

图 20. Camera Calibration Board Live View

7. Stop down the aperture as low as possible, while still being able to discern the gray and white squares on the calibration board and minimize all sources of glare. Ensure the projection area is in focus, then lock the aperture and focus. 图 21 shows an example of an overexposed image and 图 22 shows example of an underexposed image.

注: If the aperture size or focus of the camera is changed after Step 7, the resulting point cloud data is impacted. Perform camera calibration routine again if the results are undesirable.

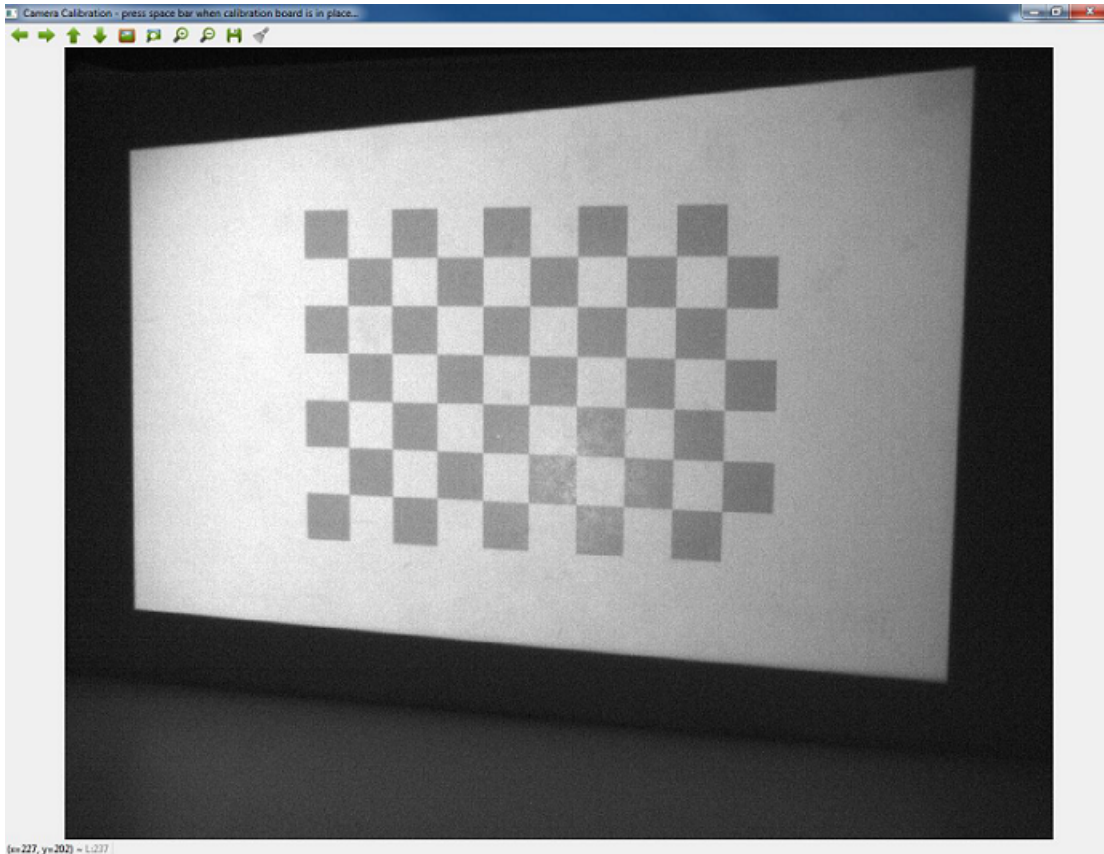

图 21. Overexposed Camera Capture



图 22. Underexposed Camera Capture

8. Click the live camera view window on the host PC, and verify the calibration board is in focus.
9. From the live camera view window, position the camera at varying angles and distances from the projection surface. Place the grid in different areas of the camera view and press the space bar to capture images.

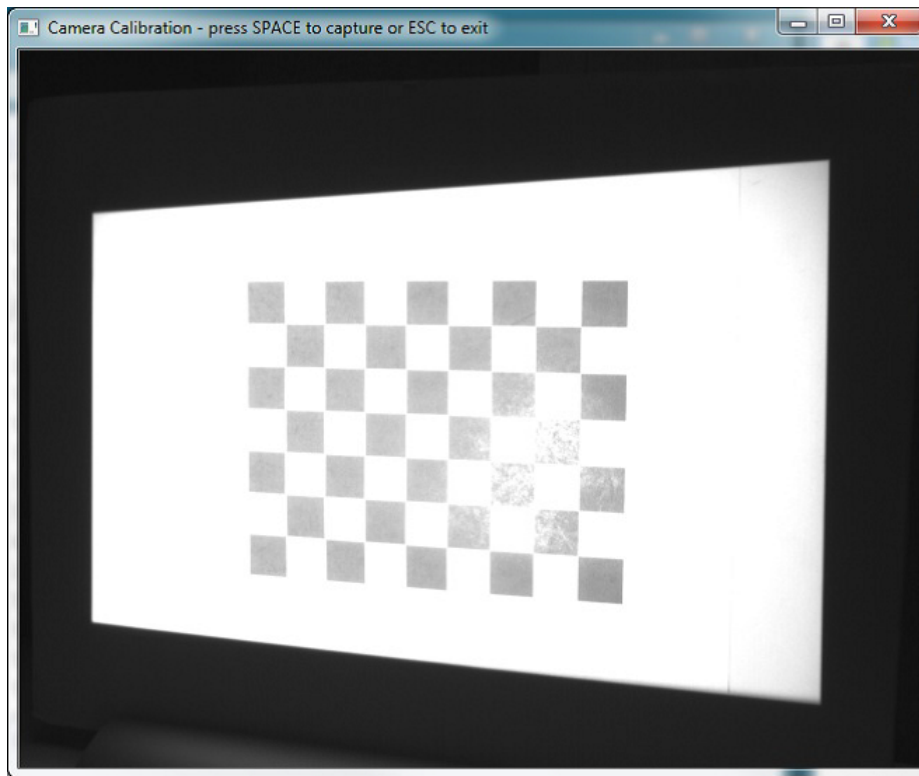
Default settings require 20 calibration images although this parameter can be adjusted. In /config, find calibration_camera.txt. 图 23 shows the parameter which specifies the number of calibration images. 图 24 shows some recommended calibration images. It is acceptable to move the camera at this point in the calibration procedure.

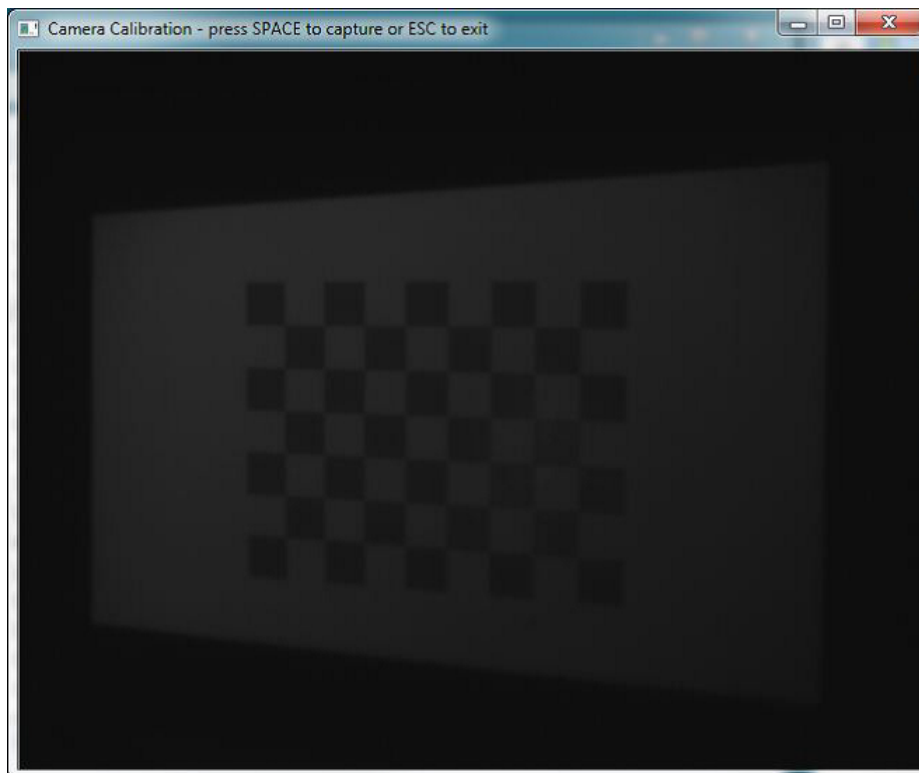

图 23. Camera Calibration Configuration File



图 24. Calibration Board Image Capture Positions

2. The projector displays a calibration board. The projected calibration board must be larger than the camera calibration board, but still fall entirely on the calibration surface. Adjust the position of the camera to center the projected calibration board in the live view (see 图 27).
3. Select the live camera view window, and press the space bar to capture the centered calibration board. Avoid glare from the projected board or the captured image is discarded by the software. Rotate the angle of the backstop on all three axes in the captured images. 图 28 shows some recommended projector calibration capture orientations. The camera captures three patterns after the space bar is clicked: solid white, black and white chessboard, and solid black.

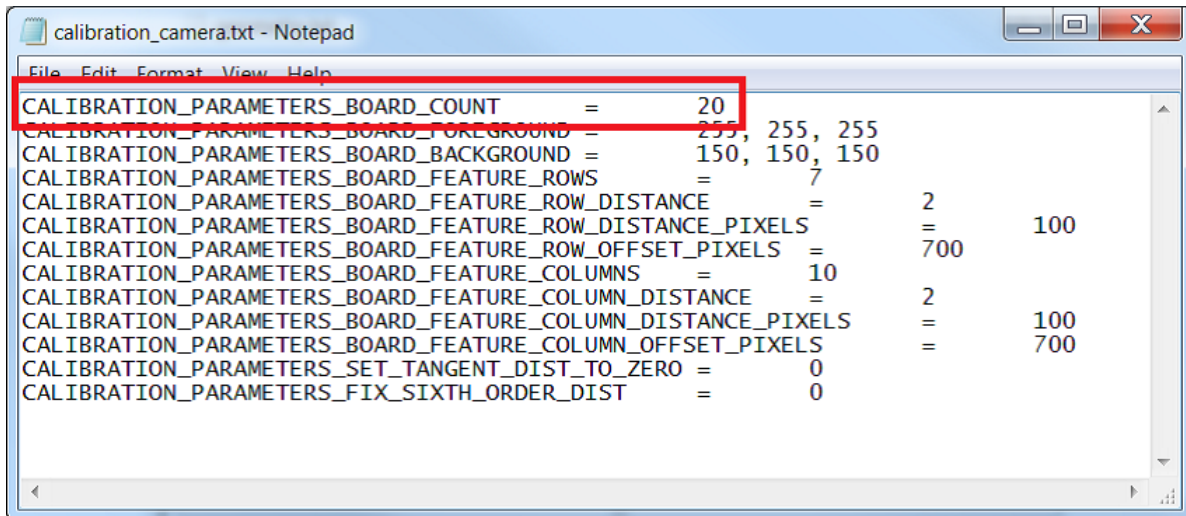

图 27. Projector Calibration Chessboard Capture

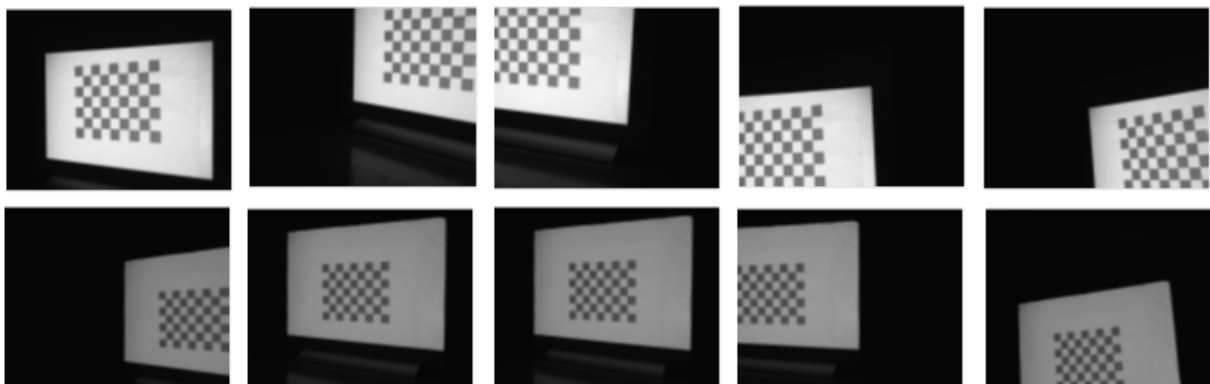

图 28. Projector Calibration Board Capture Positions 1 to 10

4. Repeat Step 3 five times, capturing various angles and positions of the calibration board by rotating and moving the calibration surface. Ensure the projected calibration board falls entirely on the calibration surface in each capture.

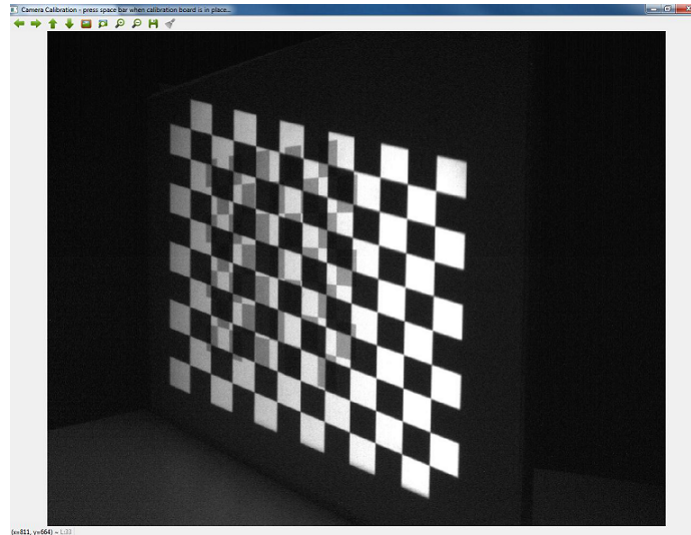
- The system calibration process estimates extrinsic and intrinsic parameters, as well as lens distortion parameters, for the projector. The system calibration also estimates the camera-projector orientation. The calibration procedure generates a reprojection error similar to the camera calibration. Zero reprojection error is ideal, however an error below two should be adequate for typical usage. If the reprojection error is not satisfactory, verify the calibration as detailed in [节 2.5.6](#) before performing the calibration again.

2.5.6 Calibration Verification

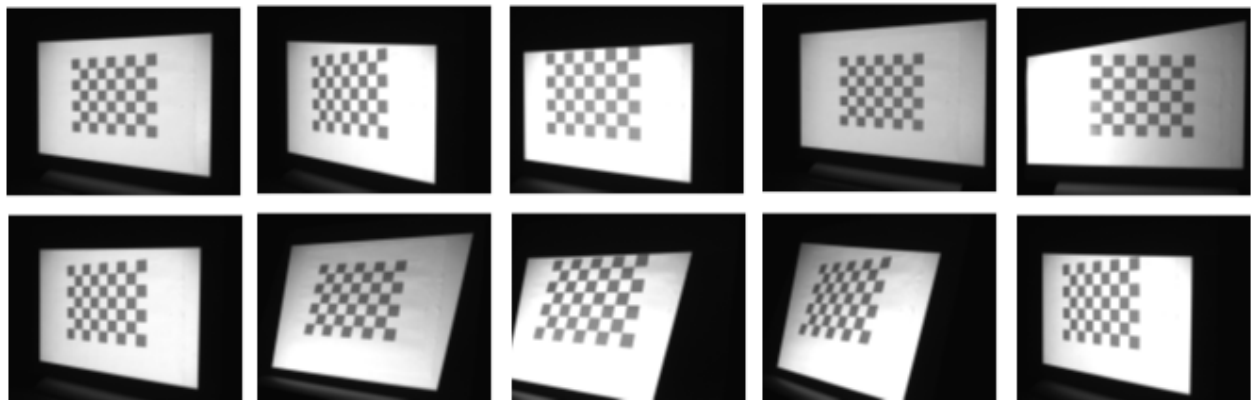
The following steps are identical to Section 3.8, Calibration Verification in [TIDA-00254](#), and were copied from there. Ignore mention of the MeshLab in the following steps for calibration on the AM57x device. The generated point cloud can be seen on the display device connected to the AM57x. Once system calibration is complete, it must be verified.

- Scan a flat, white surface, like the backdrop for the printed calibration image, by entering the perform scan command 8 in the command line menu. The output depth map should look similar to [图 29](#).



图 29. Typical Depth Map of Flat Surface

2. If the depth map is missing a significant amount of points, as shown in 图 30, check the camera and projector synchronization by looking at the captured images and verifying the gray coding is displayed correctly. It is also possible that the scene was not static. Ensure that the objects being scanned are not moving.

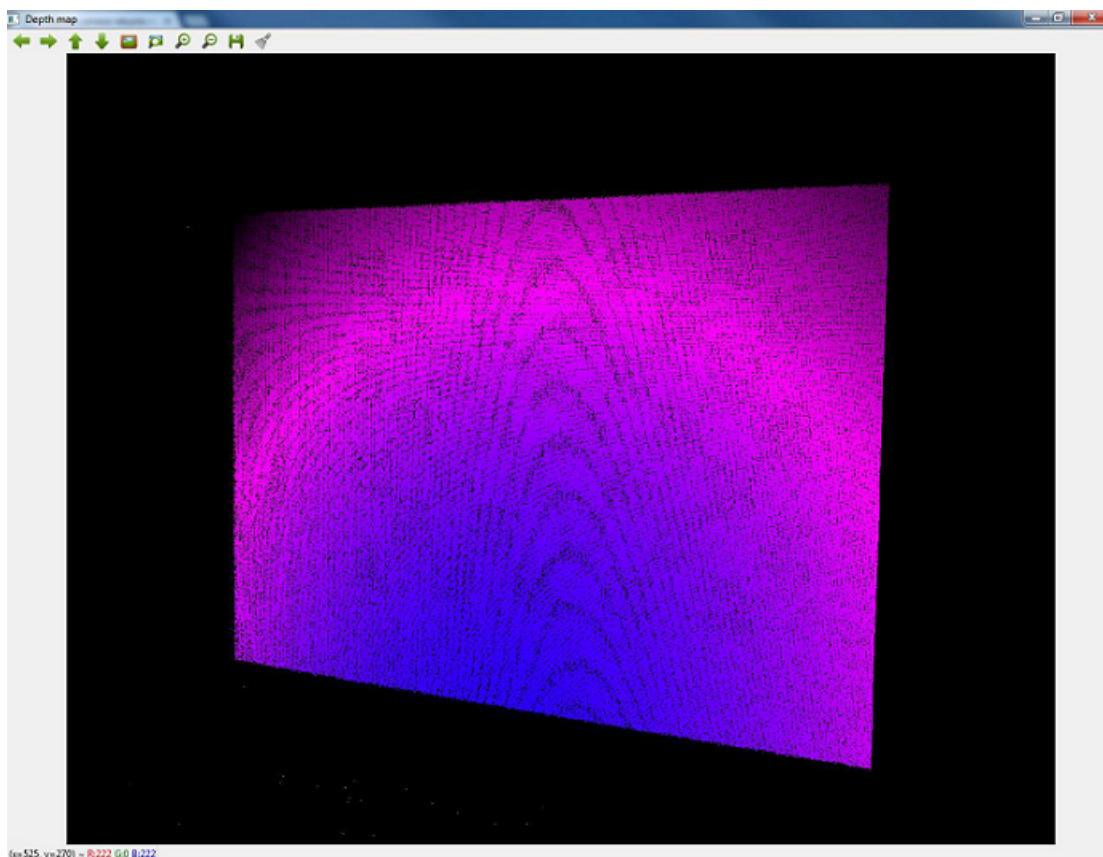

图 30. Deficient Depth Map of Flat Surface

图 31 shows a depth map with acceptable density. Optionally, users can save the point cloud (.XYZ) file and open it using MeshLab on a PC. Inspect the point cloud (on the AM57xx EVM or PC) for accurate reproduction of the scanned board.

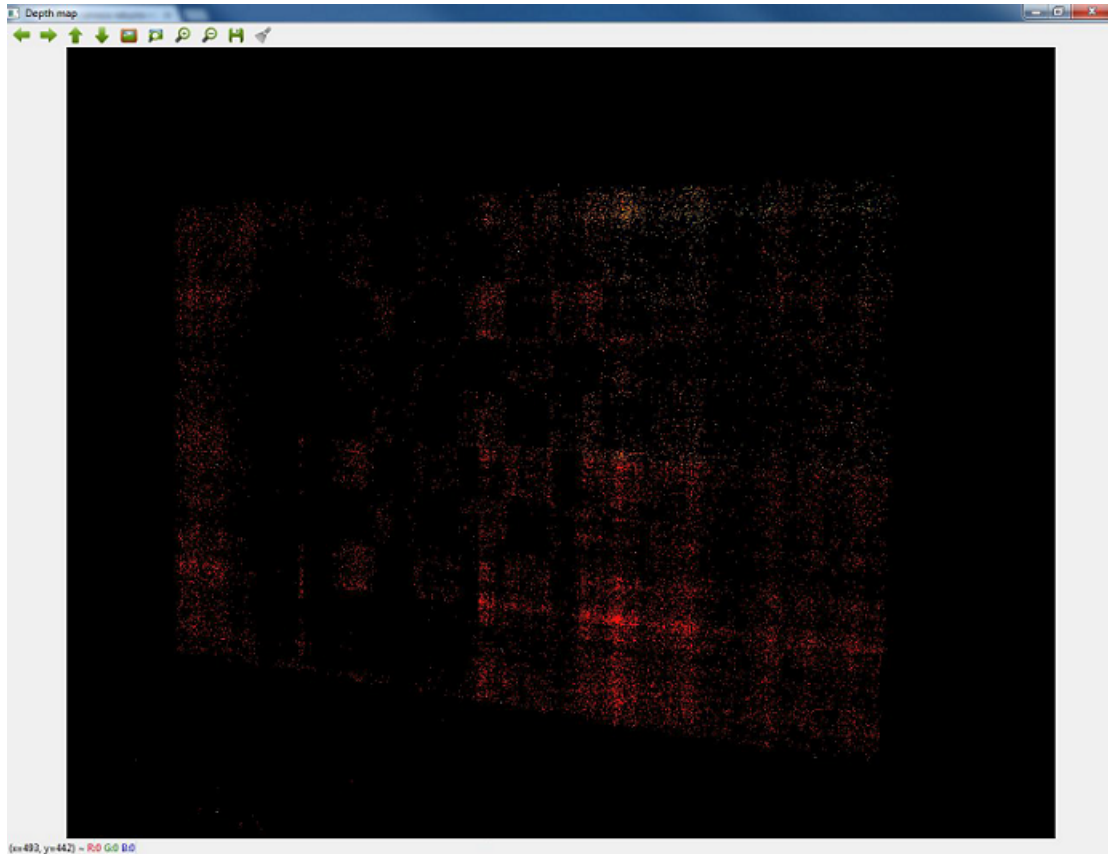

图 31. Point Cloud of Flat Surface

If the depth map is twisted or distorted around the edges, the calibration must be performed again, paying special attention to placing the printed calibration board close to the edges of the camera frame.

图 32 shows an example of an unacceptable point cloud.

注: The 3D Machine Vision Reference Design is capable of very accurate measurements. If the flat surface being scanned contains a perceivable twist, verify that the surface is not twisted before performing the calibration routine again.

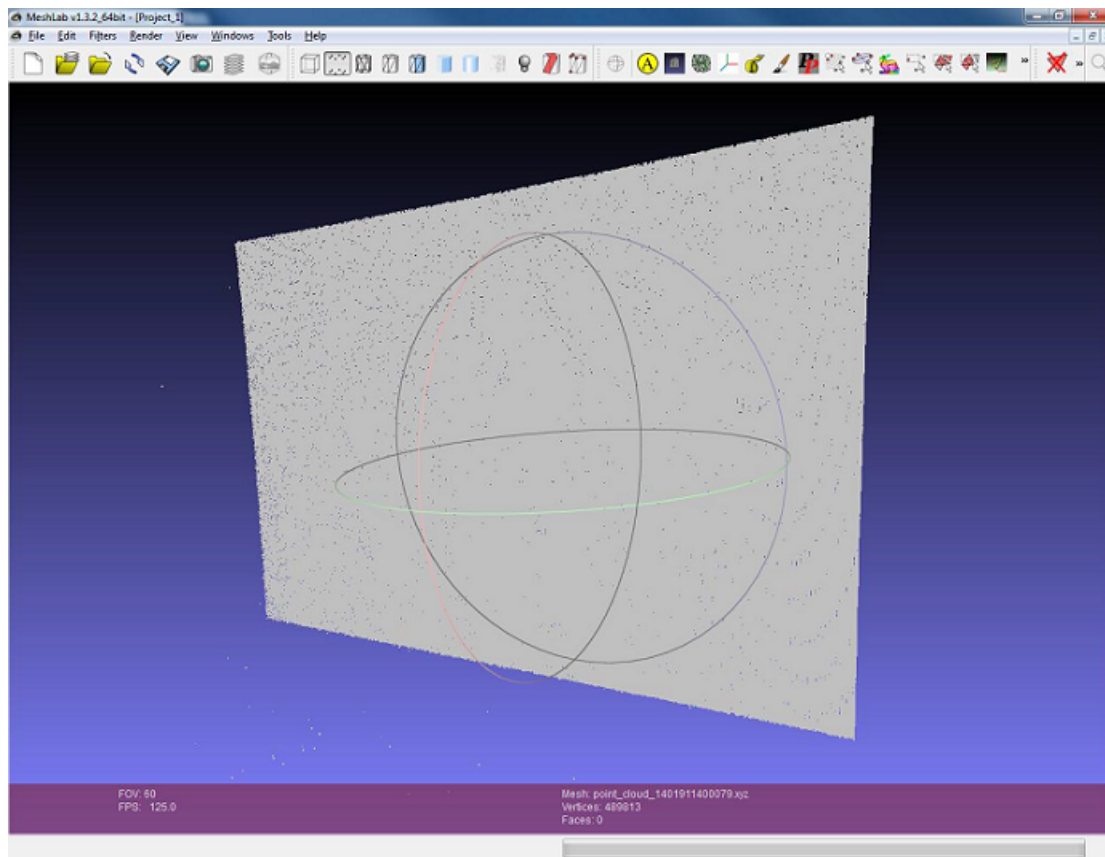

图 32. Point Cloud of Flat Surface Generated With Poor Calibration Data

2.5.7 Scan and Display 3D Object

With the system calibration complete and verified, scanning an object is done by placing the object of interest in the field of view of the camera and projector. Follow these steps:

1. Run the 3D Scanner executable file, and enter command 8: Perform scan (vertical and horizontal patterns), (see 图 33).

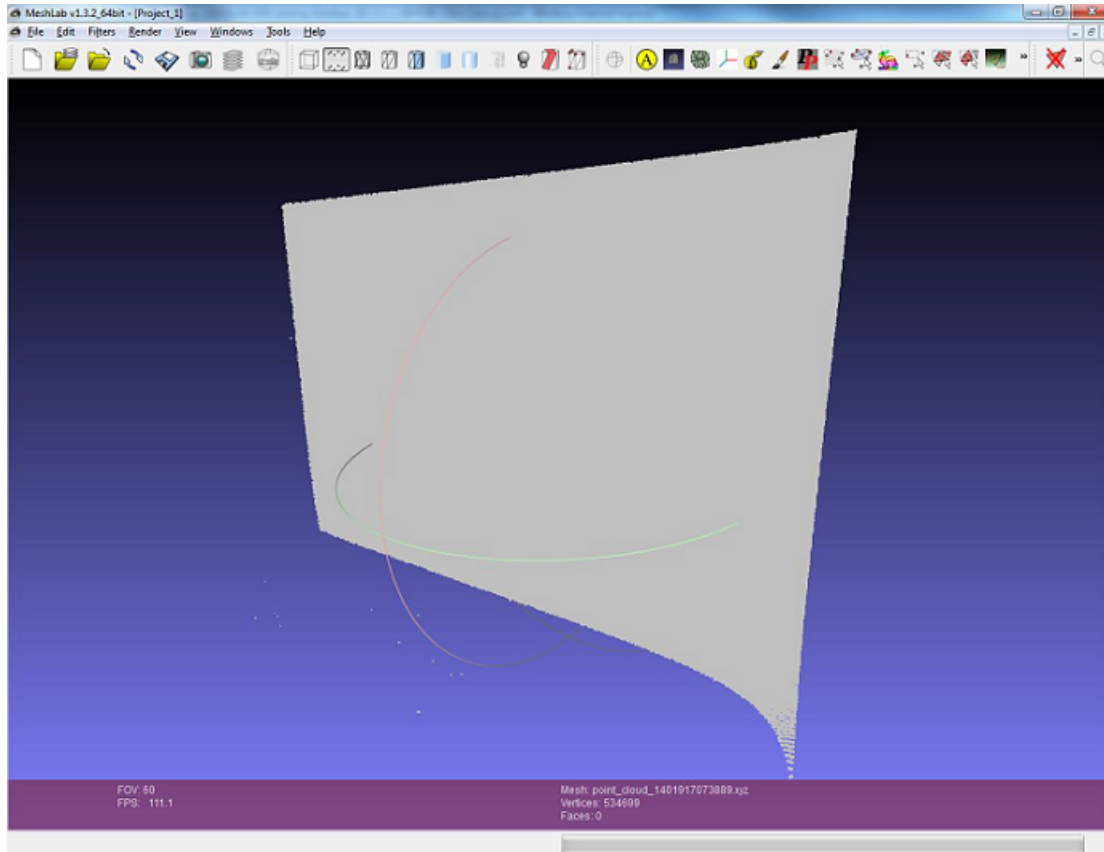

图 33. Menu Selection to Perform Scan

2. After entering command 8, the object to be scanned gets displayed on the monitor (see 图 34 and 图 35).

```

8
Loading camera and projector calibration data...
Constructing the camera and projector geometry...

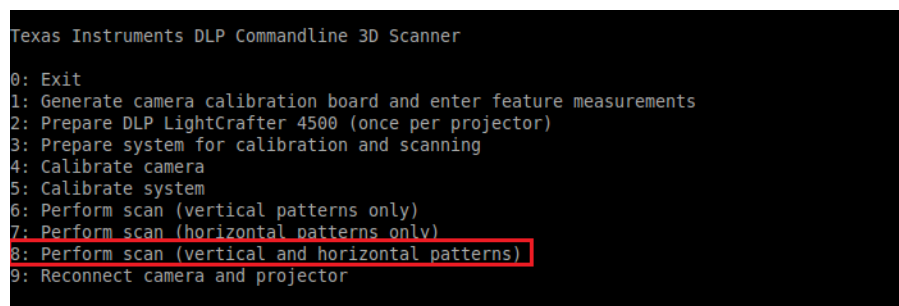
Place the scanning target within the view of the camera and projector.
Press SPACE or ESC from window when ready to scan...
No such plugin for spec "Auto"
init done
Using Wayland-EGL
wlpvr: PVR Services Initialised
    
```

图 34. Messages When Scanned Object Appears on Display



图 35. HD Display of Scanned Image

3. Adjust the camera settings so that the object to be scanned is neither too dark nor over exposed. Once the camera is set properly, place the mouse (connected to the AM57x board) cursor on the image and press the Esc or Enter button on the keyboard connected to the AM57x EVM.

- After reading the instructions on the terminal, press ENTER (see 图 36). The object scanning begins and the depth map image of the scanned object is displayed on the LCD/HDMI monitor connected to the AM57x EVM. The depth map image can be zoomed in and out by pressing the i or I (in) or o or O (out) key on the keyboard connected to the AM57x EVM. The output point cloud can be saved as an XYZ file by pressing s or S on the keyboard connected to the AM57x EVM. The XYZ file is saved in the `./output/scan_images/` directory. The XYZ images can be viewed offline using the MeshLab tool.

```
wlpvr: PVR Services DeInitialised

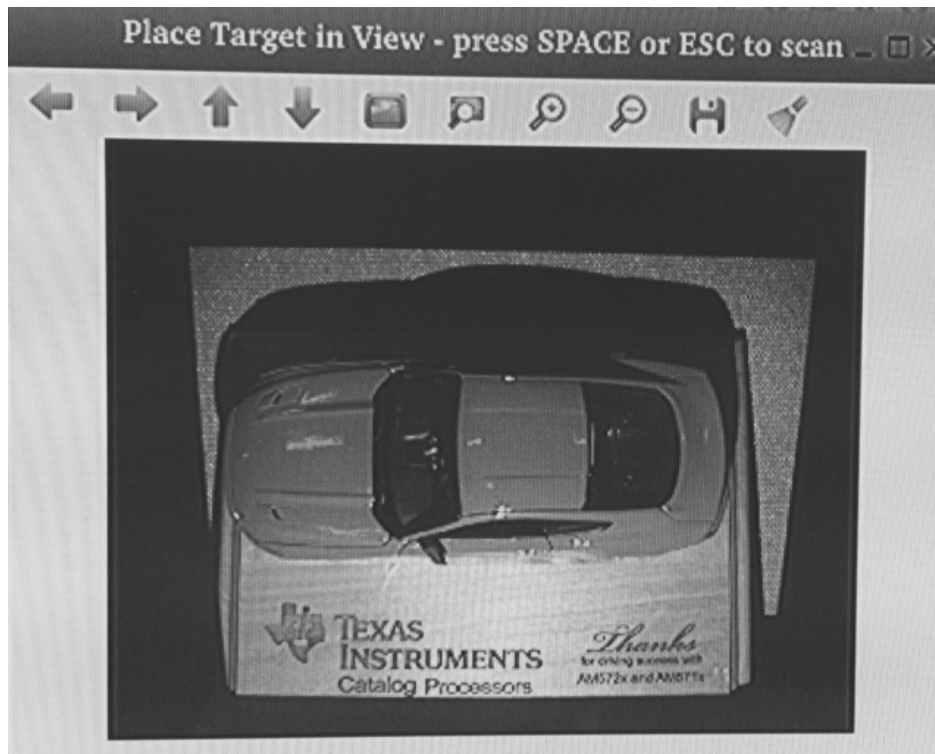
Point Cloud Viewer Operation:
i/I = Zoom in
o/O = Zoom out
s/S = Save point cloud xyz file
a/A = Auto-rotate the point cloud
c/C = Turn point cloud color on/off

NOTE: Press ESC key to quit the scan routine

Press ENTER after reading the above instructions...|
```

图 36. Menu Selections for 3D Machine Vision Functions

2.5.8 Phase 2 Optimizations

There are two modifications added in this release:

- Overlap camera stream acquisition with processing, so acquisition and processing are not sequential anymore
- Headless and batch operation: command line options are added to allow operation without typing top-level commands
- Parts of decode pattern and generate point cloud operations are offloaded from A15 to DSPs (C66x) through OpenCL (this also relaxes A15 loading):
 - LineLine intersect
 - DecodeInverted

2.5.9 Headless Operation

In this version of software, it is possible to run in batch mode (for example: without keyboard attached, but only using ssh (terminal) session).

```
root@am57xx-evm:/usr/share/ti/dlp-sdk# ./DLP_LIGHTCRAFTER -h
Usage: ./DLP_LIGHTCRAFTER , command line options:
-a          ... accumulate points in point cloud
-s          ... skip saving acquired images (performance optimization)
-b xyzd    ... sequence of commands, as sequence of digits, e.g. 380
-d [1|0]   ... display ON (1) or OFF (0)
-r scan_count ... repeat count for continuous scanning

Example: ./DLP_LIGHTCRAFTER -d 0 -b 380 -r 15
```

注: For repeated scanning operation, users must modify `DLP_LightCrafter_3D_Scan_AM57xx_Config.txt` and set the `CONTINUOUS_SCANNING` option to 1.

2.5.10 Troubleshooting

Typical problems may be related to either the AM57x EVM or the 3D scanner demo setup. For problems related to the 3D scanner setup, see Chapter 4 of [TIDA-00254](http://www.ti.com/sc/techlit/TIDA-00254) for debug steps.

For problems related to the AM57x EVM, see the [documentation](#) in the Processor SDK at http://processors.wiki.ti.com/index.php/Processor_SDK_Linux_Software_Developer's_Guide.

3 Test Data and Performance Benchmarks

表 3 lists the processing times of Phase 1 software.

表 3. Phase 1 System Processing Time

STEP	PROCESSING	CPU TIME (ms)	NOTES
1	Capture	920 ms	73 frames at 50 fps
2	File conversion	2200 ms	Majority of time spent in PG API fc2ConvertImageTo()
3	Pattern sorting	5 (550 to 600) ms	Dominated by writing acquired images to file system (can be skipped in production system)
4	Decoding patterns	380 to 450 ms	Time required for decoding a batch of 36 patterns (either horizontal or vertical) – depends on image content
5	3D point cloud generation	750 to 950 ms	Time depends on count of points in 3D cloud
–	Total processing time	4.2 to 4.5 (4.8 to 5.1) seconds	Longer time required if writing acquired images to the file system (step 3)

表 3 lists the processing times of Phase 1 software.

表 4. Phase 2 System Processing Time

STEP	PROCESSING	CPU TIME (ms)	NOTES
1	Capture	230 to 250 ms	73 frames at 50 fps. Extra time required as capture is overlapped with processing.
2	Image retrieval (from camera buffers)	300 to 320 ms	–
3	Pattern sorting	5 ms	Dominated by writing acquired images to file system (skipped here)
4	Decoding patterns	(360 to 390 ms) × 2	This is time required for decoding a batch of 36 patterns (either horizontal or vertical) – depends on image content. For both vertical and horizontal patterns, the total time is 700 to 800 ms.
5	3D point cloud generation	400 to 600 ms	Time depends on count of points in 3D cloud
–	Total processing time	1.7 to 2.0 s	Add 0.5 to 0.6 seconds if writing acquired images to the file system

3.1 Future Improvement

The Phase 1 development described in this version of the design guide is limited to ARM-based processing. Phase 2 and Phase 3, as in explained in 2 节 and 表 2, may be further developed to leverage available DSP processing capability and enabling tighter control of the synchronization. These developments may significantly reduce system processing time.

4 Design Files

4.1 Schematics

To download the schematics, see the design files at <http://www.ti.com/tool/TIDEP0076>

4.2 Bill of Materials

To download the bill of materials (BOM), see the design files at <http://www.ti.com/tool/TIDEP0076>

4.3 Assembly Drawings

To download the assembly drawings, see the design files at <http://www.ti.com/tool/TIDEP0076>

5 Software Files

To download the software files, see the design files at [TIDEP0076](http://www.ti.com/tool/TIDEP0076).

Application binary and source code are available as a single download package at <http://www.ti.com/tool/TIDEP0076>.

Reference [2.2 节](#) and [2.4 节](#) for required hardware EVM board files, as well as the SDK file system required to run the demo.

6 Related Documentation

1. Texas Instruments, [Accurate Point Cloud Generation for 3D Machine Vision Applications Using DLP® Technology and Industrial Camera](#), TIDA-00254 User's Guide (DLPU019)
2. Texas Instruments, [AM57x Software Development Kit: Processor SDK for AM57x Sitara™](#)
<http://www.ti.com/tool/PROCESSOR-SDK-AM57X>
3. Texas Instruments, [Portable Point Cloud Generation for 3D Scanning using DLP® Technology Reference Design](#), TIDA-00361 User's Guide (TIDU985)
4. MeshLab Blog, <http://meshlab.sourceforge.net>

6.1

6.1.1 商标

Sitara, Lightcrafter are trademarks of Texas Instruments.
DLP is a registered trademark of Texas Instruments.

7 About the Authors

Dr. JIAN WANG is a Chip Architect with the Catalog Processor Group. He joined TI in 2006 as a Video Systems Engineer, working on the Davinci family of digital media processors. His recent roles focus on SoC system architecture for machine vision and next-generation industrial applications.

DJORDJE SENICIC is a Senior Software Engineer with the Catalog Processor Group. He joined TI in 2000 as an embedded software engineer, working on High Density Media Gateway C55x- and C66x-based solutions. Later he worked on multicore Video Codecs on C66x and DM81xx platforms, and also TI HPC K2H platforms. His recent roles focus on Processor Linux software package for Sitara an K2 devices, including machine vision applications.

MANISHA AGRAWAL is an Applications Engineer with the Catalog Processor Group. She joined TI in 2006 as a Software Engineer working on Video Codecs for the Davinci family of digital media processors. Her recent roles focus on growing and supporting Sitara line processors for multimedia, machine vision, and industrial applications.

MARK NADESKI is a Business Development Manager in TI's Processors Business Unit. He has worked at TI since 1992. His current focus is on machine vision.

修订历史记录

注：之前版本的页码可能与当前版本有所不同。

Changes from September 8, 2016 to August 24, 2017	Page
• 已更改 information in <i>Software Development Phases</i>	8
• 已更改 <i>Figure 4. Phase 1 Software Processing Data Flow</i>	8
• 已添加 <i>Figure 5. Phase 2 Software Processing Data Flow</i>	8
• 已更改 to SDK version 4.04	11
• 已更改 to 04_00_00_04.....	11
• 已添加 information to the instructions in <i>Obtaining and Installing Software Modules</i>	12
• 已添加 <i>Phase 2 Optimzations</i> section	31
• 已添加 <i>Headless Operation</i> section	31
• 已更改 <i>Phase 1 System Processing Time</i> table	32
• 已添加 <i>Phase 2 System Processing Time</i> table	32

有关 TI 设计信息和资源的重要通知

德州仪器 (TI) 公司提供的技术、应用或其他设计建议、服务或信息，包括但不限于与评估模块有关的参考设计和材料（总称“TI 资源”），旨在帮助设计人员开发整合了 TI 产品的应用；如果您（个人，或如果是代表贵公司，则为贵公司）以任何方式下载、访问或使用了任何特定的 TI 资源，即表示贵方同意仅为该等目标，按照本通知的条款进行使用。

TI 所提供的 TI 资源，并未扩大或以其他方式修改 TI 对 TI 产品的公开适用的质保及质保免责声明；也未导致 TI 承担任何额外的义务或责任。TI 有权对其 TI 资源进行纠正、增强、改进和其他修改。

您理解并同意，在设计应用时应自行实施独立的分析、评价和判断，且应全权负责并确保应用的安全性，以及您的应用（包括应用中使用的 TI 产品）应符合所有适用的法律法规及其他相关要求。您就您的应用声明，您具备制订和实施下列保障措施所需的一切必要专业知识，能够 (1) 预见故障的危险后果，(2) 监视故障及其后果，以及 (3) 降低可能导致危险的故障几率并采取适当措施。您同意，在使用或分发包含 TI 产品的任何应用前，您将彻底测试该等应用和该等应用所用 TI 产品的功能。除特定 TI 资源的公开文档中明确列出的测试外，TI 未进行任何其他测试。

您只有在为开发包含该等 TI 资源所列 TI 产品的应用时，才被授权使用、复制和修改任何相关单项 TI 资源。但并未依据禁止反言原则或其他法律授予您任何 TI 知识产权的任何其他明示或默示的许可，也未授予您 TI 或第三方的任何技术或知识产权的许可，该等产权包括但不限于任何专利权、版权、屏蔽作品权或与使用 TI 产品或服务的任何整合、机器制作、流程相关的其他知识产权。涉及或参考了第三方产品或服务的信息不构成使用此类产品或服务的许可或与其相关的保证或认可。使用 TI 资源可能需要您向第三方获得对该等第三方专利或其他知识产权的许可。

TI 资源系“按原样”提供。TI 兹免除对 TI 资源及其使用作出所有其他明确或默示的保证或陈述，包括但不限于对准确性或完整性、产权保证、无复发故障保证，以及适销性、适合特定用途和不侵犯任何第三方知识产权的任何默认保证。

TI 不负责任何申索，包括但不限于因组合产品所致或与之有关的申索，也不为您辩护或赔偿，即使该等产品组合已列于 TI 资源或其他地方。对因 TI 资源或其使用引起或与之有关的任何实际的、直接的、特殊的、附带的、间接的、惩罚性的、偶发的、从属或惩戒性损害赔偿，不管 TI 是否获悉可能会产生上述损害赔偿，TI 概不负责。

您同意向 TI 及其代表全额赔偿因您不遵守本通知条款和条件而引起的任何损害、费用、损失和/或责任。

本通知适用于 TI 资源。另有其他条款适用于某些类型的材料、TI 产品和服务的使用和采购。这些条款包括但不限于适用于 TI 的半导体产品 (<http://www.ti.com/sc/docs/stdterms.htm>)、[评估模块](http://www.ti.com/sc/docs/sampters.htm)和样品 (<http://www.ti.com/sc/docs/sampters.htm>) 的标准条款。

邮寄地址：上海市浦东新区世纪大道 1568 号中建大厦 32 楼，邮政编码：200122
Copyright © 2017 德州仪器半导体技术（上海）有限公司