

# TI Designs: TIDA-01546

## 电池供电型智能流量计的电池和系统运行状况监控参考设计



### 说明

此参考设计展示了适用于电池供电型智能流量计电池和系统运行状况监控的创新解决方案。此电池监控子系统可实现高精度电能计量和运行状况 (SOH) 预测, 后者可预测电池使用寿命。此系统监控子系统可针对会大幅缩短电池寿命的过流状态提供保护。

本设计所展示的技术可有助于延长电池供电量表的有效期, 并优化公共事业操作人员的总体拥有成本。

### 资源

<a href="#">TIDA-01546</a>	设计文件夹
<a href="#">bq35100</a>	产品文件夹
<a href="#">ADS7142</a>	产品文件夹
<a href="#">LPV521</a>	产品文件夹
<a href="#">TPS22860</a>	产品文件夹

### 特性

- bq35100 可监控非可充电锂原电池的运行状况
- 精确预测非可充电锂电池的充放电结束 (EOS) 状况
- 采用 ADS7142 纳瓦级功率传感器监控器和 LPV521 运算放大器的低功耗系统监控
- 单通道负载开关可连接和断开系统负载
- 支持锂亚硫酰氯 (LiSOCl<sub>2</sub>) 和锂二氧化锰 (LiMnO<sub>2</sub>) 电池
- 具有用于监控系统运行状况的 1 $\mu$ A 低待机功耗和用于监控电池运行状况的 1 $\mu$ A 功耗

### 应用

- 燃气表
- 水表
- 热量计



咨询我们的 E2E™ 专家

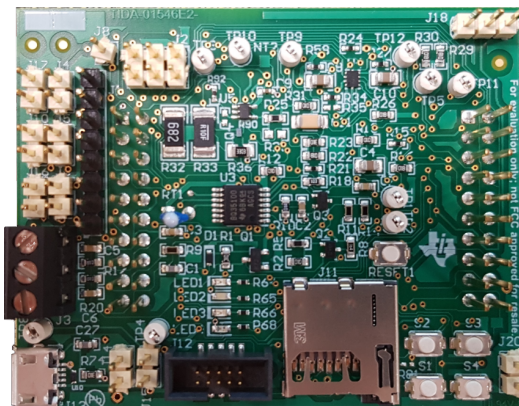
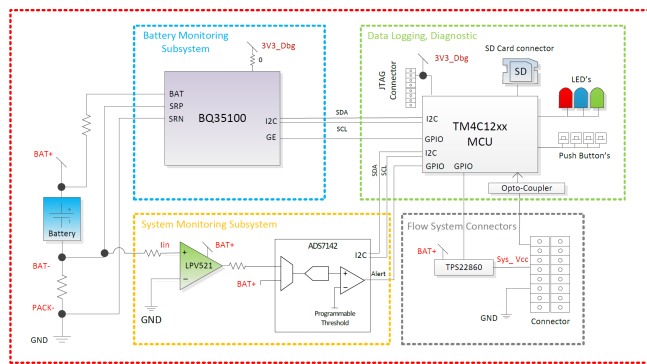

该 TI 参考设计末尾的重要声明表述了授权使用、知识产权问题和其他重要的免责声明和信息。

## 1 System Description

Smart water, gas, and heat meters continue to evolve and add new features and capabilities but must still have an operational life of at least 10 years. This standard increases pressure on battery performance. Whether due to hardware or software issues, any malfunction of the system can impact battery life and therefore product life. The battery and system monitoring solutions in this reference design help protect against such issues and provide service operators greater insight into projected product life expectancy. This insight helps the operators optimize meter replacement and service costs.

The battery monitoring circuitry accurately monitors the battery state of non-rechargeable LiSOCl<sub>2</sub> and LiMnO<sub>2</sub> batteries used in smart flow meters. The functionality of primary battery monitoring is achieved by using a bq35100 battery fuel gauge monitor, which provides the State-Of-Health (SOH) and End-Of-Service (EOS) data. The data provided by the bq35100 can be correlated with the flow meter power consumption to accurately schedule the service replacement.

The circuitry for system health monitoring monitors the health of flow meters. Any malfunctioning of the flow meter due to software or hardware issues can lead to excess current consumption and negatively impact the battery life. The system health monitoring functionality is achieved by using a ADS7142 nanopower system monitor and LPV521 op amp. The ADS7142 provides programmable threshold settings to autonomously monitor the changes in battery current and to ensure the flow meter is functioning within the operating limits.

### 1.1 Key System Specifications

表 1. Key System Specifications

PARAMETER	SPECIFICATIONS
Input voltage source	Lithium battery (3.6-V nominal voltage)
Active state current consumption	400 $\mu$ A (battery monitoring), 80 $\mu$ A (system health monitoring)
Average standby-state current consumption	1 $\mu$ A (battery monitoring), 1 $\mu$ A (system health monitoring)
Estimated battery life	Greater than 10 years
Working environment	Indoor and outdoor
Form factor	50 mm $\times$ 63 mm

## 2 System Overview

The system is designed to accurately monitor the battery state of non-rechargeable lithium batteries and control the overcurrent conditions in smart flow meters. The TM4C1294 MCU is programmed to control the bq35100 gauge monitor, ADS7142 sensor monitor, and TPS22860 load switch. The load switch provides the ability to connect or disconnect the system load (smart flow meter) and also apply a load to the battery. A microSD card is connected to the SD card slot for recording the battery monitoring data.

The battery monitoring section of the design accurately monitors the battery state of lithium non-rechargeable battery. The main battery monitoring functionality is achieved by using the bq35100 battery gauge fuel monitor. The TM4C1294 MCU communicates with the bq35100 through I<sup>2</sup>C™. The bq35100 monitor is a configurable device and can be used in three different modes based on the battery chemistry:

- SOH mode measures Lithium Manganese Dioxide (LiMnO<sub>2</sub>) cell voltage and temperature.
- EOS mode determines depth of discharge of Lithium Thionyl Chloride (LiSOCl<sub>2</sub>) batteries.
- Accumulator mode is chemistry-independent, but provides cell voltage, temperature, and accumulated discharged coulombs. This mode does not provide gauging data such as remaining SOH and EOS indication.

The system health monitoring section of the design monitors the health of the flow meter for overcurrent conditions and is implemented with the ADS7142 monitor and LPV521 op amp. The host MCU TM4C1294 communicates with the ADS7142 device through I<sup>2</sup>C. The ADS7142 device includes a digital comparator with a dedicated output pin, which is used to alert the host when a programmed high or low threshold is crossed.

### 2.1 Block Diagram

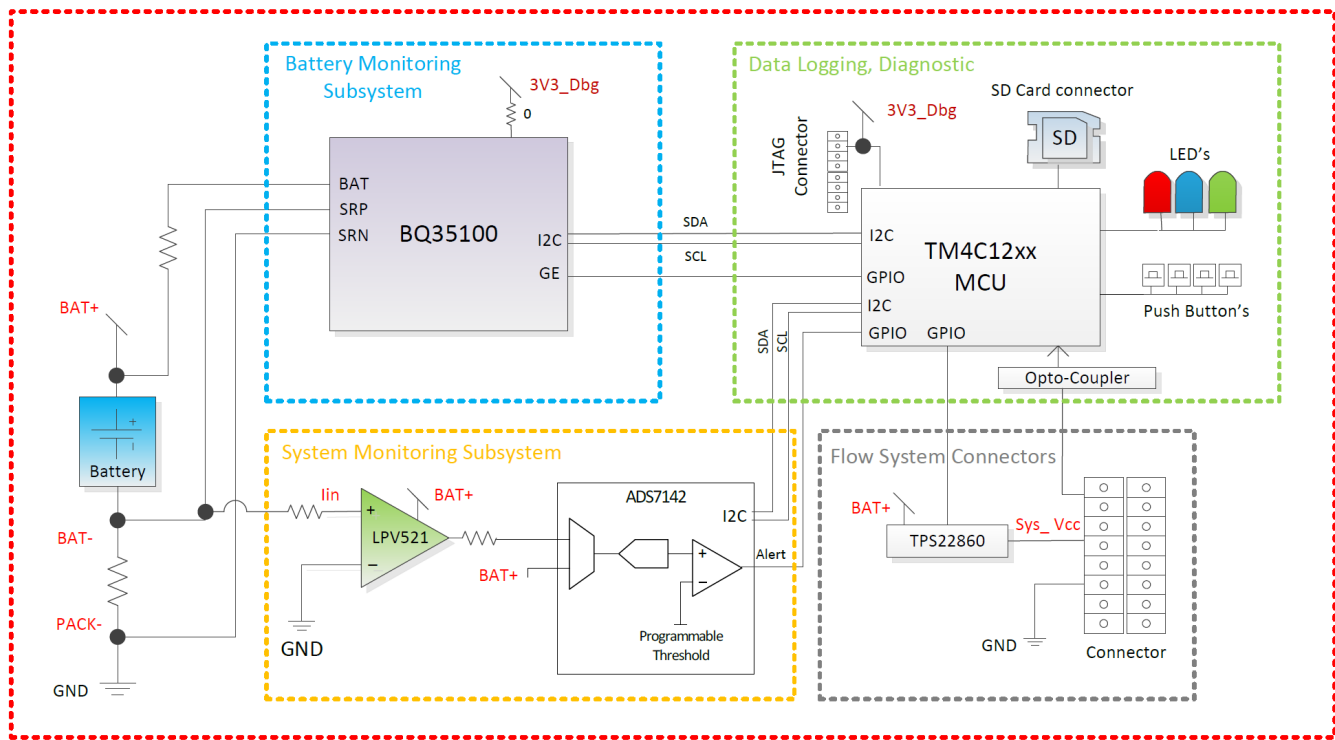

Copyright © 2018, Texas Instruments Incorporated

图 1. TIDA-01546 Block Diagram

## 2.2 Highlighted Products

### 2.2.1 bq35100

The bq35100 battery fuel gauge and EOS monitor provides highly configurable fuel gauging for non-rechargeable lithium batteries—without requiring any forced discharge of the battery. Built so that optimization is not necessary, the patented TI gauging algorithms support replaceable batteries and enable accurate results with ultra-low average power consumption through host control using the GAUGE ENABLE (GE) pin.

The fuel gauging functions use measured voltage, current, and temperature information to provide SOH and EOS data. The bq35100 device is only required to be powered long enough to gather data and to make calculations to support the selected algorithm and the frequency of updates required by the system.

The host can read the gathered data through a 400-kHz I<sup>2</sup>C bus. An ALERT output is also available to interrupt the host, based on a variety of configurable options.

### 2.2.2 ADS7142

The ADS7142 is a nanopower, dual-channel sensor monitor. The device consumes only 900 nW at a 1.8-V operation and includes an integrated digital windowed comparator with channel-independent, programmable, high and low thresholds and hysteresis for generating an ALERT output. The device supports an I<sup>2</sup>C serial interface and includes digital features such as offset calibration, a data buffer, and an accumulator.

The ADS7142 is available in a 10-pin 1.5-mm × 2.0-mm QFN package and is specified for operation from –40°C to +125°C. The miniature form-factor and extremely low power consumption make this device suitable for space-constrained and battery-powered applications.

### 2.2.3 LPV521

The LPV521 is a single nanopower 552-nW amplifier designed for ultra-long life battery applications. The operating voltage range of 1.6 V to 5.5 V coupled with typically 351 nA of supply current make it well suited for smart flow meter applications. The device has input common-mode voltage 0.1 V over the rails, ensured TC<sub>V<sub>OS</sub></sub> and voltage swing to the rail output performance. The LPV521 has a carefully designed CMOS input stage that outperforms competitors with typically 40 fA I<sub>BIAS</sub> currents. This low input current significantly reduces I<sub>BIAS</sub> and I<sub>OS</sub> errors introduced in megohm resistance, high impedance photodiode, and charge sense situations.

The LPV521 is a member of the PowerWise™ family and has an exceptional power-to-performance ratio.

The wide input common-mode voltage range, ensured 1 mV V<sub>OS</sub>, and 3.5 μV/°C TC<sub>V<sub>OS</sub></sub> enable accurate and stable measurement for both high-side and low-side current sensing.

EMI protection is designed into the device to reduce sensitivity to unwanted RF signals from cell phones or other RFID readers.

### 2.2.4 TPS22860

The TPS22860 is a small, ultra-low leakage current, single channel load switch. The device requires a VBIAS voltage and can operate over an input voltage range of 0 V to VBIAS. It can support a maximum continuous current of 200 mA.



The switch is controlled by an on/off input (ON), which is capable of interfacing directly with low-voltage control signals. The TPS22860 is available in two small, space-saving 6-pin SOT-23 and SC70 packages. The device is characterized for operation over the free-air temperature range of  $-40^{\circ}\text{C}$  to  $85^{\circ}\text{C}$ .

### 2.2.5 CSD13383F4 N-Channel FemtoFet™

This 37-m $\Omega$ , 12-V N-channel FemtoFET™ MOSFET technology is designed and optimized to minimize the footprint in many handheld and mobile applications. This technology is capable of replacing standard small signal MOSFETs while providing at least a 60% reduction in footprint size.

### 2.2.6 TPD1E10B06 Single-Channel ESD

The TPD1E10B06 device is a single-channel electrostatic discharge (ESD) transient voltage suppression (TVS) diode in a small 0402 package. This TVS protection product offers  $\pm 30\text{-kV}$  contact ESD,  $\pm 30\text{-kV}$  IEC air-gap protection, and has an ESD clamp circuit with a back-to-back TVS diode for bipolar or bidirectional signal support. The 12-pF line capacitance of this ESD protection diode is suitable for a wide range of applications supporting data rates up to 400 Mbps. The 0402 package is an industry standard and is convenient for component placement in space-saving applications.

## 2.3 System Design Theory

The system is designed for both accurately monitoring the battery state of lithium non-rechargeable batteries, and system health monitoring of battery-powered smart flow meters. With smart flow meters expected to last for over 10 years in the field, the battery monitoring and system health monitoring implementation helps extend the lifetime of the battery. The TM4C1294 MCU included in the system aids in testing by controlling the bq35100 gauge monitor, the ADS7142 sensor monitor, and TPS22860 load switch and log the battery data onto an SD card. The load switch provides the ability to connect or disconnect the system load (smart flow meter), and apply a load to the battery.

### 2.3.1 Battery Monitoring

The bq35100 gauge monitor provides highly configurable fuel gauging for non-rechargeable lithium batteries. The fuel gauging functions uses measured voltage, current, and temperature information to provide SOH and EOS data. The bq35100 device is only required to be powered long enough to gather data and to make calculations to support the selected algorithm and the frequency of updates required by the system.

The host can read the gathered data through a 400-kHz I<sup>2</sup>C bus. An ALERT output is also available to interrupt the host, based on a variety of configurable options.

The device has extended capabilities, including the following:

- Fuel gauge for single- and multi-cell primary (non-rechargeable) batteries
- Supports Lithium Thionyl Chloride (LiSOCl<sub>2</sub>) and Lithium Manganese Dioxide (LiMnO<sub>2</sub>)
- Provides four configurable algorithm options:
  - Coulomb accumulation (ACC)
  - SOH
  - EOS
- Ultra-low average power consumption supported through gauge-enable control and mode control modes

- Accurate coulomb counter, voltage, and temperature measurement options
- I<sup>2</sup>C host communication, providing battery parameter and status access
- Data logging options

The bq35100 device uses voltage, current, and temperature parameters to provide the amount of energy remaining in the battery, which can be correlated with the system power consumption to accurately schedule the service replacement.

In addition, several battery condition warnings are available such as:

- Battery Low
- Temperature Low
- Temperature High
- Battery Low SOH
- Battery EOS

The bq35100 device can be configured in data collection mode to collect the battery in-service data, including min and max cell voltages, discharge current, and temperature, which can be used for maintenance purposes when the product reaches the end of its life cycle. For example, such information can help to optimize the software running in the MCU by correlating the code with voltage, current, and temperature conditions.

The basic measurement systems and bq35100 configurations details are provided in the following subsections.

### 2.3.1.1 Voltage

The bq35100 device measures the BAT input, which is scaled by an internal translation network, through the ADC. In systems where the battery voltage is greater than the maximum specified value of  $V_{IN(BAT)}$  (for example, 2-series cell or more), an external voltage scaling circuit is required. If [EXTVCELL] is set, then the voltage is measured using the VIN pin. The input to VIN must be scaled to a maximum of 1 V.

The VEN pin can be used to enable and disable the external divider to conserve power. The firmware then scales this < 1-V value to reflect an average cell value, and then again by the number of series cells to reflect the full battery voltage value.

### 2.3.1.2 Temperature

The device can measure temperature through an integrated temperature sensor or an external NTC thermistor. Only one source can be used, and the selection is made by setting Operation A [TEMPS] appropriately. The resulting measured temperature is available through the Temperature() command. The internal temperature sensor result is also available through the InternalTemperature() command.

When an external thermistor is used, REG25 (pin 7) is used to bias the thermistor, and TS (pin 11) is used to measure the thermistor voltage (a pulldown circuit is implemented inside the device and is only enabled when measurements are required). The device then correlates the voltage to temperature, assuming the thermistor is a Semitec 103AT or similar device.

A configurable option allows the host to write the temperature to the Temperature() command when [WRTEMP] = 1. This option is disabled by default.

### 2.3.1.3 Coulombs

The integrating delta-sigma ADC in the device measures the discharge flow of the battery by measuring the voltage drop across a small-value sense resistor between the SRP and SRN pins.

The 15-bit integrating ADC measures bipolar signals from  $-0.125$  V to  $+0.125$  V. The device continuously monitors the measured current and integrates this value over time using an internal counter.

### 2.3.1.4 Current

For the primary battery current, the standard delta-sigma ADC in the device measures the discharge current of the battery by measuring the voltage drop across a small-value sense resistor between the SRP and SRN pins, and is available through the Current() command. The measured current also includes the current consumed by the device.

### 2.3.1.5 Battery Gauging

The bq35100 device can operate in three distinct modes: Accumulator (ACC) mode, SOH mode, and EOS mode. The device can be configured and used for only one of these modes in the field. because the bq35100 is not intended to be able to actively switch between modes when in normal use.

#### 2.3.1.5.1 Accumulator Mode

In this mode, the bq35100 device measures and updates cell voltage, cell temperature, and load current every 1 s. This data is provided through the I<sup>2</sup>C interface while ControlStatus() [GA] is set. When in Accumulator mode, the bq35100 device tracks and then can store the total accumulated capacity to its internal data flash.

When the GE pin is asserted, the device updates AccumulatedCapacity() from the value stored in data flash. When ControlStatus() [GA] is set, the device adds each coulomb counter measurement to the value of AccumulatedCapacity().

Sending the GAUGE\_STOP command prior to the GE pin being pulled low initiates the latest value of AccumulatedCapacity() to be written to data flash memory. As this operation takes a finite amount of time, the gauge asserts [G\_DONE] in ControlStatus() and can optionally trigger the ALERT pin to inform the host when the operation is complete.

#### 2.3.1.5.2 SOH Mode

This mode is enabled when [GMSEL1:0] in Operation Config A = 01. This mode is suitable for determining SOH for Lithium Manganese Dioxide (LiMnO<sub>2</sub>) chemistry. In this mode, cell voltage and temperature are precisely measured immediately after the GE pin is asserted. The gauge uses this data to compute SOH.

$SOH = DOD(TermV) - DOD(OCV, temperature)$ , where TermV is a DF constant determined by the manufacturer to be discharge voltage below which the cell cannot provide the power required by the device. A Battery Low SOH warning can optionally trigger the ALERT pin when the primary battery SOH falls below a programmable threshold.

### 2.3.1.5.3 EOS Mode

This mode is enabled when [GMSEL1:0] in Operation Config A = 10. This mode is suitable for gauging Lithium Thionyl Chloride (LiSOC12) cells. The EOS gauging algorithm uses voltage, current, and temperature data to determine the resistance (R) and rate of change of resistance of the battery. The resistance data is then used to find Depth of Discharge (DOD) = DOD(R). As described in [节 2.3.1.5.2](#), SOH is determined and in turn is used to determine the EOS condition.

When in EOS mode, issue a GAUGE\_START() command prior to any major discharge activity. This command ensures that any major discharge pulses are used in the determination of the battery's condition. When any major discharge completes, send the GAUGE\_STOP() command to the device. The gauge continues to collect data in a low power state for the number of seconds determined by *R Data Seconds*. The device then completes any calculations and flash writes. Once these tasks are completed, then [G\_DONE] is set and the device can be powered down.

For optimal accuracy, the first event where the device updates its impedance value is required to be when the battery is full (a fresh battery). If the battery is partially discharged, then the accuracy of the EOS detection is compromised. When a new battery is inserted, send the NEW\_BATTERY() command to the device to ensure the initial learned resistance RNEW is refreshed correctly.

In some cases, it is necessary to compensate for anode passivation effects if there is a delay between when the battery is conditioned for use and when the device is put into service. Several initial impedance readings can be discarded to remove passivation effects by setting an appropriate value for New Batt R Scale Delay.

## 2.3.2 System Health Monitoring

The size of the energy source is usually scaled to meet the system energy consumption and expected lifetime in the field. This size is not always accurate due to unforeseen issues that can occur, which prevent the smart flow meter from operating as expected. A malfunction of the flow meter due to hardware, software, or unplanned environmental issues can lead to excess current consumption and impact battery life. The system health monitoring solution monitors for overcurrent conditions and triggers a signal when an issue occurs. This signal allows for maintenance actions to be taken in a timely manner without impacting consumer service.

Current consumption of smart flow meters can vary widely depending on its mode of operation. [表 2](#) lists typical meter load profiles.

**表 2. Typical Meter Load Profiles**

MODE	CURRENT CONSUMPTION
Low-power standby	100 nA to 10 $\mu$ A
Active mode	1 mA to 12 mA
Active mode with RF transmission	> 100 mA

The system monitoring circuitry is designed to detect if some fault condition is causing any of these modes to operate outside of the expected current consumption range. To implement system monitoring circuitry, a single nanopower LPV521 amplifier is used to amplify the current. The amplified current is fed to the ADS7142 nanopower sensor monitor, which can be configured with voltage thresholds corresponding to current limits for each mode of operation by the host MCU. The ADS7142 autonomously monitors the current and provides a signal on the ALERT pin when the current limits are exceeded.

### 3 Hardware, Software, Testing Requirements, and Test Results

#### 3.1 Required Hardware and Software

##### 3.1.1 Hardware

图 2 shows the hardware details.



图 2. TIDA-01546 Hardware Description

The jumpers and battery input terminal block are located to the left side of the board. Several tests points, the JTAG header, SD card connector, push-buttons, LEDs, and circuitry for battery and system health monitoring are located on the top side of the PCB.

##### 3.1.1.1 Jumper Configuration

To facilitate measuring critical parameters and debugging the reference design, there are several jumpers included. However, to operate the design properly, the jumpers must be installed correctly. The jumper configuration for normal operation is J1 (pins 1,2): Shorted, J16: Shorted, and J5: Shorted. J20 can be shorted to use the optional load switch available on the board.

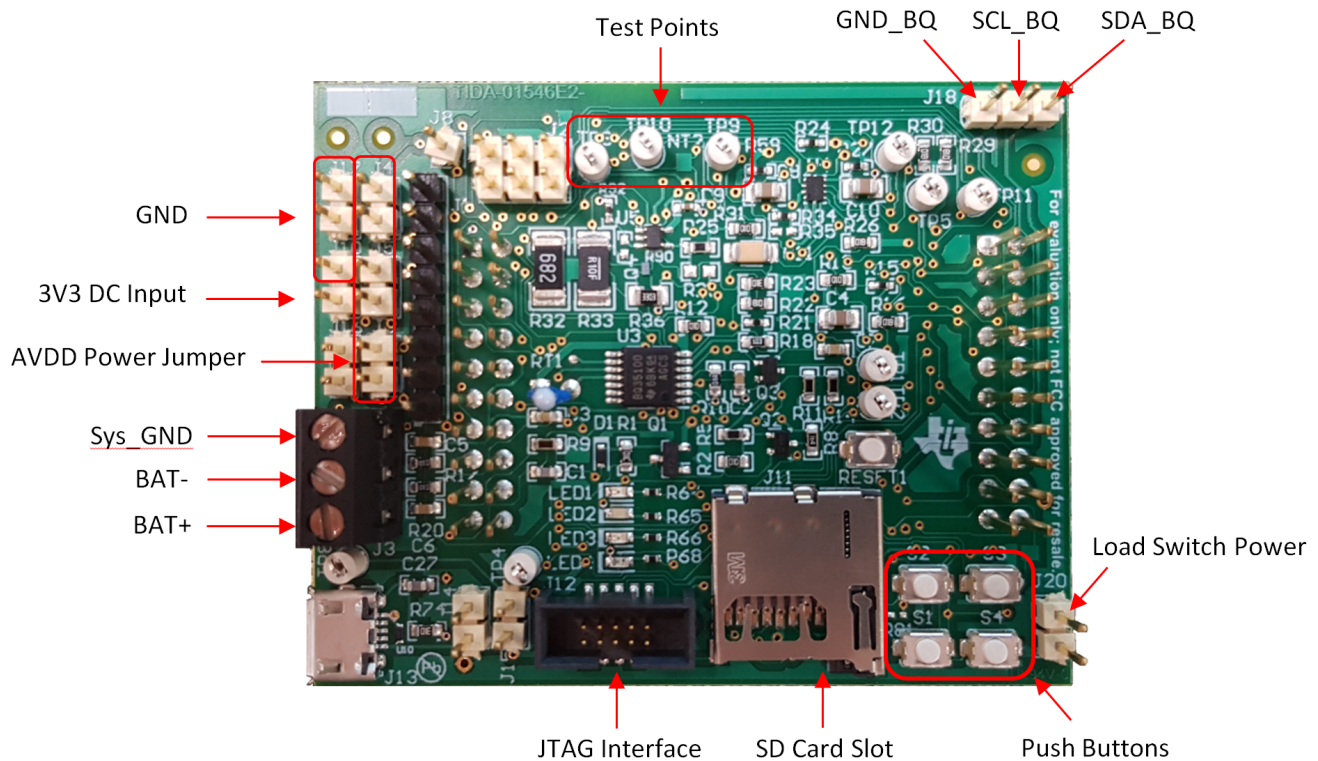
The following table describes the main configuration used during the tests:

Configurations	J1	J2	J4	J5	J6	J14	J15	J16	J20
Single Cell + ADS7142 power from supply (default)	1-2 shorted	not shorted	not shorted	shorted	not shorted	Can be used with J15	Can be used with J14	shorted	Can be used for load simulation
Single Cell + ADS7142 power from battery	1-2 shorted	not shorted	shorted	not shorted	not shorted	Can be used with J15	Can be used with J14	shorted	Can be used for load simulation
Multi Cell + ADS7142 power from supply	3-4 and 5-6 shorted	1-2 = 2S, 3-4 = 3S, 5-6 = 4S	not shorted	shorted	not shorted	Can be used with J15	Can be used with J14	shorted	Can be used for load simulation
Multi Cell + ADS7142 power from battery	3-4 and 5-6 shorted	1-2 = 2S, 3-4 = 3S, 5-6 = 4S	shorted	not shorted	not shorted	Can be used with J15	Can be used with J14	shorted	Can be used for load simulation

The following table describes how the different jumpers can be used on the PCB:

Jumper	Action
J1	bq35100 configuration (single cell or multi cell)
J2	bq35100 configuration (multi cell configuration)
J3	Battery and Load connector
J4	Power ADS7142 from the battery if shorted
J5	Power ADS7142 from the 3V3 power supply if shorted
J6	Power ADS7142 from the load switch output if shorted
J7	Booster pack connector
J9	Booster pack connector
J10	Power supply connector, do not short
J14	Connect BAT+ to Vbus of the micro USB plug
J15	Connect BAT+ to Ground of the micro USB plug
J16	Power bq35100 from the 3V3 power supply if shorted
J17	Ground connector
J18	bq35100 I <sup>2</sup> C connector
J20	Connect BAT+ to the load switch input



### 3.1.2 Software

#### 3.1.2.1 State-of-Health (SOH) Mode

The SOH mode is suitable for determining SOH for Lithium Manganese Dioxide (Li-MnO<sub>2</sub>) chemistry. In this mode, cell voltage and temperature are precisely measured immediately after the GE pin is asserted. The gauge uses this data to compute SOH. Once the initial update occurs and the host reads the updated SOH, the device can be powered down.

图 3 describes the operation of the battery monitoring software in State of Health mode.



图 3. Flow Chart of SOH Mode Software

To configure the bq35100 gauge to use the SOH mode, the following data flash configuration variables must be configured correctly. For more details, including information on Operation Config A [GMSEL], see the bq35100 Technical Reference Manual (SLUUBH1).

The following steps show how to use the SOH mode:

- Step 1. Set GE high to power up the bq35100 gauge and wait for ALERT to go low due to INITCOMP=1.
- Step 2. Clear ALERT (read BatteryStatus()).
- Step 3. Read any required data such as State-Of-Health() for the latest battery data.
- Step 4. Optional: Send GAUGE\_START().
- Step 5. Optional: Send GAUGE\_STOP(). At this point, Lifetime Data can be stored and any Threshold detection checks are run. This is only needed if these features are desired.
- Step 6. Set GE low to power down the bq35100 device.

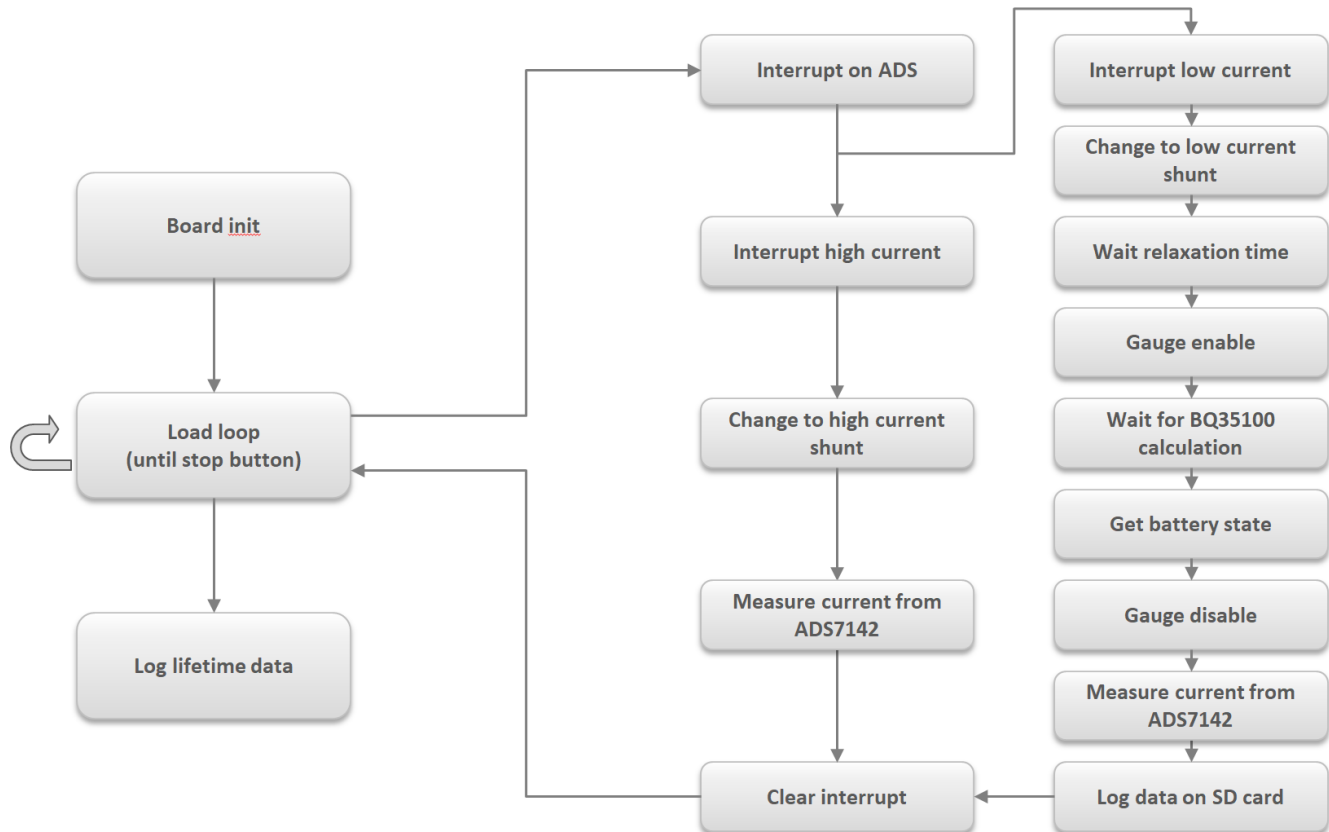
### 3.1.2.2 End-of-Service (EOS) Mode

This mode is suitable for gauging Lithium Thionyl Chloride (Li-SOCl<sub>2</sub>) cells. The End-of-Service (EOS) gauging algorithm uses voltage, current, and temperature data to determine the resistance (R) and rate of change of resistance of the battery. The resistance data is then used to find Depth of Discharge (DOD) = DOD(R). As stated previously, SOH is determined and in turn used to determine the EOS condition.

图 4 describes the operation of the battery monitoring software in EOS mode.



图 4. Flow Chart of EOS Mode Software

To configure the bq35100 device to use EOS mode, the following data flash configuration variables must be configured correctly. For more details, including information on Operation Config A [GMSEL], R Data Seconds, see the bq35100 Technical Reference Manual (SLUUBH1).

The following steps show how to use the EOS mode:

- Step 1. Set GE high to power up the bq35100 device and wait for ALERT to go low due to INITCOMP=1.
- Step 2. Clear ALERT (read BatteryStatus()).
- Step 3. Send GAUGE\_START() 1 s prior to the high load pulse starting.
- Step 4. Send GAUGE\_STOP() directly after the high load pulse has stopped. During the time between Step4 and Step 5 there should be no other pulse load. A low current DC load is acceptable.
- Step 5. Wait for ALERT to go low due to G\_DONE = 1.
- Step 6. Read BatteryStatus() for an [EOS] decision and other data, such as State-Of-Health().
- Step 7. Set GE low to power down the bq35100 device.

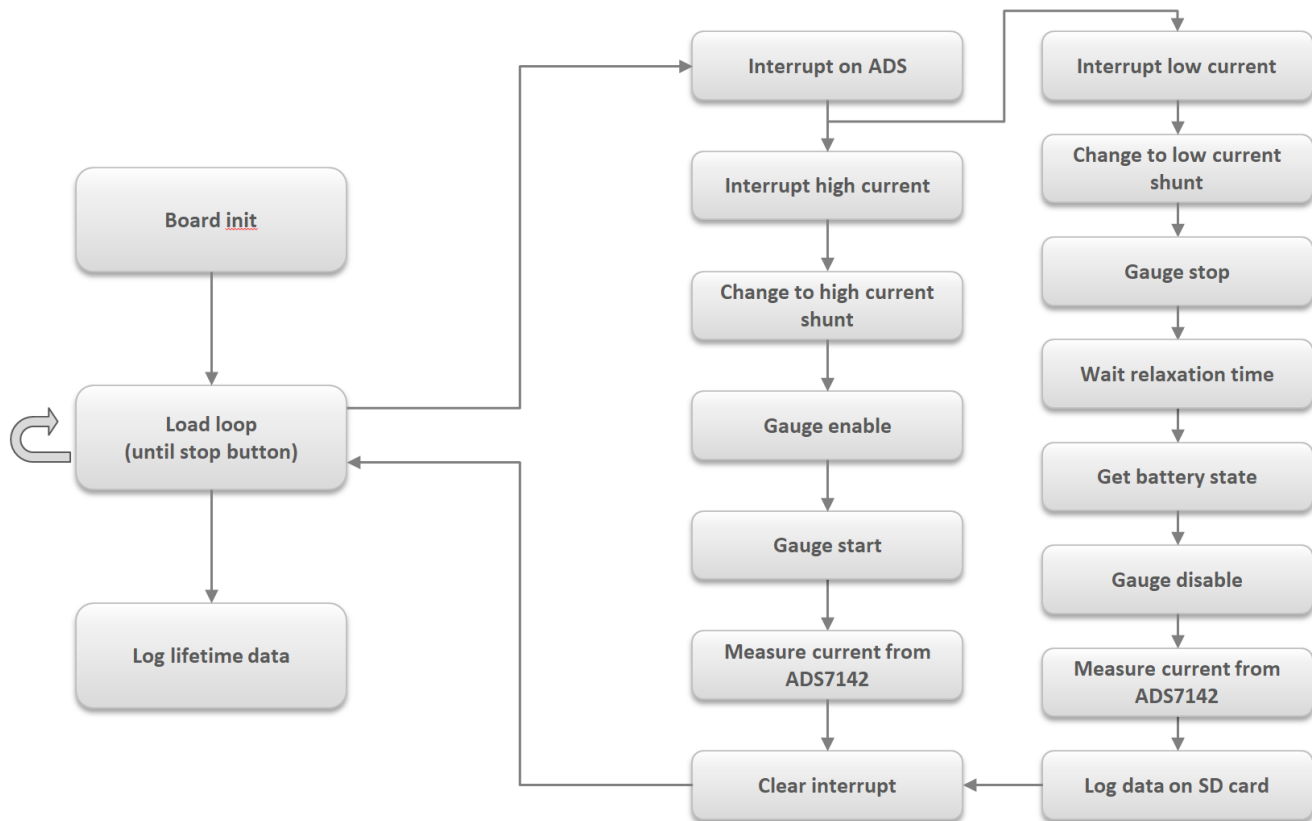
## 3.2 Testing and Results

### 3.2.1 Test Setup

The following section describes the setups for measurements including the equipment used.

#### 3.2.1.1 Steps to Calibrate bq35100

##### 3.2.1.1.1 Requirements

1. Use the following equipment:
  - EV2300 or EV2400 communications interface adapter
  - USB cable
  - PC
  - Access to internet to install the bqStudio software setup program
2. Find the latest version of the software on the [bqStudio tool page](#). Search by part number for the bq35100 to access the tool folder for the device. To install bq35100 bqStudio software:
  - a. Ensure that the EV2300 or EV2400 is not connected to the personal computer (PC) through the USB cable before starting this procedure.
  - b. Open the archive containing the installation package, and copy its contents into a temporary directory.
  - c. Open the bqStudio installer file downloaded from the TI Web site.
  - d. Follow the instructions on the screen until completion of the software installation.
  - e. Before starting the evaluation software, connect the EV2300 or EV2400 to the computer using the USB cable.
  - f. If the EV2300 is connected, wait until the system prompt New Hardware Found appears. Choose Select Location Manually, and use the Browse button to point to the subdirectory TIUSBWin2K-XP-1.
  - g. Click Continue when the warning that drivers are not certified with Microsoft® appears.
  - h. If the EV2300 is connected, after the previous installation finishes, another system prompt New Hardware Found appears. Repeat steps 1 through 5, but specify the directory as TIUSBWin2K-XP-2.
  - i. Click Continue when the warning that drivers are not certified with Microsoft appears. Driver installation is now finished.
  - j. For the EV2400, the driver should be installed along with the software installation.

### 3.2.1.1.2 Hardware Connections

1. Ensure that the Jumper configuration is the same as specified in 节 3.1.1.1.
2. Connect the battery to J3 terminal block (BAT+, BAT-).
3. Connect the load to J3 terminal block (BAT+, SYS\_GND).
4. Connect I2C SCL, SDA, and GND from J18 to the I2C port on EV2300 or EV2400 using wire leads.
5. Connect the PC USB cable to EV2300 or EV2400 and the PC USB port.

The bq35100 is now set up for calibration.

### 3.2.1.1.3 Calibration

The bq35100 must be calibrated to ensure accurate value reporting. Calibrate the device by going to the Calibration window in bqStudio (see 图 5).



图 5. Calibration Screen

#### 3.2.1.1.3.1 Voltage Calibration

1. Measure the voltage from BAT+ to BAT-.
2. Enter this value in the Applied Voltage field.
3. Select the Calibrate Voltage box.
4. Press the Calibrate Gas Gauge button to calibrate the voltage measurement system.
5. Deselect the Calibrate Voltage boxes after voltage calibration has completed.

### 3.2.1.1.3.2 Current Calibration

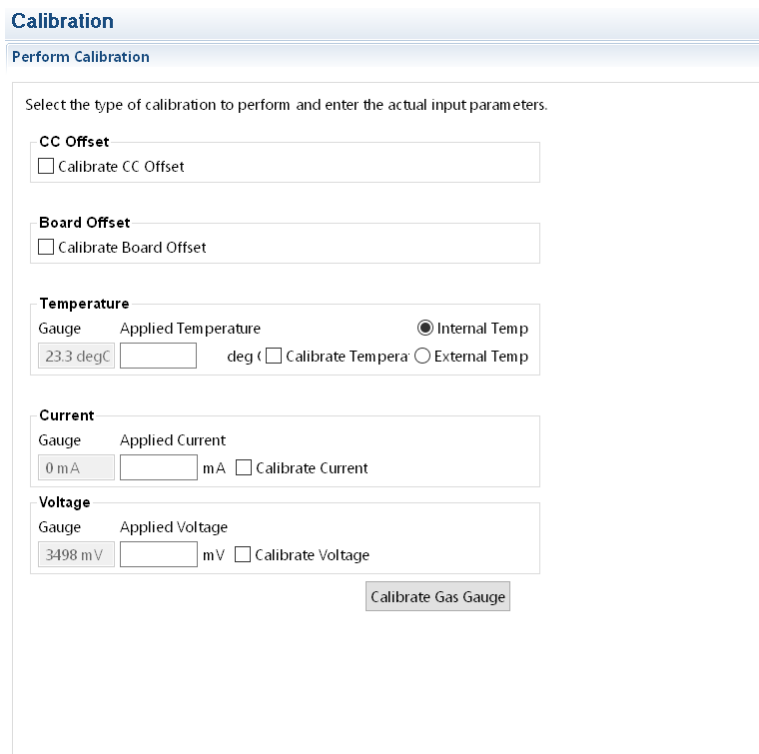
The gauge offers CC Offset and Board Offset calibration options to zero any residual current that may be reported by the gauge. These calibrations are only required if the gauge does not report a current of 0 mA when no current should be present.

1. Select the CC Offset calibration option.
2. Press the Calibrate Gas Gauge button to calibrate.
3. Verify whether the current reports 0 mA. Proceed with the Board Offset Current calibration if current is reported.
4. Select CC Offset calibration option.
5. Press the Calibrate Gas Gauge button to calibrate.
6. Verify whether the current reports 0 mA.
7. Connect a 1-A load from BAT+ to PACK-.
8. Enter '-1000' in the Applied Current field and select the Calibrate Current box.
9. Press the Calibrate Gas Gauge button to calibrate.
10. Deselect the Calibrate Current box after current calibration has completed.

### 3.2.1.1.3.3 Chemistry Screen

The chemistry file contains parameters that the simulations use to model the cell and its operating profile. It is critical to program a Chemistry ID that matches the cell into the device. Some of these parameters can be viewed in the Data Flash section of bqStudio.

Press the Chemistry button to select the Chemistry window (see [图 6](#)).

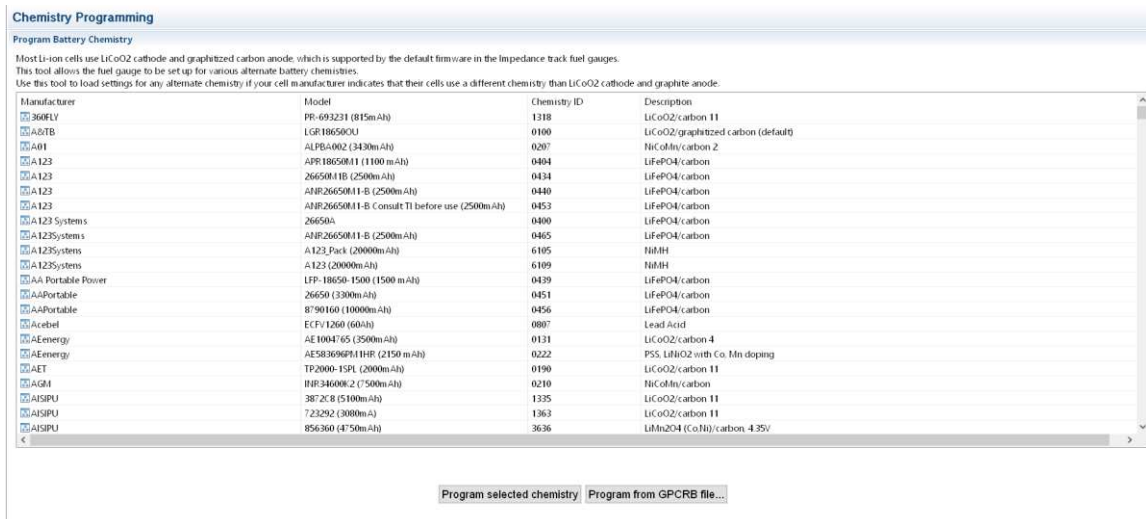

**图 6. Chemistry Screen**

1. Sort the table by clicking the desired column (for example, click on the Chemistry ID column header).
2. Select the Chemistry ID that matches the cell from the table (see [图 6](#)).
3. Press the Update Chemistry in the Data Flash button to update the chemistry in the device.

## 3.2.2 Setup Guide

This section describes the steps to program and test the PCB.

### 3.2.2.1 Reprogram TIDA-01546

This subsection describes how to reprogram the entire board. The board is already programmed by default, but this section might be useful in optimizing the board for a particular system. Therefore, this subsection is optional.

First, the software project must be open in Code Composer Studio. This procedure has been tested with CCS 7.3 ([Download CCS](#)). TivaWare™ 2.1.3.156 ([TivaWare™ for C Series](#)) must be installed as well in order to compile the software.

Once the software is loaded on CCS and compiled, it can be loaded into the board. Any XDS110 debugger can be used to debug the board. The following examples use the [CC-Debugger Devpack](#) or the MSP432 XDS110 debugger part. A 3.3-V power supply must be provided to the board by using the J10 header as shown in [图 7](#) (red: 3.3 V, black: ground).

图 7.



图 8. Debugger Connection Example

Load the program on the board by clicking Run and then Debug. Once the program is loaded, the Resume button must be pressed to start the program.

Configure the bq35100 by connecting an EV2300, or EV2400, to bq35100 by I<sup>2</sup>C. The I<sup>2</sup>C pins of the EV2300 must be connected to the J18 header. Refer to [节 3.1.1](#) for more information. The board also requires a 3.3-V supply on J10, and the jumper must be configured as described in [节 3.1.1.1](#). Lastly, connect the battery to the BAT+/BAT– pin of the J3 connector. [图 9](#) shows an example of the connections.

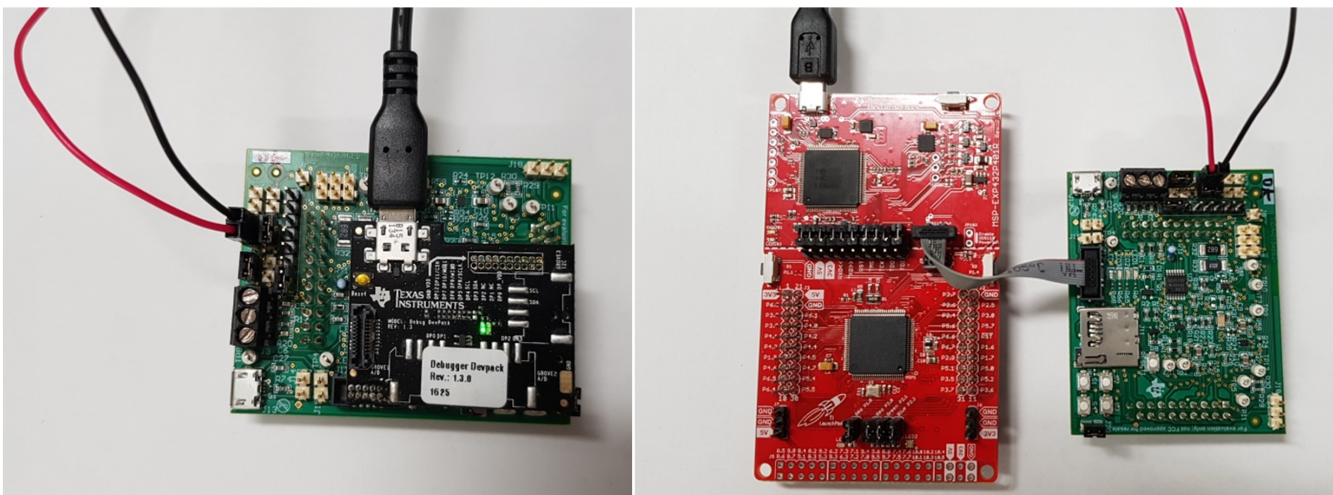

图 9.



图 10. EV2300 and Battery Connection

Once everything is connected, [Battery Management Studio](#) must be open to configure the bq35100. The software should automatically detect the bq35100. If the software is not automatically detected, the software can still be selected in the Target Selection Wizard under Gauge.

Under the Chemistry tab, choose the appropriate chemistry for the battery. To update the chemistry profile in the bq35100, select the appropriate chemistry in the list and click on the Update chemistry button.

Under the Data Memory tab, it is possible to change every parameter of the gauge. The most important is Operation Config A under Configuration. The value must be set to 11 for SOH mode and 12 for EOS mode. Then, the battery characteristics can also be configured under Gas Gauging. For more details about the different registers, please refer to the [bq35100 Technical Reference Manual](#).

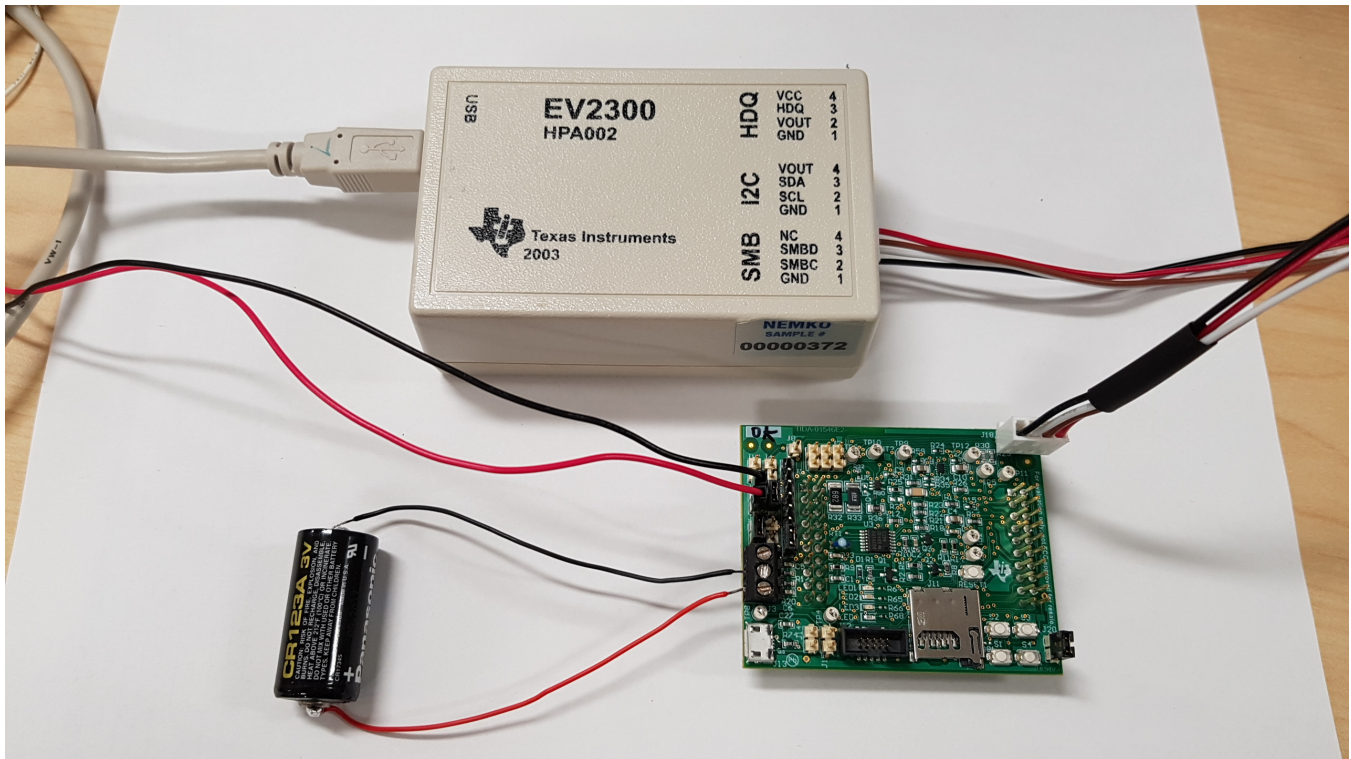
### 3.2.2.2 Testing the Board

By default, the board is configured for a 3-V Lithium Manganese Dioxide battery, and the software is optimized for the SOH mode. The current detection threshold is set for a 3- $\mu$ A standby current and a 30-mA active current. When the current is above 6  $\mu$ A, the transistor will switch on to connect the 0.1- $\Omega$  shunt resistor. When the current is below 6 mA, the transistor will switch off because the load is returning to standby mode. The MCU will then wait 10 minutes to allow time for the battery to relax (relaxation time configurable in the software) and then log the data on the SD Card.

To test the board, the battery must be connected to the BAT+/BAT- pins of the J3 connector. The supply must also be connected to J10 and the jumper configuration. Then, the micro SD card can be inserted into the SD slot. The load must be connected between the BAT+ and Sys\_GND pins of the J3 connector.

图 11.



图 12. Battery and Load Connection

The load must be a square wave alternating between the thresholds of the ADS7142. By default, the standby current of the board must be between 300 nA and 5 uA, and the active current must be between 10 mA and 300 mA. These settings can be changed in the software.

The frequency of the load change depends of the relaxation time of the battery. This demo is optimized for a system that is active only a few times per day. By default, the relaxation time is set to 10 minutes so that the next load spike can be applied a minimum of 10 minutes after the end of the previous load spike. The duration of the load spike is irrelevant because the board will automatically detect when the load is applied and when the load goes back to standby mode.

A dynamic load or an MCU that alternates between Standby and Active mode can be used to draw very low current. Even without the necessary equipment, the load switch is also populated on the board and can alternate between two resistors to simulate the load behavior.

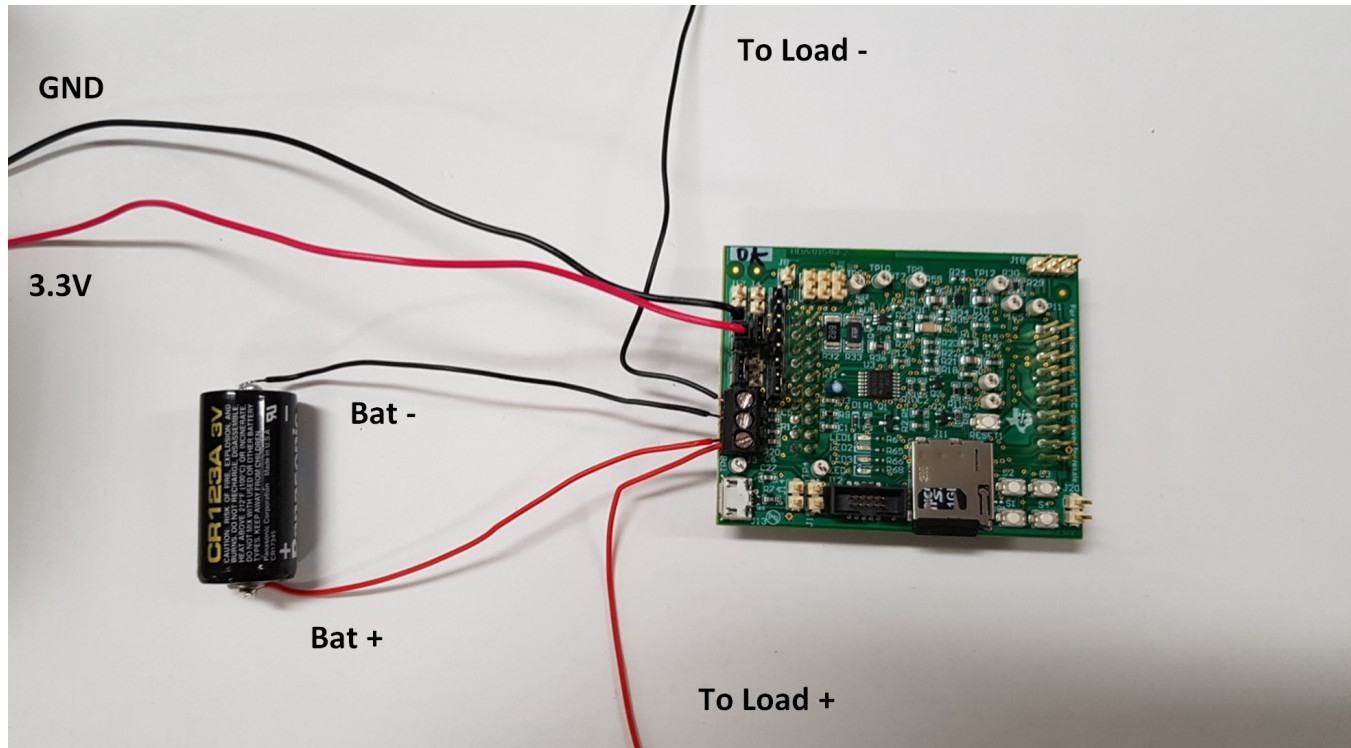
The load switch frequency and duty cycle can also be configured in the software. By default, the load is active for 2 seconds every 10 minutes. To use the load switch, R94 and R95 must be populated. See [图 13](#). The J20 jumper must be placed. R94 will simulate the standby current and R95 the active current. To work properly with the default threshold settings, TI recommends using 10 M $\Omega$  for R94 and 100  $\Omega$  for R95.



图 13.



图 14. Load Switch Resistance Placement

Once the setup is ready, reset the program by pressing the Reset button. To use the load switch, press the S4 button. A blue LED will light up and stay on. If the battery is new, press button S3 to send the New Battery command to the bq35100 and to reset the log file on the SD Card. A green LED will light up when the button is pressed.

To start the monitoring, press button S1. The red LED shows when a high current is detected. The green LED shows when the load spike is over and will stay on during relaxation time. The orange LED represents the active state of the load switch if used. To stop the monitoring, press the Reset button and take out the SD Card to read the data on a computer.

### 3.2.2.3 Modifying the Software

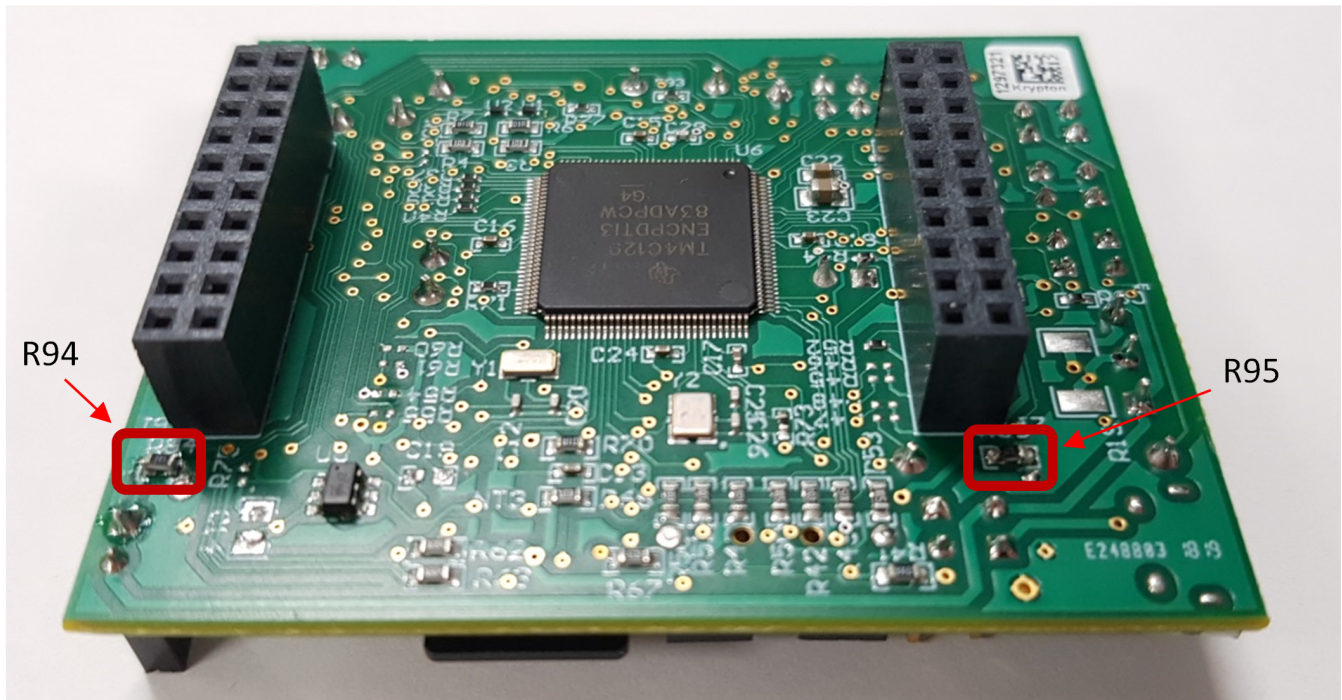
The TM4C software can be easily modified to fit a particular system need. First, there is a simple configuration file (config.h) that allows for changing the monitoring mode (SOH or EOS), the monitoring thresholds, and the relaxation time. To change the thresholds, please refer to the [ADS7142 Nanopower, Dual-Channel, Programmable Sensor Monitor Data Sheet](#).

In the software, there are two main functions that are used for monitoring. First, the main function (in main.c) will initialize the board and then go to an infinite loop. This loop will handle the load switch if used, or it will wait if not.

The second main function is AlertStatusIntHandler in cycle.c. This function will handle every interrupt signal received by the TM4C. According to the type of interruption, this function will take care of switching on and off the bq35100 and logging the data on the SD card.

### 3.2.2.4 Switching to EOS Mode

To switch to EOS mode, first set SOH\_MODE to 0 and EOS\_MODE to 1 in config.h. Then, recompile and load the program on the board by following the instructions in 节 3.2.2.1. Once that has been completed, the bq35100 must be configured as well.

By following the instructions in 节 3.2.2.1, connect the EV2300 and open Battery Management Studio. Under the data memory tab, Operation Config A (under Configuration) must be changed to 12 to set configured the bq35100 as EOS mode.

## 3.2.3 Test Results

### 3.2.3.1 Battery Monitoring Results

Battery life for this reference design varies based on the application, load currents, and use conditions.

For the purpose of testing battery monitory circuitry, system loads with 0.3 mA, 0.5 mA, 1 mA, and 4 mA are connected to the design board. Voltage (V), current consumption (mA), and average current consumption ( $\mu$ Ah) data of non-rechargeable battery are logged in a .csv file onto the SD card. The test results show the performance of battery gauge to accurately monitor the battery state of non-rechargeable batteries for loads > 0.3 mA, and is plotted in the following figures.

In 图 15, 图 16, and 图 17, the number of cycles represents the cycle time ( $\approx 2.5$  s) between each data capture. In 图 15, the battery voltage measured is an unsigned integer value in mV with a range of 0 mV to 65535 mV. In 图 16, the average current measured is a signed integer value with units in 1 mA. In 图 17, the accumulated current provides an unsigned integer value with a range of 0 to 0.42E9  $\mu$ Ah.



图 15. Battery Voltage Measured by Gauge



图 16. Current Discharge (mA) Measured by Gauge

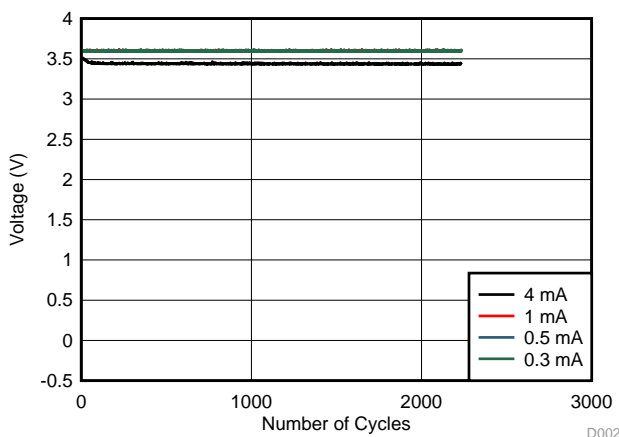

图 17. Accumulated Discharge Coulombs (µAh) Measured by Gauge

### 3.2.3.2 System Health Monitoring Results

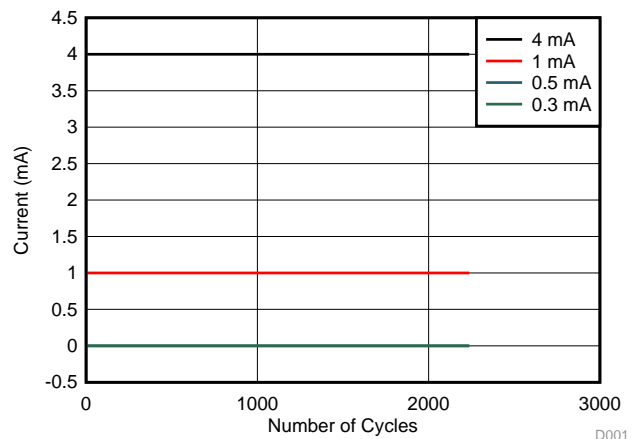
System health monitoring tracks overcurrent conditions in flow meters and triggers a signal when current consumption exceeds the programmed threshold level. The programmable threshold level varies with the application, based on features, use conditions, and load currents. To cover load currents with low current inputs (µA) and high current inputs (mA), testing is conducted by setting the threshold at 0.1 V for low currents and at 1 V for high currents (mA). LED3 is turned ON if the current input exceeds the programmed threshold voltage to indicate overcurrent condition.

注:

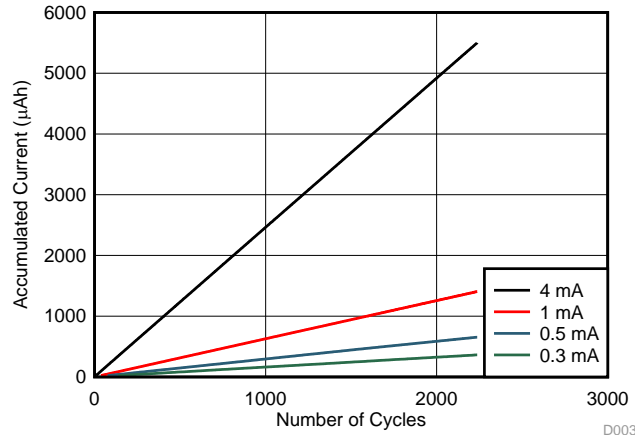
1. For low current (µA) testing, transistor Q4 is in off state.
2. Q4 is turned ON in the software to measure high currents (mA).

表 3 provides the threshold levels set in the software to test current inputs from 1 µA to 200 mA.

表 3. Results of System Health Monitoring

CURRENT INPUT	THRESHOLD SET IN SOFTWARE	LED3 STATUS
0.2 µA	0.1 V	OFF
0.4 µA	0.1 V	ON (overcurrent detected)
1.0 µA	0.1 V	ON (overcurrent detected)
1 mA	1 V	OFF
200 mA	1 V	ON (overcurrent detected)

### 3.2.3.3 Power Consumption

This section provides the power consumption numbers of battery monitoring and system monitoring circuitry.

#### 3.2.3.3.1 Battery Monitoring

The power consumption of battery monitoring system is measured with the following configuration:

- J1 (pins 1–4) shorted
- BAT+ and BAT– battery input (Tadiran Lithium 3.6-V AA battery) applied to terminal block J3
- 3.3-V input applied to J10
- In standby mode, with GE low, the average current consumption is < 1 µA.

In active mode, with the gauge started to monitor battery state, the average current consumption measured is 400  $\mu\text{A}$ .

### 3.2.3.3.2 System Health Monitoring

The power consumption of the system health monitoring system is measured with the following configuration:

- J4 shorted
- BAT+ and BAT– battery input applied to terminal block J3
- 3.3-V input applied to J10

表 4 shows the power consumption numbers for test conditions in normal mode and when overcurrent condition occurs.

**表 4. Current Consumption Results of System Health Monitoring**

TEST CONDITION	CURRENT CONSUMPTION
Normal load operation with no activity on I <sup>2</sup> C lines	1 $\mu\text{A}$
Overcurrent condition detected with activity on I <sup>2</sup> C lines	80 $\mu\text{A}$



## 4 Design Files

### 4.1 Schematics

To download the schematics, see the design files at [TIDA-01546](#).

### 4.2 Bill of Materials

To download the bill of materials (BOM), see the design files at [TIDA-01546](#).

### 4.3 PCB Layout Recommendations

#### 4.3.1 Layout Prints

To download the layer plots, see the design files at [TIDA-01546](#).

### 4.4 Altium Project

To download the Altium project files, see the design files at [TIDA-01546](#).

### 4.5 Gerber Files

To download the Gerber files, see the design files at [TIDA-01546](#).

### 4.6 Assembly Drawings

To download the assembly drawings, see the design files at [TIDA-01546](#).

## 5 Software Files

To download the software files, see the design files at [TIDA-01546](#).

## 6 Related Documentation

1. Texas Instruments, [ADS7142 Nanopower, Dual-Channel, Programmable Sensor Monitor Data Sheet](#)
2. Texas Instruments, [bq35100 Lithium Primary Battery Fuel Gauge and End-Of-Service Monitor Data Sheet](#)
3. Texas Instruments, [LPV521 NanoPower, 1.8-V, RRIO, CMOS Input, Operational Amplifier Data Sheet](#)
4. Texas Instruments, [TPS22860 Ultra-Low Leakage Load Switch Data Sheet](#)
5. Texas Instruments, [MSP430FR604x\(1\), MSP430FR603x\(1\) Ultrasonic Sensing MSP430™ Microcontrollers for Water-Metering Applications Data Sheet](#)

### 6.1 商标

E2E, PowerWise, TivaWare are trademarks of Texas Instruments.  
Microsoft is a registered trademark of Microsoft Corporation.  
I<sup>2</sup>C is a trademark of NXP B.V. Corporation.  
All other trademarks are the property of their respective owners.

## 修订历史记录

注：之前版本的页码可能与当前版本有所不同。

<b>Changes from Original (January 2018) to A Revision</b>	<b>Page</b>
• 已更改 TPS22918 至 TPS22860 的产品文件夹链接位于 <a href="#">资源</a> .....	1
• 已更改 TLV521 至 LPV521 位于 <a href="#">特性</a> .....	1
• 已更改 TPS22918 to TPS22860 in <a href="#">2 节</a> .....	3
• 已更改 <a href="#">节 2.2.4</a> title from TPS22918 to TPS22860 .....	5
• 已添加 paragraph regarding TPS22860 to <a href="#">节 2.2.4</a> .....	5
• 已删除 paragraph regarding TPS22918 from <a href="#">节 2.2.4</a> .....	5
• 已添加 <a href="#">节 2.2.6</a> .....	5
• 已更改 information in first paragraph of <a href="#">节 3.1.1.1</a> .....	9
• 已添加 tables to <a href="#">节 3.1.1.1</a> .....	10
• 已更改 <a href="#">节 3.1.2.1</a> title from <i>Battery Monitoring</i> to <i>State-of-Health (SOH) Mode</i> .....	11
• 已添加 paragraph to the beginning of <a href="#">节 3.1.2.1</a> .....	11
• 已删除 information regarding the MCU from <a href="#">节 3.1.2.1</a> .....	11
• 已更改 <a href="#">图 3</a> title to <i>Flow Chart of SOH Mode Software</i> from <i>Flow Chart of Battery Monitoring Software</i> .....	11
• 已添加 instructions regarding use of the State-of-Health (SOH) mode to <a href="#">节 3.1.2.1</a> .....	11
• 已更改 <a href="#">节 3.1.2.2</a> title from <i>System Health Monitoring</i> to <i>End-of-Service (EOS) Mode</i> .....	12
• 已删除 information regarding system health monitoring and the MCU in <a href="#">节 3.1.2.2</a> .....	12
• 已添加 information regarding End-of-Service (EOS) mode to <a href="#">节 3.1.2.2</a> .....	12
• 已更改 <a href="#">图 4</a> title from <i>Flow Chart of System Health Monitoring</i> to <i>Flow Chart of EOS Mode Software</i> .....	12
• 已添加 instructions regarding use of the End-of-Service (EOS) Mode to <a href="#">节 3.1.2.2</a> .....	12
• 已更改 steps 1, 2, 3, and 4 in <a href="#">节 3.2.1.1.2</a> .....	14
• 已添加 <a href="#">节 3.2.2</a> .....	16

## 有关 TI 设计信息和资源的重要通知

德州仪器 (TI) 公司提供的技术、应用或其他设计建议、服务或信息，包括但不限于与评估模块有关的参考设计和材料（总称“TI 资源”），旨在帮助设计人员开发整合了 TI 产品的应用；如果您（个人，或如果是代表贵公司，则为贵公司）以任何方式下载、访问或使用了任何特定的 TI 资源，即表示贵方同意仅为该等目标，按照本通知的条款进行使用。

TI 所提供的 TI 资源，并未扩大或以其他方式修改 TI 对 TI 产品的公开适用的质保及质保免责声明；也未导致 TI 承担任何额外的义务或责任。TI 有权对其 TI 资源进行纠正、增强、改进和其他修改。

您理解并同意，在设计应用时应自行实施独立的分析、评价和判断，且应全权负责并确保应用的安全性，以及您的应用（包括应用中使用的 TI 产品）应符合所有适用的法律法规及其他相关要求。就您的应用声明，您具备制订和实施下列保障措施所需的一切必要专业知识，能够 (1) 预见故障的危险后果，(2) 监视故障及其后果，以及 (3) 降低可能导致危险的故障几率并采取适当措施。您同意，在使用或分发包含 TI 产品的任何应用前，您将彻底测试该等应用和该等应用所用 TI 产品的功能而设计。除特定 TI 资源的公开文档中明确列出的测试外，TI 未进行任何其他测试。

您只有在为开发包含该等 TI 资源所列 TI 产品的应用时，才被授权使用、复制和修改任何相关单项 TI 资源。但并未依据禁止反言原则或其他法律授予您任何 TI 知识产权的任何其他明示或默示的许可，也未授予您 TI 或第三方的任何技术或知识产权的许可，该等许可包括但不限于任何专利权、版权、屏蔽作品权或与使用 TI 产品或服务的任何整合、机器制作、流程相关的其他知识产权。涉及或参考了第三方产品或服务的信息不构成使用此类产品或服务的许可或与其相关的保证或认可。使用 TI 资源可能需要您向第三方获得对该等第三方专利或其他知识产权的许可。

TI 资源系“按原样”提供。TI 兹免除对 TI 资源及其使用作出所有其他明确或默示的保证或陈述，包括但不限于对准确性或完整性、产权保证、无屡发故障保证，以及适销性、适合特定用途和不侵犯任何第三方知识产权的任何默认保证。

TI 不负责任何申索，包括但不限于因组合产品所致或与之有关的申索，也不为您辩护或赔偿，即使该等产品组合已列于 TI 资源或其他地方。对因 TI 资源或其使用引起或与之有关的任何实际的、直接的、特殊的、附带的、间接的、惩罚性的、偶发的、从属或惩戒性损害赔偿，不管 TI 是否获悉可能会产生上述损害赔偿，TI 概不负责。

您同意向 TI 及其代表全额赔偿因您不遵守本通知条款和条件而引起的任何损害、费用、损失和/或责任。

本通知适用于 TI 资源。另有其他条款适用于某些类型的材料、TI 产品和服务的使用和采购。这些条款包括但不限于适用于 TI 的半导体产品 (<http://www.ti.com/sc/docs/stdterms.htm>)、[评估模块](http://www.ti.com/sc/docs/sampters.htm)和样品 (<http://www.ti.com/sc/docs/sampters.htm>) 的标准条款。

邮寄地址：上海市浦东新区世纪大道 1568 号中建大厦 32 楼，邮政编码：200122  
Copyright © 2018 德州仪器半导体技术（上海）有限公司