

TI Designs: TIDC-01004 双频带射频频谱分析仪参考设计



说明

TI 的 SA13x0 频谱分析仪是一款易于使用、经济实惠的工具，能够以低于 1 GHz 的频带和 2.4 GHz 频带快速投入射频 (RF) 开发。

越来越多的电子器件集成内置射频链路。射频收发器本身成本并不高，但用于设计和调试其系统的设备却价格不菲。SA13x0 频谱分析仪 (SA13x0) 旨在提供一种经济实惠的开发工具，为开发人员节省必须在昂贵的测量设备上花费的时间。

SA13x0 运行于 CC13x0 LaunchPad 上，™其可以通过 USB 连接到 PC 并使用功能强大且简单易用的图形用户界面进行操作，或者连接到液晶显示器 (LCD) BoosterPack™通过按钮输入进行独立运行。SA13x0 与所有 CC13x0 LaunchPad 兼容。

资源

| | |
|----------------------------|-------|
| TIDC-01004 | 设计文件夹 |
| CC1310 | 产品文件夹 |
| CC1350 | 产品文件夹 |



咨询我们的 E2E™ 专家

特性

- 低成本低功率便携式频谱指示器
- 适用于射频系统开发和调试且具有成本效益的工具
- 在低于 1GHz 和 2.4GHz 的 ISM 频段中运行
- PC 和可选的独立 LCD 频谱指示

应用

- 射频硬件开发和调试
- 低功耗蓝牙、ZigBee™、Thread、Wi-Fi®、wM-BUS 和 802.15.4 产品开发
- 部署射频设备前，在现场测试干扰情况

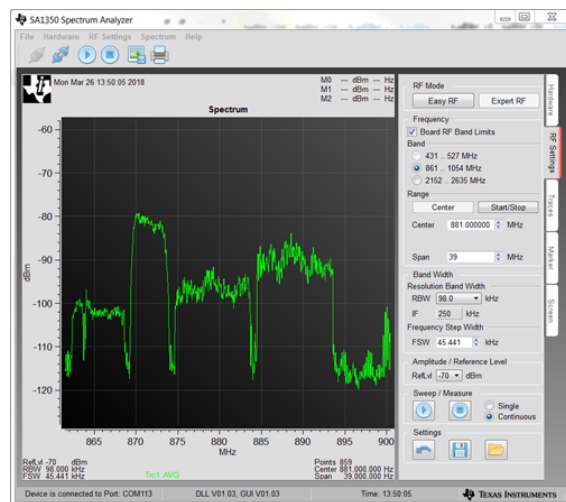
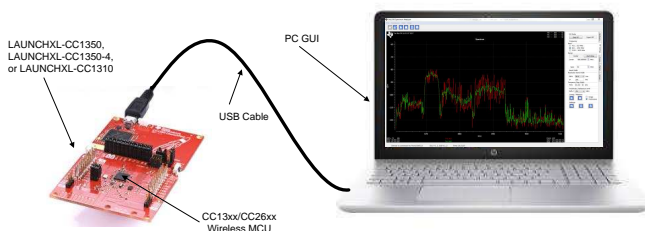

该 TI 参考设计末尾的重要声明表述了授权使用、知识产权问题和其他重要的免责声明和信息。

1 System Description

The SA13x0 system consists of a CC13x0 LaunchPad board programmed with SA13x0-specific firmware, a mechanism for user input, and a display for plotting RF-signal measurements. The SA13x0 can operate in standalone mode, where the CC13x0 LaunchPad is coupled with a SHARP-96 LCD BoosterPack board, and the RF-signal measurements are displayed on the LCD. Alternatively, the system functionality can be extended with a separate GUI application running on a Windows® PC, which provides additional configurability and enables a higher resolution measurement and display of the RF signals.

The overall system consists of the hardware and software components that follow:

- SA13x0 firmware program
- CC13x0 LaunchPad board (use any of the following)
 - [LAUNCHXL-CC1350](#)
 - [LAUNCHXL-CC1350-4](#)
 - [LAUNCHXL-CC1310](#)
- SA13x0 Windows GUI application
- Windows PC
- [430BOOST-SHARP-96](#) LCD BoosterPack (required for standalone operation, but optional when the GUI is used)

When the SA13x0 is operated in standalone mode, the hardware components used are the CC13x0 LaunchPad, LCD BoosterPack, and a 5-V micro-USB power source. 图 1 shows the SA13x0 when operating in standalone mode.



图 1. SA13x0 Standalone Mode

The CC13x0 LaunchPad is programmed with the SA13x0 firmware for either mode of operation. The SA13x0 firmware controls all the features of standalone operation, including user-interface functionality. RF measurement adjustments are made through the push buttons on the CC13x0 LaunchPad, with the RF measurement results displayed on the LCD BoosterPack.

When the SA13x0 is operated with the Windows PC GUI, the hardware components used are the CC13x0 LaunchPad, 5-V micro-USB power source, and Windows PC. 图 1 shows the SA13x0 operating in GUI mode.

RF measurement adjustments are made through the GUI configuration tabs on the Windows PC, and commands are sent to the CC13x0 LaunchPad over the USB. The RF measurement results are displayed in the graph area of the GUI. When the SA13x0 GUI is used the LCD BoosterPack is optional, because the RF measurements are displayed in the GUI.

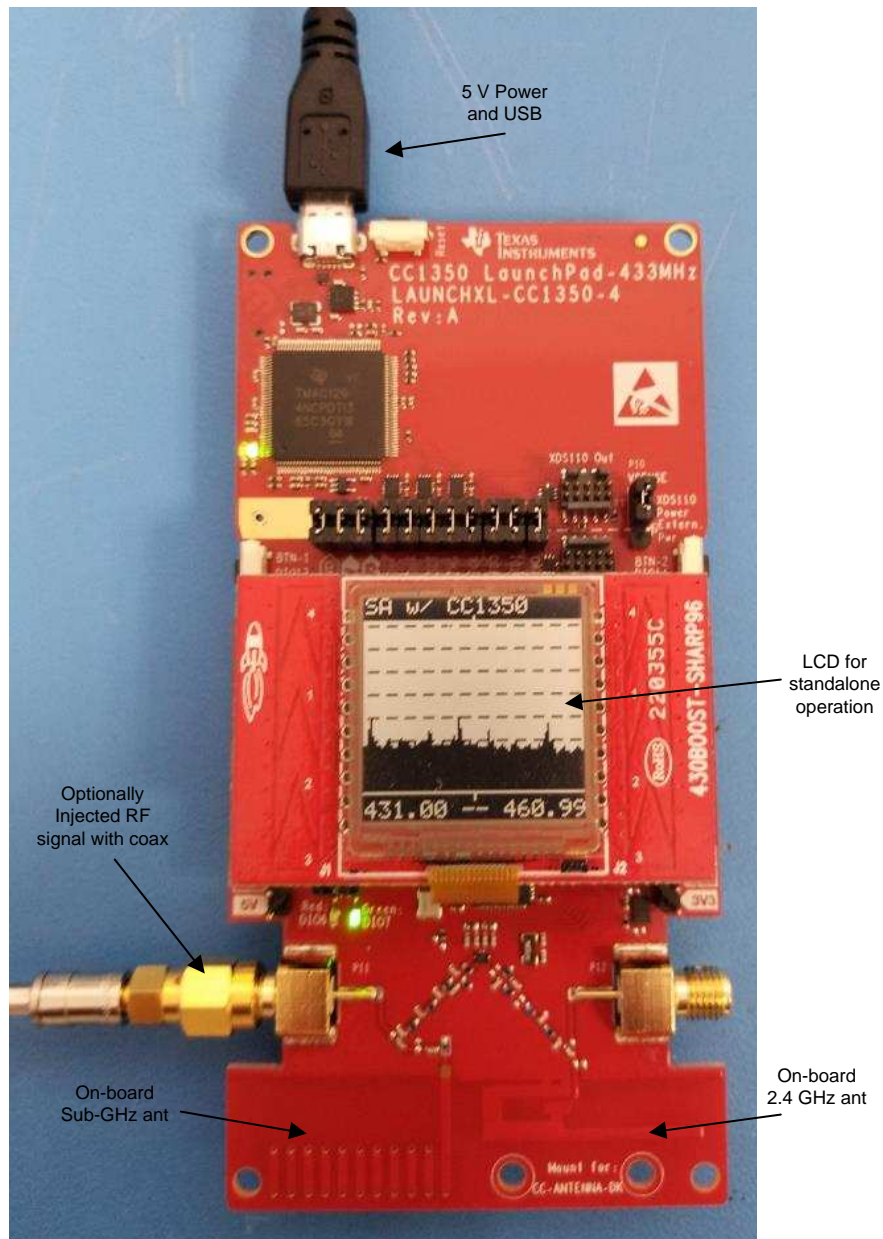
注: Detailed user documentation for the SA13x0 is included with the Windows SA13x0 installer.

1.1 Key System Specification

表 1. Key System Specifications

| PARAMETER | SPECIFICATIONS |
|--------------------------|---|
| Frequency ranges | 431 MHz to 527 MHz 861 MHz to 1054 MHz 2152 MHz to 2635 MHz |
| Minimum frequency step | 488.3 Hz (typical) |
| Maximum input level | 10 dBm (absolute) – range extendable with attenuators |
| Minimum detectable level | –109 dBm (typical) |
| Level resolution | 1.0 dB |
| Update rate | approximately 1000 samples/second |

表 2. System Requirements

| PARAMETER | SPECIFICATION |
|-------------------|---|
| Screen resolution | Minimum: 800 x 600 Recommended: 1024 x 768 |
| Operating system | Windows 7, 32/64 bit |
| Hard-drive space | 200MB free-drive space |
| Connection | USB full-speed port |

2 System Overview



图 2. TIDC-01004 System Overview

2.1 SA13x0 Firmware

The SA13x0 firmware is based on TI-RTOS and is executed by the embedded Arm® Cortex® CPU of the CC13x0 device.

One of the main functions of the firmware is to enable user input in either GUI mode or standalone mode. In GUI mode, the firmware receives user input through a serial command interface over the USB connection with the host. In standalone mode the firmware receives user input directly through the buttons of the CC13x0 LaunchPad.

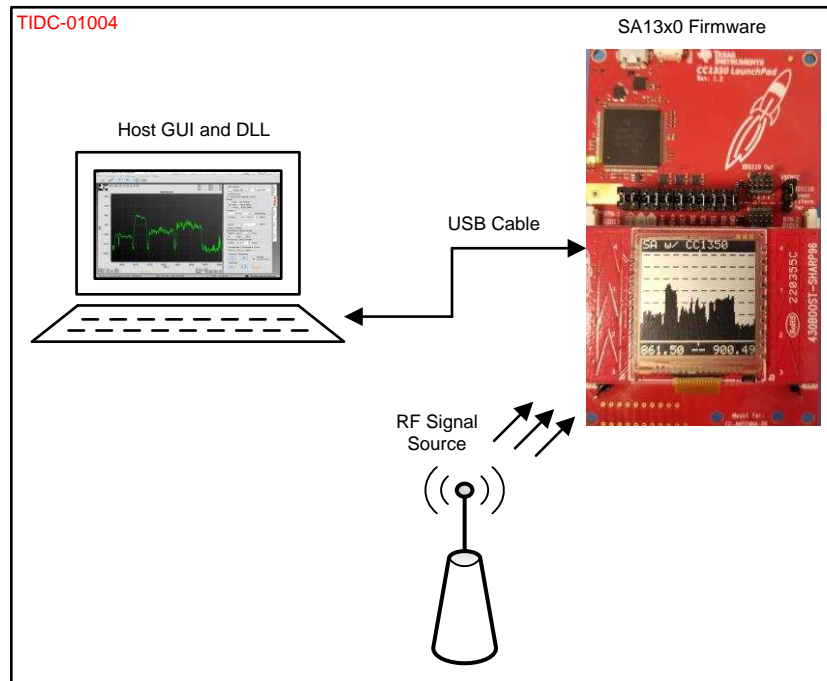
Another key function of the firmware is to configure the CC13x0 radio hardware as commanded by the GUI or LaunchPad buttons, to measure an indication of the RF signal strength at specific frequencies. Input commands are first translated into radio commands for the radio hardware, then sent to the radio hardware for new RF measurement results.

The final critical function is support of the display mechanism for the RF measurement results. The firmware displays the RF measurements on the LCD BoosterPack for standalone mode. In GUI mode, the firmware returns the RF measurements to the PC over the USB connection for display on the PC.

2.2 Host GUI and DLL

The host GUI and DLL run on a Windows PC. The flexible GUI is based on an open-source Qt GUI and lets developers set the desired frequency band, span, step size, amplitude, and receiver bandwidth, to measure an indication of the RF power.

Up to four traces can be visualized on the GUI, which can be configured to show maximum, average, or actual readings. Up to three markers are available for easy measurement of readings and deltas between readings. These markers can be manually controlled using a jog wheel.

The GUI view can be configured to show grids, customizable labels, date and time, inverted colors, and other options. The DLL implements the low-level driver that communicates with the CC13x0 LaunchPad over a USB cable.

2.3 **Highlighted Products**

2.3.1 **SimpleLink™ Ultra-Low-Power CC1350 and CC1310**

The SA13x0 is compatible with the CC1310 and CC1350 devices from TI, collectively referred to as CC13x0 devices. The CC13x0 devices are highly-integrated, true single-chip solutions, incorporating a complete RF system and an on-chip DC-DC converter. Very-low active RF and MCU current consumption, in addition to flexible low-power modes, provide excellent battery lifetime and allow long-range operation on small coin-cell batteries and in energy-harvesting applications. The CC1310 RF subsystem can operate in the sub-1 GHz RF frequency band, while the CC1350 can operate in both the sub-1 GHz and 2.4GHz RF frequency bands. [图 3](#) shows the block diagram of the SimpleLink™ CC13x0 wireless MCU.



图 3. SimpleLink™ Ultra-Low-Power CC1350 and CC1310

The CC13x0 device combines a flexible, low-power RF transceiver with a powerful 48-MHz ARM® Cortex®-M3 MCU in a platform supporting multiple physical layers and RF standards. A dedicated radio controller (Cortex-M0) handles low-level RF protocol commands that are stored in the ROM or RAM, thus ensuring ultra-low power and the flexibility to handle both sub-1 GHz and 2.4-GHz protocols. This configuration enables the combination of a sub-1 GHz communication solution that offers the best possible RF range, with a Bluetooth LE smartphone connection that enables great user experience through a phone application.

2.3.2 SimpleLink™ CC13xx SDK

The SimpleLink Sub-1 GHz CC13x0 software development kit (SDK) provides a comprehensive, sub-1 GHz software package for the sub-1 GHz CC1310 and dual-band CC1350 wireless MCUs. The SDK includes the following:

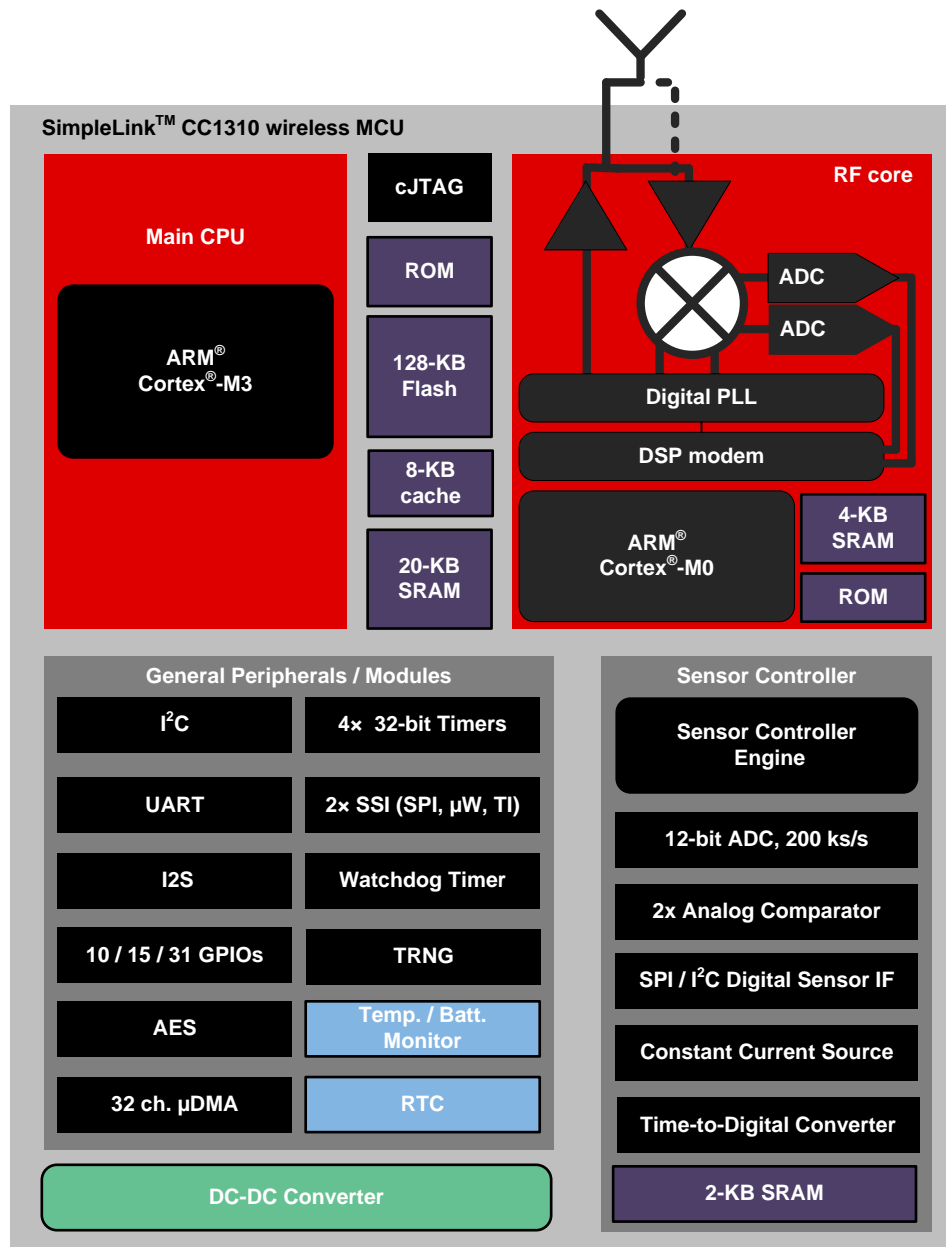
- TI 15.4-Stack – IEEE 802.15.4e/g-based, star-topology networking solution for sub-1 GHz ISM bands (868 MHz, 915 MHz, and 433 MHz)
- Support for proprietary solutions – proprietary RF examples for the sub-1 GHz based on the RF driver and EasyLink Abstraction Layer
- Bluetooth LE – Stack with support for all Bluetooth 4.2 core-specification features, as well as a BLE micro-stack to support developers using the dual-band CC1350 wireless MCU

图 4 shows a block diagram of the SimpleLink CC13xx SDK.



图 4. SimpleLink™ CC13xx SDK

The SimpleLink CC13x0 SDK is part of the SimpleLink MCU platform from TI, which offers a single development environment that delivers flexible hardware, software, and tool options for customers developing wired and wireless applications. For more information about the SimpleLink MCU Platform, visit www.ti.com/simplelink.

This software release is available royalty-free to customers using the SimpleLink Sub-1 GHz CC1310 and dual-band CC1350 wireless MCUs from TI.

3 SA13x0 Setup and Operation

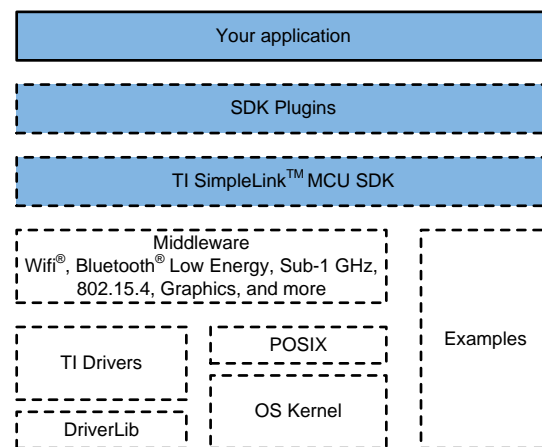
3.1 Install Software

The SA13x0 installer includes all the necessary program files and documentation for operation, while a standard Windows installer provides quick and easy installation of the SA13x0.

The device drivers required to support firmware updates of the CC13x0 LaunchPad used with the SA13x0 are installed during the SA13x0 installation. The drivers enable the GUI to automatically program the LaunchPad connected to the SA13x0 during GUI mode operation.

3.1.1 Execute Installer

1. Run the SA13x0 Windows Installer by double clicking the executable icon.
2. Click the Next button on the Setup – SA13x0 Spectrum Analyzer screen.
3. Read the license agreement then select *I accept the agreement* and click the Next button on the License Agreement screen.
4. Keep the default installation directory, and click the Next button on the Installation Directory screen.
5. Keep the Install firmware update drivers option selected, and click the Next button on the Custom SA1350 Installation Steps screen.
6. Click the Next button on the Ready to Install screen.
7. Wait for the installation process to finish.
8. Choose whether to keep the View Readme File option selected, keep the Run SA13x0 Spectrum Analyzer option selected, and then click the Next button on the Completing the SA13x0 Spectrum Analyzer Setup Wizard screen.

3.2 Connect Hardware

Connect the CC13x0 LaunchPad board to an unused USB port on the computer. The CC13x0 LaunchPad is automatically enumerated as a virtual-COM port device, XDS110 Class Application/User UART, in the Windows Device Manager. When the CC13x0 LaunchPad is connected to the PC, the board has a steady green LED and is ready to be used.

3.2.1 Connect RF

The CC13x0 LaunchPad is equipped with standard PCB trace antennas for all supported RF bands. Optional RF-SMA coaxial connections are available and can be connected to the RF path.

See the product page for the CC13x0 LaunchPad being used for details, and see the [CC-ANTENNA-DK2 product page](#) for measurement reports.

CAUTION

The absolute-maximum input level is 10 dBm. Exceeding this level can damage the SA13x0 hardware.

3.3 Connect Software With Hardware

The SA13x0 GUI starts in the Hardware tab, to allow selection of the desired hardware. Assuming only one CC13x0 LaunchPad is connected to the PC, the connection can easily be made by pressing the Connect symbol or the Connect button in the Hardware tab, as shown in 图 5.



图 5. Hardware Tab

3.3.1 Firmware Update

If the connected CC13x0 LaunchPad is not programmed with the necessary SA13x0 firmware, the GUI displays a message indicating that the device is nonresponsive and initiates a firmware update process. Simply click the Ok and No buttons within the two prompts, which appear following the nonresponsive message. After the firmware update process is complete, the GUI can connect to the CC13x0 LaunchPad.

3.3.2 Ready for Operation

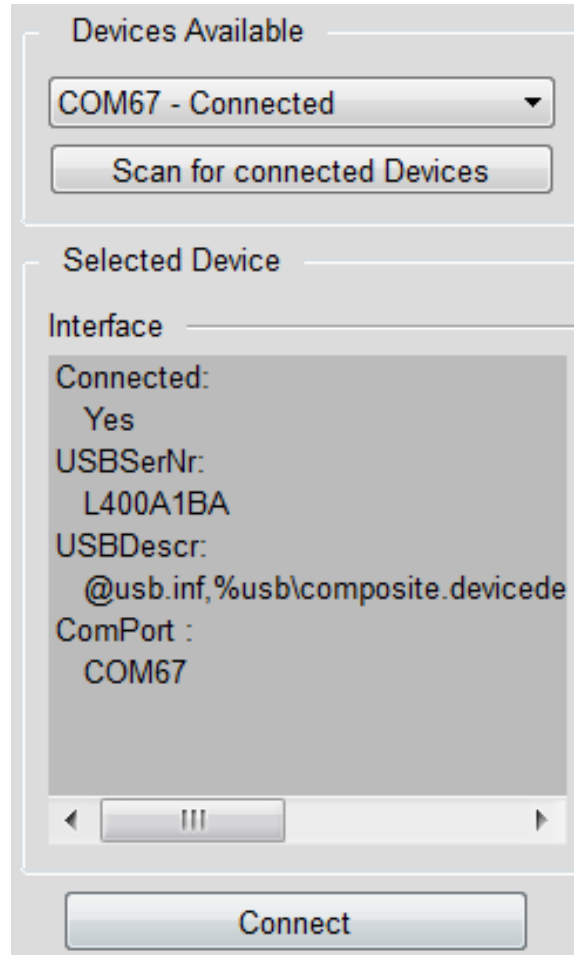
After the SA13x0 establishes communication with the LaunchPad, the connect icon is disabled, and the status bar shows a message that indicates the COM port number and device information for the connected LaunchPad (see 图 3). The SA13x0 is now ready for operation.

3.4 First Operation

3.4.1 First Measurement

Select the desired frequency band (one of the three supported bands), then specify the center frequency and span to measure. Users can either use the Center or Start/Stop frequencies for the range input – both settings are equivalent.

Select the Reference Level (RefLvL) according to the expected input level. The reference level shifts the spectrum-display axes for the RF readings. If the signal strength is unknown, it is a good idea to start with a low reference level and increase it if high readings, clipped readings, or artifacts are observed.

When all the settings are made, the measurement is triggered with the start button shown in [图 6](#). Use this button when it is time for changes to the RF settings to become active.



图 6. Start Button

To change the RF settings during the measurement, first enter the new settings, and then apply them by pressing the Start button again.

3.4.2 First Results

The measured spectrum is displayed in the left-hand graph window. The graph window displays power-indication information over frequency. By default, the actual trace is shown as well as a trace of the sliding, 6-point weighted average. Traces can be adjusted, added, and removed from the Trace tab on the right-hand side.

Markers are available, to allow for easier reading of measurement results. Markers are enabled in the Marker tab on the right side, by selecting a trace source for the desired marker. The markers can be moved across frequency with the jog dial.

图 7 shows the graph window with the default traces, marker zero and marker one configured as a delta on trace zero, and marker two configured as a measurement on trace one.



图 7. Frequency Graph

More information on how to use the Spectrum Analyzer is in the Spectrum Analyzer user's guide. Users can easily launch the guide from within the GUI in the Help menu.

4 Functional Testing Requirements, Setup, and Results

The SA13x0 functional tests are performed by capturing RF measurements of a reference tone or modulated signal with the SA13x0 and comparing the results with measurements of the same tone or signal using a calibrated, commercial, bench-top spectrum analyzer.

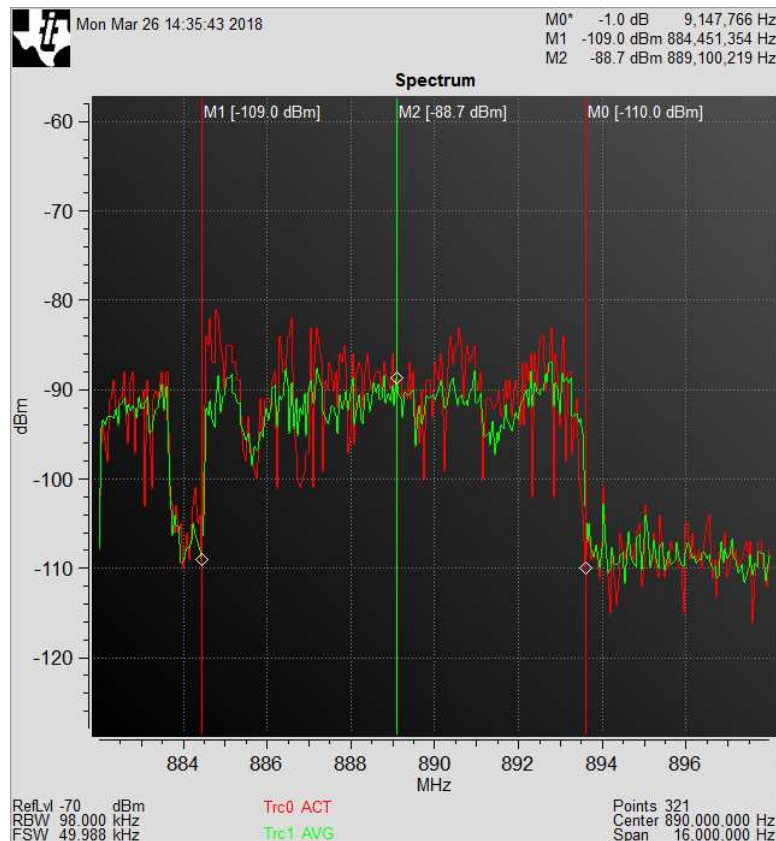
4.1 Required Hardware

The following hardware is used for the functional tests.

- Rohde & Schwarz SMU200A Signal Generator
- Agilent E4440A Spectrum Analyzer
- Two LAUNCHXL-CC1350-4 LaunchPad boards
- Midwest Microwave PWD-5520-02-sma-79 2-way divider (sub-1 GHz tests) and Mini-Circuits ZFRSC-42-S+ 2-way splitter (2.4-GHz tests)
- Windows PC
- Two Micro USB cables
- Coax cables

The LAUNCHXL-CC1350-4 LaunchPad board is modified from its default configuration, such that the CC1350 receive-input path is connected to the SMA connectors instead of the PCB trace antennas.

图 8 shows an excerpt of the LAUNCHXL-CC1350-4 board schematic highlighting the required modifications.



图 8. LAUNCHXL-CC1350-4 Hardware Modifications

To enable sub-1 GHz band testing at the SMA connector P11, the capacitor C15 is removed and C69 is populated with a 330-pF capacitor.

Similarly, to enable 2.4-GHz band testing at the SMA connector P12, the capacitor C24 is removed and C67 is populated with a 0- Ω resistor.

Also, by default the sub-1 GHz, RF front end of the LAUNCHXL-CC1350-4 LaunchPad board is tuned for the 433-MHz band. The component values of the RF front end must be changed for P11 to yield accurate measurements for the 868- and 915-MHz band signals. The LAUNCHXL-CC1350 LaunchPad board, sub-1 GHz, RF front-end, default configuration is tuned for the 868- and 915-MHz band. The schematics of that board can be referenced for the correct inductor and capacitor values to use for the 868- and 915-MHz band signals.

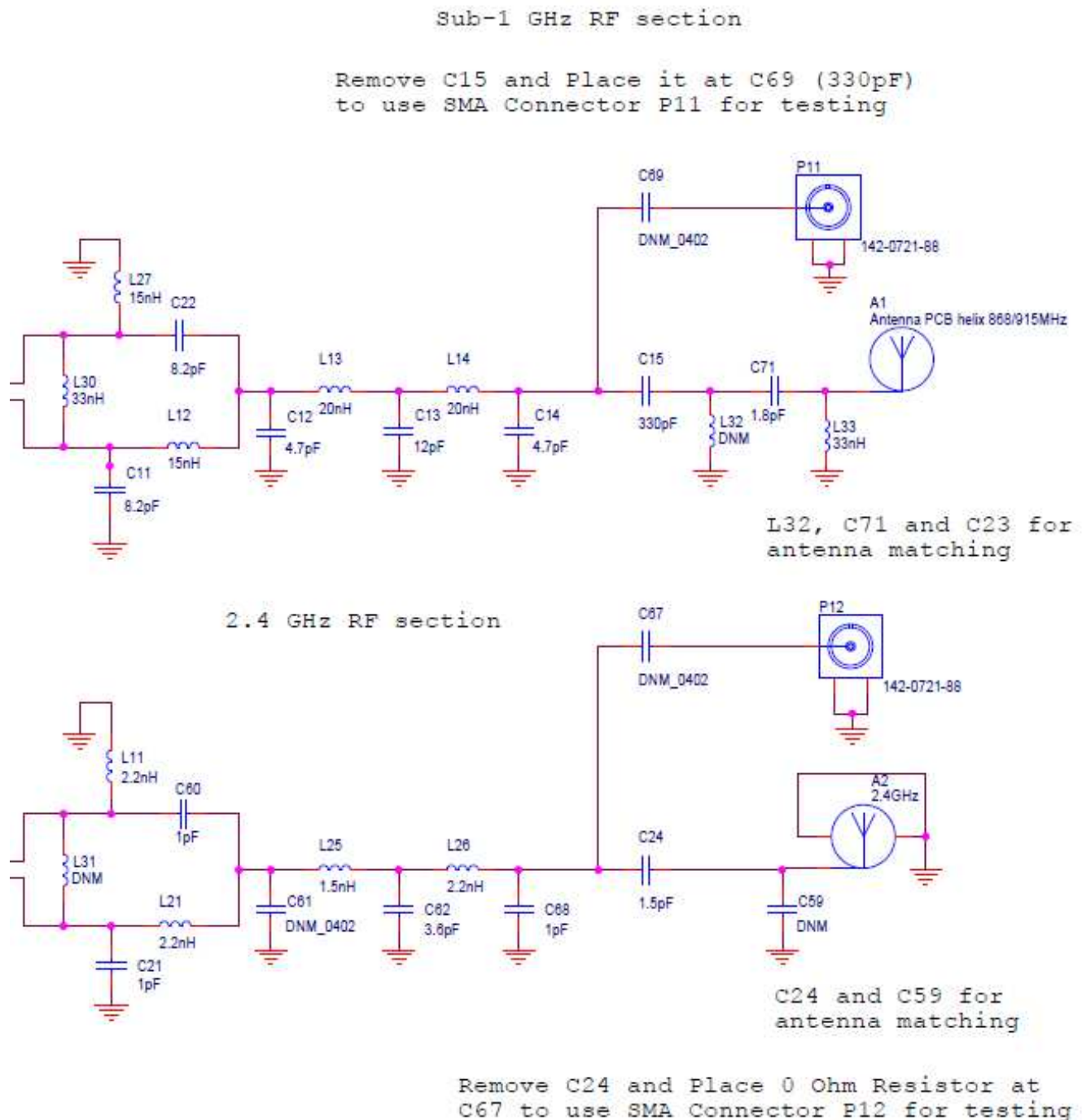
4.2 Required Software

The following software is used for the functional tests.

- SA13x0 Windows Installer
- [SmartRF™ Studio](#)

See [3 节](#) for details on installing and configuring the SA13x0 Windows GUI. See the SmartRF Studio tool page for instructions on how to configure the SmartRF Studio.

4.3 Test Setup

[图 9](#) shows the test equipment setup. The function-generator output is connected to the input of the RF divider. One output of the RF divider is connected to the CC13x0 LaunchPad connector P11 or P12, depending on the RF band of the current test. The other output of the RF divider is connected to the Agilent Spectrum Analyzer for the reference measurement.



图 9. Test Equipment Setup

4.4 Unmodulated Carrier Test

The unmodulated carrier test applies an unmodulated carrier to the SA13x0, to confirm the peak-magnitude accuracy and frequency of the RF measurements. The test is repeated with a carrier frequency set at the center, upper, and lower edges of each SA13x0 supported band. Consequently, a total of nine frequencies are tested.

At each frequency, the magnitude of the carrier is varied in 10-dB increments, from -100 dBm to -60 dBm. The overall test includes 45 separate runs: nine frequencies at five power levels each. The RF signal at each point is measured with the SA13x0 GUI and the Agilent spectrum analyzer.

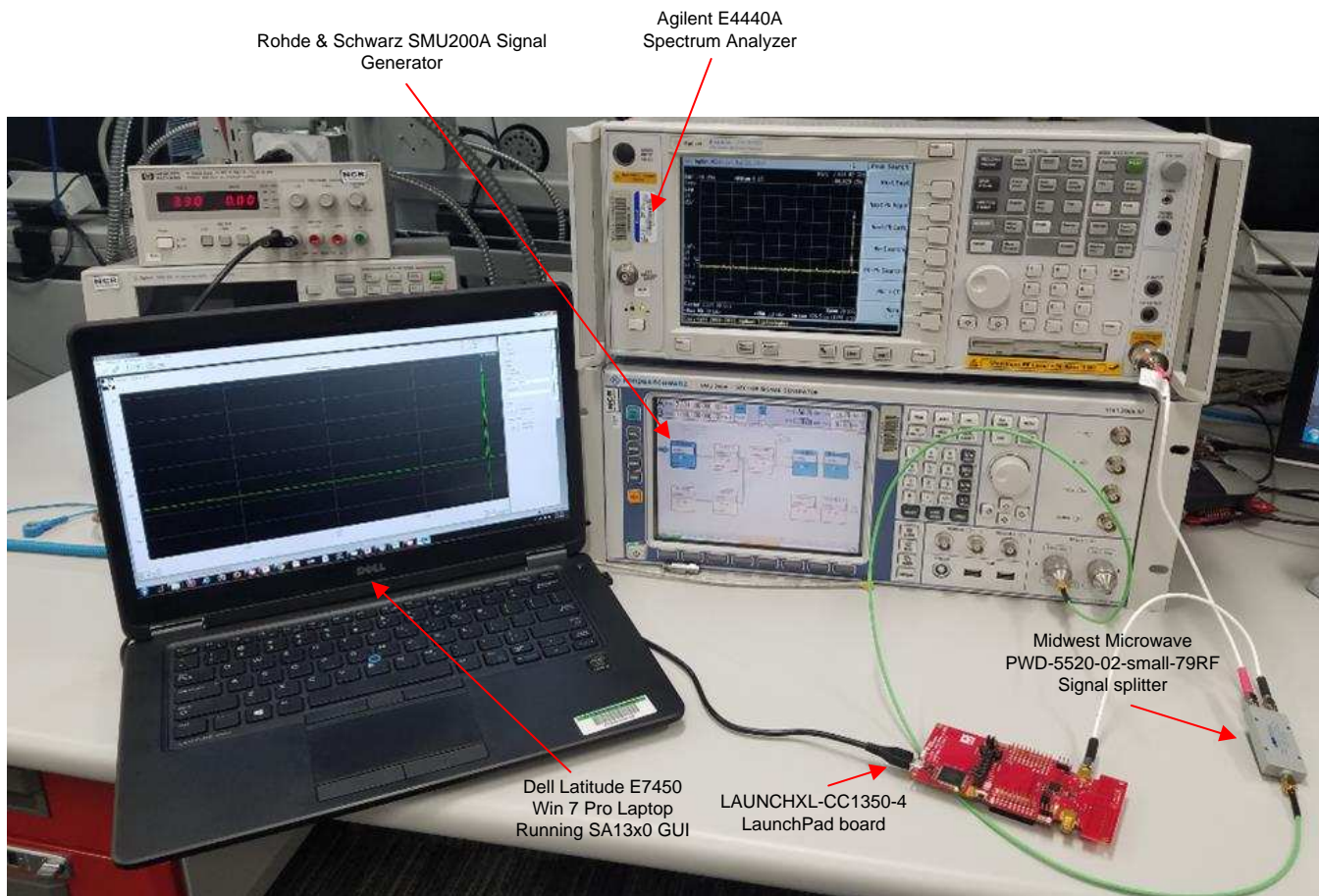
4.4.1 SA13x0 GUI Settings for Unmodulated Carrier Test

表 3 lists the SA13x0 Expert RF Mode configuration used for the unmodulated carrier test at each frequency.

表 3. SA13x0 Expert RF Mode Configuration for Unmodulated Carrier Test

| TEST CONFIG NO. | CENTER f (MHz) | SPAN (MHz) | RBW (kHz) | FSW (kHz) | RefLvl (dBm) |
|-----------------|------------------|------------|-----------|-----------|--------------|
| 1 | 441 | 20 | 38.9 | 19.226 | -70 |
| 2 | 479 | | | | |
| 3 | 517 | | | | |
| 4 | 871 | | | | |
| 5 | 957.5 | | 43.5 | | |
| 6 | 1044 | | | | |
| 7 | 2162 | | | | |
| 8 | 2393.5 | | | | |
| 9 | 2625 | | | | |

4.4.2 Signal-Generator Settings for Unmodulated Carrier Test

The signal generator is configured to output a signal, with modulation turned off, at the frequency under test, at a magnitude equal to the magnitude under test plus the measured RF loss, through the coax cables and divider. The RF losses are measured at the cable ends for both splitter outputs at the center frequency of each band under test by the spectrum analyzer.

4.5 Modulated Carrier Test

The modulated carrier test applies a modulated carrier to the SA13x0, to confirm the RF waveform shape, frequency, and magnitude accuracy of the RF measurements. The test is repeated with a carrier frequency set at a single frequency in each of the SA13x0 supported bands. Consequently, a total of three frequencies are tested.

At each frequency, a LAUNCHXL-CC1350-4 LaunchPad is connected to the SmartRF Studio in either Proprietary mode for sub-1 GHz tests or BLE mode for 2.4-GHz tests, to act as the modulated carrier source. The overall test includes three separate runs – one run at each frequency. The RF signal at each point is measured with the SA13x0 GUI and the Agilent spectrum analyzer.

4.5.1 SA13x0 GUI Settings for Modulated Carrier Test

表 4 lists the SA13x0 Expert RF mode configuration used for the modulated carrier test.

表 4. SA13x0 Expert RF Mode Configuration for Modulated Carrier Test

| CENTER f (MHz) | SPAN (MHz) | RBW (kHz) | FSW (kHz) | RefLvl (dBm) |
|------------------|------------|-----------|-----------|--------------|
| 444 | 25 | 117.7 | 31.250 | -55 |
| 915 | | | | |
| 2440 | | | | |

4.5.2 Function Generator Settings for Modulated Carrier Test

A separate LaunchPad board and SmartRF Studio software are used in place of the bench-top function generator, to generate the modulated carrier waveform. 表 5 lists the SmartRF Studio, Continuous-TX test, RF Parameters used for the modulated carrier test.

表 5. SmartRF™ Studio RF Parameters for Modulated Carrier Test

| f (MHz) | SYMBOL RATE (kbaud) | DEVIATION (kHz) | TX POWER (dBm) | WHITENING |
|-----------|---------------------|-----------------|----------------|--------------|
| 444 | 50 | 25 | -10 | No whitening |
| 915 | | | | |
| 2440 | N/A (BLE Mode) | N/A (BLE Mode) | -21 | Checked |

In addition to the RF Parameters, *Modulated* is selected in the Continuous TX test tab of the SmartRF Studio software.

4.6 Test Results and Summary

4.6.1 Unmodulated Carrier Test Results

表 6 lists the configuration of the SA13x0 and signal generator for each test run, in addition to the measured power of the spectrum analyzer and indicated power of the SA13x0.

表 6. Unmodulated Carrier Test Results

| SA13x0 CENTER f (MHz) | SIGNAL GENERATOR CARRIER CENTER f (MHz) | SIGNAL GENERATOR CARRIER MAGNITUDE (dBm) | SPECTRUM ANALYZER POWER MEASUREMENT (dBm) | SA13x0 GUI INDICATED POWER (dBm) |
|----------------------------|---|--|---|-------------------------------------|
| 441 | 432 | -100 | -100.441 | -95.9 |
| | | -90 | -90.390 | -85.7 |
| | | -80 | -80.265 | -75.4 |
| | | -70 | -70.303 | -66.0 |
| | | -60 | -60.285 | -56.0 |
| 479 | 479 | -100 | -100.559 | -97.5 |
| | | -90 | -90.924 | -88.0 |
| | | -80 | -82.478 | -78.3 |
| | | -70 | -70.792 | -69.0 |
| | | -60 | -60.777 | -60.4 |
| 517 | 526 | -100 | -100.456 | -100.3 |
| | | -90 | -90.395 | -90.1 |
| | | -80 | -80.442 | -80.0 |
| | | -70 | -70.417 | -70.1 |
| | | -60 | -60.369 | -60 |
| 871 | 862 | -100 | -100.668 | -106.5 |
| | | -90 | -90.848 | -96.1 |
| | | -80 | -80.462 | -86.0 |
| | | -70 | -70.442 | -77.0 |
| | | -60 | -60.434 | -66.0 |
| 957.5 | 957.5 | -100 | -102.532 | -105.4 |
| | | -90 | -92.417 | -95.3 |
| | | -80 | -82.337 | -85.0 |
| | | -70 | -72.502 | -75.0 |
| | | -60 | -62.527 | -66.0 |
| 1044 | 1053 | -100 | -102.094 | -102.6 |
| | | -90 | -90.799 | -95.1 |
| | | -80 | -80.769 | -85.0 |
| | | -70 | -70.767 | -75.0 |
| | | -60 | -60.916 | -65.1 |
| 2162 | 2153 | -100 | -103.983 | -102.0 |
| | | -90 | -94.257 | -90.0 |
| | | -80 | -84.787 | -80.2 |
| | | -70 | -74.813 | -74.6 |
| | | -60 | -61.662 | -54.3 |
| 2393.5 | 2393.5 | -100 | -102.505 | -100.1 |
| | | -90 | -92.236 | -88.7 |
| | | -80 | -82.292 | -80.2 |
| | | -70 | -72.334 | -73.1 |
| | | -60 | -62.213 | -57.6 |
| 2625 | 2634 | -100 | -109.374 | -106.3 |
| | | -90 | -95.279 | -95.8 |
| | | -80 | -85.307 | -83.8 |
| | | -70 | -75.058 | -73.1 |
| | | -60 | -64.98 | -63.9 |

4.6.2 Modulated Carrier Test Results

图 10 和 图 11 显示调制载波测试的 2.4-GHz 频段的原始测试结果。图 10 显示了 SA13x0 测量的截图，图 11 显示了 Agilent 频谱分析仪测量的截图。



图 10. SA13x0 Modulated Carrier Test Measurement



图 11. Spectrum Analyzer Carrier Test Measurement

表 7 列出了每个测试运行的峰值和旁瓣频率，以及频谱分析仪测量的功率和 SA13x0 的指示功率。

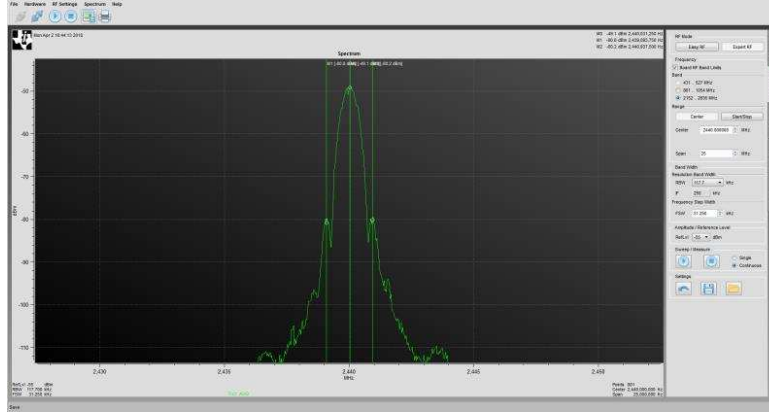
表 7. Modulated Carrier Test Results

| PEAK f (MHz) | LEFT-LOBE f (MHz) | RIGHT-LOBE f (MHz) | SPECTRUM ANALYZER PEAK POWER (dBm) | SA13x0 PEAK INDICATED POWER (dBm) | SPECTRUM ANALYZER LEFT-LOBE POWER (dBm) | SA13x0 LEFT-LOBE INDICATED POWER (dBm) | SPECTRUM ANALYZER RIGHT-LOBE POWER (dBm) | SA13x0 RIGHT-LOBE INDICATED POWER (dBm) |
|----------------|---------------------|----------------------|------------------------------------|-----------------------------------|---|--|--|---|
| 444.00 | 443.9 | 444.1 | -48.073 | -43.0 | -87.184 | -70.0 | -88.845 | -74.1 |
| 915.00 | 914.9 | 915.1 | -49.141 | -60.0 | -86.080 | -83.7 | -88.886 | -89.7 |

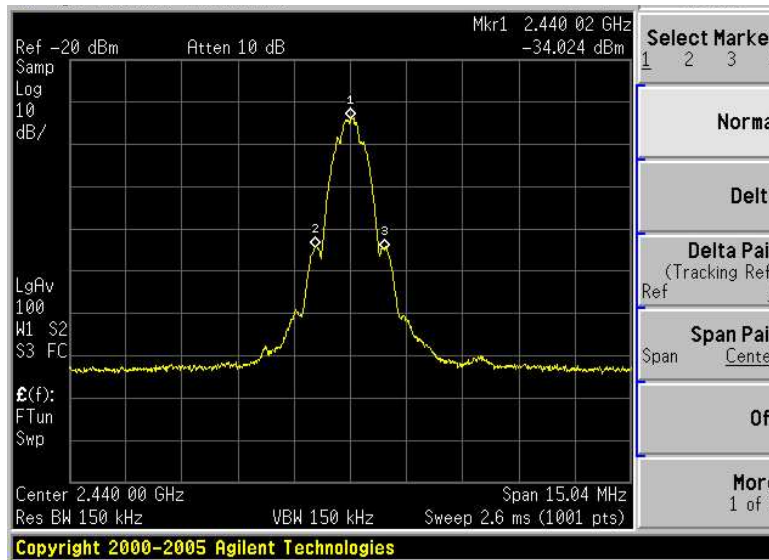
表 7. Modulated Carrier Test Results (continued)

| PEAK f (MHz) | LEFT-LOBE f (MHz) | RIGHT-LOBE f (MHz) | SPECTRUM ANALYZER PEAK POWER (dBm) | SA13x0 PEAK INDICATED POWER (dBm) | SPECTRUM ANALYZER LEFT-LOBE POWER (dBm) | SA13x0 LEFT-LOBE INDICATED POWER (dBm) | SPECTRUM ANALYZER RIGHT-LOBE POWER (dBm) | SA13x0 RIGHT-LOBE INDICATED POWER (dBm) |
|----------------|---------------------|----------------------|------------------------------------|-----------------------------------|---|--|--|---|
| 2440 | 2439 | 2441 | -34.289 | -30.5 | -65.439 | -63.4 | -64.596 | -62.1 |

图 12 through 图 14 display a comparison between the spectrum analyzer measurement and the SA13x0 measurement of the 2.4-GHz, 915-MHz, and 444-MHz bands. To generate these graphs the trace export feature of the SA13x0 GUI is used, to save a comma-separated values (.csv) file of the test results. The trace export feature is accessible from the Traces tab of the GUI. A similar export feature is used to save the measurement results from the Agilent Spectrum Analyzer, and then Microsoft Excel is used to format the results in 图 12 through 图 14.



图 12. Modulated Carrier Test Results: 2.4-GHz Band



图 13. Modulated Carrier Test Results: 915-MHz Band

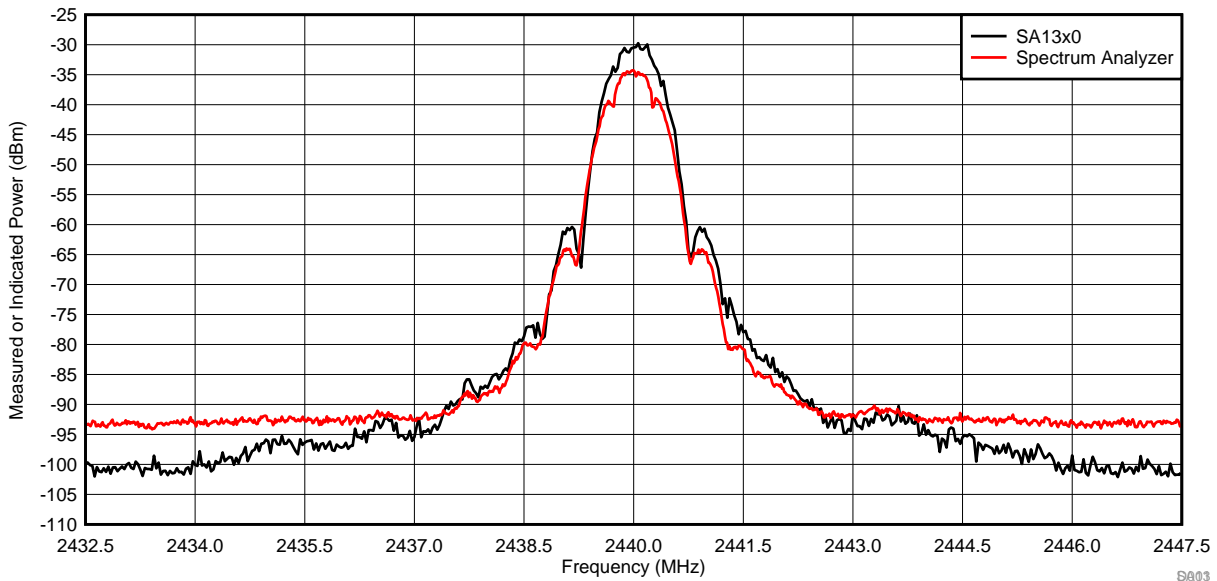

图 14. Modulated Carrier Test Results: 444-MHz Band

4.6.3 Test Results Summary

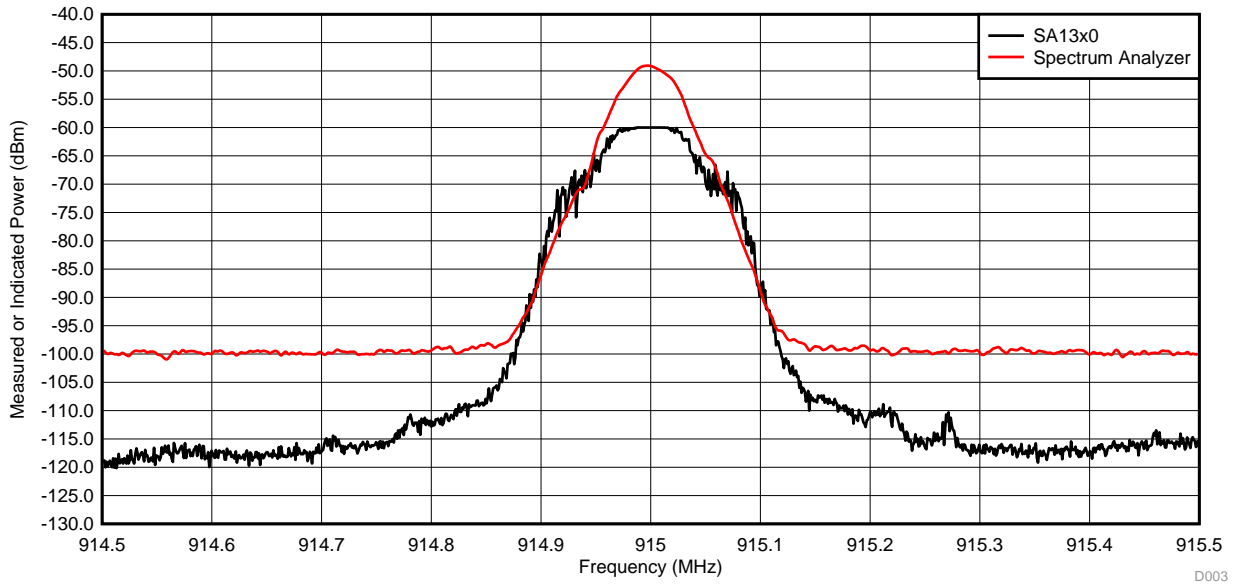
The performance of the SA13x0 indicated that power measurements are useful for debug and developmental testing of low-power RF systems. Although the SA13x0 capabilities are not expected to match the level of a dedicated spectrum analyzer, the tool provides very valuable results at a cost that is exponentially lower. This expectation of performance is reflected in both of the carrier test results summarized below.

Unmodulated-carrier test results indicate an average absolute error versus the signal generators input of 3.7 dB for the SA13x0, in comparison to 1.895 dB of the spectrum analyzer across all runs. The maximum error versus the signal-generators input was 7 dB for the SA13x0 and 8.278 dB for the spectrum analyzer. The average relative error of the SA13x0 versus the spectrum analyzer measurement was 3.0 dB across all runs, with a maximum error of 6.6 dB.

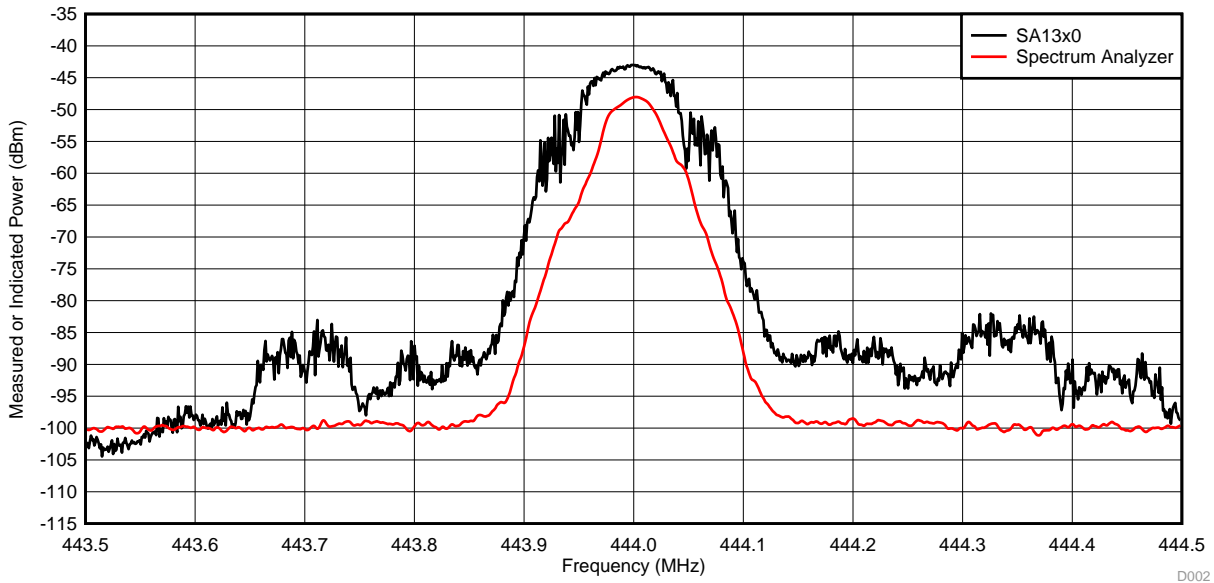
Modulated-carrier test results show an average peak measurement difference of 6.6 dB between the SA13x0 and spectrum analyzer. When comparing the power delta from the peak to side lobes, the average difference of the SA13x0 delta from the spectrum analyzer delta was 8.0 dB. These two results show that both the absolute modulated-measurement performance and relative modulated-measurement performance are similar to those seen in the unmodulated performance results of the SA13x0. [图 12](#) through [图 14](#) show a qualitative graphical view for the performance of the SA13x0 modulated-carrier test, which aligns with this quantitative performance summary.

The SA13x0 test results confirm the expectations of the system to be capable of providing RF power indication levels to a user. The SA13x0 performs well as an easy-to-use and affordable tool to quick-start RF development, as reflected in the results of both the unmodulated and modulated carrier tests.

5 Troubleshooting

- Problem: The hardware is connected, but it is not shown as available in the hardware tab.
Solution: Scan for connected devices (see [图 1](#)). It is possible that the device was plugged in after the software was started.
- Problem: The device is still not shown.
Solution: Check the green LED closest to the USB connector, the LED should be on. Ensure that the COM port shows in the device manager.
- Problem: After the user connects the USB the device is shown, but they cannot connect to it.
Solution: Ensure that the port is not used by any other software. Some applications connect to everything they can and block access to the port. Ensure that no other instances of SA13x0Gui.exe are running. Remove the SA13x0 hardware from the USB and reinsert it.
- Problem: What if the PC loses power?
Solution: Ensure to use the export-RF settings function to save the work for later reference.
- Problem: The user has an issue that is not described here. What should they do?
Solution: Go online to e2e.ti.com and post a question to the community.

6 Design Files

To download the software files, see the design files at [TIDC-01004](#).

6.1 Hardware Design Files

To download the schematics, BOM, PCB layout recommendations, Altium, Gerber, and assembly drawings, see the design files at:

- [CC1310 LaunchPad](#)
- [CC1350 LaunchPad](#)
- [CC1350-4 LaunchPad](#)
- [Sharp® Memory LCD BoosterPack](#)

7 Related Documentation

The following are related documents:

Texas Instruments, [CC1310 SimpleLink™ Ultra-Low-Power Sub-1 GHz Wireless MCU](#) , data sheet

Texas Instruments, [CC1350 SimpleLink™ Ultra-Low-Power Dual-Band Wireless MCU](#), data sheet

Texas Instruments, [CC1310 LaunchPad](#), product page

Texas Instruments, [CC1350 LaunchPad](#), product page

Texas Instruments, [CC1350-4 LaunchPad](#), product page

Texas Instruments, [Sharp® Memory LCD BoosterPack](#), product page

7.1 商标

LaunchPad 上, , BoosterPack, E2E, SimpleLink, SmartRF are trademarks of Texas Instruments. Arm, Cortex are registered trademarks of Arm Limited. Windows is a registered trademark of Microsoft Corporation. Wi-Fi is a registered trademark of Wi-Fi Alliance.

ZigBee is a trademark of ZigBee Alliance.
All other trademarks are the property of their respective owners.

8 About the Authors

RUBEN D. PEREZ is an applications engineer and Senior Member of Technical Staff at Texas Instruments. Ruben specializes in embedded systems design with microcontrollers, applications processors, and RF transceiver ICs. Ruben earned his bachelor of science in electrical engineering (BSEE) degree from the University of Florida and a master of electrical engineering (MEE) degree from Rice University.

MARK SWANSON is a field applications engineer at Texas Instruments. Mark specializes in embedded systems design with connected and wireless microcontrollers within industrial and medical applications. Mark earned his Bachelor of Science in Computer Engineering (BSCPE) degree from Rose-Hulman Institute of Technology and a Master of Science in Computer Engineering (MSCPE) degree from Florida Atlantic University.

有关 TI 设计信息和资源的重要通知

德州仪器 (TI) 公司提供的技术、应用或其他设计建议、服务或信息，包括但不限于与评估模块有关的参考设计和材料（总称“TI 资源”），旨在帮助设计人员开发整合了 TI 产品的应用；如果您（个人，或如果是代表贵公司，则为贵公司）以任何方式下载、访问或使用了任何特定的 TI 资源，即表示贵方同意仅为该等目标，按照本通知的条款进行使用。

TI 所提供的 TI 资源，并未扩大或以其他方式修改 TI 对 TI 产品的公开适用的质保及质保免责声明；也未导致 TI 承担任何额外的义务或责任。TI 有权对其 TI 资源进行纠正、增强、改进和其他修改。

您理解并同意，在设计应用时应自行实施独立的分析、评价和判断，且应全权负责并确保应用的安全性，以及您的应用（包括应用中使用的 TI 产品）应符合所有适用的法律法规及其他相关要求。就您的应用声明，您具备制订和实施下列保障措施所需的一切必要专业知识，能够 (1) 预见故障的危险后果，(2) 监视故障及其后果，以及 (3) 降低可能导致危险的故障几率并采取适当措施。您同意，在使用或分发包含 TI 产品的任何应用前，您将彻底测试该等应用和该等应用所用 TI 产品的功能而设计。除特定 TI 资源的公开文档中明确列出的测试外，TI 未进行任何其他测试。

您只有在为开发包含该等 TI 资源所列 TI 产品的应用时，才被授权使用、复制和修改任何相关单项 TI 资源。但并未依据禁止反言原则或其他法律授予您任何 TI 知识产权的任何其他明示或默示的许可，也未授予您 TI 或第三方的任何技术或知识产权的许可，该等许可包括但不限于任何专利权、版权、屏蔽作品权或与使用 TI 产品或服务的任何整合、机器制作、流程相关的其他知识产权。涉及或参考了第三方产品或服务的信息不构成使用此类产品或服务的许可或与其相关的保证或认可。使用 TI 资源可能需要您向第三方获得对该等第三方专利或其他知识产权的许可。

TI 资源系“按原样”提供。TI 兹免除对 TI 资源及其使用作出所有其他明确或默示的保证或陈述，包括但不限于对准确性或完整性、产权保证、无复发故障保证，以及适销性、适合特定用途和不侵犯任何第三方知识产权的任何默认保证。

TI 不负责任何申索，包括但不限于因组合产品所致或与之有关的申索，也不为您辩护或赔偿，即使该等产品组合已列于 TI 资源或其他地方。对因 TI 资源或其使用引起或与之有关的任何实际的、直接的、特殊的、附带的、间接的、惩罚性的、偶发的、从属或惩戒性损害赔偿，不管 TI 是否获悉可能会产生上述损害赔偿，TI 概不负责。

您同意向 TI 及其代表全额赔偿因您不遵守本通知条款和条件而引起的任何损害、费用、损失和/或责任。

本通知适用于 TI 资源。另有其他条款适用于某些类型的材料、TI 产品和服务的使用和采购。这些条款包括但不限于适用于 TI 的半导体产品 (<http://www.ti.com/sc/docs/stdterms.htm>)、[评估模块](http://www.ti.com/sc/docs/sampters.htm)和样品 (<http://www.ti.com/sc/docs/sampters.htm>) 的标准条款。

邮寄地址：上海市浦东新区世纪大道 1568 号中建大厦 32 楼，邮政编码：200122
Copyright © 2018 德州仪器半导体技术（上海）有限公司