

设计指南: TIDA-010015

效率为 94.5% 的 500W 工业交流/直流参考设计



说明

该参考设计是用于工业交流/直流电源的紧凑型、高效率、24V 直流、500W 参考设计。该设计包括一个基于 UCC28064A 的交错双相转换模式 (TM) 功率因数校正 (PFC) 前端。这最大限度地减小了 PFC 电感器尺寸并降低了 EMI 滤波器要求。该直流/直流功率级通过 HB-LLC 级实现，后者使用了 TI 的 UCC256301 器件。为了提高效率，在次级侧使用 UCC24612 实现了同步整流。

资源

| | |
|-----------------------------|-------|
| TIDA-010015 | 设计文件夹 |
| UCC28064A | 产品文件夹 |
| UCC256301 | 产品文件夹 |
| UCC24612 | 产品文件夹 |
| CSD19505KCS | 产品文件夹 |
| UCC27517 | 产品文件夹 |
| LP2951-N | 产品文件夹 |
| TL431A | 产品文件夹 |
| TL331 | 产品文件夹 |
| TLV171 | 产品文件夹 |
| INA181 | 产品文件夹 |

特性

- 满载条件下的总体效率达 94.5%，峰值效率大于 95%，待机功率小于 200mW
- 高达 330W 的工作功率，无需强制冷却
- 功率因数高达 0.99 以上，并满足 PFC 规范以及 IEC 61000-3-2 A 类电流 THD 规定
- 符合传导发射标准 (EN55011 B 类) 的要求
- LLC 控制器具有 ZSC 回避功能和 OVP 感应功能，可提升可靠性，并针对过流、短路和过压情况保护系统，确保安全
- 小巧的 PCB 外形：160mm × 80mm × 35mm

应用

- 工业交流/直流
- DIN 轨电源
- 消费类交流/直流电源
- 电池充电器



咨询我们的 E2E™ 专家

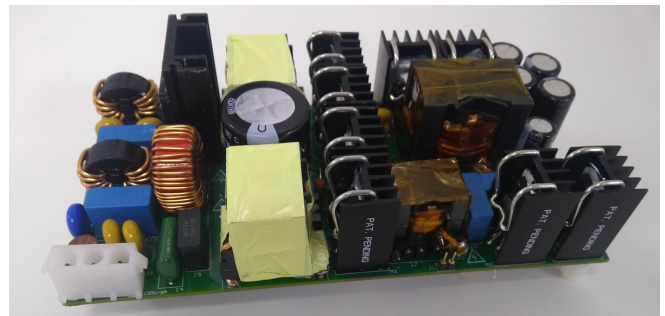
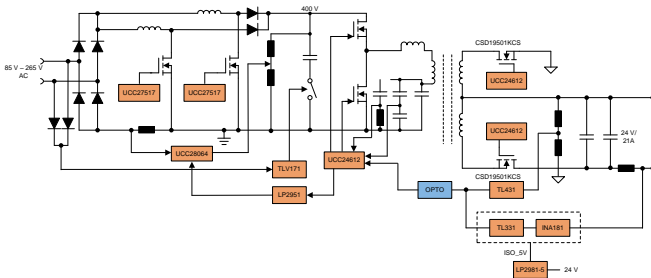

该 TI 参考设计末尾的重要声明表述了授权使用、知识产权问题和其他重要的免责声明和信息。

1 System Description

Industrial AC/DC power supplies are used in various applications such as process control, data logging, machinery control, instrumentation, factory automation, and security systems. These AC/DC supplies provide a convenient means for powering DC operated devices including programmable logic controllers (PLCs), sensors, transmitters and receivers, analyzers, motors, actuators, solenoids, relays, and so on. These supplies are convection cooled and need to support features like power boost where it supplies a increased output load for a short duration. The supplies operate over a wide input range from 85- to 265-V AC, delivering full load for entire input voltage range. The output voltages from these supplies range from 5 to 56 V with power ratings from 7.5 to 500 W. Many of these supplies can be connected in parallel for higher power applications.

This reference design is a 500-W high efficiency industrial AC/DC power supply. The design consists of a two-phase-interleaved, critical conduction mode (CrCM) PFC converter, which operates from an input voltage range of 85- to 265-V AC RMS and generates a 400-V DC bus. The second stage is made up of an isolated half-bridge LLC stage, which generates a 24-V, 20-A nominal output. Industrial power supplies have requirements of high efficiency over their entire operating voltage range and wide load variations from a 50% to 100% load. This design demonstrates high efficiency operation in a small form factor (155 x 125 mm) and delivers continuous 480 W of power over the entire input operating voltage range from 85- to 265-V AC. It gives an efficiency of > 94.5% for 230-V AC nominal operation and 92% for 115-V AC nominal operation.

The UCC28064A PFC integrated circuit (IC) controls the interleaved CrCM PFC stage. Interleaved critical conduction mode (CrCM) and continuous conduction mode (CCM) are the two popular topologies for PFC applications with greater than 300-W output power. CrCM PFC has the advantage of minimizing the turnon losses on the PFC MOSFET and eliminates the reverse recovery on the boost diode to reduce losses. CrCM PFC also has a much smaller inductor value than the CCM PFC. The reduced boost inductor value helps to develop the low-profile magnetics necessary for meeting the thin-profile requirement in the design. By interleaving two CrCM power stages, the effective input ripple current is reduced and helps to minimize the EMI filter requirement. The HB-LLC power stage is controlled through the stage of the art UCC256301 resonant controller, which implements current mode control for increased control bandwidth. This increased control bandwidth reduces the output capacitors required to suppress the AC ripple on the output. To achieve high efficiency, the output of the LLC stage uses synchronous rectification based on the UCC24612 device and the CSD19505KCS MOSFET.

The design has low standby power of < 200 mW and meets ENERGY STAR rating requirements as well as 2013 EU eco-design directive ErP Lot 6. The EMI filter is designed to meet EN55011 class-B conducted emission levels. The design is fully tested and validated for various parameters such as regulation, efficiency, EMI signature, output ripple, start-up, and switching stresses. Overall, the design meets the key challenges of industrial power supplies to provide safe and reliable power with all protections built-in, while delivering high performance with low power consumption and low bill-of-material (BoM) cost.

1.1 Key System Specifications

表 1. Key System Specifications

| PARAMETER | TEST CONDITIONS | MIN | NOM | MAX | UNIT |
|-------------------------------|--|-------------------------------|------|-----|------|
| INPUT CONDITIONS | | | | | |
| Input voltage (V_{INAC}) | – | 85 | 230 | 265 | VAC |
| Frequency (f_{LINE}) | – | 47 | 50 | 63 | Hz |
| No load power (PSB) | – | – | 200 | – | mW |
| OUTPUT CONDITIONS | | | | | |
| Output voltage | Full load (500 W) | | 24 | | V |
| Output current | Full load (500 W) | | 21 | | A |
| Line regulation | V_{IN} from 85 VAC to 265 VAC, 500-W load | | | 0.5 | % |
| Load regulation | $V_{IN} = 230$ V, output load from 50 W–500 W | | | 1 | % |
| Output voltage ripple | $V_{IN} = 230$ V, load = 500 W, | | 200 | | mV |
| Output power (nominal) | | | | 500 | W |
| SYSTEM CHARACTERISTICS | | | | | |
| Efficiency (η) | $V_{IN} = 230$ -V AC RMS and full load at 24-V output | | 94.5 | | % |
| | $V_{IN} = 115$ -V AC RMS and 230-W load at 24-V output | | 92 | | % |
| Protections | Output overcurrent | | 25 | | A |
| | Output overvoltage | | 30 | | V |
| Operating ambient | Open frame | -10 | 25 | 55 | °C |
| Standards and norms | Power line harmonics | As per IEC 61000-3- 2 Class A | | | |
| | Conducted emissions | EN55022 Class B | | | |
| | EFT | As per IEC-61000-4-4 | | | |
| | Surge | As per IEC-61000-4-5 | | | |
| Board form factor | FR4 material, 2-layer, 2-oz copper | 160 × 80 × 35 | | | mm |

2 System Overview

2.1 Block Diagram



图 1. TIDA-010015 Block Diagram

图 1 shows the high-level block diagram of this reference design. The main parts of this design are the UCC28064A (PFC controller), UCC256301 (LLC controller), UCC24612-2 (multi-mode synchronous rectifier controller), and CSD19505KCS (80-V MOSFET).

2.2 Highlighted Products

2.2.1 UCC28064A

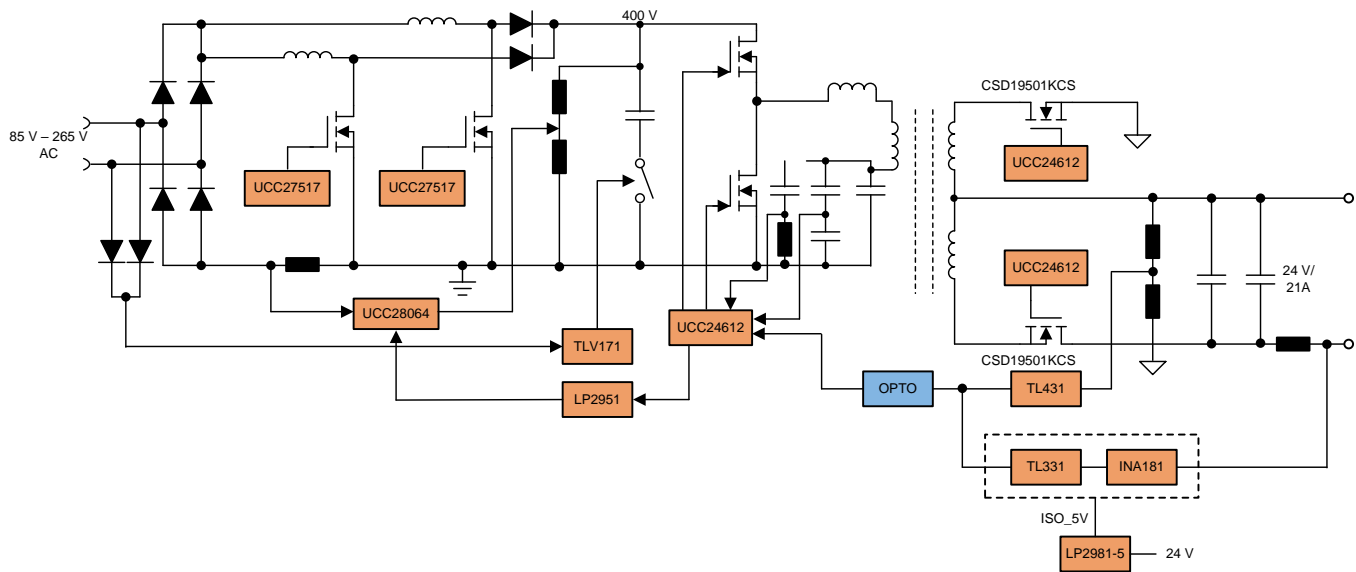
The UCC28064A is a two-phase, naturally-interleaved, transient-mode power factor correction (PFC) controller for implementing a high-efficiency, low-component-count, front-end AC/DC PFC stage. The two phase interleaved power stage reduces the filter requirements for input current ripple electromagnetic interference (EMI).

Interleaving control and phase management facilitates high efficiency 80+ and Energy Star designs with reduced input and output ripple. The Natural Interleaving method allows TM operation and achieves 180 degrees between the phases by On-time management and does not rely on tight tolerance requirements on the inductors. The Crossover Notch Reduction block implements a non-linear current shaping characteristic on the instantaneous voltage sense (VINAC) to reduce distortion and increase Power Factor. Negative current sensing is implemented on the total input current instead of just the MOSFET current which prevents MOSFET switching during inrush surges or in any mode where the inductor current may become substantially continuous (CCM). This prevents reverse recovery conduction events between the MOSFET and output rectifier.

2.2.2 UCC256301

Series resonant converters like LLC are one of the most widely used topologies for implementing medium- to high-power isolated DC/DC power stages in consumer and industrial power supplies. LLC resonant converters are quite popular due to their ability to achieve soft-switching (ZVS turnon) for high-voltage MOSFETs, thereby improving the overall efficiency of a system.

The UCC256301 has a unique, hybrid hysteretic control that provides excellent line and load transient response, minimizing the requirement for output filter capacitors. The wide frequency range of the device can be used to reduce the PFC bulk capacitor required to meet the holdup time requirement in the industrial power supplies. With the integrated high-voltage gate drive, X-Cap discharge function, and additional output overvoltage protection, the UCC256301 reduces the amount of external discrete components required to implement a high-efficiency industrial power supply.

2.2.3 UCC24612-2

The UCC24612-2 is a multi-mode synchronous rectifier controller for active clamp flyback and LLC applications. Along with its 4-A sink and 1-A source capability, this device has a proportional gate drive, which helps when using this synchronous rectifier in LLC applications where the system can operate far above the resonant frequency. The adaptive off-time feature adds robustness to the synchronous rectifier by preventing false triggering.

2.2.4 CSD19505KCS

The CSD19505KCS is an 80-V NexFET™ power MOSFET, with 2.6-mΩ resistance and 76-nC gate charge. In this reference design, the CSD19505KCS is used as the synchronous field-effect transistor (FET) to lower the losses in the output stage of the LLC converter.

2.3 System Design Theory

This reference design provides a universal AC mains-powered, 500-W nominal output at 24 V and 20 A. This design comprises a front-end AC/DC PFC power stage followed by an isolated DC/DC LLC power stage.

2.3.1 PFC Regulator Stage Design

For high power levels such as 500 W, either the single-phase CCM PFC or interleaved CrCM PFC is the preferred topology for implementing PFC. Interleaved CrCM PFC offers certain advantages at these power levels because it ensures valley switching for the PFC MOSFET and ZCS turnoff diode, which reduces the losses in the PFC stage. Cheaper diodes can be used because the PFC diode does not have a hard turnoff. CrCM PFC requires a smaller PFC inductor. By interleaving two CrCM power stages, the overall input ripple current is also reduced. Alternatively, CCM PFC requires a larger inductor and is not very effective in low-profile designs.

This reference design uses the UCC28064A-based interleaved CrCM PFC. The following subsections detail the design process and component selection.

2.3.1.1 Design Parameters

表 2. Design Parameters for PFC Power Stage Design

| SYMBOL | PARAMETER | MIN | TYP | MAX | UNIT |
|----------------|----------------------------|-----|------|-----|------|
| INPUT | | | | | |
| V_{IN} | Input Voltage | 85 | 230 | 265 | V |
| f_{LINE} | Input frequency | 47 | | 63 | Hz |
| OUTPUT | | | | | |
| V_{OUT} | Output voltage | | 390 | | VDC |
| $P_{OUT(nom)}$ | Output power | | | 500 | W |
| | Line Regulation | | | 5% | |
| | Load Regulation | | | 5% | |
| PF | Targeted power factor | | 0.99 | | |
| η | Targeted efficiency | | 98% | | |
| iTHD | Targeted input current THD | | 5% | | |

2.3.1.2 Input Current Calculations

The input fuse, bridge rectifier, and input capacitor are selected based on the input current calculations. First, determine the maximum average output current, $I_{OUT(max)}$ as per 公式 1:

$$I_{OUT(max)} = \frac{P_{OUT(max)}}{V_{OUT(max)}} = \frac{500}{390} = 1.28 \text{ A} \quad (1)$$

Calculate the maximum input root mean square (RMS) for the line current, $I_{INrms(max)}$, using the parameters from the 表 2 and the initial assumptions of the efficiency and power factor:

$$I_{INrms(max)} = \frac{P_{OUT(max)}}{\eta \times V_{IN(min)} \times PF} = \frac{500}{0.945 \times 85 \times 0.99} = 6.29 \text{ A} \quad (2)$$

2.3.1.3 Boost Inductor

Calculate the boost inductor using the minimum input voltage and the minimum desired frequency of operation. First calculate the duty cycle, $DUTY_{(max)}$, at the peak of the minimum input voltage:

$$DUTY_{max} = \frac{V_{OUT(nom)} - V_{INrms(min)} \times \sqrt{2}}{V_{OUT(nom)}} = \frac{390 - (1.414 \times 85)}{390} = 0.691 \quad (3)$$

公式 4 calculates the boost inductor value.

$$L1 = L2 = \frac{\eta \times (V_{INrms(min)})^2 \times DUTY_{(max)}}{P_{OUT(max)} \times F_{MIN}} \quad (4)$$

The minimum switching frequency of the converter (f_{MIN}) under low line conditions occurs at the peak of low line and is set between 25 kHz and 50 kHz to avoid audible noise. The minimum switching frequency chosen for this design is 40 kHz. Substituting the final values, the boost inductor's inductance is calculated by 公式 5

$$L1 = L2 = \frac{0.945 \times 85^2 \times 0.69}{500 \times 40000} = 236 \text{ } \mu\text{H} \quad (5)$$

The actual value of the boost inductor used is 240 μH . Calculate the required saturation current for the boost inductor is using 公式 6 for the minimum input voltage and under the assumption that both phases equally share the load.

$$I_{L(\max)} = \left(\sqrt{2} \times \frac{P_{\text{OUT}(\max)}}{\eta \times V_{\text{INRMS}(\min)}} \right) = 8.8 \text{ A} \quad (6)$$

The inductor RMS current can be calculated as per 公式 7

$$I_{L\text{-RMS}} = \frac{I_{L(\max)}}{\sqrt{6}} = \frac{8.8 \text{ A}}{\sqrt{6}} = 3.6 \text{ A} \quad (7)$$

2.3.1.4 Output Capacitor

The output capacitor (C_{OUT}) is selected based on the holdup requirement of 10 ms and an output ripple of 25 Vp-p, as 公式 8 and 公式 9 show.

$$C_{\text{OUT}} = \frac{2 \times P_{\text{OUT}(\max)} \times t_{\text{hold-up}}}{\eta \times (V_{\text{OUT}(\text{nom})}^2 - V_{\text{OUT}(\min)}^2)} = \frac{2 \times 500 \times 10 \text{ ms}}{0.945 \times (390^2 - 250^2)} = 123 \text{ } \mu\text{F} \quad (8)$$

$$C_{\text{OUT}} \geq 2 \times P_{\text{OUT}(\max)} \times \frac{1}{V_{\text{OUT}} \times 4 \times \pi \times F_{\text{LINE}} \times V_{\text{PFCRipple}}} = 2 \times 500 \times \frac{1}{390 \times 4 \times \pi \times 47 \times 25} = 173.7 \text{ } \mu\text{F} \quad (9)$$

In this reference design, a 220- μF PFC output capacitor is used.

2.3.1.5 Current Sense Resistor

The current sense resistor detects the sum of the inductor currents through both phases. The overcurrent protection limit in UCC28064A is 200 mV. The required value of the current sense resistor is calculated for the lowest input voltage and a 25% overload condition. Estimate the peak current first by 公式 10 before calculating the current sense resistor:

$$I_{PEAKCS} = \frac{2 \times \sqrt{2} \times P_{OUT(max)} \times 1.25}{\eta \times V_{INRMS(min)}} = \frac{2 \times \sqrt{2} \times 500 \times 1.2}{0.945 \times 85} = 21 \text{ A} \quad (10)$$

This result gives the value of the current sense resistor as:

$$R_{CS} = \frac{200 \text{ mV}}{21 \text{ A}} \cong 9 \text{ m}\Omega \quad (11)$$

This design uses two 20-mΩ resistors in parallel.

2.3.1.6 PFC MOSFET

公式 12 calculates the RMS current through the PFC MOSFET.

$$I_{DS_{RMS}} = \frac{I_{PEAKCS}}{2} \times \sqrt{\frac{1}{6} - \frac{4\sqrt{2} \times V_{INRMS(min)}}{9\pi \times V_{OUTPFC}}} = \frac{21}{2} \times \sqrt{\frac{1}{6} - \frac{4\sqrt{2} \times 85}{9\pi \times 390}} = 3.7 \text{ A} \quad (12)$$

Select a MOSFET with a low figure of merit for this application. The key MOSFET specifications that are important for minimizing losses in this design are:

- Low $R_{DS(on)}$, for reducing the conduction losses in the MOSFET
- Low QG, for fast turnoff

2.3.1.7 PFC Diode

公式 13 calculates the RMS current through the boost diode.

$$I_{DS_{RMS}} = \frac{\left(\frac{I_{PEAKCS}}{2}\right) \times \sqrt{4\sqrt{2} \times V_{INRMS(min)}}}{9\pi \times V_{OUTPFC}} = 2.2 \text{ A} \quad (13)$$

2.3.1.8 Brownout Protection Configuration

The brownout voltage in UCC28064A can be set through the potential divider on the VINAC pin. In this reference design, the brownout voltage is set to 70 V with a hysteresis of 12 V. The following equations determine the value of the resistors in the potential divider network. R_A refers to the top three resistors in the potential divider (公式 14) and R_B refers to the bottom resistor in the potential divider (公式 15).

$$R_A = 12 \times \frac{1.414}{I_{BOHYS}} = \frac{17}{2 \times 10^{-6}} = 8.5 \text{ M}\Omega \quad (14)$$

Three resistors of 2.87 MΩ are connected in series to form R_A , with the bottom resistor using 公式 15.

$$R_B = \frac{1.4 \times R_A}{70\sqrt{2} - 1.414} = 123.5 \text{ k}\Omega \quad (15)$$

A standard value of 124 kΩ is chosen for R_B .

2.3.1.9 Control Loop Compensation

This design uses a type-2 compensator for the voltage loop compensation. Resistor R42 and capacitors C34 and C36 form the compensator. Start with a value of 7.5 kΩ for R42. Place a zero close to 10 Hz to give a phase boost close to the gain crossover frequency. This zero is formed by R42 and C36.

$$C36 = \frac{1}{2\pi \times 10 \times 7500} = 2.12 \text{ }\mu\text{F} \quad (16)$$

Choose a 2.2-μF capacitor for the C36 capacitor.

Place a pole at a frequency much lower than the lowest switching frequency, around 20 KHz, to attenuate the switching noise. This pole is formed by R42 and C34.

$$C34 = \frac{1}{2\pi \times 20000 \times 7500} = 1.06 \text{ nF} \quad (17)$$

2.3.1.10 Programming VOUT and HVSEN

The Vsense pin sets the output voltage regulation point. To minimize the no-load losses, use high-value resistances to construct this potential divider network. Use three 3.01-MΩ resistors to form the top resistor in the potential divider. Calculate the bottom resistor using 公式 18.

$$R_D = V_{REF} \times \frac{R_C}{V_{OUT(nom)} - V_{REF}} = \frac{6 \times 9 \times 10^6}{390 - 6} = 140.63 \text{ k}\Omega \quad (18)$$

Use a standard value of 142 kΩ for the bottom resistor on the Vsense pin.

This reference design uses the HVSEN pin to set the fail-safe output overvoltage protection (OVP). Three 3.01-MΩ resistors form the top resistor in the potential divider. Calculate the bottom resistor using 公式 19.

$$R_F = \frac{4.87 \times R_E}{V_{OUT(pk)} - 4.87} = \frac{4.87 \times 9 \times 10^6}{430 - 4.87} = 103.1 \text{ k}\Omega \quad (19)$$

A standard 103-kΩ bottom resistor has been used in the design.

2.3.2 LLC Converter Stage Design

Increased demands for high-power-density power supplies have resulted in the increase in switching frequency of the converters designed. While component sizes tend to decrease with an increase in the switching frequency, device switching losses (which are proportional to frequency) have significantly increased contributing to resulting in significant efficiency loss. Resonant converters use soft-switching techniques to alleviate switching loss problems and attain high efficiencies. Further, soft-switching helps attain low losses during light load conditions, very-low device stress, and reduced EMI.

The LLC resonant converter is based on the series resonant converter (SRC). By utilizing the transformer magnetizing inductor, zero-voltage switching can be achieved over a wide range of input voltage and load. As a result of multiple resonances, zero-voltage switching can be maintained even when the switching frequency is higher or lower than the resonant frequency.

In this design, the LLC converter operates at a high nominal switching frequency of around 100 kHz. This allows to minimize the dimension of the LLC transformer to meet the low profile requirements. The converter achieves the best efficiency when operated close to its resonant frequency at a nominal input voltage. As the switching frequency is lowered, the voltage gain is significantly increased. This allows the converter to maintain regulation when the input voltage falls low. These features make the converter ideally suited to operate from the output of a high-voltage boost PFC pre-regulator, allowing it to hold up through brief periods of AC line-voltage dropout.

With its hybrid hysteretic control and ZCS avoidance feature, the UCC256303 LLC controller enables safe operation of the LLC power stage while minimizing the dimension of the output capacitors. In addition, the controller delivers complete system protection functions including overcurrent, undervoltage lockout (UVLO), and overvoltage protection (OVP).

表 3 lists the design parameters for the LLC power stage design.

表 3. Design Parameters for LLC Power Stage Design

| SYMBOL | PARAMETER | MIN | TYP | MAX | UNIT |
|---------------------|-----------------------------|-----|-----|-----|------|
| INPUT | | | | | |
| V _{INDC} | Input voltage | 250 | 390 | 410 | V DC |
| OUTPUT | | | | | |
| V _{OUT} | Output voltage | | 24 | | V |
| P _{OUT} | Max output power | | | 500 | W |
| f _{sw_nom} | Nominal switching frequency | | 100 | | kHz |

表 3. Design Parameters for LLC Power Stage Design (continued)

| SYMBOL | PARAMETER | MIN | TYP | MAX | UNIT |
|--------|---------------------|-----|-------|-----|------|
| | Line regulation | | 1 | | % |
| | Load regulation | | 1 | | % |
| η | Targeted efficiency | | 0.965 | | |

2.3.2.1 Determine LLC Transformer Turns Ratio N

The LLC tank is designed to have a nominal gain, M_g , of 1 at the resonant frequency. Use 公式 20 to estimate the required turns ratio.

$$n = M_g \times \frac{V_{\text{DCIN(nom)}}}{V_{\text{O(nom)}} + V_F} \quad ; \quad M_g = 1$$

where

- M_g is the voltage gain
 - $V_{\text{DCIN(nom)}}$ is the nominal PFC output
 - $V_{\text{O(nom)}}$ is the output voltage
 - V_F is the voltage drop across the synchronous rectifier
- (20)

From the specifications, the nominal values for input voltage and output voltage are 390 V and 24 V, respectively. Assuming an average drop of 100 mV on the synchronous rectifier, the turns-ratio can be calculated as:

$$n = 1 \times \left(\frac{390}{24 + 0.1} \right) = 8.07$$
(21)

The transformer turns ratio is set to 8.

2.3.2.2 Determine M_{g_min} and M_{g_max}

Determine M_{g_min} and M_{g_max} using 公式 22 and 公式 23, respectively.

$$M_{g_min} = n \times \left(\frac{V_{\text{O}} + V_F}{V_{\text{DCIN(max)}}} \right) = 8.0 \times \left(\frac{24.1 \text{ V}}{\frac{410 \text{ V}}{2}} \right) = 0.94$$
(22)

$$M_{g_max} = n \times \left(\frac{V_{\text{O(nom)}} + V_F}{V_{\text{DCIN(min)}}} \right) = 8.0 \times \left(\frac{24.1 \text{ V}}{\frac{260 \text{ V}}{2}} \right) = 1.542$$
(23)

The dimensioned M_{g_max} is increased to 1.1 times the required value to have some margin = $M_{g_max} = 1.1 \times 1.542 \approx 1.697$.

2.3.2.3 Determine Equivalent Load Resistance (R_e) of Resonant Network

公式 24 calculates the equivalent load resistance at nominal and peak load under nominal output voltage and peak output voltage.

$$R_e = \frac{8 \times n^2}{\pi^2} \times \left(\frac{V_{\text{O(nom)}}}{I_{\text{O(nom)}}} \right) = \frac{8 \times 8^2}{\pi^2} \times \left(\frac{24}{20} \right) = 62.25 \quad \Omega$$
(24)

2.3.2.4 Select L_m and L_r Ratio (L_n) and Q_e

Set the resonance point for the LLC converter close to 100 kHz to minimize the dimension of the LLC transformer set. The operating point of the LLC power stage is close to this frequency during a full load condition. Choose a value of $L_r = 27 \mu\text{H}$ and $C_r = 94 \text{ nF}$ to calculate the value of the resonant frequency as follows:

$$F_r = \frac{1}{2 \times \pi \times \sqrt{L_r \times C_r}} = 99.9 \quad \text{kHz}$$
(25)

The magnetizing inductance to resonant inductance ratio is chosen as 6.6:1 to develop a sufficient Q while simultaneously minimizing the magnetizing current in the LLC transformer. A PQ 32/30 core has been used to realize the LLC transformer. The required leakage inductance is provided through an additional shim inductor built on a 20/20 PQ core.

2.3.2.5 Determine Primary-Side Currents

Use 公式 26 to calculate the primary-side RMS load current (I_{pri}) at a full load condition:

$$I_{\text{pri}} = \frac{\pi}{2\sqrt{2}} \times \frac{I_{\text{O(nom)}}}{n} = 1.11 \times \frac{20}{8.0} = 2.775 \text{ A} \quad (26)$$

As calculated in 公式 27, the RMS magnetizing current (I_m) at $f_{\text{SW_min}} = 70 \text{ kHz}$ is:

$$I_m = \frac{2\sqrt{2}}{\pi} \times \left(n \times \frac{V_{\text{O(nom)}} + V_F}{2 \times \pi \times f_{\text{SW(min)}} \times L_M} \right) = \frac{2\sqrt{2}}{\pi} \times \left(\frac{8.0 \times 24}{2 \times \pi \times 70 \text{ kHz} \times 240 \mu\text{H}} \right) = 1.64 \text{ A} \quad (27)$$

公式 28 calculates the resonant circuit current (I_r):

$$I_r = \sqrt{I_m^2 + I_{\text{pri}}^2} = \sqrt{1.64^2 + 2.775^2} = 3.22 \text{ A} \quad (28)$$

This value is also equal to the transformer primary winding current at $f_{\text{SW_min}}$.

2.3.2.6 Determine Secondary-Side Currents

The secondary-side RMS currents can be calculated from the average load current. Assuming the LLC power stage is operating close to its second resonant frequency, the RMS current through each rectifier in the secondary-side push-pull output is calculated in 公式 29:

$$I_{\text{secRMS}} = I_{\text{sec}} \times \frac{\pi}{4} = 15.71 \text{ A} \quad (29)$$

where:

- I_{sec} is the full-load, secondary-side output current (equal to 20 A)

2.3.2.7 Primary Side MOSFETs

Consider each MOSFET to have an input voltage equal to its maximum applied voltage. A MOSFET with a maximum drain source voltage greater than 500 V is feasible for this design. The turnon losses can be neglected for an LLC power stage working in ZVS. Choose the MOSFET based on the values for $R_{\text{DS(on)}}$ and COSS. Optimizing the COSS helps to minimize the dead time required for achieving ZVS, thereby minimizing the duty cycle loss. This reference design uses the STP24N60M2 MOSFET. The adaptive dead-time optimization feature of the UCC256301 helps to maximize the duty cycle, which improves the efficiency.

2.3.2.8 Secondary-Side Synchronous MOSFETs

公式 30 calculates the synchronous rectifier maximum voltage rating.

$$V_{\text{DSmaxsec}} = 1.2 \times 2 \times V_{\text{O(nom)}} = 57.6 \text{ V} \quad (30)$$

The current rating of the MOSFET is determined as $I_{\text{sec_Mrms}} = 15.7 \text{ A}$.

This reference design uses TI's CSD19505KCS MOSFET with very low $R_{\text{DS(on)}}$ ($< 3 \text{ m}\Omega$) and Q_g ($< 80 \text{ nC}$). The very low $R_{\text{DS(on)}}$ of the device helps to reduce the overall loss in the synchronous rectifier.

2.3.2.9 Soft Start—UCC256301

The UCC256301 is configured to provide a maximum 400-ms soft-start period. During start-up the soft-start capacitor charges using the internal 25- μA current source. The UCC256301 exits soft start when the closed-loop control takes over or when the voltage on the soft-start capacitor reaches 7 V. Select the value of the soft-start capacitor using 公式 31.

$$C_{\text{SS}} = C_{33} = 400 \text{ ms} \times \frac{25 \mu\text{A}}{7 \text{ V}} = 1.5 \mu\text{F} \quad (31)$$

2.3.2.10 Current Sense Circuit (ISNS Pin)—UCC256301

The overcurrent limit OCP3 is set to trigger at 1.2 times the peak overload capability of the system.

$$V_{\text{ISNSFullload}} = \frac{\text{OCP3}}{1.2} = \frac{0.6}{1.2} = 0.5 \text{ V} \quad (32)$$

The current sense ratio is then calculated as:

$$K_{\text{ISNS}} = \frac{V_{\text{ISNSFullload}}}{\frac{P_{\text{OUTmax}}}{\eta} \times \frac{1}{V_{\text{DCIN(nom)}}}} = \frac{0.5}{500 \times \frac{1}{390}} = 0.39 \text{ } \Omega \quad (33)$$

Select the current sense capacitor $C_{\text{ISNS}} = C39 = 150 \text{ pF}$. 公式 34 calculates the current sense resistor

$$R_{\text{ISNS}} \cdot R_{\text{ISNS}} = R3 = K_{\text{ISNS}} \times \frac{C_{\text{R}}}{C_{\text{ISNS}}} = 0.39 \times \frac{94 \times 10^{-9}}{150 \times 10^{-12}} = 244 \text{ } \Omega \quad (34)$$

Use a standard 240- Ω resistor for R3.

2.3.2.11 Overvoltage Protection (BW Pin)—UCC256301

The BW pin senses the output voltage through the bias winding mounted on the LLC transformer. This pin can be used to provide an additional OVP in the system. In this reference design, the bias winding has 0.67 number of turns as the secondary winding. When the OVP voltage is set to 32 V, the bias winding voltage will be 21.3 V. After implementing this setting, the BW pin potential divider is configured in such a way that it acknowledges the 4 V at the 32-V output.

$R_{\text{BWLLOWER}} = R12 = 10 \text{ k}\Omega$. Thus R_{BWUPPER} is calculated as per 公式 35:

$$R_{\text{BWUPPER}} = R9 = R12 \times \frac{21.3 \text{ V} - 4 \text{ V}}{4 \text{ V}} = 43.25 \text{ k}\Omega \quad (35)$$

3 Hardware, Software, Testing Requirements, and Test Results

3.1 Required Hardware

3.1.1 Test Conditions

Input conditions:

- VIN: 85- to 265-V AC
- IIN: Current limit to 8 A

Output Conditions:

- $V_{OUT} - 24\text{ V}$
- $I_{OUT} - 0\text{ A to } 20\text{ A}$

3.1.2 Required Equipment

A list of required equipment follows:

- Isolated AC Source
- Single phase power analyzer
- Digital Oscilloscope
- 6½ Digit Multimeter
- Resistive load
- 12-V DC Fan

3.1.3 Procedure

The testing procedure follows:

1. Turn on the 12-V DC fan and set the current to obtain approximately 200 LFM airflow on the board
2. Connect the input terminals (connector J3) of the reference board to the AC power source.
3. Solder output connections on the board, output is marked with 24V and GND, to the resistive load
4. Set a minimum load of approximately 50 mA
5. Gradually increase the input voltage from 0 V to turn on a voltage of 85-V AC. As the voltage across the PFC bulk capacitor crosses 90 V, the LLC section begins working and supplies the auxiliary power to the PFC controller. At this point, the PFC starts and boosts the PFC stage output voltage to 390-V DC.
6. Observe the start-up conditions for smooth switching waveforms.
7. Apply load and perform tests to determine the efficiency, obtain regulation data, and observe steady state operating conditions.

3.2 Testing and Results

3.2.1 Efficiency, Regulation, PF, and iTHD

This section shows the efficiency, power factor, regulation, and iTHD results at 115-V AC and 230-V AC input.



图 2. PFC Stage Efficiency



图 3. LLC Stage Efficiency

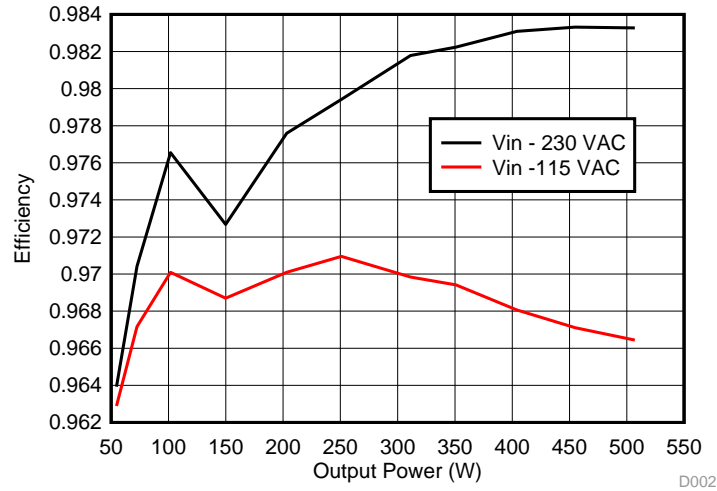

图 4. System Overall Efficiency

图 5. Load Regulation

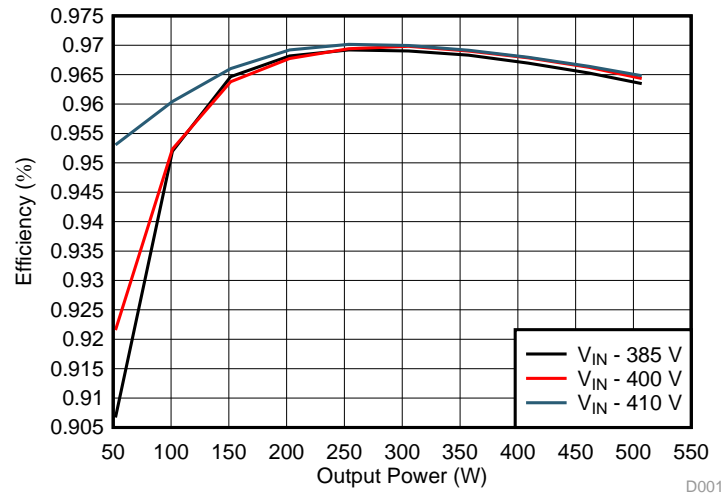

图 6. Power Factor

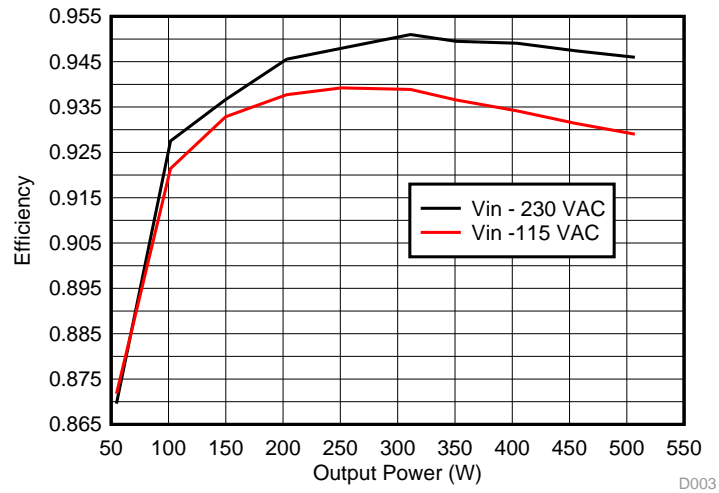

图 7. iTHD Data

3.2.2 Standby Power

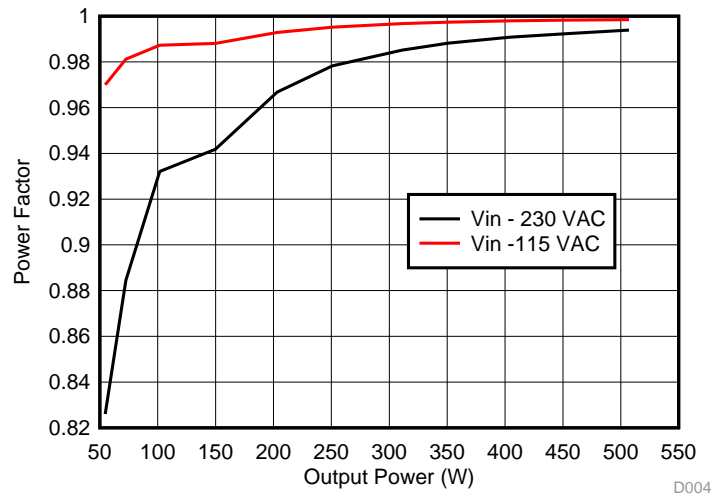
The standby power consumption at no load is shown in 表 4.

表 4. Standby Power

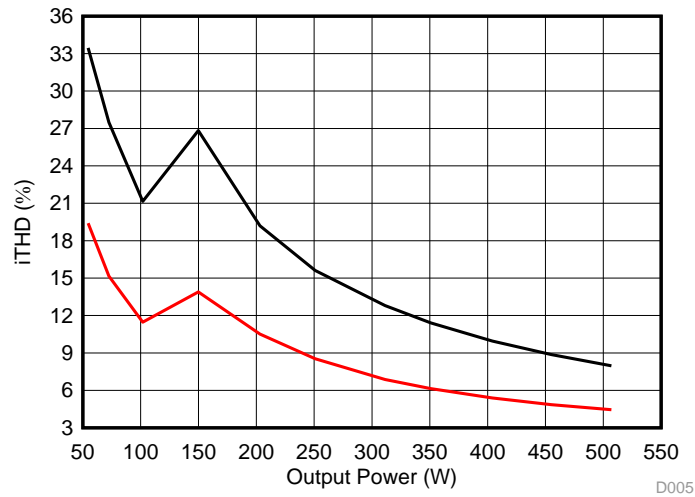
| VIN AC | Pin |
|--------|--------|
| 115 V | 170 mW |
| 230 V | 190 mW |

3.2.3 Load Transient Response

图 8 shows the transient response of the system when the 24-V output load varies from 5 A to 20 A at a slew rate of 500 mA/μs.



图 8. Transient Response at 24-V Output

3.2.4 PFC MOSFET Switching Waveforms

This section shows the PFC MOSFET turnon and turnoff switching waveforms. 图 9 shows the turn on of PFC MOSFET at 115 V, 图 10 shows the turn off of PFC MOSFET at 115 V, 图 11 shows the turn on of PFC MOSFET at 230 V and 图 12 shows the PFC MOSFET turn off switching waveform at 230 V.

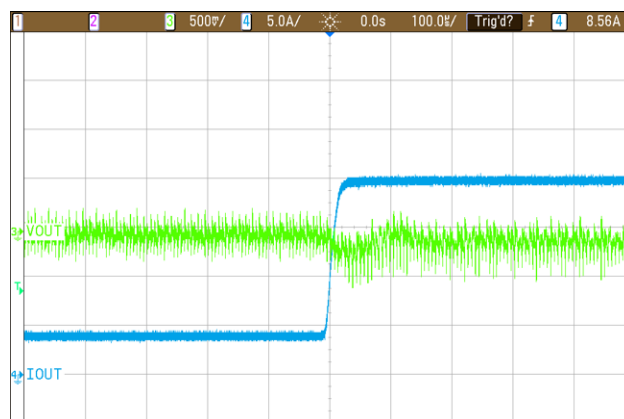

图 9. PFC MOSFET Turnon Waveform at 115 V



图 10. PFC MOSFET Turnoff Waveform at 115 V

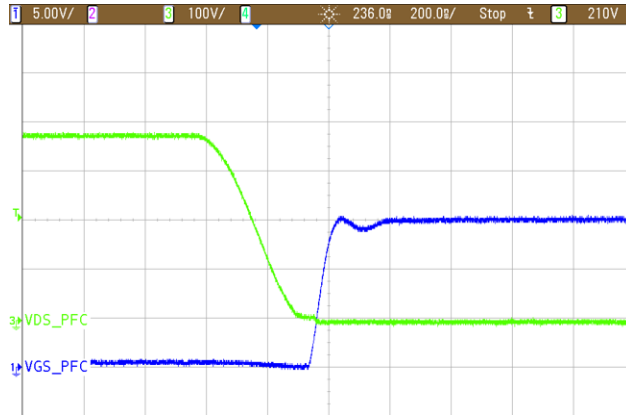

图 11. PFC MOSFET Turnon Waveform at 230 V

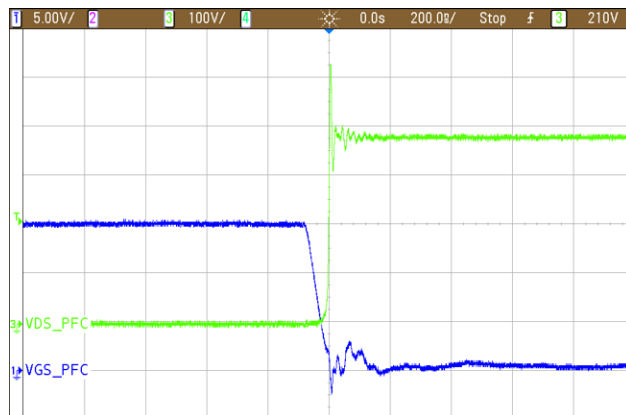

图 12. PFC MOSFET Turnoff Waveform at 230 V

3.2.5 LLC Stage Switching Waveform

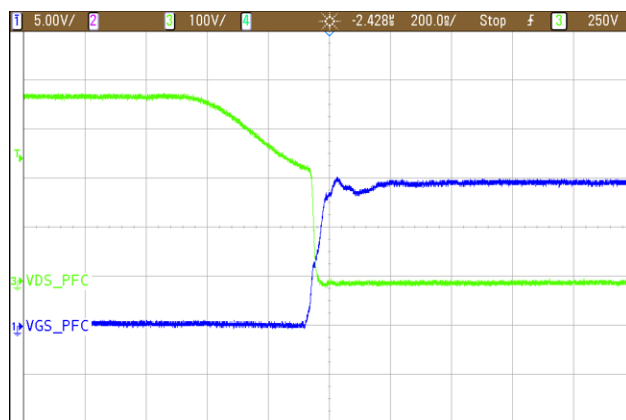
图 13 显示了 LLC 阶段初级侧的开关波形，展示了电抗电流和低端 MOSFET 的开关波形。

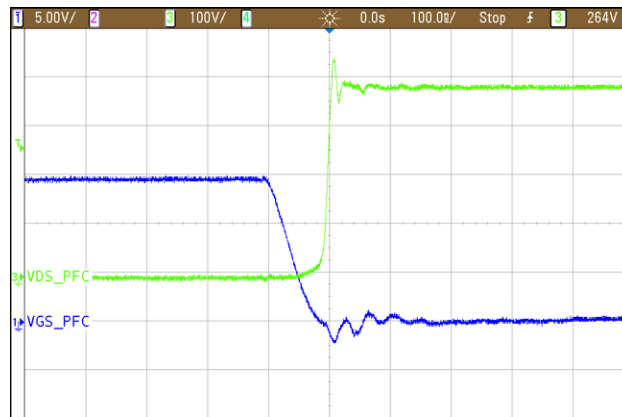

图 13. LLC 阶段初级侧电抗电流和 MOSFET 开关波形

图 14 显示了同步 MOSFET 和同步驱动输出波形。

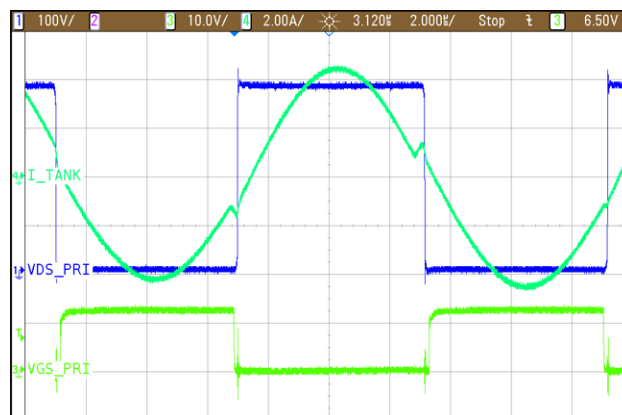

图 14. 同步 MOSFET V_{DS} 和比例门极驱动信号

3.2.6 Full-Load Thermal Image

图 15 显示了在 230 VAC 输入下，让电路板运行 20 分钟后，在 200 LFM 的风扇冷却下的全负载热成像图。

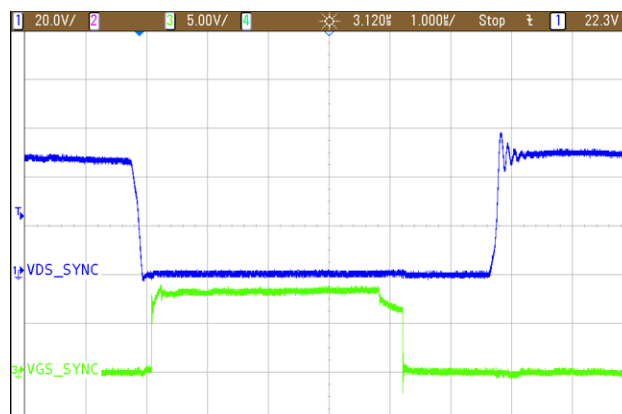

图 15. Thermal Image at Full Load, 230-VAC Input

4 Design Files

4.1 Schematics

To download the schematics, see the design files at [TIDA-010015](#).

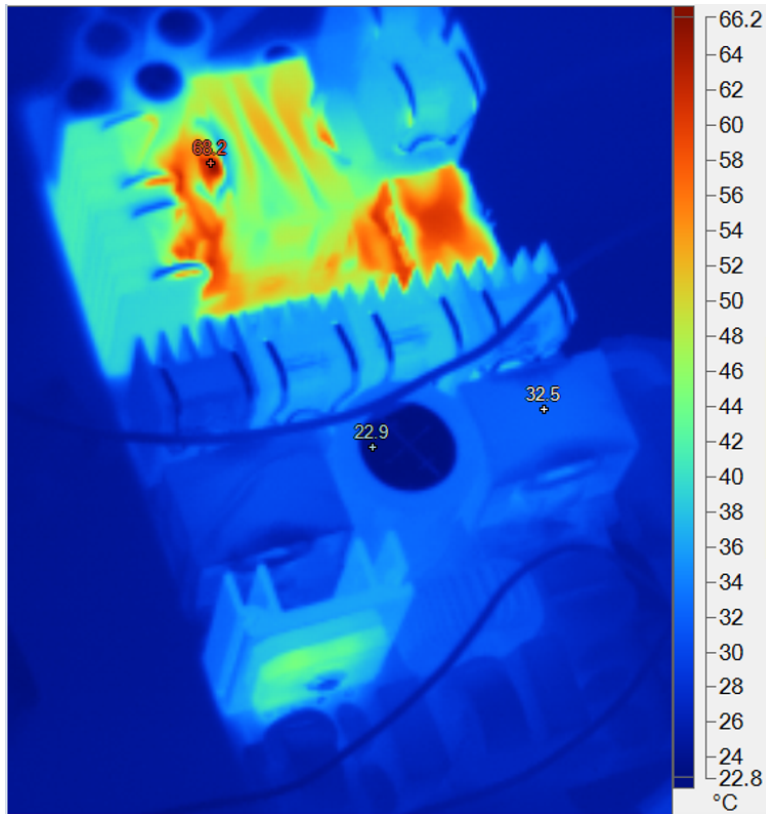
4.2 Bill of Materials

To download the bill of materials (BOM), see the design files at [TIDA-010015](#).

4.3 PCB Layout Recommendations

4.3.1 Layout Prints

To download the layer plots, see the design files at [TIDA-010015](#).

4.4 Altium Project

To download the Altium Designer® project files, see the design files at [TIDA-010015](#).

4.5 Gerber Files

To download the Gerber files, see the design files at [TIDA-010015](#).

4.6 Assembly Drawings

To download the assembly drawings, see the design files at [TIDA-010015](#).

5 Software Files

To download the software files, see the design files at [TIDA-010015](#).

6 Related Documentation

1. Texas Instruments, [UCC28064A Natural Interleaving™ Transition-Mode PFC Controller with High Light-Load Efficiency Data Sheet](#)
2. Texas Instruments, [UCC256301 Hybrid Hysteretic Mode Wide \$V_{IN}\$ LLC Resonant Controller Enabling Ultra-Low Standby Power Data Sheet](#)
3. Texas Instruments, [UCC24612 High Frequency Synchronous Rectifier Controller Data Sheet](#)

6.1 商标

E2E is a trademark of Texas Instruments.

Altium Designer is a registered trademark of Altium LLC or its affiliated companies.

All other trademarks are the property of their respective owners.

7 About the Author

SALIL CHELLAPPAN is System Manager, Member, and Group Technical Staff at Texas Instruments, where he is responsible for developing customized power solutions as part of the power delivery, industrial segment. Salil brings to this role his extensive experience in power electronics, power conversion, EMI/EMC, power and signal integrity, and analog circuits design spanning many high-profile organizations. Salil holds a bachelor of technology degree from the University of Kerala.

RAMKUMAR S is a systems engineer at Texas Instruments, where he is responsible for developing reference design solutions for the industrial segment. Ramkumar brings his diverse experience in analog and digital power supplies design to this role. Ramkumar earned his master of technology (M.Tech) from the Indian Institute of Technology in Delhi.

NEHA NAIN is a systems engineer at Texas Instruments, where she is responsible for developing reference design solutions for the power delivery, industrial segment. Neha earned her bachelor in electrical and electronics engineering from the PES Institute of Technology (now PES University), Bangalore.

修订历史记录

注：之前版本的页码可能与当前版本有所不同。

| Changes from Original (October 2018) to A Revision | Page |
|--|-------------|
| • 已更改 应用 链接 | 1 |
| • 已更改 400 mW to 200 mW | 2 |
| • 已更改 nominal value of no load power from 400 mW to 200 mW in <i>Key System Specifications</i> table | 3 |
| • 已更改 pin values in <i>Standby Power</i> table | 18 |

重要声明和免责声明

TI“按原样”提供技术和可靠性数据（包括数据表）、设计资源（包括参考设计）、应用或其他设计建议、网络工具、安全信息和其他资源，不保证没有瑕疵且不做任何明示或暗示的担保，包括但不限于对适销性、某特定用途方面的适用性或不侵犯任何第三方知识产权的暗示担保。

这些资源可供使用 TI 产品进行设计的熟练开发人员使用。您将自行承担以下全部责任：(1) 针对您的应用选择合适的 TI 产品，(2) 设计、验证并测试您的应用，(3) 确保您的应用满足相应标准以及任何其他功能安全、信息安全、监管或其他要求。

这些资源如有变更，恕不另行通知。TI 授权您仅可将这些资源用于研发本资源所述的 TI 产品的应用。严禁对这些资源进行其他复制或展示。您无权使用任何其他 TI 知识产权或任何第三方知识产权。您应全额赔偿因在这些资源的使用中对 TI 及其代表造成的任何索赔、损害、成本、损失和债务，TI 对此概不负责。

TI 提供的产品受 [TI 的销售条款](#) 或 [ti.com](#) 上其他适用条款/TI 产品随附的其他适用条款的约束。TI 提供这些资源并不会扩展或以其他方式更改 TI 针对 TI 产品发布的适用的担保或担保免责声明。

TI 反对并拒绝您可能提出的任何其他或不同的条款。

邮寄地址：Texas Instruments, Post Office Box 655303, Dallas, Texas 75265

Copyright © 2022，德州仪器 (TI) 公司