

设计指南: TIDA-070001

具有适用于 OCP 的冗余电子保险丝输入的 3V 至 7V_{IN} 航空级负载点 (POL) 参考设计



说明

航天器应用经常采用冗余设计以增强可靠性, 此参考设计展示了如何通过使用两个 TPS7H2201-SP 耐辐射电子保险丝负载开关在负载点 (POL) 电源的输入处实施冗余。使用两个负载开关可实现向耐辐射 POL 降压转换器 TPS50601A-SP 提供初级电压和冗余电压, 负载开关提供可调节过流保护 (OCP) 限制以进行保护, 同时电流检测输出引脚可实现监控和保护功能, 另外, 负载开关还具有可调节过压保护 (OVP) 功能。POL 转换器还具有电流限制, 可提供额外短路保护功能。

资源

TIDA-070001

设计文件

TPS7H2201-SP

产品文件夹

TPS50601A-SP

产品文件夹

特性

- 可调节过流保护 (OCP) 限制
- 可调节过压 (OVP) 限制
- 冗余输入
- 可配置软启动
- 启用/禁用功能

应用

- 命令和数据处理
- 卫星电力系统 (EPS)
- 光学成像有效载荷
- 雷达成像有效载荷
- 通信有效载荷



咨询我们的 E2E™ 专家

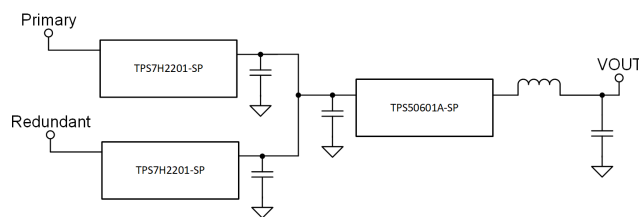
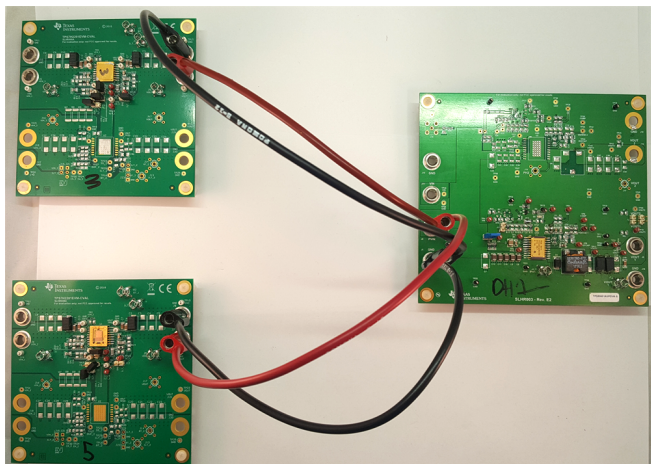

该 TI 参考设计末尾的重要声明表述了授权使用、知识产权问题和其他重要的免责声明和信息。

1 System Description

The design consists of two TPS7H2201-SP load switches supplying input power for a TPS50601A-SP point of load converter in a redundancy configuration. The redundancy of the input voltage to the point of load converter is critical in keeping important power lines to high priority parts of a satellite such as an FPGA or microcontroller functioning.

1.1 Key System Specifications

表 1. Key System Specifications

PARAMETER	OPERATING SPECIFICATIONS	MAXIMUM SPECIFICATIONS	DETAILS
Input power supply	0 to 5 VDC	0 to 7 VDC	节 3.1.1
Input current requirement	0 to 3.5 A	0 to 7.5 A (set by load switch current limit)	节 3.1.1
Output voltage of POL converter	2.5 VDC	2.5 VDC	节 3.1.1
Output current of POL converter	0 to 6 A	0 to 13 A (set by POL current limit)	节 3.1.1
Operating temperature	25°C	-55°C to 125°C	节 3.1.1

2 System Overview

2.1 Block Diagram



图 1. TIDA-070001 Block Diagram

2.2 Design Considerations

When using the TPS7H2201-SP as a current limiting load switch, the current limit must be calculated based on the duty cycle and efficiency of the TPS50601A-SP. Since the load switch is limiting the input and not the output current for the load switch, the input current will heavily depend on the duty cycle and efficiency of the converter. The output voltage of the TPS7H2201-SP will degrade slowly after the TPS50601A-SP turns off. The TPS50601A-SP has a minimum input voltage of 3 V. When the output voltage of the TPS7H2201-SP is below 3 V and disabled, the TPS50601A-SP will stop lowering the voltage and the charge stored on those capacitors will very slowly decrease. Enabling the TPS7H2201-SP during this time may result in the TPS50601A-SP turning on faster than anticipated.

2.3 Highlighted Products

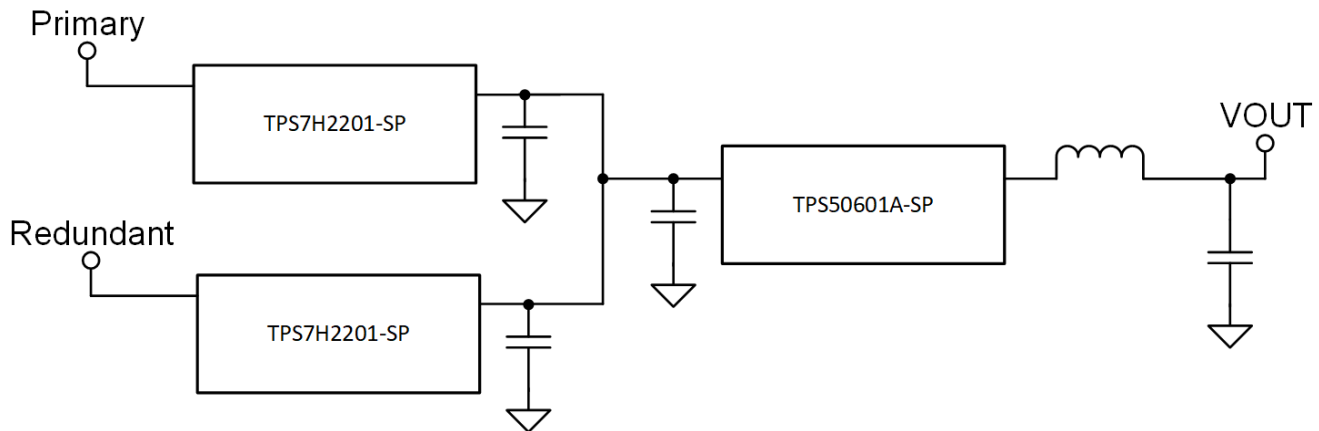
2.3.1 TPS7H2201-SP

- Radiation Performance:
 - Radiation Hardness Assurance (RHA) up to TID 100 krad(Si)
 - Single Event Latch-up (SEL), Single Event Burnout (SEB), and Single Event Gate Rupture (SEGR) Immune to LET = 75 MeV-cm²/mg
 - SEFI Immune to LET = 65 MeV-cm²/mg
 - SET Characterized to LET = 65 MeV-cm²/mg
- Integrated Single Channel Load Switch
- Input Voltage Range: 1.5 V to 7 V
- Low On-Resistance (R_{ON}) of 34-m Ω Maximum at 25°C and $V_{IN} = 5 V$
- 6-A Maximum Continuous Switch Current
- Low Control Input Threshold Enables Use of 1.2-V, 1.8-V, 2.5-V, and 3.3-V Logic
- Configurable Rise Time (Soft Start)
- Reverse Current Protection (TPS7H2201-SP)

- Programmable and Internal Current Limiting (FastTrip)
- Programmable Fault Timer (Current Limit and Retry Modes)
- Thermal Shutdown
- Ceramic Package With Thermal Pad

2.3.2 TPS50601A-SP

- Radiation Performance:
 - Radiation Hardened up to TID 100 krad(Si)
 - ELDRS Free 100 krad(Si) to 10 mrad(Si)/s
 - Single Event Latch-up (SEL) Immune to LET = 75 MeV-cm²/mg
 - SEB and SEGR Immune to 75 MeV-cm²/mg, SOA Curve Available
 - SET/SEFI Cross-Section Plot Available
- Peak Efficiency: 96.6% (VO = 3.3 V)
- Integrated 58-mΩ/50-mΩ MOSFETs
- Power Rail: 3 V to 7 V on VIN
- 6-A Maximum Output Current
- Flexible Switching Frequency Options:
 - 100-kHz to 1-MHz Adjustable Internal Oscillator
 - External Sync Capability: 100 kHz to 1 MHz
 - Sync Pin Can Be Configured as a 500-kHz Output for Master/Slave Applications
- 0.804-V ±1.5% Voltage Reference Overtemperature, Radiation, and Line and Load Regulation
- Monotonic Start-Up Into Prebiased Outputs
- Adjustable Soft Start Through External Capacitor
- Input Enable and Power-Good Output for Power Sequencing
- Power-Good Output Monitor for Undervoltage and Overvoltage
- Adjustable Input Undervoltage Lockout (UVLO)
- 20-Pin Ultra-Small, Thermally-Enhanced Ceramic Flatpack Package (HKH) for Space Applications

2.4 System Design Theory

The TPS7H2201-SP is a smart power load switch that allows multiple input voltages to supply the same TPS50601A-SP allowing for redundancy in input power supplies. The redundancy allows for a high reliability power supply for critical power rails. The TPS7H2201-SP also allows for current sensing of the input voltage of the TPS50601A-SP for monitoring the health of the power supply.

3 Hardware, Software, Testing Requirements, and Test Results

3.1 Required Hardware and Software

3.1.1 Hardware

Two power supplies are needed to provide voltage to the TPS7H2201-SP, up to 7 V, which is the maximum voltage for the load switch. The power supplies in the following test setup need to supply up to 7.5 A of current set by the IL resistor of the individual load switches. The output load needs to be able to sink up to 13 A from the TPS50601A-SP when the device output is shorted. The TPS50601A-SP was set to an output of 2.5-V nominal. The surrounding temperature will be determined by the thermal maximum of the TPS50601A-SP and the TPS7H2201-SP, which have a temperature range of -55°C to 125°C .

3.2 Testing and Results

3.2.1 Test Setup

Tests were done with the following configuration, unless otherwise specified.



图 2. Test Setup

The tests were done with the following inputs/outputs, unless otherwise specified.

表 2. Key System Specifications

PARAMETER	SPECIFICATIONS
Input power supply	5 VDC
Output voltage	2.5 VDC
Output current	6 A
Operating temperature	25°C
LSW EN threshold	4.85 V
LSW OVP threshold	6 V
LSW current limit, IL	7.5 A
LSW current limit timer, ILTIMER	1 ms
LSW retry timer, RTIMER	1 ms
LSW soft start	9 ms
LSW maximum CS pin voltage	4.6 V
POL soft start	4 ms
POL UVLO threshold	2.75 V

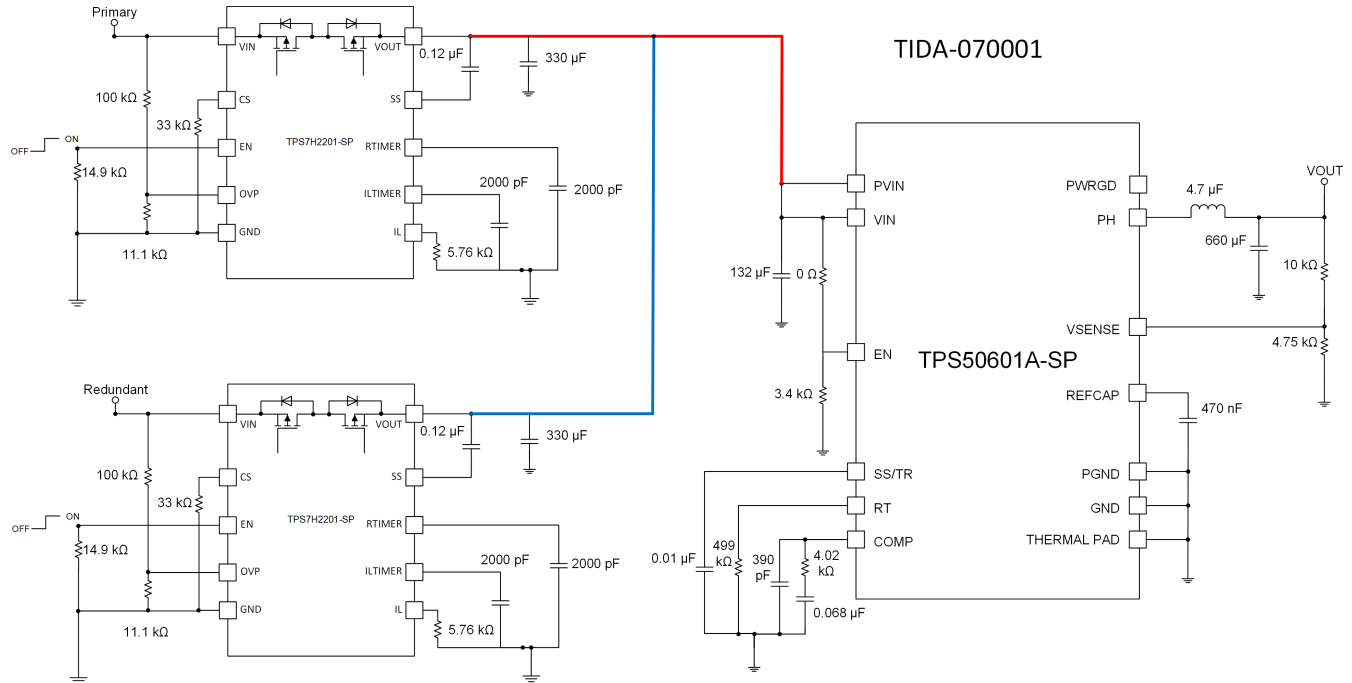
3.2.2 Test Results

3.2.2.1 Leakage Current

Current flowing through disabled load switch was measured at no load and full load.

表 3. Test Data

TEST DONE	RESULT
Leakage current of disabled load switch with no load on POL converter	1.6 μ A
Leakage current of disabled load switch with 6-A load on POL converter	0.75 μ A
Operating temperature	25°C

3.2.2.2 Start-up



图 3. Start-up Waveform Full Load With Phase Node

表 4. Waveforms for 图 3

Waveform Number	Signal	Values
1	Input Voltage to Load Switch	0 to 5 V
2	Output Voltage of Load Switch	0 to 5 V
3	Phase Node of POL Converter	0 to 5 V @ 100-kHz Switching Frequency
4	Output Voltage of POL Converter	0 to 2.5 V

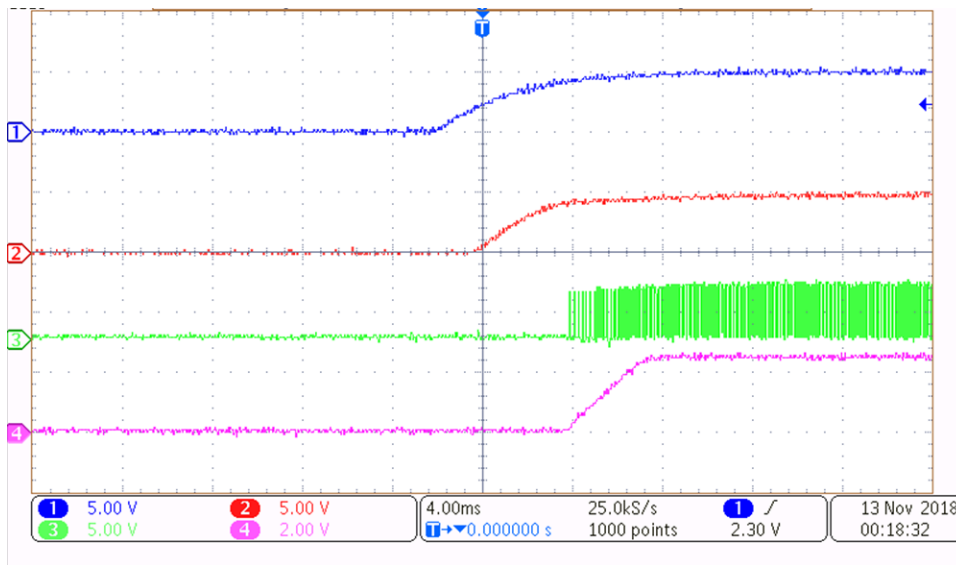

图 4. Start-up Waveform Full Load With Output Current

For the tests in 图 3 and 图 4, the input power to the load switch was ramped up with the load switch and the POL converter enabled. 6 A of current was drawn from the output of the POL converter.

表 5. Waveforms for 图 4

Waveform Number	Signal	Values
1	Input Voltage to Load Switch	0 to 5 V
2	Output Voltage of Load Switch	0 to 5 V
3	Output Current of POL Converter	0 to 6 A
4	Output Voltage of POL Converter	0 to 2.5 V

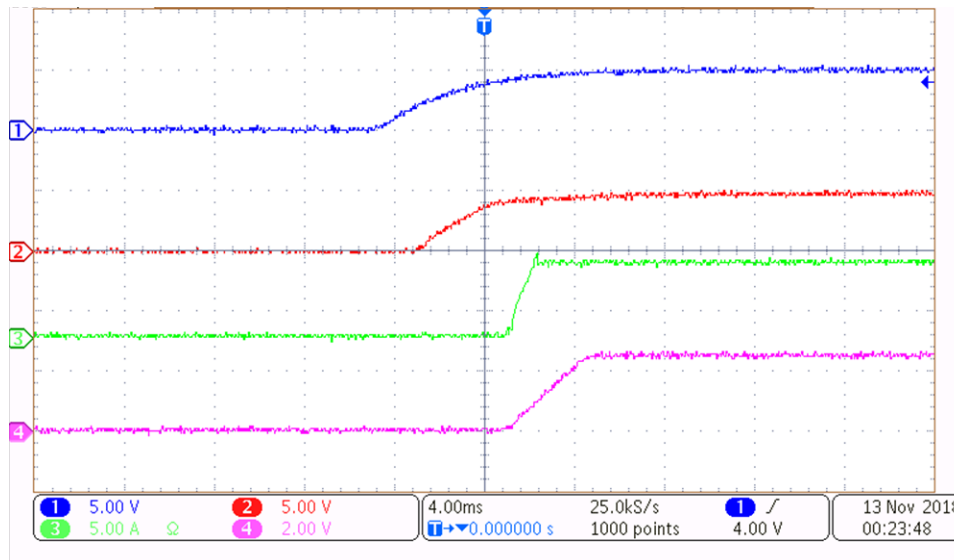

图 6. Start-up Waveform No Load With Output Current Node

For the tests in 图 5 and 图 6, the input power to the load switch was ramped up with the load switch and the POL converter enabled. 0 A of current was drawn from the output of the POL converter.

表 7. Waveforms for 图 6

Waveform Number	Signal	Values
1	Input Voltage to Load Switch	0 to 5 V
2	Output Voltage of Load Switch	0 to 5 V
3	Output Current of POL Converter	0 A
4	Output Voltage of POL Converter	0 to 2.5 V

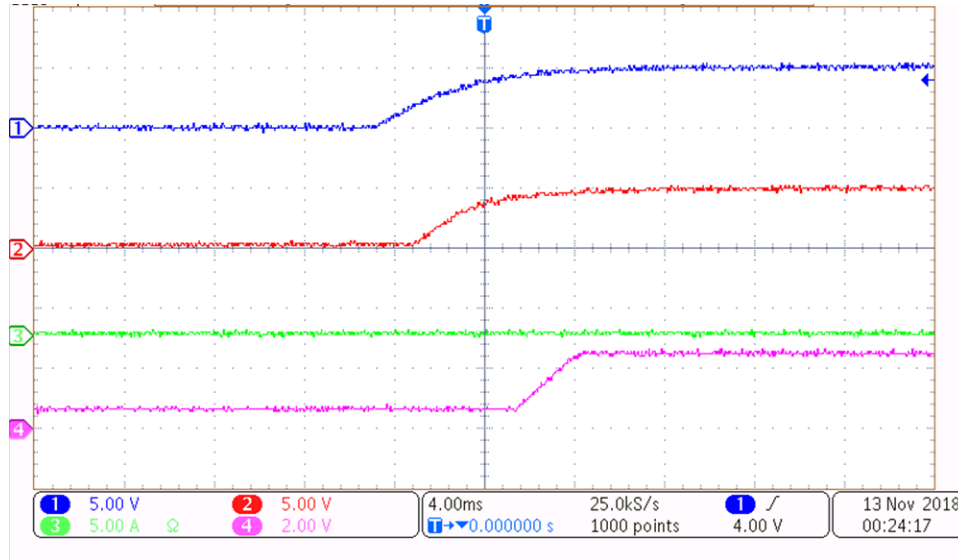
3.2.2.3 Shutdown



图 7. Shutdown Waveform Full Load With Phase Node

表 8. Waveforms for 图 7

Waveform Number	Signal	Values
1	Input Voltage to Load Switch	5 to 2.5 V
2	Phase Node of POL Converter	0 to 5 V @ 100-kHz Switching Frequency
3	Output Voltage of POL Converter	2.5 to 0 V
4	Output Voltage of Load Switch	5 to 2.5 V

图 8. Shutdown Waveform Full Load With Output Current

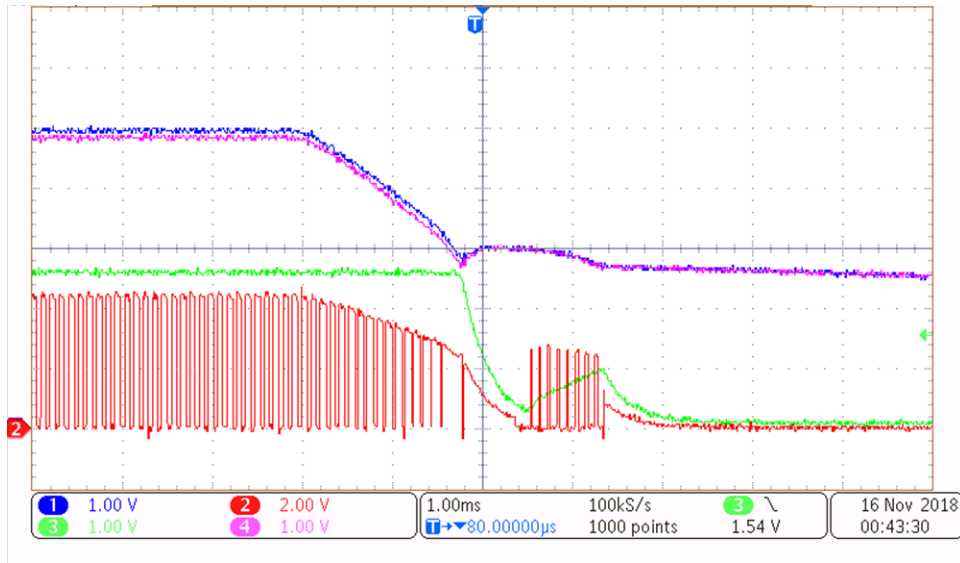
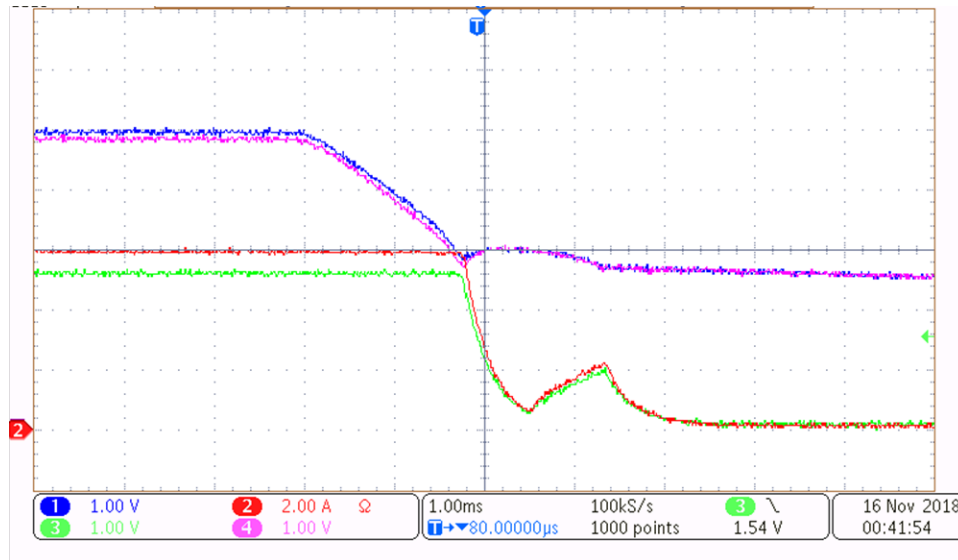
For the test in 图 7 和 图 8, the input power to the load switch was ramped down. 6 A of current was drawn from the output of the POL converter using a resistive load. The input voltage of the POL converter dips below the UVLO and the device starts to turn off. The input voltage of the POL converter then starts to increase because of the large dip in output current. This increase causes the POL to switch a few times and discharge capacitors on the input of the POL converter.

表 9. Waveforms for 图 8

Waveform Number	Signal	Values
1	Input Voltage to Load Switch	5 to 2.5 V
2	Output Current of POL Converter	6 to 0 A
3	Output Voltage of POL Converter	2.5 to 0 V
4	Output Voltage of Load Switch	5 to 2.5 V



图 9. Shutdown Waveform No Load With Phase Node

表 10. Waveforms for 图 9

Waveform Number	Signal	Values
1	Input Voltage to Load Switch	5 to 0 V
2	Output Voltage of Load Switch	5 to 0 V
3	Phase Node of POL Converter	5 to 0 V @ 100-kHz Switching Frequency
4	Output Voltage of POL Converter	2.5 to 0 V

图 10. Shutdown Waveform No Load With Output Current

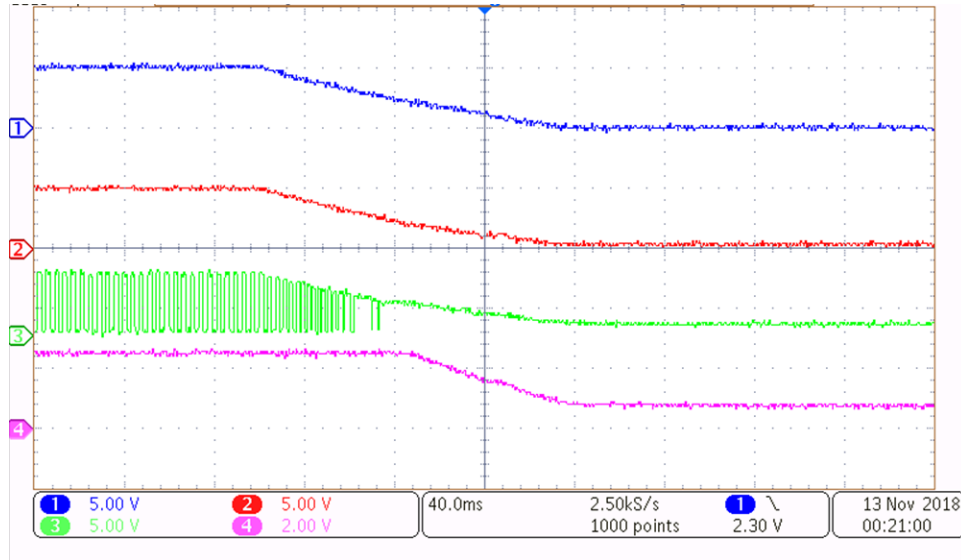
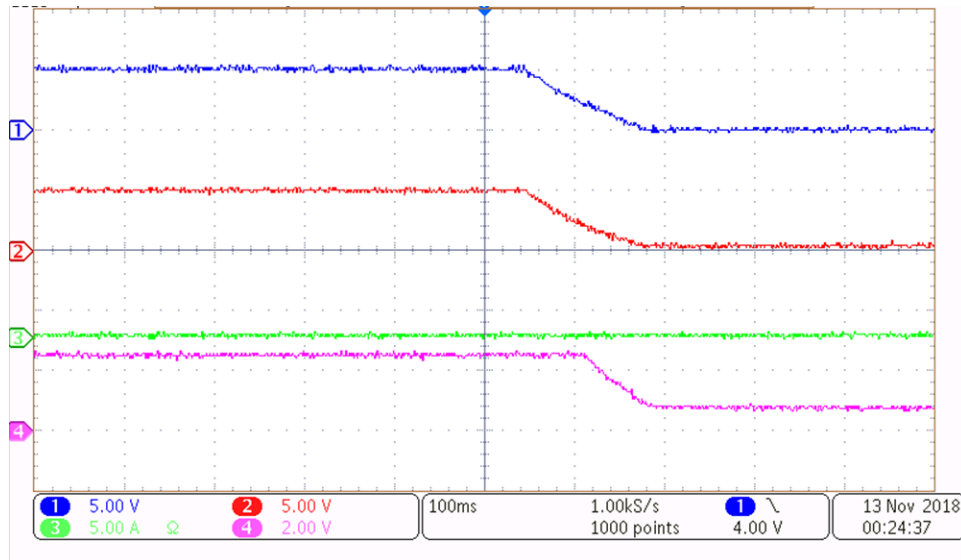
For the tests in 图 9 and 图 10, the input power to the load switch was ramped down. 0 A of current was drawn from the output of the POL converter.

表 11. Waveforms for图 10

Waveform Number	Signal	Values
1	Input Voltage to Load Switch	5 to 0 V
2	Output Voltage of Load Switch	5 to 0 V
3	Output Current of POL Converter	0 A
4	Output Voltage of POL Converter	2.5 to 0 V

3.2.2.4 Load Step



图 11. Negative Load Step With Phase Node

表 12. Waveforms for 图 11

Waveform Number	Signal	Values
1	Phase Node of POL Converter	0 to 5 V @ 100-kHz Switching Frequency
2	CS Pin Voltage	2.36 to 0 V
3	Output Current of POL Converter	6 to 0 A
4	Output Voltage of Load Switch	4.8 to 5.2 V

图 12. Negative Load Step With Input Voltage

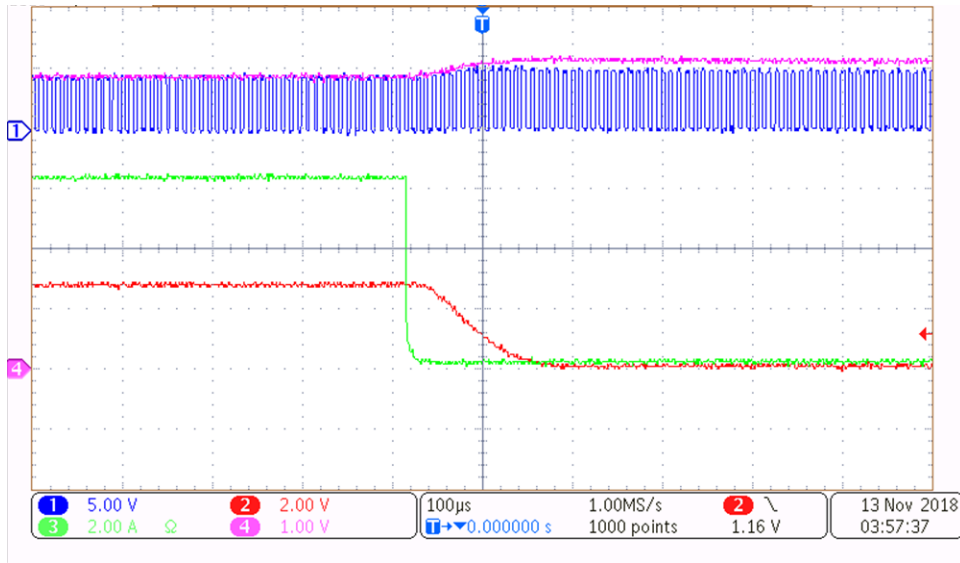
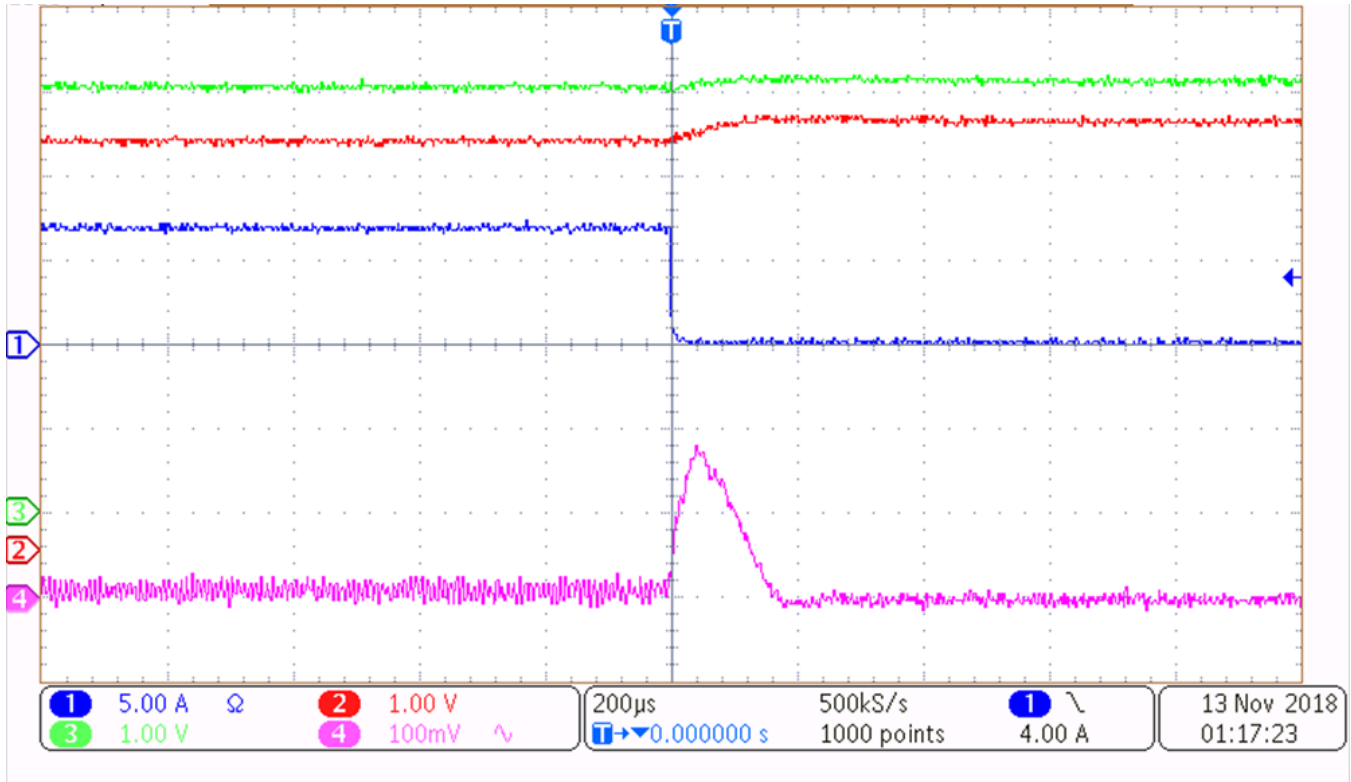
For the tests in 图 11 and 图 12, the output current of the POL converter was stepped from 6 A to 0 A.

表 13. Waveforms for 图 12

Waveform Number	Signal	Values
1	Output Current of POL Converter	6 to 0 A
2	Output Voltage of Load Switch	4.8 to 5.2 V
3	Input Voltage of Load Switch	5 to 5.2 A
4	Output Voltage of POL Converter	170-mV Increase



图 13. Positive Load Step With Phase Node

表 14. Waveforms for 图 13

Waveform Number	Signal	Values
1	Phase Node of POL Converter	0 to 5 V @ 100-kHz Switching Frequency
2	Current Sense Pin of Load Switch	0 to 2.36 V
3	Output Current of POL Converter	0 to 6 A
4	Output Voltage of Load Switch	5.2 to 4.8 V

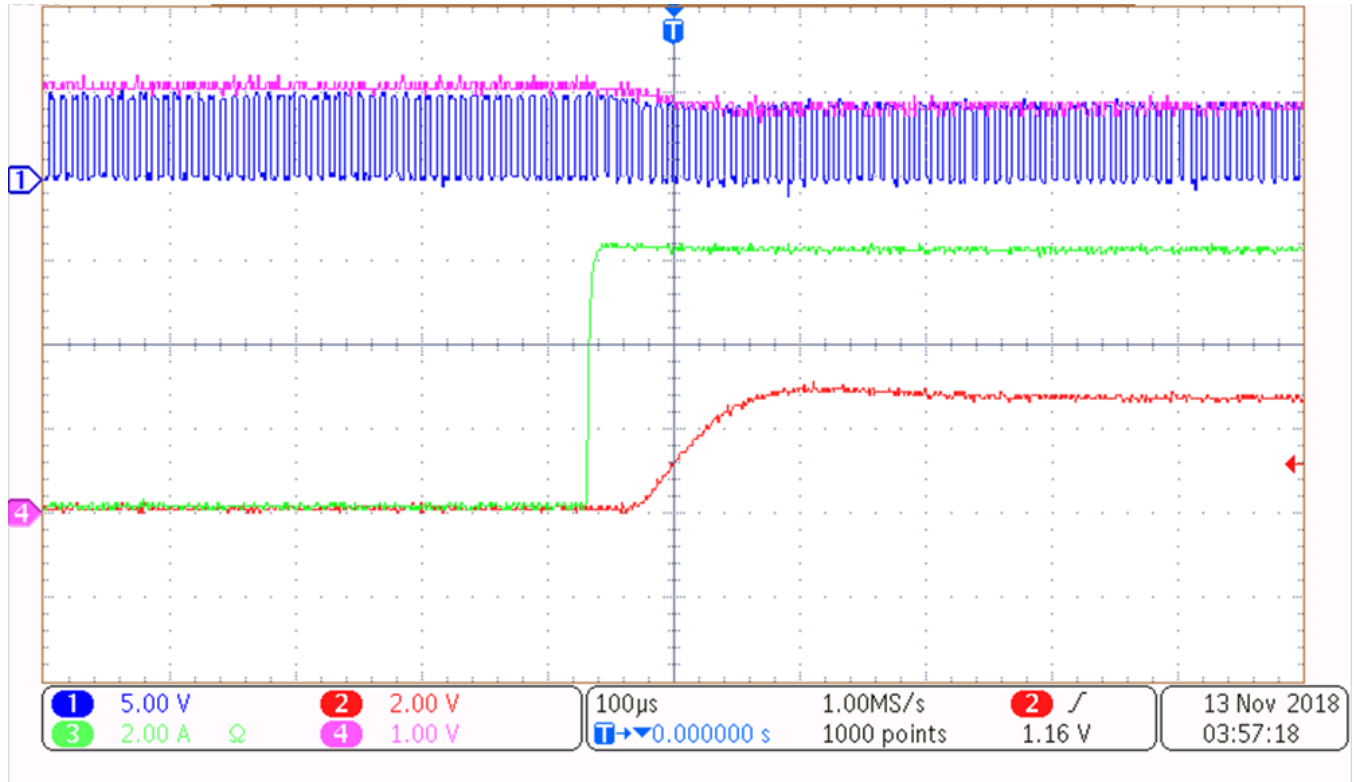

图 14. Positive Load Step With Input Voltage

For the tests in 图 13 and 图 14, the output current of the POL converter was stepped from 0 A to 6 A.

表 15. Waveforms for 图 14

Waveform Number	Signal	Values
1	Input Voltage of Load Switch	0 to 6 A
2	Output Voltage of Load Switch	5.2 to 4.8 V
3	Output Current of POL Converter	5.2 to 5 A
4	Output Voltage of POL Converter	180-mV Increase

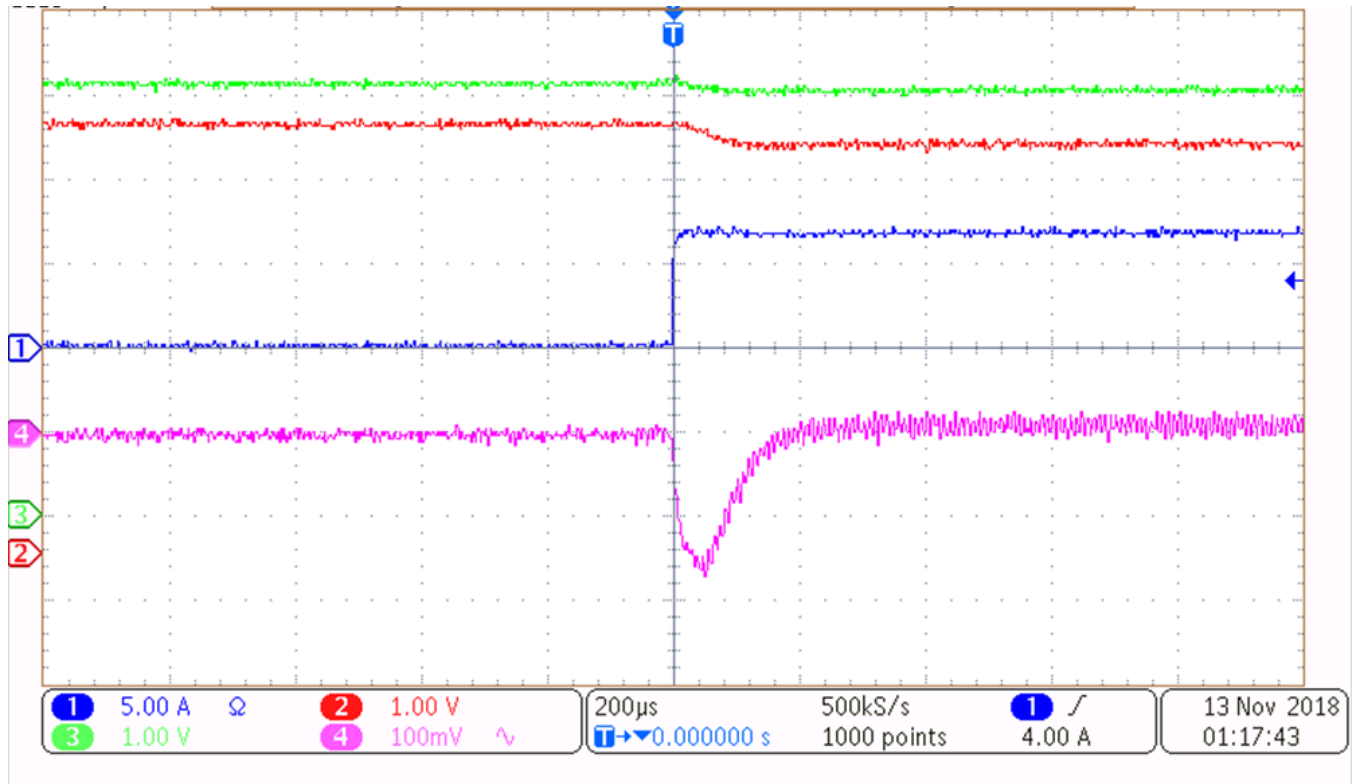
3.2.2.5 Point of Load Converter Enable Toggle



图 15. POL Enable Toggle High With Phase Node

表 16. Waveforms for 图 15

Waveform Number	Signal	Value
1	Output Current of POL Converter	0 to 6 A
2	Phase Node of POL Converter	4.8 V to 5 V
3	Enable Pin of POL Converter	5 to 0 V
4	Output Voltage of POL Converter	2.5 to 0 V

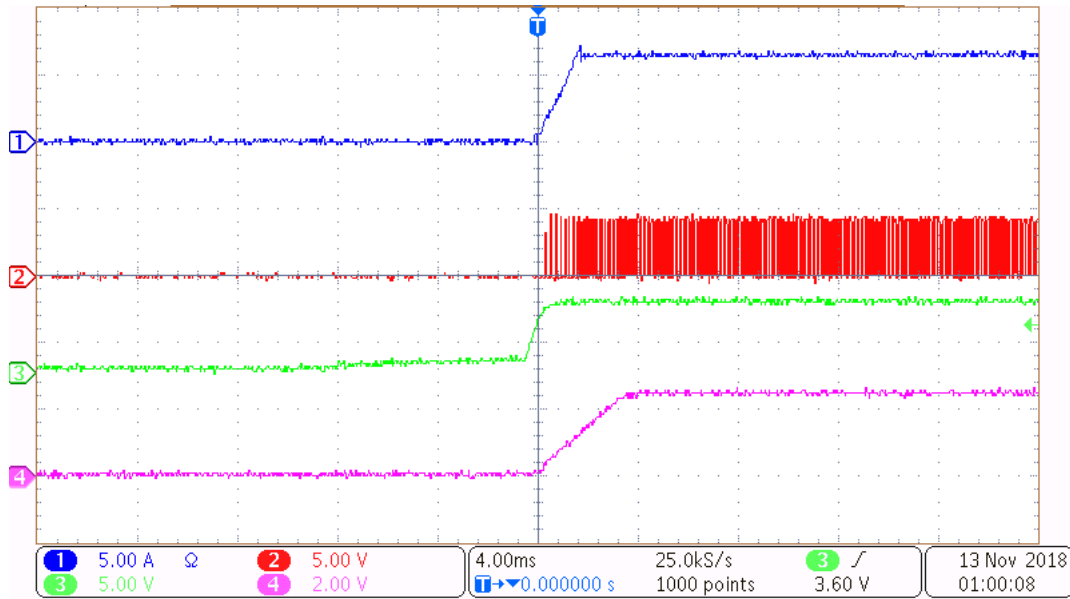

图 16. POL Enable Toggle High With Input Voltage

For tests in 图 15 and 图 16, the enable of the POL converter was brought high with the load switch already enabled.

表 17. Waveforms for 图 16

Waveform Number	Signal	Value
1	Input Voltage of Load Switch	5 V
2	Output Voltage of Load Switch	5 to 4.8 V
3	Enable Pin of POL Converter	0 to 5 V
4	Output Voltage of POL Converter	0 to 2.5 V

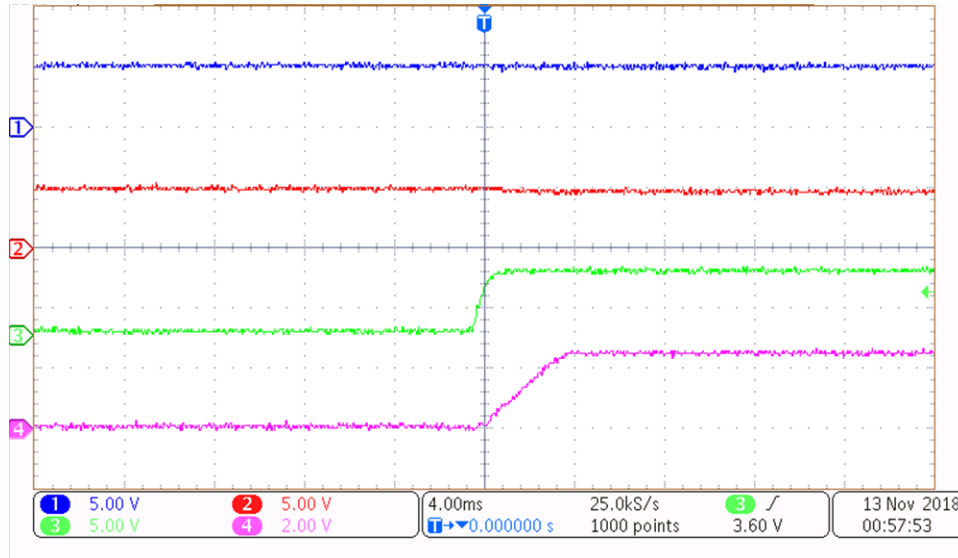

图 17. POL Enable Toggle Low With Phase Node

表 18. Waveforms for 图 17

Waveform Number	Signal	Value
1	Output Current of POL Converter	6 to 0 A
2	Phase Node of POL Converter	5 to 4.8 V
3	Enable Pin of POL Converter	0 to 5 V
4	Output Voltage of POL Converter	0 to 2.5 V

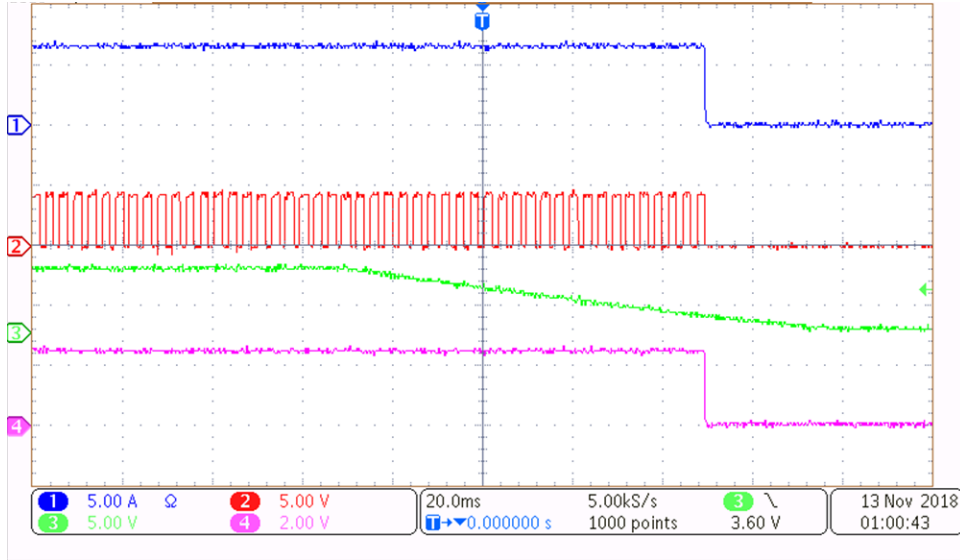

图 18. POL Enable Toggle Low With Input Voltage

For the tests in 图 17 and 图 18, the enable of the POL converter was brought low with the load switch enabled.

表 19. Waveforms for 图 18

Waveform Number	Signal	Value
1	Input Voltage of Load Switch	5 V
2	Output Voltage of POL Converter	4.8 to 5 V
3	Enable Pin of POL Converter	5 to 0 V
4	Output Voltage of POL Converter	2.5 to 0 V

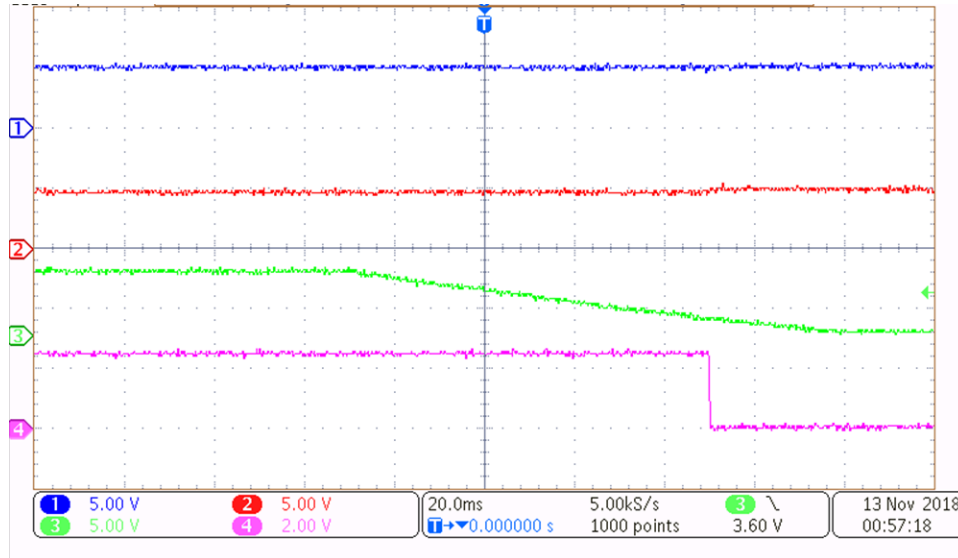

图 19. Load Switch Current Limit With Phase Node

表 20. Waveforms for 图 19

Waveform Number	Signal	Value
1	Input Voltage of Load Switch	5 and 5.2 V
2	Phase Node of POL Converter	0 to 4 V @ 100-kHz Switching Frequency
3	Output Voltage of POL Converter	0 to 2.5 V
4	Output Voltage of Load Switch	0.85 to 4 V

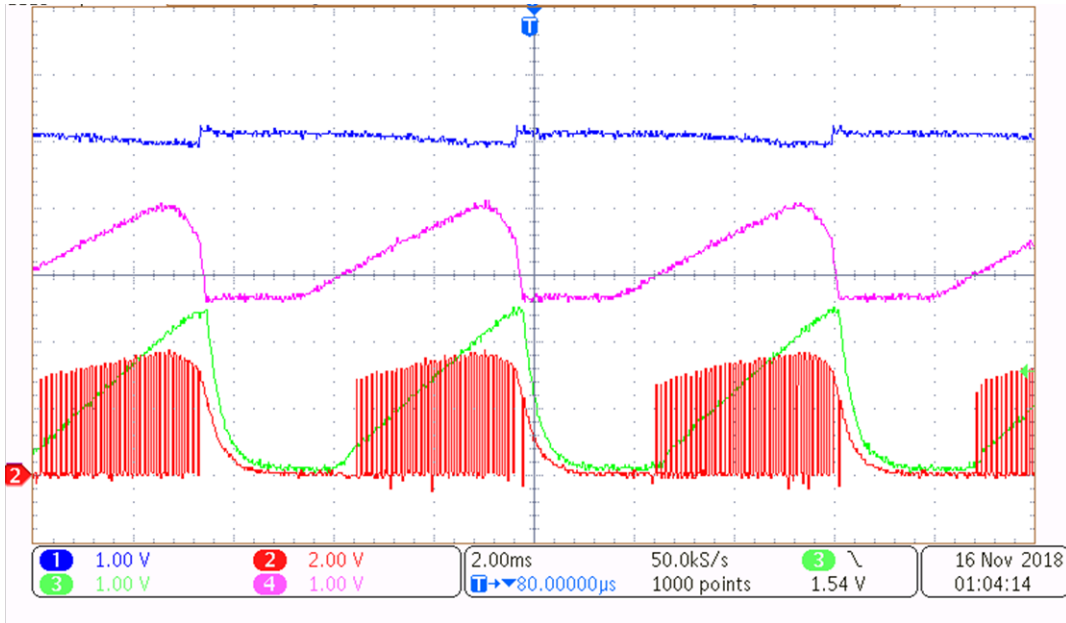

图 20. Load Switch Current Limit With Timer Pins

表 21. Waveforms for 图 20

Waveform Number	Signal	Value
1	Input Voltage of Load Switch	5 and 5.2 V
2	RLTimer Pin of Load Switch	0.5 V
3	ILTimer Pin of Load Switch	0 to 0.6 V
4	Output Voltage of Load Switch	0.85 to 4 V

For the tests in 图 19 and 图 20, the load switch current limit was set to 3 A by changing the IL resistor to 15.4 kΩ and the output current of the POL Converter was kept at 6 A. This behavior shown is the result of the load switch stopping current flow. Since the current flow is stopping the output voltage of the load switch will drop until it hits the undervoltage lockout of the POL converter. Once the undervoltage lockout of the POL converter is reached the POL converter will turn off stopping the short. Since the short on the output has stopped, the load switch will let current through again and increase the load switch output voltage. The output voltage of the load switch increases and turns on the POL converter. This process will repeat until either the short on the output goes away or one of the devices is disabled.

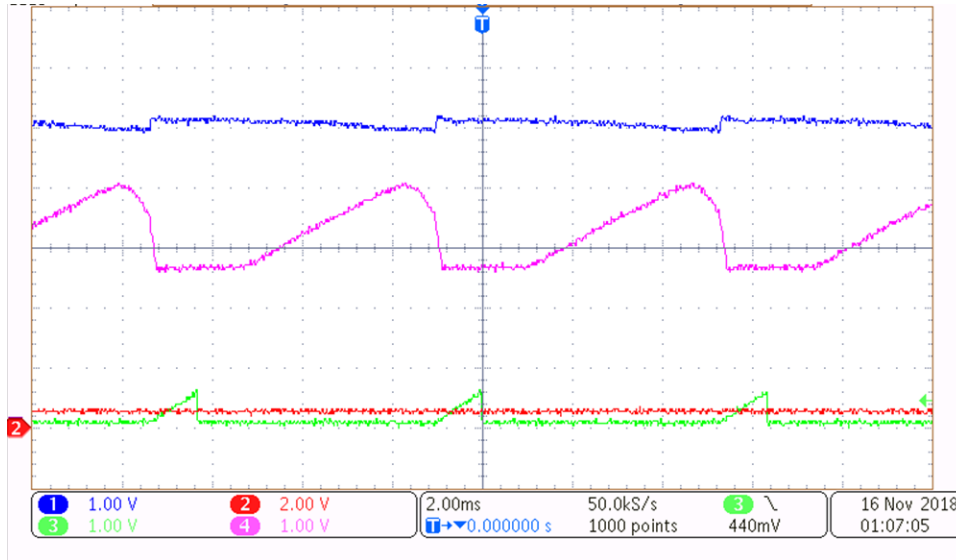

图 21. Breakdown of Load Switch Current Limit

图 22. POL Current Limit With Phase Node
表 22. Waveforms for 图 22

Waveform Number	Signal	Values
1	Input Voltage of Load Switch	5 V
2	Output Voltage of POL Converter	0 V
3	Phase Node of POL Converter	0 to 5 V @ 100-kHz Switching Frequency
4	Output Voltage of Load Switch	5 V

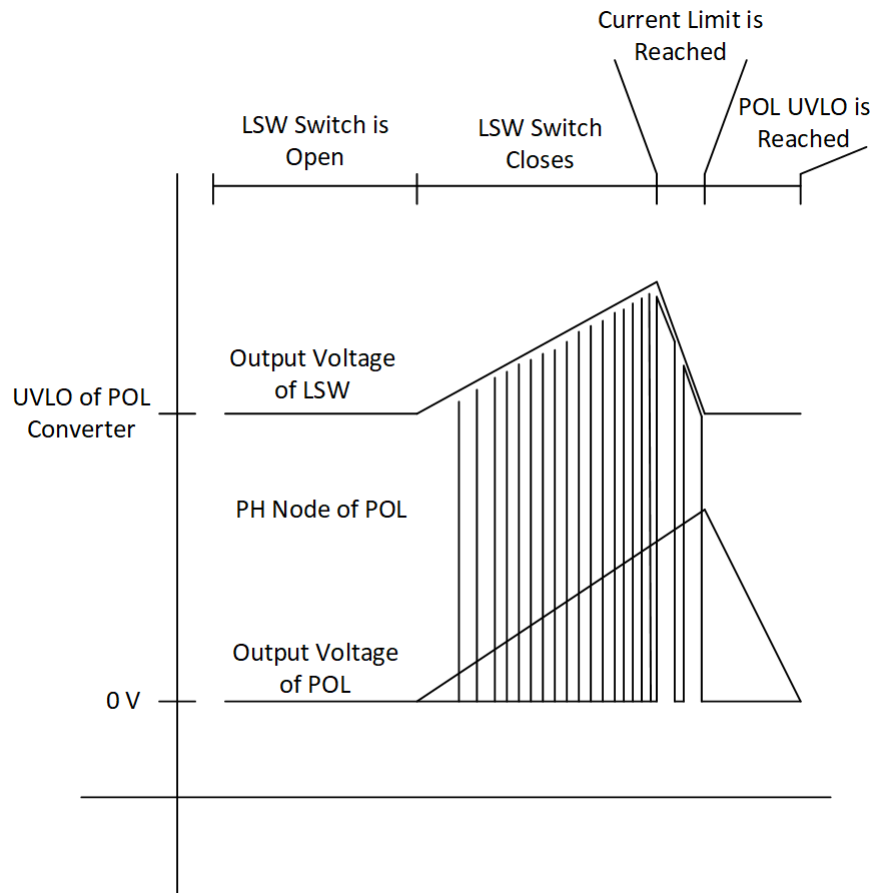
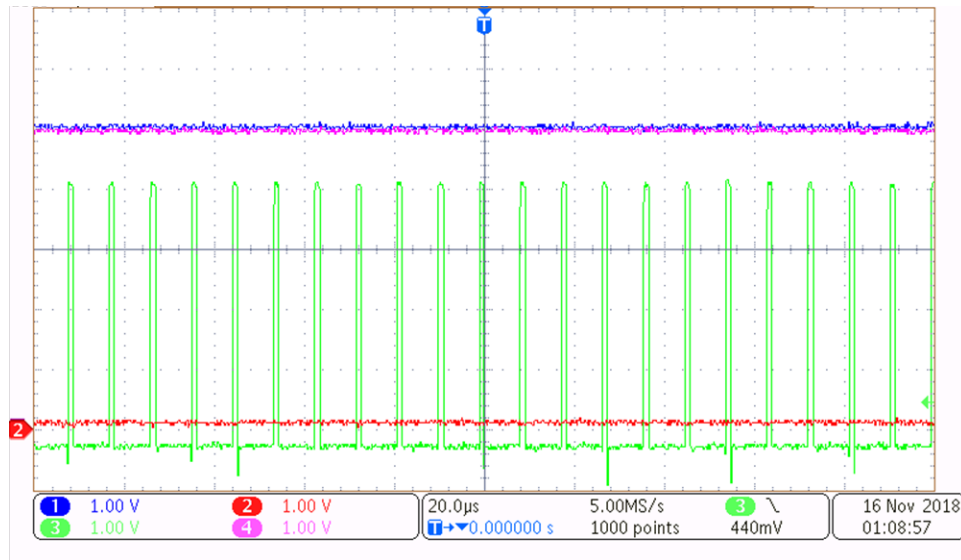

图 23. POL Current Limit With Timer Pins

In this test, the current limit of the load switch was set at 7.5 A. The POL converter has an internal current limit of 11 A to 13 A on the output that was tripped. This causes the POL converter to limit the input current to around 3 A with the output voltage of the POL converter dropping. Since the current limit of the POL converter limited the input current of the POL converter, the current limit of the load switch was not tripped and continued functioning. The duty cycle commanded will be determined by the minimum on time of the POL converter.

表 23. Waveforms for 图 23

Waveform Number	Signal	Values
1	Input Voltage of Load Switch	5 V
2	RLTimer Pin of Load Switch	0.5 V
3	ILTimer Pin of Load Switch	0 V
4	Output Voltage of Load Switch	5 V

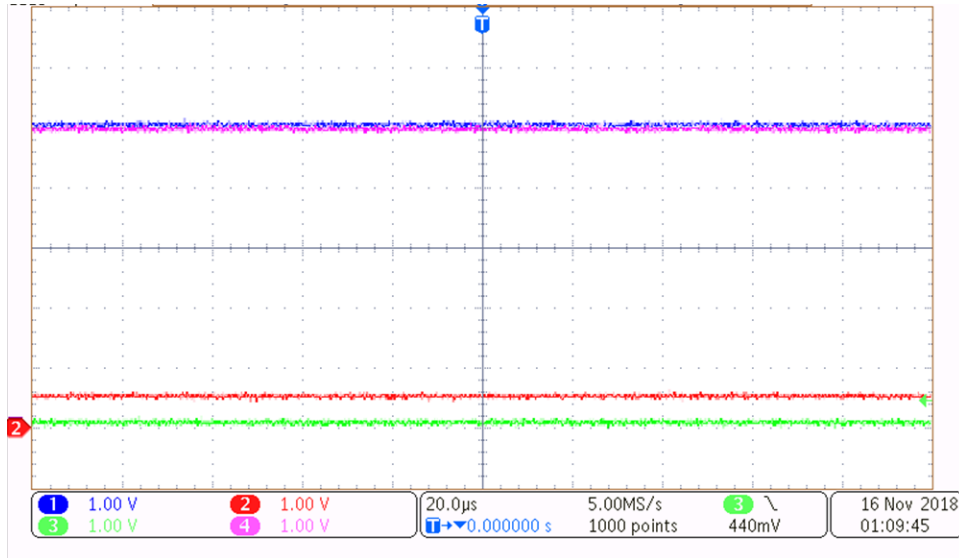
4 Design Files

4.1 Schematics

To download the schematics, see the design files at [TIDA-070001](#).

4.2 Bill of Materials

To download the bill of materials (BOM), see the design files at [TIDA-070001](#).

4.3 PCB Layout Recommendations

The TPS7H2201-SP EVM has power planes for VIN1, VIN2, VOUT, and GND on the top layer. Layers 2 and 3 are mostly all GND, with some signal routing on layer 3. Layer 4 contains more power planes for VIN1, VIN2, VOUT, and GND. Having multiple layers for each power plane allows for increased current carrying capacity and very low trace resistance. Vias are placed under the TPS7H2201-SP to allow for a thermal path from the top layer to the bottom layer.

For the TPS50601A-SP EVM that was used, it has PVIN, VIN, VOUT, and VPHASE all placed on the top layer. PVIN, VIN, and VOUT are also placed on the bottom of the board to increase current carrying capacity of the traces. The input decoupling capacitors (C8, C9, C10, C11, C12, C3, C4) are all located as close to the IC as possible. Placing the capacitors close is required to help with mitigating high frequency noise. The feedback resistors need to be placed as close to the FB pin as possible to prevent high frequency noise as well. The voltage set point divider, frequency set resistor, slow start capacitor, and compensation components are all routed to ground and placed close to a via to allow for high accuracy to the ground of the circuit board.

4.3.1 Layout Prints

To download the layer plots, see the design files at [TIDA-070001](#).

4.4 Altium Project

To download the Altium Designer® project files, see the design files at [TIDA-070001](#).

4.5 Gerber Files

To download the Gerber files, see the design files at [TIDA-070001](#).

4.6 Assembly Drawings

To download the assembly drawings, see the design files at [TIDA-070001](#).

5 Related Documentation

1. [TPS7H2201-SP Radiation Hardened 1.5-V to 7-V, 6-A Load Switch, SLVSD00](#)
2. [TPS50601A-SP Radiation Hardened 3-V to 7-V Input, 6-A Synchronous Buck Converter, SLVSDF5](#)

5.1 商标

E2E is a trademark of Texas Instruments.

Altium Designer is a registered trademark of Altium LLC or its affiliated companies.

All other trademarks are the property of their respective owners.

5.2 *Third-Party Products Disclaimer*

TI'S PUBLICATION OF INFORMATION REGARDING THIRD-PARTY PRODUCTS OR SERVICES DOES NOT CONSTITUTE AN ENDORSEMENT REGARDING THE SUITABILITY OF SUCH PRODUCTS OR SERVICES OR A WARRANTY, REPRESENTATION OR ENDORSEMENT OF SUCH PRODUCTS OR SERVICES, EITHER ALONE OR IN COMBINATION WITH ANY TI PRODUCT OR SERVICE.

修订历史记录

注：之前版本的页码可能与当前版本有所不同。

Changes from Original (December 2018) to A Revision	Page
• 已更改 将标题从“切换输入降压转换器参考设计”更改为“具有适用于 OCP 的冗余电子保险丝输入的 3V 至 7V _{IN} 航空级负载点 (POL) 参考设计”	1
• 已更改 更改了说明 段落	1
• 已更改 将“过流限制；过压限制；输入电压冗余；以及软启动”更改为“可调节过流保护 (OCP) 限制；可调节过压 (OVP) 限制；冗余输入；以及可配置软启动”	1
• 已删除 删除了“适用于 FPGA、微控制器、数据转换器和 ASIC 的卫星配电；耐辐射 应用和航天卫星有效载荷 应用”	1
• 已添加 添加了“命令和数据处理；卫星电力系统 (EPS)；光学成像有效载荷；雷达成像有效载荷；以及通信有效载荷 应用”	1

重要声明和免责声明

TI 均以“原样”提供技术性 & 可靠性数据（包括数据表）、设计资源（包括参考设计）、应用或其他设计建议、网络工具、安全信息和其他资源，不保证其中不含任何瑕疵，且不做任何明示或暗示的担保，包括但不限于对适销性、适合某特定用途或不侵犯任何第三方知识产权的暗示担保。

所述资源可供专业开发人员应用 TI 产品进行设计使用。您将对以下行为独自承担全部责任：(1) 针对您的应用选择合适的 TI 产品；(2) 设计、验证并测试您的应用；(3) 确保您的应用满足相应标准以及任何其他安全、安保或其他要求。所述资源如有变更，恕不另行通知。TI 对您使用所述资源的授权仅限于开发资源所涉及 TI 产品的相关应用。除此之外不得复制或展示所述资源，也不提供其它 TI 或任何第三方的知识产权授权许可。如因使用所述资源而产生任何索赔、赔偿、成本、损失及债务等，TI 对此概不负责，并且您须赔偿由此对 TI 及其代表造成的损害。

TI 所提供产品均受 TI 的销售条款 (<http://www.ti.com.cn/zh-cn/legal/termsofsale.html>) 以及 [ti.com.cn](http://www.ti.com.cn) 上或随附 TI 产品提供的其他可适用条款的约束。TI 提供所述资源并不扩展或以其他方式更改 TI 针对 TI 产品所发布的可适用的担保范围或担保免责声明。

邮寄地址：上海市浦东新区世纪大道 1568 号中建大厦 32 楼，邮政编码：200122
Copyright © 2019 德州仪器半导体技术（上海）有限公司

重要声明和免责声明

TI 均以“原样”提供技术性数据（包括数据表）、设计资源（包括参考设计）、应用或其他设计建议、网络工具、安全信息和其他资源，不保证其中不含任何瑕疵，且不做任何明示或暗示的担保，包括但不限于对适销性、适合某特定用途或不侵犯任何第三方知识产权的暗示担保。

所述资源可供专业开发人员应用TI 产品进行设计使用。您将对以下行为独自承担全部责任：(1) 针对您的应用选择合适的TI 产品；(2) 设计、验证并测试您的应用；(3) 确保您的应用满足相应标准以及任何其他安全、安保或其他要求。所述资源如有变更，恕不另行通知。TI 对您使用所述资源的授权仅限于开发资源所涉及TI 产品的相关应用。除此之外不得复制或展示所述资源，也不提供其它TI 或任何第三方的知识产权授权许可。如因使用所述资源而产生任何索赔、赔偿、成本、损失及债务等，TI 对此概不负责，并且您须赔偿由此对TI 及其代表造成的损害。

TI 所提供产品均受TI 的销售条款 (<http://www.ti.com.cn/zh-cn/legal/termsofsale.html>) 以及ti.com.cn上或随附TI产品提供的其他可适用条款的约束。TI提供所述资源并不扩展或以其他方式更改TI 针对TI 产品所发布的可适用的担保范围或担保免责声明。

邮寄地址：上海市浦东新区世纪大道 1568 号中建大厦 32 楼，邮政编码：200122
Copyright © 2019 德州仪器半导体技术（上海）有限公司