

TI Designs: TIDM-TM4C129SDRAMNVM

使用 NVM 中的存储代码从 SDRAM 中执行，以获得高性能 MCU 参考设计



说明

TM4C129x 微控制器 (MCU) 的存储空间可在内部存储不足时进行扩展。此参考设计对 TM4C129x MCU 的硬件接口要求和示例软件进行了说明。

资源

TIDM-TM4C129SDRAMNVM	设计文件夹
EK-TM4C1294XL	工具文件夹
TM4C1294NCPDT	产品文件夹
TM4C123GH6PM	产品文件夹
TPD4S012	产品文件夹
TPS2052B	产品文件夹
TPS62177	产品文件夹
TPS73733-Q1	产品文件夹



咨询我们的 E2E™ 专家

特性

- 通过 60MHz 外设接口 (EPI) 将可用存储空间扩展为 512MB 16 位 SDRAM，以应对高存储吞吐量和空间占用应用
- 专为基于 Arm® Cortex®-M4F 的 MCU TM4C1294 互联 LaunchPad™ 评估套件而设计
- 执行用于 SD 卡或四路串行非易失性闪存存储器的串行接口加载程序
- 为四路闪存模式命令提供额外支持，以实现裸机外部存储记录器的自定义执行方式
- 提供包含 Code Composer Studio™IDE 项目示例的源代码

应用

- 交互式人机界面
- 工业自动化
- 物联网 (IoT) 解决方案
- 测试和测量

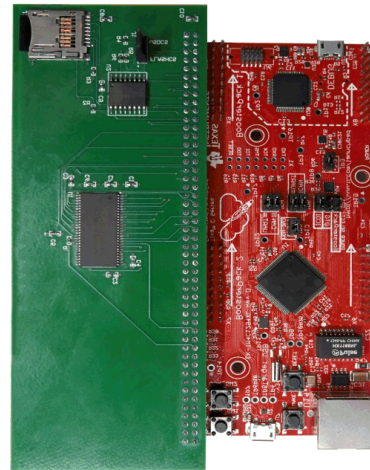
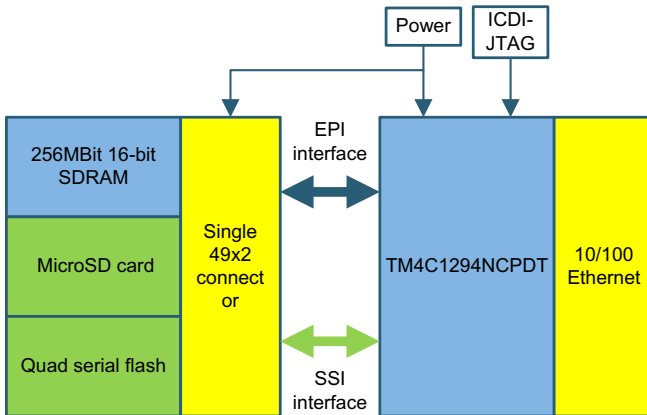

该 TI 参考设计末尾的重要声明表述了授权使用、知识产权问题和其他重要的免责声明和信息。

1 System Description

The external peripheral interface (EPI) of the TM4C129x MCUs can be used to extend the executable memory region to 16-bit 512Mb of SDRAM. The QSSI interface at 60 MHz can extend storage of NVM code. This capability lets applications use microSD cards or QSSI flash memory greater than 512Mb. The design files include schematics, BOM, Gerber files, and reference example code for an easy-to-use SDRAM, an SD card boot, and an QSSI boot with a [TM4C1294NCPDT Connected LaunchPad development kit](#).

2 System Overview

2.1 Block Diagram

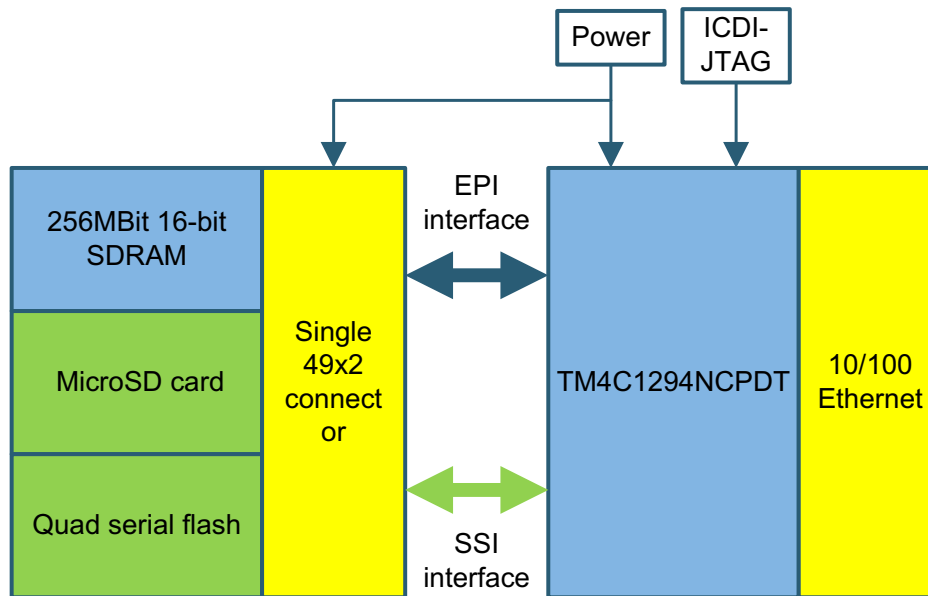

SDRAM-NVM Memory Extender Block Diagram

2.2 TM4C1294NCPDT Microcontroller

The TM4C1294NCPDT is a 120-MHz high-performance microcontroller with 1MB of on-chip flash and 256KB of on-chip SRAM. The device features an integrated Ethernet MAC and PHY for connected applications. The device has high-bandwidth interfaces like a memory controller and a high-speed USB 2.0 digital interface. Integrating low- to mid-speed serials, up to 4-Msps 12-bit ADC, and motion control peripherals, this design is a unique solution for a variety of applications from industrial communication equipment to smart energy and smart grid applications.

图 1 shows a high-level block diagram of the TM4C1294NCPDT microcontroller.



图 1. TM4C1294NCPDT Microcontroller High-Level Block Diagram

3 Hardware, Software, Testing Requirements, and Test Results

3.1 Getting Started Hardware

Interfacing the SDRAM-NVM memory to the TM4C1294NCPDT device on an EK-TM4C1294XL Connected LaunchPad kit requires a daughterboard that can connect to the breadboard connector X11.

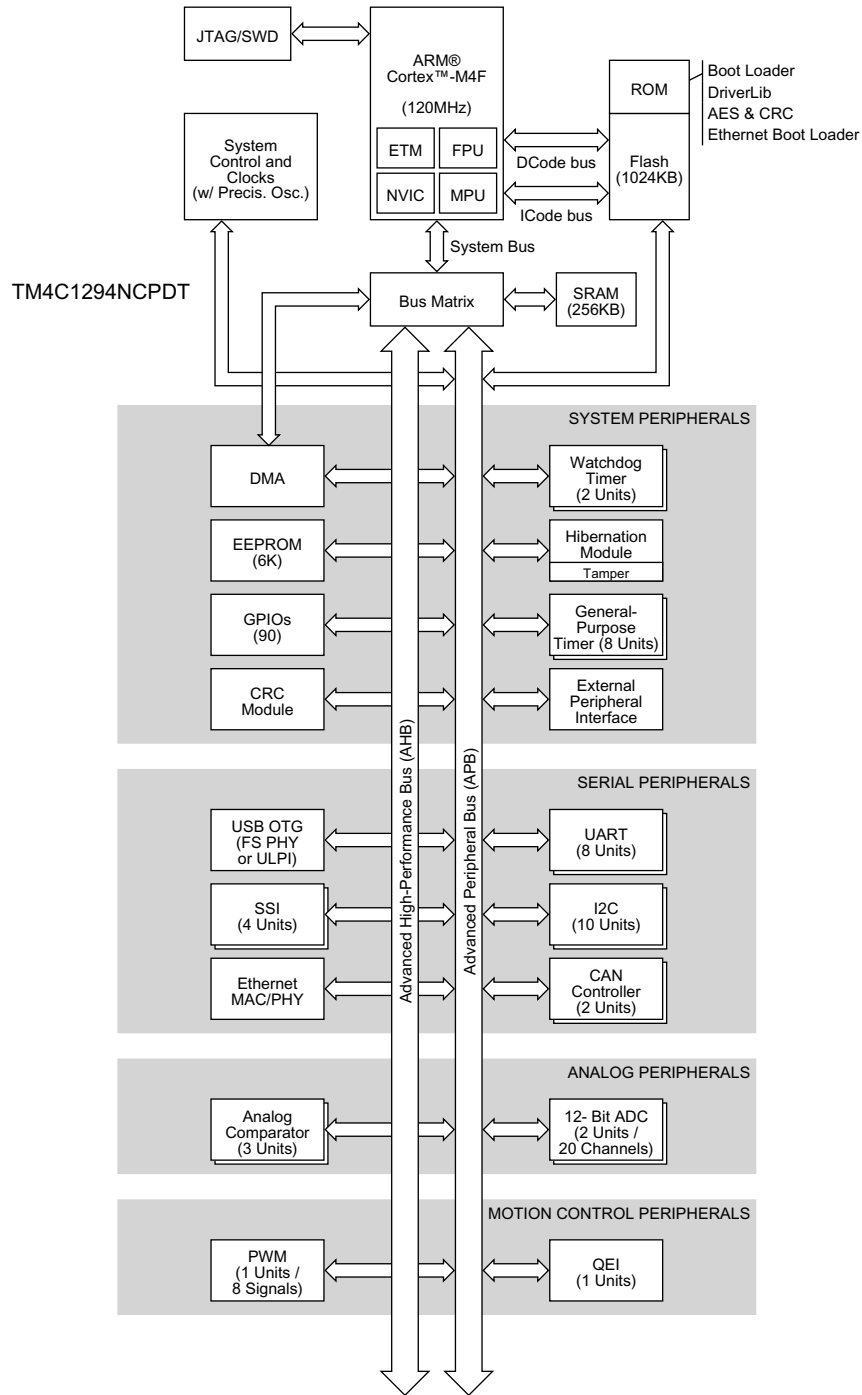
3.1.1 SDRAM-NVM Daughtercard

The SDRAM-NVM daughtercard interfaces to the EK-TM4C1294XL Connected LaunchPad kit using the 49x2 breadboard connectors. The daughtercard has one jumper (J1) that can be used to select between the microSD card or the QSSI serial flash. The microSD card uses the legacy SPI mode of the QSSI module to interface with the microcontroller while the QSSI serial flash uses the advanced mode of the QSSI module to interface with the microcontroller. 图 2 shows an overview of the connector mounting for the daughtercard.



图 2. SDRAM-NVM Connector Mounting

3.2 Getting Started Software

The software for this reference design comes with three codes that you can import in Code Composer Studio IDE and use as a starting point for your application (for download information, see 5 节).

3.2.1 MicroSD Card Boot With SDRAM Code Execution

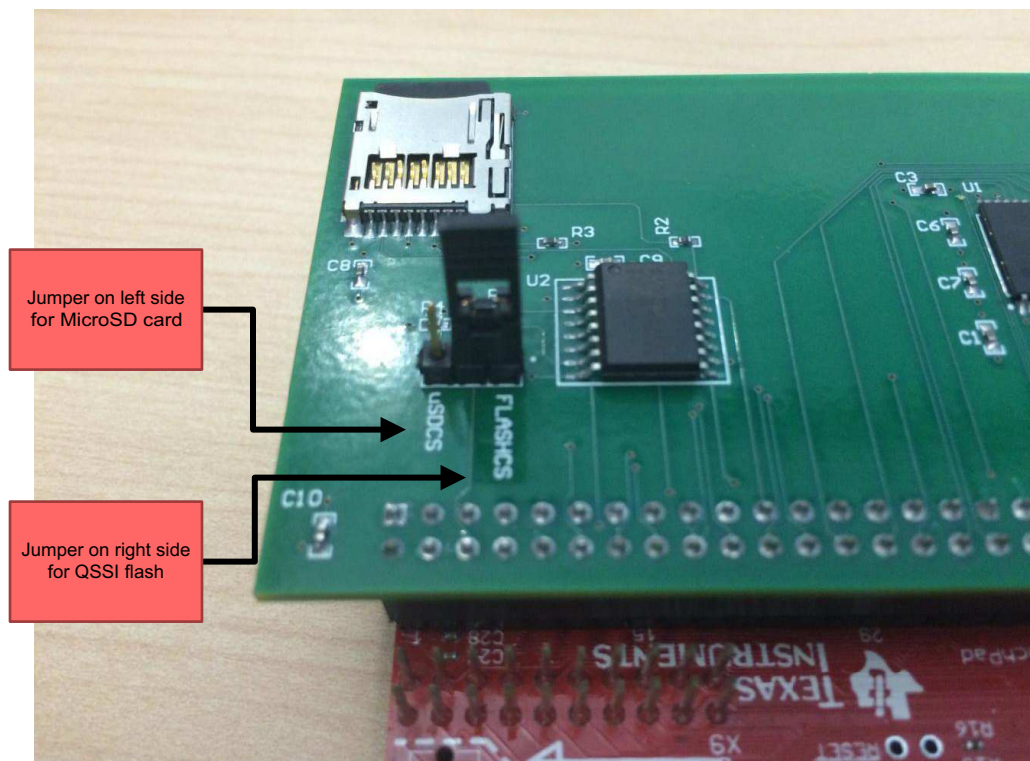
The MicroSD card boot with SDRAM code uses the internal flash of the TM4C1294NCPDT to hold the FAT file system and bootloader. The bootloader configures the QSSI modules to run the FAT file system and EPI to interface to a 512-Mb SDRAM at interface frequency of 60 MHz. You can have multiple images on an microSD card configured during compile time to execute from an EPI address space of 0x6000 0000. You can select one of the image files that the bootloader copies to the EPI peripheral-connected SDRAM. After the image is copied, the Cortex-M4 disables the interrupts, updates the NVIC_VTABLE register to map to the external address map, and jumps to the external address space of 0x6000 0000. All subsequent code execution occurs in the external address space until the next board reset. You must use a PC to copy the images to the microSD Card.

3.2.2 QSSI Serial Flash Boot With SDRAM Code Execution

The QSSI serial flash boot with SDRAM code uses the internal flash of the TM4C1294NCPDT to hold a custom bootloader. The bootloader configures the QSSI modules to read a QSSI flash memory and the EPI to interface to a 512-Mb SDRAM at an interface frequency of 60 MHz for executing code.

The lowest sector (Sector-0) of QSSI flash memory holds a table indicating the start address, size, and validity of an image. The bootloader updates this location when you download the binary file to the external QSSI flash memory through UART0. 图 3 shows the structure of the information held in Sector-0 pertaining to an actual application image.



图 3. Sector-0 Information Block Structure

You can download an image to the QSSI flash memory that has been configured at compile time to execute from the EPI address space 0x6000 0000. The image is downloaded from a PC or other controller. To load a new image to the QSSI flash, press USR_SW1 when powering up or resetting the LaunchPad kit. This causes the bootloader to enter download mode. If the USR_SW1 is not pressed, the bootloader reads Sector-0 for a valid image pointer and executes the last image available on QSSI flash. If no valid image pointer is found, the bootloader enters download mode and waits for a new image. During the execution phase, the bootloader copies the image to the SDRAM memory connected to the EPI peripheral. When the image finishes copying, the Cortex-M4 disables the interrupts, updates the NVIC_VTABLE register to map to the external address map, and jumps to the external address space 0x6000 0000. All subsequent code execution occurs in the external address space until the next board reset. 图 4 shows a flow chart of how the code operates.

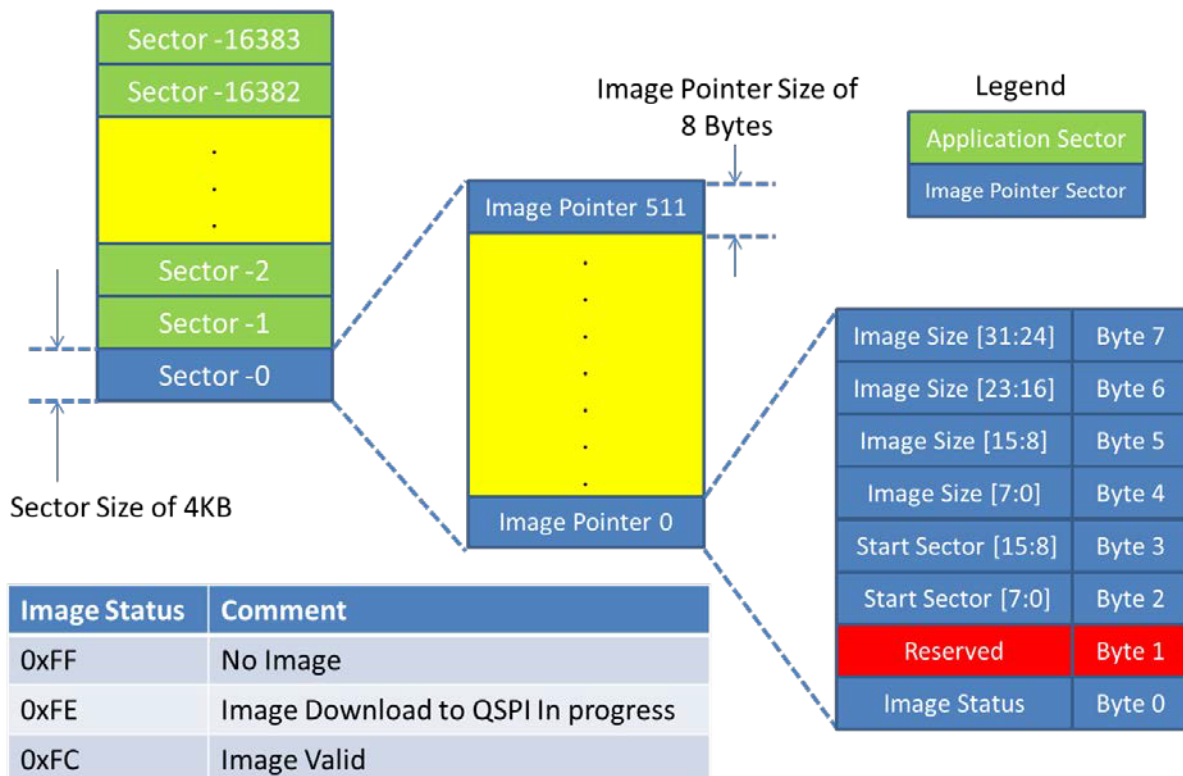

图 4. Example Code Program Flow

3.2.3 QSSI Bare Metal Code

The QSSI bare metal code configures the QSSI module of the TM4C1294NCPDT to perform advanced and quad mode programming for write operations and advanced-, bi-, and quad-mode for read operations. For this example, the QSSI serial interface operates at 60 MHz, which demonstrates the maximum achievable throughput.

3.3 Test Setup

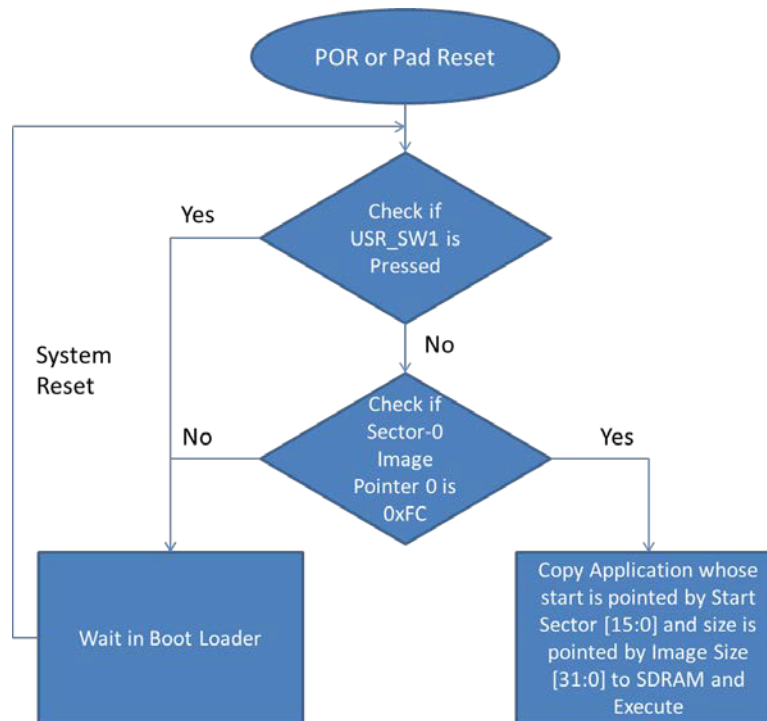
The test setup is:

1. Import the test project into CCS.
2. Build and compile the project.
3. Download the executable to the EK-TM4C1294XL LaunchPad lit.
4. Execute the test code on the target.

During execution, the test code first erases a 4KB sector and checks to ensure the erase was successful. If the erase was successful, the test code then performs a program and read operation on the 4KB sector. After performing the read operation, the test concludes with an erase and erase confirmation of the 4KB test sector.

3.3.1 Hardware Setup

图 5 shows an overview of the hardware setup. The USB cable on the left side of the EK-TM4C129XL Connected LaunchPad kit provides power, connects to JTAG, and connects the UART for communication between a PC terminal window application such as Putty or Tera Term and the hardware. The SDRAM-NVM memory extender uses header X11 to connect to the LaunchPad kit.

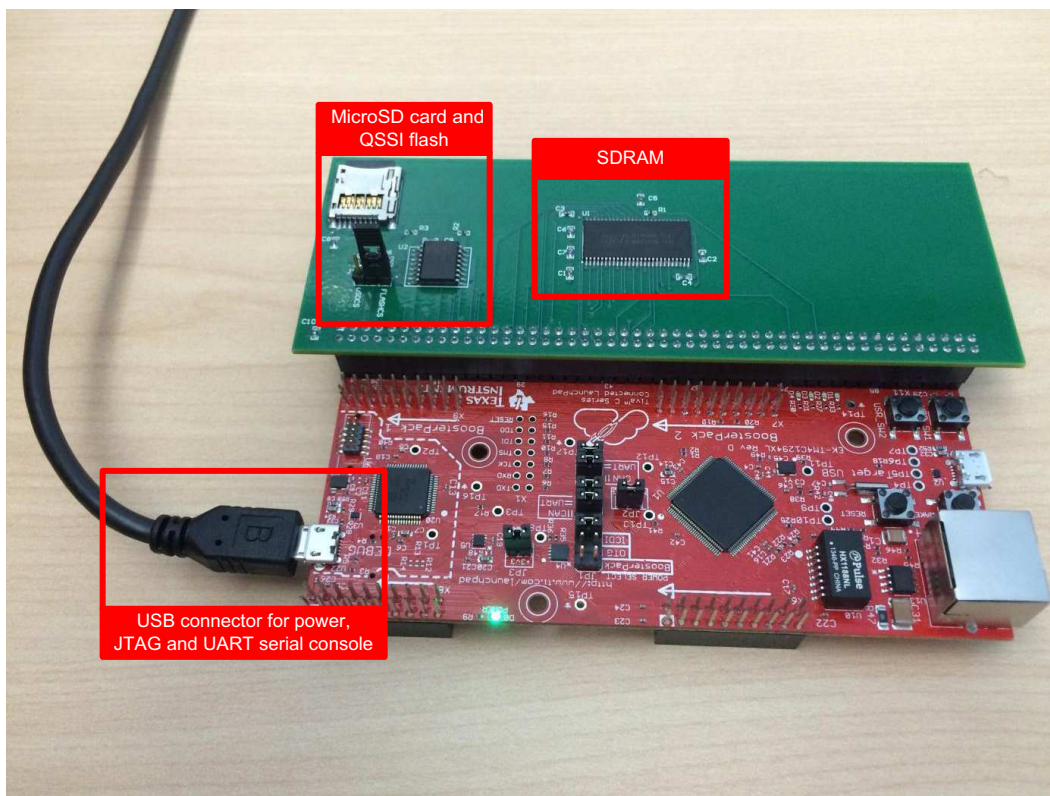

Download and install a serial console application (for example, PuTTY, TeraTerm, and so forth), Code Composer Studio™ IDE v6.0.1 or later, and TivaWare™ for C Series v2.1.0-12573 or later to use this example.

图 5. Full Test Assembly

3.3.2 Software Setup (microSD Card Boot With SDRAM Code Execution)

1. Download the example software package from [TIDM-TM4C129SDRAMNVM](#). Unzip the software package.
2. Launch Code Composer Studio IDE v6.0.1 or later → Click Import→ Click CCS Projects→ Click Next. Browse to the directory with the software examples. Select "ektm4c129_sdcard_bootloader", "ektm4c129_sdcard_boot_demo1", and "ektm4c129_sdcard_boot_demo2". Click Finish.



图 6. SD Card Boot Project Import

- Build each project. To build a project, right-click on a project. Click Rebuild Project. Ensure the projects compile free of errors.

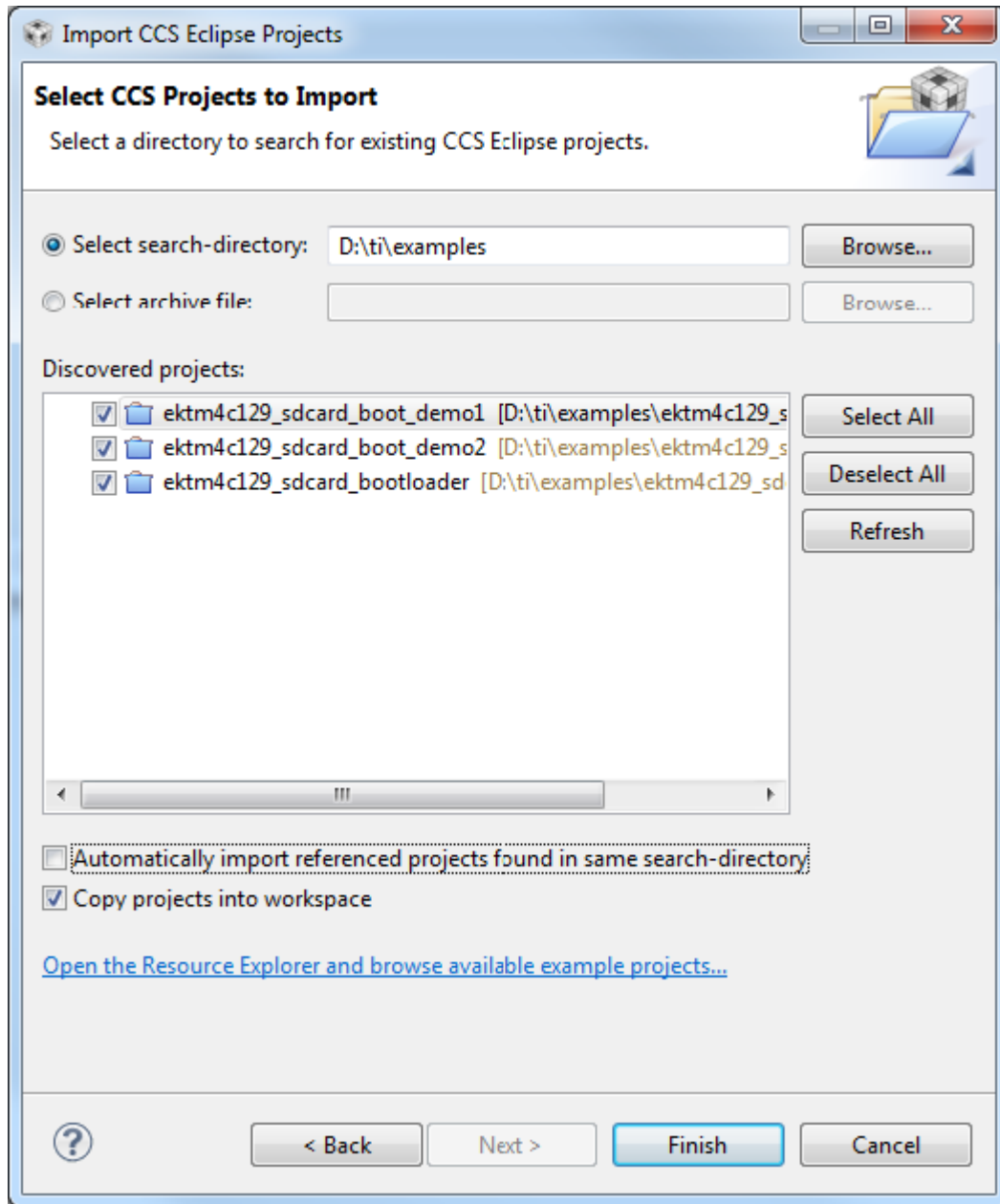

图 7. Compiling SD Card Boot Software

- Copy the bin files from "ektm4c129_sdcard_boot_demo1" and "ektm4c129_sdcard_boot_demo2" to a microSD card connected to a PC. Insert the microSD card with the copied files into the slot on the SDRAM-NVM memory extender. Place jumper J1 on the uSDCS side to assert the microSD chip select.

5. Press Debug to run the main bootloader, "ektm4c129_sdcard_bootloader", in the TM4C1294NCPDT flash. Press Play when the code loads. When you will see the prompt for the microSD card on a serial console, type "help" to see the options. Type "ls" to see the list of files. To select a binary image, type "boot ektm4c129_sdcard_boot_demo1". The uart_echo application will copy and execute from the SDRAM.

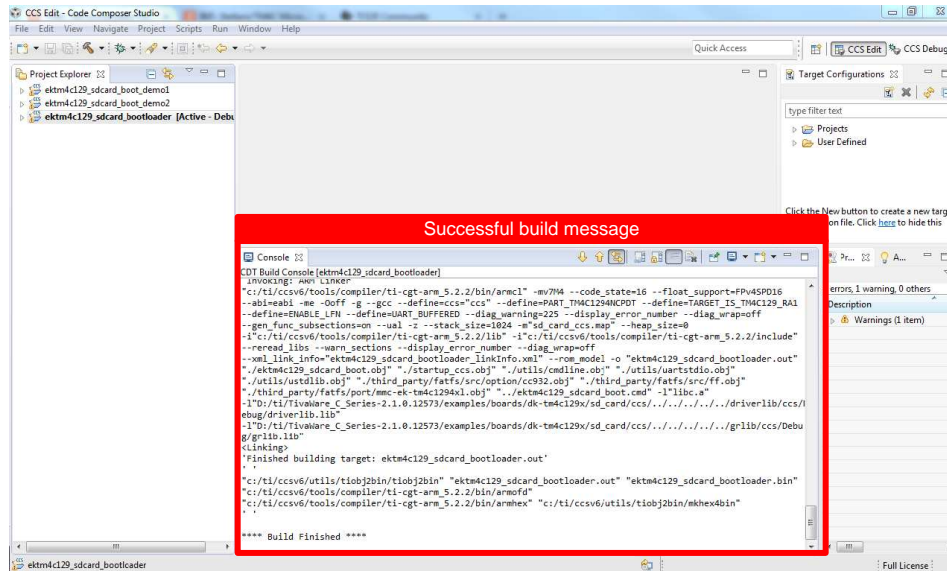
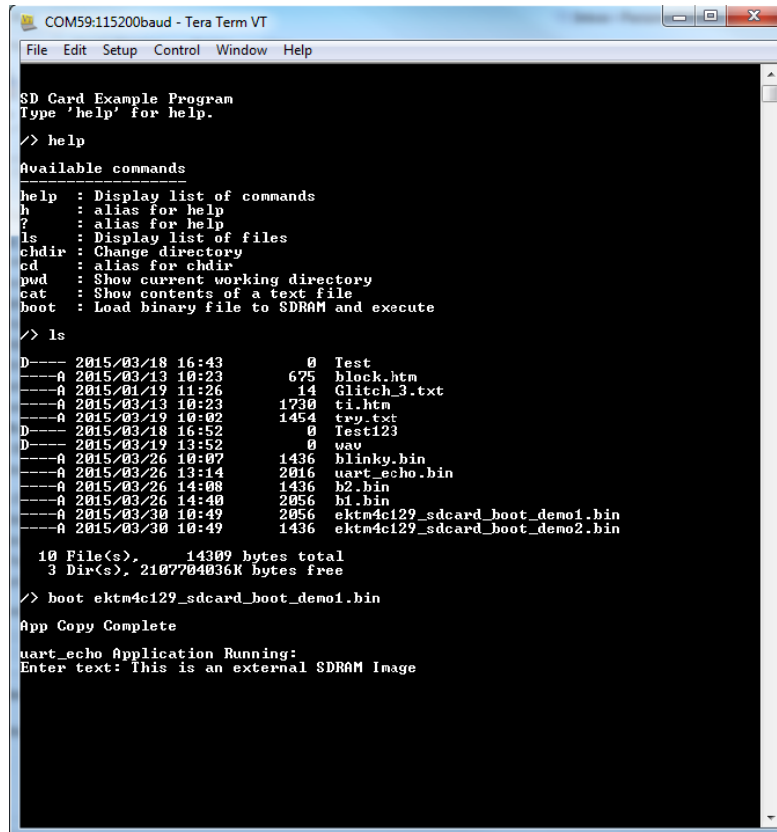

```

COM59:115200baud - Tera Term VT
File Edit Setup Control Window Help

SD Card Example Program
Type 'help' for help.

/> help

Available commands

help : Display list of commands
h : alias for help
? : alias for help
ls : Display list of files
chdir : Change directory
cd : alias for chdir
pwd : Show current working directory
cat : Show contents of a text file
boot : Load binary file to SDRAM and execute

/> ls

D---- 2015/03/18 16:43      0 Test
----A 2015/03/13 10:23    675 block.htm
----A 2015/01/19 11:26     14 Glitch_3.txt
----A 2015/03/13 10:23   1730 ti.htm
----A 2015/03/19 10:02   1454 try.txt
D---- 2015/03/18 16:52      0 Test123
D---- 2015/03/19 13:52      0 wav
----A 2015/03/26 10:07   1436 blinky.bin
----A 2015/03/26 13:14   2016 uart_echo.bin
----A 2015/03/26 14:08   1436 b2.bin
----A 2015/03/26 14:40   2056 b1.bin
----A 2015/03/30 10:49   2056 ektm4c129_sdcard_boot_demo1.bin
----A 2015/03/30 10:49   1436 ektm4c129_sdcard_boot_demo2.bin

 10 File(s),  14309 bytes total
   3 Dir(s), 2107704036K bytes free

/> boot ektm4c129_sdcard_boot_demo1

App Copy Complete

uart_echo Application Running:
Enter text: This is an external SDRAM Image
    
```

图 8. Serial Console Output For ektm4c129_sdcard_boot_demo1.bin

Type "boot ektm4c129_sdcard_boot_demo2" to copy and execute the D2 LED blinky application from the SDRAM.

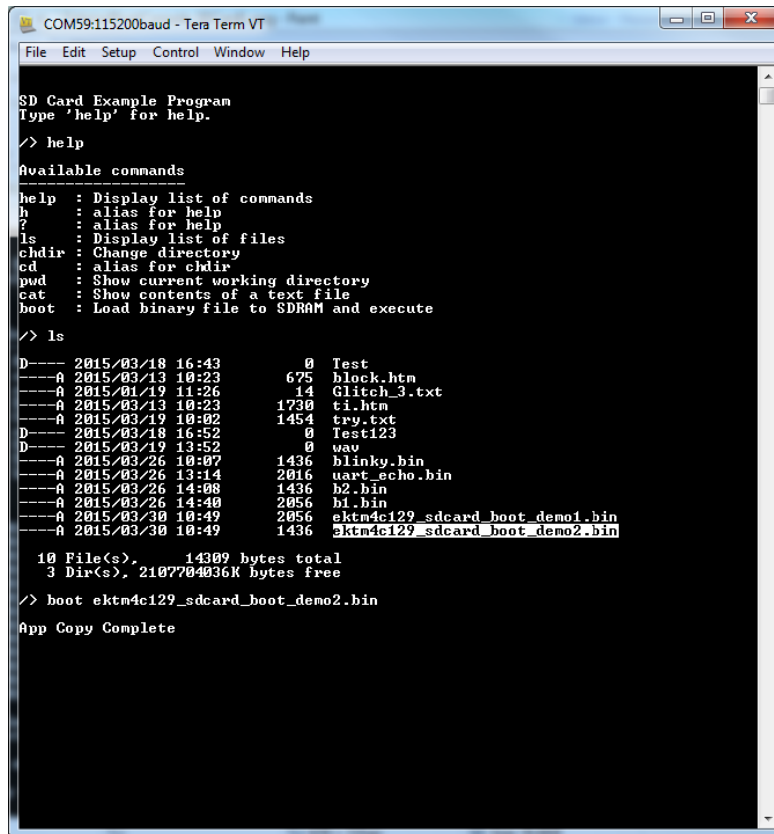

```

COM59:115200baud - Tera Term VT
File Edit Setup Control Window Help

SD Card Example Program
Type 'help' for help.

>> help

Available commands
-----
help : Display list of commands
h    : alias for help
?    : alias for help
ls   : Display list of files
chdir: Change directory
cd   : alias for chdir
pwd  : Show current working directory
cat  : Show contents of a text file
boot : Load binary file to SDRAM and execute

>> ls

D----- 2015/03/18 16:43      0 Test
--a---- 2015/03/13 10:23    675 block.htm
--a---- 2015/01/19 11:26      14 Glitch 3.txt
--a---- 2015/03/13 10:23   1730 ti.htm
--a---- 2015/03/19 10:02   1454 try.txt
D----- 2015/03/18 16:52      0 Test123
D----- 2015/03/19 13:52      0 wav
--a---- 2015/03/26 10:07   1436 blinky.bin
--a---- 2015/03/26 13:14   2016 uart_echo.bin
--a---- 2015/03/26 14:08   1436 b2.bin
--a---- 2015/03/26 14:40   2056 b1.bin
--a---- 2015/03/30 10:49   2056 ektm4c129_sdcard_boot_demo1.bin
--a---- 2015/03/30 10:49   1436 ektm4c129_sdcard_boot_demo2.bin

 10 File(s), 14309 bytes total
  3 Dir(s), 2107704036K bytes free

>> boot ektm4c129_sdcard_boot_demo2.bin

App Copy Complete
    
```

图 9. Serial Console Output For ektm4c129_sdcard_boot_demo2.bin

- To restart the microSD card boot, press reset. The current application does not jump to the microSD card prompt.

3.3.3 Software Setup (QSSI Serial Flash Boot with SDRAM Code Execution)

1. Download the example software package from [TIDM-TM4C129SDRAMNVM](#). Unzip the software package.
2. Launch Code Composer Studio v6.0.1 or later → Click Import → Click CCS Projects → Click Next. Browse to the directory with the software examples. Select "ektm4c129_qssi_bootloader", "ektm4c129_qssi_boot_demo1", and "ektm4c129_sdcard_boot_demo2". Click Finish.



图 10. QSSI Example Project Import

- Build each project. To build a project, right-click on a project. Click Rebuild Project. Ensure the projects compile free of errors.

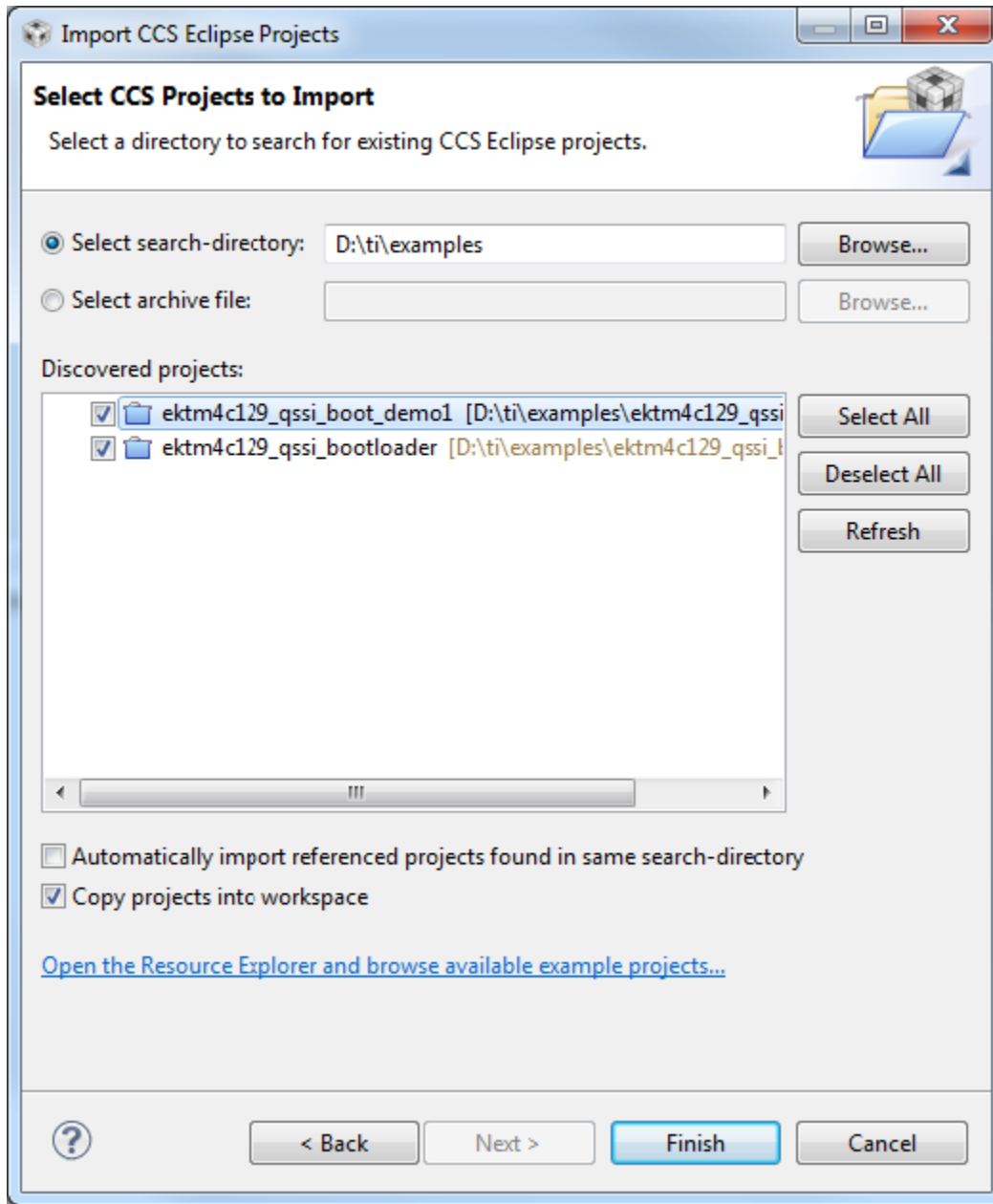

图 11. Compiling the QSSI Software Example

- Place jumper J1 on the FLASHCS side. Use the LM Flash programmer to download ektm4c129_qssi_bootloader to an TM4C1294NCPDT Connected LaunchPad kit that has been erased. After performing checks for QSSI and SDRAM memory, the bootloader activates UART0 to download an image to the external QSSI flash. For the setting of the LM flash programmer, see [图 12](#) and [图 13](#).)



图 12. LM Flash Programmer Main Bootloader Programming - Interface Setting (JTAG)

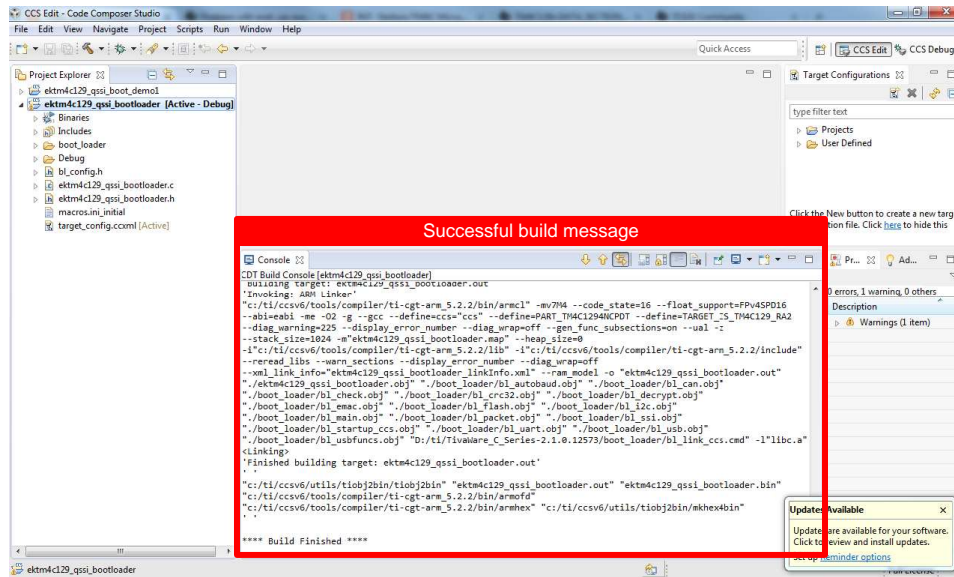

图 13. LM Flash Programmer Main Bootloader Programming - Options Settings

- Using the LM Flash Programmer in serial mode, download ektm4c129_qssi_boot_demo1. Ensure Disable Auto Baud Support is checked. Select the correct COM port. Ensure the Transfer Size is 64 bytes or less. On the Program Tab, select the Program Address Offset as the start of a sector of QSSI Flash other than Sector-0. (For the setting of the LM Flash Programmer for downloading the demo code, see 图 14 and 图 15. When the demo code downloads, the LED D3 will start blinking.)

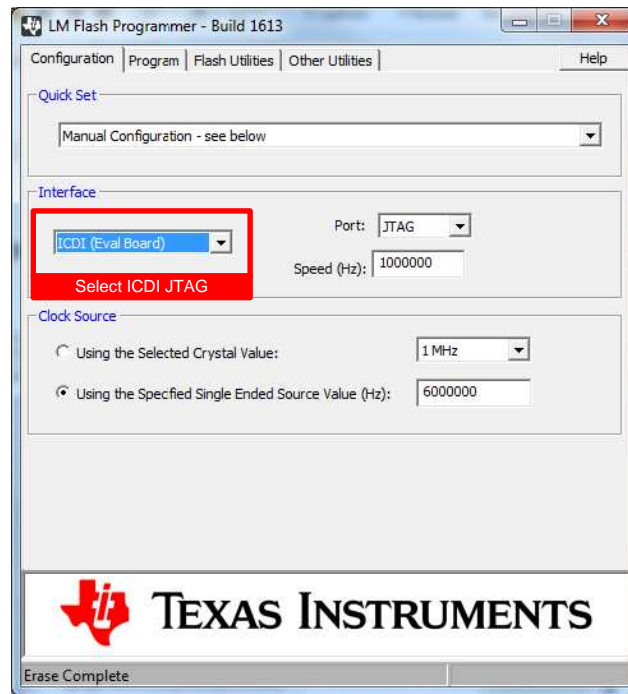

图 14. LM Flash Programmer QSSI Boot Demo1 Programming - Interface Settings (UART)

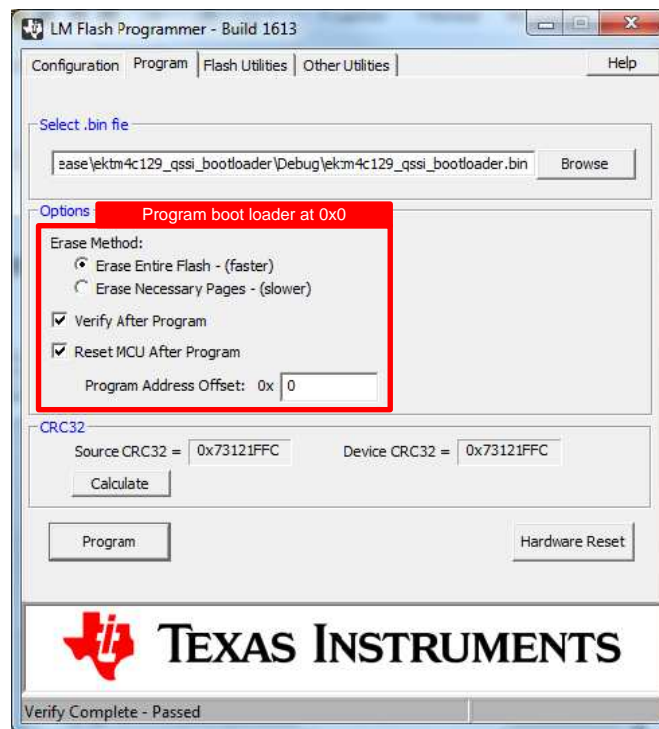

图 15. LM Flash Programmer QSSI Boot Demo 1 Programming - Options (Address Offset)

- Use USR_SW2 to accelerate the blinking rate and USR_SW1 to reduce the blinking rate.

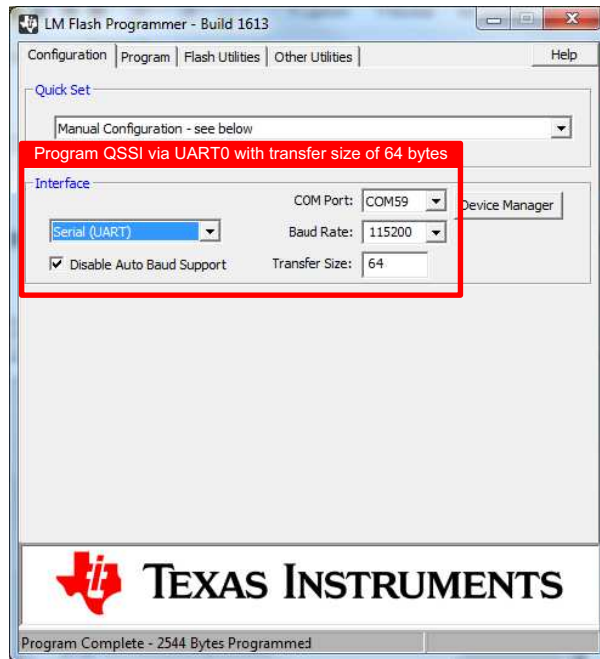
3.3.4 Software Setup (QSSI Bare Metal Example)

1. Download the example software package from [TIDM-TM4C129SDRAMNVM](#). Unzip the software package.
2. Launch Code Composer Studio v6.0.1 or later→ Click Import→ Click CCS Projects→ Click Next. Browse to the directory with the software examples. Select "ektm4c129_qssi_example". Click Finish.

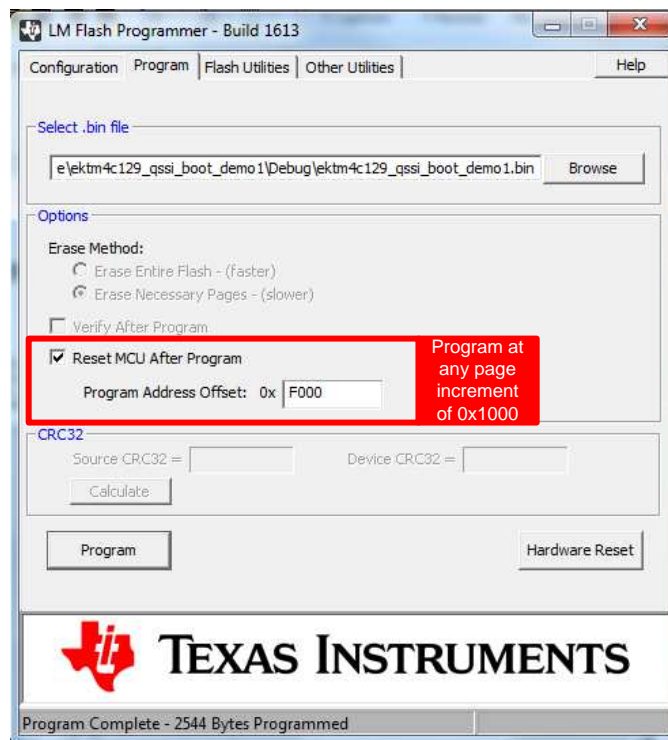

图 16. QSSI Bare Metal Project Import

- Build each project. To build a project, right-click on a project. Click Rebuild Project. Ensure the projects compile free of errors.

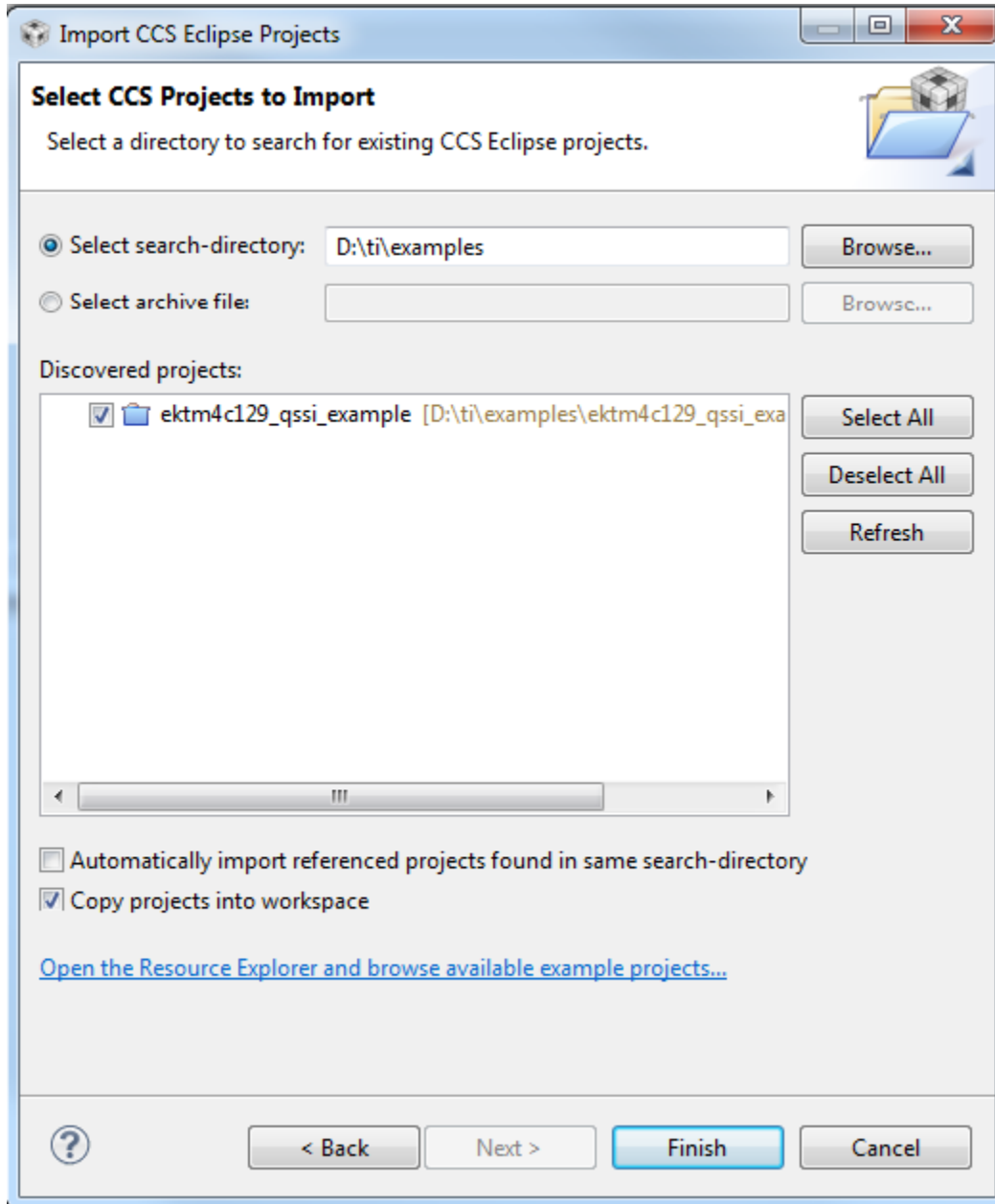

图 17. QSSI Bare Metal Compile

- Ensure the J1 jumper is connected to the FLASHCS side. Press Debug to download "ektm4c129_qssi_example" and load the code into the TM4C1294NCPDT flash. Press Play when the code has loaded. On the serial console, ensure you see the log file generated for erase, advanced mode program, quad mode program, advanced mode read, bi-mode read, and quad mode read.

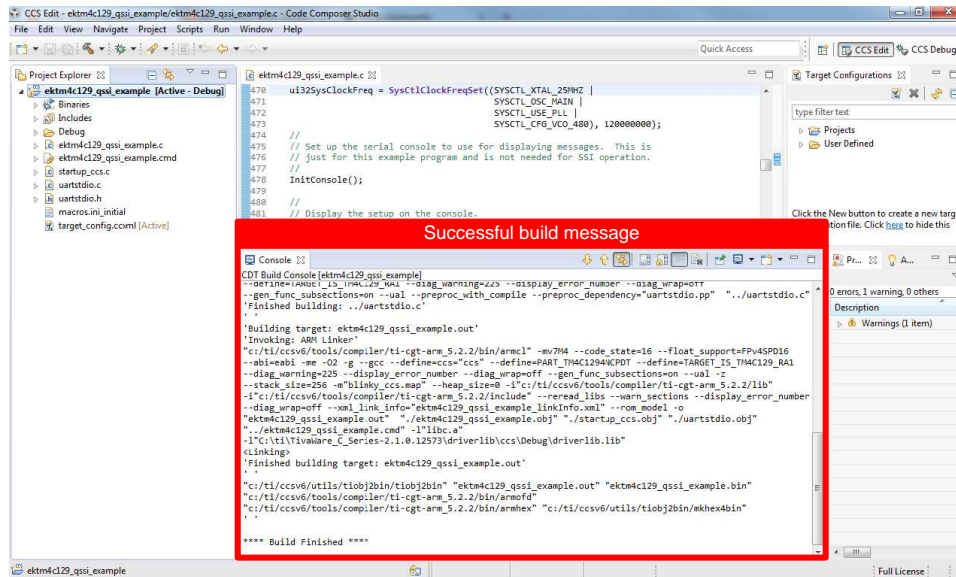

图 18. QSSI Bare Metal Example Serial Console Output

4 Design Files

4.1 Schematics

To download the schematics for the board, see the design files at [TIDM-TM4C129SDRAMNVM](#).

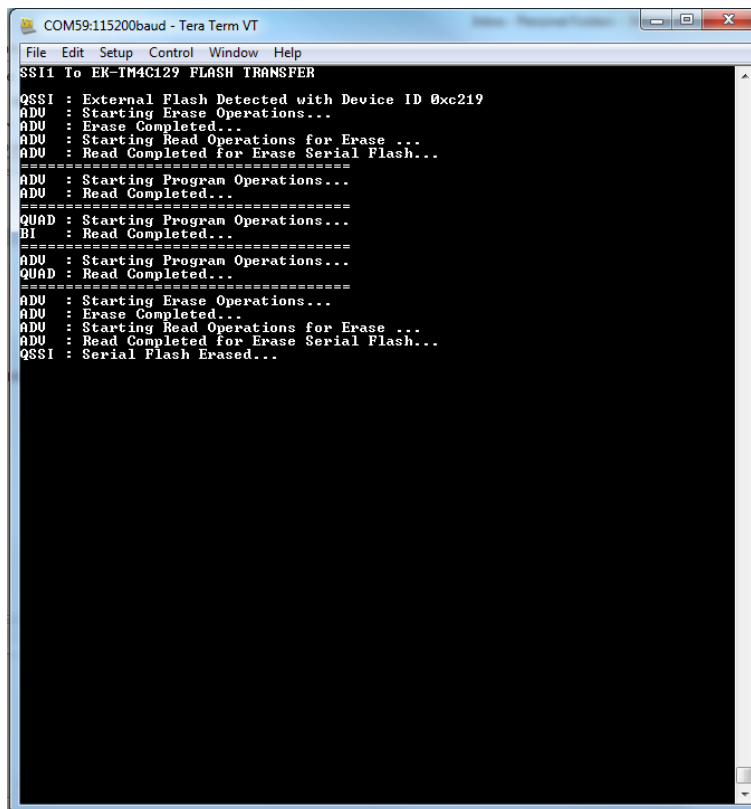
4.2 Bill of Materials

To download the bill of materials (BOM), see the design files at [TIDM-TM4C129SDRAMNVM](#).

4.3 PCB Layout Recommendations

When performing the layout, make sure that the EPI0S31 (the SDRAM clock pin) has the shortest trace. To minimize reflections from the shared data and address pins, use a single route from the connector pin to the address pin or data pin without creating a stub.

4.4 Altium Project

Altium Designer® project files are not available for this reference design.

4.5 Gerber Files

To download the Gerber files, see the design files at [TIDM-TM4C129SDRAMNVM](#).

4.6 Assembly Drawings

Assembly drawings are not available for this reference design.

5 Software Files

To download the software files, see the design files at [TIDM-TM4C129SDRAMNVM](#).

6 Related Documentation

1. [IS42/45R86400D/16320D/32160D 16Mx32, 32Mx16, 64Mx8 512Mb SDRAM data sheet](#)
2. [MX66L51235F 3V, 512M-BIT \[x 1/x 2/x 4\] CMOS MXSMIO® \(SERIAL MULTI I/O\) FLASH MEMORY data sheet](#)

6.1 商标

E2E, LaunchPad, Code Composer Studio, TivaWare are trademarks of Texas Instruments. Altium Designer is a registered trademark of Altium LLC or its affiliated companies. Arm, Cortex are registered trademarks of Arm Limited. All other trademarks are the property of their respective owners.

6.2 Third-Party Products Disclaimer

TI'S PUBLICATION OF INFORMATION REGARDING THIRD-PARTY PRODUCTS OR SERVICES DOES NOT CONSTITUTE AN ENDORSEMENT REGARDING THE SUITABILITY OF SUCH PRODUCTS OR SERVICES OR A WARRANTY, REPRESENTATION OR ENDORSEMENT OF SUCH PRODUCTS OR SERVICES, EITHER ALONE OR IN COMBINATION WITH ANY TI PRODUCT OR SERVICE.

7 About the Author

AMIT ASHARA is an application engineer at TI, where he develops applications for the TM4C12x family of high-performance microcontrollers. Amit brings to this role his extensive experience and expertise in high-speed digital and microcontroller system-level design. Amit earned his Bachelor of Engineering (BE) from the University of Pune in India.

修订历史记录

注：之前版本的页码可能与当前版本有所不同。

Changes from April 7, 2015 to February 1, 2019	Page
• 对文档进行了通篇编辑、格式和布局更改	1
• Removed link to layout prints (not available).....	18
• Removed link to Altium project (not available).....	18
• Removed link to assembly drawings (not available)	18
• Updated related documentation links	18

重要声明和免责声明

TI“按原样”提供技术和可靠性数据（包括数据表）、设计资源（包括参考设计）、应用或其他设计建议、网络工具、安全信息和其他资源，不保证没有瑕疵且不做任何明示或暗示的担保，包括但不限于对适销性、某特定用途方面的适用性或不侵犯任何第三方知识产权的暗示担保。

这些资源可供使用 TI 产品进行设计的熟练开发人员使用。您将自行承担以下全部责任：(1) 针对您的应用选择合适的 TI 产品，(2) 设计、验证并测试您的应用，(3) 确保您的应用满足相应标准以及任何其他功能安全、信息安全、监管或其他要求。

这些资源如有变更，恕不另行通知。TI 授权您仅可将这些资源用于研发本资源所述的 TI 产品的应用。严禁对这些资源进行其他复制或展示。您无权使用任何其他 TI 知识产权或任何第三方知识产权。您应全额赔偿因在这些资源的使用中对 TI 及其代表造成的任何索赔、损害、成本、损失和债务，TI 对此概不负责。

TI 提供的产品受 [TI 的销售条款](#) 或 [ti.com](#) 上其他适用条款/TI 产品随附的其他适用条款的约束。TI 提供这些资源并不会扩展或以其他方式更改 TI 针对 TI 产品发布的适用的担保或担保免责声明。

TI 反对并拒绝您可能提出的任何其他或不同的条款。

邮寄地址：Texas Instruments, Post Office Box 655303, Dallas, Texas 75265

Copyright © 2022，德州仪器 (TI) 公司