

设计指南: TIDA-00494 使用 Sharp® LCD 实现的穿透玻璃触控参考设计



说明

作为人与机器交互的主要方式之一, 人机界面 (HMI) 是制炼厂的基本组成部分。TIDA-00494 参考设计为环境恶劣且危险的区域应用提供了 HMI 解决方案。在制炼厂中, 操作人员需要通过液晶显示器 (LCD) 与封装在拧紧式防爆金属外壳中的键盘交互进行编程, 该外壳具有用于本地读取的厚玻璃窗口。

TIDA-00494 TI 设计使用了采用 TI CapTivate™ 技术的 MSP430™ 微控制器 (MCU)。借助此参考设计, 操作人员无需打开外壳即可与控制器交互, 通过省去开工许可或避免工厂停工节省了时间, 而且可以从 LCD 读取结果并通过只包含一个集成电路 (IC) 的发光二极管 (LED) 接收通知。

资源

TIDA-00494	设计文件夹
MSP430FR2633	产品文件夹
CapTivate	产品文件夹



咨询我们的 E2E 专家

特性

- 单步和多步按钮
- 实施了四个强大的按钮选项
- 四个 LED 提供反馈
- 超低功耗 LCD
- 按钮与玻璃之间具有可变气隙 (1 至 2mm)
- 通过厚玻璃进行手指检测 (8 至 12mm)
- 工作时可佩戴手套, 并能够适应恶劣的环境 (水、油、灰尘等)
- 温度范围: -40°C 至 85°C

应用

- HMI
- 过程控制
- 场发射器
- 场传动器

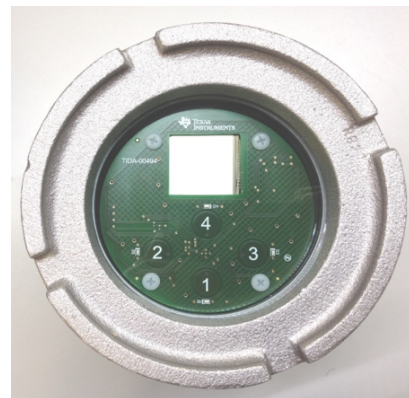
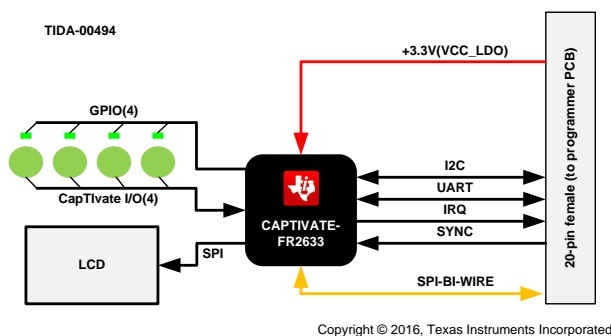

该 TI 参考设计末尾的重要声明表述了授权使用、知识产权问题和其他重要的免责声明和信息。

1 System Overview

1.1 System Description

The TIDA-00494 is an HMI system that features a four-button keypad for programming functions, four LEDs for feedback, and an ultra-low-power LCD for readouts. Everything is controlled by the MSP430FR2633, a FRAM-based ultra-low-power MSP microcontroller (MCU) that features CapTIvate touch technology, which processes the button's touch, drives the LEDs, and shows the results on the LCD.

The complete system offers a solution for harsh or difficult hazardous area applications in process plants that require operators to interact with a keypad for programming functions, encapsulated in explosive proof screw-on metallic enclosures with thick glass windows for local readouts through an LCD.

The CapTIvate technology in this TI Design allows the operator to interact with the keypad without requiring operators to open the enclosure, which saves time by avoiding a work permit or plant shutdown.

The CapTIvate technology provides high-resolution capacitive-touch sensing, which allows touching a button through the thick glass window while offering high reliability and noise immunity at the lowest power.

1.2 Key System Specifications

表 1. Key System Specifications

PARAMETER	SPECIFICATION	DETAILS
Glass thickness	9.5 mm	See 2.2 节
Glass diameter	80 mm	See 2.2 节
Air gap	1 to 2 mm	See 2.4 节
Number of buttons	Four	See 2.4 节
Feedback	LED	—
Ultra-low-power LCD	LS013B4DN04	See 2.3 节
Work with gloves	—	See 节 4.2.2
Harsh environment resistant	—	See 4.2 节
SNR	—	See 4.2 节
Crosstalk	—	See 4.2 节
Low power (\approx 10-Hz scan rate)	240 μ A (average)	—
Temperature range	-40°C to 85°C	—

1.3 Block Diagram

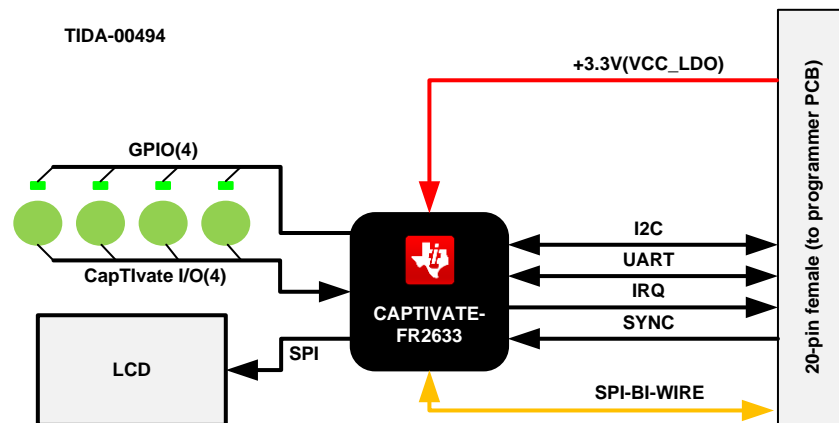

Copyright © 2016, Texas Instruments Incorporated

图 1. TIDA-00494 Block Diagram

1.4 Highlighted Products

The key part of the TIDA-00494 system design is the MSP430FR2633 MCU, which allows capacitive sensing by pressing a button, even through the thick glass. Implementing CapTivate technology enables the capacitive touch sensing capabilities of the MSP430FR2633 MCU. The MSP430FR2633 is able to drive LEDs and LCD thanks to its additional GPIOs and SPI and is powered and programmed through the 20-pin female connector by the CAPTIVATE-PGMR Programmer PCB.

The MSP430FR2633 MCU communicates with a dedicated USB HID Bridge MCU located on the CAPTIVATE-PGMR PCB using UART or I²C communication to send sensor data and status to the CapTivate Design Center as part of the sensor design and tuning process. A compact communications protocol is provided as part of the CapTivate™ software library along with UART and I²C drivers. Both drivers are located in the MSP430FR2633 ROM to minimize the impact on the FRAM memory footprint.

When used with CapTivate protocol, the UART operates in a full-duplex mode using RX and TX pins, and the I²C operates as an I²C slave using SDA and SCL pins with an additional pin P1.2/IRQ to generate interrupt requests.

1.4.1 MSP430FR2633

The MSP430FR2633 is a FRAM-based ultra-low-power MSP microcontroller that feature CapTivate touch technology for buttons, sliders, wheels (BSW), and proximity applications. CapTivate technology provides the highest resolution capacitive-touch solution in the market with high reliability and noise immunity at the lowest power. CapTivate technology supports concurrent self-capacitance and mutual-capacitance electrodes on the same design for maximum flexibility. Using the CapTivate Design Center, engineers can quickly develop BSW applications with an easy-to-use GUI.

The TI MSP family of low-power MCUs consists of several devices that feature different sets of peripherals targeted for various applications. The architecture, combined with extensive low-power modes, is optimized to achieve extended battery life in portable measurement applications. The MCU features a powerful 16-bit RISC CPU, 16-bit registers, and constant generators that contribute to maximum code efficiency. The digitally controlled oscillator (DCO) allows the MCU to wake up from low-power modes to active mode typically in less than 10 μs.



图 2. MSP430FR2633 Functional Block Diagram

Features:

- Embedded MCU
 - 16-bit RISC architecture
 - Clock supports frequencies up to 16 MHz
 - Wide supply voltage range from 1.8 to 3.6 V ⁽¹⁾
- Optimized ultra-low-power modes
 - Active mode: 126 μ A/MHz (typical)
 - Standby:
 - 1.7 μ A/button average (typical) (16 self-capacitance buttons, 8-Hz scanning)
 - 1.7 μ A/button average (typical) (64 mutual-capacitance buttons, 8-Hz scanning)
 - LPM3.5 real-time clock (RTC) counter with 32,768-Hz crystal: 770 nA (typical)
 - Shutdown (LPM4.5): 15 nA (typical)
- Low-power ferroelectric RAM (FRAM)
 - Up to 15.5KB of nonvolatile memory
 - Built-in error correction code (ECC)
 - Configurable write protection
 - Unified memory of program, constants, and storage
 - 10^{15} write cycle endurance
 - Radiation resistant and nonmagnetic
 - High FRAM-to-SRAM ratio, up to 4:1

⁽¹⁾ Minimum supply voltage is restricted by SVS levels

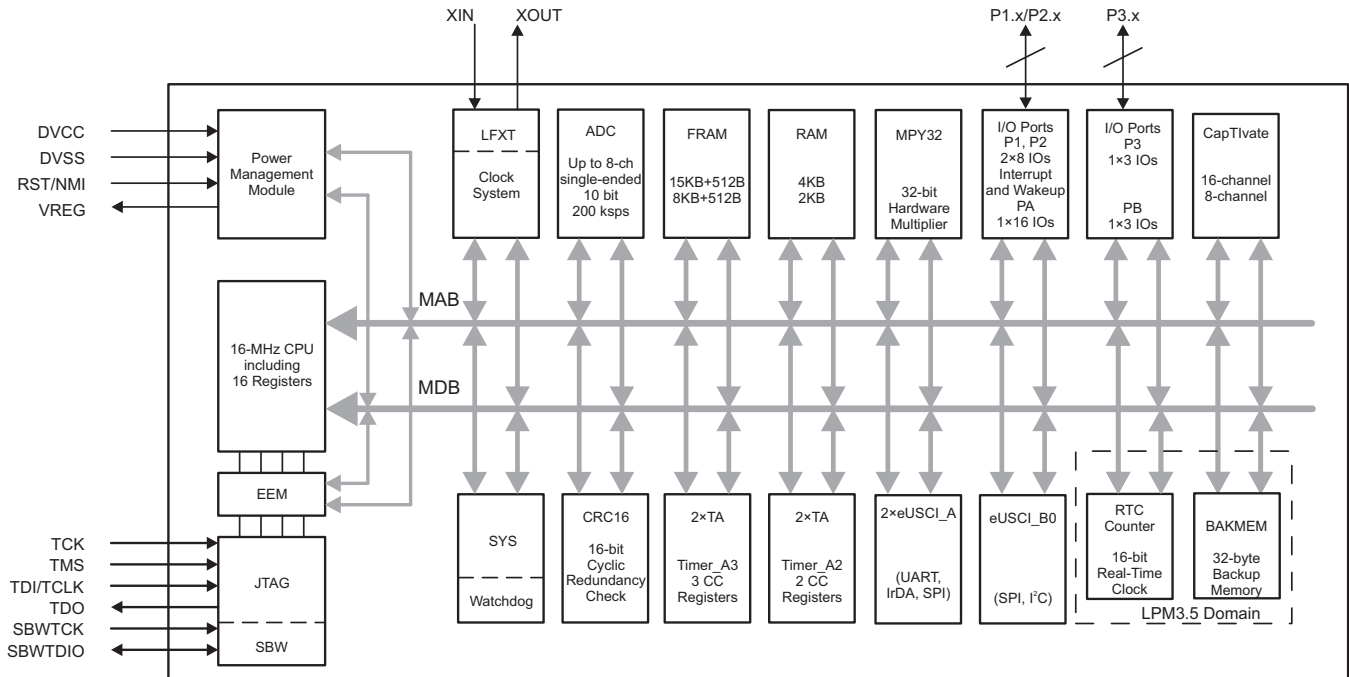
- Intelligent digital peripherals
 - Four 16-bit timers
 - Two timers with three capture/compare registers each (Timer_A3)
 - Two timers with two capture/compare registers each (Timer_A2)
 - One 16-bit timer associated with CapTIvate technology
 - One 16-bit counter-only RTC
 - 16-bit cyclic redundancy check (CRC)
- Enhanced serial communications
 - Two enhanced universal serial communication interfaces (eUSCI_A) support UART, IrDA, and SPI
 - One eUSCI (eUSCI_B) supports SPI and I²C
- High-performance analog
 - 8-channel 10-bit analog-to-digital converter (ADC)
 - Internal 1.5-V reference
 - Sample-and-hold 200 ksps
 - [CapTIvate Technology](#)—Capacitive touch
 - Performance
 - Fast electrode scanning with four simultaneous scans
 - Support for high-resolution sliders with > 1024 points
 - 30-cm proximity sensing
 - Reliability
 - Increased immunity to power line, RF, and other environmental noise
 - Built-in spread spectrum, automatic tuning, noise filtering, and debouncing algorithms
 - Enables [Reliable Touch Solutions](#) with 10-V_{RMS} common-mode noise, 4-kV electrical fast transients, and 15-kV electrostatic discharge, allowing for IEC-61000-4-6, IEC-61000-4-4, and IEC-61000-4-2 compliance
 - Reduced RF emissions to simplify electrical designs
 - Support for metal touch and water rejection designs
 - Flexibility
 - Up to 16 self-capacitance and 64 mutual-capacitance electrodes
 - Mix and match [self- and mutual-capacitive electrodes in the same design](#)
 - Supports multi-touch functionality
 - Wide range of capacitance detection, wide electrode range of 0 to 300 pF
 - Low power
 - <0.9 μA/button in wake-on-touch mode, where capacitive measurement and touch detection is done by hardware state machine while CPU is asleep
 - Wake-on-touch state machine allows electrode scanning while CPU is asleep
 - Hardware acceleration for environmental compensation, filtering, and threshold detection
 - Ease of use

- [CapTlvate Design Center](#), PC GUI lets engineers design and tune capacitive buttons in real time without having to write code
- CapTlvate software library in ROM provides ample FRAM for customer application

- Clock system (CS)
 - On-chip 32-kHz RC oscillator (REFO)
 - On-chip 16-MHz digitally controlled oscillator (DCO) with frequency-locked loop (FLL)
 - $\pm 1\%$ accuracy with on-chip reference at room temperature
 - On-chip very low-frequency 10-kHz oscillator (VLO)
 - On-chip high-frequency modulation oscillator (MODOSC)
 - External 32-kHz crystal oscillator (LFXT)
 - Programmable MCLK prescaler of 1 to 128
 - SMCLK derived from MCLK with programmable prescaler of 1, 2, 4, or 8
- General input/output and pin functionality
 - Total of 19 I/Os on TSSOP-32 package
 - 16 interrupt pins (P1 and P2) can wake MCU from low-power modes
- Development tools and software
 - Ease-of-use ecosystem
 - CapTIvate design center—code generation, customizable GUI, real-time tuning
 - Free professional development environments
- 12-KB ROM library includes CapTIvate touch libraries and driver libraries
- Package options
 - 32-pin: VQFN (RHB)
 - 32-pin: TSSOP (DA)
 - 24-pin: VQFN (RGE)
 - 24-pin: DSBGA (YQW)

For a complete module description, see the *MSP430FR4xx and MSP430FR2xx Family User's Guide* ([SLAU445](#)).

2 System Design Theory

The TIDA-00494 is designed to fit in an explosive-proof enclosure as the one showed in 2.2 节. The PCB has four buttons displaced according to certain rules (see 2.4 节), four LEDs, and one display (see 2.3 节) to indicate the buttons status. Everything is controlled by the MSP430FR2633 that can be programmed and debugged by the CAPTIVATE-PGMR PCB, found in the MSP CapTivate MCU Development Kit, which is needed as well to collect data and display them on the MSP CapTivate Design Center GUI.

Once the MSP430FR2633 is programmed, the board could be used even without CAPTIVATE-PGMR PCB and be powered externally (see 3 节).

2.1 Mechanical Design

Designing the TIDA-00494 requires attention to a few key mechanical details. Note that the board is to be housed in a screw-on metallic enclosure (see 2.2 节), which can be removed by unscrewing the top unit. In order to prevent any interference with the electronics when the user removes the enclosure, the electrodes board must not be in direct contact with the glass window. The distance between the window glass and the electrode board can vary depending on the application.

TI recommends keeping the TIDA-00494 as close as possible to the glass window for better performance (See 2.4 节 and 4.2 节).

2.2 Explosion-Proof Enclosure

The TIDA-00494 design uses an explosion-proof enclosure made of stainless steel with a 9.5-mm thick glass window. 图 3 shows the mechanical specifications of this enclosure.



图 3. Explosion-Proof Enclosure

The enclosure is big enough to contain the electronics and has a hole on the bottom side that allows the user to wire the USB cable or any other cable, which are used to power the board and acquire data from the sensors.

The enclosure must be grounded. If the enclosure is floating, a touch on it may couple together all of the buttons and cause a false detection.

However, the buttons closer to the enclosure or any conductive surface that is tied at a fixed potential are less sensitive than the other buttons because the grounded enclosure pulls in the electric field, which limits the field above the glass in the desired area of interaction. This behavior can be improved through an optimized board layout (see 5.3 节).

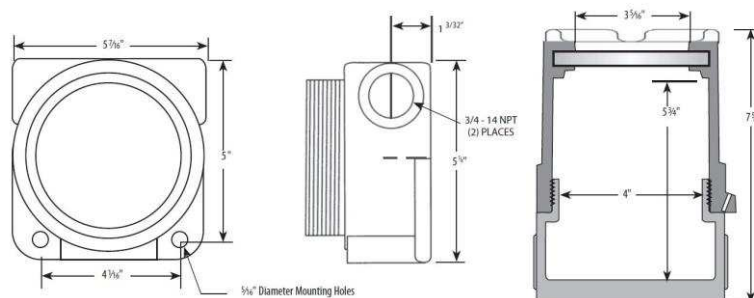
2.3 Ultra-Low-Power LCD

The Sharp Microelectronics LS013B4DN04 1.35-inch PNLC Memory LCD[6] is loaded with features that deliver a display capable of smooth-moving graphics with 50% reflectance and low power use of 10 μ W. The LCD is visible in a 0.5-lux environment without requiring a light source.

Main features of the LCD include:

- Reflective panel of white and black with aspect ratio of 1:1
- 1.3-inch screen has 96x96 resolution (9216 pixels stripe array)
- Display control by serial data signal communication (SPI)
- Typical power consumption 6 μ W (static mode, depends on update rate)

表 2 shows the input terminals and functions of the LCD:

表 2. Sharp LS013B4DN04 Display Connections

PIN	SYMBOL	FUNCTION
1	SCLK	Serial clock signal
2	SI	Serial data input signal
3	SCS	Chip select signal
4	EXTCOMIN	External COM inversion signal input High = Enabled Low = Serial input flag enabled
5	DISP	Display on or off signal
6	VDDA	Power supply (analog)
7	VDD	Power supply (digital)
8	EXTMODE	COM inversion select terminal
9	VSS	GND (digital)
10	VSSA	GND (analog)

2.4 Electrode Design

The definition of the electrodes diameter and shape is a tradeoff between obtaining the maximum sensitivity (see [公式 1](#)) and respect the mechanical constraints of such application.

$$C = \epsilon_r \times \epsilon_0 \times \frac{A}{d} \quad (1)$$

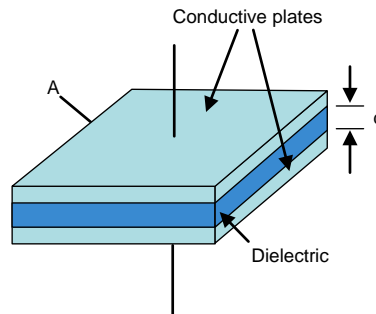

Copyright © 2016, Texas Instruments Incorporated

图 4. Parallel Plate Capacitor

The area of the button must be as big as possible or at least the same size of the average finger press for a higher sensitivity. The button diameter of the TIDA-00494 is equal to 10 mm, which is a bit smaller than the average finger press of an operator and is limited by the mechanical constraints of the application.

This application typically requires using a glass window with a diameter that spans from 4 to 12 cm and contains three to six buttons, which are usually placed behind the glass on the lower section. In this setup, the space for each button is approximately 1 to 2 cm without accounting for the minimum distance required between the buttons, which is fundamental to avoiding crosstalk, and the space occupied by the MCU, LED, and passives in the printed circuit board (PCB).

A medium-sized enclosure has an 8-cm glass window diameter and a four-button application. To account for the application requirements of this design, the TIDA-00494 has four buttons with a 10-mm diameter.

As [2.1 节](#) explains, it is important to place the buttons a certain distance from the metallic enclosure. The buttons must also be placed as far from each other as possible to avoid crosstalk, which increases as the air gap between the glass and buttons increase. Note that the dielectric of this application is not negligible (see [图 5](#)).



图 5. Application Stackup

Every 1 mm of air gap is equivalent to 7 to 8 mm of glass (see 表 3). So with a glass thickness of 10 mm, the actual stackup consists of approximately 25 to 30 mm of glass. This ratio of materials affects the sensitivity of the buttons as well.

表 3. Dielectric Material

MATERIAL	DIELECTRIC CONSTANT (ϵ_r)
Air	1
FR-4	4.8
Glass	7.6 to 8
Nylon	3.2 to 5
Alumina (96%)	10
Plexiglass	2.2 to 3.4
Water	76.7 to 78.2

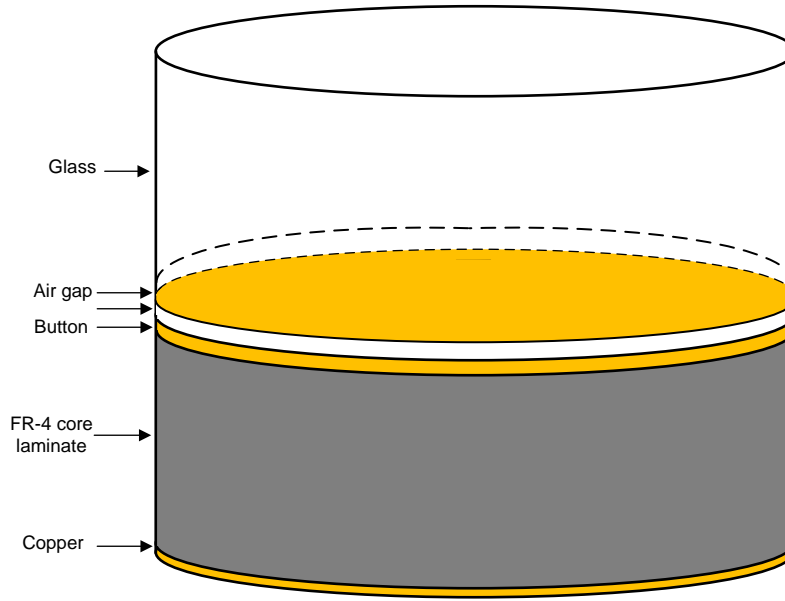
图 6 shows the configuration of the buttons.

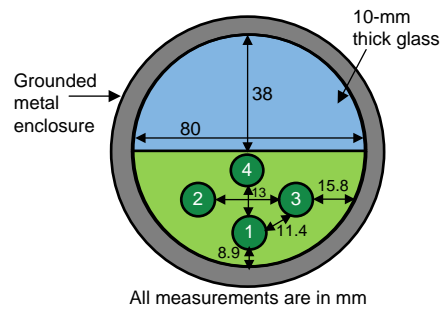

All measurements are in mm

Copyright © 2016, Texas Instruments Incorporated

图 6. Button Configuration

This configuration allows the user to test how the crosstalk varies among the buttons and how the metal enclosure influences the different buttons.

The TIDA-00464 design utilizes buttons known as self-capacitance buttons.

2.4.1 Self Capacitive Buttons

A self capacitive button sensor is a single electrode. Self capacitive buttons are simple to layout and each button is assigned to only one pin on the MCU. Self capacitive buttons will provide greater sensitivity as compared to a mutual capacitive button, but are more influenced by parasitic capacitances to ground.

表 4. Self-Capacitive Button Properties

PARAMETER	GUIDANCE
Radiation pattern	Between electrode and ground
Size	Equivalent to iteration
Shape	Various: typically round or square
Spacing	0.5 x overlay minimum thickness



图 7. Self Capacitive Button Designs Example

2.4.1.1 Self Capacitive Button Shapes

The electrode shape is typically rectangular or round with common sizes of 10 and 12 mm. Ultimately, the size will depend on the required touch area. A good design practice is to keep the size of the button as small as possible, which minimizes the capacitance and will help with the following:

- Reduce susceptibility to noise
- Improve sensitivity
- Lower power operation due to smaller capacitance and reduced electrode scan time

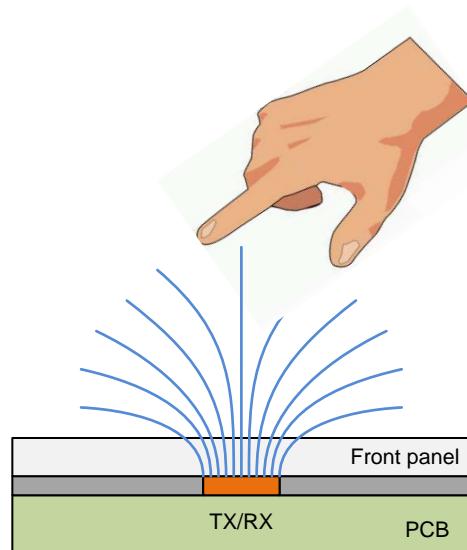
图 8 shows an example of a silkscreen button outline pattern.



图 8. Silkscreen-Button Outline Pattern

The goal of the button area is to provide sufficient signal when the user touches the overlay above the button electrode. Typically, a nonconductive decal or ink is used to identify the touch area above the electrode. The relationship between the decal and the electrode can be varied so that contact with the outer edge of the decal registers a touch. Conversely, the electrode could be small to ensure that the button is activated only when the center of the decal is touched. 图 9 and 图 10 show how the effective touch area is a function of the electrode size and the size of the finger.



图 9. Effective Area Example for Electrodes Larger Than Decal



图 10. Effective Area Example for Electrode Smaller Than Decal

One common mistake is to make the electrode the same shape as the icons printed (in nonconductive ink) on the overlay. As shown in 图 11, this can lead to electrodes with odd shapes that create discontinuities and reduce surface area.

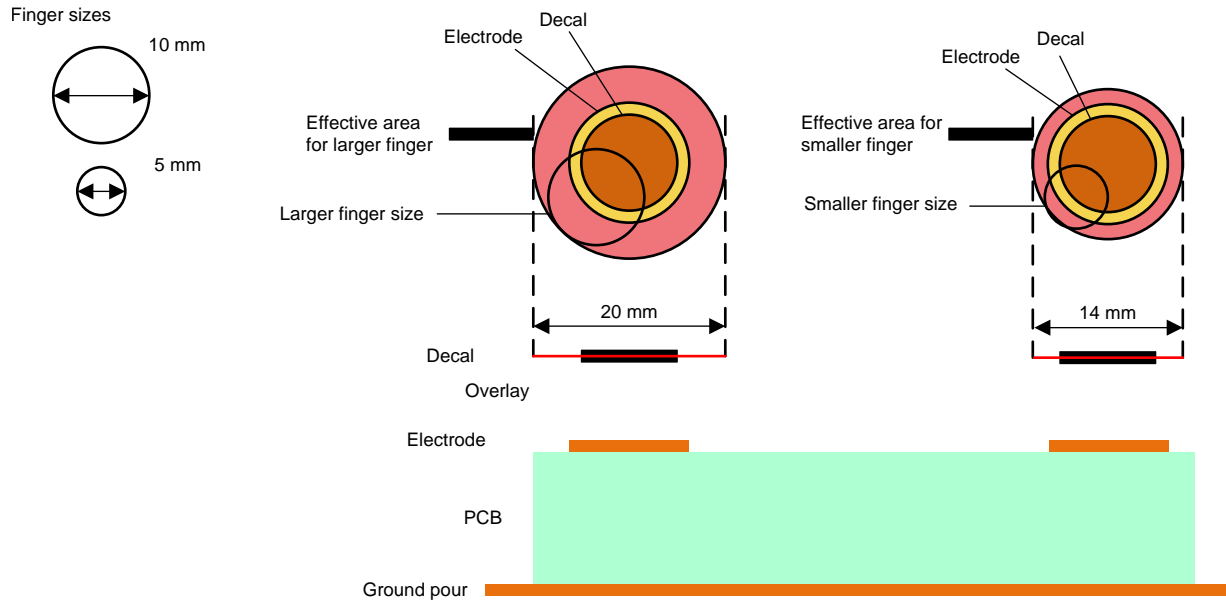

图 11. Button Shape Examples, Dos and Don'ts

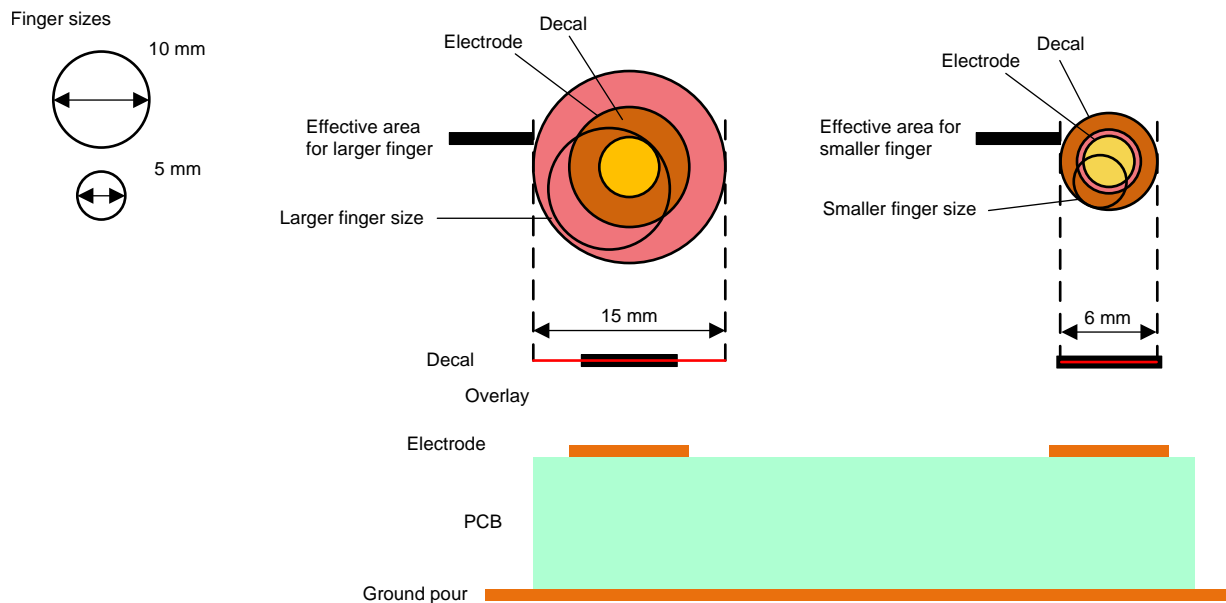
As the distance of the overlay increases, the effective area decreases. Therefore, it is important to keep the button electrode diameter at least three times the laminate thickness.

3 Getting Started Hardware and Firmware

3.1 Hardware

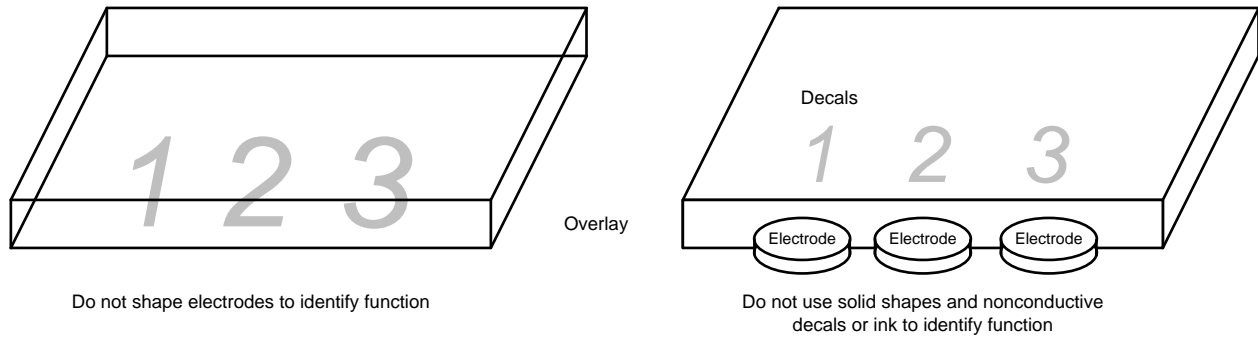
Implement the following steps to set up the demo:

1. Power the TIDA-00494 through pin 3 of the connector J1 with 3.3 V. Connect the ground to pin 1 of the same connector as shown in [图 12](#).



图 12. Hardware Demo Setup

2. Use plastic spacers to elevate the board from the floor up to the glass. The length of the spacers depends on the height of the used enclosure (see [图 14](#)).
3. Use screws, nuts, spacers, or bumpers to establish a defined air gap between the glass window and the board (see [图 14](#)).
4. Place the TIDA-00494 inside the enclosure with the electrodes facing the glass window, as [图 15](#) shows.

For data acquisition and debug services, the CAPTIVATE-PGMR programmer PCB available with the CapTivate Design Kit is needed.

Implement the following steps to set up the hardware:

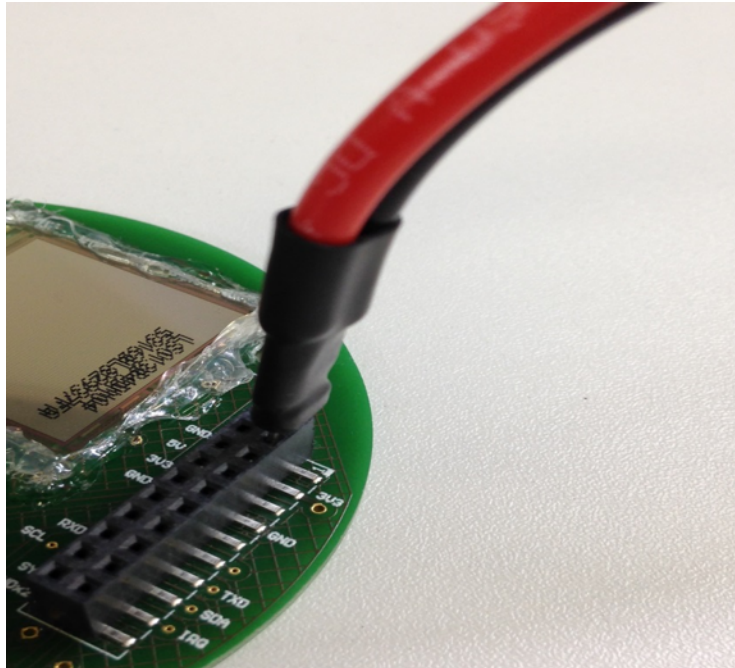
1. Connect the TIDA-00494 to the CAPTIVATE-PGMR PCB in order to debug or program it and to collect and visualize the data through CapTivate Design Center GUI. For more information about the CAPTIVATE-PGMR PCB, visit the Hardware section of the CapTivate Technology Guide (see [图 13](#)).



图 13. TIDA-00494 Connected to the CAPTIVATE-PGMR PCB

2. Connect the CAPTIVATE-PGMR PCB through a micro-USB cable to the PC (see [图 14](#)).
3. Use plastic spacers to elevate the board from the floor up to the glass. The length of the spacers depends on the height of the used enclosure (see [图 14](#)).
4. Use screws, nuts, spacers, or bumpers to establish a defined air gap between the glass window and the board (see [图 14](#)).



图 14. TIDA-00494 Connected to the PC, Ready for Data Acquisition and Debugging

5. Place the TIDA-00494 inside the enclosure with the electrodes facing the glass window, as 图 15 shows.

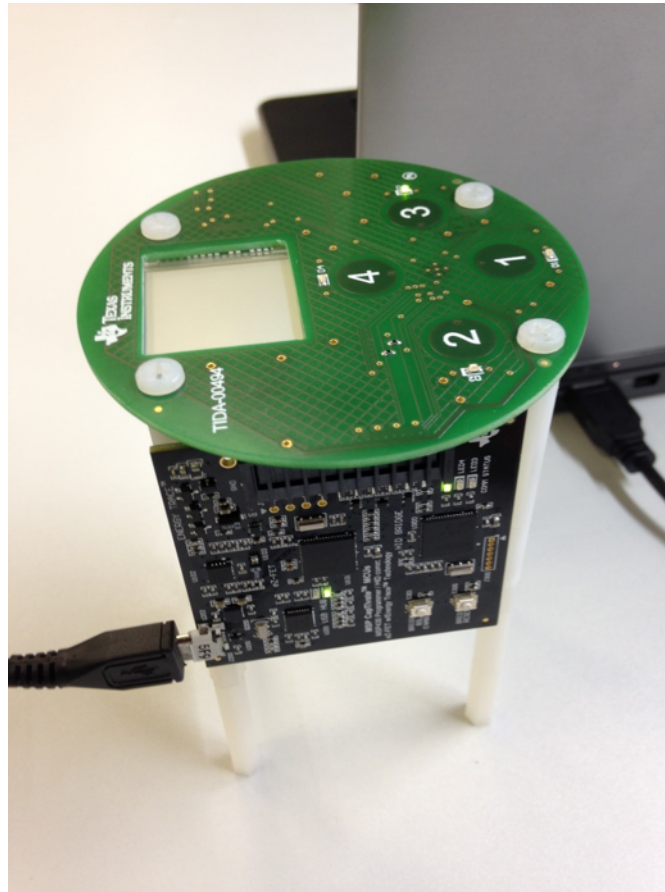

图 15. TIDA-00494 Final Test Setup

3.2 Firmware

To download the software files for this reference design, please see the link at <http://www.ti.com/tool/TIDA-00494>.

The TIDA-00494 ships pre-programmed with demo software where each buttons press corresponds to a light-up LED and a confirmation string in the display.

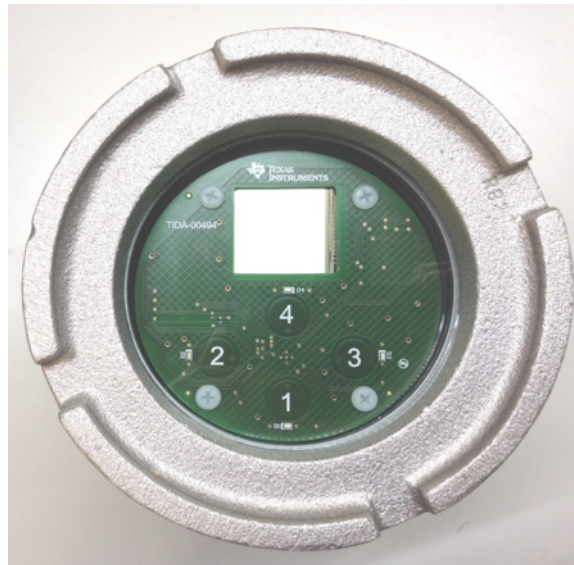
For data acquisition and debug services, the CAPTIVATE-PGMR programmer PCB available with the CapTlvate Design Kit is needed.

Once the CAPTIVATE-PGMR programmer PCB is connected to the TIDA-00494 and to the PC (see 3 节), it is possible through Code Composer Studio™ (CCS) and the CapTlvate Design Center GUI to acquire data, debug the software, and modify it according to the needs of your application. To install CCS and the CapTlvate Design Center GUI and learn how to use them, look at the "Getting Started with the MCU Development Kit" section of the CapTlvate Technology Guide.

4 Testing and Results

4.1 Test Setup

The TIDA-00494 and the CAPTIVATE-PGMR PCB must be connected as outlined in 3 节 and then contained in the explosive-proof enclosure. A USB wire is the only object that is allowed to protrude from the enclosure and this USB must be connected to a laptop, which uses the CapTlvate Design Center GUI to acquire the sensor data.

Adjusting the conversion gain and the conversion count is an important step that the user can control in the CapTlvate Design Center. Adjust these properties by opening the ButtonGroupSensor properties with a double-click on the button group icon and then navigating to the Conversion_Control tab.

The conversion gain and conversion count are the fundamental parameters used to establish the performance of the sensor. These parameters determine the resolution, sensitivity, and required conversion time.

The TIDA-00494 design has a conversion gain count equal to 1400 and a conversion gain equal to 200. Increasing the strength of the infinite impulse response (IIR) filter to improve the signal-to-noise ratio (SNR) is also possible. This property is controlled by the Count Filter Beta parameter located in the Tuning tab for each sensor.

The TIDA-00494 design has a count filter beta set to 3.

The following tests were performed:

- Touch
- Touch with gloves
- False touch

In each test, 1000 samples were taken while pressing a button, and 1000 samples were taken without performing any action. The sampling was followed by calculating the SNR and crosstalk among the buttons.

The diagram in 图 16 can be used to show the results if considering a normal distribution for the touch event and untouched event:



图 16. Event Distribution (SNR) With and Without Touch

TouchedAVG_B1 is the average of 1000 sample while pressing button 1.

$$\text{Touched}_{\text{AVG},B1} = \frac{\sum_{n=0}^{\text{Sample size}} \text{Touched}_{B1}[n]}{\text{Sample size}} \quad (2)$$

Untouched_{AVG}_B1 is the average of 1000 samples without any button presses.

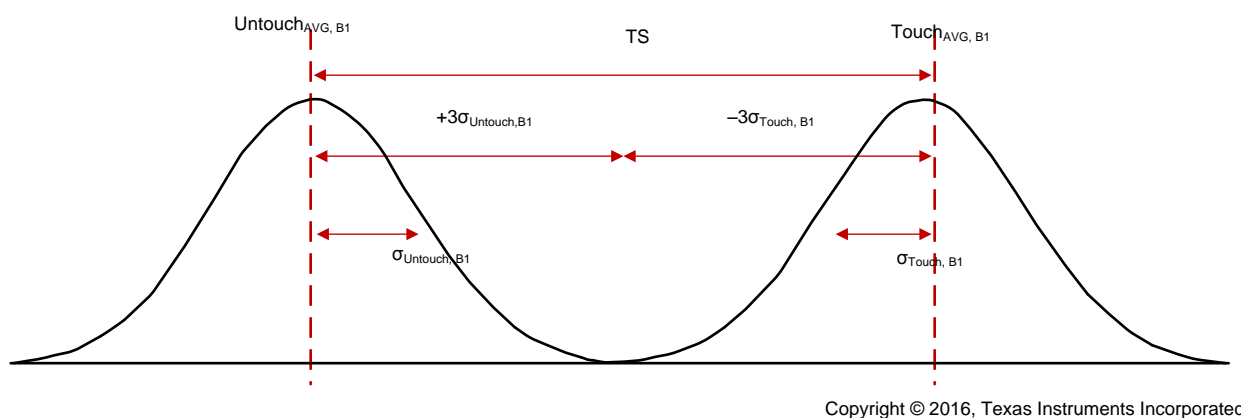
$$\text{Untouched}_{\text{AVG},B1} = \frac{\sum_{n=0}^{\text{Sample size}} \text{Untouched}_{B1}[n]}{\text{Sample size}} \quad (3)$$

表 5 shows the SNR and the probability of a false event as a function of the number of σ .

表 5. SNR and Probability of False Event in Function of Number of σ

$z\sigma$	SNR (dB)	PROBABILITY OF FALSE EVENT
1σ	0	31.73%
2σ	6	4.55%
3σ	9.5	0.27%
4σ	12	60 ppm
5σ	14	0.57 ppm

To achieve a 0.27% probability of a false event, ensure that $\text{Touched}_{\text{AVG},B1}$ minus $3\sigma_{\text{TOUCH},B1}$ is bigger than $\text{Untouched}_{\text{AVG},B1}$ plus $3\sigma_{\text{Untouch},B1}$:

$$T_{\text{AVG},B1} - 3\sigma_{\text{Touch},B1} > U_{\text{AVG},B1} + 3\sigma_{\text{Untouch},B1} \quad (4)$$

where

$$\sigma_{\text{Touch},B1} = \sqrt{\left(\frac{\sum_{n=0}^{\text{Sample size}} (\text{Touched}_{B1}[n] - \text{Touched}_{\text{AVG},B1})^2}{\text{Sample size}} \right)} \quad (5)$$

$$\sigma_{\text{Untouch},B1} = \sqrt{\left(\frac{\sum_{n=0}^{\text{Sample size}} (\text{Untouched}_{B1}[n] - \text{Untouched}_{\text{AVG},B1})^2}{\text{Sample size}} \right)} \quad (6)$$

The calculations from 公式 4 can be further simplified in 公式 7:

$$T_{\text{AVG},B1} - U_{\text{AVG},B1} > 3(\sigma_{\text{Untouch},B1} + \sigma_{\text{Touch},B1}) \Rightarrow \frac{T_{\text{AVG},B1} - U_{\text{AVG},B1}}{\sigma_{\text{Untouch},B1} + \sigma_{\text{Touch},B1}} > 3 \quad (7)$$

Define the touch strength (TS) in 公式 8 using the previous calculations from 公式 7:

$$\text{Touch strength (TS)} = \text{Untouched}_{\text{AVG},B1} - \text{Touched}_{\text{AVG},B1} \quad (8)$$

Calculate the SNR in dB in 公式 7:

$$\text{SNR(dB)} = 20 \times \log\left(\frac{\text{TS}}{\sigma_{\text{Untouch},B1} + \sigma_{\text{Touch},B1}}\right) > 9.5 \text{ dB} \quad (9)$$

To ensure that the probability of a button being touched is equal to 99.73%, the SNR must be greater than 9.5 dB (see 表 5).

The method for calculating the crosstalk is similar to that of the SNR; however, this method considers the average of 1000 samples of a button while touching a nearby button (see 图 17).



图 17. Event Distribution (Crosstalk) With and Without Touch

In 图 17, $\text{Touch}_{\text{AVG}, \text{B1}}$ is equal to the average of 1000 samples while the button 1 is pressed, and $\text{Untouch}_{\text{AVG}, \text{B2}}$ is equal to the average of 1000 samples of button 2 while the button 1 is pressed. 公式 10 shows how to calculate the crosstalk:

$$\text{Crosstalk}_{\text{B1}, \text{B2}} (\text{dB}) = 20 \times \log \left(\frac{\text{TS}}{\sigma_{\text{Untouch}, \text{B2}} + \sigma_{\text{Touch}, \text{B1}}} \right) > 9.5 \text{ dB} \quad (10)$$

To ensure that the probability of an unintentional button touch is equal to 0.27%, the crosstalk must be greater than 9.5 dB (see 表 5). See 公式 5, 公式 6, and 公式 8 for calculating TS, $\sigma_{\text{Untouch}, \text{B2}}$, and $\sigma_{\text{Untouch}, \text{B1}}$.

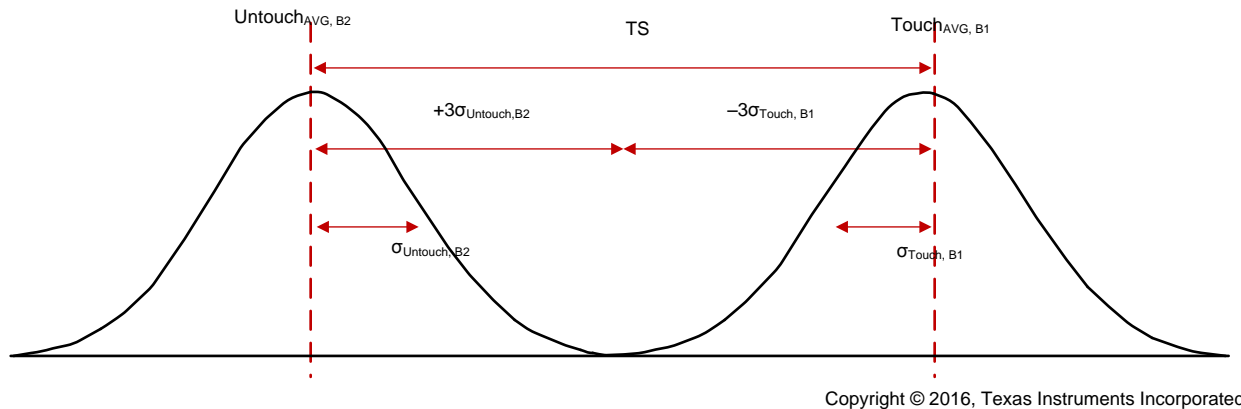
The air gap between the glass window and the buttons varies in each test from 1 to 2 mm. Decrease the proximity and touch threshold in the Tuning tab of the ButtonGroupSensor properties as the air gap increases.

4.2 Test Data

4.2.1 Touch

This test measures the SNR and crosstalk for each button while using a human finger to press the button.



图 18. Touch Test

表 6 and 图 19 show how the SNR decreases as the air gap increases. Note that these results can be improved by enabling the noise immunity features (frequency hopping, oversampling, dynamic threshold adjustment).

Note that button 2 has a lower SNR with respect to the other buttons because the signal trace of button 2 crosses several digital traces (see 5.3 节 for more details).

表 6. Finger Touch—SNR (dB)

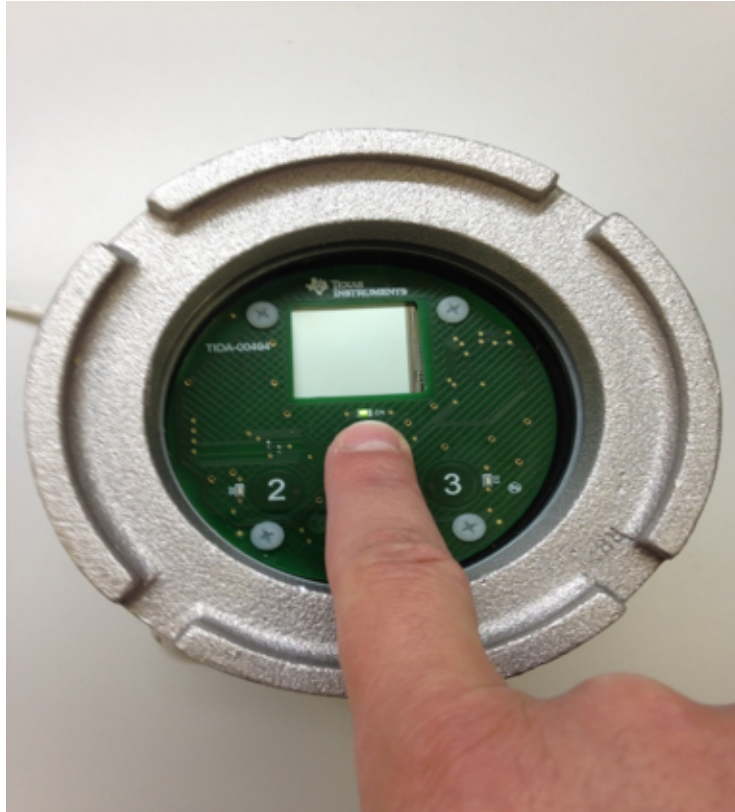
AIR GAP (mm)	B1	B2	B3	B4
1	16	14	18	17
2	11	9	12	12



图 19. Finger Touch—SNR

The crosstalk has a similar behavior to that of the SNR: it decreases as the air gap increases. 表 7 shows the obtained results:

表 7. Finger Touch—Crosstalk

AIR GAP (mm)	UNTOUCHED BUTTONS	B1	B2	B3	B4
1	B1	—	11	12	13
	B2	15	—	14	14
	B3	19	16	—	18
	B4	17	14	15	—
2	B1	—	10	12	12
	B2	13	—	12	12
	B3	12	12	—	13
	B4	14	12	14	—

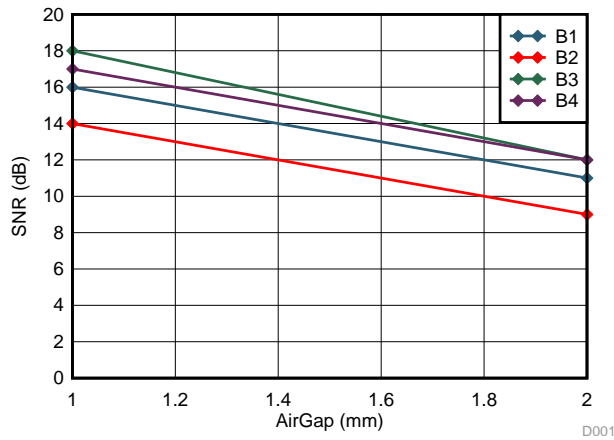
The crosstalk is measured for each button pressed. The best crosstalk results are obtained between button 3 and button 2 because they have the most distance between each other with respect to the other buttons (see 图 20).

图 20 shows the crosstalk results:



图 20. Finger Touch Crosstalk

4.2.2 Touch With Gloves

This test measures the SNR and crosstalk for each button, during which a human finger wearing a thick glove is used to press the button (图 21).

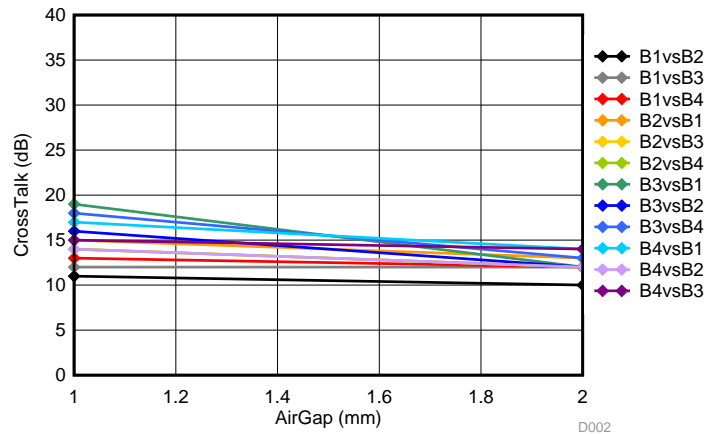

图 21. Touch With Gloves Test

This test shows a significant decrease in the measured SNR and crosstalk in comparison to the test results without a glove as a result of the thick fabric of the glove and its resistance to harsh environments.

Again, as for the touch test, the SNR of button 2 is lower due to the fact that the signal trace of button 2 cross several digital traces (see 5.3 节 for more details).

表 8. Finger Touch With Gloves—SNR

AIR GAP (mm)	B1	B2	B3	B4
1	12	10	14	13
2	11	9	12	11



图 22. Finger Touch With Gloves—SNR

表 9 shows the crosstalk values. At a 2-mm air gap, there are some values that are less than 9.5 dB, meaning that the touch of a button when wearing a glove could influence the nearby buttons. However, the results can be improved by implementing a data processing algorithm. One such example is to increase the sample rate, thereby also increasing the samples averaging.

表 9. Finger Touch With Gloves—Crosstalk

AIR GAP (mm)	UNTOUCHED BUTTONS	B1	B2	B3	B4
1	B1	—	7	7	7
	B2	9	—	10	9
	B3	12	11	—	13
	B4	12	10	10	—
2	B1	—	4	6	6
	B2	5	—	9	6
	B3	5	6	—	5
	B4	4	4	5	—

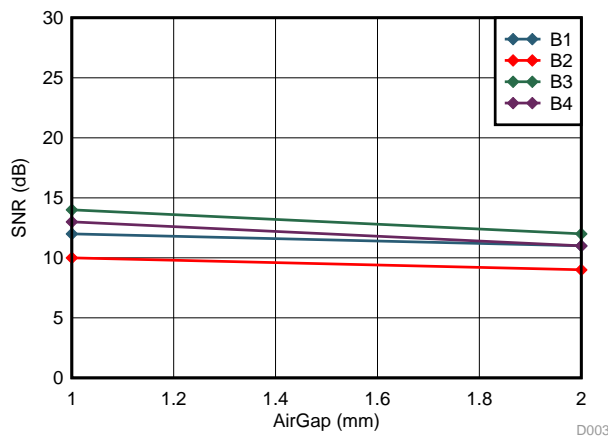

图 23. Finger Touch With Gloves—Crosstalk

4.2.3 False Touch

This test measures the SNR of the two buttons that are the closest to the false touch position and is performed by touching the point between two buttons, as 图 24 shows.

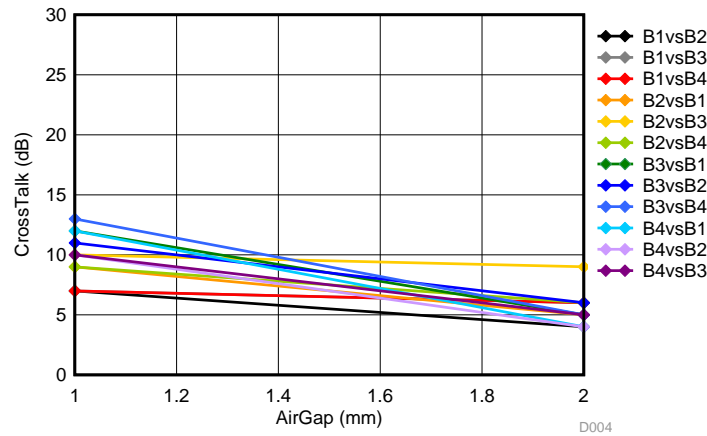
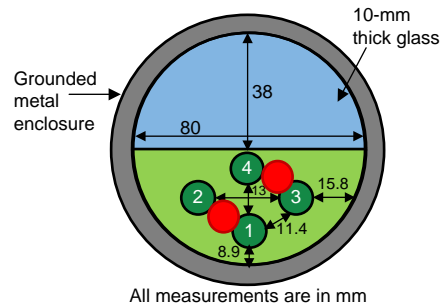

All measurements are in mm

Copyright © 2016, Texas Instruments Incorporated

图 24. False Touch Example

表 10 shows the results of the false-finger touch test:

表 10. False Touch—SNR

AIR GAP (mm)	B1-B2	B2-B4	B4-B3	B3-B1	B3-B2	B1-B4
1	14-13	14-14	19-19	15-16	10-12	15-19
2	6-6	9-13	15-10	11-10	8-4	8-14

In the false touch example, the measured SNR on button 1 and button 2 is 14 dB and 13 dB, respectively, when measuring with a 1-mm air gap (see 表 8). These values show that the SNR of button 1 and button 2 is lower during a false touch event in comparison to the values in 表 7 during a normal button touch event. This is enough to set a proper threshold to exclude the false touch event from the true event. Another way to address false touch events is to exclude them from the true events when the SNR of the two buttons is simultaneously high.

The same thing has been performed while wearing the firefighter glove, for which 表 11 shows the results.

表 11. False Touch With Gloves—SNR

AIR GAP (mm)	B1-B2	B2-B4	B4-B3	B3-B1	B3-B2	B1-B4
1	11-9	11-11	11-12	14-16	5-7	13-9
2	7-4	12-11	8-9	13-12	2-3	10-8

4.3 CapTivate Design Center SNR Tool

This section is an extension of the design that includes additional measurements and test results based on the SNR tool available in CDC V 1_80_00_xx.

This section will give an explanation of the test results and recommendations to ensure functional stability.

4.3.1 Tools and Test Description

The following tools were used for testing:

- CDC V 1_80_00_xx & SNR
- TIDA-0494 HW setup
 - Modifications: removed the resistors and LEDs from the TOP layer
 - Enclosure GND connected with the board
- Spacers between the bottom of the glass and the PCB

To test different scenarios, an air gap with a 0-, 1-, 2-, and 3-mm distance between an electrode and glass will be added. The test plans include:

- Double-sided tape used between an electrode and glass for the 0-mm tests
- Tests with an air gap of 1 mm without filler material
- Tests with an air gap of 1, 2, and 3 mm using conductive foam to bridge the gap
- Metal spring used to bridge the large air gap of 3 mm (no double-sided tape on top)
- Conductive foam (and spring) used to bridge the air gap of 12 mm

The following filler material was used for testing:

- Regular double-sided tape
- Conductive foam such as polyethylene foam filled with carbon and other materials such as black ESD foams
- Springs metal springs with a 7-mm x 7-mm top head



图 25. Springs and Filler Material



图 26. Test Setup

For the test execution, the PCB was placed directly under the glass. The distance was adjusted using spacers between the glass and the electrode.

To have reproducible results in the case of a 0-cm distance, double-sided tape was used to bridge the possible air gap between the electrode and glass surface.

4.3.2 Introduction to Design Margin and SNR Analysis

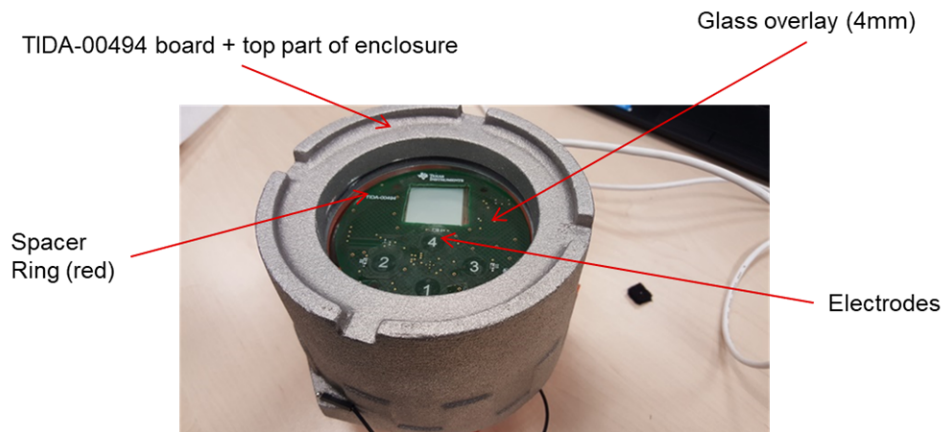
The detailed overview of the design margin and SNR analysis for capacitive touch applications can be seen in the [Sensitivity, SNR, and design margin in capacitive touch applications report](#). TI also provides an SNR analysis view within the CapTIvate Design Center development tool. This view can be used to perform a quick assessment of the robustness of a touch sensor by logging measurement data in the touched state and untouched state. This design was tested using the SNR tool in CapTIvate Design Center version 1.80.00.28

To ensure a stable and reliable operation, the system must be able to operate in situations where noise sources can be the device itself, RF, or any conductive noise. The SNR tool can measure the signal and noise levels and, considering the system settings, the recommended margins and limits. Based on the results, recommendations will be given on the system health to prevent false activations. When conducting these tests, it is important that the test environment is as close as possible to the expected environment of the end product. This means that all possible noise sources that the capacitive touch sensor may be exposed to during operation should be active during the measurements (for example, a motor, radio, the internal or external noise source, and so forth).

In the CapTIvate device family, two versions of the CapTIvate IP are available. Gen1 representing the basic IP implementation. Gen2 is an extension of the Gen1 with some modifications and extension and will be implemented in specific devices.

The differences between the two versions can be found in the [CapTIvate Technology Guide](#).

TI recommends using the CapTIvate Design Center development tool during the prototyping phase to measure the SNR and the resulting design margins for each touch sensor in the design. The SNR tool measures the *Signal (S)* and *Noise (N)* levels and calculates the detection threshold (T_h) and the design margins (*MarginIn* and *MarginOut*). These parameters indicate the ability of the design to handle additional noise due to device variation or external noise source.

The SNR test will initiate a series of measurements on the selected element (E00 in the following test) and update the results table.



图 27. SNR Tool

Advice will be given at the end of the test cycle, indicating whether the design has good or poor health.

Signal ('S') is the average percent change in capacitance due to a touch or proximity.

Noise ('N') is defined as the maximum percent change in capacitance due to noise.

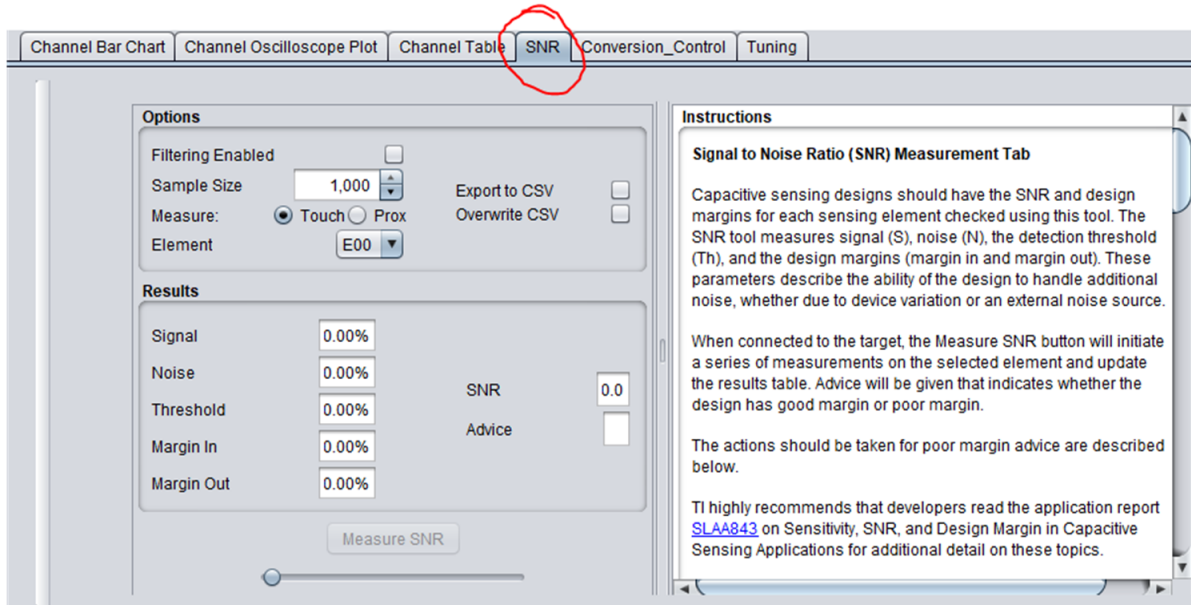
Threshold ('Th') sets the sensitivity of the sensor. It defines the minimum percent change in capacitance (up or down) which must occur for a proximity or touch detection to be reported.

Margin In ("Min") is the false detection margin, or the margin going into a touch. It is the margin between the highest noise level 'N' and the detection threshold 'Th'. This gives an indication on how much additional noise can be tolerated by the system before a false detection would occur. This is one of the most valuable parameters when conducting a reliability analysis.

MarginIn is calculated for Self mode as follows:

$$\text{Min} = \text{Th} - \text{N} \tag{11}$$

MarginIn is calculated for Mutual mode as follows:

$$\text{Min} = \text{N} - \text{Th} \tag{12}$$

Margin Out ("Mout") is the detection margin, or the margin going out of a touch. It is the margin between the lowest signal level 'S' and the detection threshold 'Th'. This margin indicates how much additional noise can be tolerated during a valid touch. Previously, the touch status would be reported as cleared because noise has pulled the measurement result below the detection threshold.

SNR is the straight ratio of signal S to noise N:

$$\text{SNR} = \text{S} / \text{N} \tag{13}$$

For more information, see the instructions given in the tool or the [Sensitivity, SNR, and design margin in capacitive touch applications report](#).



图 28. Signal-Margin-Definition

4.3.3 SNR Tool Parameter Explanation and Limit Recommendations

图 29 给出了不同参数和技术以确保系统可靠操作的推荐限制。

Technology	Application Operating Temperature	Typical Device Noise Floor	Max Device Noise Floor	Safety Factor	Minimum Recommended Threshold	Minimum Recommended Margin-In
Gen 1	25 C	0.07%	0.50%	+ 0.1%	0.60%	0.53%
Gen 1	0 C	0.09%	0.80%	+ 0.1%	0.90%	0.83%
Gen 1	-40 C	0.13%	1.3%	+ 0.1%	1.4%	1.33%
Gen 2	25 C	0.06%	0.20%	+ 0.1%	0.30%	0.24%
Gen 2	0 C	-	0.20%	+ 0.1%	0.30%	0.24%
Gen 2	-40 C	0.09%	0.20%	+ 0.1%	0.30%	0.24%

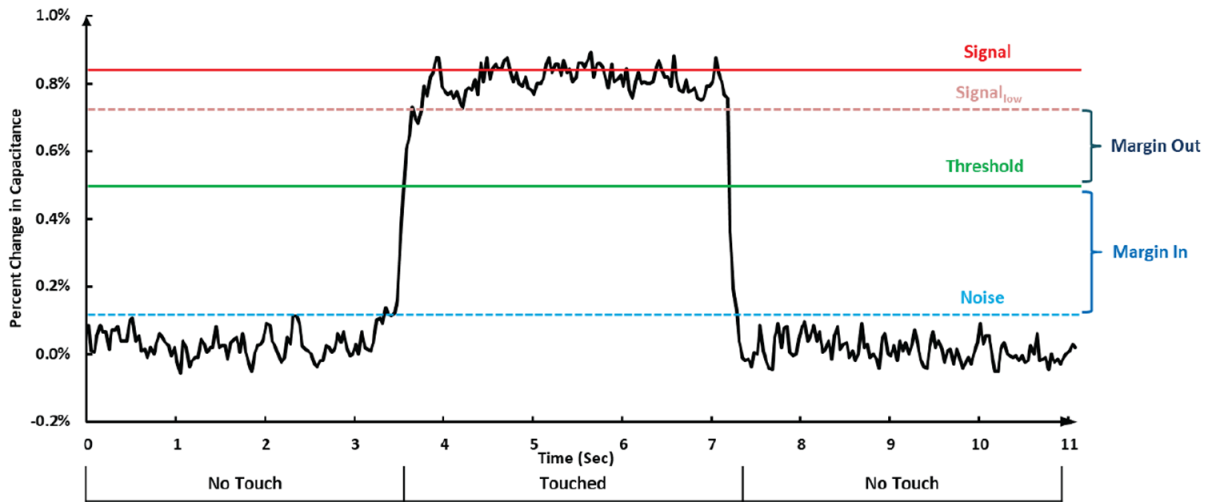
图 29. Recommended Limits for Gen1 and Gen2

TI 推荐满足以下系统值以实现稳健设计：

$$Min > DN_{max} - DN_{typ} + SF$$

$$Th > DN_{max} + SF$$

为了更好地理解工具输入和输出参数，图 30 说明了概念并逐步解释数据。

Implementation Parameters (HW, Design, etc)								Parameter set in CDC			Parameters Measured and calculated by the SNR Tool					
Thickness [mm]	Self/Mutual	Shielding	Electr. size [mm]	Separation [mm]	Air gap [mm]	Filler material	CC	Gain	Touch Threshold	Signal	Noise	Threshold	Margin IN	Margin OUT	SNR	
4	S	Y	ø 10	TIDA-494	0	N	600	100	5	0,76	0,03	0,68	0,65	0,02	27,1	

图 30. System Parameter Example

在此示例中，测量的噪声和信号值保持相同。

推荐的工艺技术限制在图 29 中给出，并且 Gen1 和 Gen2 不同。

This design is a good example for understanding the differences between the Gen1 and Gen2 IP generation on challenging applications.

As shown in 表 12, for Gen 1, the system shows a good margin and passes the test at 25°C (**Pass > 0.53%**). At a temperature of 0°C, the calculated margin and threshold are below the recommended limits (**Fail <0.83%**). This does not mean that the system will not work at this temperature, but it indicates an increased risk at this temperature of false detection in mass production. To improve the stability at 0°C, adjustments to the design need to be made. These modifications, depending on the degree of freedom of the design, should target to increase the signal strength and/or reduce noise and/or reduce the parasitic capacitance. For example, reduce the overlay thickness, use conductive filler to bridge the air gap, or increase the size of the electrodes, and so forth. More information can be found in the [CapTlvate Technology Guide](#).

In Gen2, due to the lower worst-case noise floor across the operating temperature range, the recommended limits are lower leading to a pass over the full temperature range.

表 12. Test Results Analysis

IP Generation	Temperature	Min. Recommended Limits	Resulting Values
Gen 1	@25°C	Min > DNmax-DNtyp+SF > 0.5-0.07+0.1 > 0.53% Th>DNmax+SF > 0.5+0.1 > 0.6%	Min calculated by the SNR tool: 0.65% (Pass > 0.53%) Th calculated by the SNR tool: 0.68% (Pass > 0.6%)
	@0°C	Min > DNmax-DNtyp+SF > 0.8-0.09+0.1 > 0.83% Th>DNmax+SF > 0.8+0.1 > 0.9%	Min calculated by the SNR tool: 0.65% (Fail <0.83%) Th calculated by the SNR tool: 0.68% (Fail <0.9%)
	@-40°C	Min > DNmax-DNtyp+SF > 0.8-0.09+0.1 > 1.33% Th>DNmax+SF > 0.8+0.1 > 1.4%	Min calculated by the SNR tool: 0.65% (Fail <1.33%) Th calculated by the SNR tool: 0.68% (Fail <1.4%)
Gen2	@ Full Temperature range	Min > DNmax-DNtyp+SF > 0.2-0.09+0.1 > 0.21% Th>DNmax+SF > 0.2+0.1 > 0.3%	Min calculated by the SNR tool: 0.65% (Pass > 0.21%) Th calculated by the SNR tool: 0.3% (Pass > 0.3%)

4.3.4 Summary of the Test Results

A summary of the executed test scenarios and the related results are listed below. The given advice indicates the health of the design covering all possible noise and temperature ranges.

Red advice does not mean that the system does not work under normal condition. It indicates the risk of false detection, especially in mass production due to the device parameter drifts and noise conditions. The results are related to the system with the given electrode design and mechanical assembly. The indication should be seen as advice to make additional modifications to the design implementations, for example, to improve the signal strength.

To improve the signal strength, the following modifications can be considered:

- Reduce overlay thickness
- Reduce the gap between the electrode and glass
- Bridge the gap with higher dielectric constant material (air = 1)
- Increase the size of the electrodes

- Reduce the GND coupling

Detailed information on how to improve the system health can be found in [Sensitivity, SNR, and design margin in capacitive touch applications report](#) and the [CapTIvate Technology Guide](#).

图 31 lists a number of tests conducted under similar conditions but varying system parameters and distance from the electrode to the overlay. Filler material Y means a filler material is used to bridge the gap and N test without filler material. Under the given settings, the design was tuned at the beginning of the test to operate as intended. Tests with filler material, especially metal springs, showed the best performance due to the improved gap dielectric (air versus conductive material), providing the best coupling between electrode and finger.

Overlay Material: Glass							
Type of Sensor: Button							
Board: TIDA-00494 w/ enclosure							
Airgap [mm]	0	1	1	2	3	3	12
Filler material	Y Double sided tape	N Air gap	Y Conductive Foam	Y Conductive Foam	Y Conductive Foam	Y metal spring	Y Conductive Foam
CC	500	1000	500	500	500	400	500
Gain	100	100	100	100	100	100	100
Touch Threshold	5	2	7	7	7	10	7
Signal	0,95	.11	1,28	1.29	1.24	2.34	1,2
Noise	0,04	.03	0,04	0.04	.04	.04	.04
Threshold	0,82	.08	1.17	1.17	1.16	2.13	1.16
Margin IN	0,78	.05	1.13	1.13	1.12	2.13	1.12
Margin OUT	.03	.01	.05	.5	.02	.08	.02
SNR	23	3.4	31	33	30	55	29
Gen 1 Advice @25 °C							
Th >0.6							
Min >0.53							
Gen 1 Advice @0 °C							
Th >0.9	*See text						
Min >0.83							
Gen 2 Advice @ full temp range							
Th >0.3							
Min >0.21							

图 31. Summary of the Test Results

The values in 图 31 are manually measured on the original hardware and may vary slightly due to positioning of the finger on the setup.

With the given electrode design and enclosure, Gen2 devices allow reliable operation across temperature for up to a 3-mm distance from the glass, provided a filler material is used.

In this application, Gen1 shows a reliable operation at 25°C and 0°C. At a temperature of 0°C and a distance of 0 mm, (double-sided tape was used), the Gen1 results are slightly below the limits. This will be in the responsibility of the user to decide if that would be acceptable for their application.

Using conductive filler material (foam or springs), larger gaps can be also supported with reliable operation see also test results up to 12 mm. This is due to the conductive properties of the filler material allowing larger distance between the finger and the electrode with less signal losses.

TI does **not recommend** implementations with large air gaps with conductive filler material, as the filler material will act as a noise receiver and will increase the noise susceptibility of the system. This will lead to reduced reliability of the system under noise conditions.

注: *SF*: Safety Factor, *Min*: MarginIn, *DN*: Device Noise, *Th*: Threshold, *N*: Noise measured by the tool, MarginIn is calculated as follows: $Min = Th - N$

5 Design Files

5.1 Schematics

To download the schematics, see the design files at [TIDA-00494](#).

5.2 Bill of Materials

To download the bill of materials (BOM), see the design files at [TIDA-00494](#).

5.3 PCB Layout Recommendations

The diameter of the board is determined by the diameter of the enclosure window. On the upper part of the PCB, a board cutout has to be made for the LCD. It is important that all the components are surface-mounted devices (SMDs) and placed on the bottom part of the PCB so that the air gap between the top part of the PCB and the window can be kept as small as possible. Only the buttons and the LED have to be placed on the top part.

Digital signals can act as aggressors and can be active during capacitance measurement. Keep these types of signals far away from the capacitive touch trace as shown for button 1, 3, and 4 of the TIDA-00494. If the digital signal and the capacitive touch trace must cross each other, like in the case of button 2, then it is recommended to keep the crossing at a 90-degree angle.

Using a hatched ground plane on the top and bottom side reduces the parasitic capacitance associated with both trace and electrode capacitance, reducing the susceptibility of the traces to capacitive touch events.

See the "Best Practices" section of the CapTIvate Technology Guide to browse other recommendations for an optimized layout.

5.3.1 Layout Prints

To download the layer plots, see the design files at [TIDA-00494](#).

5.4 Altium Project

To download the Altium project files, see the design files at [TIDA-00494](#).

5.5 Gerber Files

To download the Gerber files, see the design files at [TIDA-00494](#).

5.6 Assembly Drawings

To download the assembly drawings, see the design files at [TIDA-00494](#).

6 Software Files

To download the software files, see the design files at [TIDA-00494](#).

7 Related Documentation

1. Texas Instruments, CapTIvate™ Touch Microcontroller (<http://www.ti.com/capTIvate>)
2. Texas Instruments, MSP CapTIvate MCU Development Kit (<http://www.ti.com/tool/msp-capt-fr2633>)
3. Texas Instruments, MSP CapTIvate Design Center GUI (<http://www.ti.com/tool/MSPCAPTDSNCTR>)
4. Texas Instruments, CapTIvate™ Technology Guide (http://software-dl.ti.com/msp430/msp430_public_sw/mcu/msp430/CapTIvate_Design_Center/latest/exports/docs/users_guide/html/index.html)
5. Texas Instruments, MSP430FR2633 Product Page (<http://www.ti.com/product/MSP430FR2633>)
6. Texas Instruments, *Sharp® LCD BoosterPack (430BOOST-SHARP96) for the LaunchPad (SLAU553)*
7. Sharp Electronics, *Application Information for Sharp's LS013B4DN04 Memory LCD*, SHARP LCD Module Application Note (http://www.sharpmemorylcd.com/resources/ls013b4dn04_application_info.pdf)

7.1 商标

All trademarks are the property of their respective owners.

8 About the Author

GIOVANNI CAMPANELLA is an industrial systems engineer with the Field Transmitter Team in the Factory Automation and Control organization. He earned his bachelor's degree in electronic and telecommunication engineering at the University of Bologna and his master's degree in electronic engineering at the Polytechnic of Turin in Italy. He is an expert in sensors and analog signal chain, with a focus on magnetic and analytics sensing technologies, and mixed-signal control of DC brushed servo drives. He is currently working on IoT and EH systems design for field transmitters and actuators.

修订历史记录

注：之前版本的页码可能与当前版本有所不同。

Changes from A Revision (September 2016) to B Revision	Page
• 已更改 values in <i>Finger Touch—Crosstalk</i> table	24
• 已更改 values in <i>Finger Touch With Gloves—Crosstalk</i> table	26
• 已添加 <i>CapIvate Design Center SNR Tool</i> section	28

Changes from Original (July 2016) to A Revision	Page
• 已更改 对预览页进行了更改.....	1

重要声明和免责声明

TI“按原样”提供技术和可靠性数据（包括数据表）、设计资源（包括参考设计）、应用或其他设计建议、网络工具、安全信息和其他资源，不保证没有瑕疵且不做任何明示或暗示的担保，包括但不限于对适销性、某特定用途方面的适用性或不侵犯任何第三方知识产权的暗示担保。

这些资源可供使用 TI 产品进行设计的熟练开发人员使用。您将自行承担以下全部责任：(1) 针对您的应用选择合适的 TI 产品，(2) 设计、验证并测试您的应用，(3) 确保您的应用满足相应标准以及任何其他功能安全、信息安全、监管或其他要求。

这些资源如有变更，恕不另行通知。TI 授权您仅可将这些资源用于研发本资源所述的 TI 产品的应用。严禁对这些资源进行其他复制或展示。您无权使用任何其他 TI 知识产权或任何第三方知识产权。您应全额赔偿因在这些资源的使用中对 TI 及其代表造成的任何索赔、损害、成本、损失和债务，TI 对此概不负责。

TI 提供的产品受 [TI 的销售条款](#) 或 [ti.com](#) 上其他适用条款/TI 产品随附的其他适用条款的约束。TI 提供这些资源并不会扩展或以其他方式更改 TI 针对 TI 产品发布的适用的担保或担保免责声明。

TI 反对并拒绝您可能提出的任何其他或不同的条款。

邮寄地址：Texas Instruments, Post Office Box 655303, Dallas, Texas 75265

Copyright © 2022，德州仪器 (TI) 公司