

设计指南: **TIDC-HYBRID-RF-PLC**

用于扩展网络覆盖范围并增强可靠性的混合射频和 **PLC** 参考设计



说明

随着先进抄表基础设施 (AMI) 和配电自动化网络中的准时响应和监控越来越重要, 人们对通信可靠性的要求也有所提高。此参考设计通过采用射频 (RF) 和电力线通信 (PLC) 的解决方案, 不仅能解决这一问题, 还有助于提高网络性能、可靠性、容量和可扩展性。CC13xx 无线微控制器 (MCU) 可用作射频协议处理器和 PLC 处理器的主机, 从而降低额外的系统设计成本。此设计利用专有的射频解决方案, 可以为满足不同市场要求的各种射频协议和频带提供参考。混合无线 *M-Bus* 和 *G3-PLC* 参考设计 ([TIDC-HYBRID-WMBUS-PLC](#)) 采用特定版本的混合射频和 PLC 方案。

资源

TIDC-HYBRID-RF-PLC	设计文件夹
CC1310	产品文件夹
F28PLC84	产品文件夹
F28375S	产品文件夹
F28M35H52C	产品文件夹
AFE031	产品文件夹
AFE032	产品文件夹
TMDSPCKITV4-CEN	工具文件夹
LAUNCHXL-CC1310	工具文件夹
TI-PLC-G3-CENELEC-SN	工具文件夹
SIMPLELINK-CC13X0-SDK	工具文件夹

特性

- 通过无线网络和 PLC 网络的同时传输提高网络可靠性
- 使用射频和 PLC 网络同时传输独立数据, 通过空间多路复用提高网络容量
- 通过用作射频网络和 PLC 网络之间的桥接器, 扩展区域内的覆盖范围, 从而提高网络可扩展性
- 完全可编程的协议设计为射频和 PLC 通信协议和频带提供各种选项
 - CENELEC、ARIB 和 FCC 频带上的 PLC 协议 (PRIME、G3-PLC 和 PLC Lite)
 - 低于 1GHz (CC1310 或 CC1350) 和 2.4GHz 频带 (CC1350) 上的射频协议 (无线 M-Bus、IEEE 802.15.4g FSK 和远距离模式)

应用

- 配电自动化
- 电表
- 智能插头
- 智能电网通信



[Search Our E2E™ support forums](#)

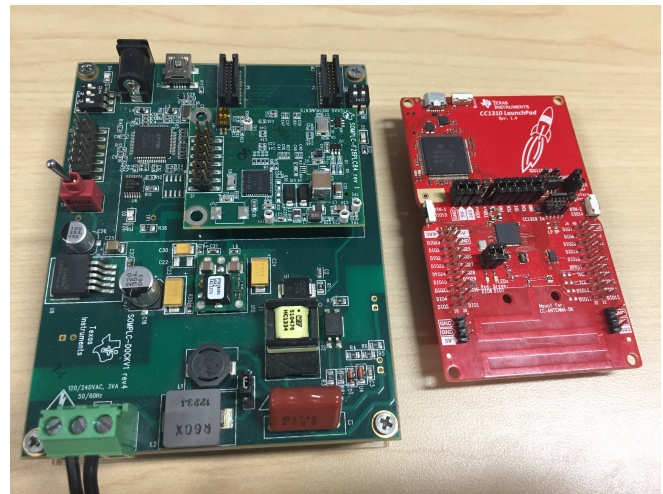
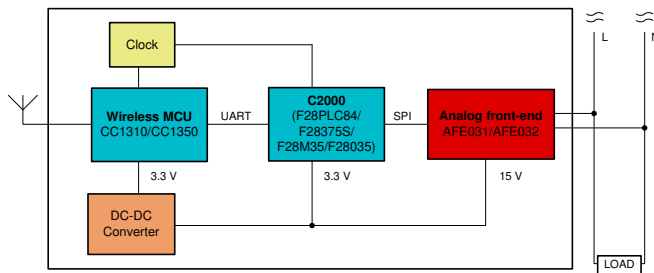

该 TI 参考设计末尾的重要声明表述了授权使用、知识产权问题和其他重要的免责声明和信息。

1 System Description

This TI Design provides a reliable communication system solution with dual RF and PLC communications for end equipment of smart grid applications. This design is built on top of the existing TI PLC and RF solutions, which target at improving network performance and providing more features by combining the communication modems while keeping the advantages inherited from the existing PLC and RF solutions.

The programmable PLC design allows two options for the system design: one uses RF with a PLC full-stack based design (图 1), and one uses RF with a PLC lower-MAC stack based design (图 2). The former design takes full advantage of the embedded PLC network stacks, allowing multi-hop communications without additional effort in addition to the new features such as simultaneous transmissions, spatial multiplexing, PLC and RF repeaters, and support for two independent networks. The latter design allows the lower stacks (MAC or network layer) to control which physical layer (wireless or PLC) is used for each link over multi-hop networks. This capability cannot be supported by the former design.

图 1 shows the RF with a PLC full-stack based system architecture. The ARM® Cortex®-M3 processor in the CC1310 (or CC1350) Simplelink™ Wireless MCU is the CPU controlling both the RF and PLC links. For this design, the CC1310 Wireless MCU is connected to the C2000™ PLC MCU through UART to act as the PLC modem's external host processor. The PLC MCU is loaded with the complete PRIME or G3-PLC software stack. The wireless MCU also runs the system's host applications; for example, it simultaneously transmits packets on both networks or acts as a bridge between the different physical networks. The hybrid RF/PLC example project described in 4 节 implements this architecture with the full G3-PLC stack.

图 1. System Architecture (RF With PLC Full-Stack)



图 2 显示了 RF 带有 PLC 较低-MAC 堆栈的系统架构。该架构的唯一区别在于 C2000 PLC 设备加载了 PLC 较低-MAC 堆栈二进制代码，而不是完整的 PLC 堆栈。该架构的好处是允许构建一个网络层来控制 RF 和 PLC MAC 或 PHY，从而使网络层能够在整个多跳路径上选择 RF 和 PLC 通道。该网络层如何选择其中一个链接（有线或 PLC）的决策算法可以是实现特定的。请注意，此设计能够构建这种类型的架构，但随此设计而来的软件并不提供任何具体的示例来配合此架构。

较低-MAC PLC 软件二进制代码可以从 G3-PLC DC 或 PRIME DC 软件包[5][6]中获得。PLCLite，TI 的专有 PLC 解决方案，仅包括 MAC 和 PHY，可以从 TI-PLC-PLCLITE 产品页面[8]中下载。

图 2. System Architecture (RF With PLC Lower-MAC Stack)

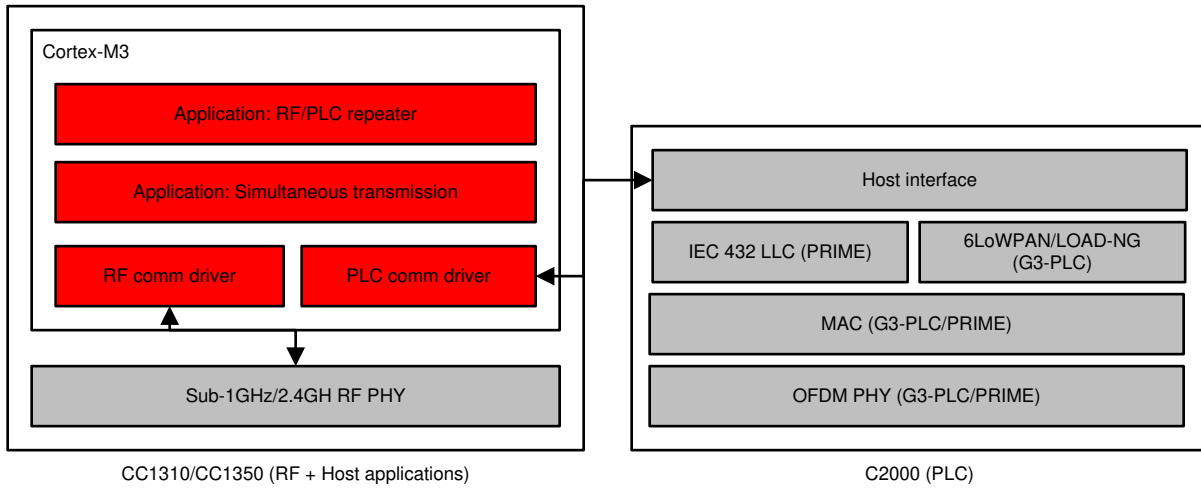
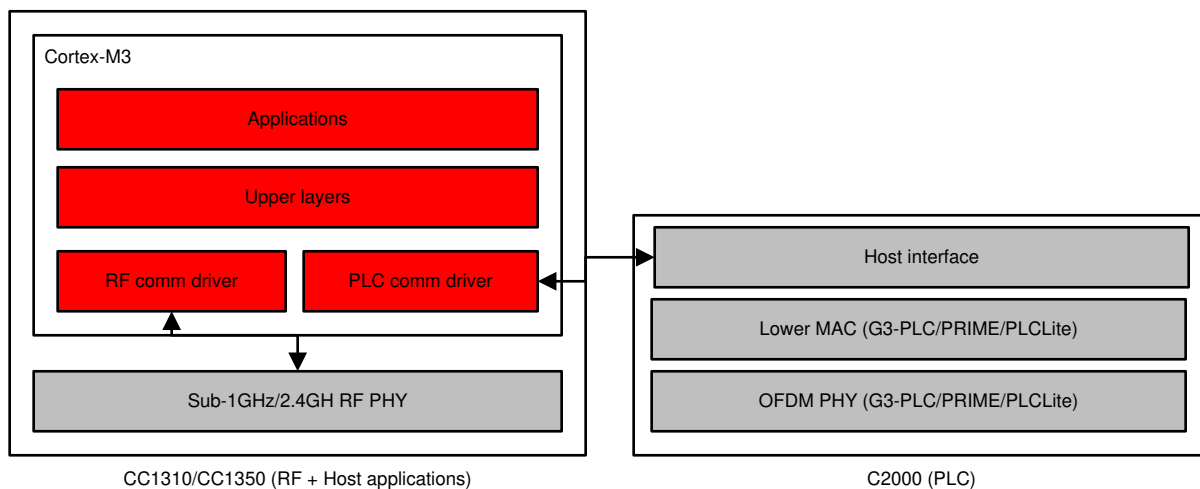

2 Block Diagram

图 3 shows the block diagram of the design. The primary devices for this design are the CC1310, TMS320F28PLC84, and AFE031. The CC1310 includes two core processors: ARM Cortex-M0 for RF communication, and ARM Cortex-M3 for applications, network stacks, and host-level RF and PLC communication drivers. The TMS320F28PLC84 with the AFE031 (PLC analog front-end) is for PLC communication.

For this design, these devices were chosen because of the following:

- The CC1310 combines a flexible, ultralow-power RF transceiver with a powerful 48-MHz ARM Cortex-M3 microcontroller in a platform supporting multiple PHY (physical) layers and RF standards.
- The TMS320F28PLC84 provides optimized PLC OFDM performance with VCU and allows a programmable, flexible PLC design upgradable to different PLC solutions without hardware modification.
- The AFE031 analog front-end provides high reliability in PLC applications by monolithic integrated circuit with thermal and overcurrent protection.

图 3. Block Diagram

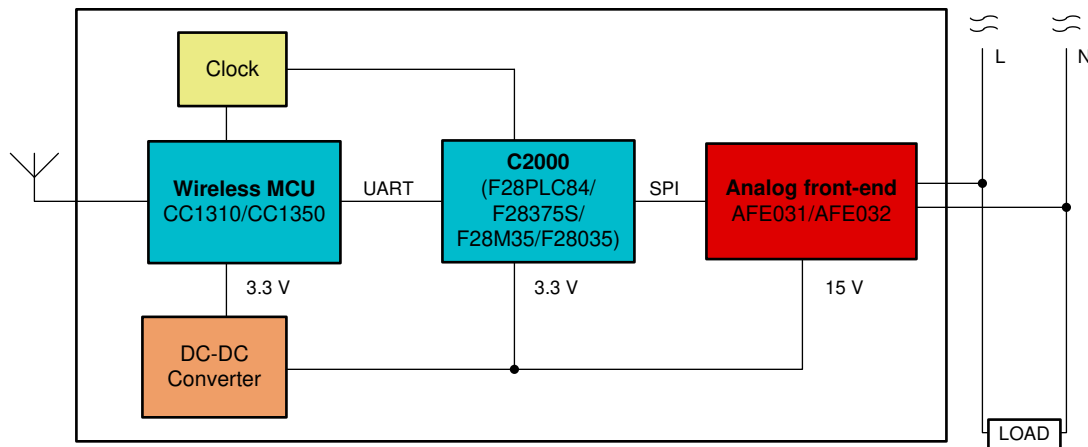

2.1 CC1310

The CC1310 is a member of the CC26xx and CC13xx family of cost-effective, ultralow-power, 2.4-GHz and Sub-1GHz RF devices. Its very low active RF, MCU current, and low-power mode current consumption provide excellent battery lifetime and allow operation on small coin-cell batteries and in energy-harvesting applications. The device is the first part in a Sub-1 GHz family of cost-effective, ultralow power wireless MCUs. The CC1310 combines a flexible, very low power RF transceiver with a powerful 48-MHz Cortex-M3 microcontroller in a platform supporting multiple physical layers and RF standards. A dedicated radio controller (Cortex-M0) handles low-level RF protocol commands that are stored in ROM or RAM, thus ensuring ultralow power and flexibility. The low-power consumption of the CC1310 does not come at the expense of RF performance; the CC1310 has excellent sensitivity and robustness (selectivity and blocking) performance. The CC1310 is a highly integrated, true single-chip solution incorporating a complete RF system and an on-chip DC-DC converter. Sensors can be handled in a very low-power manner by a dedicated autonomous ultralow-power MCU that can be configured to handle analog and digital sensors; thus, the main MCU (Cortex-M3) is able to maximize sleep time. The CC1310 power and clock management and radio systems require specific configuration and handling by software to operate correctly. This has been implemented in the TI RTOS, and it is therefore recommended that this software framework is used for all application development on the device. The complete TI-RTOS and device drivers are offered in source code free of charge. 图 4 shows the CC1310 functional block diagram[1].

图 4. CC1310 Functional Block Diagram[1]

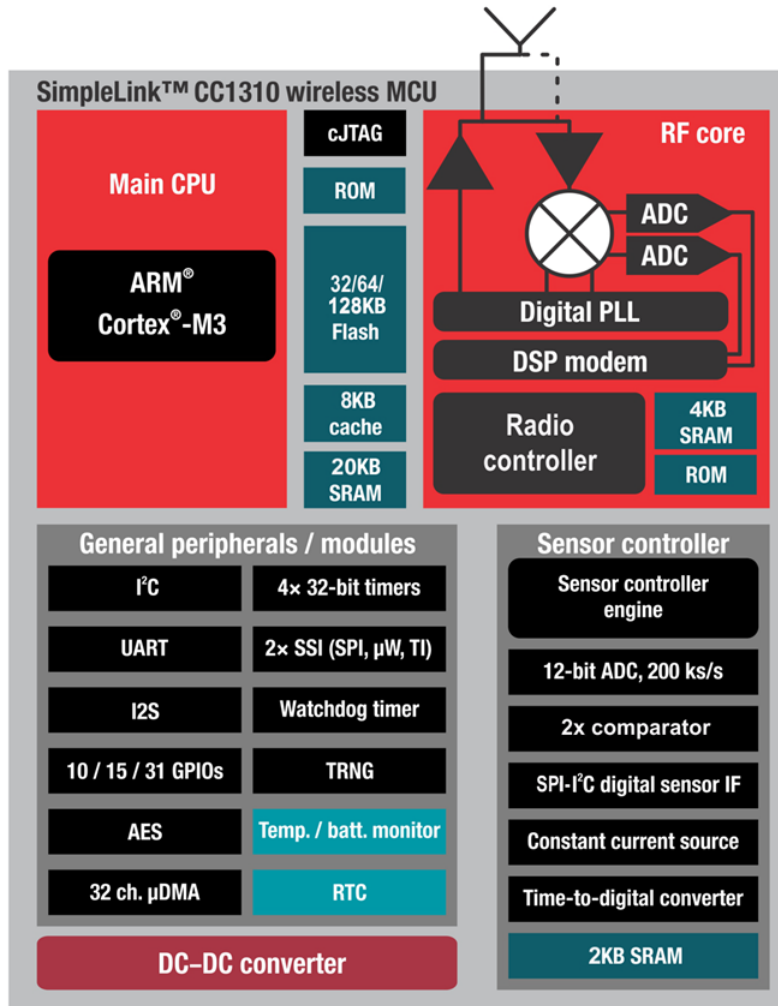

2.2 TMS320F28PLC84

The TMS320F28PLC84 PLC processors are optimized to meet the requirements for AMI networks in smart grid installations that use narrowband PLC in the CENELEC frequency band. The CENELEC band is defined to be 35 to 90 kHz. The F28PLC84 processor is designed to execute the entire PLC protocol stack for the supported industry standards. TI supplies these firmware libraries to execute on the F28PLC84 processor with no additional license fees or royalties. The F28PLC84 processor is also used in PLC data concentrators, which act as neighborhood-area collectors of electricity usage information from multiple end nodes. The F28PLC84 processors are optimized to work with the AFE031 analog front-end for PLCs. The AFE031 is an integrated analog front-end for narrowband PLCs that are capable of driving a transformer-coupled connection to the AC mains power line. It is ideal for driving high-current, low-impedance lines driving up to 1.9 A into reactive loads. The AFE031 is compliant to CENELEC A, B, C, and D (EN50065-1, EN50065-2, EN50065-3, EN50065-7) frequency bands. 图 5 shows the TMS320F28PLC84 functional block diagram[2].

图 5. TMS320F28PLC84 Functional Block Diagram[2]

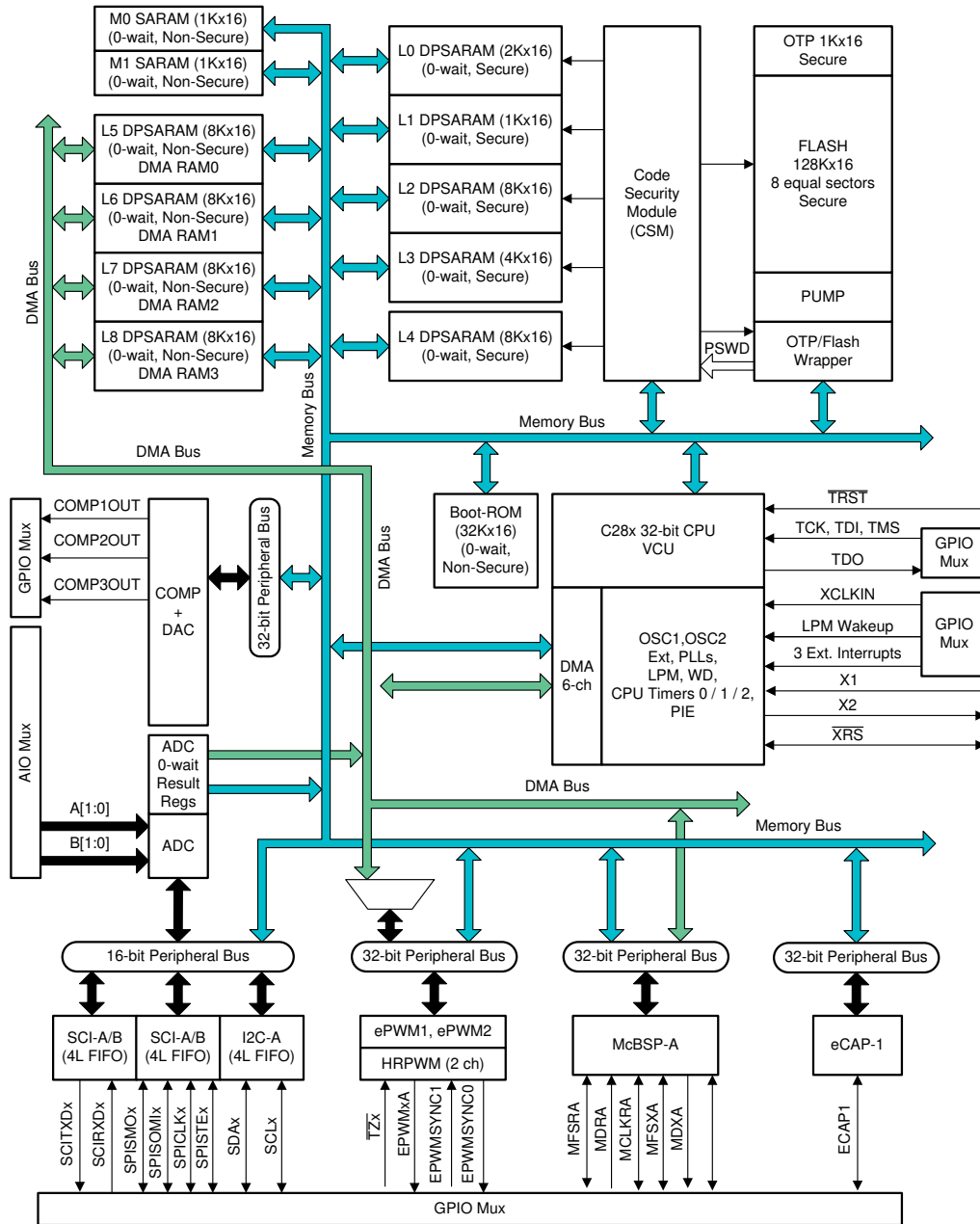

2.3 AFE031

The AFE031 is a low-cost, integrated, PLC analog front-end device that is capable of capacitive- or transformer-coupled connections to the power line while under the control of a DSP or microcontroller. It is ideal for driving low-impedance lines that require up to 1.5 A into reactive loads. The integrated receiver is able to detect signals down to 20 μV_{RMS} and is capable of a wide range of gain options to adapt to varying input signal conditions. This monolithic integrated circuit provides high reliability in demanding PLC applications.

The AFE031 transmit power amplifier operates from a single supply in the range of 7 to 24 V. At maximum output current, a wide output swing provides a 12-V_{PP} ($I_{\text{OUT}} = 1.5 \text{ A}$) capability with a nominal 15-V supply. The analog and digital signal processing circuitry operates from a single 3.3-V power supply.

The AFE031 is internally protected against over temperature and short-circuit conditions. It also provides an adjustable current limit. An interrupt output is provided that indicates both current limit and thermal limit. There is also a shutdown pin that can be used to quickly put the device into its lowest power state.

Through the four-wire serial peripheral interface, or SPI, each functional block can be enabled or disabled to optimize power dissipation. The AFE031 is housed in a thermally-enhanced, surface-mount Power PAD package (QFN-48). Operation is specified over the extended industrial junction temperature range of -40°C to 125°C . 图 6 shows the AFE031 functional block diagram[3].

图 6. AFE031 Functional Block Diagram[3]

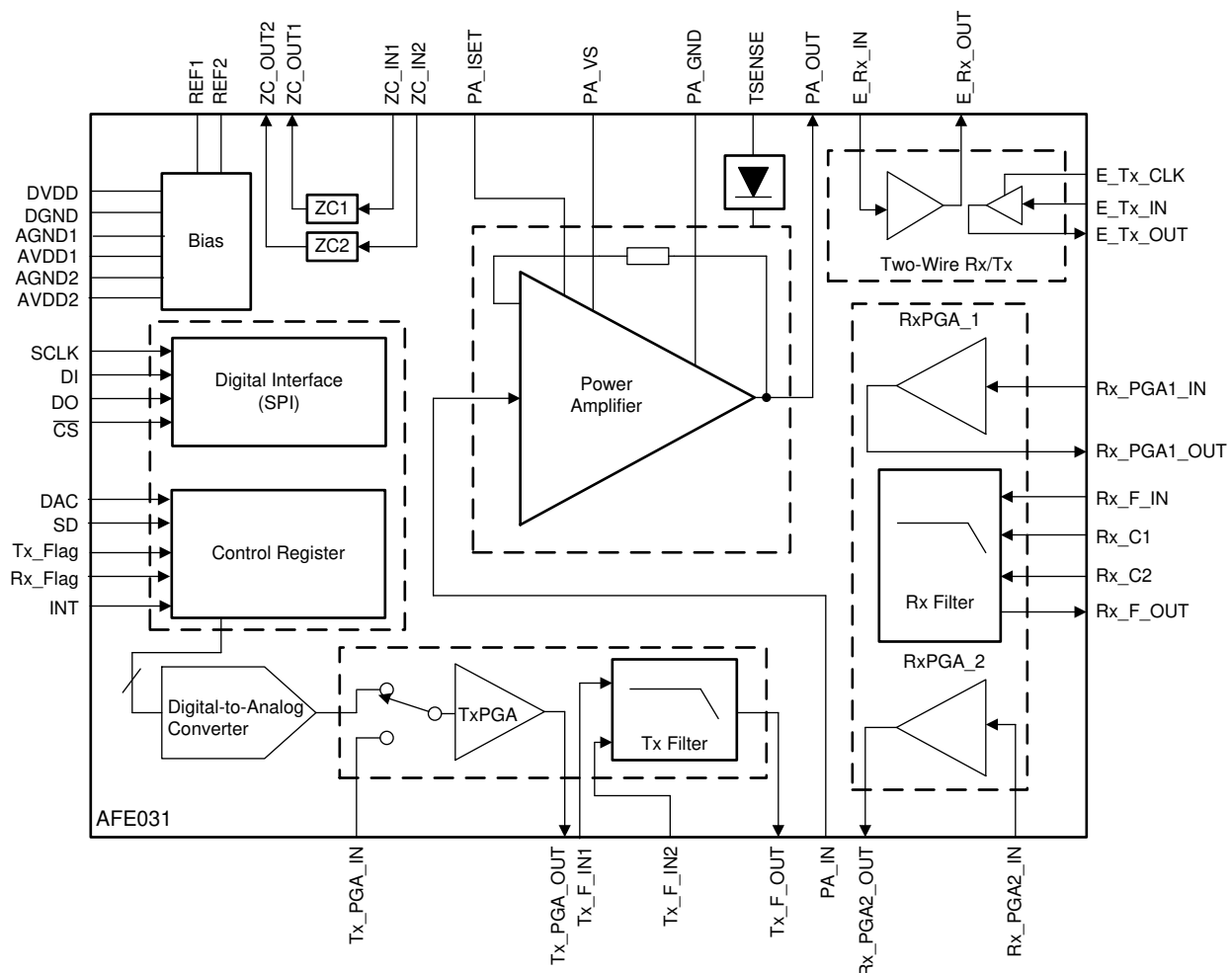

3 Getting Started Hardware

The hybrid RF and PLC communications design is built with two standard EVMs: the LAUNCHXL-CC1310 (<http://www.ti.com/tool/launchxl-cc1310>) and the TMDSPCKITV4-CEN (<http://www.ti.com/tool/tmdsplckitv4-cen>), shown in 图 7 and 图 8, respectively. For PLC, this reference design is configured as CENELEC-A band in software with the TMDSPCKITV4-CEN platform. Depending on user applications, the TIDM-SOMPLC-FCC (<http://www.ti.com/tool/TIDM-SOMPLC-FCC>) or the TMDSPCKITV4-ARIB (<http://www.ti.com/tool/TIDM-SOMPLC-ARIB>) can be also used with the LAUNCHXL-CC1310 EVM. Similarly, the CC1310 can be replaced with the CC1350 or other CC wireless MCUs with some modification on the example software provided with the reference design.

图 7. LAUNCHXL-CC1310



图 8. TMDSPCKITV4-CEN



3.1 Hybrid RF/PLC EVM Configuration

The major hardware modification to build the hybrid RF and PLC module is to connect UART pins between RF and PLC EVM: UART_TX, UART_RX, and GND. 图 9 shows UART pin connections between the TMDSPCKITV4 and LAUNCHXL-CC1310. The M3:P2-12 (PLC_SCIA_TX) pin (图 9) is connected to the UART RX pin (DIO 2) on the LAUNCHXL-CC1310, and M3:P2-14 (PLC_SCIA_RX) (图 9) to the UART TX pin (DIO 3) on the LAUNCHXL-CC1310 EVM. One of the GND pins in the TMDSPCKITV4 EVM, shown in 图 9, is connected to a GND pin on the LAUNCHXL-CC1310.

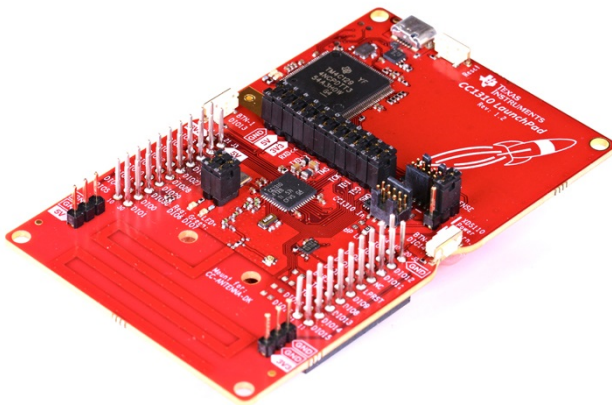
图 9. UART Pins on TMDSPCKITV4

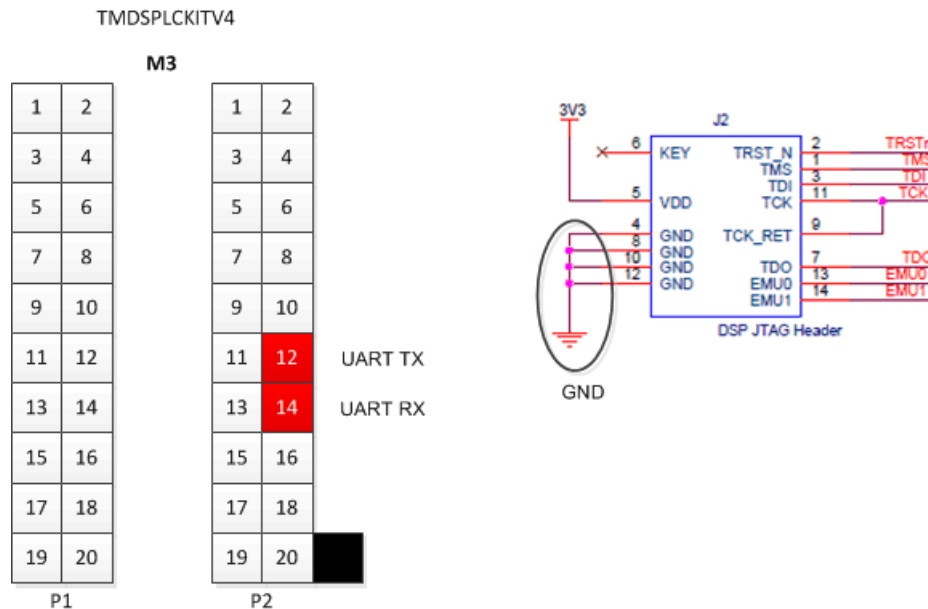

As shown in 图 10, additional configuration change is SW2 position to OFF. Turning off the SW2 blocks UART communication with the mini-USB port in TMDSPCKITV4. Thus, it allows the M3 module to communicate with external device through UART without any interrupts.

图 10. SW2 Position in TMDSPCKITV4 EVM

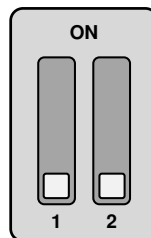

4 Getting Started Firmware

This reference design provides a HYBRID-RF-PLC software example which includes applications for simultaneous transmissions, RF and PLC repeaters, and RF and PLC communication drivers. This section covers details of the example software architecture, followed by how to build and flash the example project using Code Composer Studio™ (CCS). The software example can be built with Code Composer Studio™ (CCS) v9.0.1 (or above). 图 11 and 图 12 show the compiler and CC1310 SDK versions (SIMPLELINK-CC13X0-SDK v3.10.0.11) used to compile the software example.

图 11. Software Example Compiler Version



图 12. Software Example SDK Version



4.1 TIDC-HYBRID-RF-PLC Software Example

The example software runs based on TI-RTOS in the ARM Cortex-M3. For PLC communication, the default configuration in the example is set to CENELEC-A, TMR ON, and the TX level of 0x20 (maximum). For RF communication, the example is set to a 50-kbps FSK mode over a 868-MHz frequency band.

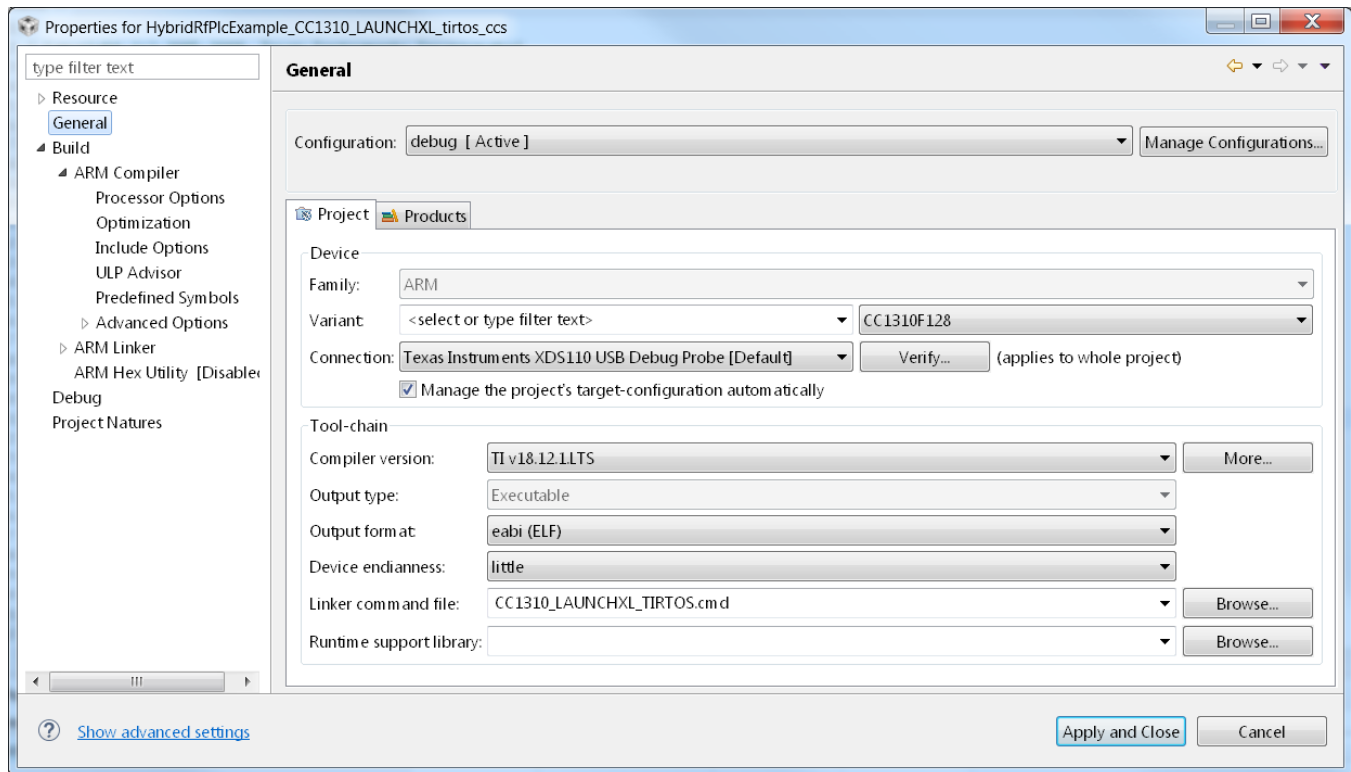
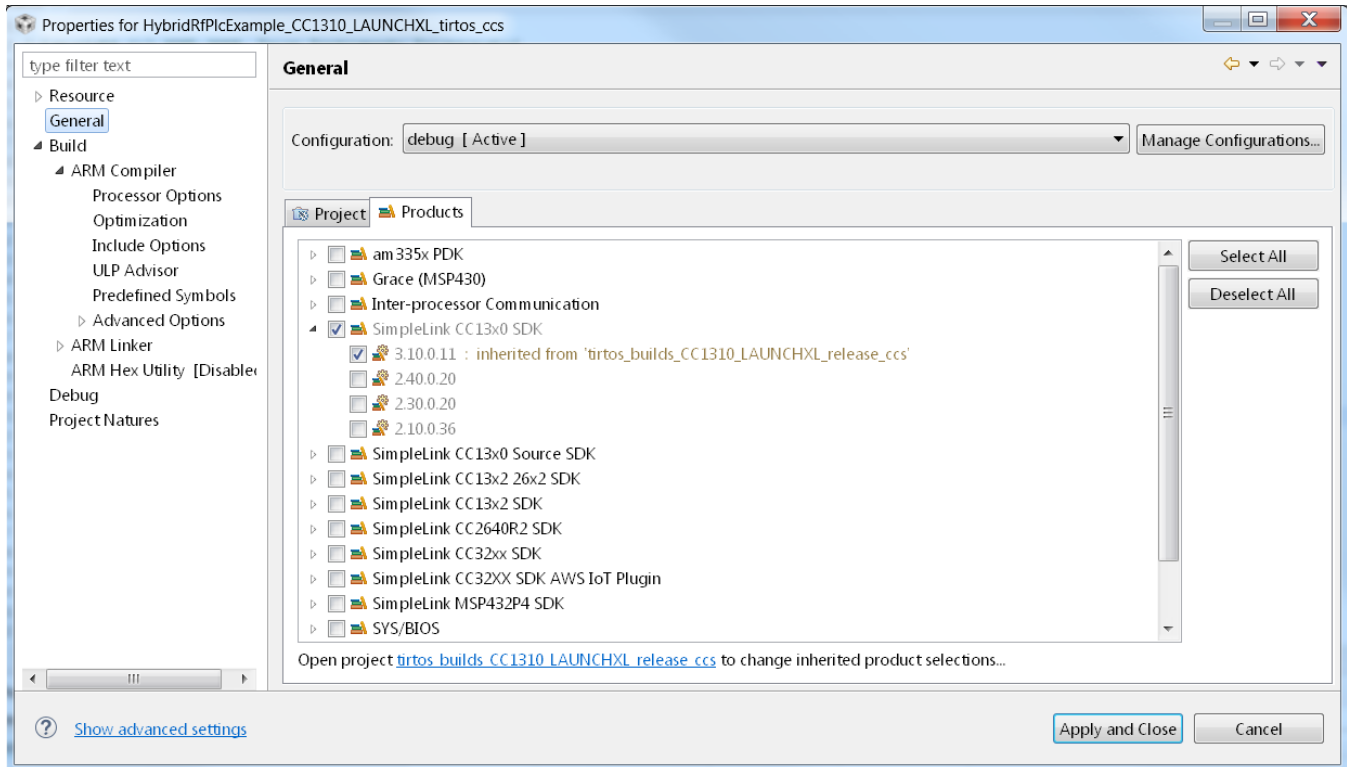
To run the software example in different frequency bands of FCC or ARIB, the following code line needs to be updated in the `init_plcHandler()` to `TONEMASK_FCC_FULL_BAND` or `TONEMASK_FCC_ARIB_54`. The TX power level and TMR configuration can be changed in the same function.

```
plcHandle.g3ToneMaskSelection = TONEMASK_CENELEC_A_36;
```

The software example runs simultaneous transmissions (sending data to RF and PLC channels). In addition, the RF and PLC repeater feature (passing received RF (or PLC) data to PLC (or RF) link) can be supported on top of the simultaneous transmissions by enabling `RF_PLC_REPEATER` macro definition in the software.

图 13 shows the overall software architecture of the hybrid RF/PLC example, which consists of five tasks: `uartRxTask`, `PLCStateMachineTask`, `RFTxTask`, `PLCTxTask`, and `applicationTask`. This project is provided as a working example to be used for baseline software on customer-specific application development.

图 13. Hybrid RF/PLC Example Software Architecture



图 14.

4.1.1 uartRxTask

The uartRXTask processes PLC host messages received from the C2000 PLC device. The task waits for a 6-byte PLC host message header that contains the host message type, payload length, and header CRC. If the CRC passes, the task extracts remaining bytes including payload CRC, payload sub-header, and payload. If the payload CRC passes, then the task passes the received data to the corresponding tasks through mailbox.

4.1.2 PLCStateMachineTask

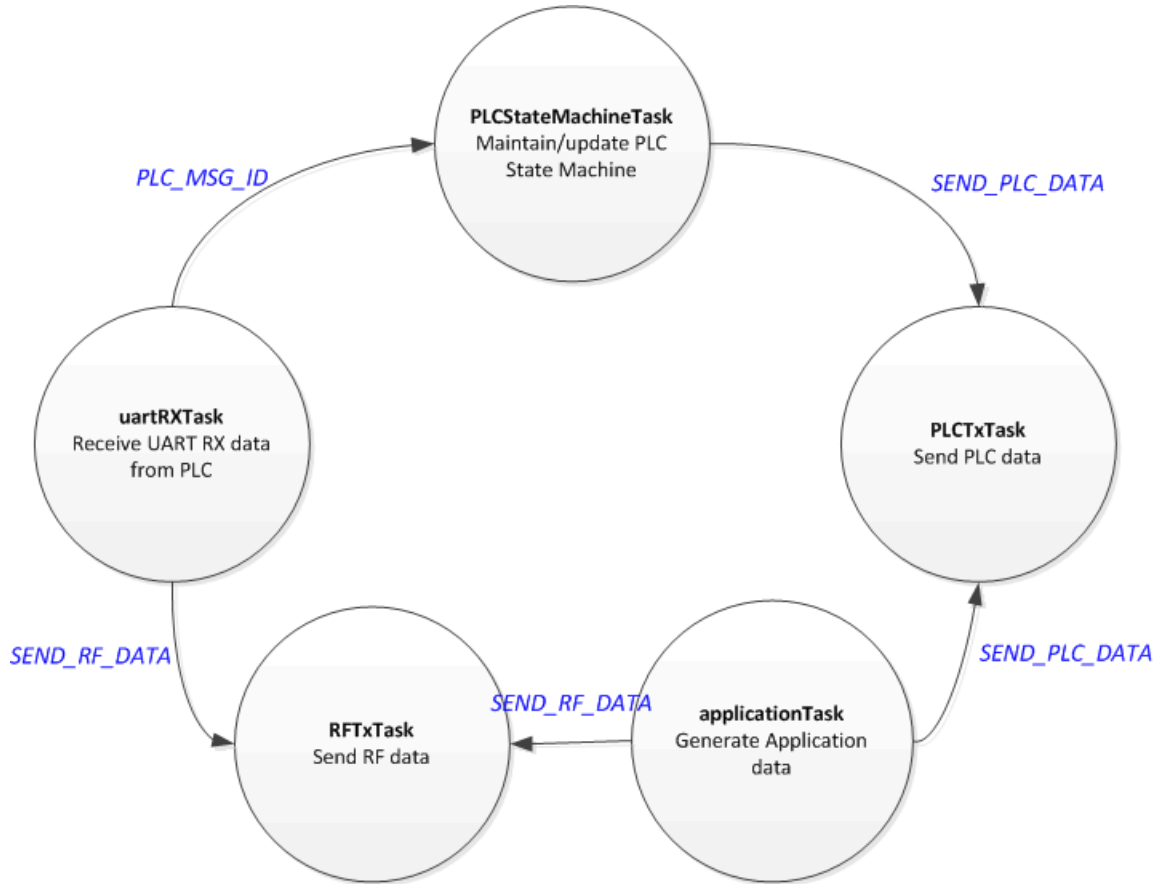
The PLCStateMachineTask maintains G3-PLC service node state machine. When power is on, the PLCStateMachine task starts to initialize G3-PLC with the default configuration and to join the G3-PLC network once G3-PLC DC is detected. Once all steps are successful, the task changes the state machine to NORMAL state, which allows the PLCTxTask to start data transmissions.

The details of the G3-PLC host message sequences can be found in 4.2 节, and this example is implemented in all procedures except for the keep-alive mechanism and firmware upgrade.

4.1.3 RFTxTask

The RFTxTask waits for the mailbox message of "SEND_RF_DATA". Once the task receives the mailbox message, it sends the data over the RF transmission path with a given configuration and then changes back to the receive state.

4.1.4 PLCTxTask

The PLCTxTask wait for the mailbox message of "SEND_PLC_DATA". If the task receives the mailbox message, it sends the data over UART to the PLC C2000 device for PLC transmissions, and then copies the data into PLC_HoldQueue to handle re-transmissions. When retransmission happens, the task simply sends the data in the PLC_HoldQueue through UART.

4.1.5 applicationTask

The applicationTask emulates application data source. This task creates 100B random data and sends a mailbox message with data to RFTxTask and PLCTxTask every 5 seconds for simultaneous transmissions. The application data size and interval can be configurable in application/app.c.

4.1.6 LED Configuration

The example project has activated two LEDs on LAUNCHXL-CC1310 to trace software activities. [表 1](#) summarizes the LED pin mapping to the specific software activity.

表 1. LED Mapping

LED NUMBER	BEHAVIOR MAPPING TO SOFTWARE ACTIVITY
DIO6	PLC TX/RX activities
DIO7	RF TX/RX activities

4.2 G3-PLC Service Node Host Message Sequences

This section details the G3-PLC host message sequences to run as G3-PLC service node.

4.2.1 Initialization State

表 2. Host Message Sequence (Initialization)

SEQ	HOST MSG	MSG TYPE	PARAMETERS
1	Load system configuration (Port configuration)	0x0C	Config type: 0x0001 Diag port/host port: SCI-A (0x00)
2	Load system configuration (System configuration)	0x0C	Config type: 0x0003 Device mode: 0x0000 (G3 normal mode)
3	Load system configuration (G3 configuration)	0x0C	Config type: 0x0008 COH: 0 (OFF) TMR: 1 (ON if TMR is used) G3 long address: unique ID* Note that the G3 long address should be little-endian order. As an example, 0x11 22 33 44 55 66 77 88 if your long address is 0x88 77 66 55 44 33 22 11.
4	SHUT_DOWN	0x05	Reset type: soft reset
2-second delay after receiving SHUT_DOWN.confirm			
5	SET_INFO (G3 PHY TX parameters)	0x04	Info type: 0x0002 Band selection: CENELEC/FCC/ARIB TX level: 0x20 (maximum) Modulation: Any value in [4] Tonemask: CEN A 36 (for CENELEC)
6	SET_INFO (G3 PHY RX parameters)	0x04	Info type: 0x0003 Band selection: CENELEC/FCC/ARIB COH/BLI: 0 AGC: 1 Gain value: 0 (ignored if AGC is set to 1) Tonemask: CEN A 36 (for CENELEC) The tonemask value should be the same as TX.
7	SET_MAC_PIB		adpLOADNGSequenceNumber (= (previous value + offset1)%0xFFFF) macFrameCounter (= (previous value + offset2)%0xFFFFFFFF) Note that the initial values are set to 0, and the offset calculation is given in 节 4.2.2.
8	Discover	0x12	Discover type: 0x00 - Network discover Duration: 12 (in seconds)
Choose one from a list of PAN Descriptors in Discover.confirm (based on LQI, fixed PAN ID searching and so on)			
9	Attach	0x10	PAN ID: CoordPANId from the PAN Descriptor LBA address: CoordAddr from the PAN descriptor

注: All reserved fields should be set to zero.

To avoid collisions between multiple nodes in the discovery stage, it is strongly recommended to add random back-off before sending Discover.request.

Step 7 is required when the DC assigns static short address for each service node.

4.2.2 Normal State

After the host receives ATTACH.confirm (SUCCESS), it is ready state to send and receive data.

4.2.2.1 Data Transfer

表 3. Data Transfer Message Configuration

SEQ	HOST MSG	MSG TYPE	PARAMETERS
1	DATA_TRANSFER	0x00	NSDU Handle: random value SEC: 1 QoS: 0 D-route:1 (This will automatically set up route to the destination whenever it is needed.) L_SDU data: IPv6 packet

Set D-route flag to 1, which allows the DSP to find a route to the destination if the route is not valid. The L_SDU data should be IPv6 packet. An example of UDP over IPv6 packet is given below.

```

60 00 00 00 00 23 11 08 FE 80 00 00 00 00 00 00 74 55 00 FF FE 00 00 00 FE 80 00 00 00 00 00 00 74
55 00 FF FE 00 00 01 00 00 00 00 00 23 13 43 A0 AA 00 00 00 00 00 00 01 00 00 00 01 00 00 00 01 00
00 00 03 00 00 00 31 31 31
    
```

- IPv6 header (40-byte in red-color with underline)
 - Next header: 17 (=UDP)
 - Payload length: 35
 - Hop limit: 8
 - Source address: FE80:0000:0000:0000:7455:00FF:FE00:0000
 - Destination address: FE80:0000:0000:0000:7455:00FF:FE00:0001
- UDP header (8-byte in blue-color with italic)
 - Source port: 0x0000
 - Destination port: 0x0000
 - Length: 35 (Note that the length should be the same as that of the IPv6 header)
 - CRC: 0x0000 (If the CRC is zero, UDP checksum will be ignored)
- Application payload
 - A0 AA 00 00 00 00 00 00 01 00 00 00 01 00 00 00 01 00 00 00 03 00 00 00 31 31 31

4.2.2.2 Keep-Alive Mechanism

The keep-alive mechanism is for the host to check if the DSP is alive or not. For this purpose, probe the PIBs given in 表 4. The host requires tracking of the PIB values and setting updated values (= the previous PIB value + offset) to the PIBs in the initialization routine when reset happens.

The ping interval can be implementation specific. The offset value depends on the ping interval. As an example, if the host set the ping interval to 2 minutes for macFrameCounter and the last update for the value is 100, then the macFrameCounter should be set to 1300 (= 2 minutes × 600 per minute + 100) when reset happens.

表 4. PIB for Keep-Alive

ATTRIBUTE	PIB ID	LENGTH	OFFSET
adpLOADNGSequenceNumber	0xa5	2	10 per minute
macFrameCounter	0x77	4	600 per minute

图 15. Keep-Alive Mechanism

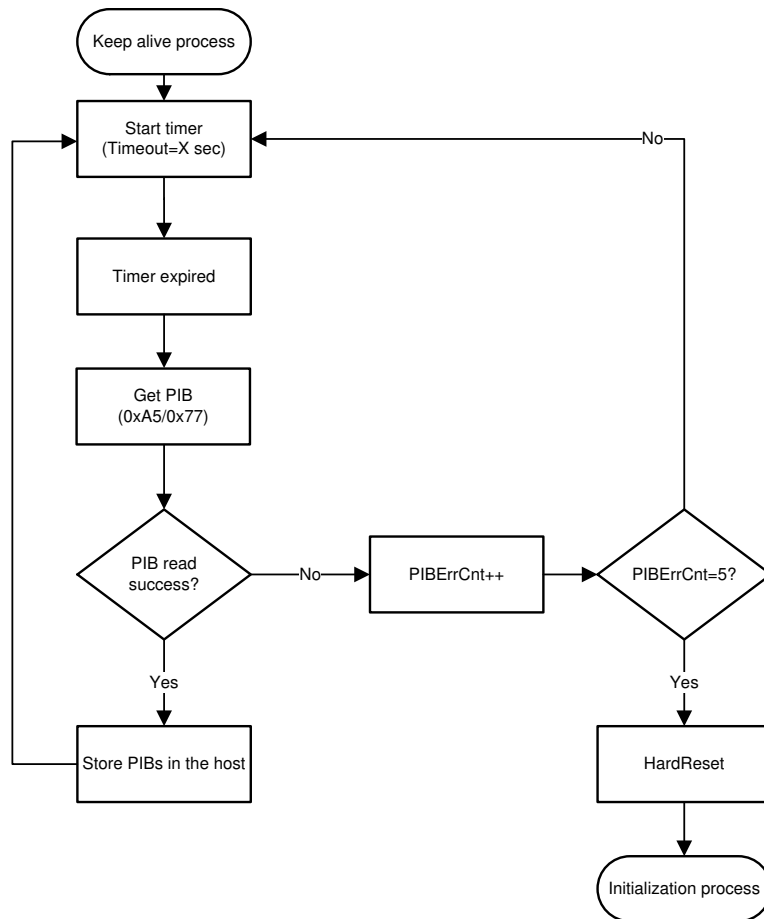

4.2.3 Error Handling

If the host does not receive confirmation from the DSP within the timeout given in 表 5, the host needs to retry until it reaches MaxRetryCnt (implementation-specific). If all the trials fail, hard reset to recover from the stage. The details are given in 图 16.

注: The host application has to wait until it receives a confirmation message to transmit the next message. The timeout value given in 表 5 can be used to indicate that the confirmation is lost.

表 5. Timeout Values for PLC Host Messages

MESSAGE	TIMEOUT
Attach.request	$T1 = \text{adpLBAMAXAttempts} \times \text{adpJoinWaitTime}$ (for example, 360 seconds with the default PIB setting) Note that changing the PIB values should apply to the timeout calculation.
Data transfer	T2 = 150 seconds (CENELEC) or 90 seconds (FCC)
Other messages	T3 = 5 seconds

图 16. Recovery and Timeout Mechanism

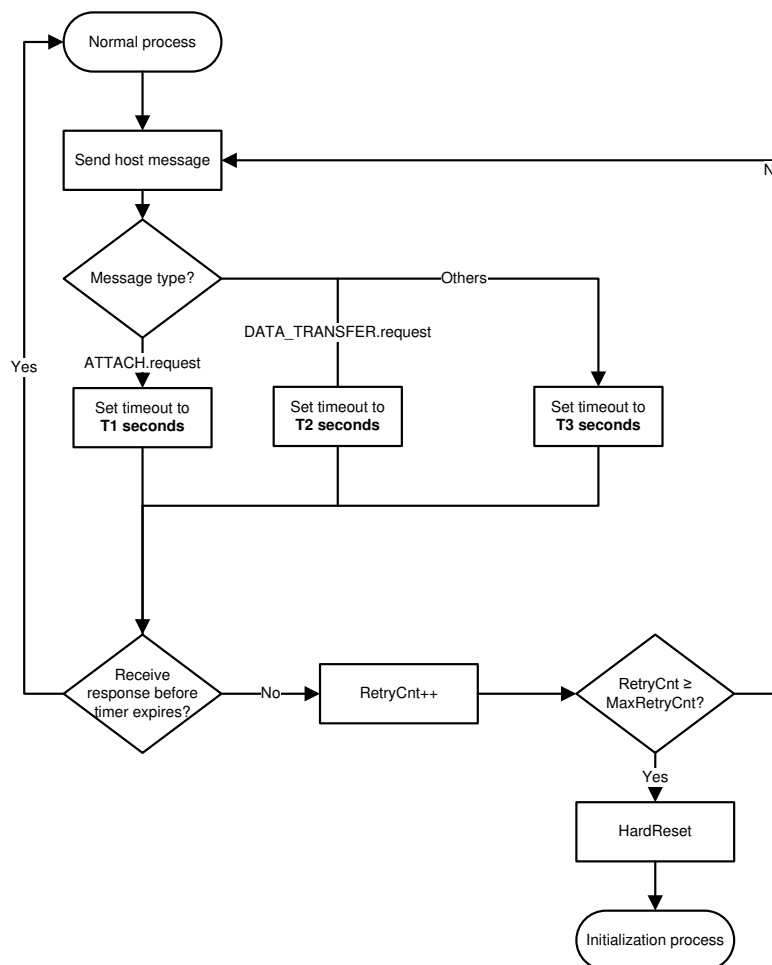

4.2.4 Firmware Upgrade

The details of host message exchanges for a firmware upgrade are described in Section 2.4 of the TI-PLC-G3-GENELC-SN software package *TI_G3_host_msg.pdf* [4].

4.3 Build HYBRID-RF-PLC Software Example Using CCS

The example project can be built with CCS IDE v9.0.1 (or above). The two CCS projects of HybridRfPlcExample_CC1310_LAUNCHXL_tirtos_ccs and tirtos_builds_CC1310_LAUNCHXL_release_ccs need to be opened to compile the project. The screen capture of the project view is shown in 图 17. Once successfully compiled, the binary file (HybridRfPlcExample_CC1310_LAUNCHXL_tirtos_ccs.out) will be generated in the directory of *debug*.

图 17. Build TIDC-HYBRID-RF-PLC CCS Project

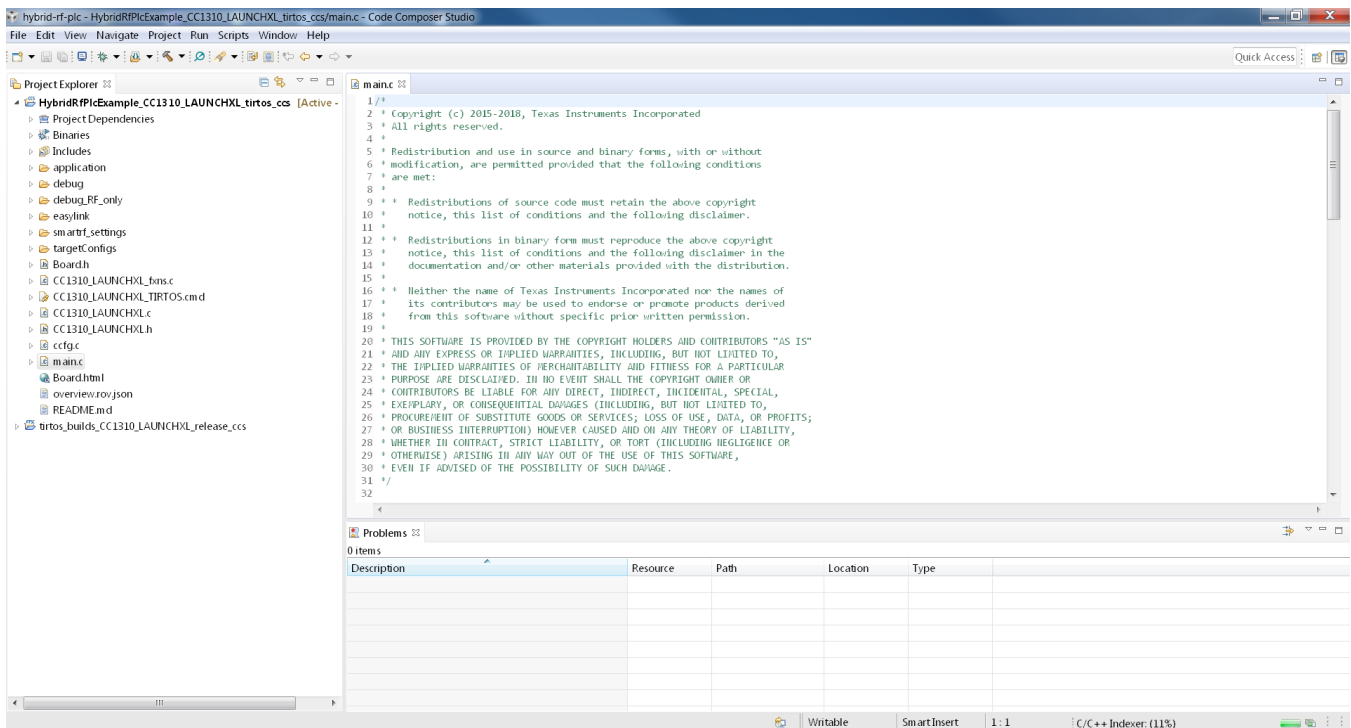

4.4 Flashing Binaries Using CCS

This section presents a step-by-step procedure to flash software binary to F28PLC84 (for G3-PLC) and CC1310 (for Hybrid RF/PLC application) devices, which is required to run the Hybrid RF/PLC node.

4.4.1 Flashing Hybrid RF/PLC Example Binary to CC1310 Using CCS

This section covers how to flash the Hybrid RF/PLC example binary on the CC1310 using CCS.

1. Connect the USB cable to LAUNCHXL-CC1310 EVM..
2. Launch the target configuration for CC1310 and connect to the device in hte CCS debug mode.
3. Select Run → Load → Load Program and flash the "HybridRfPlcExample_CC1310_LAUNCHXL_tirtos_ccs.out" binary in the directory of *debug*.

4.4.2 Flashing PLC Binary to TMS320F28PLC84

Find the step-by-step procedure in Section 7.1 (if using the XDS100 and CodeSkin to program the F28PLC84 MCU) or Section 7.2 (if using CCS and JTAG emulator to program the F28PLC84 MCU) in the TIDM-SOMPLC-G3-CENELEC reference design guide[7]. The latest G3-PLC software can be obtained from TI-PLC-G3-CENELEC-SN-F28PLC84 (<http://www.ti.com/tool/ti-plc-g3-cenelec-sn>).

5 Hybrid RF/PLC Test

The goal of the Hybrid RF/PLC test is to show simultaneous transmissions and RF-to-PLC repeater features with a 3-node set-up: one RF only, one PLC only, and one Hybrid RF/PLC node.

5.1 Test Setup

To run the Hybrid RF/PLC test, it is required to have the [LAUNCHXL-CC1310](#) and the [TMDSPCKITV4-CEN](#). Find both EVMs in the TI store (<https://store.ti.com/>). In addition, 表 6 summarizes the additional tools and software required to run the Hybrid RF/PLC test.

表 6. Required Tools for Hybrid RF/PLC Test Setup

DEVICE	EVM	HW MODIFICATION?	FLASH FIRMWARE?	GUI TOOL?
RF only	LAUNCHXL-CC1310	No	Yes ⁽¹⁾	No (or SmartRF studio without flashing the firmware)
PLC only	TMDSPCKITV4-CEN	No	Yes (节 4.4.2)	Yes (Zero-configuration GUI ⁽²⁾)
Hybrid RF/PLC	CC1310DK TMDSPCKITV4-CEN	No	Yes (节 4.4.1 and 节 4.4.2)	No

⁽¹⁾ The pre-built RF only standalone binary can be found in the debug_RF_only directory. This example echo back data received from the HYBRID-RF-PLC node.

⁽²⁾ Zero-configuration GUI is use to run PLC node as mini-DC to start G3-PLC network. The G3-PLC software package (<http://www.ti.com/tool/ti-plc-g3-cenelec-sn>) installs the GUI automatically.

5.2 Running Hybrid RF/PLC Test

图 18 shows the 3-node test setup. The RF only node runs with the SmartRF™ software tool and the PLC only node runs with zero-configuration graphical user interface (GUI) tool. The Hybrid RF/PLC node runs in standalone mode.

图 18. Hybrid RF/PLC Test Setup

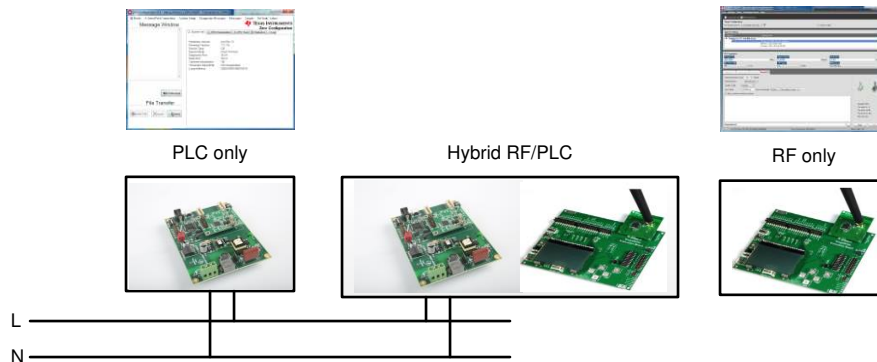

For the Hybrid RF/PLC test, the PLC only node is configured as the G3-PLC mini-DC node. The RF only node can run as the PACKET_RX mode to capture RF packets or the PACKET_TX mode to transmit RF packets. The PACKET_RX mode shows simultaneous transmissions from the Hybrid RF/PLC node, and the PACKET_TX mode shows RF-to-PLC repeater functionality on the Hybrid RF/PLC node.

When the Hybrid RF/PLC node starts, it will try to join to the PLC mini-DC (PLC only node) as the G3-PLC service node. The RF is running only PHY, so no joining is required. Once joined to the PLC network, the Hybrid RF/PLC node starts to send out 10B data to both RF and PLC nodes every 5 seconds. The PLC only and RF only node can capture the packet receptions through the GUI. In addition, the RF only or the PLC only nodes can generate data to show the RF-to-PLC repeater functionality on the Hybrid RF/PLC node. The Hybrid RF/PLC node can forward data received from one end (the RF only or PLC only node) to the other end. The receptions on the other end can be captured with the GUI tool.

5.2.1 Test Procedure

This section covers the step-by-step procedure to run the Hybrid RF/PLC test.

1. Start the PLC only node as mini-DC ([Steps 1 to 5](#) in [节 5.2.2](#)).
2. Start the RF only node in a standalone mode. (or use SmartRF studio to capture the RF packet RX.)
3. Once the Hybrid RF/PLC node is joined to the PLC network, an indication will show up in the mini-DC pop-up window ([Step 6](#) in [节 5.2.2](#)).
4. Check the simultaneous transmissions from Hybrid RF/PLC node on the GUI for the PLC([Step 7](#) in [节 5.2.2](#) for PLC). The RF only node can monitor the packet reception via the CCS debug window or SmartRF studio.

5.2.2 PLC Only Node Setup

This section covers how to run the PLC only node as mini-DC with the GUI.

1. Connect the PLC only node to the PC and open intermediate GUI.
2. Set a unique long address for each device by using "Set System Config."

图 19. Set System Configuration



图 20. G3-PLC System Configuration



3. Turn on "Log Raw Message Data" to see all the raw data exchanged between the GUI and C2000 PLC.

图 21. Log Raw Message Data

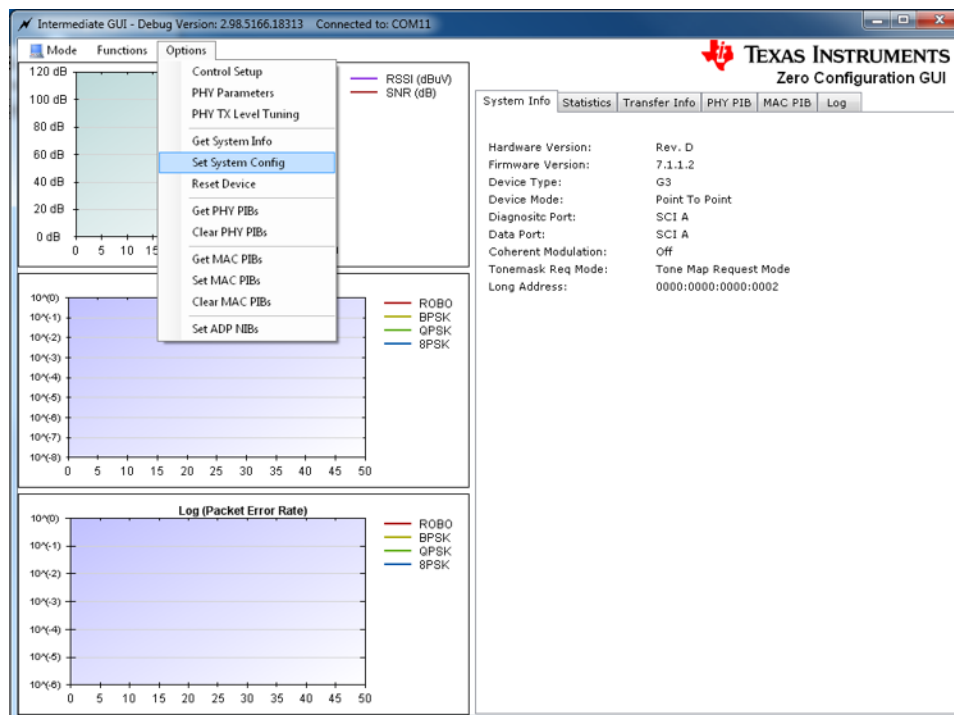
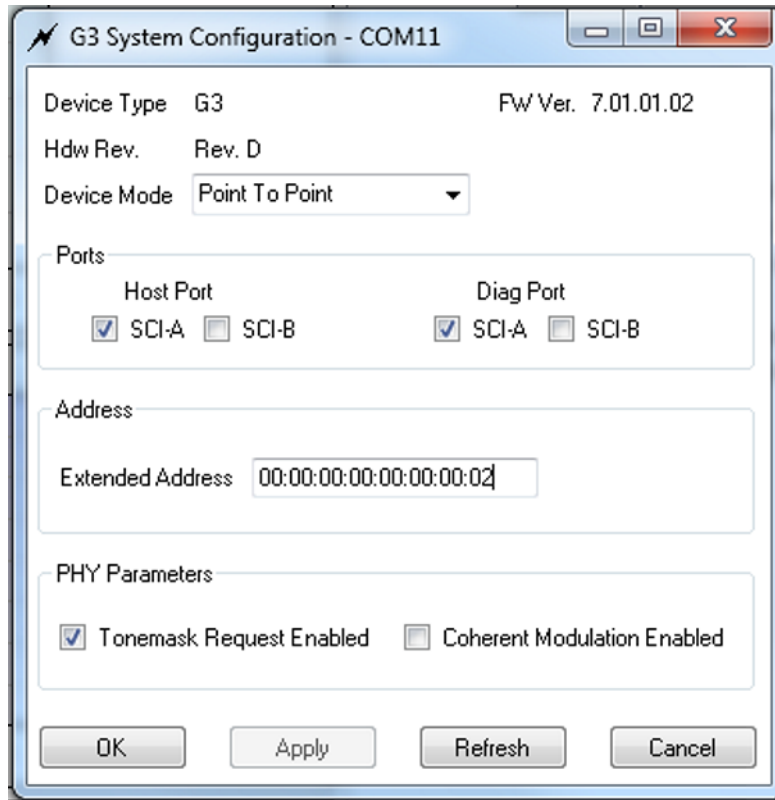
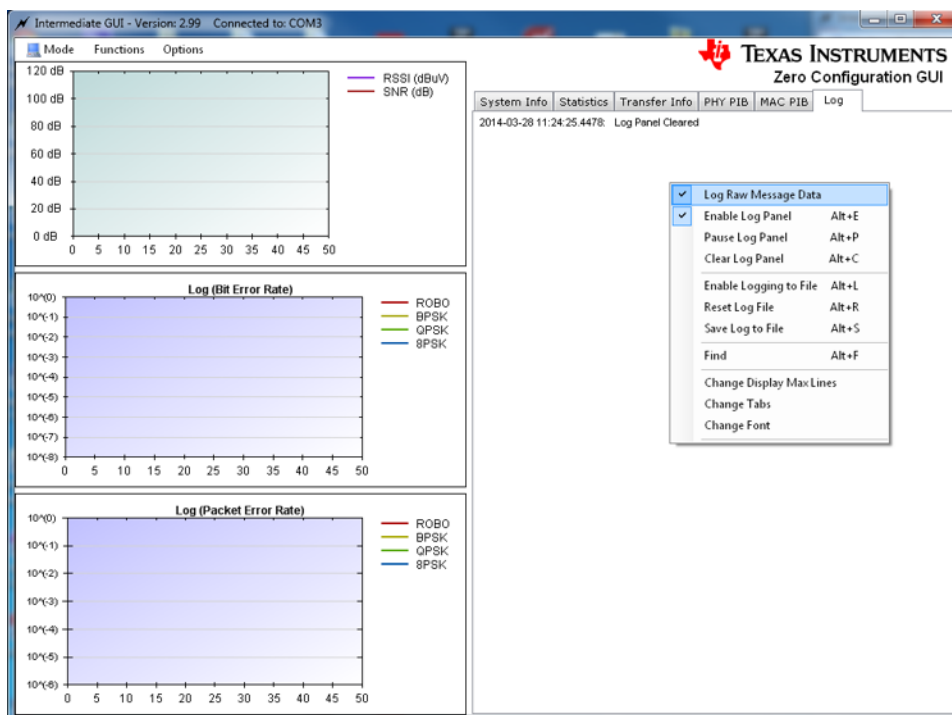

4. Start the device as mini-DC by selecting Functions → Start Base Node.

图 22. Start Base Node

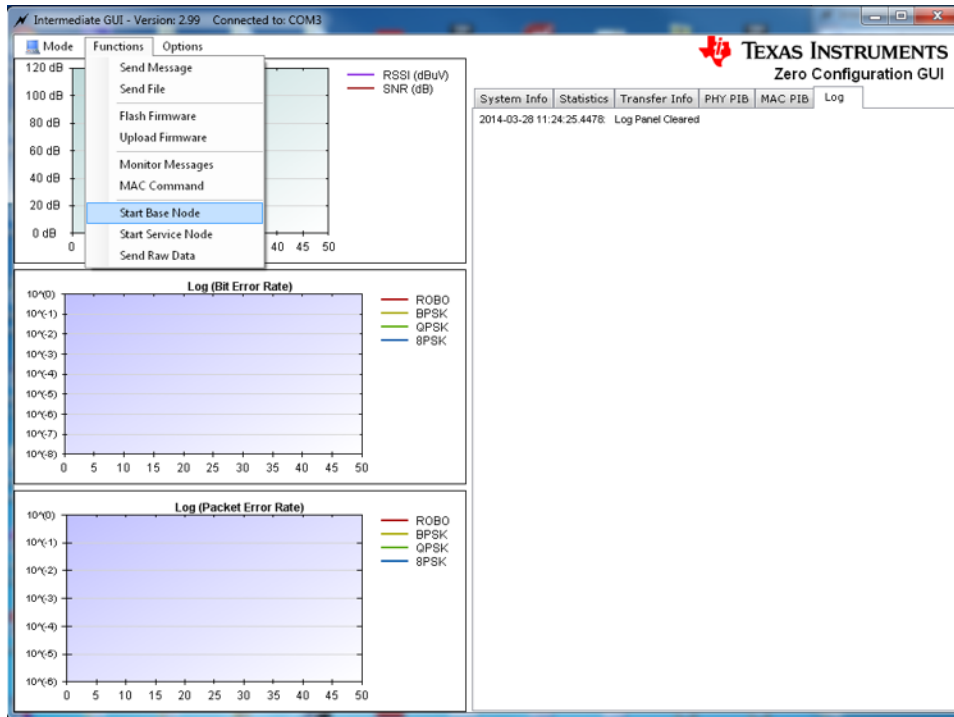

5. In the pop-up window of the G3 base node, click "Start Network".

图 23. Start Network With the G3 Base Node Window

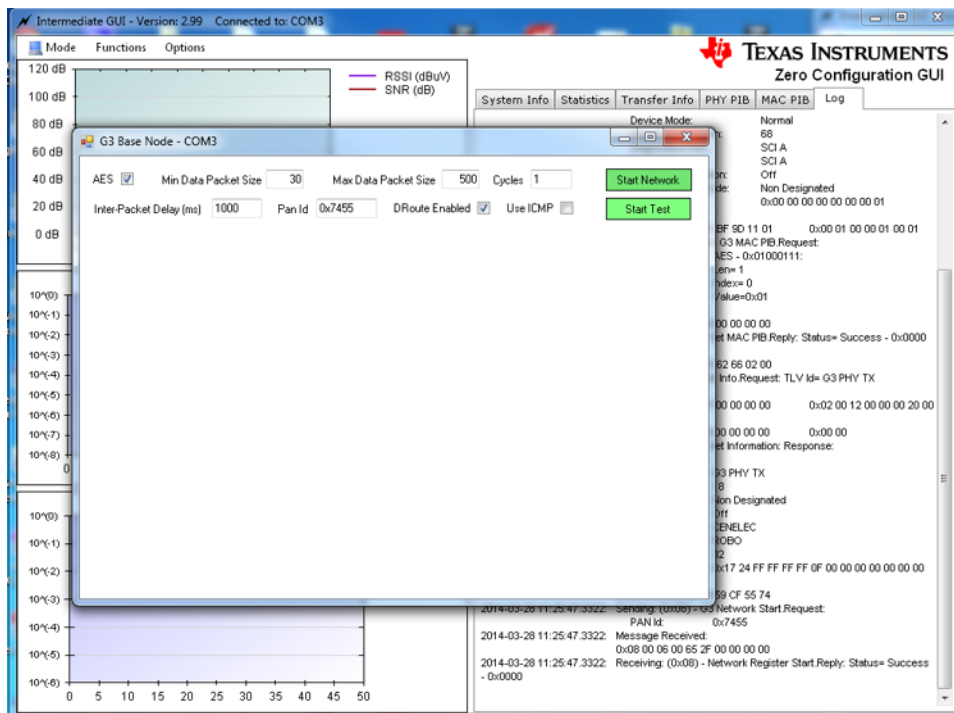

6. Once the Hybrid RF/PLC node is joined, the IPv6 information for the joined node is visible.

图 24. Joining Node Information in the G3 Base Node Window

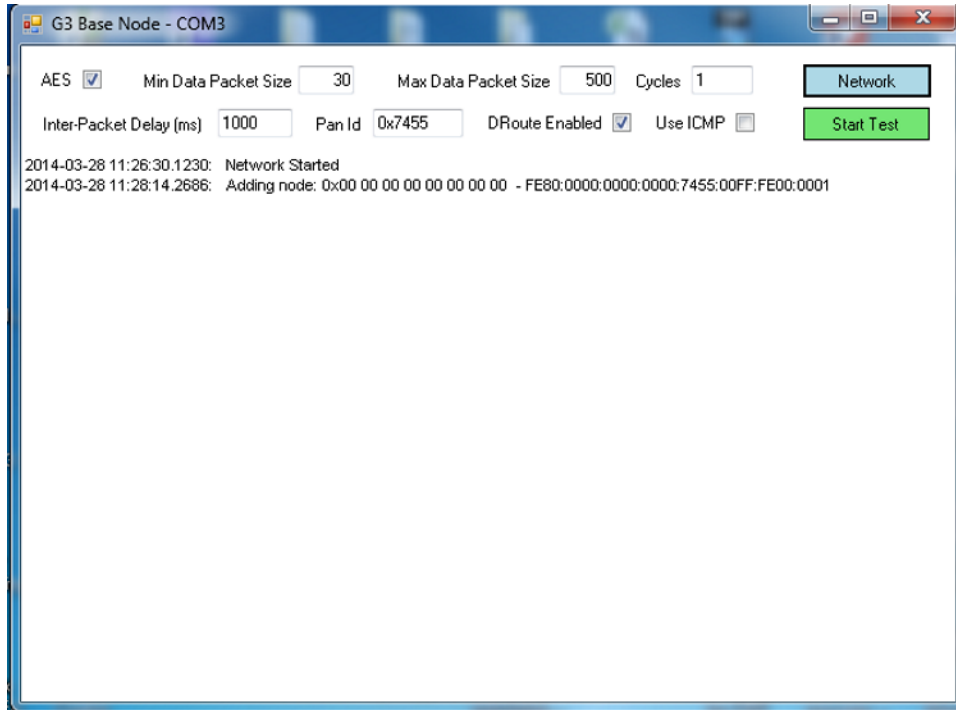

7. Go to the log window to trace all the received data (G3 Data Transfer Indication).

图 25. G3 Data Transfer Indication on the Log Window

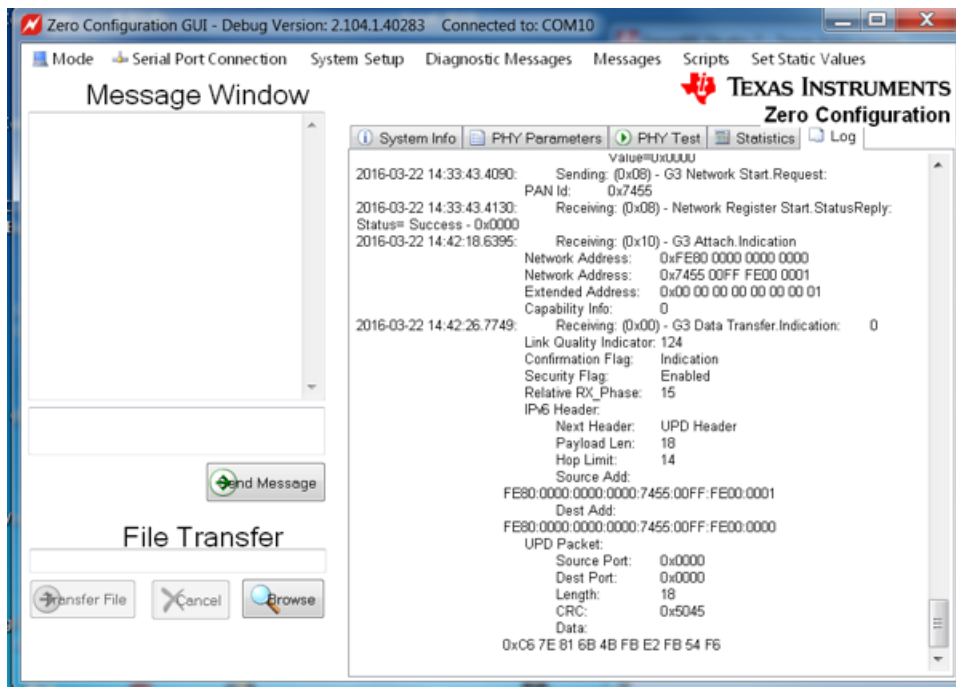

8. Set both "Min Data Packet Size" and "Max Data Packet Size" to less than 70B and with "Cycle" to 1 as shown in [图 26](#). In this capture, the packet size is set to 50B with cycles of 1. Then, send PLC data by selecting "Start Test."

图 26. Start Test in the G3 Base Node Window

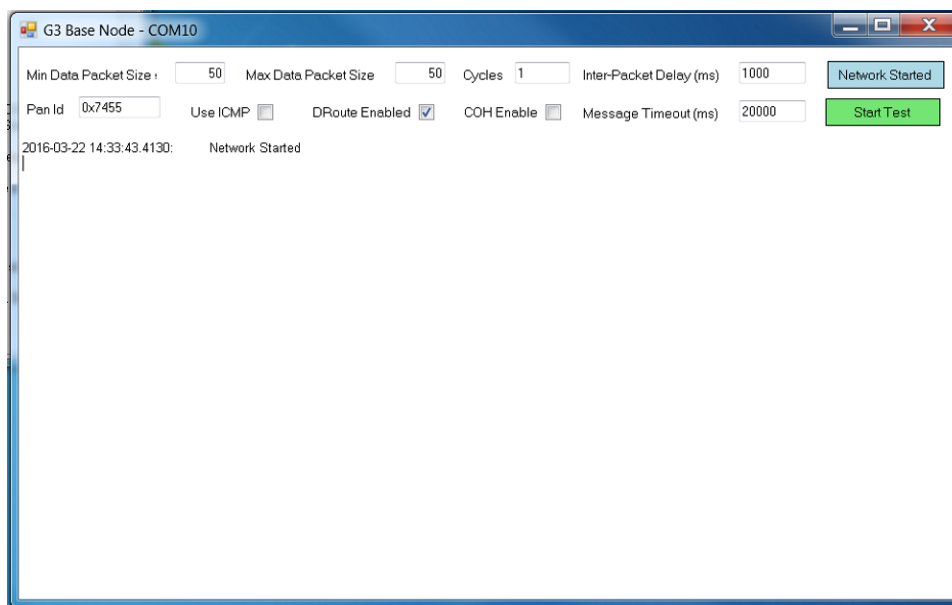

5.3 Hybrid RF/PLC Test Results

This section shows the Hybrid RF/PLC test results to verify simultaneous transmissions and RF-to-PLC repeater functionality.

图 27 shows the simultaneous transmission test results with a 3-node setup. The Hybrid RF/PLC node starts to send 10B packets with intervals of 5 seconds to both RF and PLC nodes once PLC completely joins the process. The zero-configuration GUI on the PLC only node shows 10B packet reception (G3 Data Transfer.Indication) in the log window (top of 图 27), and at the same time the RF only node receives the same packet (10B packet with RF sub-header information).

图 27. Simultaneous Transmissions



图 28 shows test results for PLC-to-RF repeater functionality. For the test, the PLC node sent a 50B UDP/IPV6 packet, meaning that the total packet size is 98B (50B payload + 40B IPv6 header + 8B UDP header). The zero-configuration GUI shows the packet transmission (G3 Data Transfer.Request) in the GUI. As a result, the Hybrid RF/PLC node forwarded the received PLC data to the RF link. Finally, the RF node shows the packet reception on the Packet RX window at the timestamp of 15:32:38.905. Note that, for this testing, the packet size sent by the PLC should be limited up to 70B because of the size limitation by the pre-programmed RF software. The RX packet size can be increased by flashing a new RF RX example binary with the increased maximum RX packet size.

图 28. PLC-to-RF Repeater

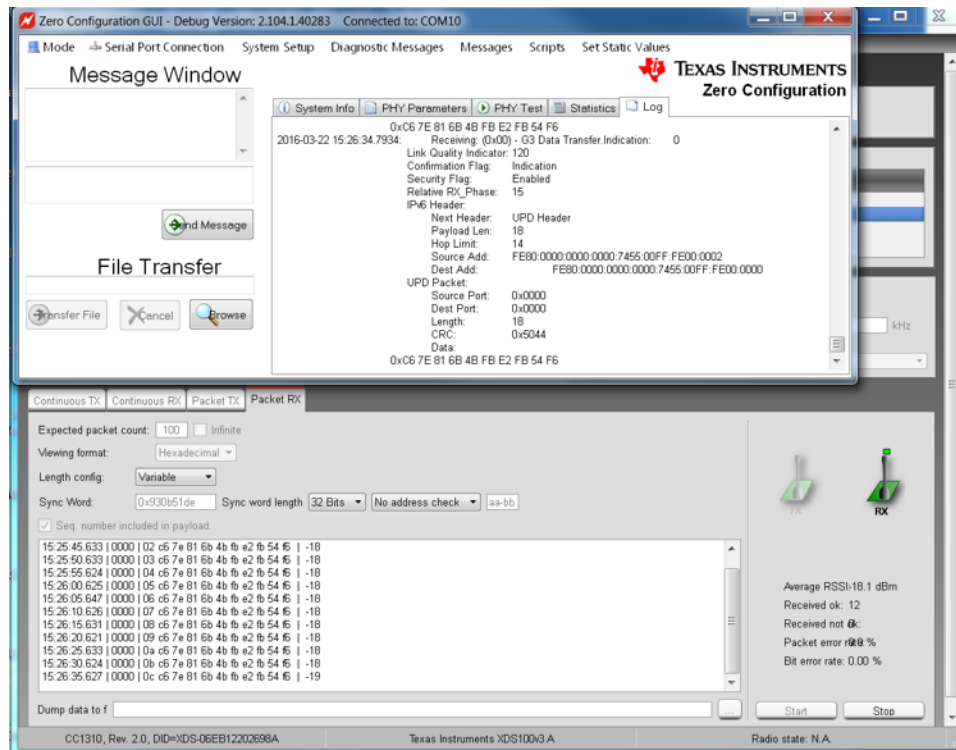

图 29 shows test results of the RF-to-PLC repeater. For the test, the RF node sent a 5B text message.

Once the 5B packet is received at the Hybrid RF/PLC node, the node passes the received data to the PLC link. The zero-configuration GUI shows the packet reception (in forms of G3 Data Transfer Indication) in the zero-configuration GUI (top in 图 29). The received packet at PLC includes 6B of information (5B message + 1B sub-header inserted by the RF transmitter).

图 29. RF-to-PLC Repeater

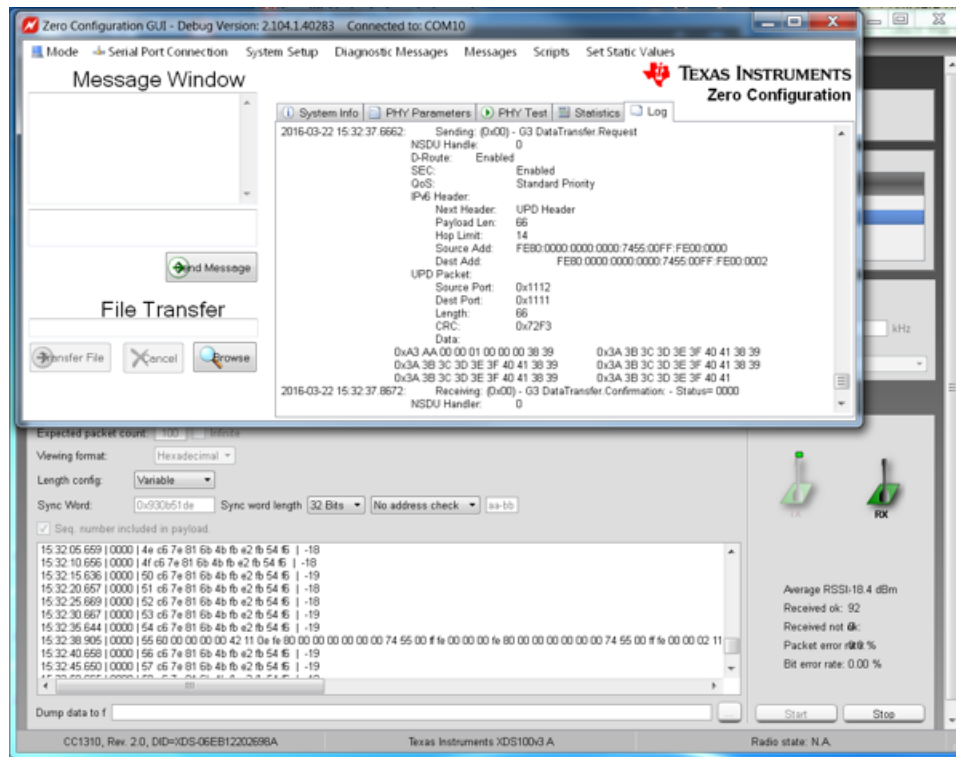
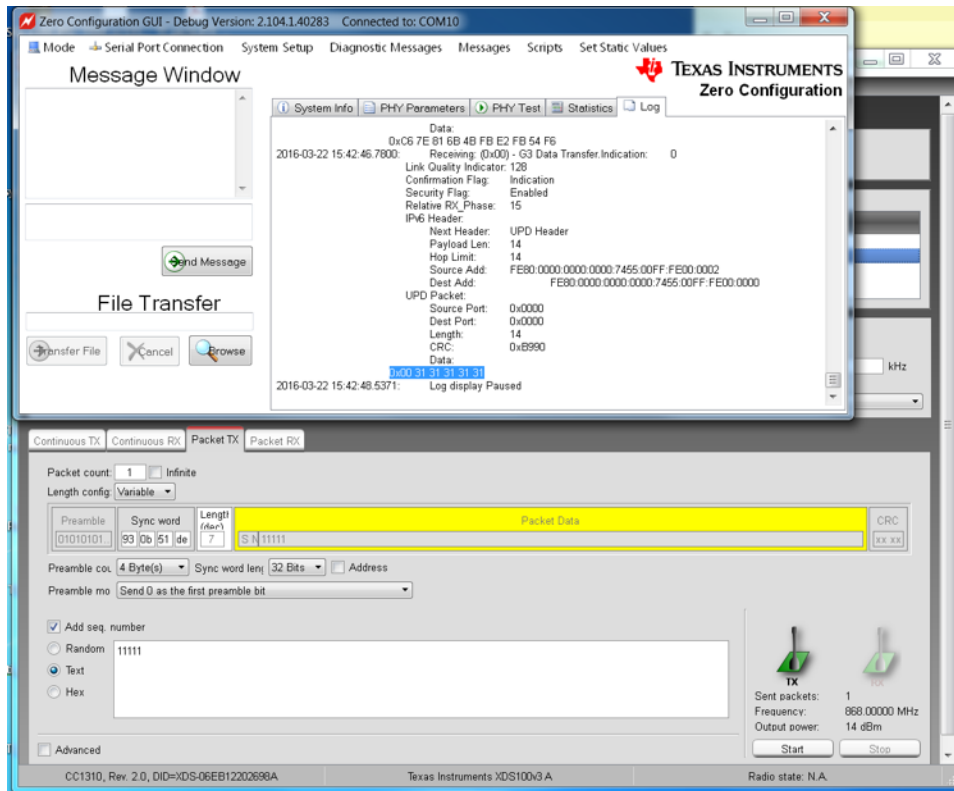

6 Design Files

6.1 Schematics

To download the schematics, see the design files at [TIDC-HYBRID-RF-PLC](#).

6.2 Bill of Materials

To download the bill of materials (BOM), see the design files at [TIDC-HYBRID-RF-PLC](#).

6.3 Layout Prints

To download the layer plots, see the design files at [TIDC-HYBRID-RF-PLC](#).

6.4 Gerber Files

To download the Gerber files, see the design files at [TIDC-HYBRID-RF-PLC](#).

6.5 Assembly Drawings

To download the assembly drawings, see the design files at [TIDC-HYBRID-RF-PLC](#).

7 Software Files

To download the software files, see the design files at [TIDC-HYBRID-RF-PLC](#).

8 References

1. Texas Instruments, *CC1310 SimpleLink™ Ultralow Power Sub-1-GHz Wireless MCU*, CC1310 Datasheet ([SWRS181](#))
2. Texas Instruments, *TMS320F28PLC8x Power Line Communications (PLC) Processors*, TMS320F28PLC8x Datasheet ([SPRS802](#))
3. Texas Instruments, *Powerline Communications Analog Front-End*, AFE031 Datasheet ([SBOS531](#))
4. Texas Instruments, *TI_G3_host_msg.pdf*, TI-PLC-G3-CENELEC-SN Software Package (<http://www.ti.com/tool/ti-plc-g3-cenelec-sn>)
5. Texas Instruments, *G3 Data Concentrator Power-Line Communication Modem*, TI-PLC-G3-DC Software Package (<http://www.ti.com/tool/ti-plc-g3-dc>)
6. Texas Instruments, *PRIME Data Concentrator Power-Line Communication Modem*, TI-PLC-PRIME-DC Software Package (<http://www.ti.com/tool/ti-plc-prime-dc>)
7. Texas Instruments, *System on Module for G3 Power Line Communication (CENELEC Frequency Band)*, TIDM-SOMPLC-G3-CENELEC Design Guide ([TIDU442](#))
8. Texas Instruments, *PLCLite Industrial Power-Line Communication Modem*, TI-PLC-PLCLITE Software Package (<http://www.ti.com/tool/ti-plc-plclite>)

8.1 商标

E2E is a trademark of Texas Instruments.

9 Terminology

PLC— Power line communication

RF— Radio frequency

TMR— ToneMap request

DC— Data concentrator

VCU— Viterbi/complex math unit

AMI— Advanced metering infrastructure

AFE— Analog front-end

10 About the Author

WONSOO KIM is a system engineer at Texas Instruments, where he is responsible for driving system solutions for Smart Grid applications, defining future requirements in TI's product roadmap, and providing system-level support and training focusing on communication software and systems for Smart Grid customers. He received the Ph.D. degree in electrical and computer engineering from the University of Texas at Austin, Austin, TX.

修订历史记录

注：之前版本的页码可能与当前版本有所不同。

Changes from Original (April 2016) to A Revision	Page
• 已更改 更改了“从预发布页面”	1

Changes from A Revision (May2016) to B Revision	Page
• 已更改 将 LAUNCHXL-CC1310CC1310DK 更改为 LAUNCHXL-CC1310.....	1
• 已更改 将 SIMPLELINK-CC13XO-SKDCC13XX 更改为 SIMPLELINK-CC13X0-SDK.....	1
• 已更改 CC13xx to CC1310	2
• 已更改 CC1310DK to LAUNCHXL-CC1310.....	11
• 已更改 hyperlink.....	11
• 已更改 CC1310DK to LAUNCHXL-CC1310 EVM	11
• 已更改 title from CC1310DK to LAUNCHXL-CC1310	11
• 已更改 paragraph text	12
• 已更改 paragraph text	13
• 已更改 title from Hybrid_RF-PLC-project to TIDC-HYBRID-RF-PLC Software Example	14
• 已更改 paragraph text	14
• 已更改 paragraph text	14
• 已更改 paragraph text	16
• 已更改 10 byte to 100 B	16
• 已添加 sentence	16
• 已更改 paragraph text	16
• 已更改 text in table	16
• 已更改 title from Build Hybrid_RF_PLC_Project Example Using CCS to Build HYBRID-RF-PLC Software Example Using CCS.....	22
• 已更改 paragraph text	22
• 已更改 title from Build Hybrid_RF_PLC Project to Build TIDC-HYBRID-RF-PLC CCS Project	22
• 已更改 CC1310DK to LAUNCHXL-CC1310 EVM	22
• 已更改 paragraph text	22
• 已更改 paragraph text	22
• 已更改 CC1310DK to LAUNCHXL-CC1310.....	23
• 已更改 hyperlink name	23
• 已更改 table text	23
• 已添加 note 1	23
• 已更改 paragraph text	24
• 已更改 paragraph text	24
• 已更改 paragraph text	29

重要声明和免责声明

TI“按原样”提供技术和可靠性数据（包括数据表）、设计资源（包括参考设计）、应用或其他设计建议、网络工具、安全信息和其他资源，不保证没有瑕疵且不做任何明示或暗示的担保，包括但不限于对适销性、某特定用途方面的适用性或不侵犯任何第三方知识产权的暗示担保。

这些资源可供使用 TI 产品进行设计的熟练开发人员使用。您将自行承担以下全部责任：(1) 针对您的应用选择合适的 TI 产品，(2) 设计、验证并测试您的应用，(3) 确保您的应用满足相应标准以及任何其他功能安全、信息安全、监管或其他要求。

这些资源如有变更，恕不另行通知。TI 授权您仅可将这些资源用于研发本资源所述的 TI 产品的应用。严禁对这些资源进行其他复制或展示。您无权使用任何其他 TI 知识产权或任何第三方知识产权。您应全额赔偿因在这些资源的使用中对 TI 及其代表造成的任何索赔、损害、成本、损失和债务，TI 对此概不负责。

TI 提供的产品受 [TI 的销售条款](#) 或 [ti.com](#) 上其他适用条款/TI 产品随附的其他适用条款的约束。TI 提供这些资源并不会扩展或以其他方式更改 TI 针对 TI 产品发布的适用的担保或担保免责声明。

TI 反对并拒绝您可能提出的任何其他或不同的条款。

邮寄地址：Texas Instruments, Post Office Box 655303, Dallas, Texas 75265

Copyright © 2022，德州仪器 (TI) 公司