



说明

此参考设计展示了适用于前照灯应用、完全自运行的三通道 TPS92682-Q1 和 TPS92520-Q1 LED 驱动器。此设计用于替换与汽车车身控制模块兼容的低成本卤素前照灯模块。三个 LED 通道可驱动远光灯/近光灯、转向灯、日间行车灯和位置标志灯。此设计将一个 TPS92682-Q1 双通道控制器用作恒压升压转换器和恒流 SEPIC 转换器。它还将一个通过升压转换器供电的 TPS92520-Q1 用于两个同步整流的恒流降压转换器。该电路板使用接地片设计，可包含功率级，从而符合 EMI 标准（包括 CISPR 25 5 类传导标准）。

资源

[TIDA-050040](#) 设计文件夹
[TPS92682-Q1、TPS92520-Q1、MSP432E401Y](#) 设计文件夹
[TPS92682EVM-070、TPS92682EVM-069、TIDA-050029](#) 产品文件夹

特性

- 两级恒压升压转换器为远光灯/近光灯和转向灯提供两个同步降压转换器
- 适用于日间行车灯和位置标志灯的 SEPIC 转换器
- 与车身控制模块的功率规格兼容
- 为远光灯/近光灯和转向灯提供单个 LED 短路、输出短路和灯串开路检测，实现故障报告和禁用
- 反向电池保护
- 远光灯/近光灯功率最大可达 30W
- 频率为 1.5Hz 且占空比为 50% 时转向灯功率最大可达 15W
- 从转向灯输入到输出的延迟不到 10ms
- 日间行车灯/位置灯功率高达 15W

应用

- 车身电子装置和照明

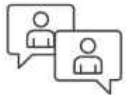

请咨询 TI 公司 TI E2E™ 支持专家

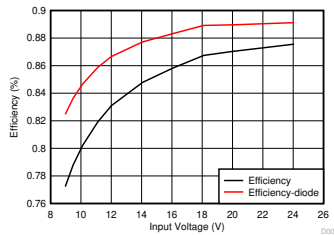

1 System Description

This reference design demonstrates a three channel LED driver for front headlight applications. The design uses a single channel of the TPS92682-Q1 for a constant voltage boost converter driving a two channel constant current synchronous buck converter, the TPS92520-Q1. Channel one of the TPS92520-Q1 provides up to 30 watts for Highbeam/Lowbeam applications. The Highbeam input is used to open or shunt the Highbeam section of the LED string, this determines Highbeam or Lowbeam operation. The second channel of the TPS92520-Q1 provides up to 15 watts for Turn Indicator applications. A switched input power of 1.5 Hz drives the Turn Indicator LED string with less than a 10 ms delay from the rising Turn Indicator input. The second channel of the TPS92682-Q1 is set up as a constant current SEPIC to provide up to 15 watts for Day Time Running Light/ Position Marker Light. The mode of operation is determined by the Highbeam/Lowbeam and Turn Indicator inputs. The design contains a MSP432 processor to program the TPS92682-Q1 and TPS92520-Q1 via SPI bus, control the headlight functions, read LED string voltages and report faults to the Body Control Module. Each function has its own reverse battery protected input.

This design has single LED short-fault reporting for Highbeam/Lowbeam and Turn Indicator. A Highbeam/Lowbeam fault reduces Lowbeam input current to zero to notify the automotive Body Control Module there is a fault. There is also an open collector fault line available. The Turn Indicator fault is an open collector fault line. Turn Indicator fault goes low when there is an open string, shorted string or shorted LED and the Turn Indicator is disabled. The Printed Circuit Board is setup to use an edge card connector, EC1. The board also has a ground strip to allow enclosing the power stages to meet CISPR 25 Class 5 conducted EMI levels.

Terminology

HB	Highbeam
LB	Lowbeam
TI	Turn Indicator
DRL	Daytime Running Light
POS	Position Marker Light

The Key System Specifications include the following:

表 1-1. TPS92682-Q1 Channel One Constant Voltage boost

BOOST	MINIMUM	TYPICAL	MAXIMUM	UNIT
Output Voltage	24	55	55	volts
Output power			45	watts
Maximum Power Input Voltage Range	9	13	16	volts
Input Voltage Range Reduced Power	6		24	volts
Switching Frequency		300		KHz

表 1-2. TPS92682-Q1 Channel Two Constant Current SEPIC

SEPIC	MINIMUM	TYPICAL	MAXIMUM	UNIT
Output Voltage	3	43	48	volts
Output Current	0.1	0.33	1	amps
Output Power	2		15	watts
Switching Frequency		300		KHz

表 1-3. TPS92520-Q1 Channel One Constant Current Buck Converter

BUCKS1	MINIMUM	TYPICAL	MAXIMUM	UNIT
Output Voltage	3	34	48	volts
Output Current	0.1	0.88	1.2	amps
Output Power			30	watts
Switching Frequency		400		KHz

表 1-4. TPS92520-Q1 Channel Two Constant Current Buck Converter

BUCKS2	MINIMUM	TYPICAL	MAXIMUM	UNIT
Output Voltage	3	33	48	volts
Output Current	0.1	0.43	1.2	amps
Output Power			15	watts
Switching Frequency		400		KHz

2 System Overview

This reference design is a self-contained LED headlight driver. Three power inputs, Lowbeam, Turn Indicator and Daytime Running Light/Position Marker Light are reverse battery protected. A fourth reverse battery protected signal input, Highbeam, determines whether to shunt or open via a MOSFET the Highbeam portion of the Highbeam/Lowbeam LED string. Daytime Running Light/Position Market light, as setup for testing, is always powered. Daytime Running Light/Position Marker Light function is determined by the other two power inputs Lowbeam and Turn Indicator. The test board is one of many possible configurations. A table shows light function based on inputs as configured for functional testing:

表 2-1. Headlight Function Truth Table

INPUT	INPUT	INPUT	OUTPUT	OUTPUT	OUTPUT	OUTPUT
Lowbeam	Highbeam	Turn Indicator	Lowbeam	Highbeam	Turn Indicator	DRL/POS
0	0	0	off	off	off	high
0	0	1.5 Hz	off	off	1.5 Hz	1.5 Hz
0	1	0	off	off	off	high
0	1	1.5 Hz	off	off	1.5 Hz	1.5 Hz
1	0	0	on	off	off	high
1	0	1.5 Hz	on	on	1.5 Hz	1.5 Hz
1	1	0	on	off	off	high
1	1	1.5 Hz	on	off	1.5 Hz	1.5 Hz

2.1 Block Diagram



图 2-1. TIDA050040 Block Diagram

2.2 Design Considerations

The printed circuit board is 56 mm X 102 mm including the edge card connector. Low profile components are on the top side to allow for a thermal interface to an enclosure for heatsinking. A ground strip is provided to enclose the power stages for EMI compliance. All tall components are on the bottom side including a connector for programming the MSP432 via JTAG, connector J3.

2.2.1 PCB Assembly

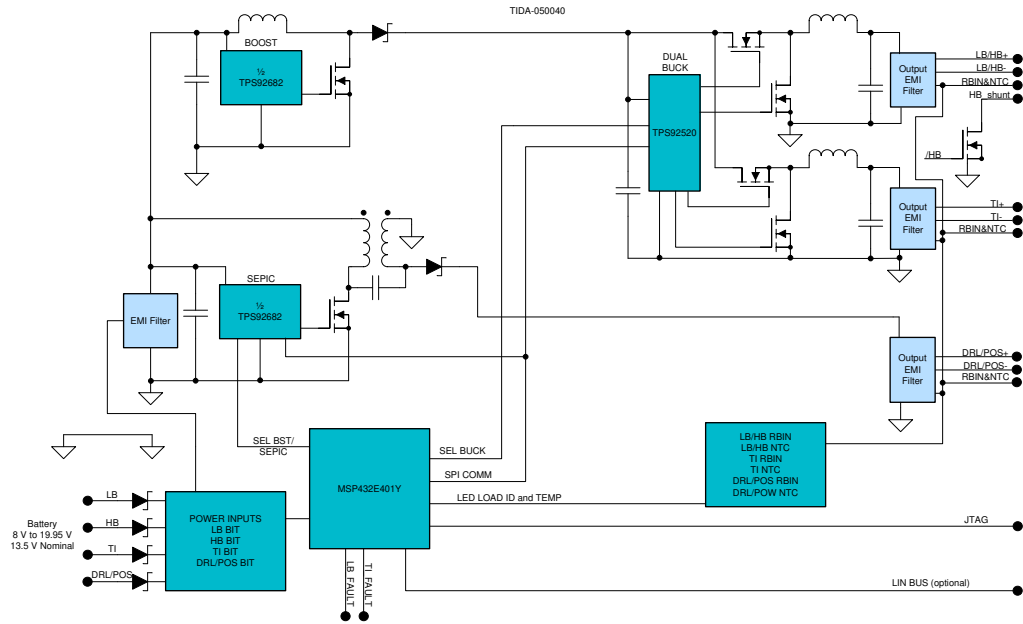
PCB top side with low profile parts, PCB bottom side with tall components

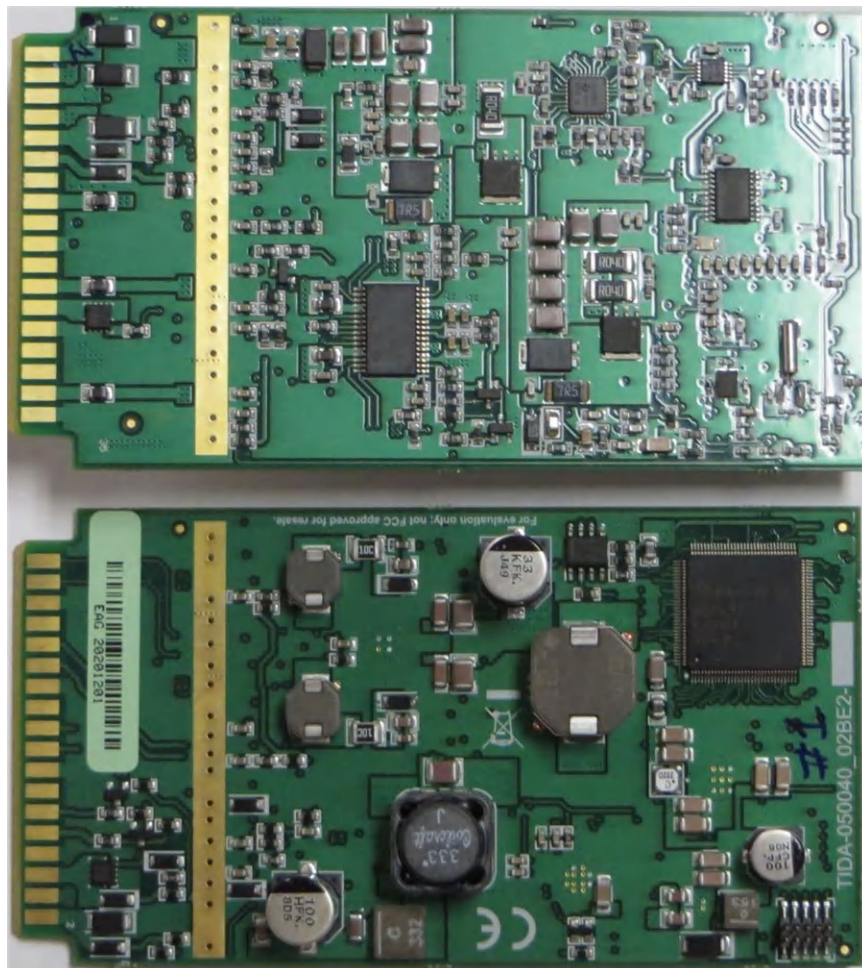

2.2.2 Top Side of PCB Assembly

Thermal pad can be used to conduct heat to an enclosure to remove heat from this side of the printed circuit board.

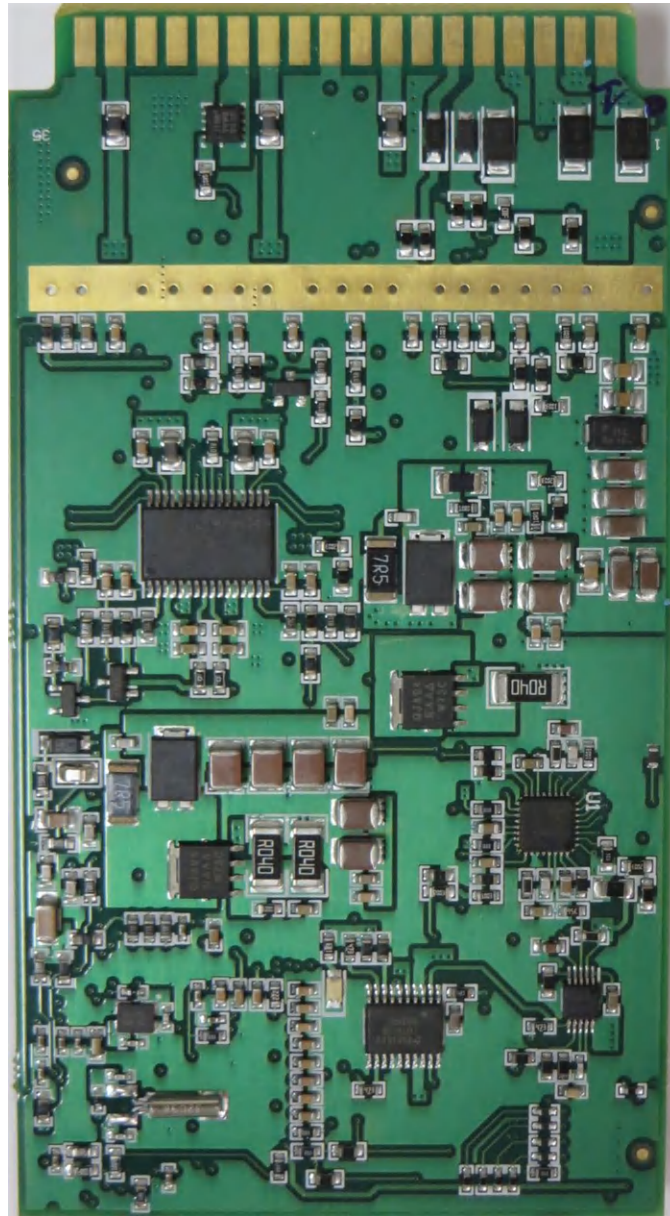

2.3 Highlighted Products

2.3.1 TPS92682-Q1

The TPS92682-Q1 is a dual-channel, peak current mode controller with SPI communication interface. The device is programmable to operate in constant-voltage (CV) or constant-current (CC) modes. In CV mode, TPS92682-Q1 can be programmed to operate as two independent or dual-phase Boost voltage regulators. The output voltage can be programmed using an external resistor voltage divider, and a SPI-programmable 8-bit DAC.

In CC mode, the device is designed to support dual channel step-up or step-down LED driver topologies. LED current can be independently modulated using analog or PWM dimming techniques. Analog dimming with over 28:1 range is obtained using a programmable 8-bit DAC. PWM dimming of LED current is achieved either by directly modulating the PWM input pins with the desired duty cycle, or using a SPI-programmable 10-bit PWM counter. The optional PDRV gate driver output can be used to drive an external P-Channel series MOSFET.

The TPS92682-Q1 incorporates an advanced SPI programmable diagnostic and fault protection mechanism including: cycle-by-cycle current limit, output overvoltage and undervoltage protection, ILED overcurrent protection, and thermal warning. The device also includes an open-drain fault indicator output per channel. The TPS92682-Q1 includes an LH pin, when pulled high, initiates the limp home (LH) condition. In LH mode, the device uses a separate set of SPI programmed registers.

2.3.2 TPS92682-Q1

The following image is the TPS92682-Q1 Functional Block Diagram.



图 2-2. TPS92682-Q1 Functional Block Diagram

2.3.3 TPS92520-Q1

The TPS92520-Q1 is a monolithic dual synchronous buck LED driver with a wide 4.5-V to 65-V operating input voltage range that can independently power two strings of series connected LEDs. The TPS92520-Q1 implements an adaptive on-time average current mode control and is designed to be compatible with shunt FET dimming techniques and LED matrix manager based dynamic beam headlamps. The adaptive on-time control provides near constant switching frequency that can be set between 100-kHz and 2.2-MHz. Inductor current sensing and closed loop feedback enables better than $\pm 4\%$ accuracy over wide input voltage, output voltage and ambient temperature range.

The high performance LED driver can independently modulate LED current using both analog or PWM dimming techniques. Linear analog dimming response with over 16:1 range is obtained by programming the 10-bit IADJ value via SPI. PWM dimming of LED current is achieved by directly modulating the corresponding UDIM input pin with the desired duty cycle or by enabling the internal PWM generator circuit. The PWM generator translates the 10-bit PWM register value to a corresponding duty cycle by comparing it to a programmable digital counter.

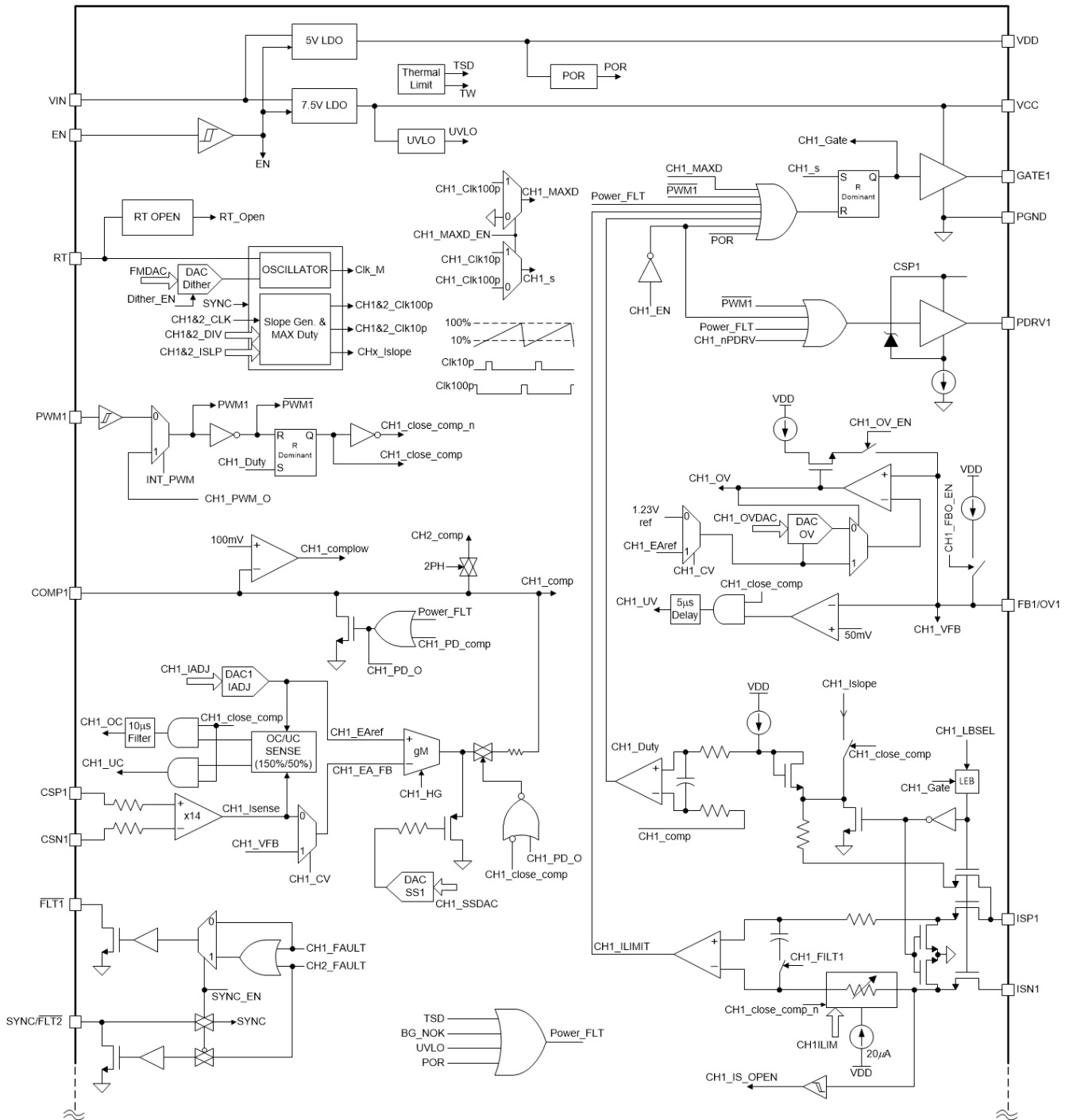
The TPS92520-Q1 incorporates advanced SPI programmable diagnostic and fault protection featuring: cycle-by-cycle switch current limit, bootstrap undervoltage, LED open, LED short, thermal warning and thermal shutdown. An on-board 10-bit ADC samples critical input parameters required for system health monitoring and diagnostics.

(The TPS92520-Q1 is available in a 8.1-mm x 11-mm thermally-enhanced 32-pin HTSSOP package with a 2.75-mm x 3.45-mm top-exposed and bottomexposed pad.)



图 2-3. TPS92520-Q1 Functional Block Diagram

2.3.4 MSP432

The SimpleLink MSP432E401Y Arm® Cortex®-M4F microcontrollers provide top performance and advanced integration. The product family is positioned for cost-effective applications requiring significant control processing and connectivity capabilities.

The MSP432E401Y microcontrollers integrate a large variety of rich communication features to enable a new class of highly connected designs with the ability to allow critical real-time control between performance and power. The microcontrollers feature integrated communication peripherals along with other high-performance analog and digital functions to offer a strong foundation for many different target uses, spanning from human-machine interface (HMI) to networked system management controllers.

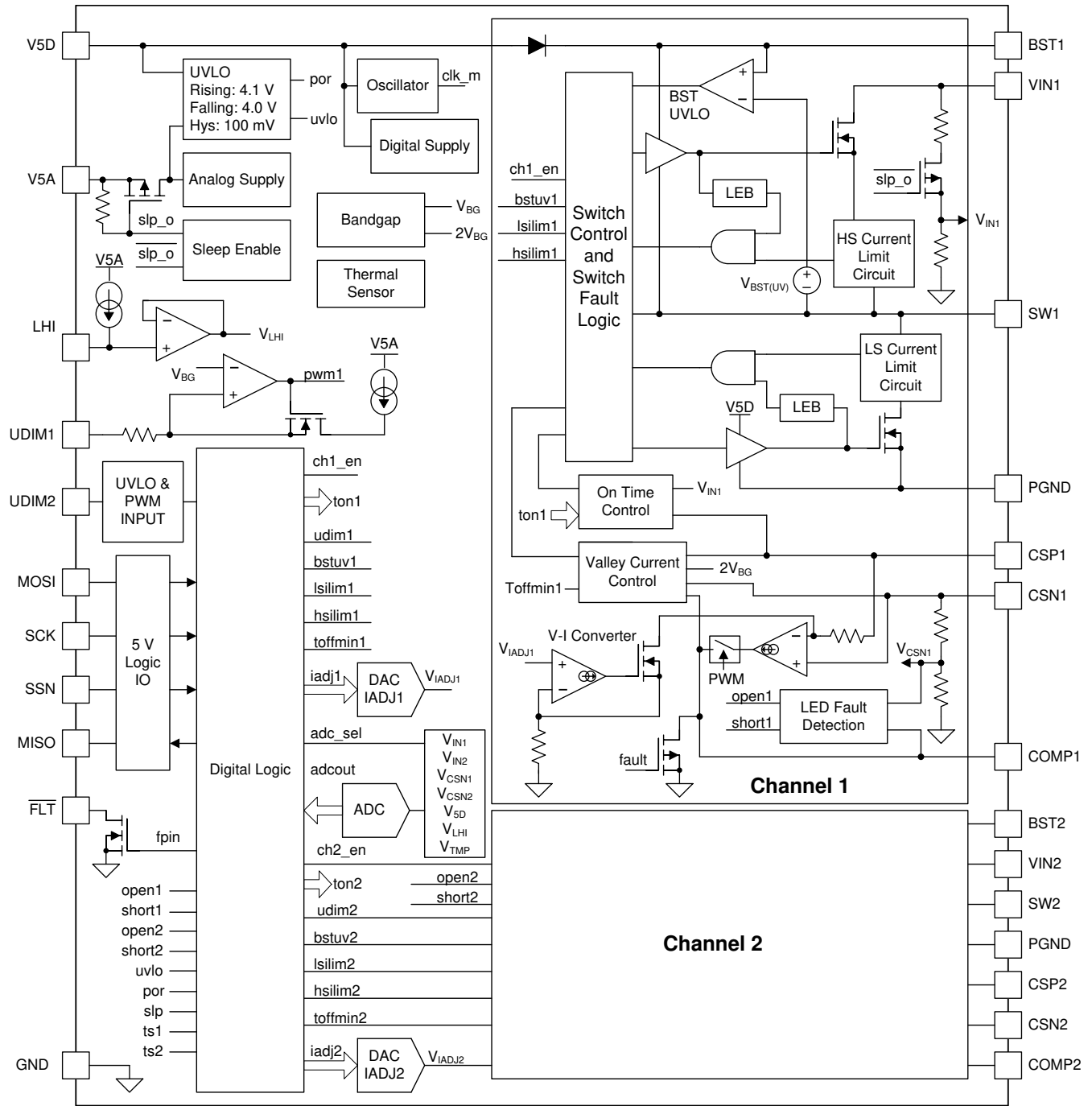

图 2-4. MSP432E401Y Functional Block Diagram

2.3.5 System Design Theory

The input power connects to EC1, the edge card connector, as three power inputs. Lowbeam power is fed to reverse protection diodes D19 and D20. 1.5 Hz Turn Indicator power is fed to reverse protection diode D12. Daytime Running Light/Position Marker Light power input is fed to reverse protection diode D18. A P-channel MOSFET, Q6, is across D18 to reduce Lowbeam input current to zero when there is a Highbeam/Lowbeam fault. All power lines are signal detected and sent to the microprocessor, U10. An additional input signal, Highbeam, is reverse diode protected and sent to the microprocessor. Highbeam is powered from the Lowbeam power input. HB_LED output is the drain of Q9 used to shunt the Highbeam portion of the Highbeam/Lowbeam LED string. All input power lines after the reverse protection diodes are tied together and sent to an EMI filter. The output of the EMI filter provides power to the TPS92682-Q1, channel one a Constant Voltage boost, channel two a Constant Current SEPIC converter. The Constant Voltage Boost feeds the TPS92520-Q1 dual buck converter for Highbeam/Lowbeam and Turn Indicator. A detailed design procedure can be found in the [TPS92682-Q1](#) data sheet and [TPS92520-Q1](#) data sheet.

Constant Voltage boost converter calculations:

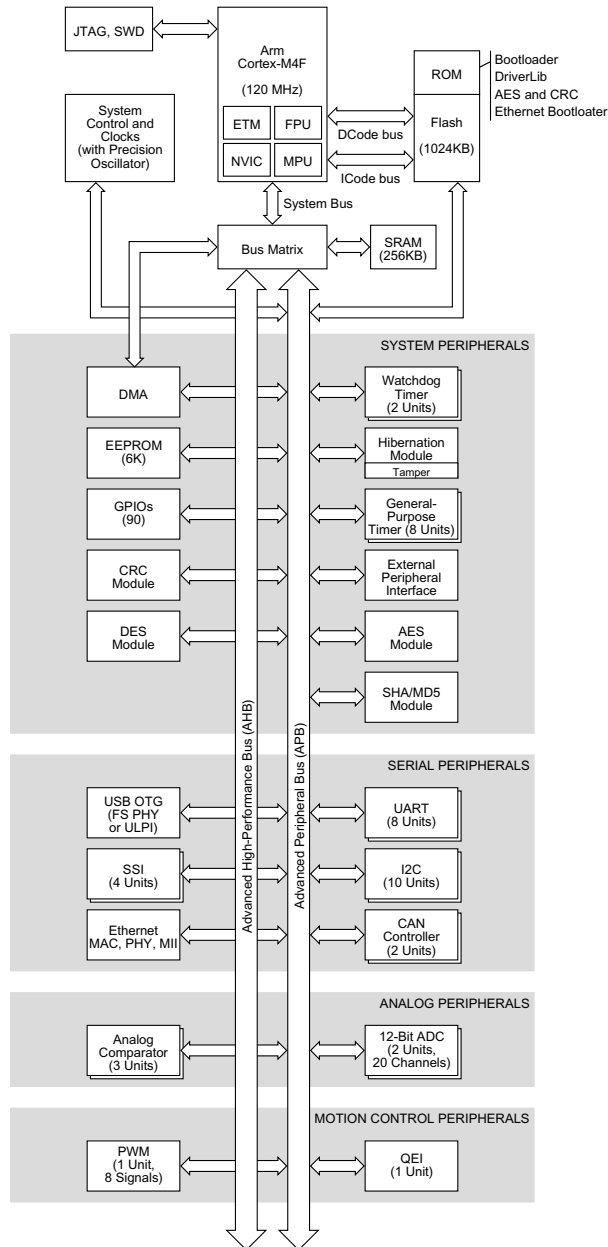
The Calculation for the timing resistor for 320 KHz switching frequency is:

$$R_T = \frac{10^{12}}{12.5 \times SW_{DIV} \times f_{sw}} = \frac{10^{12}}{12.5 \times 2 \times 320 \text{ kHz}} = 130 \text{ k}\Omega \quad (1)$$

where

- SW_{DIV} is 2. This is the default division factor in SW_{DIV} register 03h of the TPS92682-Q1 device.
- f_{sw} is the switching frequency of the circuit. A value of 130 k Ω is selected for R31.

Calculating Boost output power assuming a worst case buck converter efficiency of 90%:

$$P_{outbst} = \frac{P_{outbuck}}{0.9} = \frac{39 \text{ W}}{0.9} = 43.3 \text{ W} \quad (2)$$

The first step to calculate the cycle by cycle current limit resistor value is to calculate average maximum input current:

$$I_{inave} = \frac{P_{outbst}}{V_{inmin}} = \frac{43.3 \text{ W}}{8.0 \text{ V}} = 6.02 \text{ A} \quad (3)$$

where

- V_{inmin} is the minimum input voltage at maximum output power, 8.0V is used
- 0.9 is used for worst case Boost converter efficiency

The next step is to calculate the duty cycle at maximum input current:

$$D_{max} = \frac{V_{bst} + V_{bstdiode} - V_{inmin}}{V_{bst} + V_{bstdiode}} = \frac{55 \text{ V} + 0.7 \text{ V} - 8.0 \text{ V}}{55 \text{ V} + 0.7 \text{ V}} = 0.856 \quad (4)$$

where

- V_{bst} is the boost output voltage
- $V_{bstdiode}$ is the forward voltage of the boost diode, 0.7V is used
- V_{inmin} is the minimum voltage for maximum output power, 8.0V is used

Using the duty cycle the maximum average on-time input current can be calculated:

$$I_{inmax} = \frac{I_{inave}}{D_{max}} = \frac{6.02 \text{ A}}{0.856} = 7.03 \text{ A} \quad (5)$$

To calculate peak current the peak to peak current ripple at maximum output power needs to be calculated, the first step is calculating t_{on} :

$$t_{onmax} = \frac{1}{f_{sw}} \times D_{max} = \frac{1}{320 \text{ kHz}} \times 0.856 = 2.68 \text{ } \mu\text{s} \quad (6)$$

where

- f_{sw} is the switching frequency, 320 kHz

The peak to peak inductor ripple can be calculated using the previous calculations:

$$di_L = \frac{V_{inmin}}{L} \times t_{onmax} = \frac{8.0 \text{ V}}{22 \text{ } \mu\text{H}} \times 2.68 \text{ } \mu\text{s} = 0.973 \text{ A}_{pkpk} \quad (7)$$

where

- L is the inductor value, 22 μ H is chosen for this design

By summing the maximum average on-time current and half of the peak to peak current ripple the peak current can be calculated:

$$I_{peak} = I_{inmax} + \frac{di_L}{2} = 7.03 \text{ A} + \frac{0.973 \text{ A}}{2} = 7.514 \text{ A} \quad (8)$$

The maximum peak current can now be used to calculate the R_{is} resistor value

$$R_{ismax} = \frac{V_{ilim}}{I_{peak}} = \frac{0.228 \text{ V}}{7.514 \text{ A}} = 0.03 \text{ } \Omega \quad (9)$$

where

- V_{ilim} is the TPS92682-Q1 minimum peak current trip threshold when CHxILIM = 11, register 0x0E

The design uses two 0.04 ohm resistors in parallel for margin and testing.

Calculations for the TPS92520-Q1:

The two TPS92520-Q1 synchronous buck converters are set up with the same components and same operational range. The switching frequencies of the buck converters are 384 kHz for Lowbeam/Highbeam and 438 kHz for Turn Indicator set by registers 0x11 and 0x12.

Maximum current ripple occurs when V_{led} is half of the input voltage, using 400 kHz for the on-time and 50% duty cycle:

$$t_{onbuck} = \frac{1}{f_{sw}} \times 0.5 = \frac{1}{400 \text{ kHz}} \times 0.5 = 1.25 \text{ } \mu\text{s} \quad (10)$$

Peak to peak current ripple can be calculated using t_{onbuck} along with the inductor value and V_{led} at half of V_{bst} , 55V:

$$di_L = \frac{V_{bst}}{L} \times t_{onbuck} = \frac{55 \text{ V}}{68 \text{ } \mu\text{H}} \times 1.25 \text{ } \mu\text{s} = 0.506 \text{ A}_{pkpk} \quad (11)$$

where

- L is the inductor value, 68 μ H is chosen for this design
- f_{sw} is set to 400 kHz

Maximum output current for both channels using R_{CS} value:

$$I_{max} = \frac{V_{csmax}}{R_{cs}} = \frac{0.173 \text{ V}}{0.1 \Omega} = 1.73 \text{ A} \quad (12)$$

where

- V_{csmax} is 0.173V from the TPS92520-Q1 datasheet current sense threshold
- R_{CS} is the current sense resistor, 0.1 Ω is chosen

3 Hardware, Software, Testing Requirements, and Test Results

This reference design includes software for the MSP432 to program the TPS92682-Q1 and TPS92520-Q1 registers via SPI bus. The MSP432 software also determines Highbeam/Lowbeam, Turn Indicator and Day Time Running Light/Position Marker Light function from three power inputs and a Highbeam input signal. Functional operation and Faults are determined by reading binning resistors, NTC inputs and LED string voltages. Single LED fault detection for Highbeam/Lowbeam and Turn Indicator are determined by monitoring their output voltage. Reliability of detection can be improved by adding first turn on calibration and adding a load temperature, load current and LED string voltage table.

The TPS92682-Q1 register settings include the following:

表 3-1. TPS92682-Q1 and TPS92520-Q1 SPI Register Read and Write Values

TPS92682-Q1 SPI REGISTER ADDRESS	TPS92682-Q1 SPI REGISTER VALUE	COMMENT	TPS92520-Q1 SPI REGISTER ADDRESS	TPS92520-Q1 SPI REGISTER VALUE	COMMENT
Read Status Register			Read Status Register		
0x11	0x00		0x03	0x00	
0x12	0x00		0x04	0x00	
Write 682 Registers			0x05	0x00	
0x01	0x01		Write 520 Registers		
0x02	0x00		0x00	0x00	
0x03	0x00		0x01	0x00	
0x04	0x25		0x02	0x08	
0x05	0x0F		0x06	0x8A	
0x06	0xFF		0x07	0x00	
0x07	0xE7	Sets Boost Output to 55V	0x09	0x07	Sets LB/HB Current Low
0x08	0x0C	Sets SEPIC Current Low	0x08	0x00	Sets LB/HB Current Low
0x08	0x2B	Sets SEPIC Full Power	0x09	0x82	Sets LB/HB Full Power
0x09	0x41		0x08	0x00	Sets LB/HB Full Power
0x0B	0x0E		0x20	0x03	
0x0A	0x02		0x21	0x6A	
0x0D	0x00		0x0B	0x0E	Sets TI Current Low
0x0C	0x00		0x0A	0x02	Sets TI Current Low

表 3-1. TPS92682-Q1 and TPS92520-Q1 SPI Register Read and Write Values (continued)

TPS92682-Q1 SPI REGISTER ADDRESS	TPS92682-Q1 SPI REGISTER VALUE	COMMENT	TPS92520-Q1 SPI REGISTER ADDRESS	TPS92520-Q1 SPI REGISTER VALUE	COMMENT
0x0E	0x0F	SET ILIM	0x0B	0x41	Sets TI Full Power
0x0F	0x0A		0x0A	0x00	Sets TI Full Power
0x10	0x99		0x0C	0x07	
0x13	0x3C		0x0E	0x00	
0x14	0x2F		0x0D	0x40	
0x15	0x00		0x10	0x00	
0x16	0x44		0x0F	0x40	
0x17	0x3C		0x11	0x06	Set f_{sw} LB/HB
			0x12	0x07	Set f_{sw} TI
			0x1E	0x00	
			0x1F	0x00	
			0x22	0x00	
			0x23	0x10	
			0x24	0x00	
			0x25	0x10	
			0x26	0x00	
			0x27	0x00	
			0x28	0x00	
			0x29	0x00	
			0x2A	0x07	
			0x2B	0x07	
			0x2C	0x80	

MSP432 is programmed via JTAG, connector J3.

3.1 Hardware Requirements

Test setup showing switched inputs, outputs, PCB edge connector pin numbers and connections for measurements.



图 3-1. TIDA-50040 Test Connections for efficiency measurements, turn-on, turn-off delays and steady state operation

A 0 V to 25 V, 10A minimum DC lab supply is required for maximum power testing and efficiency measurements. For testing a Hewlett Packard 6010A DC supply provides power to the test board. Custom software is loaded to allow full output power from each stage when powered from their respective inputs. Four volt meters measure input voltage and current as well as each channel's output voltage and current. Input current is measured through a current shunt, output currents are measured across a 0.1Ω precision resistor. A tektronics TDS5054B displayed oscilloscope measurements for voltage and current waveforms. To run maximum output power a custom LED load board was developed. A function generator set to 1.5 Hz 0 V to 5 V drives the Turn Indicator input for delay measurements.

The Turn Indicator LED load to operate with single LED fault detection needs to fall within 6.9 V to 7.7 V at 40 mA using four amber LEDs. The LED load for Lowbeam needs to fall within 10 V to 11.2 V at 70 mA using four white LEDs. The LED load for Highbeam needs to fall within 20.2 V to 22.4 V using eight LEDs, four for Lowbeam in series with four for Highbeam. The center of the string ties to HB_LED to allow shunt of the Highbeam portion of the LED string. The RBIN resistor to ground value for Lowbeam is $20 k\Omega$. The RBIN resistors for Turn Indicator and Daytime Running Light are $30 k\Omega$.

表 3-2. Edge Card Connector pin Description, Highbeam (HB), Lowbeam (LB), Turn indicator (TI), Daytime Running Light (DRL), Position Marker light (POS)

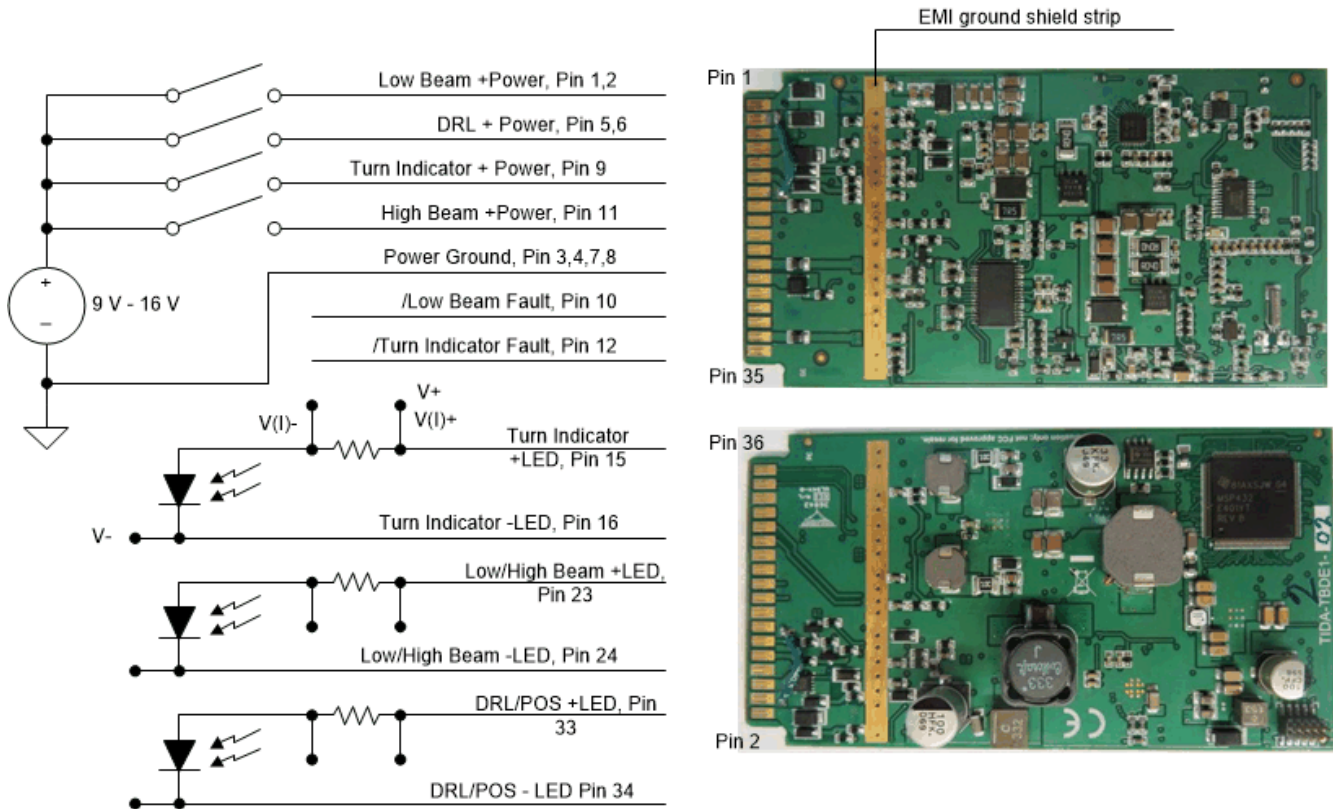
PIN NUMBER	PIN NAME	PIN DESCRIPTION	PIN NUMBER	PIN NAME	PIN DESCRIPTION
1	LB1	Power Input for LB and HB	2	LB2	Power Input for LB and HB
3	Power GND	Input Power Ground	4	Power GND	Input Power Ground
5	DRLPOS1	Power input for DRL/POS	6	DRLPOS2	Input Power for DRL/POS
7	Power GND	Input Power Ground	8	Power Ground	Input Power Ground
9	TI	Power Input for TI	10	LB_Fault	Open Collector HB/LB Fault
11	HB	Signal Input for HB shunt MOSFET	12	TI_Fault	Open Collector TI Fault
13	NC		14	NC	
15	DRLPOS+	DRL/POS +LED Connection	16	Power GND	DRL/POS -LED Connection
17	NC		18	DRLPOS_RBIN	DRL/POS Binning Resistor Input
19	Signal GND	Return for RBIN and NTC	20	DRLPOS_NTC	DRL/POS Thermal Feedback
21	NC		22	NC	
23	LBHB+	LB/HB +LED Connection	24	Power GND	LB/HB -LED Connection
25	HB_LED	HB Shunt Output	26	LBHB_RBIN	LB/HB Binning Resistor
27	Signal GND	Return for RBIN and NTC	28	LBHB_NTC	LB/HB Thermal Feedback
29	NC		30	NC	
31	NC		32	Power GND	TI -LED Connection
33	TI+	TI +LED Connection	34	TI_RBIN	TI Binning Resistor
35	Signal GND	Return for RVIN and NTC	36	TI_NTC	TI Thermal Feedback

3.1.1 CISPR 25 Class 5 Test Setup

CISPR 25 Class 5 test setup showing LED load board and TIDA-050040 board in an enclosure. The system is in a test chamber powered by a 12V battery.



图 3-2. CISPR 25 Class 5 test setup

3.1.2 LED Load Board Top

LED side of the LED load board for testing efficiency, collecting waveforms and EMI measurements

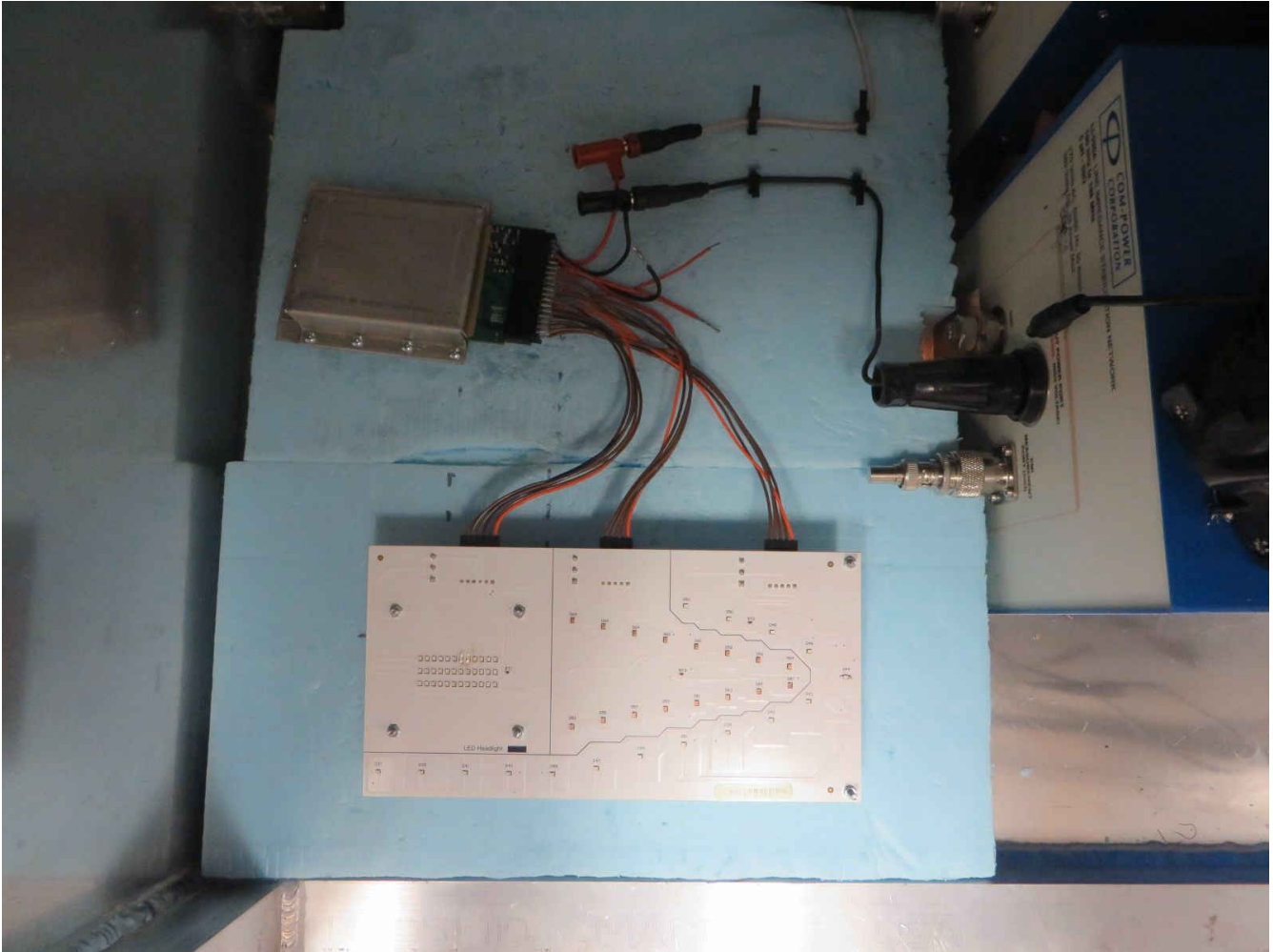

图 3-3. LED Load Board Top

3.1.3 LED Load Board Bottom

Connector and heatsink side of the LED load board for testing efficiency, waveforms and EMI

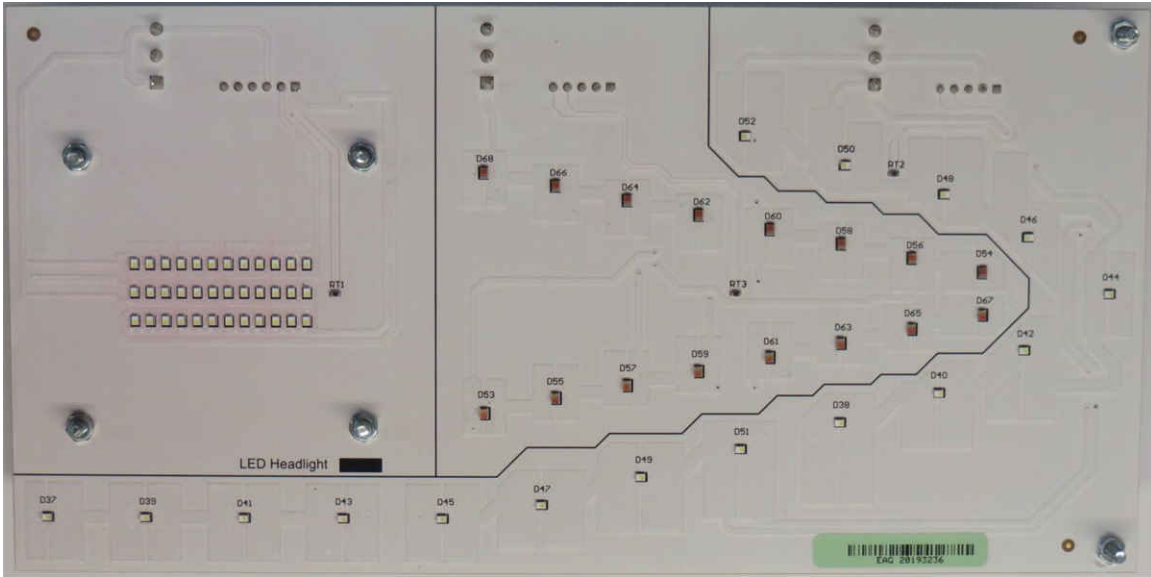

图 3-4. LED Load Board Bottom

3.2 Test Setup

Test results include multiple oscilloscope waveforms, efficiency graphs and a CISPR 25 Class 5 EMI measurement. Multiple operational configurations were run for the following test results. Two Digital Multimeters measure input voltage and input current through a voltage measurement across a 0.075 Ω precision shunt. Two

additional Digital Multimeters measure each output channel's voltage and current via a 0.1 Ω precision resistors. Input voltage range used was 6 V to 24 V.

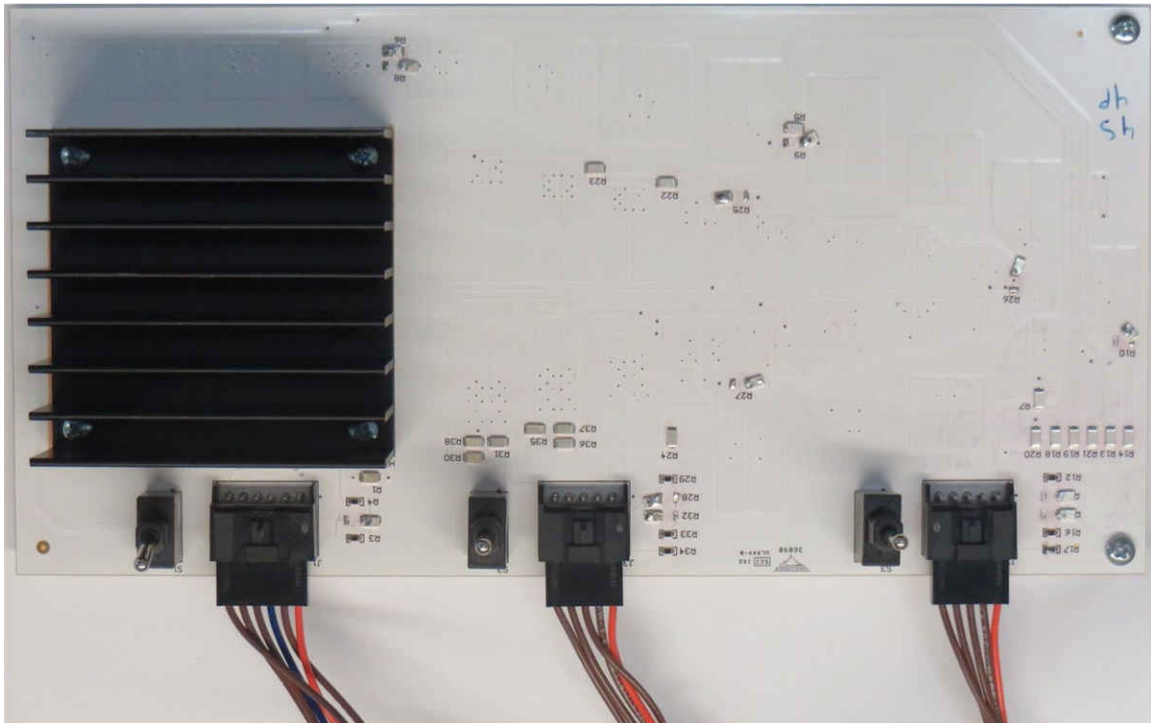
3.3 Test Results

3.3.1 Boost Turn on Delay

The following data represents the operation of the design showing many of the boards functions.

Boost turn on delay after power applied, 13 V to 55 V (yellow), Highbeam/Lowbeam current (green).



图 3-5. Boost Turn on Delay

3.3.2 Highbeam/Lowbeam Turn on Delay

Highbeam/Lowbeam turn-on delay. Boost at 55 V (yellow) Highbeam/Lowbeam current (green).

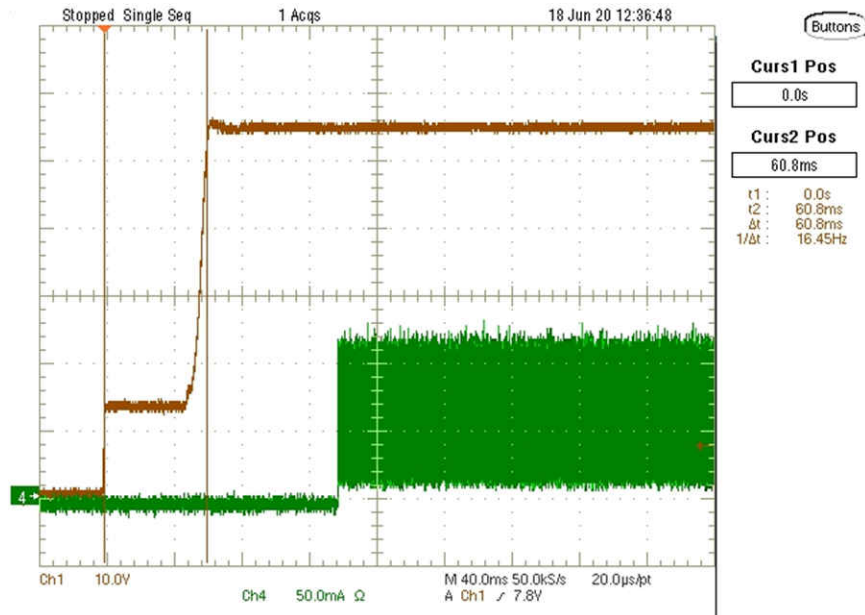

图 3-6. Highbeam/Lowbeam Turn on Delay

3.3.3 Highbeam/Lowbeam Switch Node and Ripple Current

Highbeam/Lowbeam switch node (yellow), switching frequency at 880 mA output current (green).

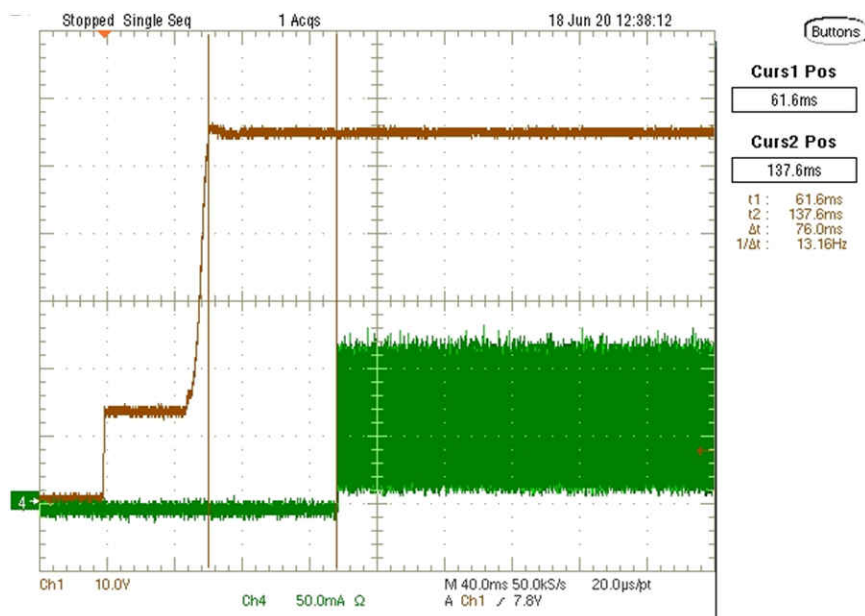

图 3-7. Highbeam/Lowbeam Switch Node and Ripple Current

3.3.4 Turn Indicator Turn on Delay

Turn Indicator input rising (blue), Turn Indicator output (yellow) and current (green).

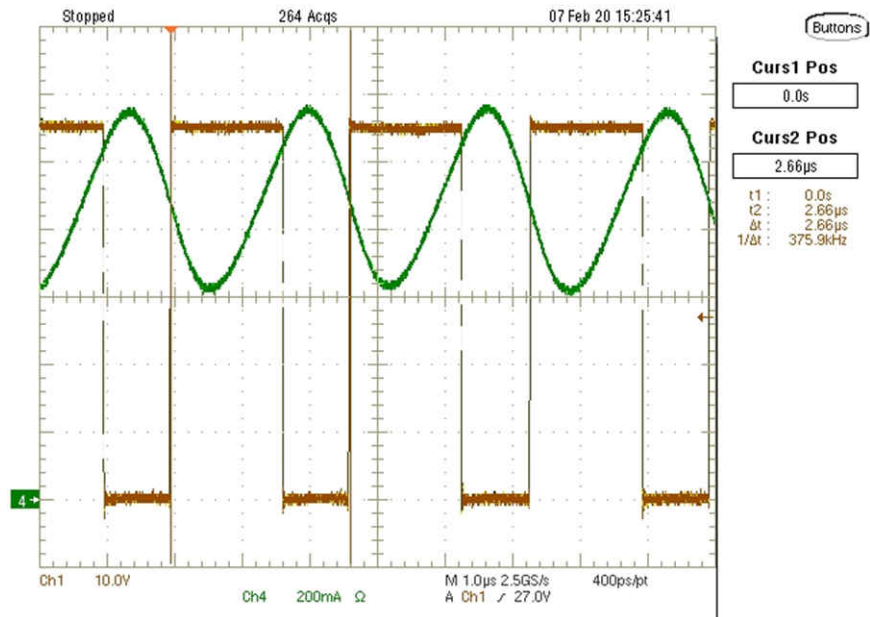

图 3-8. Turn Indicator Turn on Delay

3.3.5 Turn Indicator Turn Off Delay

Turn Indicator input falling (blue), Turn Indicator voltage output (yellow) and current (green).

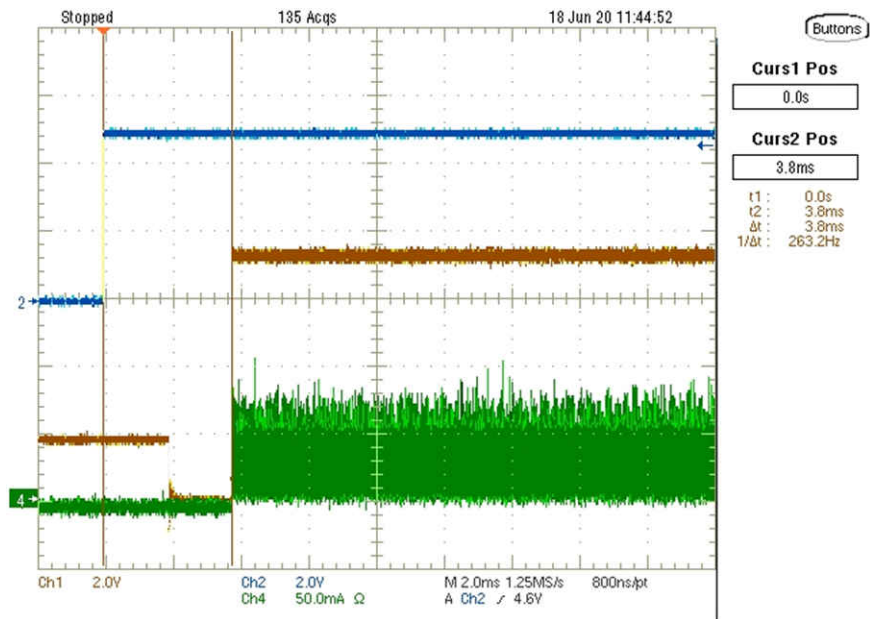

图 3-9. Turn Indicator Turn Off Delay

3.3.6 Turn Indicator 1.5 Hz Operation

1.5 Hz Turn Indicator input (blue), Turn Indicator output (yellow) and current (green).

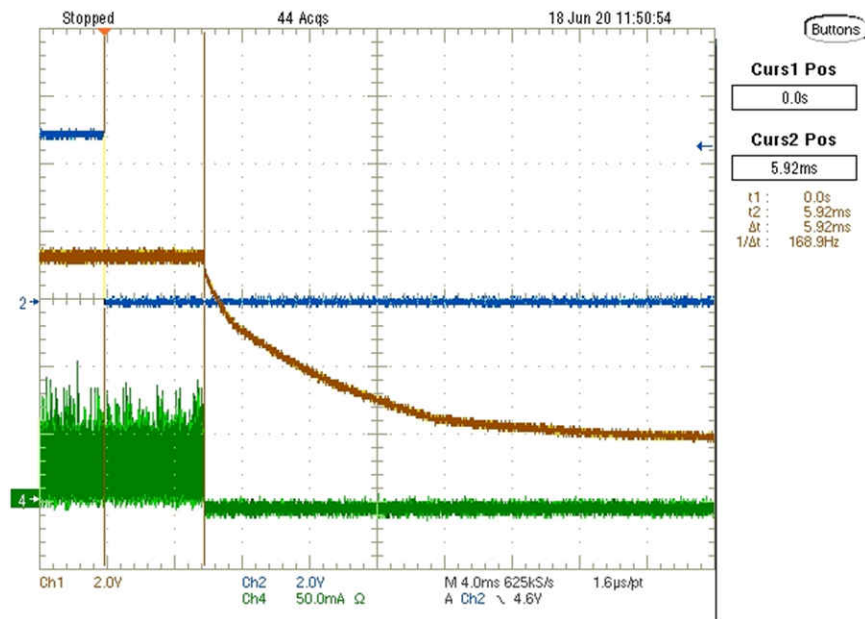

图 3-10. Turn Indicator 1.5 Hz Operation

3.3.7 Turn Indicator Output Voltage and Current

Turn Indicator output voltage (yellow), current ripple and switching frequency (green).

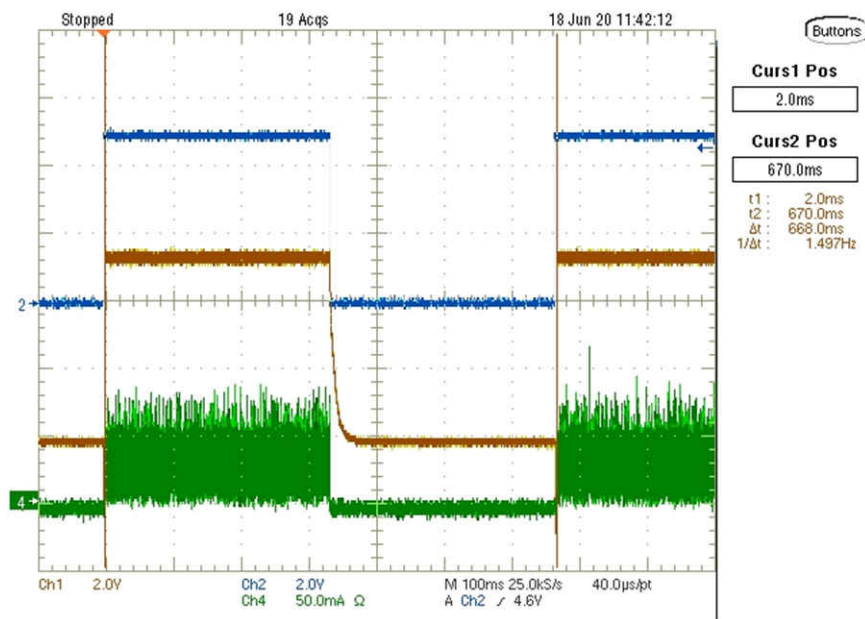

图 3-11. Turn Indicator Output Voltage and Current

3.3.8 Daytime Running Light Turn-on Delay

Turn indicator input falling (blue), Daytime Running Light output (yellow) and current (green).

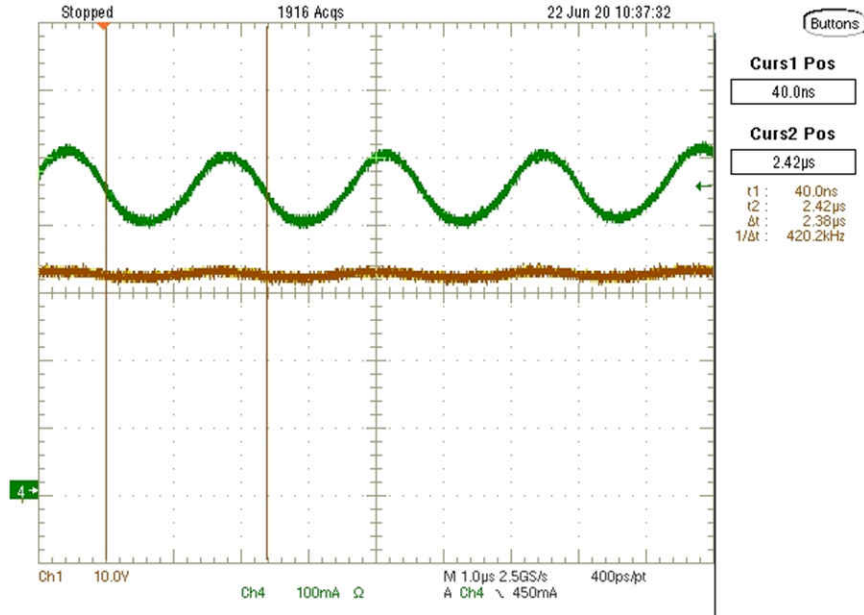

图 3-12. Daytime Running Light Turn-on Delay

3.3.9 Daytime Running Light Switch Node and Output Current

Daytime Running Light switch node (yellow), switching frequency at 330 mA output current (green).

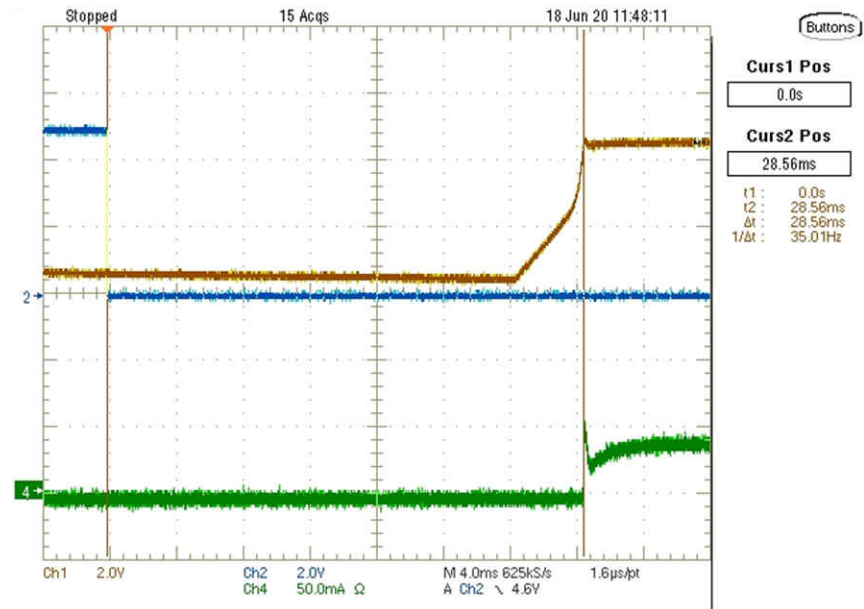

图 3-13. Daytime Running Light Switch Node and Output Current

3.3.10 Highbeam/Lowbeam LED Short

Highbeam/Lowbeam output voltage (yellow), input current (green) during a single LED short fault. Highbeam/Lowbeam fault shutdown time.

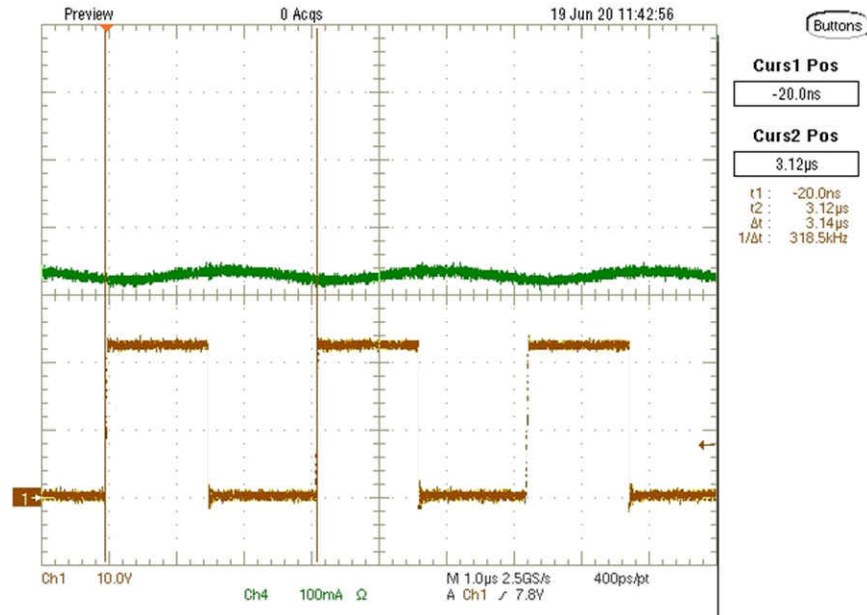

图 3-14. Highbeam/Lowbeam LED Short

3.3.11 Highbeam/Lowbeam Fault Indicator

Highbeam/Lowbeam fault output (yellow) with an 8.2 K Ω pull up resistor, Lowbeam input current with Turn Indicator on (green).

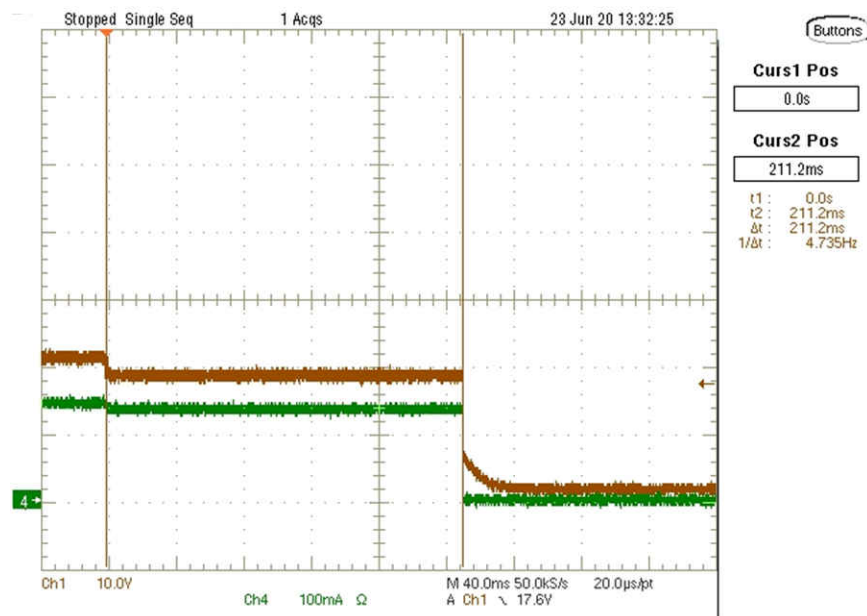

图 3-15. Highbeam/Lowbeam Fault Indicator

3.3.12 Turn Indicator Fault Output

Turn Indicator single LED short fault output, open collector, 8.2 K Ω pullup.

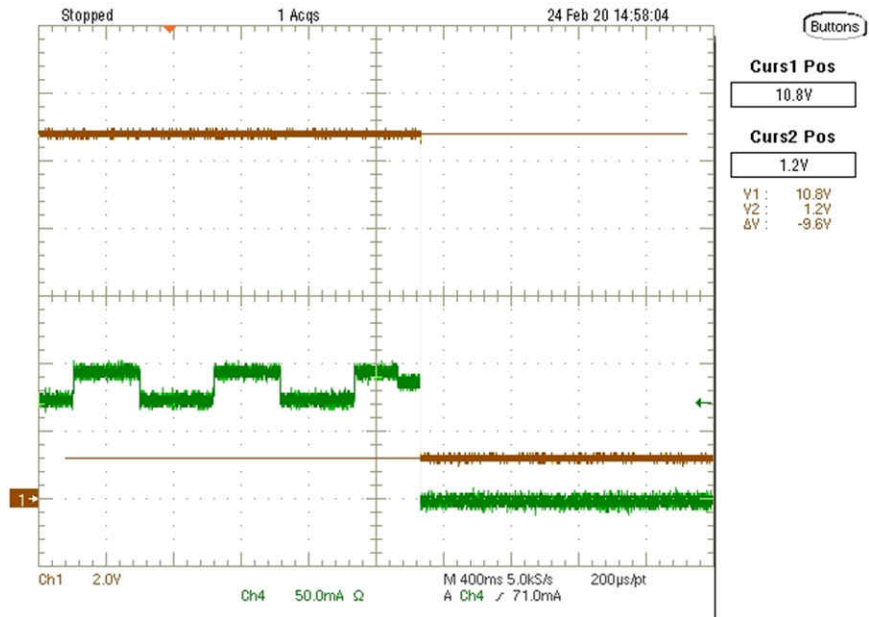

图 3-16. Turn Indicator Fault Output

3.3.13 TPS92682-Q1 Boost and SEPIC Interleaving

The switch node of the boost (violet) and the SEPIC (yellow) showing TPS92682-Q1 interleaved frequency. Falling edges are MOSFETs turning on.

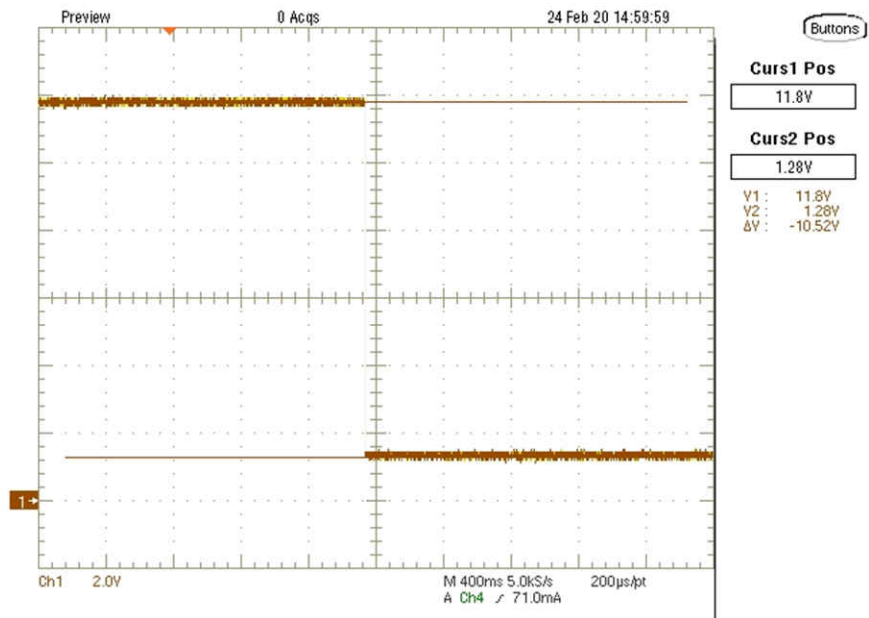

图 3-17. TPS92682-Q1 Boost and SEPIC Interleaving

3.3.14 TIDA-050040 Full Load Efficiency

Full load efficiency at 58W output showing full system efficiency and efficiency minus the reverse input protection diodes. HB/LB at 29.5W, TI at 14.34W and DRL/POS at 14.14W.

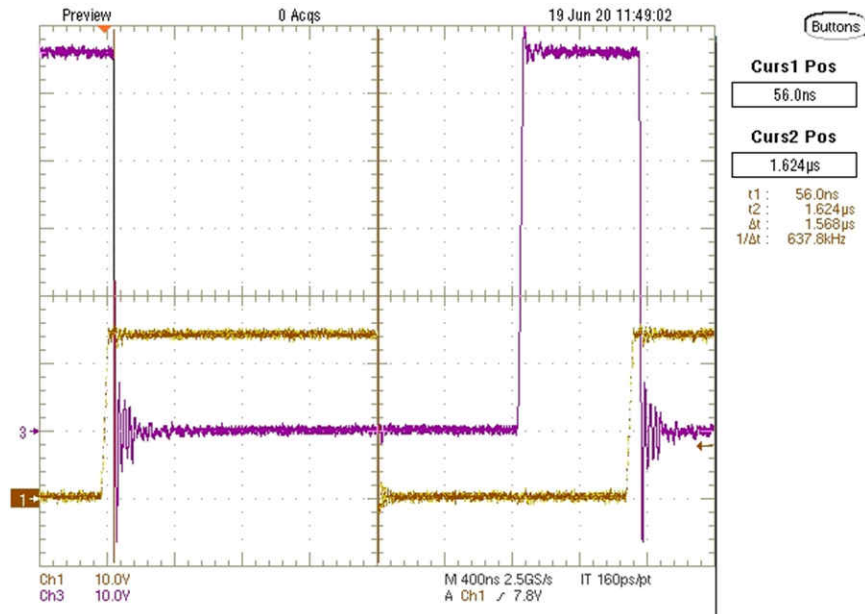

图 3-18. TIDA-050040 Full Load Efficiency

3.3.15 Efficiency Highbeam/Lowbeam

Efficiency Highbeam/Lowbeam at 29.5W including reverse battery protection diode.

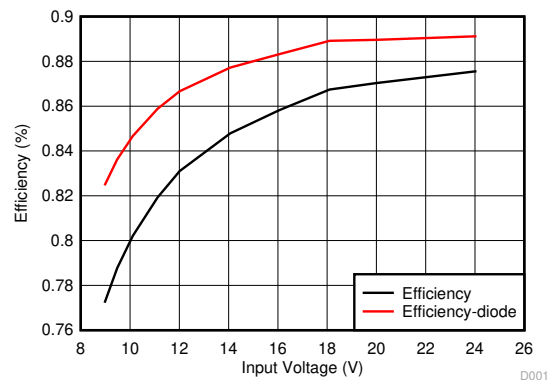

图 3-19. Efficiency Highbeam/Lowbeam

3.3.16 Efficiency Turn Indicator and Daytime Running Light

Efficiency Turn Indicator at 14.34W and Daytime Running Light at 14.14W including reverse protection diodes.

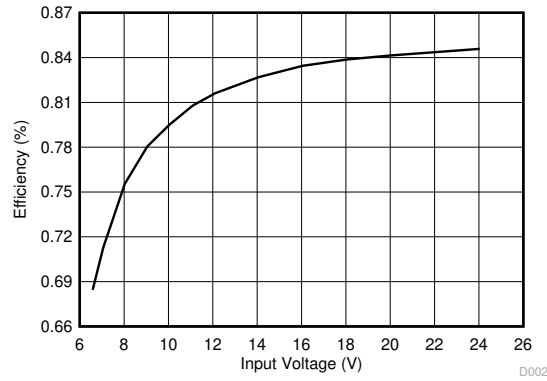

图 3-20. Efficiency Turn Indicator and Daytime Running Light

3.3.17 Efficiency Highbeam/Lowbeam and Turn Indicator

Efficiency Highbeam/Lowbeam at 29.5W and Turn Indicator at 14.34W including reverse protection diodes.

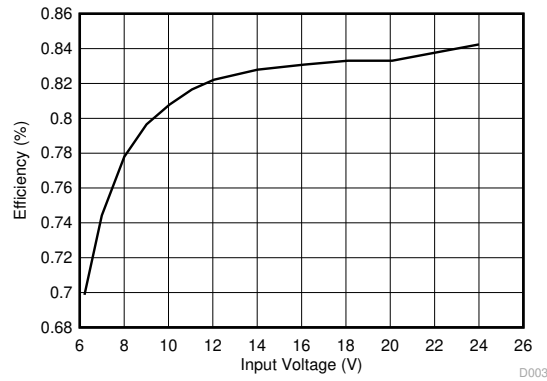

图 3-21. Efficiency Highbeam/Lowbeam and Turn Indicator

3.3.18 CISPR 25 Class 5 EMI Scan

CISPR 25 Class 5 limits, peak and average, scan. Highbeam/Lowbeam, Turn Indicator and Daytime Running light powered. For more information on EMI filter design, see the applications notes [AN-2162 Simple Success With Conducted EMI From DC-DC Converters](#) and [Input Filter Design for Switching Power Supplies](#).

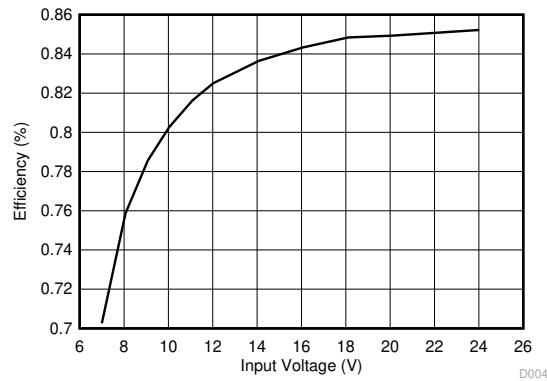

图 3-22. CISPR 25 Class 5 EMI Scan

3.3.19 Top Side Thermal Image DRL at 15W

Thermal image top side of PCB at 25C ambient, no air flow.

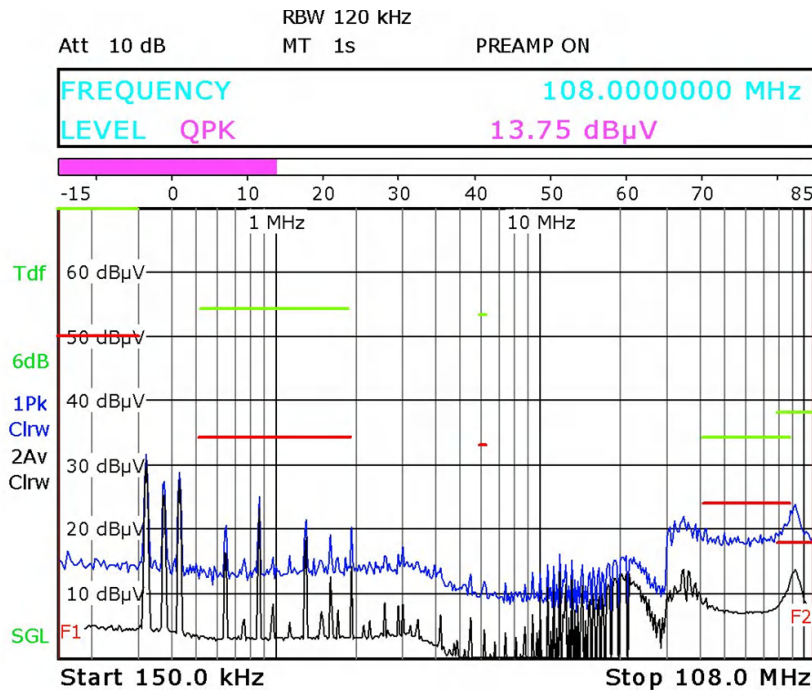

图 3-23. Top Side Thermal Image DRL at 15W

3.3.20 Bottom side thermal image DRL at 15W

Thermal image bottom side of PCB at 25C ambient, no air flow.

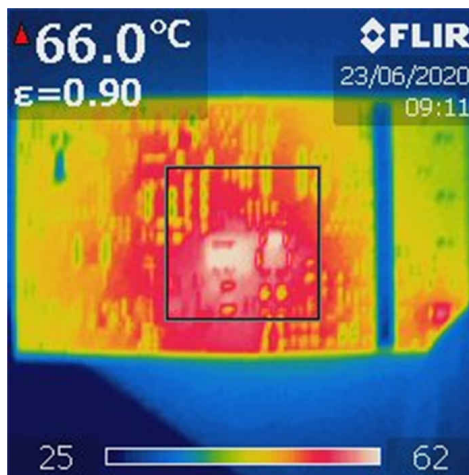

图 3-24. Bottom side thermal image DRL at 15W

3.3.21 Top Side Thermal Image Highbeam/Lowbeam at 30W, Turn Indicator at 7.5W average

Thermal image top side of PCB at 25C ambient, no airflow.



图 3-25. Top Side Thermal Image Highbeam/Lowbeam at 30W, Turn Indicator at 7.5W average

3.3.22 Bottom Side Thermal Image Highbeam/Lowbeam at 30W, Turn Indicator at 7.5W average

Thermal image bottom side of PCB at 25C ambient, no airflow.

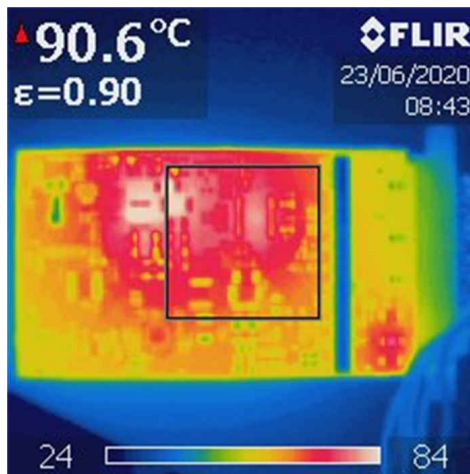

图 3-26. Bottom Side Thermal Image Highbeam/Lowbeam at 30W, Turn Indicator at 7.5W average

4 Design and Documentation Support

4.1 Design Files

4.1.1 Schematics

To download the schematics, see the design files at [TIDA-050040](#).

4.1.2 BOM

To download the bill of materials (BOM), see the design files at [TIDA-050040](#).

4.2 Documentation Support

1. Texas Instruments, [Dual Channel Constant-Voltage and Constant Current Controller with SPI data sheet](#)
2. Texas Instruments, [1.6-A dual synchronous buck LED driver with SPI data sheet](#)
3. Texas Instruments, [SimpleLink™ 32-bit Arm Cortex-M4F MCU with ethernet, CAN, 1MB Flash and 256kB RAM data sheet](#)
4. Texas Instruments, [TPS92682-Q1 constant current 2-channel boost and boost-to-battery evaluation module User Guide](#)
5. Texas Instruments, [TPS92682-Q1 Constant Voltage 2-Phase Boost Evaluation Module User Guide](#)
6. Texas Instruments, [45-W, 15-W dual SEPIC LED Driver Reference Design for Automotive Lighting Design Guide](#)

4.3 Support Resources

[TI E2E™ support forums](#) are an engineer's go-to source for fast, verified answers and design help — straight from the experts. Search existing answers or ask your own question to get the quick design help you need.

Linked content is provided "AS IS" by the respective contributors. They do not constitute TI specifications and do not necessarily reflect TI's views; see TI's [Terms of Use](#).

4.4 Trademarks

TI E2E™ is a trademark of Texas Instruments.

所有商标均为其各自所有者的财产。

重要声明和免责声明

TI“按原样”提供技术和可靠性数据（包括数据表）、设计资源（包括参考设计）、应用或其他设计建议、网络工具、安全信息和其他资源，不保证没有瑕疵且不做任何明示或暗示的担保，包括但不限于对适销性、某特定用途方面的适用性或不侵犯任何第三方知识产权的暗示担保。

这些资源可供使用 TI 产品进行设计的熟练开发人员使用。您将自行承担以下全部责任：(1) 针对您的应用选择合适的 TI 产品，(2) 设计、验证并测试您的应用，(3) 确保您的应用满足相应标准以及任何其他功能安全、信息安全、监管或其他要求。

这些资源如有变更，恕不另行通知。TI 授权您仅可将这些资源用于研发本资源所述的 TI 产品的应用。严禁对这些资源进行其他复制或展示。您无权使用任何其他 TI 知识产权或任何第三方知识产权。您应全额赔偿因在这些资源的使用中对 TI 及其代表造成的任何索赔、损害、成本、损失和债务，TI 对此概不负责。

TI 提供的产品受 [TI 的销售条款](#) 或 [ti.com](#) 上其他适用条款/TI 产品随附的其他适用条款的约束。TI 提供这些资源并不会扩展或以其他方式更改 TI 针对 TI 产品发布的适用的担保或担保免责声明。

TI 反对并拒绝您可能提出的任何其他或不同的条款。

邮寄地址：Texas Instruments, Post Office Box 655303, Dallas, Texas 75265

Copyright © 2022，德州仪器 (TI) 公司