

# ADC12D1x00 12-Bit, 2.0/3.2 GSPS Ultra High-Speed ADC

## 1 Features

- Configurable to Either 2.0/3.2 GSPS Interleaved or 1.0/1.6 GSPS Dual ADC
- Pin-Compatible With ADC10D1x00 and ADC12D1x00
- Internally Terminated, Buffered, Differential Analog Inputs
- Interleaved Timing Automatic and Manual Skew Adjust
- Test Patterns at Output for System Debug
- Programmable 15-bit Gain and 12-bit Plus Sign Offset
- Programmable  $t_{AD}$  Adjust Feature
- 1:1 Non-demuxed or 1:2 Demuxed LVDS Outputs
- AutoSync Feature for Multi-Chip Systems
- Single 1.9-V  $\pm$  0.1-V Power Supply

## 2 Applications

- Wideband Communications
- Data Acquisition Systems
- RADAR and LIDAR
- Set-Top Boxes
- Consumer RF
- Software Defined Radios

## 3 Description

The 12-bit, 2.0/3.2 GSPS ADC12D1x00 device is the latest advance in TI's Ultra High-Speed ADC family and builds upon the features, architecture, and functionality of the 10-bit GHz family of ADCs.

The ADC12D1x00 provides a flexible LVDS interface which has multiple SPI programmable options to facilitate board design and FPGA/ASIC data capture. The LVDS outputs are compatible with IEEE 1596.3-1996 and support programmable common-mode voltage.

The ADC12D1x00 is packaged in a leaded or lead-free 292-pin thermally enhanced BGA package over the rated industrial temperature range of  $-40^{\circ}\text{C}$  to  $85^{\circ}\text{C}$ .

### Device Information<sup>(1)</sup>

PART NUMBER	PACKAGE	BODY SIZE (NOM)
ADC12D1000	BGA (292)	27.00 mm x 27.00 mm
ADC12D1600		

(1) For all available packages, see the orderable addendum at the end of the data sheet.

### Simplified Block Diagram

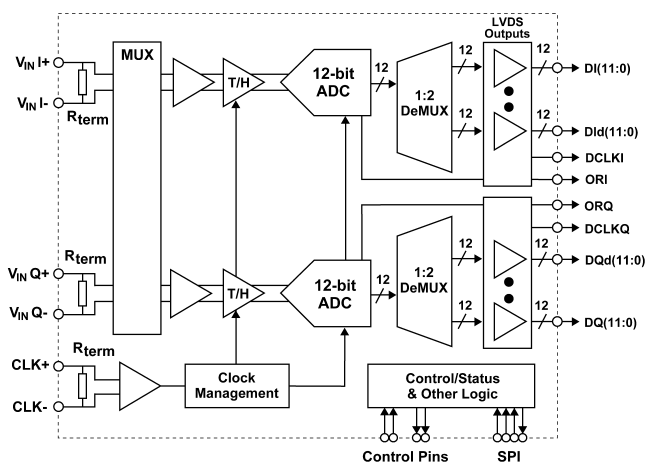

### Wideband Performance

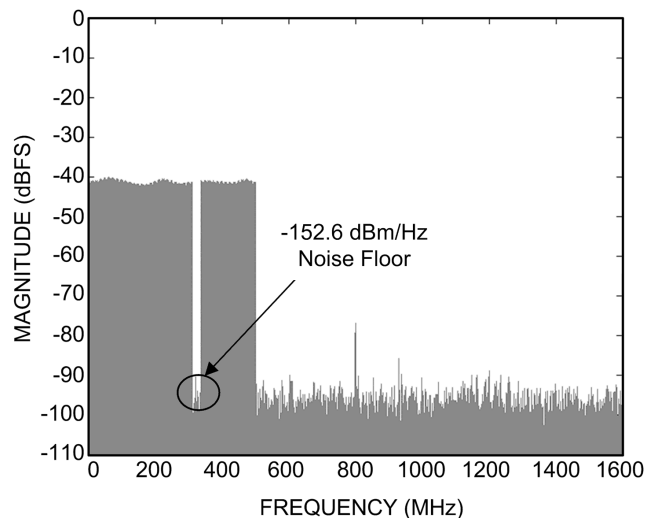

## Table of Contents

<b>1</b>	<b>Features</b> .....	<b>1</b>	7.1	Overview .....	<b>40</b>
<b>2</b>	<b>Applications</b> .....	<b>1</b>	7.2	Functional Block Diagram .....	<b>40</b>
<b>3</b>	<b>Description</b> .....	<b>1</b>	7.3	Feature Description .....	<b>41</b>
<b>4</b>	<b>Revision History</b> .....	<b>2</b>	7.4	Device Functional Modes .....	<b>47</b>
<b>5</b>	<b>Pin Configuration and Functions</b> .....	<b>3</b>	7.5	Programming .....	<b>48</b>
<b>6</b>	<b>Specifications</b> .....	<b>13</b>	7.6	Register Maps .....	<b>53</b>
6.1	Absolute Maximum Ratings .....	<b>13</b>	<b>8</b>	<b>Application and Implementation</b> .....	<b>59</b>
6.2	ESD Ratings .....	<b>13</b>	8.1	Application Information .....	<b>59</b>
6.3	Recommended Operating Conditions .....	<b>14</b>	8.2	Typical Application .....	<b>67</b>
6.4	Thermal Information .....	<b>14</b>	<b>9</b>	<b>Power Supply Recommendations</b> .....	<b>70</b>
6.5	Electrical Characteristics: Static Converter .....	<b>15</b>	9.1	System Power-On Considerations .....	<b>70</b>
6.6	Electrical Characteristics: Dynamic Converter .....	<b>16</b>	9.2	Supply Voltage .....	<b>72</b>
6.7	Electrical Characteristics: Analog Input/Output and Reference .....	<b>21</b>	<b>10</b>	<b>Layout</b> .....	<b>73</b>
6.8	Electrical Characteristics: I-Channel To Q-Channel .....	<b>22</b>	10.1	Layout Guidelines .....	<b>73</b>
6.9	Electrical Characteristics: Converter and Sampling Clock .....	<b>22</b>	10.2	Layout Example .....	<b>75</b>
6.10	Electrical Characteristics: Autosync Feature .....	<b>22</b>	10.3	Thermal Management .....	<b>77</b>
6.11	Electrical Characteristics: Digital Control and Output Pin .....	<b>23</b>	<b>11</b>	<b>Device and Documentation Support</b> .....	<b>79</b>
6.12	Electrical Characteristics: Power Supply .....	<b>24</b>	11.1	Device Support .....	<b>79</b>
6.13	Electrical Characteristics: AC .....	<b>25</b>	11.2	Documentation Support .....	<b>81</b>
6.14	Timing Requirements: Serial Port Interface .....	<b>26</b>	11.3	Related Links .....	<b>81</b>
6.15	Timing Requirements: Calibration .....	<b>26</b>	11.4	Community Resources .....	<b>81</b>
6.16	Typical Characteristics .....	<b>31</b>	11.5	Trademarks .....	<b>81</b>
<b>7</b>	<b>Detailed Description</b> .....	<b>40</b>	11.6	Electrostatic Discharge Caution .....	<b>81</b>
			11.7	Glossary .....	<b>82</b>
			<b>12</b>	<b>Mechanical, Packaging, and Orderable Information</b> .....	<b>82</b>

## 4 Revision History

NOTE: Page numbers for previous revisions may differ from page numbers in the current version.

Changes from Revision M (March 2013) to Revision N	Page
• Added <i>ESD Ratings</i> table, <i>Feature Description</i> section, <i>Device Functional Modes</i> , <i>Application and Implementation</i> section, <i>Power Supply Recommendations</i> section, <i>Layout</i> section, <i>Device and Documentation Support</i> section, and <i>Mechanical, Packaging, and Orderable Information</i> section .....	<b>1</b>
• Deleted $T_A \leq$ from Ambient Temperature MAX column .....	<b>14</b>
• Deleted $T_J \leq$ from Ambient Temperature MAX column .....	<b>14</b>

Changes from Revision L (March 2013) to Revision M	Page
• Changed layout of National Data Sheet to TI format .....	<b>53</b>

## 5 Pin Configuration and Functions

The center ground pins are for thermal dissipation and must be soldered to a ground plane to ensure rated performance. See [Layout Guidelines](#) for more information.

**NXA Package  
292-Pin BGA  
Top View**

	1	2	3	4	5	6	7	8	9	10	11	12	13	14	15	16	17	18	19	20	
A	GND	V_A	SDO	TPM	NDM	V_A	GND	V_E	GND_E	DId0+	V_DR	DId3+	GND_DR	DId6+	V_DR	DId9+	GND_DR	DId11+	DId11-	GND_DR	A
B	Vbg	GND	ECEb	SDI	CalRun	V_A	GND	GND_E	V_E	DId0-	DId2+	DId3-	DId5+	DId6-	DId8+	DId9-	DId10+	DId0+	DId1+	DId1-	B
C	Rtrim+	Vcmo	Rext+	SCSb	SCLK	V_A	NC	V_E	GND_E	DId1+	DId2-	DId4+	DId5-	DId7+	DId8-	DId10-	DId0-	V_DR	DId2+	DId2-	C
D	DNC	Rtrim-	Rext-	GND	GND	CAL	DNC	V_A	V_A	DId1-	V_DR	DId4-	GND_DR	DId7-	V_DR	GND_DR	V_DR	DId3+	DId4+	DId4-	D
E	V_A	Tdiode+	DNC	GND													GND_DR	DId3-	DId5+	DId5-	E
F	V_A	GND_TC	Tdiode-	DNC													GND_DR	DId6+	DId6-	GND_DR	F
G	V_TC	GND_TC	V_TC	V_TC													DId7+	DId7-	DId8+	DId8-	G
H	Vin+	V_TC	GND_TC	V_A	GND						GND						DId9+	DId9-	DId10+	DId10-	H
J	Vin-	GND_TC	V_TC	Vbiasl	GND						GND						V_DR	DId11+	DId11-	V_DR	J
K	GND	Vbiasl	V_TC	GND_TC	GND						GND						ORI+	ORI-	DCLKI+	DCLKI-	K
L	GND	VbiasQ	V_TC	GND_TC	GND						GND						ORQ+	ORQ-	DCLKQ+	DCLKQ-	L
M	VinQ-	GND_TC	V_TC	VbiasQ	GND						GND						GND_DR	DQ11+	DQ11-	GND_DR	M
N	VinQ+	V_TC	GND_TC	V_A	GND						GND						DQ9+	DQ9-	DQ10+	DQ10-	N
P	V_TC	GND_TC	V_TC	V_TC													DQ7+	DQ7-	DQ8+	DQ8-	P
R	V_A	GND_TC	V_TC	V_TC													V_DR	DQ6+	DQ6-	V_DR	R
T	V_A	GND_TC	GND_TC	GND													V_DR	DQ3-	DQ5+	DQ5-	T
U	GND_TC	CLK+	PDI	GND	GND	RCOut1-	DNC	V_A	V_A	DQd1-	V_DR	DQd4-	GND_DR	DQd7-	V_DR	V_DR	GND_DR	DQ3+	DQ4+	DQ4-	U
V	CLK-	DCLK_RST+	PDQ	CalDly	DES	RCOut2+	RCOut2-	V_E	GND_E	DQd1+	DQd2-	DQd4+	DQd5-	DQd7+	DQd8-	DQd10-	DQ0-	GND_DR	DQ2+	DQ2-	V
W	DCLK_RST-	GND	DNC	DDRPh	RCLK-	V_A	GND	GND_E	V_E	DQd0-	DQd2+	DQd3-	DQd5+	DQd6-	DQd8+	DQd9-	DQd10+	DQ0+	DQ1+	DQ1-	W
Y	GND	V_A	FSR	RCLK+	RCOut1+	V_A	GND	V_E	GND_E	DQd0+	V_DR	DQd3+	GND_DR	DQd6+	V_DR	DQd9+	GND_DR	DQd11+	DQd11-	GND_DR	Y

**Pin Functions: Analog Front-End and Clock Balls**

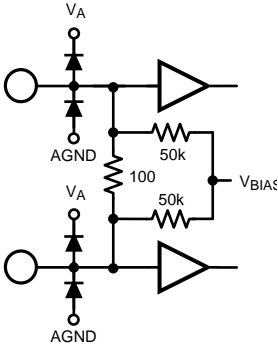
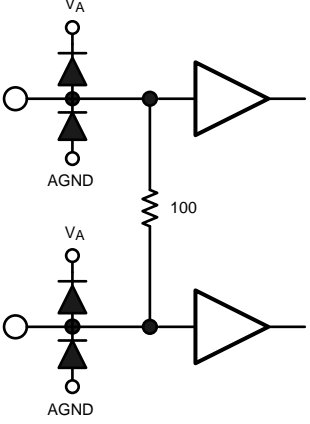
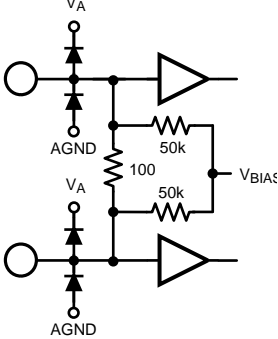
PIN		I/O	EQUIVALENT CIRCUIT	DESCRIPTION
NAME	NO.			
CLK+/-	U2/V1	I		Differential Converter Sampling Clock. In the Non-DES Mode, the analog inputs are sampled on the positive transitions of this clock signal. In the DES Mode, the selected input is sampled on both transitions of this clock. This clock must be AC-coupled.
DCLK_RST+/-	V2/W1	I		Differential DCLK Reset. A positive pulse on this input is used to reset the DCLKI and DCLKQ outputs of two or more ADC12D1x00s to synchronize them with other ADC12D1x00s in the system. DCLKI and DCLKQ are always in phase with each other, unless one channel is powered down, and do not require a pulse from DCLK_RST to become synchronized. The pulse applied here must meet timing relationships with respect to the CLK input. Although supported, this feature has been superseded by AutoSync.
RCLK+/-	Y4/W5	I		Reference Clock Input. When the AutoSync feature is active, and the ADC12D1x00 is in Slave Mode, the internal divided clocks are synchronized with respect to this input clock. The delay on this clock may be adjusted when synchronizing multiple ADCs. This feature is available in ECM through Control Register (Addr: Eh).

Pin Functions: Analog Front-End and Clock Balls (continued)

PIN		I/O	EQUIVALENT CIRCUIT	DESCRIPTION
NAME	NO.			
RCOut1+/- RCOut2+/-	Y5/U6 V6/V7	O		<p>Reference Clock Output 1 and 2. These signals provide a reference clock at a rate of CLK/4, when enabled, independently of whether the ADC is in Master or Slave Mode. The signals are used to drive the RCLK of another ADC12D1x00, to enable automatic synchronization for multiple ADCs (AutoSync feature). The impedance of each trace from RCOut1 and RCOut2 to the RCLK of another ADC12D1x00 should be 100-Ω differential. Having two clock outputs allows the auto-synchronization to propagate as a binary tree. Use the DOC Bit (Addr: Eh, Bit 1) to enable or disable this feature; default is disabled.</p>
Rext+/-	C3/D3	I/O		<p>External Reference Resistor terminals. A 3.3-kΩ ±0.1% resistor should be connected between Rext+/- . The Rext resistor is used as a reference to trim internal circuits which affect the linearity of the converter; the value and precision of this resistor should not be compromised.</p>
Rtrim+/-	C1/D2	I/O		<p>Input Termination Trim Resistor terminals. A 3.3-kΩ ±0.1% resistor should be connected between Rtrim+/- . The Rtrim resistor is used to establish the calibrated 100-Ω input impedance of VinI, VinQ and CLK. These impedances may be fine tuned by varying the value of the resistor by a corresponding percentage; however, the tuning range and performance is not ensured for such an alternate value.</p>
Tdiode+/-	E2/F3	Passive		<p>Temperature Sensor Diode Positive (Anode) and Negative (Cathode) Terminals. This set of pins is used for die temperature measurements. It has not been fully characterized.</p>

**Pin Functions: Analog Front-End and Clock Balls (continued)**

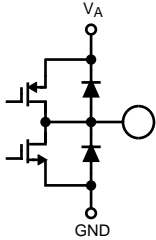
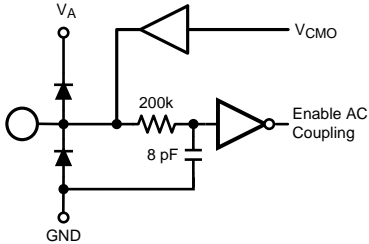
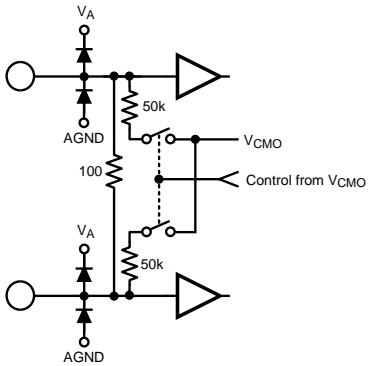
PIN		I/O	EQUIVALENT CIRCUIT	DESCRIPTION
NAME	NO.			
$V_{BG}$	B1	O		<p>Bandgap Voltage Output or LVDS Common-mode Voltage Select. This pin provides a buffered version of the bandgap output voltage and is capable of sourcing and sinking 100 <math>\mu</math>A and driving a load of up to 80 pF. Alternately, this pin may be used to select the LVDS digital output common-mode voltage. If tied to logic-high, the 1.2-V LVDS common-mode voltage is selected; 0.8 V is the default.</p>
$V_{CMO}$	C2	I/O		<p>Common-Mode Voltage Output or Signal Coupling Select. If AC-coupled operation at the analog inputs is desired, this pin should be held at logic-low level. This pin is capable of sourcing and sinking up to 100 <math>\mu</math>A. For DC-coupled operation, this pin should be left floating or terminated into high-impedance. In DC-coupled Mode, this pin provides an output voltage which is the optimal common-mode voltage for the input signal and should be used to set the common-mode voltage of the driving buffer.</p>
$V_{inI\pm}$ $V_{inQ\pm}$	H1/J1 N1/M1	I		<p>Differential signal I- and Q-inputs. In the Non-Dual Edge Sampling (Non-DES) Mode, each I- and Q-input is sampled and converted by its respective channel with each positive transition of the CLK input. In Non-ECM (Non-Extended Control Mode) and DES Mode, both channels sample the I-input. In Extended Control Mode (ECM), the Q-input may optionally be selected for conversion in DES Mode by the DEQ Bit (Addr: 0h, Bit 6).</p> <p>Each I- and Q-channel input has an internal common mode bias that is disabled when DC-coupled Mode is selected. Both inputs must be either AC- or DC-coupled. The coupling mode is selected by the <math>V_{CMO}</math> Pin.</p> <p>In Non-ECM, the full-scale range of these inputs is determined by the FSR Pin; both I- and Q-channels have the same full-scale input range. In ECM, the full-scale input range of the I- and Q-channel inputs may be independently set through the Control Register (Addr: 3h and Addr: Bh). The high and low full-scale input range setting in Non-ECM corresponds to the mid and minimum full-scale input range in ECM.</p> <p>The input offset may also be adjusted in ECM.</p>

**Pin Functions: Control and Status Balls**

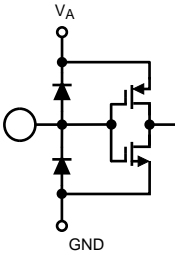
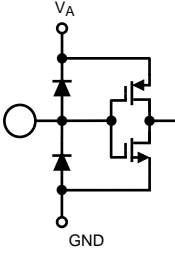
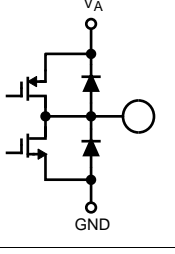
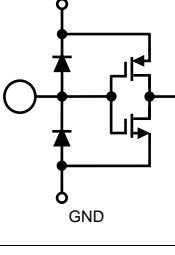
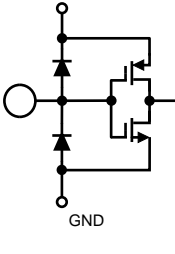
PIN		I/O	EQUIVALENT CIRCUIT	DESCRIPTION
NAME	NO.			
CAL	D6	I		Calibration cycle initiate. The user can command the device to execute a self-calibration cycle by holding this input high a minimum of $t_{CAL\_H}$ after having held it low a minimum of $t_{CAL\_L}$ . If this input is held high at the time of power on, the automatic power-on calibration cycle is inhibited until this input is cycled low-then-high. This pin is active in both ECM and Non-ECM. In ECM, this pin is logically OR'd with the CAL Bit (Addr: 0h, Bit 15) in the Control Register. Therefore, both pin and bit must be set low and then either can be set high to execute an on-command calibration.
CalDly	V4	I		Calibration Delay select. By setting this input logic-high or logic-low, the user can select the device to wait a longer or shorter amount of time, respectively, before the automatic power-on self-calibration is initiated. This feature is pin-controlled only and is always active during ECM and Non-ECM.
CalRun	B5	O		Calibration Running indication. This output is logic-high while the calibration sequence is executing. This output is logic-low otherwise.
DDRPh	W4	I		DDR Phase select. This input, when logic-low, selects the 0° Data-to-DCLK phase relationship. When logic-high, it selects the 90° Data-to-DCLK phase relationship, that is, the DCLK transition indicates the middle of the valid data outputs. This pin only has an effect when the chip is in 1:2 Demuxed Mode, that is, the NDM pin is set to logic-low. In ECM, this input is ignored and the DDR phase is selected through the Control Register by the DPS Bit (Addr: 0h, Bit 14); the default is 0° Mode.
DES	V5	I		Dual Edge Sampling (DES) Mode select. In the Non-Extended Control Mode (Non-ECM), when this input is set to logic-high, the DES Mode of operation is selected, meaning that the VinI input is sampled by both channels in a time-interleaved manner. The VinQ input is ignored. When this input is set to logic-low, the device is in Non-DES Mode, that is, the I- and Q-channels operate independently. In the Extended Control Mode (ECM), this input is ignored and DES Mode selection is controlled through the Control Register by the DES Bit (Addr: 0h, Bit 7); default is Non-DES Mode operation.
DNC	D1, D7, E3, F4, W3, U7	—	NONE	Do Not Connect. These pins are used for internal purposes and should not be connected, that is, left floating. Do not ground.

**Pin Functions: Control and Status Balls (continued)**

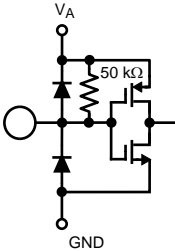
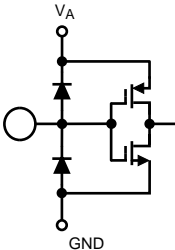
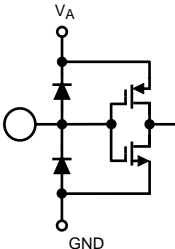
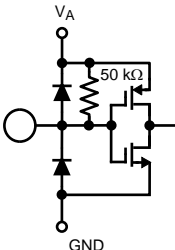
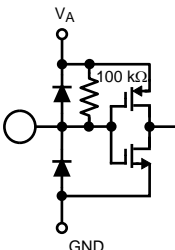
PIN		I/O	EQUIVALENT CIRCUIT	DESCRIPTION
NAME	NO.			
$\overline{\text{ECE}}$	B3	I		<p>Extended Control Enable bar. Extended feature control through the SPI interface is enabled when this signal is asserted (logic-low). In this case, most of the direct control pins have no effect. When this signal is deasserted (logic-high), the SPI interface is disabled, all SPI registers are reset to their default values, and all available settings are controlled through the control pins.</p>
FSR	Y3	I		<p>Full-Scale input Range select. In Non-ECM, when this input is set to logic-low or logic-high, the full-scale differential input range for both I- and Q-channel inputs is set to the lower or higher FSR value, respectively. In the ECM, this input is ignored and the full-scale range of the I- and Q-channel inputs is independently determined by the setting of Addr: 3h and Addr: Bh, respectively. The high (lower) FSR value in Non-ECM corresponds to the mid (min) available selection in ECM; the FSR range in ECM is greater.</p>
NC	C7	—	NONE	<p>Not Connected. This pin is not bonded and may be left floating or connected to any potential.</p>
NDM	A5	I		<p>Non-Demuxed Mode select. Setting this input to logic-high causes the digital output bus to be in the 1:1 Non-Demuxed Mode. Setting this input to logic-low causes the digital output bus to be in the 1:2 Demuxed Mode. This feature is pin-controlled only and remains active during ECM and Non-ECM.</p>
PDI PDQ	U3 V3	I		<p>Power-down I- and Q-channel. Setting either input to logic-high powers down the respective I- or Q-channel. Setting either input to logic-low brings the respective I- or Q-channel to an operational state after a finite time delay. This pin is active in both ECM and Non-ECM. In ECM, each Pin is logically OR'd with its respective Bit. Therefore, either this pin or the PDI and PDQ Bit in the Control Register can be used to power-down the I- and Q-channel (Addr: 0h, Bit 11 and Bit 10), respectively.</p>
SCLK	C5	I		<p>Serial Clock. In ECM, serial data is shifted into and out of the device synchronously to this clock signal. This clock may be disabled and held logic-low, as long as timing specifications are not violated when the clock is enabled or disabled.</p>



**Pin Functions: Control and Status Balls (continued)**

PIN		I/O	EQUIVALENT CIRCUIT	DESCRIPTION
NAME	NO.			
$\overline{SCS}$	C4	I		Serial Chip Select bar. In ECM, when this signal is asserted (logic-low), SCLK is used to clock in serial data which is present on SDI and to source serial data on SDO. When this signal is deasserted (logic-high), SDI is ignored and SDO is at TRI-STATE.
SDI	B4	I		Serial Data-In. In ECM, serial data is shifted into the device on this pin while $\overline{SCS}$ signal is asserted (logic-low).
SDO	A3	O		Serial Data-Out. In ECM, serial data is shifted out of the device on this pin while $\overline{SCS}$ signal is asserted (logic-low). This output is at TRI-STATE when $\overline{SCS}$ is deasserted.
TPM	A4	I		Test Pattern Mode select. With this input at logic-high, the device continuously outputs a fixed, repetitive test pattern at the digital outputs. In the ECM, this input is ignored and the Test Pattern Mode can only be activated through the Control Register by the TPM Bit (Addr: 0h, Bit 12).

**Pin Functions: Power and Ground Balls**

PIN		I/O	EQUIVALENT CIRCUIT	DESCRIPTION
NAME	NO.			
GND	A1, A7, B2, B7, D4, D5, E4, K1, L1, T4, U4, U5, W2, W7, Y1, Y7, H8:N13	—	NONE	Ground Return for the Analog circuitry.
GND <sub>DR</sub>	A13, A17, A20, D13, D16, E17, F17, F20, M17, M20, U13, U17, V18, Y13, Y17, Y20	—	NONE	Ground Return for the Output Drivers.
GND <sub>E</sub>	A9, B8, C9, V9, W8, Y9	—	NONE	Ground Return for the Digital Encoder.
GND <sub>TC</sub>	F2, G2, H3, J2, K4, L4, M2, N3, P2, R2, T2, T3, U1	—	NONE	Ground Return for the Track-and-Hold and Clock circuitry.
V <sub>A</sub>	A2, A6, B6, C6, D8, D9, E1, F1, H4, N4, R1, T1, U8, U9, W6, Y2, Y6	—	NONE	Power Supply for the Analog circuitry. This supply is tied to the ESD ring. Therefore, it must be powered up before or with any other supply.
V <sub>biasI</sub>	J4, K2	—	NONE	Bias Voltage I-channel. This is an externally decoupled bias voltage for the I-channel. Each pin should individually be decoupled with a 100-nF capacitor through a low-resistance, low-inductance path to GND.
V <sub>biasQ</sub>	L2, M4	—	NONE	Bias Voltage Q-channel. This is an externally decoupled bias voltage for the Q-channel. Each pin should individually be decoupled with a 100-nF capacitor through a low-resistance, low-inductance path to GND.
V <sub>DR</sub>	A11, A15, C18, D11, D15, D17, J17, J20, R17, R20, T17, U11, U15, U16, Y11, Y15	—	NONE	Power Supply for the Output Drivers.
V <sub>E</sub>	A8, B9, C8, V8, W9, Y8	—	NONE	Power Supply for the Digital Encoder.
V <sub>TC</sub>	G1, G3, G4, H2, J3, K3, L3, M3, N2, P1, P3, P4, R3, R4	—	NONE	Power Supply for the Track-and-Hold and Clock circuitry.

Pin Functions: High-Speed Digital Outputs

PIN		I/O	EQUIVALENT CIRCUIT	DESCRIPTION
NAME	NO.			
DCLKI+/- DCLKQ+/-	K19/K20 L19/L20	O		<p>Data Clock Output for the I- and Q-channel data bus. These differential clock outputs are used to latch the output data and, if used, should always be terminated with a 100-Ω differential resistor placed as closely as possible to the differential receiver. Delayed and non-delayed data outputs are supplied synchronously to this signal. In 1:2 Demux Mode or Non-Demux Mode, this signal is at ¼ or ½ the sampling clock rate, respectively. DCLKI and DCLKQ are always in phase with each other, unless one channel is powered down, and do not require a pulse from DCLK_RST to become synchronized.</p>
DI11+/- DI10+/- DI9+/- DI8+/- DI7+/- DI6+/- DI5+/- DI4+/- DI3+/- DI2+/- DI1+/- DI0+/- . DQ11+/- DQ10+/- DQ9+/- DQ8+/- DQ7+/- DQ6+/- DQ5+/- DQ4+/- DQ3+/- DQ2+/- DQ1+/- DQ0+/-	J18/J19 H19/H20 H17/H18 G19/G20 G17/G18 F18/F19 E19/E20 D19/D20 D18/E18 C19/C20 B19/B20 B18/C17 . M18/M19 N19/N20 N17/N18 P19/P20 P17/P18 R18/R19 T19/T20 U19/U20 U18/T18 V19/V20 W19/W20 W18/V17	O		<p>I- and Q-channel Digital Data Outputs. In Non-Demux Mode, this LVDS data is transmitted at the sampling clock rate. In Demux Mode, these outputs provide ½ the data at ½ the sampling clock rate, synchronized with the delayed data, that is, the other ½ of the data which was sampled one clock cycle earlier. Compared with the DI and DQ outputs, these outputs represent the later time samples. If used, each of these outputs should always be terminated with a 100-Ω differential resistor placed as closely as possible to the differential receiver.</p>

**Pin Functions: High-Speed Digital Outputs (continued)**

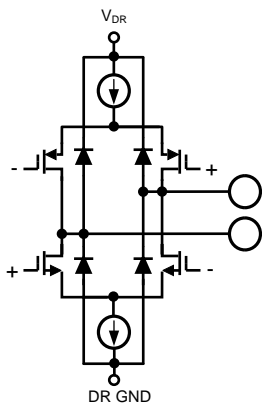
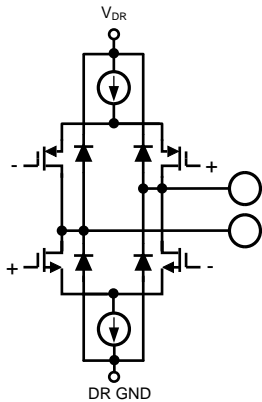
PIN		I/O	EQUIVALENT CIRCUIT	DESCRIPTION
NAME	NO.			
DId11+/- DId10+/- DId9+/- DId8+/- DId7+/- DId6+/- DId5+/- DId4+/- DId3+/- DId2+/- DId1+/- DId0+/- . DQd11+/- DQd10+/- DQd9+/- DQd8+/- DQd7+/- DQd6+/- DQd5+/- DQd4+/- DQd3+/- DQd2+/- DQd1+/- DQd0+/-	A18/A19 B17/C16 A16/B16 B15/C15 C14/D14 A14/B14 B13/C13 C12/D12 A12/B12 B11/C11 C10/D10 A10/B10 . Y18/Y19 W17/V16 Y16/W16 W15/V15 V14/U14 Y14/W14 W13/V13 V12/U12 Y12/W12 W11/V11 V10/U10 Y10/W10	O		Delayed I- and Q-channel Digital Data Outputs. In Non-Demux Mode, these outputs are at TRI-STATE. In Demux Mode, these outputs provide ½ the data at ½ the sampling clock rate, synchronized with the non-delayed data, that is, the other ½ of the data which was sampled one clock cycle later. Compared with the DI and DQ outputs, these outputs represent the earlier time samples. If used, each of these outputs should always be terminated with a 100-Ω differential resistor placed as closely as possible to the differential receiver.
ORI+/- ORQ+/-	K17/K18 L17/L18	O		Out-of-Range Output for the I- and Q-channel. This differential output is asserted logic-high while the over- or under-range condition exists, that is, the differential signal at each respective analog input exceeds the full-scale value. Each OR result refers to the current Data, with which it is clocked out. If used, each of these outputs should always be terminated with a 100-Ω differential resistor placed as closely as possible to the differential receiver.

## 6 Specifications

### 6.1 Absolute Maximum Ratings

over operating free-air temperature range (unless otherwise noted)<sup>(1)</sup>

	MIN	MAX	UNIT
Supply Voltage ( $V_A$ , $V_{TC}$ , $V_{DR}$ , $V_E$ )		2.2	V
Supply Difference $\max(V_{A/TC/DR/E}) - \min(V_{A/TC/DR/E})$	0	100	mV
Voltage on Any Input Pin (except $V_{IN+/-}$ )	-0.15	$V_A + 0.15$	V
$V_{IN+/-}$ Voltage Range	-0.5	2.5	V
Ground Difference $\max(GND_{TC/DR/E}) - \min(GND_{TC/DR/E})$	0	100	mV
Input Current at Any Pin <sup>(2)</sup>	-50	50	mA
ADC12D1000 Package Power Dissipation at $T_A \leq 75^\circ\text{C}$ <sup>(2)</sup>		4.06	W
ADC12D1600 Package Power Dissipation at $T_A \leq 65^\circ\text{C}$ <sup>(2)</sup>		4.37	W
Storage Temperature, $T_{stg}$	-65	150	$^\circ\text{C}$

- (1) Stresses beyond those listed under *Absolute Maximum Ratings* may cause permanent damage to the device. These are stress ratings only, which do not imply functional operation of the device at these or any other conditions beyond those indicated under *Recommended Operating Conditions*. Exposure to absolute-maximum-rated conditions for extended periods may affect device reliability.
- (2) When the input voltage at any pin exceeds the power supply limits, that is, less than GND or greater than  $V_A$ , the current at that pin should be limited to 50 mA. In addition, overvoltage at a pin must adhere to the maximum voltage limits. Simultaneous overvoltage at multiple pins requires adherence to the maximum package power dissipation limits. These dissipation limits are calculated using JEDEC JESD51-7 thermal model. Higher dissipation may be possible based on specific customer thermal situation and specified package thermal resistances from junction to case.

### 6.2 ESD Ratings

		VALUE	UNIT
$V_{(ESD)}$ Electrostatic discharge	Human-body model (HBM), per ANSI/ESDA/JEDEC JS-001 <sup>(1)</sup>	$\pm 2500$	V
	Charged-device model (CDM), per JEDEC specification JESD22-C101 <sup>(2)</sup>	$\pm 1000$	
	Machine Model	$\pm 250$	

- (1) JEDEC document JEP155 states that 500-V HBM allows safe manufacturing with a standard ESD control process.
- (2) JEDEC document JEP157 states that 250-V CDM allows safe manufacturing with a standard ESD control process.

### 6.3 Recommended Operating Conditions

 over operating free-air temperature range (unless otherwise noted)<sup>(1)</sup>

		MIN	NOM	MAX	UNIT	
T <sub>A</sub>	Ambient Temperature	ADC12D1000 (Standard JEDEC thermal model)		–40	75	°C
		ADC12D1600 (Standard JEDEC thermal model)		–40	65	°C
		ADC12D1x00 (Enhanced thermal model or heatsink)		–40	85	°C
T <sub>J</sub>	Junction Temperature Range <sup>(2)</sup>	ADC12D1000 Junction Temperature Range			140	°C
		ADC12D1600 Junction Temperature Range			135	°C
Supply Voltage (V <sub>A</sub> , V <sub>TC</sub> , V <sub>E</sub> )				1.8	2	V
Driver Supply Voltage (V <sub>DR</sub> )				1.8	V <sub>A</sub>	V
V <sub>IN+/-</sub> Voltage Range <sup>(3)</sup>		(DC-coupled)		–0.4	2.4	V
V <sub>IN+/-</sub> Differential Voltage <sup>(4)</sup>	(DC-coupled at 100% duty cycle)				1	V
	(DC-coupled at 20% duty cycle)				2	
	(DC-coupled at 10% duty cycle)				2.8	
V <sub>IN+/-</sub> Current Range <sup>(5)</sup>		(AC-coupled)		–50	50	mA peak
V <sub>IN+/-</sub> Power	(maintaining common-mode voltage, AC-coupled)				15.3	dBm
	(not maintaining common-mode voltage, AC-coupled)				17.1	
Ground Difference max(GND <sub>TC/DR/E</sub> ) -min(GND <sub>TC/DR/E</sub> )				0		V
CLK+/- Voltage Range				0	V <sub>A</sub>	V
Differential CLK Amplitude				0.4	2	V <sub>P-P</sub>
V <sub>CMi</sub> Common Mode Input Voltage				V <sub>CMO</sub> – 150	V <sub>CMO</sub> +150	mV

 (1) All voltages are measured with respect to GND = GN<sub>TC</sub> = GN<sub>DDR</sub> = GN<sub>DE</sub> = 0 V, unless otherwise specified.

(2) Applies only to maximum operating speed.

(3) Proper common mode voltage must be maintained to ensure proper output codes, especially during input overdrive.

 (4) This rating is intended for DC-coupled applications; the voltages listed may be safely applied to V<sub>IN+/-</sub> for the life-time duty-cycle of the part.

(5) Proper common mode voltage must be maintained to ensure proper output codes, especially during input overdrive.

### 6.4 Thermal Information

THERMAL METRIC <sup>(1)</sup>		ADC12D1000, ADC12D1600	UNIT
		NXA (BGA)	
		292 PINS	
R <sub>θJA</sub>	Junction-to-ambient thermal resistance	16	°C/W
R <sub>θJC(top)</sub>	Junction-to-case (top) thermal resistance	2.9	°C/W
R <sub>θJC(bot)</sub>	Junction-to-case (bottom) thermal resistance	2.5	°C/W

 (1) For more information about traditional and new thermal metrics, see the *Semiconductor and IC Package Thermal Metrics* application report, [SPRA953](#).

### 6.5 Electrical Characteristics: Static Converter

Unless otherwise specified, the following apply after calibration for  $V_A = V_{DR} = V_{TC} = V_E = 1.9\text{ V}$ ; I- and Q-channels, AC-coupled, unused channel terminated to AC ground, FSR Pin = High;  $C_L = 10\text{ pF}$ ; Differential, AC coupled Sine Wave Sampling Clock,  $f_{CLK} = 1\text{ or }1.6\text{ GHz}$  at  $0.5\text{ V}_{P,P}$  with 50% duty cycle (as specified);  $V_{BG} = \text{Floating}$ ; Non-Extended Control Mode;  $R_{ext} = R_{trim} = 3300\ \Omega \pm 0.1\%$ ; Analog Signal Source Impedance =  $100\text{-}\Omega$  Differential; 1:2 Demultiplex Non-DES Mode; Duty Cycle Stabilizer on. All other limits  $T_A = 25^\circ\text{C}$ , unless otherwise noted.<sup>(1)(2)(3)</sup>

PARAMETER	TEST CONDITIONS	MIN	TYP	MAX	UNIT
Resolution with No Missing Codes	$T_A = T_{MIN}$ to $T_{MAX}$			12	bits
INL Integral Non-Linearity (Best fit)	1-MHz DC-coupled over-ranged sine wave	$T_A = 25^\circ\text{C}$	$\pm 2.5$		LSB
		$T_A = T_{MIN}$ to $T_{MAX}$		$\pm 4.8$	
DNL Differential Non-Linearity	1-MHz DC-coupled over-ranged sine wave	$T_A = 25^\circ\text{C}$	$\pm 0.4$		LSB
		$T_A = T_{MIN}$ to $T_{MAX}$		$\pm 0.9$	
$V_{OFF}$ Offset Error			5		LSB
$V_{OFF\_ADJ}$ Input Offset Adjustment Range	Extended Control Mode		$\pm 45$		mV
PFSE Positive Full-Scale Error	See <sup>(4)</sup> . $T_A = T_{MIN}$ to $T_{MAX}$			$\pm 25$	mV
NFSE Negative Full-Scale Error	See <sup>(4)</sup> . $T_A = T_{MIN}$ to $T_{MAX}$			$\pm 25$	mV
Out-of-Range Output Code <sup>(5)</sup>	$(V_{IN+}) - (V_{IN-}) > +\text{ Full Scale, } T_A = T_{MIN}$ to $T_{MAX}$			4095	
	$(V_{IN+}) - (V_{IN-}) < -\text{ Full Scale, } T_A = T_{MIN}$ to $T_{MAX}$			0	

(1) The analog inputs, labeled "I/O", are protected as shown below. Input voltage magnitudes beyond the *Absolute Maximum Ratings* may

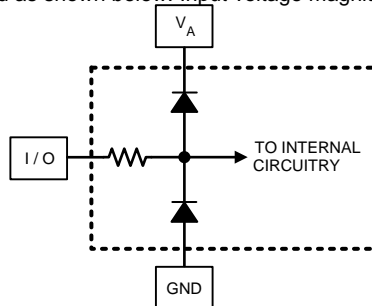

damage this device). See the following figure.

- (2) To ensure accuracy, it is required that  $V_A$ ,  $V_{TC}$ ,  $V_E$  and  $V_{DR}$  be well-bypassed. Each supply pin must be decoupled with separate bypass capacitors.
- (3) Typical figures are at  $T_A = 25^\circ\text{C}$ , and represent most likely parametric norms. Test limits are ensured to TI's AOQL (Average Outgoing Quality Level).
- (4) Calculation of Full-Scale Error for this device assumes that the actual reference voltage is exactly its nominal value. Full-Scale Error for this device, therefore, is a combination of Full-Scale Error and Reference Voltage Error. See [Figure 8](#). For relationship between Gain Error and Full-Scale Error, see Specification Definitions for Gain Error.
- (5) This parameter is specified by design and is not tested in production.

## 6.6 Electrical Characteristics: Dynamic Converter

 $T_A = 25^\circ\text{C}$ , unless otherwise noted

PARAMETER		TEST CONDITIONS		MIN	TYP	MAX	UNIT
FPBW	Full Power Bandwidth	Non-DES Mode			2.8		GHz
		DESI, DESQ Mode			1.25		GHz
		DESIQ Mode			1.75		GHz
Gain Flatness		<b>NON-DES MODE</b>					
		D.C. to $F_s/2$	ADC12D1000		0.35		dB
			ADC12D1600		0.5		
		D.C. to $F_s$	ADC12D1000		0.5		dB
			ADC12D1600		1		
		<b>DESI, DESQ MODE</b>					
		D.C. to $F_s/2$	ADC12D1000		2.4		dB
			ADC12D1600		4		
		<b>DESIQ MODE</b>					
		D.C. to $F_s/2$	ADC12D1000		1.9		dB
			ADC12D1600		2		
		CER	Code Error Rate				$10^{-18}$
NPR	Noise Power Ratio	See <sup>(1)</sup>	ADC12D1000		49.5		dB
			ADC12D1600		48.5		
IMD3	3rd order Intermodulation Distortion	$F_{IN1} = 1212.52$ MHz at -7dBFS	ADC12D1000		-66		dBFS
			ADC12D1600		-63		
		$F_{IN2} = 1217.52$ MHz at -7dBFS DESIQ Mode	ADC12D1000		-59		dBc
			ADC12D1600		-56		
Noise Floor Density		50 $\Omega$ single-ended termination, DES Mode	ADC12D1000		-152.6		dBm/Hz
			ADC12D1600		-153.6		
			ADC12D1000		-151.6		dBFS/Hz
			ADC12D1600		-152.6		
		Wideband input, DES Mode <sup>(2)</sup>	ADC12D1000		-151.5		dBm/Hz
			ADC12D1600		-152.6		
			ADC12D1000		-150.5		dBFS/Hz
			ADC12D1600		-151.6		

- (1) The NPR was measured using an Agilent N6030A Arbitrary Waveform Generator (ARB) to generate the input signal. See the Wideband Performance for an example spectrum. The "noise" portion of the signal was created by tones spaced at 500 kHz and the "notch" was a 25-MHz absence of tones centered at 320 MHz. The bandwidth of this equipment is only 500 MHz, so the final reported NPR was extrapolated from the measured NPR as if the entire Nyquist band were occupied with noise.
- (2) The Noise Floor was measured for two conditions: the analog input terminated with 50  $\Omega$ , and in the presence of a 500-MHz wideband noise signal with total power just below the maximum input level to the ADC. In both cases, the spurs at DC,  $F_s/4$  and  $F_s/2$  were removed. The power over the entire Nyquist band (except the noise signal) was integrated and the average number is reported.



**Electrical Characteristics: Dynamic Converter (continued)**
 $T_A = 25^\circ\text{C}$ , unless otherwise noted

PARAMETER		TEST CONDITIONS		MIN	TYP	MAX	UNIT	
<b>NON-DES MODE <sup>(2)</sup>(2)</b>								
ENOB	Effective Number of Bits	$A_{IN} = 125\text{ MHz at } -0.5\text{ dBFS}$	ADC12D1000	9.6			bits	
			ADC12D1600	9.4				
		$A_{IN} = 248\text{ MHz at } -0.5\text{ dBFS}$	ADC12D1000 $T_A = T_{MIN}\text{ to } T_{MAX}$	9.5				bits
			ADC12D1600 $T_A = T_{MIN}\text{ to } T_{MAX}$	8.7				
		$A_{IN} = 498\text{ MHz at } -0.5\text{ dBFS}$	ADC12D1000 $T_A = T_{MIN}\text{ to } T_{MAX}$	9.4				bits
			ADC12D1600 $T_A = T_{MIN}\text{ to } T_{MAX}$	8.7				
		$A_{IN} = 998\text{ MHz at } -0.5\text{ dBFS}$			8.9			bits
		$A_{IN} = 1448\text{ MHz at } -0.5\text{ dBFS}$			8.6			bits
SINAD	Signal-to-Noise Plus Distortion Ratio	$A_{IN} = 125\text{ MHz at } -0.5\text{ dBFS}$	ADC12D1000	59.7			dB	
			ADC12D1600	58.2				
		$A_{IN} = 248\text{ MHz at } -0.5\text{ dBFS}$	ADC12D1000 $T_A = T_{MIN}\text{ to } T_{MAX}$	59				dB
			ADC12D1600 $T_A = T_{MIN}\text{ to } T_{MAX}$	54.1				
		$A_{IN} = 498\text{ MHz at } -0.5\text{ dBFS}$	ADC12D1000 $T_A = T_{MIN}\text{ to } T_{MAX}$	58				dB
			ADC12D1600 $T_A = T_{MIN}\text{ to } T_{MAX}$	53.5				
		$A_{IN} = 998\text{ MHz at } -0.5\text{ dBFS}$	ADC12D1000	58.2				dB
			ADC12D1600	54.1				
		$A_{IN} = 1448\text{ MHz at } -0.5\text{ dBFS}$			55.4			dB
		$A_{IN} = 1448\text{ MHz at } -0.5\text{ dBFS}$			55.1			dB
SNR	Signal-to-Noise Ratio	$A_{IN} = 125\text{ MHz at } -0.5\text{ dBFS}$	ADC12D1000	60.2			dB	
			ADC12D1600	58.5				
		$A_{IN} = 248\text{ MHz at } -0.5\text{ dBFS}$	ADC12D1000 $T_A = T_{MIN}\text{ to } T_{MAX}$	59.7				dB
			ADC12D1600 $T_A = T_{MIN}\text{ to } T_{MAX}$	55.1				
		$A_{IN} = 498\text{ MHz at } -0.5\text{ dBFS}$	ADC12D1000 $T_A = T_{MIN}\text{ to } T_{MAX}$	58.7				dB
			ADC12D1600 $T_A = T_{MIN}\text{ to } T_{MAX}$	54.6				
		$A_{IN} = 998\text{ MHz at } -0.5\text{ dBFS}$	ADC12D1000	58.7				dB
			ADC12D1600	55.1				
		$A_{IN} = 1448\text{ MHz at } -0.5\text{ dBFS}$			58.5			dB
		$A_{IN} = 1448\text{ MHz at } -0.5\text{ dBFS}$			54.6			dB
	$A_{IN} = 998\text{ MHz at } -0.5\text{ dBFS}$			56.3			dB	
	$A_{IN} = 998\text{ MHz at } -0.5\text{ dBFS}$			56.5			dB	
	$A_{IN} = 1448\text{ MHz at } -0.5\text{ dBFS}$			54.1			dB	
	$A_{IN} = 1448\text{ MHz at } -0.5\text{ dBFS}$			55			dB	

**Electrical Characteristics: Dynamic Converter (continued)**
 $T_A = 25^\circ\text{C}$ , unless otherwise noted

PARAMETER		TEST CONDITIONS		MIN	TYP	MAX	UNIT	
THD	Total Harmonic Distortion	$A_{IN} = 125\text{ MHz at } -0.5\text{ dBFS}$	ADC12D1000		-68.7		dB	
			ADC12D1600		-70.3			
		$A_{IN} = 248\text{ MHz at } -0.5\text{ dBFS}$	ADC12D1000	$T_A = T_{MIN}\text{ to } T_{MAX}$			-67	dB
			ADC12D1600	$T_A = T_{MIN}\text{ to } T_{MAX}$			-66.6	
		$A_{IN} = 498\text{ MHz at } -0.5\text{ dBFS}$	ADC12D1000	$T_A = T_{MIN}\text{ to } T_{MAX}$			-67.4	dB
			ADC12D1600	$T_A = T_{MIN}\text{ to } T_{MAX}$			-66	
	$A_{IN} = 998\text{ MHz at } -0.5\text{ dBFS}$	ADC12D1000				-62.9	dB	
		ADC12D1600				-60.8		
	$A_{IN} = 1448\text{ MHz at } -0.5\text{ dBFS}$	ADC12D1000				-63	dB	
		ADC12D1600				-60		
	2nd Harm	Second Harmonic Distortion	$A_{IN} = 125\text{ MHz at } -0.5\text{ dBFS}$	ADC12D1000		-75.7		dBc
				ADC12D1600		-75		
$A_{IN} = 248\text{ MHz at } -0.5\text{ dBFS}$		ADC12D1000				-75.7	dBc	
		ADC12D1600				-80		
$A_{IN} = 498\text{ MHz at } -0.5\text{ dBFS}$		ADC12D1000				-79.8	dBc	
		ADC12D1600				-71		
$A_{IN} = 998\text{ MHz at } -0.5\text{ dBFS}$		ADC12D1000				-70	dBc	
		ADC12D1600				-73		
$A_{IN} = 1448\text{ MHz at } -0.5\text{ dBFS}$					-67	dBc		
3rd Harm		Third Harmonic Distortion	$A_{IN} = 125\text{ MHz at } -0.5\text{ dBFS}$	ADC12D1000		-71		dBc
	ADC12D1600				-74			
	$A_{IN} = 248\text{ MHz at } -0.5\text{ dBFS}$		ADC12D1000				-68.4	dBc
			ADC12D1600				-68	
	$A_{IN} = 498\text{ MHz at } -0.5\text{ dBFS}$		ADC12D1000				-68.7	dBc
			ADC12D1600				-69	
	$A_{IN} = 998\text{ MHz at } -0.5\text{ dBFS}$	ADC12D1000				-66	dBc	
		ADC12D1600				-62		
	$A_{IN} = 1448\text{ MHz at } -0.5\text{ dBFS}$	ADC12D1000				-67	dBc	
		ADC12D1600				-61		
	SFDR	Spurious-Free Dynamic Range	$A_{IN} = 125\text{ MHz at } -0.5\text{ dBFS}$	ADC12D1000		71		dBc
				ADC12D1600		70.3		
$A_{IN} = 248\text{ MHz at } -0.5\text{ dBFS}$			ADC12D1000	$T_A = T_{MIN}\text{ to } T_{MAX}$	68.4		61	dBc
			ADC12D1600	$T_A = T_{MIN}\text{ to } T_{MAX}$	68		60	
$A_{IN} = 498\text{ MHz at } -0.5\text{ dBFS}$			ADC12D1000	$T_A = T_{MIN}\text{ to } T_{MAX}$	68.7		61	dBc (min)
			ADC12D1600	$T_A = T_{MIN}\text{ to } T_{MAX}$	68.2		60	
$A_{IN} = 998\text{ MHz at } -0.5\text{ dBFS}$		ADC12D1000				66	dBc	
		ADC12D1600				62		
$A_{IN} = 1448\text{ MHz at } -0.5\text{ dBFS}$		ADC12D1000				67	dBc	
		ADC12D1600				61.9		

**Electrical Characteristics: Dynamic Converter (continued)**
 $T_A = 25^\circ\text{C}$ , unless otherwise noted

PARAMETER		TEST CONDITIONS		MIN	TYP	MAX	UNIT		
<b>DES MODE<sup>(2)</sup>(2)</b>									
ENOB	Effective Number of Bits	$A_{IN} = 125\text{ MHz at } -0.5\text{ dBFS}$	ADC12D1000		9.5		bits		
			ADC12D1600		9.4				
		$A_{IN} = 248\text{ MHz at } -0.5\text{ dBFS}$	ADC12D1000	$T_A = T_{MIN}\text{ to } T_{MAX}$	9.4		bits		
			ADC12D1600	$T_A = T_{MIN}\text{ to } T_{MAX}$	9.2	8.6			
		$A_{IN} = 498\text{ MHz at } -0.5\text{ dBFS}$	ADC12D1000			9.2	bits		
			ADC12D1600			9.1			
		$A_{IN} = 998\text{ MHz at } -0.5\text{ dBFS}$	ADC12D1000			8.8	bits		
			ADC12D1600			8.5			
		$A_{IN} = 1448\text{ MHz at } -0.5\text{ dBFS}$	ADC12D1000			8.6	bits		
			ADC12D1600			8.5			
		SINAD	Signal-to-Noise Plus Distortion Ratio	$A_{IN} = 125\text{ MHz at } -0.5\text{ dBFS}$	ADC12D1000		59		dB
					ADC12D1600		58.2		
$A_{IN} = 248\text{ MHz at } -0.5\text{ dBFS}$	ADC12D1000			$T_A = T_{MIN}\text{ to } T_{MAX}$	58.6	54	dB		
	ADC12D1600			$T_A = T_{MIN}\text{ to } T_{MAX}$	57	53.5			
$A_{IN} = 498\text{ MHz at } -0.5\text{ dBFS}$	ADC12D1000					57.3	dB		
	ADC12D1600					56.9			
$A_{IN} = 998\text{ MHz at } -0.5\text{ dBFS}$	ADC12D1000					54.5	dB		
	ADC12D1600					52.7			
$A_{IN} = 1448\text{ MHz at } -0.5\text{ dBFS}$	ADC12D1000					53.9	dB		
	ADC12D1600					52.7			
SNR	Signal-to-Noise Ratio			$A_{IN} = 125\text{ MHz at } -0.5\text{ dBFS}$	ADC12D1000		59.2		dB
					ADC12D1600		58.6		
		$A_{IN} = 248\text{ MHz at } -0.5\text{ dBFS}$	ADC12D1000	$T_A = T_{MIN}\text{ to } T_{MAX}$	58.9	55.3	dB		
			ADC12D1600	$T_A = T_{MIN}\text{ to } T_{MAX}$	57.9	54.6			
		$A_{IN} = 498\text{ MHz at } -0.5\text{ dBFS}$	ADC12D1000			58.3	dB		
			ADC12D1600			57.6			
		$A_{IN} = 998\text{ MHz at } -0.5\text{ dBFS}$	ADC12D1000			55.9	dB		
			ADC12D1600			53.6			
		$A_{IN} = 1448\text{ MHz at } -0.5\text{ dBFS}$	ADC12D1000			54.2	dB		
			ADC12D1600			53.3			
		THD	Total Harmonic Distortion	$A_{IN} = 125\text{ MHz at } -0.5\text{ dBFS}$	ADC12D1000		-74		dB
					ADC12D1600		-68.2		
$A_{IN} = 248\text{ MHz at } -0.5\text{ dBFS}$	ADC12D1000			$T_A = T_{MIN}\text{ to } T_{MAX}$			-71.2	dB	
	ADC12D1600			$T_A = T_{MIN}\text{ to } T_{MAX}$			-60		
$A_{IN} = 498\text{ MHz at } -0.5\text{ dBFS}$	ADC12D1000						-64.6	dB	
	ADC12D1600						-60		
$A_{IN} = 998\text{ MHz at } -0.5\text{ dBFS}$	ADC12D1000					-63.8	dB		
	ADC12D1600					-66.3			
$A_{IN} = 1448\text{ MHz at } -0.5\text{ dBFS}$	ADC12D1000					-60	dB		
	ADC12D1600					-60			
$A_{IN} = 1448\text{ MHz at } -0.5\text{ dBFS}$	ADC12D1000					-65	dB		
	ADC12D1600					-61.7			

**Electrical Characteristics: Dynamic Converter (continued)**
 $T_A = 25^\circ\text{C}$ , unless otherwise noted

PARAMETER		TEST CONDITIONS		MIN	TYP	MAX	UNIT
2nd Harm	Second Harmonic Distortion	$A_{IN} = 125\text{ MHz at } -0.5\text{ dBFS}$	ADC12D1000		-82		dBc
			ADC12D1600		-77.3		
		$A_{IN} = 248\text{ MHz at } -0.5\text{ dBFS}$	ADC12D1000		-82		dBc
			ADC12D1600		-82.7		
		$A_{IN} = 498\text{ MHz at } -0.5\text{ dBFS}$	ADC12D1000		-72		dBc
			ADC12D1600		-71.6		
		$A_{IN} = 998\text{ MHz at } -0.5\text{ dBFS}$	ADC12D1000		-63.2		dBc
			ADC12D1600		-63		
		$A_{IN} = 1448\text{ MHz at } -0.5\text{ dBFS}$	ADC12D1000		-75		dBc
			ADC12D1600		-75.6		
3rd Harm	Third Harmonic Distortion	$A_{IN} = 125\text{ MHz at } -0.5\text{ dBFS}$	ADC12D1000		-82		dBc
			ADC12D1600		-69.8		
		$A_{IN} = 248\text{ MHz at } -0.5\text{ dBFS}$	ADC12D1000		-73		dBc
			ADC12D1600		-65.3		
		$A_{IN} = 498\text{ MHz at } -0.5\text{ dBFS}$	ADC12D1000		-65		dBc
			ADC12D1600		-67.3		
		$A_{IN} = 998\text{ MHz at } -0.5\text{ dBFS}$	ADC12D1000		-65		dBc
			ADC12D1600		-63		
		$A_{IN} = 1448\text{ MHz at } -0.5\text{ dBFS}$	ADC12D1000		-67		dBc
			ADC12D1600		-62.4		
SFDR	Spurious-Free Dynamic Range	$A_{IN} = 125\text{ MHz at } -0.5\text{ dBFS}$	ADC12D1000		69		dBc
			ADC12D1600		69.8		
		$A_{IN} = 248\text{ MHz at } -0.5\text{ dBFS}$	ADC12D1000	$T_A = T_{MIN}\text{ to } T_{MAX}$	69 60		dBc
			ADC12D1600	$T_A = T_{MIN}\text{ to } T_{MAX}$	65.3 60		
		$A_{IN} = 498\text{ MHz at } -0.5\text{ dBFS}$	ADC12D1000		65		dBc
			ADC12D1600		67.3		
		$A_{IN} = 998\text{ MHz at } -0.5\text{ dBFS}$	ADC12D1000		64		dBc
			ADC12D1600		60.2		
		$A_{IN} = 1448\text{ MHz at } -0.5\text{ dBFS}$	ADC12D1000		66		dBc
			ADC12D1600		60		

## 6.7 Electrical Characteristics: Analog Input/Output and Reference

 $T_A = 25^\circ\text{C}$ , unless otherwise noted

PARAMETER		TEST CONDITIONS		MIN	TYP	MAX	UNIT	
<b>ANALOG INPUTS</b>								
$V_{IN\_FSR}$	Analog Differential Input Full Scale Range	<b>NON-EXTENDED CONTROL MODE</b>						
		FSR Pin Low	ADC12D1000 $T_A = T_{MIN}$ to $T_{MAX}$	540	600	660	mV <sub>P-P</sub>	
			ADC12D1600 $T_A = T_{MIN}$ to $T_{MAX}$	540	600	660	mV <sub>P-P</sub>	
		FSR Pin High	ADC12D1000 $T_A = T_{MIN}$ to $T_{MAX}$	740	800	860	mV <sub>P-P</sub>	
			ADC12D1600 $T_A = T_{MIN}$ to $T_{MAX}$	740	800	860	mV <sub>P-P</sub>	
		<b>EXTENDED CONTROL MODE</b>						
		FM(14:0) = 0000h			600		mV <sub>P-P</sub>	
FM(14:0) = 4000h (default)			800		mV <sub>P-P</sub>			
FM(14:0) = 7FFFh			1000		mV <sub>P-P</sub>			
$C_{IN}$	Analog Input Capacitance, Non-DES Mode <sup>(1)(2)</sup>	Differential			0.02		pF	
		Each input pin to ground			1.6		pF	
	Analog Input Capacitance, DES Mode <sup>(1)(2)</sup>	Differential				0.08		pF
		Each input pin to ground				2.2		pF
$R_{IN}$	Differential Input Resistance	ADC12D1000 $T_A = T_{MIN}$ to $T_{MAX}$	91	100	109		$\Omega$	
		ADC12D1600 $T_A = T_{MIN}$ to $T_{MAX}$	91	100	109		$\Omega$	
<b>COMMON-MODE OUTPUT</b>								
$V_{CMO}$	Common-Mode Output Voltage	$I_{CMO} = \pm 100 \mu\text{A}$	ADC12D1000 $T_A = T_{MIN}$ to $T_{MAX}$	1.15	1.25	1.35	V	
			ADC12D1600 $T_A = T_{MIN}$ to $T_{MAX}$	1.15	1.25	1.35	V	
$TC_{V_{CMO}}$	Common-Mode Output Voltage Temperature Coefficient	$I_{CMO} = \pm 100 \mu\text{A}$			38		ppm/ $^\circ\text{C}$	
$V_{CMO\_LVL}$	$V_{CMO}$ input threshold to set DC-coupling Mode				0.63		V	
$C_{L\_V_{CMO}}$	Maximum $V_{CMO}$ Load Capacitance	See <sup>(3)</sup>				80	pF	

(1) This parameter is specified by design and is not tested in production.

(2) The differential and pin-to-ground input capacitances are lumped capacitance values from design; they are defined as shown below

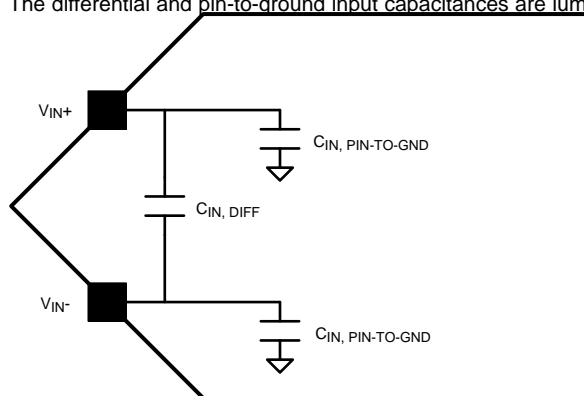

(3) This parameter is specified by design and is not tested in production.

**Electrical Characteristics: Analog Input/Output and Reference (continued)**
 $T_A = 25^\circ\text{C}$ , unless otherwise noted

PARAMETER		TEST CONDITIONS		MIN	TYP	MAX	UNIT
<b>BANDGAP REFERENCE</b>							
$V_{BG}$	Bandgap Reference Output Voltage	$I_{BG} = \pm 100 \mu\text{A}$	ADC12D1000 $T_A = T_{MIN}$ to $T_{MAX}$	1.15	1.25	1.35	V
			ADC12D1600 $T_A = T_{MIN}$ to $T_{MAX}$	1.15	1.25	1.35	V
$TC_{V_{BG}}$	Bandgap Reference Voltage Temperature Coefficient	$I_{BG} = \pm 100 \mu\text{A}$			32		ppm/ $^\circ\text{C}$
$C_{L_{V_{BG}}}$	Maximum Bandgap Reference load Capacitance	See <sup>(3)</sup>				80	pF

**6.8 Electrical Characteristics: I-Channel To Q-Channel**

PARAMETER		TEST CONDITIONS		MIN	TYP	MAX	UNIT
Offset Match					2		LSB
Positive Full-Scale Match		Zero offset selected in Control Register			2		LSB
Negative Full-Scale Match		Zero offset selected in Control Register			2		LSB
Phase Matching (I, Q)		$f_{IN} = 1 \text{ GHz}$			< 1		Degree
X-TALK	Crosstalk from I-channel (Aggressor) to Q-channel (Victim)	Aggressor = 867 MHz F.S. Victim = 100 MHz F.S.			-70		dB
	Crosstalk from Q-channel (Aggressor) to I-channel (Victim)	Aggressor = 867 MHz F.S. Victim = 100 MHz F.S.			-70		dB

**6.9 Electrical Characteristics: Converter and Sampling Clock**
 $T_A = 25^\circ\text{C}$ , unless otherwise noted

PARAMETER		TEST CONDITIONS		MIN	TYP	MAX	UNIT
$V_{IN\_CLK}$	Differential Sampling Clock Input Level <sup>(1)</sup>	Sine Wave Clock Differential Peak-to-Peak	ADC12D1000 $T_A = T_{MIN}$ to $T_{MAX}$	0.4	0.6	2	$V_{P-P}$
			ADC12D1600 $T_A = T_{MIN}$ to $T_{MAX}$	0.4	0.6	2	$V_{P-P}$
		Square Wave Clock Differential Peak-to-Peak	ADC12D1000 $T_A = T_{MIN}$ to $T_{MAX}$	0.4	0.6	2	$V_{P-P}$ (min)
			ADC12D1600 $T_A = T_{MIN}$ to $T_{MAX}$	0.4	0.6	2	$V_{P-P}$ (max)
$C_{IN\_CLK}$	Sampling Clock Input Capacitance <sup>(2)</sup>	Differential			0.1		pF
		Each input to ground			1		pF
$R_{IN\_CLK}$	Sampling Clock Differential Input Resistance				100		$\Omega$

(1) This parameter is specified by design and/or characterization and is not tested in production.

(2) This parameter is specified by design and is not tested in production.

**6.10 Electrical Characteristics: Autosync Feature**

PARAMETER		TEST CONDITIONS		MIN	TYP	MAX	UNIT
$V_{IN\_RCLK}$	Differential RCLK Input Level	Differential Peak-to-Peak			360		m $V_{P-P}$
$C_{IN\_RCLK}$	RCLK Input Capacitance	Differential			0.1		pF
		Each input to ground			1		
$R_{IN\_RCLK}$	RCLK Differential Input Resistance				100		$\Omega$
$I_{IH\_RCLK}$	Input Leakage Current; $V_{IN} = V_A$				22		$\mu\text{A}$

**Electrical Characteristics: Autosync Feature (continued)**

PARAMETER		TEST CONDITIONS	MIN	TYP	MAX	UNIT
$I_{IL\_RCLK}$	Input Leakage Current; $V_{IN} = GND$			-33		$\mu A$
$V_{O\_RCOUT}$	Differential RCOOut Output Voltage			360		mV

**6.11 Electrical Characteristics: Digital Control and Output Pin**
 $T_A = 25^\circ C$ , unless otherwise noted

PARAMETER		TEST CONDITIONS	MIN	TYP	MAX	UNIT		
<b>DIGITAL CONTROL PINS (DES, CalDly, CAL, PDI, PDQ, TPM, NDM, FSR, DDRPh, <math>\overline{ECE}</math>, SCLK, SDI, <math>\overline{SCS}</math>)</b>								
$V_{IH}$	Logic High Input Voltage	$T_A = T_{MIN}$ to $T_{MAX}$	0.7 $\times V_A$			V		
$V_{IL}$	Logic Low Input Voltage	$T_A = T_{MIN}$ to $T_{MAX}$			0.3 $\times V_A$	V		
$I_{IH}$	Input Leakage Current; $V_{IN} = V_A$			0.02		$\mu A$		
$I_{IL}$	Input Leakage Current; $V_{IN} = GND$	FSR, CalDly, CAL, NDM, TPM, DDRPh, DES		-0.02		$\mu A$		
		$\overline{SCS}$ , SCLK, SDI		-17		$\mu A$		
		PDI, PDQ, $\overline{ECE}$		-38		$\mu A$		
$C_{IN\_DIG}$	Digital Control Pin Input Capacitance <sup>(1)</sup>	Measured from each control pin to GND		1.5		pF		
<b>DIGITAL OUTPUT PINS (DATA, DCLKI, DCLKQ, ORI, ORQ)</b>								
$V_{OD}$	LVDS Differential Output Voltage	$V_{BG} = \text{Floating, OVS} = \text{High}$	ADC12D1000 $T_A = T_{MIN}$ to $T_{MAX}$	400	630	800	mV <sub>P-P</sub>	
			ADC12D1600 $T_A = T_{MIN}$ to $T_{MAX}$	400	630	800	mV <sub>P-P</sub>	
		$V_{BG} = \text{Floating, OVS} = \text{Low}$	ADC12D1000 $T_A = T_{MIN}$ to $T_{MAX}$	230	460	630	mV <sub>P-P</sub>	
			ADC12D1600 $T_A = T_{MIN}$ to $T_{MAX}$	230	460	630	mV <sub>P-P</sub>	
		$V_{BG} = V_A, \text{OVS} = \text{High}$				670		mV <sub>P-P</sub>
		$V_{BG} = V_A, \text{OVS} = \text{Low}$				500		mV <sub>P-P</sub>
$\Delta V_{O\_DIFF}$	Change in LVDS Output Swing Between Logic Levels			$\pm 1$		mV		
$V_{OS}$	Output Offset Voltage	$V_{BG} = \text{Floating}$		0.8		V		
		$V_{BG} = V_A$		1.2		V		
$\Delta V_{OS}$	Output Offset Voltage Change Between Logic Levels			$\pm 1$		mV		
$I_{OS}$	Output Short-Circuit Current	$V_{BG} = \text{Floating};$ D+ and D- connected to 0.8 V		$\pm 4$		mA		
$Z_O$	Differential Output Impedance			100		$\Omega$		
$V_{OH}$	Logic High-Output Level	CalRun, $I_{OH} = -100 \mu A^{(2)}$ , SDO, $I_{OH} = -400 \mu A^{(2)}$		1.65		V		
$V_{OL}$	Logic Low Output Level	CalRun, $I_{OL} = 100 \mu A^{(2)}$ , SDO, $I_{OL} = 400 \mu A^{(2)}$		0.15		V		
<b>DIFFERENTIAL DCLK RESET PINS (DCLK_RST)</b>								
$V_{CMI\_DRS\_T}$	DCLK_RST Common-Mode Input Voltage			1.25		V		
$V_{ID\_DRST}$	Differential DCLK_RST Input Voltage			$V_{IN\_CLK}$		$V_{P-P}$		
$R_{IN\_DRST}$	Differential DCLK_RST Input Resistance	See <sup>(1)</sup>		100		$\Omega$		

(1) This parameter is specified by design and is not tested in production.

(2) This parameter is specified by design and/or characterization and is not tested in production.

## ADC12D1000, ADC12D1600

SNAS480N – MAY 2010 – REVISED AUGUST 2015

www.ti.com

### 6.12 Electrical Characteristics: Power Supply

T<sub>A</sub> = 25°C, unless otherwise noted

PARAMETER		TEST CONDITIONS		MIN	TYP	MAX	UNIT	
I <sub>A</sub>	Analog Supply Current	PDI = PDQ = Low	ADC12D1000		1110		mA	
			ADC12D1600		1235			
		PDI = Low; PDQ = High	ADC12D1000		610		mA	
			ADC12D1600		670			
		PDI = High; PDQ = Low	ADC12D1000		610		mA	
			ADC12D1600		670			
PDI = PDQ = High				15		mA		
I <sub>TC</sub>	Track-and-Hold and Clock Supply Current	PDI = PDQ = Low	ADC12D1000		400		mA	
			ADC12D1600		470			
		PDI = Low; PDQ = High	ADC12D1000		240		mA	
			ADC12D1600		280			
		PDI = High; PDQ = Low	ADC12D1000		240		mA	
			ADC12D1600		280			
PDI = PDQ = High				4		mA		
I <sub>DR</sub>	Output Driver Supply Current	PDI = PDQ = Low	ADC12D1000		305		mA	
			ADC12D1600		325			
		PDI = Low; PDQ = High	ADC12D1000		160		mA	
			ADC12D1600		170			
		PDI = High; PDQ = Low	ADC12D1000		160		mA	
			ADC12D1600		170			
PDI = PDQ = High				3		mA		
I <sub>E</sub>	Digital Encoder Supply Current	PDI = PDQ = Low	ADC12D1000		80		mA	
			ADC12D1600		140			
		PDI = Low; PDQ = High	ADC12D1000		40		mA	
			ADC12D1600		70			
		PDI = High; PDQ = Low	ADC12D1000		40		mA	
			ADC12D1600		70			
PDI = PDQ = High				1		mA		
I <sub>TOTAL</sub>	Total Supply Current	1:2 Demux Mode PDI = PDQ = Low	ADC12D1000 T <sub>A</sub> = T <sub>MIN</sub> to T <sub>MAX</sub>		1895	2105	mA	
			ADC12D1600 T <sub>A</sub> = T <sub>MIN</sub> to T <sub>MAX</sub>		2170	2310		
		Non-Demux Mode PDI = PDQ = Low	ADC12D1000		1780		mA	
			ADC12D1600		2040			
P <sub>C</sub>	Power Consumption	1:2 Demux Mode						
		PDI = PDQ = Low	ADC12D1000 T <sub>A</sub> = T <sub>MIN</sub> to T <sub>MAX</sub>		3.60	4	W	
			ADC12D1600 T <sub>A</sub> = T <sub>MIN</sub> to T <sub>MAX</sub>		4.12	4.4		
		PDI = Low; PDQ = High	ADC12D1000		1.99		W	
			ADC12D1600		2.26			
		PDI = High; PDQ = Low	ADC12D1000		1.99		W	
			ADC12D1600		2.26			
		PDI = PDQ = High				43		mW
		Non-Demux Mode PDI = PDQ = Low	ADC12D1000		3.38		W	
			ADC12D1600		3.88			



## 6.13 Electrical Characteristics: AC

 $T_A = 25^\circ\text{C}$ , unless otherwise noted

PARAMETER		TEST CONDITIONS		MIN	TYP	MAX	UNIT
<b>SAMPLING CLOCK (CLK)</b>							
$f_{\text{CLK (max)}}$	Maximum Sampling Clock Frequency	ADC12D1000 $T_A = T_{\text{MIN}}$ to $T_{\text{MAX}}$				1.0	GHz
		ADC12D1600 $T_A = T_{\text{MIN}}$ to $T_{\text{MAX}}$				1.6	
$f_{\text{CLK (min)}}$	Minimum Sampling Clock Frequency	Non-DES Mode; LFS = 0b	ADC12D1000 $T_A = T_{\text{MIN}}$ to $T_{\text{MAX}}$	300			MHz
			ADC12D1600 $T_A = T_{\text{MIN}}$ to $T_{\text{MAX}}$	300			
		Non-DES Mode; LFS = 1b, $T_A = T_{\text{MIN}}$ to $T_{\text{MAX}}$		150			MHz
		DES Mode, $T_A = T_{\text{MIN}}$ to $T_{\text{MAX}}$		500			MHz
Sampling Clock Duty Cycle	$f_{\text{CLK(min)}} \leq f_{\text{CLK}} \leq f_{\text{CLK(max)}}^{(1)}$	ADC12D1000 $T_A = T_{\text{MIN}}$ to $T_{\text{MAX}}$		20%	50%	80%	
		ADC12D1600 $T_A = T_{\text{MIN}}$ to $T_{\text{MAX}}$		20%	50%	80%	
$t_{\text{CL}}$	Sampling Clock Low Time	See <sup>(2)</sup>	ADC12D1000 $T_A = T_{\text{MIN}}$ to $T_{\text{MAX}}$	200	500		ps
			ADC12D1600 $T_A = T_{\text{MIN}}$ to $T_{\text{MAX}}$	125	312.5		
$t_{\text{CH}}$	Sampling Clock High Time	See <sup>(2)</sup>	ADC12D1000 $T_A = T_{\text{MIN}}$ to $T_{\text{MAX}}$	200	500		p
			ADC12D1600 $T_A = T_{\text{MIN}}$ to $T_{\text{MAX}}$	125	312.5		
<b>DATA CLOCK (DCLKI, DCLKQ)</b>							
DCLK Duty Cycle	See <sup>(2)</sup>	ADC12D1000 $T_A = T_{\text{MIN}}$ to $T_{\text{MAX}}$		45%	50%	55%	
		ADC12D1600 $T_A = T_{\text{MIN}}$ to $T_{\text{MAX}}$		45%	50%	55%	
$t_{\text{SR}}$	Setup Time DCLK_RST $\pm$	See <sup>(1)</sup>			45		ps
$t_{\text{HR}}$	Hold Time DCLK_RST $\pm$	See <sup>(1)</sup>			45		ps
$t_{\text{PWR}}$	Pulse Width DCLK_RST $\pm$	See <sup>(2)</sup> , $T_A = T_{\text{MIN}}$ to $T_{\text{MAX}}$		5			Sampling Clock Cycles
$t_{\text{SYNC\_DLY}}$	DCLK Synchronization Delay	90° Mode <sup>(2)</sup> , $T_A = T_{\text{MIN}}$ to $T_{\text{MAX}}$		4			Sampling Clock Cycles
		0° Mode <sup>(2)</sup> , $T_A = T_{\text{MIN}}$ to $T_{\text{MAX}}$		5			
$t_{\text{LHT}}$	Differential Low-to-High Transition Time	10%-to-90%, $C_L = 2.5$ pF			200		ps
$t_{\text{HLT}}$	Differential High-to-Low Transition Time	10%-to-90%, $C_L = 2.5$ pF			200		ps
$t_{\text{SU}}$	Data-to-DCLK Setup Time	90° Mode <sup>(2)</sup>	ADC12D1000		870		ps
			ADC12D1600		500		
$t_{\text{H}}$	DCLK-to-Data Hold Time	90° Mode <sup>(2)</sup>	ADC12D1000		870		ps
			ADC12D1600		500		
$t_{\text{OSK}}$	DCLK-to-Data Output Skew	50% of DCLK transition to 50% of Data transition <sup>(2)</sup>				±50	ps
<b>DATA INPUT-TO-OUTPUT</b>							
$t_{\text{AD}}$	Aperture Delay	Sampling CLK+ Rise to Acquisition of Data			1.15		ns
$t_{\text{AJ}}$	Aperture Jitter				0.2		ps (rms)

(1) This parameter is specified by design and/or characterization and is not tested in production.

(2) This parameter is specified by design and is not tested in production.

**Electrical Characteristics: AC (continued)**
 $T_A = 25^\circ\text{C}$ , unless otherwise noted

PARAMETER		TEST CONDITIONS	MIN	TYP	MAX	UNIT
$t_{OD}$	Sampling Clock-to Data Output Delay (in addition to Latency)	50% of Sampling Clock transition to 50% of Data transition		3.2		ns
$t_{LAT}$	Latency in 1:2 Demux Non-DES Mode <sup>(2)</sup>	DI, DQ Outputs, $T_A = T_{MIN}$ to $T_{MAX}$			34	Sampling Clock Cycles
		DI <sub>d</sub> , DQ <sub>d</sub> Outputs, $T_A = T_{MIN}$ to $T_{MAX}$			35	
	Latency in 1:4 Demux DES Mode <sup>(2)</sup>	DI Outputs, $T_A = T_{MIN}$ to $T_{MAX}$			34	
		DQ Outputs, $T_A = T_{MIN}$ to $T_{MAX}$			34.5	
		DI <sub>d</sub> Outputs, $T_A = T_{MIN}$ to $T_{MAX}$			35	
		DQ <sub>d</sub> Outputs, $T_A = T_{MIN}$ to $T_{MAX}$			35.5	
	Latency in Non-Demux Non-DES Mode <sup>(2)</sup>	DI Outputs, $T_A = T_{MIN}$ to $T_{MAX}$			34	
		DQ Outputs, $T_A = T_{MIN}$ to $T_{MAX}$			34	
Latency in Non-Demux DES Mode <sup>(2)</sup>	DI Outputs, $T_A = T_{MIN}$ to $T_{MAX}$			34		
	DQ Outputs, $T_A = T_{MIN}$ to $T_{MAX}$			34.5		
$t_{ORR}$	Over-Range Recovery Time	Differential $V_{IN}$ step from $\pm 1.2\text{ V}$ to $0\text{ V}$ to accurate conversion		1		Sampling Clock Cycle
$t_{WU}$	Wake-Up Time (PDI/PDQ low to Rated Accuracy Conversion)	Non-DES Mode <sup>(2)</sup>		500		ns
		DES Mode <sup>(2)</sup>		1		$\mu\text{s}$

**6.14 Timing Requirements: Serial Port Interface**
 $T_A = 25^\circ\text{C}$ , unless otherwise noted

			MIN	TYP	MAX	UNIT
$f_{SCLK}$	Serial Clock Frequency	See <sup>(1)</sup>		15		MHz
	Serial Clock Low Time	$T_A = T_{MIN}$ to $T_{MAX}$	30			ns
	Serial Clock High Time	$T_A = T_{MIN}$ to $T_{MAX}$	30			ns
$t_{SSU}$	Serial Data-to-Serial Clock Rising Setup Time	See <sup>(1)</sup>	2.5			ns
$t_{SH}$	Serial Data-to-Serial Clock Rising Hold Time	See <sup>(1)</sup>	1			ns
$t_{SCS}$	$\overline{SCS}$ -to-Serial Clock Rising Setup Time			2.5		ns
$t_{HCS}$	$\overline{SCS}$ -to-Serial Clock Falling Hold Time			1.5		ns
$t_{BSU}$	Bus turnaround time			10		ns

(1) This parameter is specified by design and is not tested in production.

**6.15 Timing Requirements: Calibration**
 $T_A = 25^\circ\text{C}$ , unless otherwise noted

			MIN	TYP	MAX	UNIT
$t_{CAL}$	Calibration Cycle Time	CSS = 0b		$5.2 \cdot 10^7$		Sampling Clock Cycles
		CSS = 1b				
$t_{CAL\_L}$	CAL Pin Low Time	See <sup>(1)</sup> , $T_A = T_{MIN}$ to $T_{MAX}$	1280			Sampling Clock Cycles
$t_{CAL\_H}$	CAL Pin High Time	See <sup>(1)</sup> , $T_A = T_{MIN}$ to $T_{MAX}$	1280			
$t_{CalDly}$	Calibration delay determined by CalDly Pin <sup>(1)</sup>	CalDly = Low, $T_A = T_{MIN}$ to $T_{MAX}$			$2^{24}$	Sampling Clock Cycles
		CalDly = High, $T_A = T_{MIN}$ to $T_{MAX}$			$2^{30}$	

(1) This parameter is specified by design and is not tested in production.

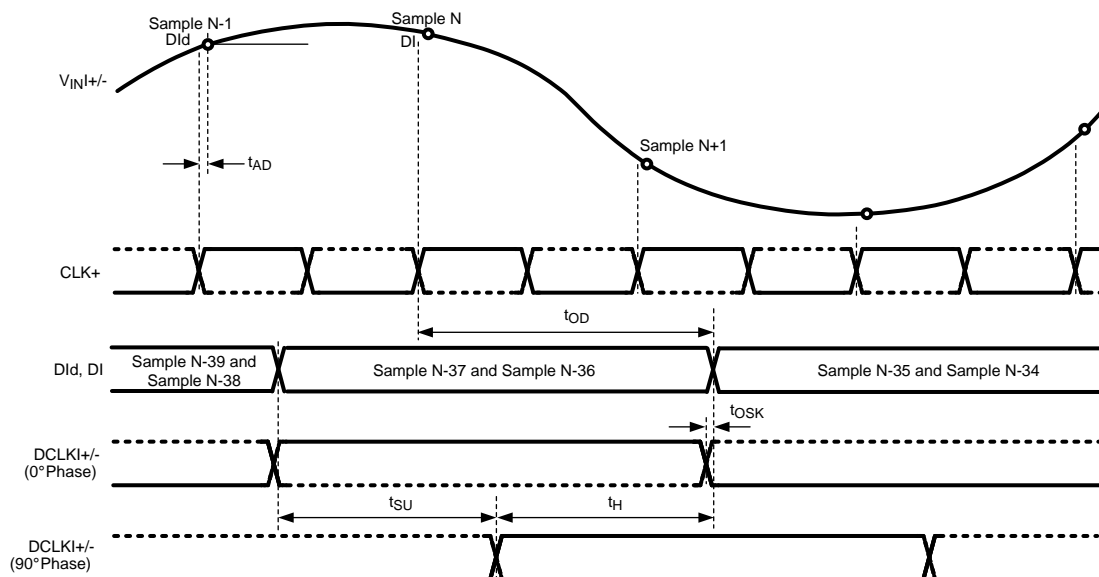

The timing for these figures is shown for the one input only (I or Q). However, both I- and Q-inputs may be used. For this case, the I-channel functions precisely the same as the Q-channel, with  $V_{inI}$ ,  $DCLKI$ ,  $D_{Id}$  and  $D_I$  instead of  $V_{inQ}$ ,  $DCLKQ$ ,  $D_{Qd}$  and  $D_Q$ . Both I- and Q-channel use the same  $CLK$ .

**Figure 1. Clocking in 1:2 Demux Non-DES Mode\***

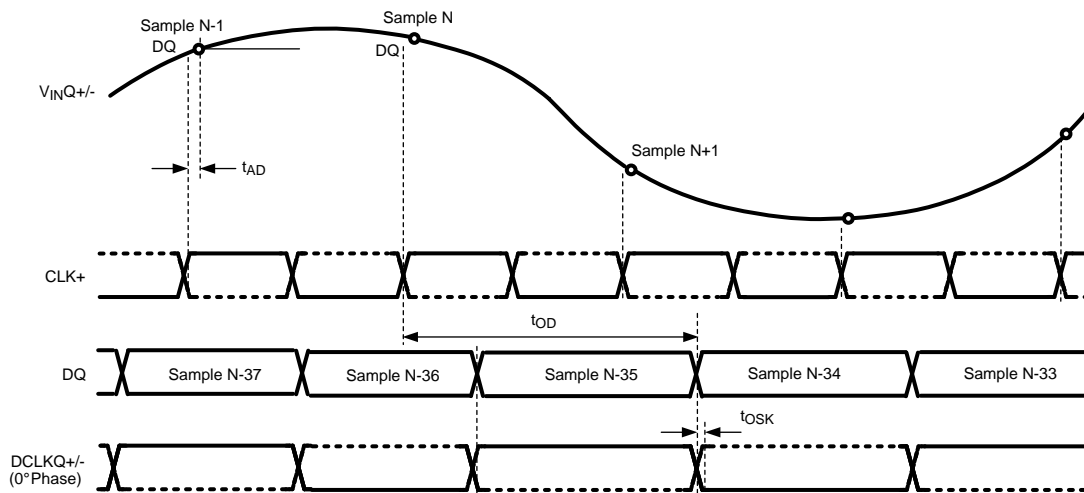

The timing for these figures is shown for the one input only (I or Q). However, both I- and Q-inputs may be used. For this case, the I-channel functions precisely the same as the Q-channel, with  $V_{inI}$ ,  $DCLKI$ ,  $D_{Id}$  and  $D_I$  instead of  $V_{inQ}$ ,  $DCLKQ$ ,  $D_{Qd}$  and  $D_Q$ . Both I- and Q-channel use the same  $CLK$ .

**Figure 2. Clocking in Non-Demux Non-DES Mode\***



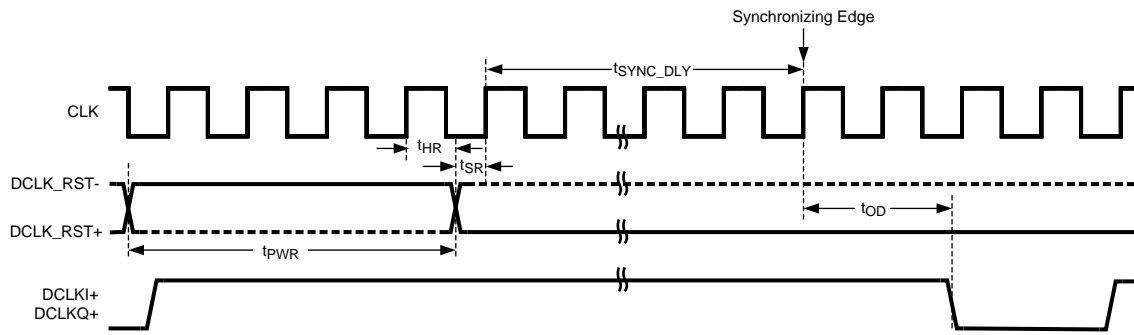

Figure 5. Data Clock Reset Timing (Demux Mode)

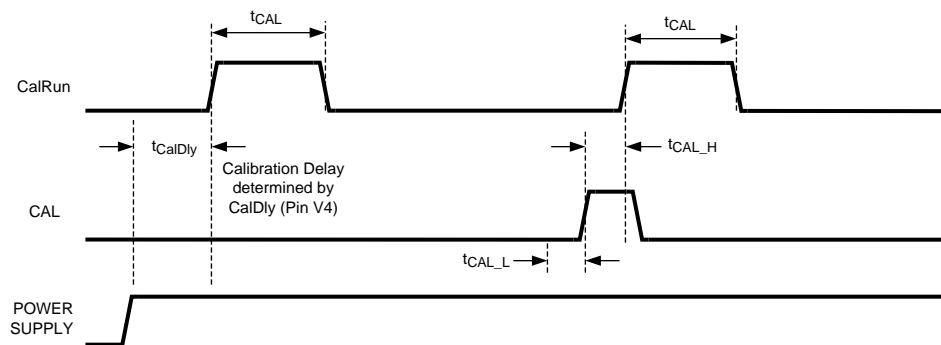

Figure 6. Power-on and On-Command Calibration Timing

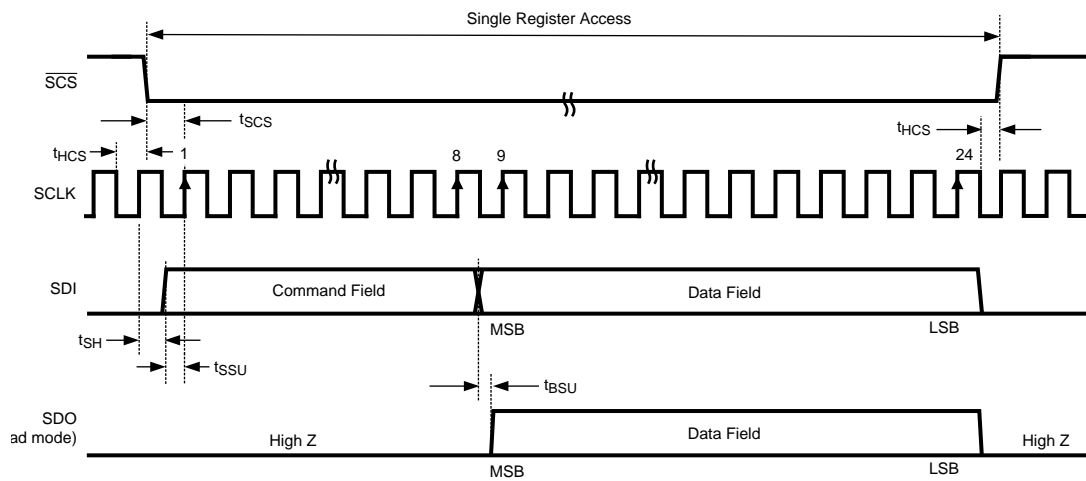

Figure 7. Serial Interface Timing

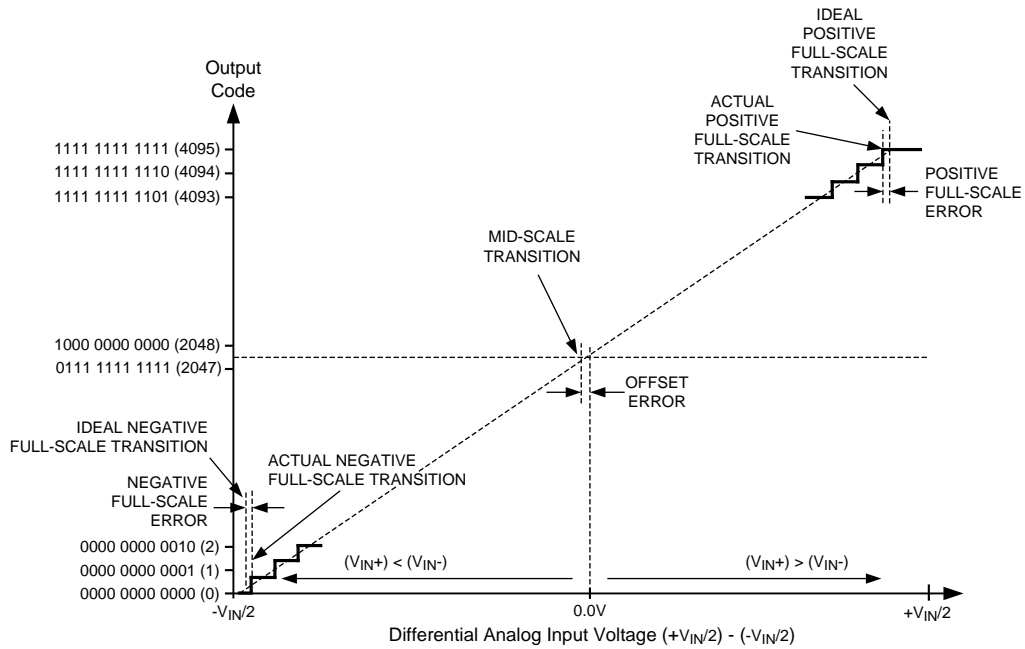

Figure 8. Input / Output Transfer Characteristic

## 6.16 Typical Characteristics

$V_A = V_{DR} = V_{TC} = V_E = 1.9\text{ V}$ ,  $f_{CLK} = 1.0/1.6\text{ GHz}$ ,  $f_{IN} = 498\text{ MHz}$ ,  $T_A = 25^\circ\text{C}$ , I-channel, 1:2 Demux Non-DES Mode (1:1 Demux Non-DES Mode has similar performance), unless otherwise stated. For NPR plots, notch width = 25 MHz,  $f_c = 320\text{ MHz}$ .

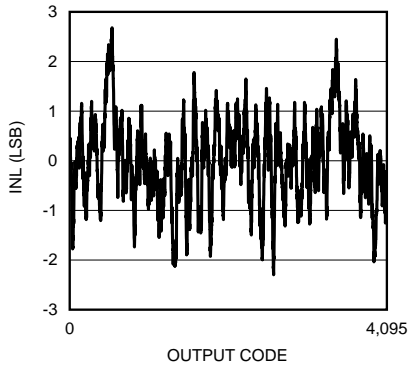

Figure 9. INL vs Code (ADC12D1000)

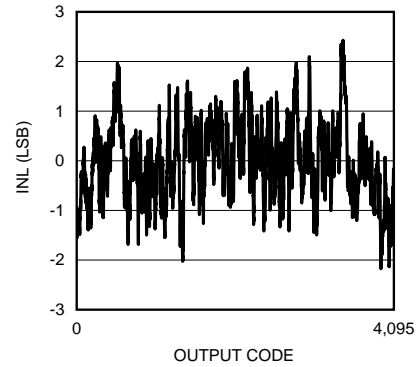

Figure 10. INL vs Code (ADC12D1600)

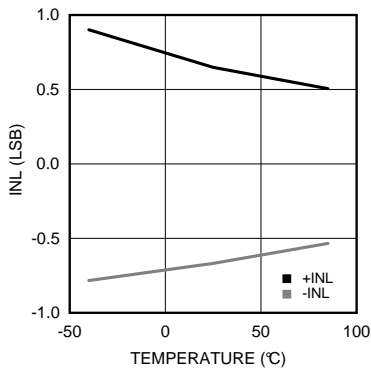

Figure 11. INL vs Temperature (ADC12D1000)

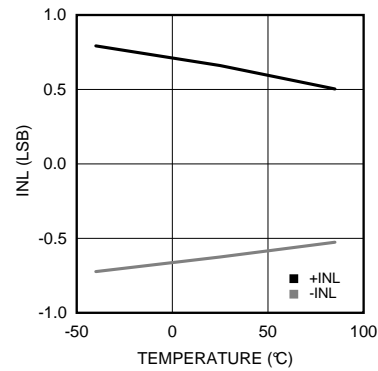

Figure 12. INL vs Temperature (ADC12D1600)

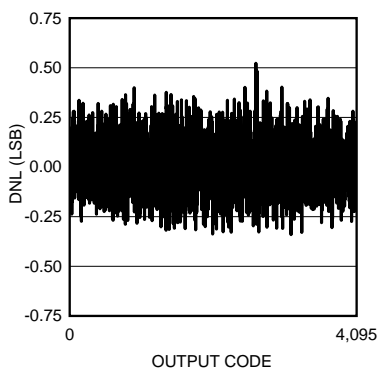

Figure 13. DNL vs Code (ADC12D1000)

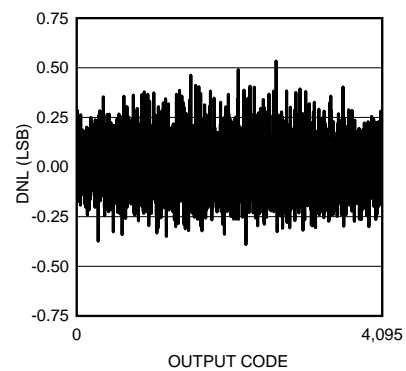
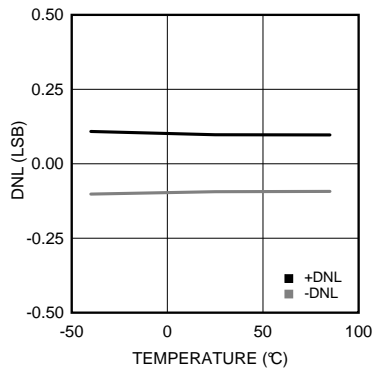
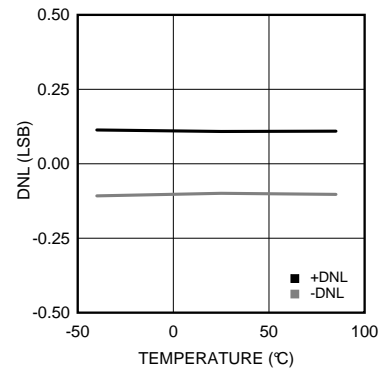
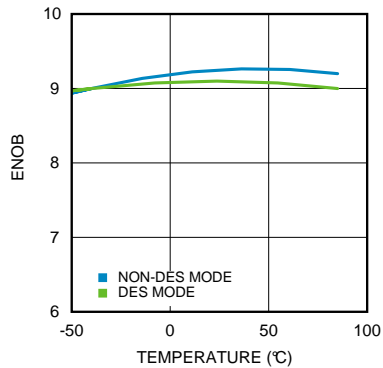
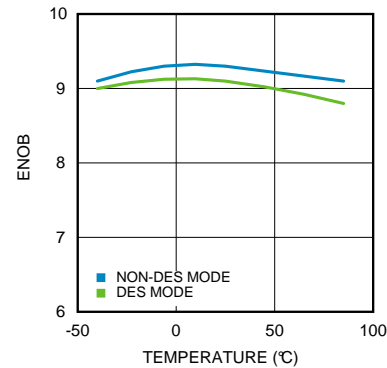
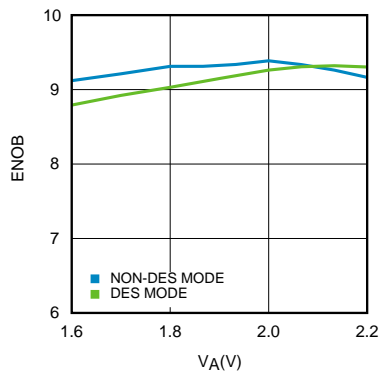
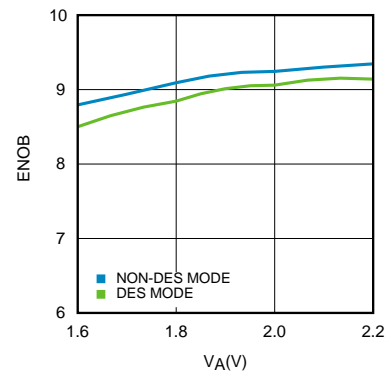

Figure 14. DNL vs Code (ADC12D1600)

**Typical Characteristics (continued)**

$V_A = V_{DR} = V_{TC} = V_E = 1.9\text{ V}$ ,  $f_{CLK} = 1.0/1.6\text{ GHz}$ ,  $f_{IN} = 498\text{ MHz}$ ,  $T_A = 25^\circ\text{C}$ , I-channel, 1:2 Demux Non-DES Mode (1:1 Demux Non-DES Mode has similar performance), unless otherwise stated. For NPR plots, notch width = 25 MHz,  $f_c = 320\text{ MHz}$ .

**Figure 15. DNL vs Temperature (ADC12D1000)**

**Figure 16. DNL vs Temperature (ADC12D1600)**

**Figure 17. ENOB vs Temperature (ADC12D1000)**

**Figure 18. ENOB vs Temperature (ADC12D1600)**

**Figure 19. ENOB vs Supply Voltage (ADC12D1000)**

**Figure 20. ENOB vs Supply Voltage (ADC12D1600)**



Typical Characteristics (continued)

$V_A = V_{DR} = V_{TC} = V_E = 1.9\text{ V}$ ,  $f_{CLK} = 1.0/1.6\text{ GHz}$ ,  $f_{IN} = 498\text{ MHz}$ ,  $T_A = 25^\circ\text{C}$ , I-channel, 1:2 Demux Non-DES Mode (1:1 Demux Non-DES Mode has similar performance), unless otherwise stated. For NPR plots, notch width = 25 MHz,  $f_c = 320\text{ MHz}$ .

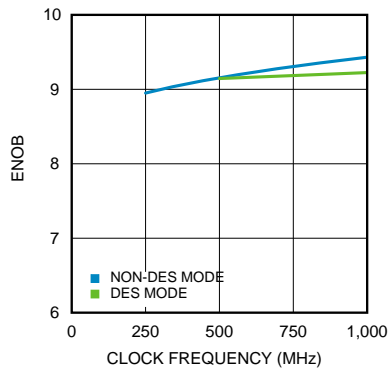

Figure 21. ENOB vs Clock Frequency (ADC12D1000)

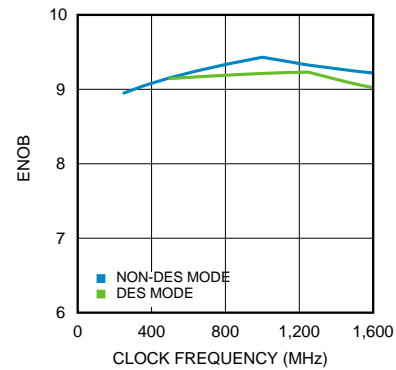

Figure 22. ENOB vs Clock Frequency (ADC12D1600)

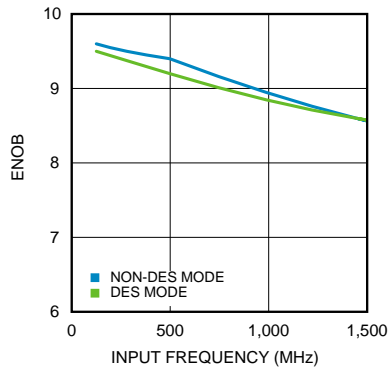

Figure 23. ENOB vs Input Frequency (ADC12D1000)

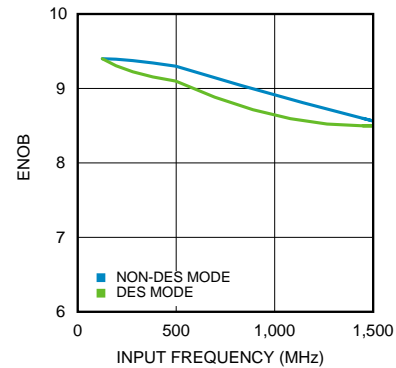

Figure 24. ENOB vs Input Frequency (ADC12D1600)

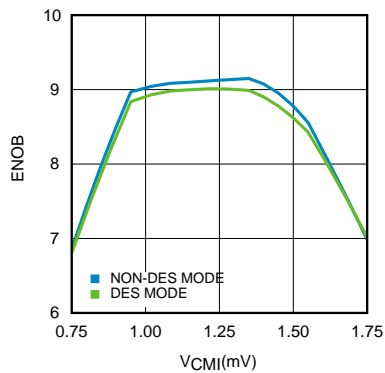

Figure 25. ENOB vs  $V_{CMI}$  (ADC12D1000)

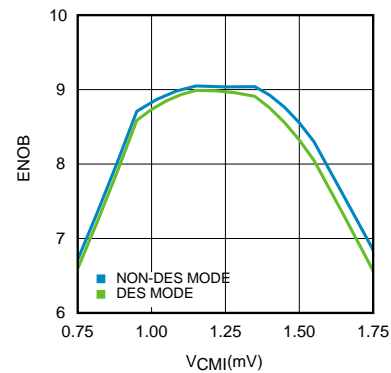

Figure 26. ENOB vs  $V_{CMI}$  (ADC12D1600)

Typical Characteristics (continued)

$V_A = V_{DR} = V_{TC} = V_E = 1.9\text{ V}$ ,  $f_{CLK} = 1.0/1.6\text{ GHz}$ ,  $f_{IN} = 498\text{ MHz}$ ,  $T_A = 25^\circ\text{C}$ , I-channel, 1:2 Demux Non-DES Mode (1:1 Demux Non-DES Mode has similar performance), unless otherwise stated. For NPR plots, notch width = 25 MHz,  $f_c = 320\text{ MHz}$ .

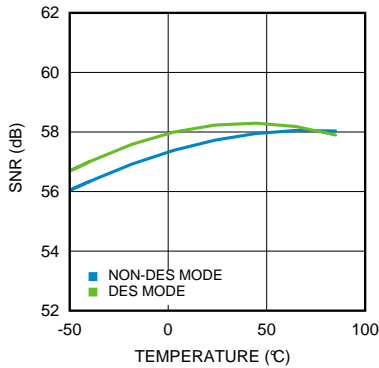

Figure 27. SNR vs Temperature (ADC12D1000)

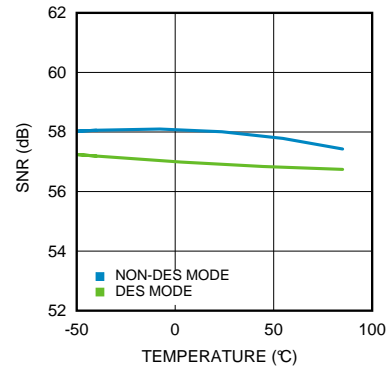

Figure 28. SNR vs Temperature (ADC12D1600)

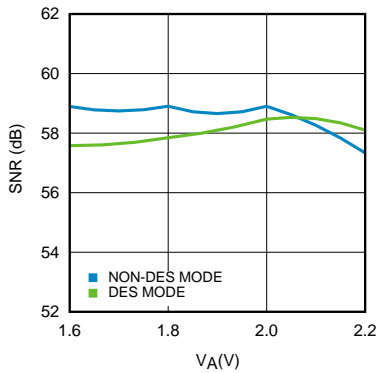

Figure 29. SNR vs Supply Voltage (ADC12D1000)

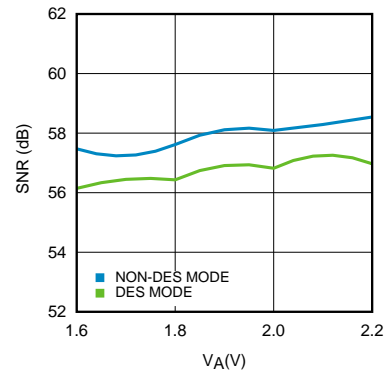

Figure 30. SNR vs Supply Voltage (ADC12D1600)

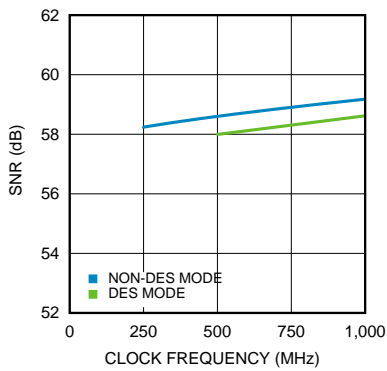

Figure 31. SNR vs Clock Frequency (ADC12D1000)

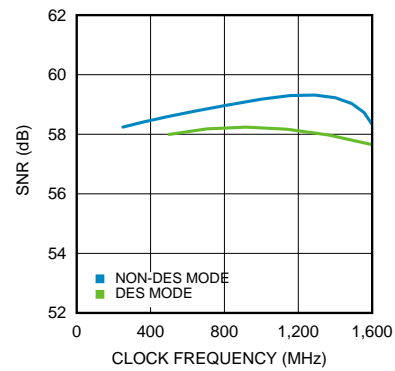

Figure 32. SNR vs Clock Frequency (ADC12D1600)

Typical Characteristics (continued)

$V_A = V_{DR} = V_{TC} = V_E = 1.9\text{ V}$ ,  $f_{CLK} = 1.0/1.6\text{ GHz}$ ,  $f_{IN} = 498\text{ MHz}$ ,  $T_A = 25^\circ\text{C}$ , I-channel, 1:2 Demux Non-DES Mode (1:1 Demux Non-DES Mode has similar performance), unless otherwise stated. For NPR plots, notch width = 25 MHz,  $f_c = 320\text{ MHz}$ .

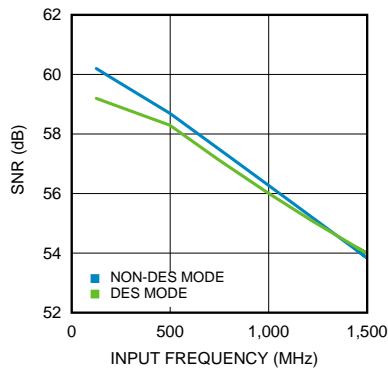

Figure 33. SNR vs Input Frequency (ADC12D1000)

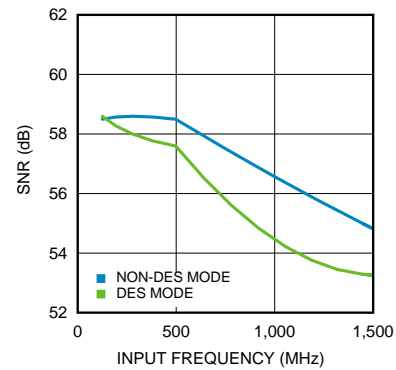

Figure 34. SNR vs Input Frequency (ADC12D1600)

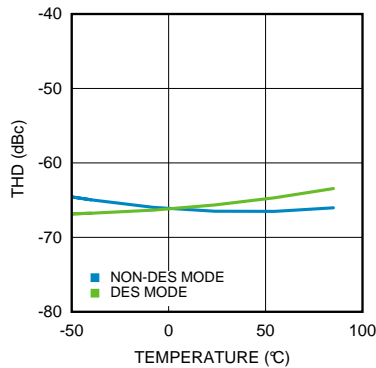

Figure 35. THD vs Temperature (ADC12D1000)

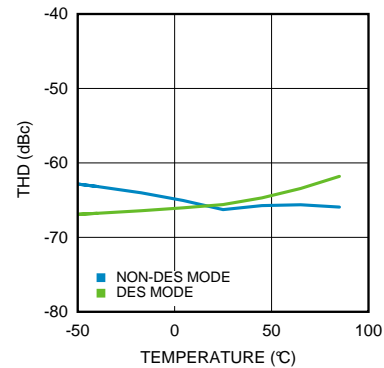

Figure 36. THD vs Temperature (ADC12D1600)

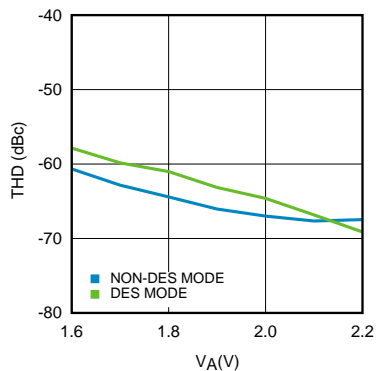

Figure 37. THD vs Supply Voltage (ADC12D1000)

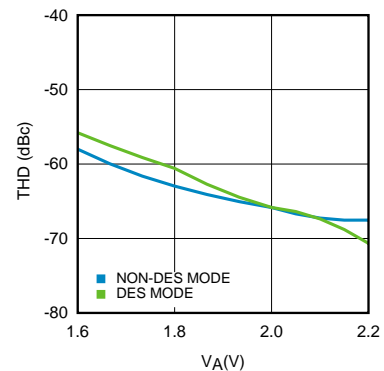

Figure 38. THD vs Supply Voltage (ADC12D1600)

Typical Characteristics (continued)

$V_A = V_{DR} = V_{TC} = V_E = 1.9\text{ V}$ ,  $f_{CLK} = 1.0/1.6\text{ GHz}$ ,  $f_{IN} = 498\text{ MHz}$ ,  $T_A = 25^\circ\text{C}$ , I-channel, 1:2 Demux Non-DES Mode (1:1 Demux Non-DES Mode has similar performance), unless otherwise stated. For NPR plots, notch width = 25 MHz,  $f_c = 320\text{ MHz}$ .

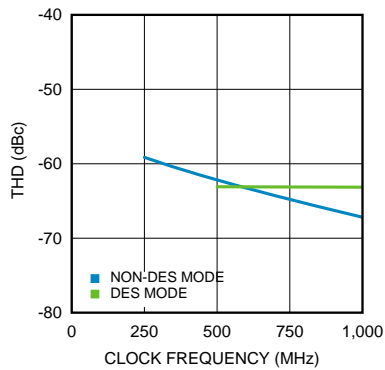

Figure 39. THD vs Clock Frequency (ADC12D1000)

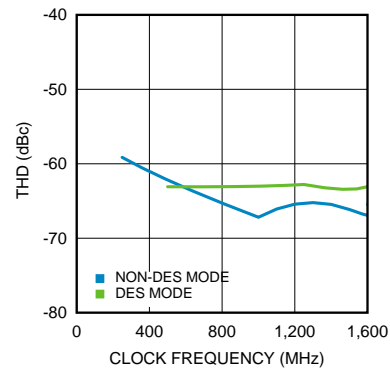

Figure 40. THD vs Clock Frequency (ADC12D1600)

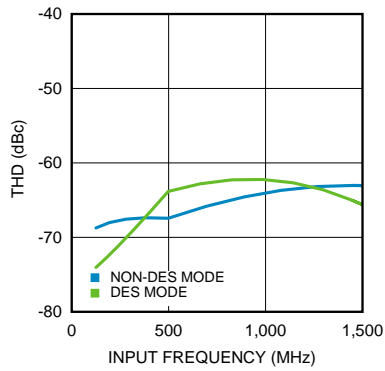

Figure 41. THD vs Input Frequency (ADC12D1000)

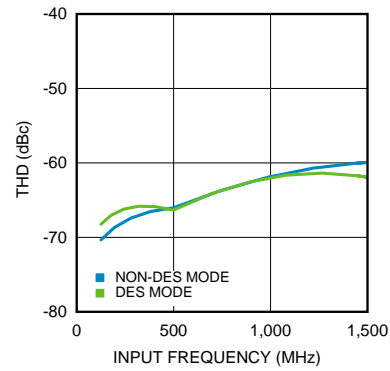

Figure 42. THD vs Input Frequency (ADC12D1600)

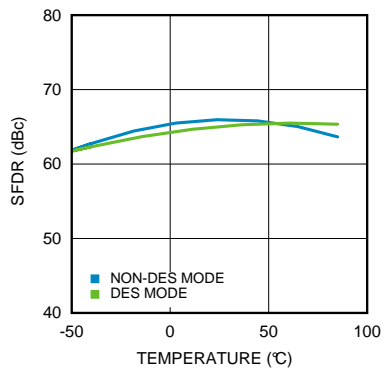

Figure 43. SFDR vs Temperature (ADC12D1000)

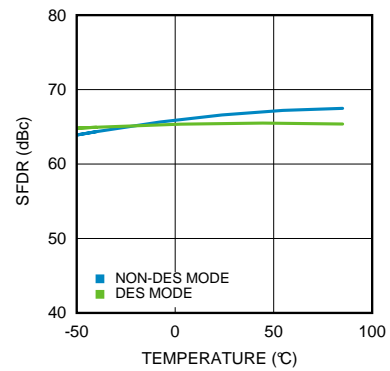
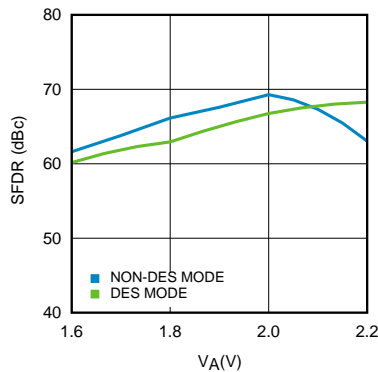

Figure 44. SFDR vs Temperature (ADC12D1600)

**Typical Characteristics (continued)**

$V_A = V_{DR} = V_{TC} = V_E = 1.9\text{ V}$ ,  $f_{CLK} = 1.0/1.6\text{ GHz}$ ,  $f_{IN} = 498\text{ MHz}$ ,  $T_A = 25^\circ\text{C}$ , I-channel, 1:2 Demux Non-DES Mode (1:1 Demux Non-DES Mode has similar performance), unless otherwise stated. For NPR plots, notch width = 25 MHz,  $f_c = 320\text{ MHz}$ .



**Figure 45. SFDR vs Supply Voltage (ADC12D1000)**

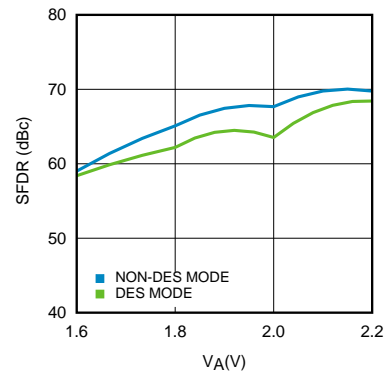

**Figure 46. SFDR vs Supply Voltage (ADC12D1600)**

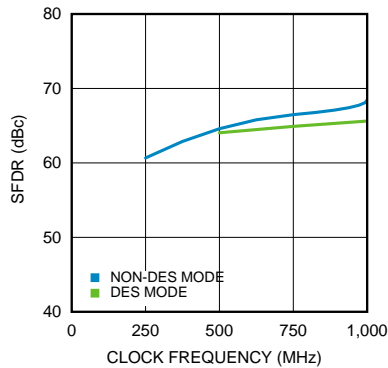

**Figure 47. SFDR vs Clock Frequency (ADC12D1000)**

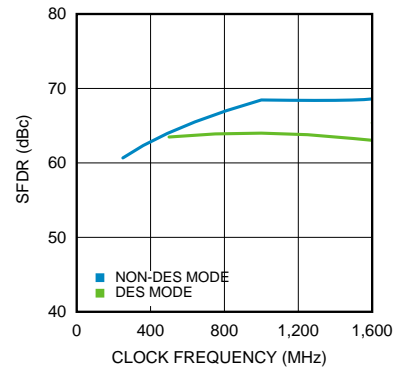

**Figure 48. SFDR vs Clock Frequency (ADC12D1600)**

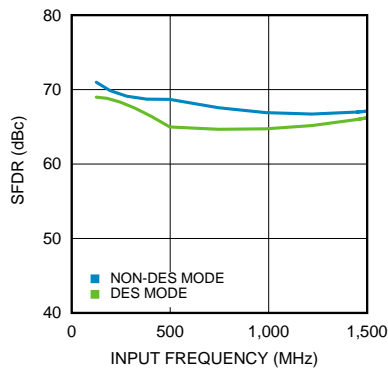

**Figure 49. SFDR vs Input Frequency (ADC12D1000)**

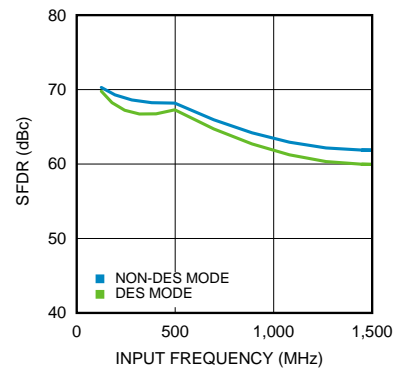

**Figure 50. SFDR vs Input Frequency (ADC12D1600)**

Typical Characteristics (continued)

$V_A = V_{DR} = V_{TC} = V_E = 1.9\text{ V}$ ,  $f_{CLK} = 1.0/1.6\text{ GHz}$ ,  $f_{IN} = 498\text{ MHz}$ ,  $T_A = 25^\circ\text{C}$ , I-channel, 1:2 Demux Non-DES Mode (1:1 Demux Non-DES Mode has similar performance), unless otherwise stated. For NPR plots, notch width = 25 MHz,  $f_c = 320\text{ MHz}$ .

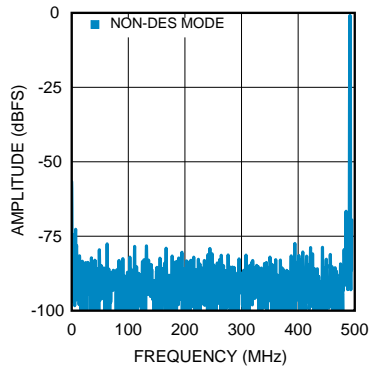

Figure 51. Spectral Response at  $f_{IN} = 498\text{ MHz}$  (ADC12D1000)

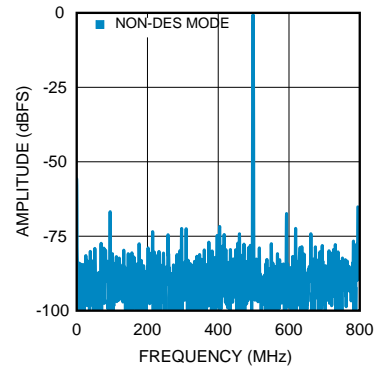

Figure 52. Spectral Response at  $f_{IN} = 498\text{ MHz}$  (ADC12D1600)

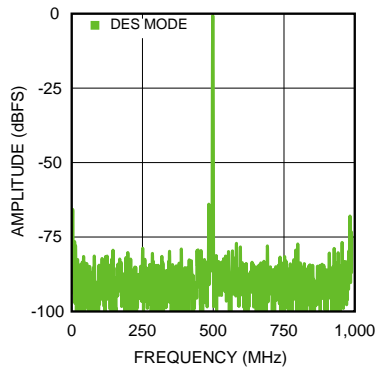

Figure 53. Spectral Response at  $f_{IN} = 498\text{ MHz}$  (ADC12D1000)

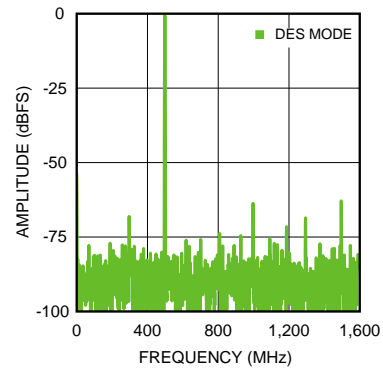

Figure 54. Spectral Response at  $f_{IN} = 498\text{ MHz}$  (ADC12D1600)

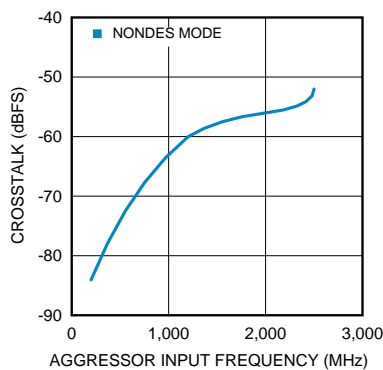

Figure 55. Crosstalk vs Source Frequency (ADC12D1000)

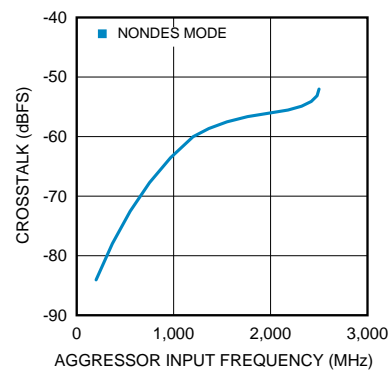

Figure 56. Crosstalk vs Source Frequency (ADC12D1600)

Typical Characteristics (continued)

$V_A = V_{DR} = V_{TC} = V_E = 1.9\text{ V}$ ,  $f_{CLK} = 1.0/1.6\text{ GHz}$ ,  $f_{IN} = 498\text{ MHz}$ ,  $T_A = 25^\circ\text{C}$ , I-channel, 1:2 Demux Non-DES Mode (1:1 Demux Non-DES Mode has similar performance), unless otherwise stated. For NPR plots, notch width = 25 MHz,  $f_c = 320\text{ MHz}$ .

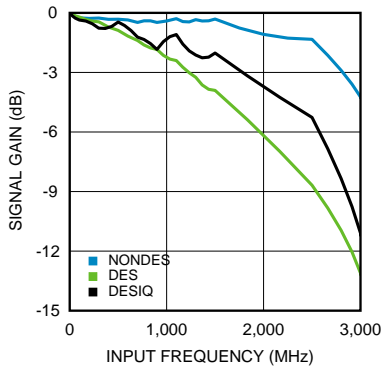

Figure 57. Full Power Bandwidth (ADC12D1000)

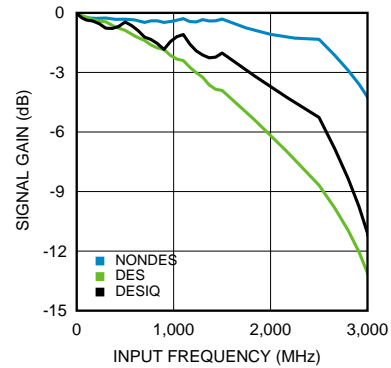

Figure 58. Full Power Bandwidth (ADC12D1600)

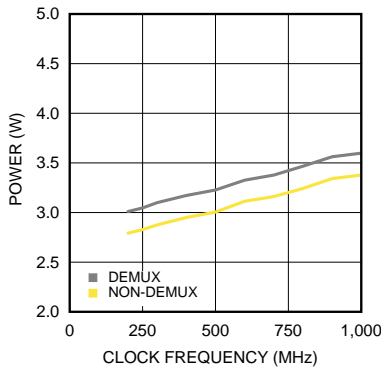

Figure 59. Power Consumption vs Clock Frequency (ADC12D1000)

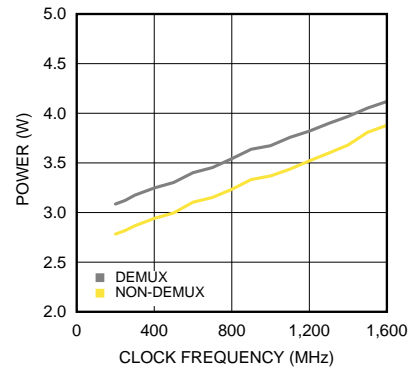

Figure 60. Power Consumption vs Clock Frequency (ADC12D1600)

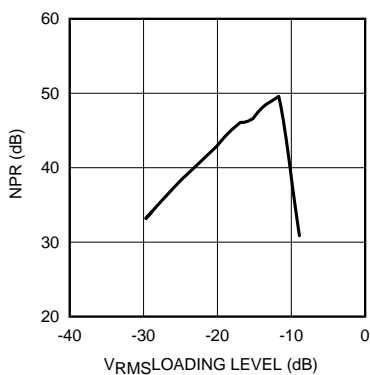

Figure 61. NPR vs RMS Noise Loading Level (ADC12D1000)

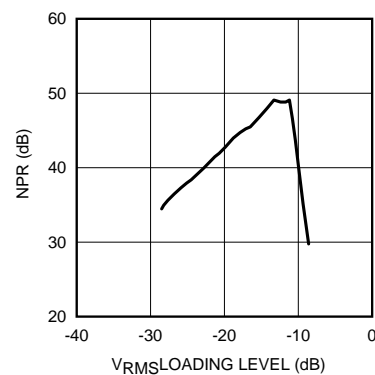

Figure 62. NPR vs RMS Noise Loading Level (ADC12D1600)

## 7 Detailed Description

### 7.1 Overview

The ADC12D1x00 is a versatile A/D converter with an innovative architecture, which permits very high-speed operation. The controls available ease the application of the device to circuit solutions. Optimum performance requires adherence to the provisions discussed here and in [Application Information](#). This section covers an overview, a description of control modes (Extended Control Mode and Non-Extended Control Mode), and features.

The ADC12D1x00 uses a calibrated folding and interpolating architecture that achieves a high Effective Number of Bits (ENOB). The use of folding amplifiers greatly reduces the number of comparators and power consumption. Interpolation reduces the number of front-end amplifiers required, minimizing the load on the input signal and further reducing power requirements. In addition to correcting other non-idealities, on-chip calibration reduces the INL bow often seen with folding architectures. The result is an extremely fast, high-performance, low-power converter.

The analog input signal (which is within the converter's input voltage range) is digitized to twelve bits at speeds of 150/150 MSPS to 2.0/3.2 GSPS, typical. Differential input voltages below negative full-scale will cause the output word to consist of all zeroes. Differential input voltages above positive full-scale will cause the output word to consist of all ones. Either of these conditions at the I- or Q-input will cause the Out-of-Range I-channel or Q-channel output (ORI or ORQ), respectively, to output a logic-high signal.

In ECM, an expanded feature set is available through the Serial Interface. The ADC12D1x00 builds upon previous architectures, introducing a new DES Mode timing adjust feature, AutoSync feature for multi-chip synchronization and increasing to 15-bit for gain and 12-bit plus sign for offset the independent programmable adjustment for each channel.

Each channel has a selectable output demultiplexer which feeds two LVDS buses. If the 1:2 Demux Mode is selected, the output data rate is reduced to half the input sample rate on each bus. When Non-Demux Mode is selected, the output data rate on each channel is at the same rate as the input sample clock and only one 12-bit bus per channel is active.

### 7.2 Functional Block Diagram

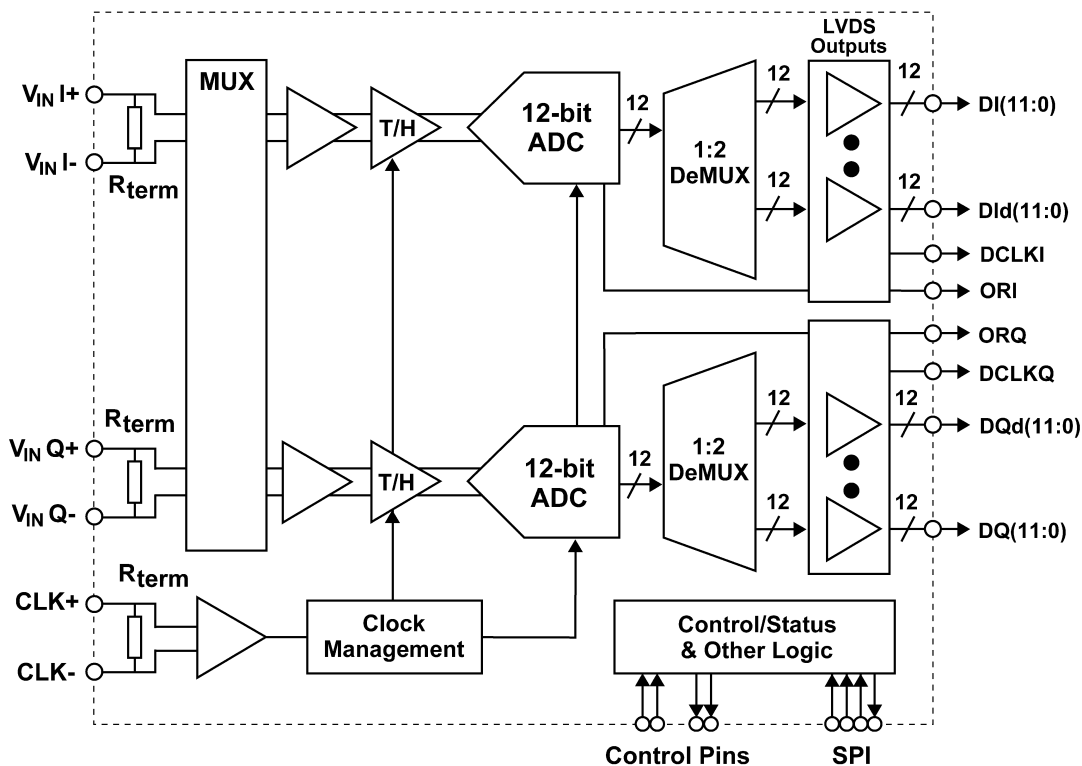



### 7.3 Feature Description

The ADC12D1x00 offers many features to make the device convenient to use in a wide variety of applications. [Table 1](#) is a summary of the features available, as well as details for the control mode chosen. "N/A" means "Not Applicable."

**Table 1. Features and Modes**

FEATURE	NON-ECM	CONTROL PIN ACTIVE IN ECM	ECM	DEFAULT ECM STATE
<b>INPUT CONTROL AND ADJUST</b>				
AC-DC-coupled Mode Selection	Selected through $V_{CMO}$ (Pin C2)	Yes	Not available	N/A
Input Full-scale Range Adjust	Selected through FSR (Pin Y3)	No	Selected through the Config Reg (Addr: 3h and Bh)	Mid FSR value
Input Offset Adjust Setting	Not available	N/A	Selected through the Config Reg (Addr: 2h and Ah)	Offset = 0 mV
DES/Non-DES Mode Selection	Selected through DES (Pin V5)	No	Selected through the DES Bit (Addr: 0h; Bit: 7)	Non-DES Mode
DES Timing Adjust	Not available	N/A	Selected through the DES Timing Adjust Reg (Addr: 7h)	Mid skew offset
Sampling Clock Phase Adjust	Not available	N/A	Selected through the Config Reg (Addr: Ch and Dh)	$t_{AD}$ adjust disabled
<b>OUTPUT CONTROL AND ADJUST</b>				
DDR Clock Phase Selection	Selected through DDRPh (Pin W4)	No	Selected through the DPS Bit (Addr: 0h; Bit: 14)	0° Mode
LVDS Differential Voltage Amplitude Selection	Higher amplitude only	N/A	Selected through the OVS Bit (Addr: 0h; Bit: 13)	Higher amplitude
LVDS Common-Mode Voltage Amplitude Selection	Selected through $V_{BG}$ (Pin B1)	Yes	Not available	N/A
Output Formatting Selection	Offset Binary only	N/A	Selected through the 2SC Bit (Addr: 0h; Bit: 4)	Offset Binary
Test Pattern Mode at Output	Selected through TPM (Pin A4)	No	Selected through the TPM Bit (Addr: 0h; Bit: 12)	TPM disabled
Demux/Non-Demux Mode Selection	Selected through NDM (Pin A5)	Yes	Not available	N/A
AutoSync	Not available	N/A	Selected through the Config Reg (Addr: Eh)	Master Mode, RCOut1/2 disabled
DCLK Reset	Not available	N/A	Selected through the Config Reg (Addr: Eh; Bit: 0)	DCLK Reset disabled
Time Stamp	Not available	N/A	Selected through the TSE Bit (Addr: 0h; Bit: 3)	Time Stamp disabled
<b>CALIBRATION</b>				
On-command Calibration	Selected through CAL (Pin D6)	Yes	Selected through the CAL Bit (Addr: 0h; Bit: 15)	N/A (CAL = 0)
Power-on Calibration Delay Selection	Selected through CalDly (Pin V4)	Yes	Not available	N/A
Calibration Adjust	Not available	N/A	Selected through the Config Reg (Addr: 4h)	$t_{CAL}$
Read/Write Calibration Settings	Not available	N/A	Selected through the SSC Bit (Addr: 4h; Bit: 7)	R/W calibration values disabled

**Feature Description (continued)**
**Table 1. Features and Modes (continued)**

FEATURE	NON-ECM	CONTROL PIN ACTIVE IN ECM	ECM	DEFAULT ECM STATE
<b>POWER-DOWN</b>				
Power-down I-channel	Selected through PDI (Pin U3)	Yes	Selected through the PDI Bit (Addr: 0h; Bit: 11)	I-channel operational
Power-down Q-channel	Selected through PDQ (Pin V3)	Yes	Selected through the PDQ Bit (Addr: 0h; Bit: 10)	Q-channel operational

**7.3.1 Input Control and Adjust**

There are several features and configurations for the input of the ADC12D1x00 so that it may be used in many different applications. This section covers AC-DC-coupled Mode, input full-scale range adjust, input offset adjust, DES/Non-DES Mode, and sampling clock phase adjust.

**7.3.1.1 AC-DC-Coupled Mode**

The analog inputs may be AC or DC-coupled. See [AC-DC-Coupled Mode Pin \( \$V\_{CMO}\$ \)](#) for information on how to select the desired mode and [DC-Coupled Input Signals](#) and [AC-Coupled Input Signals](#) for applications information.

**7.3.1.2 Input Full-Scale Range Adjust**

The input full-scale range for the ADC12D1x00 may be adjusted through Non-ECM or ECM. In Non-ECM, a control pin selects a higher or lower value; see [Full-Scale Input Range Pin \(FSR\)](#). In ECM, the input full-scale range may be adjusted with 15-bits of precision. See  $V_{IN\_FSR}$  in [Electrical Characteristics: Analog Input/Output and Reference](#) for electrical specification details. The higher and lower full-scale input range settings in Non-ECM correspond to the mid and min full-scale input range settings in ECM. It is necessary to execute an on-command calibration following a change of the input full-scale range. See [Register Maps](#) for information about the registers.

**7.3.1.3 Input Offset Adjust**

The input offset adjust for the ADC12D1x00 may be adjusted with 12-bits of precision plus sign through ECM. See [Register Maps](#) for information about the registers.

**7.3.1.4 DES Timing Adjust**

The performance of the ADC12D1x00 in DES Mode depends on how well the two channels are interleaved, that is, that the clock samples either channel with precisely a 50% duty-cycle, each channel has the same offset (nominally code 2047/2048), and each channel has the same full-scale range. The ADC12D1x00 includes an automatic clock phase background adjustment in DES Mode to automatically and continuously adjust the clock phase of the I- and Q-channels. In addition to this, the residual fixed timing skew offset may be further manually adjusted, and further reduce timing spurs for specific applications. See the DES Timing Adjust (Addr: 7h). As the DES Timing Adjust is programmed from 0d to 127d, the magnitude of the  $F_s/2$ -Fin timing interleaving spur will decrease to a local minimum and then increase again. The default, nominal setting of 64d may or may not coincide with this local minimum. The user may manually skew the global timing to achieve the lowest possible timing interleaving spur.

**7.3.1.5 Sampling Clock Phase Adjust**

The sampling clock (CLK) phase may be delayed internally to the ADC up to 825 ps in ECM. This feature is intended to help the system designer remove small imbalances in clock distribution traces at the board level when multiple ADCs are used, or to simplify complex system functions such as beam steering for phase array antennas.

Additional delay in the clock path also creates additional jitter when using the sampling clock phase adjust. Because the sampling clock phase adjust delays all clocks, including the DCLKs and output data, the user is strongly advised to use the minimal amount of adjustment and verify the net benefit of this feature in his system before relying on it.

### 7.3.2 Output Control and Adjust

There are several features and configurations for the output of the ADC12D1x00 so that it may be used in many different applications. This section covers DDR clock phase, LVDS output differential and common-mode voltage, output formatting, Demux/Non-demux Mode, Test Pattern Mode, and Time Stamp.

#### 7.3.2.1 DDR Clock Phase

The ADC12D1x00 output data is always delivered in Double Data Rate (DDR). With DDR, the DCLK frequency is half the data rate and data is sent to the outputs on both edges of DCLK; see [Figure 63](#). The DCLK-to-Data phase relationship may be either 0° or 90°. For 0° Mode, the Data transitions on each edge of the DCLK. Any offset from this timing is  $t_{OSK}$ ; see [Electrical Characteristics: AC](#) for details. For 90° Mode, the DCLK transitions in the middle of each Data cell. Setup and hold times for this transition,  $t_{SU}$  and  $t_H$ , may also be found in [Electrical Characteristics: AC](#). The DCLK-to-Data phase relationship may be selected through the DDRPh Pin in Non-ECM (see [Dual Data Rate Phase Pin \(DDRPH\)](#)) or the DPS bit in the Configuration Register (Addr: 0h; Bit: 14) in ECM.

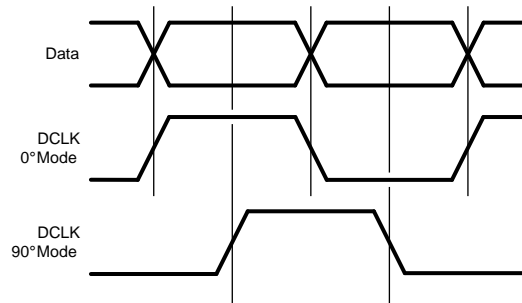

**Figure 63. DDR DCLK-to-Data Phase Relationship**

#### 7.3.2.2 LVDS Output Differential Voltage

The ADC12D1x00 is available with a selectable higher or lower LVDS output differential voltage. This parameter is  $V_{OD}$  and may be found in [Electrical Characteristics: Digital Control and Output Pin](#). The desired voltage may be selected through the OVS Bit (Addr: 0h, Bit 13). For many applications, in which the LVDS outputs are very close to an FPGA on the same board, for example, the lower setting is sufficient for good performance; this will also reduce the possibility for EMI from the LVDS outputs to other signals on the board. See [Register Maps](#) for more information.

#### 7.3.2.3 LVDS Output Common-Mode Voltage

The ADC12D1x00 is available with a selectable higher or lower LVDS output common-mode voltage. This parameter is  $V_{OS}$  and may be found in [Electrical Characteristics: Digital Control and Output Pin](#). See [LVDS Output Common-Mode Pin \( \$V\_{BG}\$ \)](#) for information on how to select the desired voltage.

#### 7.3.2.4 Output Formatting

The formatting at the digital data outputs may be either offset binary or two's complement. The default formatting is offset binary, but two's complement may be selected through the 2SC Bit (Addr: 0h, Bit 4); see [Register Maps](#) for more information.

### 7.3.2.5 Test Pattern Mode

The ADC12D1x00 can provide a test pattern at the four output buses independently of the input signal to aid in system debug. In Test Pattern Mode, the ADC is disengaged and a test pattern generator is connected to the outputs, including ORI and ORQ. The test pattern output is the same in DES Mode or Non-DES Mode. Each port is given a unique 12-bit word, alternating between 1's and 0's. When the part is programmed into the Demux Mode, the test pattern's order is described in [Table 2](#). If the I- or Q-channel is powered down, the test pattern will not be output for that channel.

**Table 2. Test Pattern By Output Port In Demux Mode**

TIME	Qd	Id	Q	I	ORQ	ORI	COMMENTS
T0	000h	004h	008h	010h	0b	0b	Pattern Sequence n
T1	FFFh	FFBh	FF7h	FEFh	1b	1b	
T2	000h	004h	008h	010h	0b	0b	
T3	FFFh	FFBh	FF7h	FEFh	1b	1b	
T4	000h	004h	008h	010h	0b	0b	Pattern Sequence n+1
T5	000h	004h	008h	010h	0b	0b	
T6	FFFh	FFBh	FF7h	FEFh	1b	1b	
T7	000h	004h	008h	010h	0b	0b	
T8	FFFh	FFBh	FF7h	FEFh	1b	1b	Pattern Sequence n+2
T9	000h	004h	008h	010h	0b	0b	
T10	000h	004h	008h	010h	0b	0b	
T11	FFFh	FFBh	FF7h	FEFh	1b	1b	
T12	000h	004h	008h	010h	0b	0b	Pattern Sequence n+2
T13	...	...	...	...	...	...	

When the part is programmed into the Non-Demux Mode, the test pattern's order is described in [Table 3](#).

**Table 3. Test Pattern By Output Port In Non-Demux Mode**

TIME	Q	I	ORQ	ORI	COMMENTS
T0	000h	004h	0b	0b	Pattern Sequence n
T1	000h	004h	0b	0b	
T2	FFFh	FFBh	1b	1b	
T3	FFFh	FFBh	1b	1b	
T4	000h	004h	0b	0b	
T5	FFFh	FFBh	1b	1b	
T6	000h	004h	0b	0b	
T7	FFFh	FFBh	1b	1b	
T8	FFFh	FFBh	1b	1b	
T9	FFFh	FFBh	1b	1b	
T10	000h	004h	0b	0b	Pattern Sequence n+1
T11	000h	004h	0b	0b	
T12	FFFh	FFBh	1b	1b	
T13	FFFh	FFBh	1b	1b	
T14	...	...	...	...	

### 7.3.2.6 Time Stamp

The Time Stamp feature enables the user to capture the timing of an external trigger event, relative to the sampled signal. When enabled through the TSE Bit (Addr: 0h; Bit: 3), the LSB of the digital outputs (DQd, DQ, DI, DI) captures the trigger information. In effect, the 12-bit converter becomes an 11-bit converter and the LSB acts as a 1-bit converter with the same latency as the 11-bit converter. The trigger should be applied to the DCLK\_RST input. It may be asynchronous to the ADC sampling clock.

### 7.3.3 Calibration Feature

The ADC12D1x00 calibration must be run to achieve specified performance. The calibration procedure is exactly the same regardless of how it was initiated or when it is run. Calibration trims the analog input differential termination resistors, the CLK input resistor, and sets internal bias currents which affect the linearity of the converter. This minimizes full-scale error, offset error, DNL and INL, which results in the maximum dynamic performance, as measured by: SNR, THD, SINAD (SNDR) and ENOB.

#### 7.3.3.1 Calibration Control Pins and Bits

Table 4 is a summary of the pins and bits used for calibration. See [Pin Configuration and Functions](#) for complete pin information and [Figure 6](#) for the timing diagram.

**Table 4. Calibration Pins**

PIN (BIT)	NAME	FUNCTION
D6 (Addr: 0h; Bit 15)	CAL (Calibration)	Initiate calibration
V4  (Addr: 4h)	CalDly (Calibration Delay)  Calibration Adjust	Select power-on calibration delay  Adjust calibration sequence
B5	CalRun (Calibration Running)	Indicates while calibration is running
C1/D2	Rtrim+/- (Input termination trim resistor)	External resistor used to calibrate analog and CLK inputs
C3/D3	Rext+/- (External Reference resistor)	External resistor used to calibrate internal linearity

#### 7.3.3.2 How to Execute a Calibration

Calibration may be initiated by holding the CAL pin low for at least  $t_{CAL\_L}$  clock cycles, and then holding it high for at least another  $t_{CAL\_H}$  clock cycles, as defined in [Timing Requirements: Calibration](#). The minimum  $t_{CAL\_L}$  and  $t_{CAL\_H}$  input clock cycle sequences are required to ensure that random noise does not cause a calibration to begin when it is not desired. The time taken by the calibration procedure is specified as  $t_{CAL}$ . The CAL Pin is active in both ECM and Non-ECM. However, in ECM, the CAL Pin is logically OR'd with the CAL Bit, so both the pin and bit are required to be set low before executing another calibration through either pin or bit.

#### 7.3.3.3 Power-On Calibration

For standard operation, power-on calibration begins after a time delay following the application of power, as determined by the setting of the CalDly Pin and measured by  $t_{CalDly}$  (see [Timing Requirements: Calibration](#)). This delay allows the power supply to come up and stabilize before the power-on calibration takes place. The best setting (short or long) of the CalDly Pin depends upon the settling time of the power supply.

TI strongly recommends setting CalDly Pin (to either logic-high or logic-low) before powering the device on because this pin affects the power-on calibration timing. This may be accomplished by setting CalDly through an external 1-k $\Omega$  resistor connected to GND or  $V_A$ . If the CalDly Pin is toggled while the device is powered on, it can execute a calibration even though the CAL Pin/Bit remains logic-low.

The power-on calibration will not be performed if the CAL pin is logic-high at power-on. In this case, the calibration cycle will not begin until the on-command calibration conditions are met. The ADC12D1x00 will function with the CAL pin held high at power up, but no calibration will be done and performance will be impaired.

If it is necessary to toggle the CalDly Pin before the system power-up sequence, then the CAL Pin/Bit must be set to logic-high during the toggling and afterwards for  $10^9$  Sampling Clock cycles. This will prevent the power-on calibration, so an on-command calibration must be executed or the performance will be impaired.

### 7.3.3.4 On-Command Calibration

In addition to the power-on calibration, TI recommends executing an on-command calibration whenever the settings or conditions to the device are altered significantly, to obtain optimal parametric performance. Some examples include: changing the FSR through either ECM or Non-ECM, power-cycling either channel, and switching into or out of DES Mode. For best performance, it is also recommended that an on-command calibration be run 20 seconds or more after application of power and whenever the operating temperature changes significantly, relative to the specific system performance requirements.

Due to the nature of the calibration feature, TI recommends avoiding unnecessary activities on the device while the calibration is taking place. For example, do not read or write to the Serial Interface or use the DCLK Reset feature while calibrating the ADC. Doing so will impair the performance of the device until it is re-calibrated correctly. Also, TI recommends not applying a strong narrow-band signal to the analog inputs during calibration because this may impair the accuracy of the calibration; broad spectrum noise is acceptable.

### 7.3.3.5 Calibration Adjust

The sequence of the calibration event itself may be adjusted. This feature can be used if a shorter calibration time than the default is required; see  $t_{CAL}$  in [Timing Requirements: Calibration](#). However, the performance of the device, when using this feature is not ensured.

The calibration sequence may be adjusted through CSS (Addr: 4h, Bit 14). The default setting of CSS = 1b executes both  $R_{IN}$  and  $R_{IN\_CLK}$  Calibration (using Rtrim) and internal linearity Calibration (using Rext). Executing a calibration with CSS = 0b executes only the internal linearity Calibration. The first time that Calibration is executed, it must be with CSS = 1b to trim  $R_{IN}$  and  $R_{IN\_CLK}$ . However, once the device is at its operating temperature and  $R_{IN}$  has been trimmed at least one time, it will not drift significantly. To save time in subsequent calibrations, trimming  $R_{IN}$  and  $R_{IN\_CLK}$  may be skipped, that is, by setting CSS = 0b.

### 7.3.3.6 Read/Write Calibration Settings

When the ADC performs a calibration, the calibration constants are stored in an array which is accessible through the Calibration Values register (Addr: 5h). To save the time which it takes to execute a calibration,  $t_{CAL}$ , or to allow re-use of a previous calibration result, these values can be read from and written to the register at a later time. For example, if an application requires the same input impedance,  $R_{IN}$ , this feature can be used to load a previously determined set of values. For the calibration values to be valid, the ADC must be operating under the same conditions, including temperature, at which the calibration values were originally determined by the ADC.

To read calibration values from the SPI, do the following:

1. Set ADC to desired operating conditions.
2. Set SSC (Addr: 4h, Bit 7) to 1.
3. Read exactly 240 times the Calibration Values register (Addr: 5h). The register values are R0, R1, R2... R239 where R0 is a dummy value. The contents of R<239:1> should be stored.
4. Set SSC (Addr: 4h, Bit 7) to 0.
5. Continue with normal operation.

To write calibration values to the SPI, do the following:

1. Set ADC to operating conditions at which Calibration Values were previously read.
2. Set SSC (Addr: 4h, Bit 7) to 1.
3. Write exactly 239 times the Calibration Values register (Addr: 5h). The registers should be written with stored register values R1, R2... R239.
4. Make two additional dummy writes of 0000h.
5. Set SSC (Addr: 4h, Bit 7) to 0.
6. Continue with normal operation.



### 7.3.3.7 Calibration and Power-Down

If PDI and PDQ are simultaneously asserted during a calibration cycle, the ADC12D1x00 will immediately power down. The calibration cycle will continue when either or both channels are powered back up, but the calibration will be compromised due to the incomplete settling of bias currents directly after power up. Therefore, a new calibration should be executed upon powering the ADC12D1x00 back up. In general, the ADC12D1x00 should be recalibrated when either or both channels are powered back up, or after one channel is powered down. For best results, this should be done after the device has stabilized to its operating temperature.

### 7.3.3.8 Calibration and the Digital Outputs

During calibration, the digital outputs (including DI, DI<sub>d</sub>, DQ, DQ<sub>d</sub> and OR) are set logic-low, to reduce noise. The DCLK runs continuously during calibration. After the calibration is completed and the CalRun signal is logic-low, it takes an additional 60 Sampling Clock cycles before the output of the ADC12D1x00 is valid converted data from the analog inputs. This is the time it takes for the pipeline to flush, as well as for other internal processes.

### 7.3.4 Power Down

On the ADC12D1x00, the I- and Q-channels may be powered down individually. This may be accomplished through the control pins, PDI and PDQ, or through ECM. In ECM, the PDI and PDQ pins are logically OR'd with the Control Register setting. See [Power-Down I-Channel Pin \(PDI\)](#) and [Power-Down Q-Channel Pin \(PDQ\)](#) for more information.

## 7.4 Device Functional Modes

### 7.4.1 DES/Non-DES Mode

The ADC12D1x00 can operate in Dual-Edge Sampling (DES) or Non-DES Mode. The DES Mode allows for a single analog input to be sampled by both I- and Q-channels. One channel samples the input on the rising edge of the sampling clock and the other samples the same input signal on the falling edge of the sampling clock. A single input is thus sampled twice per clock cycle, resulting in an overall sample rate of twice the sampling clock frequency, for example, 2.0/3.2 GSPS with a 1.0/1.6 GHz sampling clock. Because DES Mode uses both I- and Q-channels to process the input signal, both channels must be powered up for the DES Mode to function properly.

In Non-ECM, only the I-input may be used for the DES Mode input. See [Dual Edge Sampling Pin \(DES\)](#) for information on how to select the DES Mode. In ECM, either the I- or Q-input may be selected by first using the DES bit (Addr: 0h, Bit 7) to select the DES Mode. The DEQ Bit (Addr: 0h, Bit: 6) is used to select the Q-input, but the I-input is used by default. Also, both I- and Q-inputs may be driven externally, that is, DESIQ Mode, by using the DIQ bit (Addr: 0h, Bit 5). See [Driving the ADC in DES Mode](#) for more information about how to drive the ADC in DES Mode.

The DESIQ Mode results in the best DES Mode bandwidth. In general, the bandwidth decreases from Non-DES Mode to DES Mode (specifically, DESI or DESQ) because both channels are sampling off the same input signal and non-ideal effects introduced by interleaving the two channels lower the bandwidth. Driving both I- and Q-channels externally (DESIQ Mode) results in better bandwidth for the DES Mode because each channel is being driven, which reduces routing losses.

In the DES Mode, the outputs must be carefully interleaved to reconstruct the sampled signal. If the device is programmed into the 1:4 Demux DES Mode, the data is effectively demultiplexed by 1:4. If the sampling clock is 1.0/1.6 GHz, the effective sampling rate is doubled to 2.0/3.2 GSPS and each of the 4 output buses has an output rate of 500/800 MSPS. All data is available in parallel. To properly reconstruct the sampled waveform, the four bytes of parallel data that are output with each DCLK must be correctly interleaved. The sampling order is as follows, from the earliest to the latest: DQ<sub>d</sub>, DI<sub>d</sub>, DQ, DI. See [Figure 3](#). If the device is programmed into the Non-Demux DES Mode, two bytes of parallel data are output with each edge of the DCLK in the following sampling order, from the earliest to the latest: DQ, DI. See [Figure 4](#).

## Device Functional Modes (continued)

### 7.4.2 Demux/Non-Demux Mode

The ADC12D1x00 may be in one of two demultiplex modes: Demux Mode or Non-Demux Mode (also sometimes referred to as 1:1 Demux Mode). In Non-Demux Mode, the data from the input is simply output at the sampling rate on one 12-bit bus. In Demux Mode, the data from the input is output at half the sampling rate, on twice the number of buses. Demux/Non-Demux Mode may only be selected by the NDM pin. In Non-DES Mode, the output data from each channel may be demultiplexed by a factor of 1:2 (1:2 Demux Non-DES Mode) or not demultiplexed (Non-Demux Non-DES Mode). In DES Mode, the output data from both channels interleaved may be demultiplexed (1:4 Demux DES Mode) or not demultiplexed (Non-Demux DES Mode).

## 7.5 Programming

### 7.5.1 Control Modes

The ADC12D1x00 may be operated in one of two control modes: Non-extended Control Mode (Non-ECM) or Extended Control Mode (ECM). In the simpler Non-ECM (also sometimes referred to as Pin Control Mode), the user affects available configuration and control of the device through the control pins. The ECM provides additional configuration and control options through a serial interface and a set of 16 registers, most of which are available to the customer.

#### 7.5.1.1 Non-Extended Control Mode

In Non-extended Control Mode (Non-ECM), the Serial Interface is not active and all available functions are controlled through various pin settings. Non-ECM is selected by setting the ECE Pin to logic-high. For the control pins, "logic-high" and "logic-low" refer to  $V_A$  and GND, respectively. Nine dedicated control pins provide a wide range of control for the ADC12D1x00 and facilitate its operation. These control pins provide DES Mode selection, Demux Mode selection, DDR Phase selection, execute Calibration, Calibration Delay setting, Power-down I-channel, Power-down Q-channel, Test Pattern Mode selection, and Full-Scale Input Range selection. In addition to this, two dual-purpose control pins provide for AC-DC-coupled Mode selection and LVDS output common-mode voltage selection. See [Table 5](#) for a summary.

**Table 5. Non-ECM Pin Summary**

PIN NAME	LOGIC-LOW	LOGIC-HIGH	FLOATING
<b>DEDICATED CONTROL PINS</b>			
DES	Non-DES Mode	DES Mode	Not valid
NDM	Demux Mode	Non-Demux Mode	Not valid
DDRPh	0° Mode	90° Mode	Not valid
CAL	See <a href="#">Calibration Pin (CAL)</a>		Not valid
CalDly	Shorter delay	Longer delay	Not valid
PDI	I-channel active	Power Down I-channel	Power Down I-channel
PDQ	Q-channel active	Power Down Q-channel	Power Down Q-channel
TPM	Non-Test Pattern Mode	Test Pattern Mode	Not valid
FSR	Lower FS input Range	Higher FS input Range	Not valid
<b>DUAL-PURPOSE CONTROL PINS</b>			
$V_{CMO}$	AC-coupled operation	Not allowed	DC-coupled operation
$V_{BG}$	Not allowed	Higher LVDS common-mode voltage	Lower LVDS common-mode voltage



#### 7.5.1.1.1 Dual Edge Sampling Pin (DES)

The Dual Edge Sampling (DES) Pin selects whether the ADC12D1x00 is in DES Mode (logic-high) or Non-DES Mode (logic-low). DES Mode means that a single analog input is sampled by both I- and Q-channels in a time-interleaved manner. One of the ADCs samples the input signal on the rising sampling clock edge (duty cycle corrected); the other ADC samples the input signal on the falling sampling clock edge (duty cycle corrected). In Non-ECM, only the I-input may be used for DES Mode, a.k.a. DESI Mode. In ECM, the Q-input may be selected through the DEQ Bit (Addr: 0h, Bit: 6), a.k.a. DESQ Mode. In ECM, both the I- and Q-inputs may be selected, a.k.a. DESIQ Mode.

To use this feature in ECM, use the DES bit in the Configuration Register (Addr: 0h; Bit: 7). See [DES/Non-DES Mode](#) for more information.

#### 7.5.1.1.2 Non-Demultiplexed Mode Pin (NDM)

The Non-Demultiplexed Mode (NDM) Pin selects whether the ADC12D1x00 is in Demux Mode (logic-low) or Non-Demux Mode (logic-high). In Non-Demux Mode, the data from the input is produced at the sampled rate at a single 12-bit output bus. In Demux Mode, the data from the input is produced at half the sampled rate at twice the number of output buses. For Non-DES Mode, each I- or Q-channel will produce its data on one or two buses for Non-Demux or Demux Mode, respectively. For DES Mode, the selected channel will produce its data on two or four buses for Non-Demux or Demux Mode, respectively.

This feature is pin-controlled only and remains active during both Non-ECM and ECM. See [Demux/Non-Demux Mode](#) for more information.

#### 7.5.1.1.3 Dual Data Rate Phase Pin (DDRPH)

The Dual Data Rate Phase (DDRPh) Pin selects whether the ADC12D1x00 is in 0° Mode (logic-low) or 90° Mode (logic-high). The Data is always produced in DDR Mode on the ADC12D1x00. The Data may transition either with the DCLK transition (0° Mode) or halfway between DCLK transitions (90° Mode). The DDRPh Pin selects 0° Mode or 90° Mode for both the I-channel: DI- and DI<sub>d</sub>-to-DCLKI phase relationship and for the Q-channel: DQ- and DQ<sub>d</sub>-to-DCLKQ phase relationship.

To use this feature in ECM, use the DPS bit in the Configuration Register (Addr: 0h; Bit: 14). See [DDR Clock Phase](#) for more information.

#### 7.5.1.1.4 Calibration Pin (CAL)

The Calibration (CAL) Pin may be used to execute an on-command calibration or to disable the power-on calibration. The effect of calibration is to maximize the dynamic performance. To initiate an on-command calibration through the CAL pin, bring the CAL pin high for a minimum of  $t_{CAL\_H}$  input clock cycles after it has been low for a minimum of  $t_{CAL\_L}$  input clock cycles. Holding the CAL pin high upon power-on will prevent execution of the power-on calibration. In ECM, this pin remains active and is logically OR'd with the CAL bit.

To use this feature in ECM, use the CAL bit in the Configuration Register (Addr: 0h; Bit: 15). See [Calibration Feature](#) for more information.

#### 7.5.1.1.5 Calibration Delay Pin (CALDLY)

The Calibration Delay (CalDly) Pin selects whether a shorter or longer delay time is present, after the application of power, until the start of the power-on calibration. The actual delay time is specified as  $t_{CalDly}$  and may be found in [Timing Requirements: Calibration](#). This feature is pin-controlled only and remains active in ECM. TI recommends selecting the desired delay time before power-on and not dynamically alter this selection.

See [Calibration Feature](#) for more information.

#### 7.5.1.1.6 Power-Down I-Channel Pin (PDI)

The Power-Down I-channel (PDI) Pin selects whether the I-channel is powered down (logic-high) or active (logic-low). The digital data output pins, DI and DI<sub>d</sub>, (both positive and negative) are put into a high impedance state when the I-channel is powered down. Upon return to the active state, the pipeline will contain meaningless information and must be flushed. The supply currents (typicals and limits) are available for the I-channel powered down or active and may be found in [Electrical Characteristics: Power Supply](#). The device should be recalibrated following a power-cycle of PDI (or PDQ).

This pin remains active in ECM. In ECM, either this pin or the PDI bit (Addr: 0h; Bit: 11) in the Control Register may be used to power-down the I-channel. See [Power Down](#) for more information.

#### 7.5.1.1.7 Power-Down Q-Channel Pin (PDQ)

The Power-Down Q-channel (PDQ) Pin selects whether the Q-channel is powered down (logic-high) or active (logic-low). This pin functions similarly to the PDI pin, except that it applies to the Q-channel. The PDI and PDQ pins function independently of each other to control whether each I- or Q-channel is powered down or active.

This pin remains active in ECM. In ECM, either this pin or the PDQ bit (Addr: 0h; Bit: 10) in the Control Register may be used to power-down the Q-channel. See [Power Down](#) for more information.

#### 7.5.1.1.8 Test Pattern Mode Pin (TPM)

The Test Pattern Mode (TPM) Pin selects whether the output of the ADC12D1x00 is a test pattern (logic-high) or the converted analog input (logic-low). The ADC12D1x00 can provide a test pattern at the four output buses independently of the input signal to aid in system debug. In TPM, the ADC is disengaged and a test pattern generator is connected to the outputs, including ORI and ORQ. See [Test Pattern Mode](#) for more information.

#### 7.5.1.1.9 Full-Scale Input Range Pin (FSR)

The Full-Scale Input Range (FSR) Pin selects whether the full-scale input range for both the I- and Q-channel is higher (logic-high) or lower (logic-low). The input full-scale range is specified as  $V_{IN\_FSR}$  in [Electrical Characteristics: Analog Input/Output and Reference](#). In Non-ECM, the full-scale input range for each I- and Q-channel may not be set independently, but it is possible to do so in ECM. The device must be calibrated following a change in FSR to obtain optimal performance.

To use this feature in ECM, use the Configuration Registers (Addr: 3h and Bh). See [Input Control and Adjust](#) for more information.

#### 7.5.1.1.10 AC-DC-Coupled Mode Pin ( $V_{CMO}$ )

The  $V_{CMO}$  Pin serves a dual purpose. When functioning as an output, it provides the optimal common-mode voltage for the DC-coupled analog inputs. When functioning as an input, it selects whether the device is AC-coupled (logic-low) or DC-coupled (floating). This pin is always active, in both ECM and Non-ECM.

#### 7.5.1.1.11 LVDS Output Common-Mode Pin ( $V_{BG}$ )

The  $V_{BG}$  Pin serves a dual purpose. When functioning as an output, it provides the bandgap reference. When functioning as an input, it selects whether the LVDS output common-mode voltage is higher (logic-high) or lower (floating). The LVDS output common-mode voltage is specified as  $V_{OS}$  and may be found in [Electrical Characteristics: Digital Control and Output Pin](#). This pin is always active, in both ECM and Non-ECM.

### 7.5.1.2 Extended Control Mode

In Extended Control Mode (ECM), most functions are controlled through the Serial Interface. In addition to this, several of the control pins remain active. See [Table 1](#) for details. ECM is selected by setting the ECE Pin to logic-low. If the ECE Pin is set to logic-high (Non-ECM), then the registers are reset to their default values. So, a simple way to reset the registers is by toggling the  $\overline{ECE}$  pin. Four pins on the ADC12D1x00 control the Serial Interface:  $\overline{SCS}$ , SCLK, SDI and SDO. This section covers the Serial Interface. The Register Definitions are located at the end of the data sheet so that they are easy to find, see [Register Maps](#).

#### 7.5.1.2.1 The Serial Interface

The ADC12D1x00 offers a Serial Interface that allows access to the sixteen control registers within the device. The Serial Interface is a generic 4-wire (optionally 3-wire) synchronous interface that is compatible with SPI type interfaces that are used on many micro-controllers and DSP controllers. Each serial interface access cycle is exactly 24 bits long. A register-read or register-write can be accomplished in one cycle. The signals are defined in such a way that the user can opt to simply join SDI and SDO signals in his system to accomplish a single, bidirectional SDI/O signal. A summary of the pins for this interface may be found in [Table 6](#). See [Figure 7](#) for the timing diagram and [Timing Requirements: Serial Port Interface](#) for timing specification details. Control register contents are retained when the device is put into power-down mode. If this feature is unused, the SCLK, SDI, and  $\overline{SCS}$  pins may be left floating because they each have an internal pullup.

**Table 6. Serial Interface Pins**

PIN	NAME
C4	$\overline{\text{SCS}}$ (Serial Chip Select bar)
C5	SCLK (Serial Clock)
B4	SDI (Serial Data In)
A3	SDO (Serial Data Out)

**$\overline{\text{SCS}}$ :** Each assertion (logic-low) of this signal starts a new register access, that is, the SDI command field must be ready on the following SCLK rising edge. The user is required to deassert this signal after the 24th clock. If the  $\overline{\text{SCS}}$  is deasserted before the 24th clock, no data read/write will occur. For a read operation, if the  $\overline{\text{SCS}}$  is asserted longer than 24 clocks, the SDO output will hold the D0 bit until  $\overline{\text{SCS}}$  is deasserted. For a write operation, if the  $\overline{\text{SCS}}$  is asserted longer than 24 clocks, data write will occur normally through the SDI input upon the 24th clock. Setup and hold times,  $t_{\text{SCS}}$  and  $t_{\text{HCS}}$ , with respect to the SCLK must be observed.  $\overline{\text{SCS}}$  must be toggled in between register access cycles.

**SCLK:** This signal is used to register the input data (SDI) on the rising edge; and to source the output data (SDO) on the falling edge. The user may disable the clock and hold it at logic-low. There is no minimum frequency requirement for SCLK; see  $f_{\text{SCLK}}$  in *Timing Requirements: Serial Port Interface* for more details.

**SDI:** Each register access requires a specific 24-bit pattern at this input, consisting of a command field and a data field. If the SDI and SDO wires are shared (3-wire mode), then during read operations, it is necessary to tri-state the master which is driving SDI while the data field is being output by the ADC on SDO. The master must be at TRI-STATE before the falling edge of the 8<sup>th</sup> clock. If SDI and SDO are not shared (4-wire mode), then this is not necessary. Setup and hold times,  $t_{\text{SH}}$  and  $t_{\text{SSU}}$ , with respect to the SCLK must be observed.

**SDO:** This output is normally at TRI-STATE and is driven only when  $\overline{\text{SCS}}$  is asserted, the first 8 bits of command data have been received and it is a READ operation. The data is shifted out, MSB first, starting with the 8th clock's falling edge. At the end of the access, when  $\overline{\text{SCS}}$  is deasserted, this output is at TRI-STATE once again. If an invalid address is accessed, the data sourced will consist of all zeroes. If it is a read operation, there will be a bus turnaround time,  $t_{\text{BSU}}$ , from when the last bit of the command field was read in until the first bit of the data field is written out.

Table 7 shows the Serial Interface bit definitions.

**Table 7. Command and Data Field Definitions**

BIT NO.	NAME	COMMENTS
1	Read/Write (R/W)	1b indicates a read operation 0b indicates a write operation
2-3	Reserved	Bits must be set to 10b
4-7	A<3:0>	16 registers may be addressed. The order is MSB first
8	X	This is a "don't care" bit
9-24	D<15:0>	Data written to or read from addressed register

The serial data protocol is shown for a read and write operation in [Figure 64](#) and [Figure 65](#), respectively.

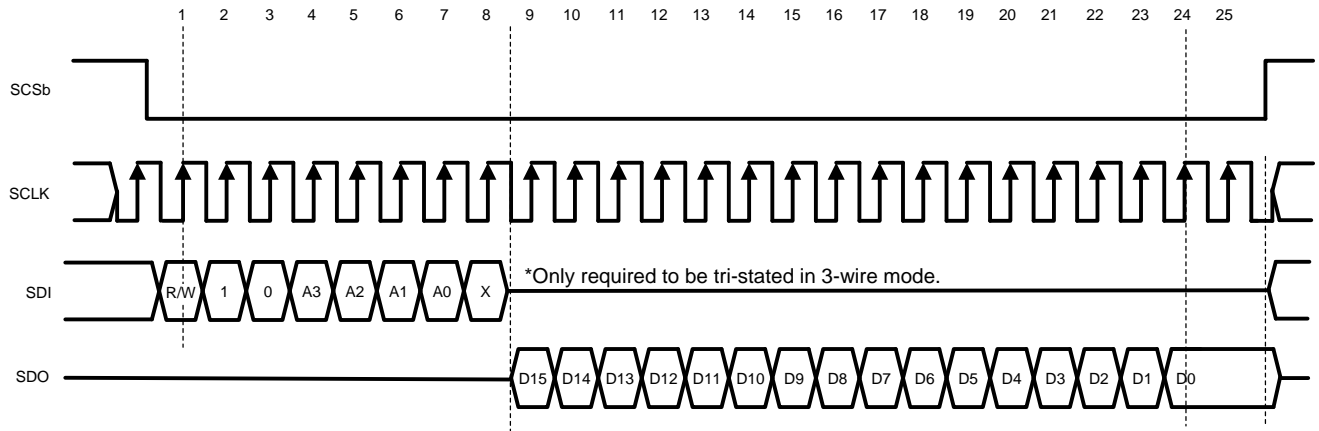

**Figure 64. Serial Data Protocol - Read Operation**

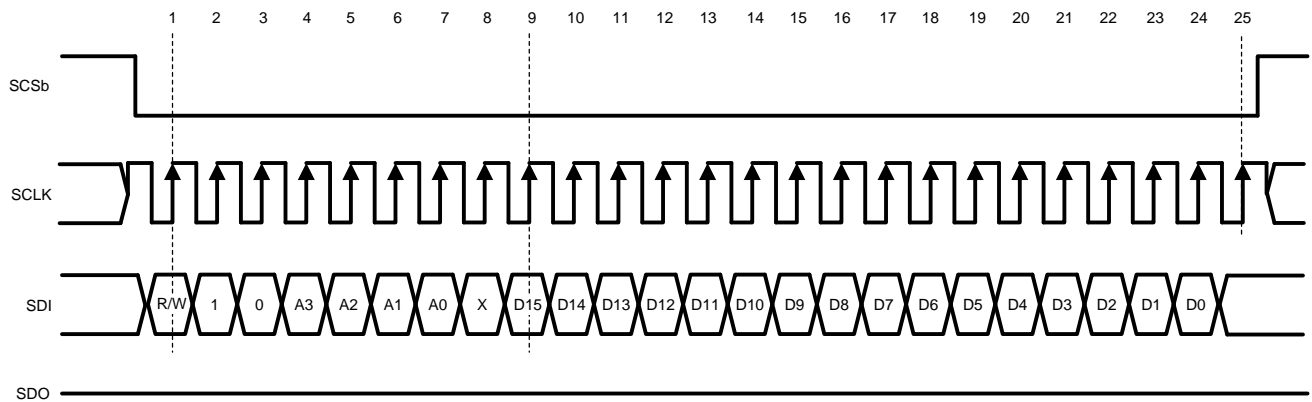

**Figure 65. Serial Data Protocol - Write Operation**

## 7.6 Register Maps

Ten read/write registers provide several control and configuration options in the Extended Control Mode. These registers have no effect when the device is in the Non-extended Control Mode. Each register description below also shows the Power-On Reset (POR) state of each control bit. See [Table 8](#) for a summary. For a description of the functionality and timing to read/write the control registers, see [The Serial Interface](#).

**Table 8. Register Addresses**

A3	A2	A1	A0	Hex	Register Addressed
0	0	0	0	0h	Configuration Register 1
0	0	0	1	1h	Reserved
0	0	1	0	2h	I-channel Offset
0	0	1	1	3h	I-channel Full-Scale Range
0	1	0	0	4h	Calibration Adjust
0	1	0	1	5h	Calibration Values
0	1	1	0	6h	Reserved
0	1	1	1	7h	DES Timing Adjust
1	0	0	0	8h	Reserved
1	0	0	1	9h	Reserved
1	0	1	0	Ah	Q-channel Offset
1	0	1	1	Bh	Q-channel Full-Scale Range
1	1	0	0	Ch	Aperture Delay Coarse Adjust
1	1	0	1	Dh	Aperture Delay Fine Adjust
1	1	1	0	Eh	AutoSync
1	1	1	1	Fh	Reserved

**Table 9. Configuration Register 1**

Addr: 0h (0000b)									POR state: 2000h							
Bit	15	14	13	12	11	10	9	8	7	6	5	4	3	2	1	0
Name	CAL	DPS	OVS	TPM	PDI	PDQ	Res	LFS	DES	DEQ	DIQ	2SC	TSE	Res		
POR	0	0	1	0	0	0	0	0	0	0	0	0	0	0	0	0
Bit 15	CAL: Calibration Enable. When this bit is set to <b>1b</b> , an on-command calibration is initiated. This bit is not reset automatically upon completion of the calibration. Therefore, the user must reset this bit to <b>0b</b> and then set it to <b>1b</b> again to execute another calibration. This bit is logically OR'd with the CAL Pin; both bit and pin must be set to <b>0b</b> before either is used to execute a calibration.															
Bit 14	DPS: DCLK Phase Select. In DDR, set this bit to <b>0b</b> to select the 0° Mode DDR Data-to-DCLK phase relationship and to <b>1b</b> to select the 90° Mode. If the device is in Non-Demux Mode, this bit has no effect; the device will always be in 0°DDR Mode.															
Bit 13	OVS: Output Voltage Select. This bit sets the differential voltage level for the LVDS outputs including Data, OR, and DCLK. <b>0b</b> selects the lower level and <b>1b</b> selects the higher level. See $V_{OD}$ in <a href="#">Electrical Characteristics: Digital Control and Output Pin</a> for details.															
Bit 12	TPM: Test Pattern Mode. When this bit is set to <b>1b</b> , the device will continually output a fixed digital pattern at the digital Data and OR outputs. When set to <b>0b</b> , the device will continually output the converted signal, which was present at the analog inputs. See <a href="#">Test Pattern Mode</a> for details about the TPM pattern.															
Bit 11	PDI: Power-down I-channel. When this bit is set to <b>0b</b> , the I-channel is fully operational; when it is set to <b>1b</b> , the I-channel is powered-down. The I-channel may be powered-down through this bit or the PDI Pin, which is active, even in ECM.															
Bit 10	PDQ: Power-down Q-channel. When this bit is set to <b>0b</b> , the Q-channel is fully operational; when it is set to <b>1b</b> , the Q-channel is powered-down. The Q-channel may be powered-down through this bit or the PDQ Pin, which is active, even in ECM.															
Bit 9	Reserved. Must be set to <b>0b</b> .															
Bit 8	LFS: Low-Frequency Select. If the sampling clock (CLK) is at or below 300 MHz, set this bit to <b>1b</b> for improved performance.															
Bit 7	DES: Dual-Edge Sampling Mode select. When this bit is set to <b>0b</b> , the device will operate in the Non-DES Mode; when it is set to <b>1b</b> , the device will operate in the DES Mode. See <a href="#">DES/Non-DES Mode</a> for more information.															
Bit 6	DEQ: DES Q-input select, a.k.a. DESQ Mode. When the device is in DES Mode, this bit selects the input that the device will operate on. The default setting of <b>0b</b> selects the I-input and <b>1b</b> selects the Q-input.															
Bit 5	DIQ: DES I- and Q-input, a.k.a. DESIQ Mode. When in DES Mode, setting this bit to <b>1b</b> shorts the I- and Q-inputs internally to the device. If the bit is left at its default <b>0b</b> , the I- and Q-inputs remain electrically separate. To operate the device in DESIQ Mode, Bits<7:5> must be set to <b>101b</b> . In this mode, both the I- and Q-inputs must be externally driven; see <a href="#">DES/Non-DES Mode</a> for more information.															
Bit 4	2SC: Two's Complement output. For the default setting of <b>0b</b> , the data is output in Offset Binary format; when set to <b>1b</b> , the data is output in Two's Complement format.															
Bit 3	TSE: Time Stamp Enable. For the default setting of <b>0b</b> , the Time Stamp feature is not enabled; when set to <b>1b</b> , the feature is enabled. See <a href="#">Output Control and Adjust</a> for more information about this feature.															
Bits 2:0	Reserved. Must be set as shown.															

**Table 10. Reserved**

Addr: 1h (0001b)									POR state: 2A0Eh							
Bit	15	14	13	12	11	10	9	8	7	6	5	4	3	2	1	0
Name	Res															
POR	0	0	1	0	1	0	1	0	0	0	0	0	1	1	1	0
Bits 15:0	Reserved. Must be set as shown.															

**Table 11. I-Channel Offset Adjust**

Addr: 2h (0010b)									POR state: 0000h							
Bit	15	14	13	12	11	10	9	8	7	6	5	4	3	2	1	0
Name	Res			OS	OM(11:0)											
POR	0	0	0	0	0	0	0	0	0	0	0	0	0	0	0	0

Bits 15:13	Reserved. Must be set to 0b.	
Bit 12	OS: Offset Sign. The default setting of 0b incurs a positive offset of a magnitude set by Bits 11:0 to the ADC output. Setting this bit to 1b incurs a negative offset of the set magnitude.	
Bits 11:0	OM(11:0): Offset Magnitude. These bits determine the magnitude of the offset set at the ADC output (straight binary coding). The range is from 0 mV for OM(11:0) = 0d to 45 mV for OM(11:0) = 4095d in steps of approximately 11 $\mu$ V. Monotonicity is ensured by design only for the 9 MSBs.	
	Code	Offset [mV]
	0000 0000 0000 (default)	0
	1000 0000 0000	22.5
	1111 1111 1111	45

**Table 12. I-Channel Full Scale Range Adjust**

Addr: 3h (0011b)									POR state: 4000h							
Bit	15	14	13	12	11	10	9	8	7	6	5	4	3	2	1	0
Name	Res	FM(14:0)														
POR	0	1	0	0	0	0	0	0	0	0	0	0	0	0	0	0

Bit 15	Reserved. Must be set to 0b.	
Bits 14:0	FM(14:0): FSR Magnitude. These bits increase the ADC full-scale range magnitude (straight binary coding.) The range is from 600 mV (0d) to 1000 mV (32767d) with the default setting at 800 mV (16384d). Monotonicity is ensured by design only for the 9 MSBs. The mid-range (low) setting in ECM corresponds to the nominal (low) setting in Non-ECM. A greater range of FSR values is available in ECM, that is, FSR values above 800 mV. See $V_{IN\_FSR}$ in <a href="#">Electrical Characteristics: Analog Input/Output and Reference</a> for characterization details.	
	Code	FSR [mV]
	000 0000 0000 0000	600
	100 0000 0000 0000 (default)	800
	111 1111 1111 1111	1000

**Table 13. Calibration Adjust**

Addr: 4h (0100b)									POR state: DF4Bh								
Bit	15	14	13	12	11	10	9	8	7	6	5	4	3	2	1	0	
Name	Res	CSS	Res						SSC	Res							
POR	1	1	0	1	1	1	1	1	0	1	0	0	1	0	1	1	

Bit 15	Reserved. Must be set as shown.	
Bit 14	CSS: Calibration Sequence Select. The default 1b selects the following calibration sequence: reset all previously calibrated elements to nominal values, do $R_{IN}$ Calibration, do internal linearity Calibration. Setting CSS = 0b selects the following calibration sequence: do not reset $R_{IN}$ to its nominal value, skip $R_{IN}$ calibration, do internal linearity Calibration. The calibration must be completed at least one time with CSS = 1b to calibrate $R_{IN}$ . Subsequent calibrations may be run with CSS = 0b (skip $R_{IN}$ calibration) or 1b (full $R_{IN}$ and internal linearity Calibration).	
Bits 13:8	Reserved. Must be set as shown.	
Bit 7	SSC: SPI Scan Control. Setting this control bit to 1b allows the calibration values, stored in Addr: 5h, to be read/written. When not reading/writing the calibration values, this control bit should left at its default 0b setting. See <a href="#">Calibration Feature</a> for more information.	
Bits 6:0	Reserved. Must be set as shown.	

**ADC12D1000, ADC12D1600**

SNAS480N – MAY 2010 – REVISED AUGUST 2015

[www.ti.com](http://www.ti.com)
**Table 14. Calibration Values**

Addr: 5h (0101b)									POR state: XXXXh							
Bit	15	14	13	12	11	10	9	8	7	6	5	4	3	2	1	0
Name	SS(15:0)															
POR	X	X	X	X	X	X	X	X	X	X	X	X	X	X	X	X

Bits 15:0 SS(15:0): SPI Scan. When the ADC performs a self-calibration, the values for the calibration are stored in this register and may be read from/ written to it. Set SSC (Addr: 4h, Bit 7) to read/write. See [Calibration Feature](#) for more information.

**Table 15. Reserved**

Addr: 6h (0110b)									POR state: 1C20h							
Bit	15	14	13	12	11	10	9	8	7	6	5	4	3	2	1	0
Name	Res															
POR	0	0	0	1	1	1	0	0	0	0	1	0	0	0	0	0

Bits 15:0 Reserved. Must be set as shown.

**Table 16. Des Timing Adjust**

Addr: 7h (0111b)									POR state: 8140h							
Bit	15	14	13	12	11	10	9	8	7	6	5	4	3	2	1	0
Name	DTA(6:0)								Res							
POR	1	0	0	0	0	0	0	1	0	1	0	0	0	0	0	0

Bits 15:9 DTA(6:0): DES Mode Timing Adjust. In the DES Mode, the time at which the falling edge sampling clock samples relative to the rising edge of the sampling clock may be adjusted; the automatic duty cycle correction continues to function. See [Input Control and Adjust](#) for more information. The nominal step size is 30fs.

Bits 8:0 Reserved. Must be set as shown.

**Table 17. Reserved**

Addr: 8h (1000b)									POR state: 0000h							
Bit	15	14	13	12	11	10	9	8	7	6	5	4	3	2	1	0
Name	Res															
POR	0	0	0	0	0	0	0	0	0	0	0	0	0	0	0	0

Bits 15:0 Reserved. Must be set as shown.

**Table 18. Reserved**

Addr: 9h (1001b)									POR state: 0000h							
Bit	15	14	13	12	11	10	9	8	7	6	5	4	3	2	1	0
Name	Res															
POR	0	0	0	0	0	0	0	0	0	0	0	0	0	0	0	0

Bits 15:0 Reserved. Must be set as shown.



**Table 19. Q-Channel Offset Adjust**

Addr: Ah (1010b)									POR state: 0000h							
Bit	15	14	13	12	11	10	9	8	7	6	5	4	3	2	1	0
Name	Res			OS	OM(11:0)											
POR	0	0	0	0	0	0	0	0	0	0	0	0	0	0	0	0

Bits 15:13	Reserved. Must be set to 0b.	
Bit 12	OS: Offset Sign. The default setting of 0b incurs a positive offset of a magnitude set by Bits 11:0 to the ADC output. Setting this bit to 1b incurs a negative offset of the set magnitude.	
Bits 11:0	OM(11:0): Offset Magnitude. These bits determine the magnitude of the offset set at the ADC output (straight binary coding). The range is from 0 mV for OM(11:0) = 0d to 45 mV for OM(11:0) = 4095d in steps of approximately 11 $\mu$ V. Monotonicity is ensured by design only for the 9 MSBs.	
	Code	Offset [mV]
	0000 0000 0000 (default)	0
	1000 0000 0000	22.5
	1111 1111 1111	45

**Table 20. Q-Channel Full-Scale Range Adjust**

Addr: Bh (1011b)									POR state: 4000h							
Bit	15	14	13	12	11	10	9	8	7	6	5	4	3	2	1	0
Name	Res	FM(14:0)														
POR	0	1	0	0	0	0	0	0	0	0	0	0	0	0	0	0

Bit 15	Reserved. Must be set to 0b.	
Bits 14:0	FM(14:0): FSR Magnitude. These bits increase the ADC full-scale range magnitude (straight binary coding.) The range is from 600 mV (0d) to 1000 mV (32767d) with the default setting at 800 mV (16384d). Monotonicity is ensured by design only for the 9 MSBs. The mid-range (low) setting in ECM corresponds to the nominal (low) setting in Non-ECM. A greater range of FSR values is available in ECM, that is, FSR values above 800 mV. See $V_{IN\_FSR}$ in <a href="#">Electrical Characteristics: Analog Input/Output and Reference</a> for characterization details.	
	Code	FSR [mV]
	000 0000 0000 0000	600
	100 0000 0000 0000 (default)	800
	111 1111 1111 1111	1000

**Table 21. Aperture Delay Coarse Adjust**

Addr: Ch (1100b)									POR state: 0004h							
Bit	15	14	13	12	11	10	9	8	7	6	5	4	3	2	1	0
Name	CAM(11:0)												STA	DCC	Res	
POR	0	0	0	0	0	0	0	0	0	0	0	0	0	1	0	0

Bits 15:4	CAM(11:0): Coarse Adjust Magnitude. This 12-bit value determines the amount of delay that will be applied to the input CLK signal. The range is 0 ps delay for CAM(11:0) = 0d to a maximum delay of 825 ps for CAM(11:0) = 2431d ( $\pm$ 95 ps due to PVT variation) in steps of approximately 340 fs. For code CAM(11:0) = 2432d and above, the delay saturates and the maximum delay applies. Additional, finer delay steps are available in register Dh. The STA (Bit 3) must be selected to enable this function.	
Bit 3	STA: Select $t_{AD}$ Adjust. Set this bit to 1b to enable the $t_{AD}$ adjust feature, which will make both coarse and fine adjustment settings, that is, CAM(11:0) and FAM(5:0), available.	
Bit 2	DCC: Duty Cycle Correct. This bit can be set to 0b to disable the automatic duty-cycle stabilizer feature of the chip. This feature is enabled by default.	
Bits 1:0	Reserved. Must be set to 0b.	

**Table 22. Aperture Delay Fine Adjust**

Addr: Dh (1101b)									POR state: 0000h							
Bit	15	14	13	12	11	10	9	8	7	6	5	4	3	2	1	0
Name	FAM(5:0)						Res		Res							
POR	0	0	0	0	0	0	0	0	0	0	0	0	0	0	0	0

Bits 15:10	FAM(5:0): Fine Aperture Adjust Magnitude. This 6-bit value determines the amount of additional delay that will be applied to the input CLK when the Clock Phase Adjust feature is enabled through STA (Addr: Ch, Bit 3). The range is straight binary from 0 ps delay for FAM(5:0) = 0d to 2.3 ps delay for FAM(5:0) = 63d ( $\pm 300$ fs due to PVT variation) in steps of approximately 36 fs.
Bits 9:0	Reserved. Must be set as shown.

**Table 23. Autosync**

Addr: Eh (1110b)									POR state: 0003h							
Bit	15	14	13	12	11	10	9	8	7	6	5	4	3	2	1	0
Name	DRC(8:0)						Res		SP(1:0)		ES	DOC	DR			
POR	0	0	0	0	0	0	0	0	0	0	0	0	0	0	1	1

Bits 15:7	DRC(8:0): Delay Reference Clock (8:0). These bits may be used to increase the delay on the input reference clock when synchronizing multiple ADCs. The delay may be set from a minimum of 0s (0d) to a maximum of 1000 ps (319d). The delay remains the maximum of 1000 ps for any codes above or equal to 319d. See <a href="#">Synchronizing Multiple ADC12D1x00s in a System</a> for more information.
Bits 6:5	Reserved. Must be set as shown.
Bits 4:3	SP(1:0): Select Phase. These bits select the phase of the reference clock which is latched. The codes correspond to the following phase shift: 00 = 0° 01 = 90° 10 = 180° 11 = 270°
Bit 2	ES: Enable Slave. Set this bit to 1b to enable the Slave Mode of operation. In this mode, the internal divided clocks are synchronized with the reference clock coming from the master ADC. The master clock is applied on the input pins RCLK. If this bit is set to 0b, then the device is in Master Mode.
Bit 1	DOC: Disable Output reference Clocks. Setting this bit to 0b sends a CLK/4 signal on RCOut1 and RCOut2. The default setting of 1b disables these output drivers. This bit functions as described, regardless of whether the device is operating in Master or Slave Mode, as determined by ES (Bit 2).
Bit 0	DR: Disable Reset. The default setting of 1b leaves the DCLK_RST functionality disabled. Set this bit to 0b to enable DCLK_RST functionality.

**Table 24. Reserved**

Addr: Fh (1111b)									POR state: 0018h							
Bit	15	14	13	12	11	10	9	8	7	6	5	4	3	2	1	0
Name	Res															
POR	0	0	0	0	0	0	0	0	0	0	0	1	1	0	0	0

Bits 15:0	Reserved. This address is read only.
-----------	--------------------------------------

## 8 Application and Implementation

### NOTE

Information in the following applications sections is not part of the TI component specification, and TI does not warrant its accuracy or completeness. TI's customers are responsible for determining suitability of components for their purposes. Customers should validate and test their design implementation to confirm system functionality.

### 8.1 Application Information

#### 8.1.1 The Analog Inputs

The ADC12D1x00 will continuously convert any signal which is present at the analog inputs, as long as a CLK signal is also provided to the device. This section covers important aspects related to the analog inputs including: acquiring the input, driving the ADC in DES Mode, the reference voltage and FSR, out-of-range indication, AC-DC-coupled signals, and single-ended input signals.

##### 8.1.1.1 Acquiring the Input

Data is acquired at the rising edge of CLK+ in Non-DES Mode and both the falling and rising edges of CLK+ in DES Mode. The digital equivalent of that data is available at the digital outputs a constant number of sampling clock cycles later for the DI, DQ, DI<sub>d</sub> and DQ<sub>d</sub> output buses, a.k.a. Latency, depending on the demultiplex mode which is selected. See  $t_{LAT}$  in [Electrical Characteristics: AC](#). In addition to the Latency, there is a constant output delay,  $t_{OD}$ , before the data is available at the outputs. See  $t_{OD}$  in [Electrical Characteristics: AC](#) and the timing diagrams.

The output latency versus Demux/Non-Demux Mode is shown in [Table 25](#) and [Table 26](#), respectively. For DES Mode, the I- and Q-channel inputs are available in ECM, but only the I-channel input is available in Non-ECM.

**Table 25. Output Latency in Demux Mode**

DATA	NON-DES MODE	DES MODE	
		Q-INPUT <sup>(1)</sup>	I-INPUT
DI	I-input sampled with rise of CLK, 34 cycles earlier	Q-input sampled with rise of CLK, 34 cycles earlier	I-input sampled with rise of CLK, 34 cycles earlier
DQ	Q-input sampled with rise of CLK, 34 cycles earlier	Q-input sampled with fall of CLK, 34.5 cycles earlier	I-input sampled with fall of CLK, 34.5 cycles earlier
DI <sub>d</sub>	I-input sampled with rise of CLK, 35 cycles earlier	Q-input sampled with rise of CLK, 35 cycles earlier	I-input sampled with rise of CLK, 35 cycles earlier
DQ <sub>d</sub>	Q-input sampled with rise of CLK, 35 cycles earlier	Q-input sampled with fall of CLK, 35.5 cycles earlier	I-input sampled with fall of CLK, 35.5 cycles earlier

(1) Available in ECM only.

**Table 26. Output Latency in Non-Demux Mode**

DATA	NON-DES MODE	DES MODE	
		Q-INPUT <sup>(1)</sup>	I-INPUT
DI	I-input sampled with rise of CLK, 34 cycles earlier	Q-input sampled with rise of CLK, 34 cycles earlier	I-input sampled with rise of CLK, 34 cycles earlier
DQ	Q-input sampled with rise of CLK, 34 cycles earlier	Q-input sampled with rise of CLK, 34.5 cycles earlier	I-input sampled with rise of CLK, 34.5 cycles earlier
DI <sub>d</sub>	No output; high impedance.		
DQ <sub>d</sub>	No output; high impedance.		

(1) Available in ECM only.

### 8.1.1.2 Driving the ADC in DES Mode

The ADC12D1x00 can be configured as either a 2-channel, 1.0/1.6 GSPS device (Non-DES Mode) or a 1-channel 2.0/3.2 GSPS device (DES Mode). When the device is configured in DES Mode, there is a choice for with which input to drive the single-channel ADC. These are the 3 options:

DES – externally driving the I-channel input only. This is the default selection when the ADC is configured in DES Mode. It may also be referred to as “DESI” for added clarity.

DESQ – externally driving the Q-channel input only.

DESIQ – externally driving both the I- and Q-channel inputs.  $V_{IN+}$  and  $V_{INQ+}$  should be driven with the exact same signal.  $V_{IN-}$  and  $V_{INQ-}$  should be driven with the exact same signal, which is the differential complement to the one driving  $V_{IN+}$  and  $V_{INQ+}$ .

The input impedance for each I- and Q-input is 100  $\Omega$  differential (or 50  $\Omega$  single-ended), so the trace to each  $V_{IN+}$ ,  $V_{IN-}$ ,  $V_{INQ+}$ , and  $V_{INQ-}$  should always be 50  $\Omega$  single-ended. If a single I- or Q-input is being driven, then that input will present a 100- $\Omega$  differential load. For example, if a 50- $\Omega$  single-ended source is driving the ADC, then a 1:2 balun will transform the impedance to 100  $\Omega$  differential. However, if the ADC is being driven in DESIQ Mode, then the 100- $\Omega$  differential impedance from the I-input will appear in parallel with the Q-input for a composite load of 50  $\Omega$  differential and a 1:1 balun would be appropriate. See [Figure 66](#) for an example circuit driving the ADC in DESIQ Mode. A recommended part selection is using the Mini-Circuits TC1-1-13MA+ balun with  $C_{couple} = 0.22 \mu\text{F}$ .

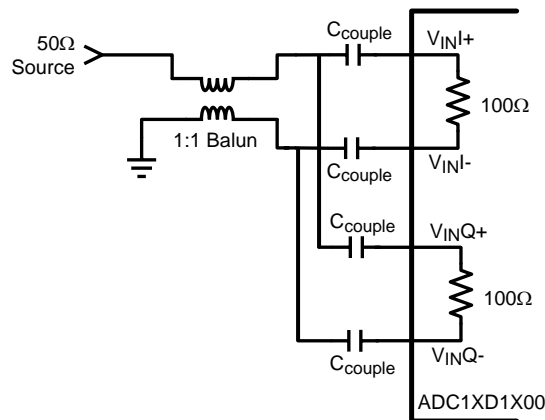

**Figure 66. Driving DESIQ Mode**

In the case that only one channel is used in Non-DES Mode or that the ADC is driven in DESI or DESQ Mode, the unused analog input should be terminated to reduce any noise coupling into the ADC. See [Table 27](#) for details.

**Table 27. Unused Analog Input Recommended Termination**

MODE	POWER DOWN	COUPLING	RECOMMENDED TERMINATION
Non-DES	Yes	AC-DC	Tie Unused+ and Unused- to Vbg
DES/Non-DES	No	DC	Tie Unused+ and Unused- to Vbg
DES/Non-DES	No	AC	Tie Unused+ to Unused-

### 8.1.1.3 FSR and the Reference Voltage

The full-scale analog differential input range ( $V_{IN\_FSR}$ ) of the ADC12D1x00 is derived from an internal bandgap reference. In Non-ECM, this full-scale range has two settings controlled by the FSR Pin; see [Full-Scale Input Range Pin \(FSR\)](#). The FSR Pin operates on both I- and Q-channels. In ECM, the full-scale range may be independently set for each channel through Addr:3h and Bh with 15 bits of precision; see [Register Maps](#). The best SNR is obtained with a higher full-scale input range, but better distortion and SFDR are obtained with a lower full-scale input range. It is not possible to use an external analog reference voltage to modify the full-scale range, and this adjustment should only be done digitally, as described.

A buffered version of the internal bandgap reference voltage is made available at the  $V_{BG}$  Pin for the user. The  $V_{BG}$  pin can drive a load of up to 80 pF and source or sink up to 100  $\mu$ A. It should be buffered if more current than this is required. This pin remains as a constant reference voltage regardless of what full-scale range is selected and may be used for a system reference.  $V_{BG}$  is a dual-purpose pin and it may also be used to select a higher LVDS output common-mode voltage; see [LVDS Output Common-Mode Pin \( \$V\_{BG}\$ \)](#).

#### 8.1.1.4 Out-of-Range Indication

Differential input signals are digitized to 12 bits, based on the full-scale range. Signal excursions beyond the full-scale range, that is, greater than  $+V_{IN\_FSR}/2$  or less than  $-V_{IN\_FSR}/2$ , will be clipped at the output. An input signal which is above the FSR will result in all 1's at the output and an input signal which is below the FSR will result in all 0's at the output. When the conversion result is clipped for the I-channel input, the Out-of-Range I-channel (ORI) output is activated such that ORI+ goes high and ORI- goes low while the signal is out of range. This output is active as long as accurate data on either or both of the buses would be outside the range of 000h to FFFh. The Q-channel has a separate ORQ which functions similarly.

#### 8.1.1.5 Maximum Input Range

The recommended operating and absolute maximum input range may be found in [Recommended Operating Conditions](#) and [Absolute Maximum Ratings](#), respectively. Under the stated allowed operating conditions, each  $V_{in+}$  and  $V_{in-}$  input pin may be operated in the range from 0 V to 2.15 V if the input is a continuous 100% duty cycle signal and from 0 V to 2.5 V if the input is a 10% duty cycle signal. The absolute maximum input range for  $V_{in+}$  and  $V_{in-}$  is from  $-0.15$  V to 2.5 V. These limits apply only for input signals for which the input common-mode voltage is properly maintained.

#### 8.1.1.6 AC-Coupled Input Signals

The ADC12D1x00 analog inputs require a precise common-mode voltage. This voltage is generated on-chip when AC-coupling Mode is selected. See [AC-DC-Coupled Mode Pin \( \$V\_{CMO}\$ \)](#) for more information about how to select AC-coupled Mode.

In AC-coupled Mode, the analog inputs must of course be AC-coupled. For an ADC12D1x00 used in a typical application, this may be accomplished by on-board capacitors, as shown in [Figure 67](#). For the ADC12D1x00RB, the SMA inputs on the Reference Board are directly connected to the analog inputs on the ADC12D1x00, so this may be accomplished by DC blocks (included with the hardware kit).

When the AC-coupled Mode is selected, an analog input channel that is not used (for example, in DES Mode) should be connected to AC ground, for example, through capacitors to ground. Do not connect an unused analog input directly to ground.

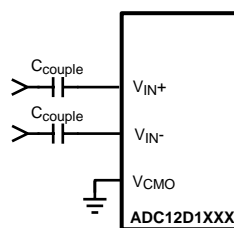

Figure 67. AC-Coupled Differential Input

The analog inputs for the ADC12D1x00 are internally buffered, which simplifies the task of driving these inputs and the RC pole which is generally used at sampling ADC inputs is not required. If the user desires to place an amplifier circuit before the ADC, care should be taken to choose an amplifier with adequate noise and distortion performance, and adequate gain at the frequencies used for the application.

### 8.1.1.7 DC-Coupled Input Signals

In DC-coupled Mode, the ADC12D1x00 differential inputs must have the correct common-mode voltage. This voltage is provided by the device itself at the  $V_{CMO}$  output pin. TI recommends using this voltage because the  $V_{CMO}$  output potential will change with temperature and the common-mode voltage of the driving device should track this change. Full-scale distortion performance falls off as the input common mode voltage deviates from  $V_{CMO}$ . Therefore, TI recommends keeping the input common-mode voltage within 100 mV of  $V_{CMO}$  (typical), although this range may be extended to  $\pm 150$  mV (maximum). See  $V_{CMI}$  in [Electrical Characteristics: Analog Input/Output and Reference](#) and ENOB vs.  $V_{CMI}$  in [Typical Characteristics](#). Performance in AC- and DC-coupled Mode are similar, provided that the input common mode voltage at both analog inputs remains within 100 mV of  $V_{CMO}$ .

### 8.1.1.8 Single-Ended Input Signals

The analog inputs of the ADC12D1x00 are not designed to accept single-ended signals. The best way to handle single-ended signals is to first convert them to differential signals before presenting them to the ADC. The easiest way to accomplish single-ended to differential signal conversion is with an appropriate balun-transformer, as shown in [Figure 68](#).

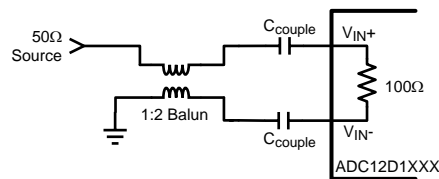

**Figure 68. Single-Ended to Differential Conversion Using a Balun**

When selecting a balun, it is important to understand the input architecture of the ADC. The impedance of the analog source should be matched to the on-chip 100- $\Omega$  differential input termination resistor of the ADC12D1x00. The range of this termination resistor is specified as  $R_{IN}$  in [Electrical Characteristics: Analog Input/Output and Reference](#).

## 8.1.2 The Clock Inputs

The ADC12D1x00 has a differential clock input, CLK+ and CLK-, which must be driven with an AC-coupled, differential clock signal. This provides the level shifting necessary to allow for the clock to be driven with LVDS, PECL, LVPECL, or CML levels. The clock inputs are internally terminated to 100 $\Omega$  differential and self-biased. This section covers coupling, frequency range, level, duty-cycle, jitter, and layout considerations.

### 8.1.2.1 CLK Coupling

The clock inputs of the ADC12D1x00 must be capacitively coupled to the clock pins as indicated in [Figure 69](#).

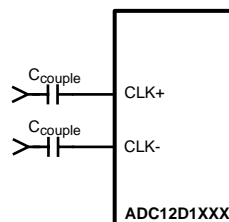

**Figure 69. Differential Input Clock Connection**

The choice of capacitor value will depend on the clock frequency, capacitor component characteristics and other system economic factors. For example, on the ADC12D1x00RB, the capacitors have the value  $C_{couple} = 4.7$  nF which yields a highpass cutoff frequency,  $f_c = 677.2$  kHz.

### 8.1.2.2 CLK Frequency

Although the ADC12D1x00 is tested and its performance is ensured with a differential 1.0/1.6 GHz sampling clock, it will typically function well over the input clock frequency range; see  $f_{CLK(min)}$  and  $f_{CLK(max)}$  in [Electrical Characteristics: AC](#). Operation up to  $f_{CLK(max)}$  is possible if the maximum ambient temperatures indicated are not exceeded. Operating at sample rates above  $f_{CLK(max)}$  for the maximum ambient temperature may result in reduced device reliability and product lifetime. This is due to the fact that higher sample rates results in higher power consumption and die temperatures. If  $f_{CLK} < 300$  MHz, enable LFS in the Control Register (Addr: 0h, Bit 8).

### 8.1.2.3 CLK Level

The input clock amplitude is specified as  $V_{IN\_CLK}$  in [Electrical Characteristics: Converter and Sampling Clock](#). Input clock amplitudes above the max  $V_{IN\_CLK}$  may result in increased input offset voltage. This would cause the converter to produce an output code other than the expected 2047/2048 when both input pins are at the same potential. Insufficient input clock levels will result in poor dynamic performance. Both of these results may be avoided by keeping the clock input amplitude within the specified limits of  $V_{IN\_CLK}$ .

### 8.1.2.4 CLK Duty Cycle

The duty cycle of the input clock signal can affect the performance of any A/D converter. The ADC12D1x00 features a duty cycle clock correction circuit which can maintain performance over the 20%-to-80% specified clock duty-cycle range. This feature is enabled by default and provides improved ADC clocking, especially in the Dual-Edge Sampling (DES) Mode.

### 8.1.2.5 CLK Jitter

High speed, high performance ADCs such as the ADC12D1x00 require a very stable input clock signal with minimum phase noise or jitter. ADC jitter requirements are defined by the ADC resolution (number of bits), maximum ADC input frequency and the input signal amplitude relative to the ADC input full scale range. The maximum jitter (the sum of the jitter from all sources) allowed to prevent a jitter-induced reduction in SNR is found to be:

$$t_{J(MAX)} = (V_{IN(P-P)} / V_{FSR}) \times (1 / (2^{(N+1)} \times \pi \times f_{IN}))$$

where

- $t_{J(MAX)}$  is the rms total of all jitter sources in seconds
- $V_{IN(P-P)}$  is the peak-to-peak analog input signal
- $V_{FSR}$  is the full-scale range of the ADC
- "N" is the ADC resolution in bits
- $f_{IN}$  is the maximum input frequency, in Hertz, at the ADC analog input. (1)

$t_{J(MAX)}$  is the square root of the sum of the squares (RSS) of the jitter from all sources, including: the ADC input clock, system, input signals and the ADC itself. Because the effective jitter added by the ADC is beyond user control, TI recommends keeping the sum of all other externally added jitter to a minimum.

### 8.1.2.6 CLK Layout

The ADC12D1x00 clock input is internally terminated with a trimmed 100-Ω resistor. The differential input clock line pair should have a characteristic impedance of 100 Ω and (when using a balun), be terminated at the clock source in that (100 Ω) characteristic impedance.

It is a good practice to keep the ADC input clock line as short as possible, tightly coupled, keep it well away from any other signals, and treat it as a transmission line. Otherwise, other signals can introduce jitter into the input clock signal. Also, the clock signal can introduce noise into the analog path if it is not properly isolated.

## 8.1.3 The LVDS Outputs

The Data, ORI, ORQ, DCLKI and DCLKQ outputs are LVDS. The electrical specifications of the LVDS outputs are compatible with typical LVDS receivers available on ASIC and FPGA chips; but they are not IEEE or ANSI communications standards compliant due to the low 1.9-V supply used on this chip. These outputs should be terminated with a 100-Ω differential resistor placed as closely to the receiver as possible. If the 100-Ω differential resistance is built in to the receiver, then an externally placed resistor is not necessary. This section covers common-mode and differential voltage, and data rate.



### 8.1.3.1 Common-Mode and Differential Voltage

The LVDS outputs have selectable common-mode and differential voltage,  $V_{OS}$  and  $V_{OD}$ ; see [Electrical Characteristics: Digital Control and Output Pin](#). See [Output Control and Adjust](#) for more information.

Selecting the higher  $V_{OS}$  will also increase  $V_{OD}$  slightly. The differential voltage,  $V_{OD}$ , may be selected for the higher or lower value. For short LVDS lines and low noise systems, satisfactory performance may be realized with the lower  $V_{OD}$ . This will also result in lower power consumption. If the LVDS lines are long and/or the system in which the ADC12D1x00 is used is noisy, it may be necessary to select the higher  $V_{OD}$ .

### 8.1.3.2 Output Data Rate

The data is produced at the output at the same rate it is sampled at the input. The minimum recommended input clock rate for this device is  $f_{CLK(MIN)}$ ; see [Electrical Characteristics: AC](#). However, it is possible to operate the device in 1:2 Demux Mode and capture data from just one 12-bit bus, for example, just DI (or DI<sub>d</sub>) although both DI and DI<sub>d</sub> are fully operational. This will decimate the data by two and effectively halve the data rate.

### 8.1.3.3 Terminating Unused LVDS Output Pins

If the ADC is used in Non-Demux Mode, then only the DI and DQ data outputs will have valid data present on them. The DI<sub>d</sub> and DQ<sub>d</sub> data outputs may be left not connected; if unused, they are internally at TRI-STATE.

Similarly, if the Q-channel is powered-down (that is, PDQ is logic-high), the DQ data output pins, DCLKQ and ORQ may be left not connected.

### 8.1.4 Synchronizing Multiple ADC12D1x00s in a System

The ADC12D1x00 has two features to assist the user with synchronizing multiple ADCs in a system; AutoSync and DCLK Reset. The AutoSync feature is new and designates one ADC12D1x00 as the Master ADC and other ADC12D1x00s in the system as Slave ADCs. The DCLK Reset feature performs the same function as the AutoSync feature, but is the first generation solution to synchronizing multiple ADCs in a system; it is disabled by default. For the application in which there are multiple Master and Slave ADC12D1x00s in a system, AutoSync may be used to synchronize the Slave ADC12D1x00(s) to each respective Master ADC12D1x00 and the DCLK Reset may be used to synchronize the Master ADC12D1x00s to each other.

If the AutoSync or DCLK Reset feature is not used, see [Table 28](#) for recommendations about terminating unused pins.

**Table 28. Unused Autosync and DCLK Reset Pin Recommendation**

PINS	UNUSED TERMINATION
RCLK+/-	Do not connect.
RCOUT1+/-	Do not connect.
RCOUT2+/-	Do not connect.
DCLK_RST+	Connect to GND through 1-kΩ resistor.
DCLK_RST-	Connect to $V_A$ through 1-kΩ resistor.

#### 8.1.4.1 Autosync Feature

AutoSync is a new feature which continuously synchronizes the outputs of multiple ADC12D1x00s in a system. It may be used to synchronize the DCLK and data outputs of one or more Slave ADC12D1x00s to one Master ADC12D1x00. Several advantages of this feature include: no special synchronization pulse required, any upset in synchronization is recovered upon the next DCLK cycle, and the Master/Slave ADC12D1x00s may be arranged as a binary tree so that any upset will quickly propagate out of the system.

An example system is shown below in [Figure 70](#) which consists of one Master ADC and two Slave ADCs. For simplicity, only one DCLK is shown; in reality, there is DCLKI and DCLKQ, but they are always in phase with one another.



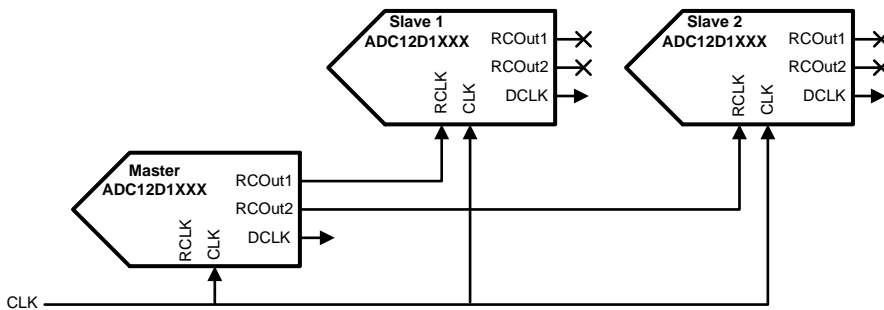

Figure 70. AutoSync Example

To synchronize the DCLK (and Data) outputs of multiple ADCs, the DCLKs must transition at the same time, as well as be in phase with one another. The DCLK at each ADC is generated from the CLK after some latency, plus  $t_{OD}$  minus  $t_{AD}$ . Therefore, in order for the DCLKs to transition at the same time, the CLK signal must reach each ADC at the same time. To tune out any differences in the CLK path to each ADC, the  $t_{AD}$  adjust feature may be used. However, using the  $t_{AD}$  adjust feature will also affect when the DCLK is produced at the output. If the device is in Demux Mode, then there are four possible phases which each DCLK may be generated on because the typical CLK = 1 GHz and DCLK = 250 MHz for this case. The RCLK signal controls the phase of the DCLK, so that each Slave DCLK is on the same phase as the Master DCLK.

The AutoSync feature may only be used through the Control Registers. For more information, see *AN-2132 Synchronizing Multiple GSPS ADCs in a System: The AutoSync Feature* (SNA073).

#### 8.1.4.2 DCLK Reset Feature

The DCLK reset feature is available through ECM, but it is disabled by default. DCLKI and DCLKQ are always synchronized, by design, and do not require a pulse from DCLK\_RST to become synchronized.

The DCLK\_RST signal must observe certain timing requirements, which are shown in [Figure 5](#) of the Timing Diagrams. The DCLK\_RST pulse must be of a minimum width and its deassertion edge must observe setup and hold times with respect to the CLK input rising edge. These timing specifications are listed as  $t_{PWR}$ ,  $t_{SR}$  and  $t_{HR}$  and may be found in *Electrical Characteristics: AC*.

The DCLK\_RST signal can be asserted asynchronously to the input clock. If DCLK\_RST is asserted, the DCLK output is held in a designated state (logic-high) in Demux Mode; in Non-Demux Mode, the DCLK continues to function normally. Depending upon when the DCLK\_RST signal is asserted, there may be a narrow pulse on the DCLK line during this reset event. When the DCLK\_RST signal is deasserted, there are  $t_{SYNC\_DLY}$  CLK cycles of systematic delay and the next CLK rising edge synchronizes the DCLK output with those of other ADC12D1x00s in the system. For 90° Mode (DDRP<sub>H</sub> = logic-high), the synchronizing edge occurs on the rising edge of CLK, 4 cycles after the first rising edge of CLK after DCLK\_RST is released. For 0° Mode (DDRP<sub>H</sub> = logic-low), this is 5 cycles instead. The DCLK output is enabled again after a constant delay of  $t_{OD}$ .

For both Demux and Non-Demux Modes, there is some uncertainty about how DCLK comes out of the reset state for the first DCLK\_RST pulse. For the second (and subsequent) DCLK\_RST pulses, the DCLK will come out of the reset state in a known way. Therefore, if using the DCLK Reset feature, TI recommends applying one "dummy" DCLK\_RST pulse before using the second DCLK\_RST pulse to synchronize the outputs. This recommendation applies each time the device or channel is powered-on.

When using DCLK\_RST to synchronize multiple ADC12D1x00s, it is required that the Select Phase bits in the Control Register (Addr: Eh, Bits 3,4) be the same for each Master ADC12D1x00.

#### 8.1.5 Recommended System Chips

TI recommends these other chips including temperature sensors, clocking devices, and amplifiers to support the ADC12D1x00 in a system design.

### 8.1.5.1 Temperature Sensor

The ADC12D1x00 has an on-die temperature diode connected to pins Tdiode+/- which may be used to monitor the die temperature. TI also provides a family of temperature sensors for this application which monitor different numbers of external devices, see [Table 29](#).

**Table 29. Temperature Sensor Recommendation**

NUMBER OF EXTERNAL DEVICES MONITORED	RECOMMENDED TEMPERATURE SENSOR
1	LM95235
2	LM95213
4	LM95214

The temperature sensor (LM95235/13/14) is an 11-bit digital temperature sensor with a 2-wire System Management Bus (SMBus) interface that can monitor the temperature of one, two, or four remote diodes as well as its own temperature. It can be used to accurately monitor the temperature of up to one, two, or four external devices such as the ADC12D1x00, a FPGA, other system components, and the ambient temperature.

The temperature sensor reports temperature in two different formats for +127.875°C/-128°C range and 0°/255°C range. It has a Sigma-Delta ADC core which provides the first level of noise immunity. For improved performance in a noisy environment, the temperature sensor includes programmable digital filters for Remote Diode temperature readings. When the digital filters are invoked, the resolution for the Remote Diode readings increases to 0.03125°C. For maximum flexibility and best accuracy, the temperature sensor includes offset registers that allow calibration for other types of diodes.

Diode fault detection circuitry in the temperature sensor can detect the absence or fault state of a remote diode: whether D+ is shorted to the power supply, D- or ground, or floating.

In the following typical application, the LM95213 is used to monitor the temperature of an ADC12D1x00 as well as an FPGA, see [Figure 71](#). If this feature is unused, the Tdiode+/- pins may be left floating.

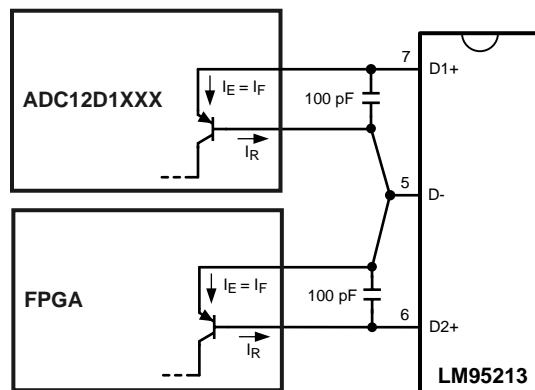

**Figure 71. Typical Temperature Sensor Application**

### 8.1.5.2 Clocking Device

The clock source can be a PLL or VCO device such as the LMX2531LQxxxx family of products. The specific device should be selected according to the desired ADC sampling clock frequency. The ADC12D1x00RB uses the LMX2531LQ1910E/1570E, with the ADC clock source provided by the Aux PLL output. Other devices which may be considered based on clock source, jitter cleaning, and distribution purposes are the LMK01XXX, LMK02XXX, LMK03XXX and LMK04XXX product families.

### 8.1.5.3 Amplifiers for the Analog Input

The following amplifiers can be used for ADC12D1x00 applications which require DC coupled input or signal gain, neither of which can be provided with a transformer coupled input circuit. In addition, several of the amplifiers provide single-ended to differential conversion options:

**Table 30. Amplifier Recommendations**

AMPLIFIER	BANDWIDTH	BRIEF FEATURES
LMH3401	7 GHz	Fixed gain, single-ended to differential conversion
LMH5401	8 GHz	Configurable gain, single-ended to differential conversion
LMH6401	4.5 GHz	Digital variable controlled gain
LMH6554	2.8 GHz	Configurable gain
LMH6555	1.2 GHz	Fixed gain

**8.1.5.4 Balun Recommendations for Analog Input**

The following baluns are recommended for the ADC12D1x00 for applications which require no gain. When evaluating a balun for the application of driving an ADC, some important qualities to consider are phase error and magnitude error.

**Table 31. Balun Recommendations**

BALUN	BANDWIDTH
Mini Circuits TC1-1-13MA+	4.5 - 3000MHz
Anaren B0430J50100A00	400 - 3000 MHz
Mini Circuits ADTL2-18	30 - 1800 MHz

**8.2 Typical Application**

The ADC12D1600 can be used to directly sample a signal in the radio frequency range for downstream processing. The wide input bandwidth, buffered input, and high sampling rate make ADC12D1600 ideal for RF sampling applications.

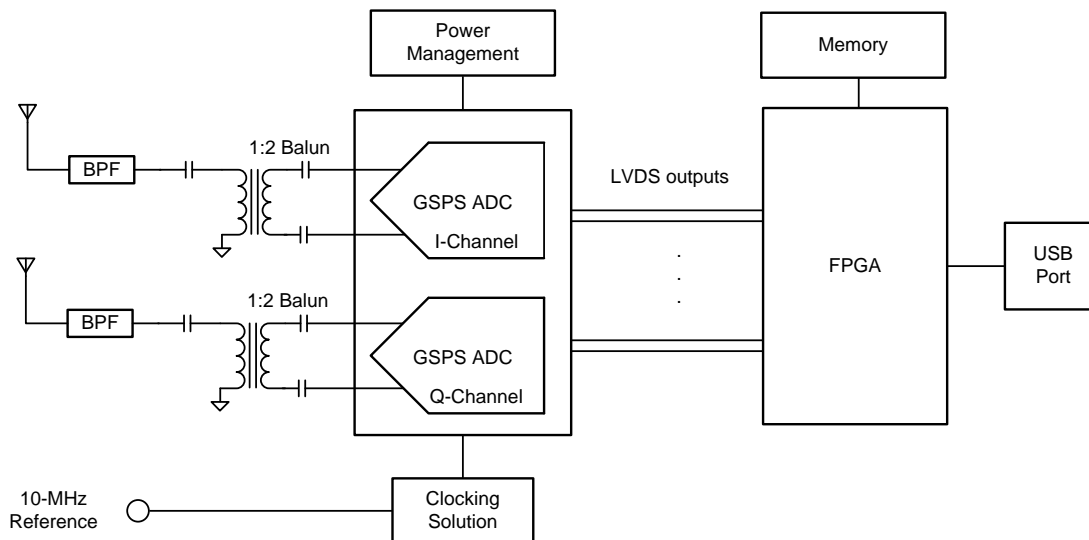

**Figure 72. Simplified Schematic**

## Typical Application (continued)

### 8.2.1 Design Requirements

In this example, ADC12D1600 will be used to sample signals in DES mode and Non-DES mode. The design parameters are listed in [Table 32](#).

**Table 32. Design Parameters**

DESIGN PARAMETERS	EXAMPLE VALUES (Non-DES mode)	EXAMPLE VALUES (DES mode)
Signal center frequency	1800 MHz	1000 MHz
Signal bandwidth	100 MHz	75 MHz
ADC sampling Rate	1600 MSPS	3200 MSPS
Signal nominal amplitude	-7 dBm	-7 dBm
Signal maximum amplitude	6 dBm	6 dBm
Minimum SNR (in BW of interest)	48 dBc	48 dBc
Minimum THD (in BW of interest)	-57 dBc	-55 dBc
Minimum SFDR (in BW of interest)	53 dBc	50 dBc

### 8.2.2 Detailed Design Procedure

Use the step described below to design the RF receiver:

- Select the appropriate mode of operation (DES mode or Non-DES mode).
- Use the input signal frequency to select an appropriate sampling rate.
- Select the sampling rate so that the input signal is within the Nyquist zone and away from any harmonics and interleaving tones.
- Select the system components such as clocking device, amplifier for analog input and Balun according to sampling frequency and input signal frequency.
- See [Clocking Device](#) for the recommended clock sources.
- See [Amplifiers for the Analog Input](#) for recommended analog amplifiers.
- See [Balun Recommendations for Analog Input](#) for recommended Balun components.
- Select the bandpass filters and limiter components based on the requirement to attenuate the unwanted input signals.

**8.2.3 Application Curves**

Figure 73 and Figure 74 show an RF signal at 1797.97 MHz captured at a sample rate of 1600 MSPS in Non-DES mode and an RF signal at 997.97 MHz sample at an effective sample rate of 3200 MSPS in DES mode.

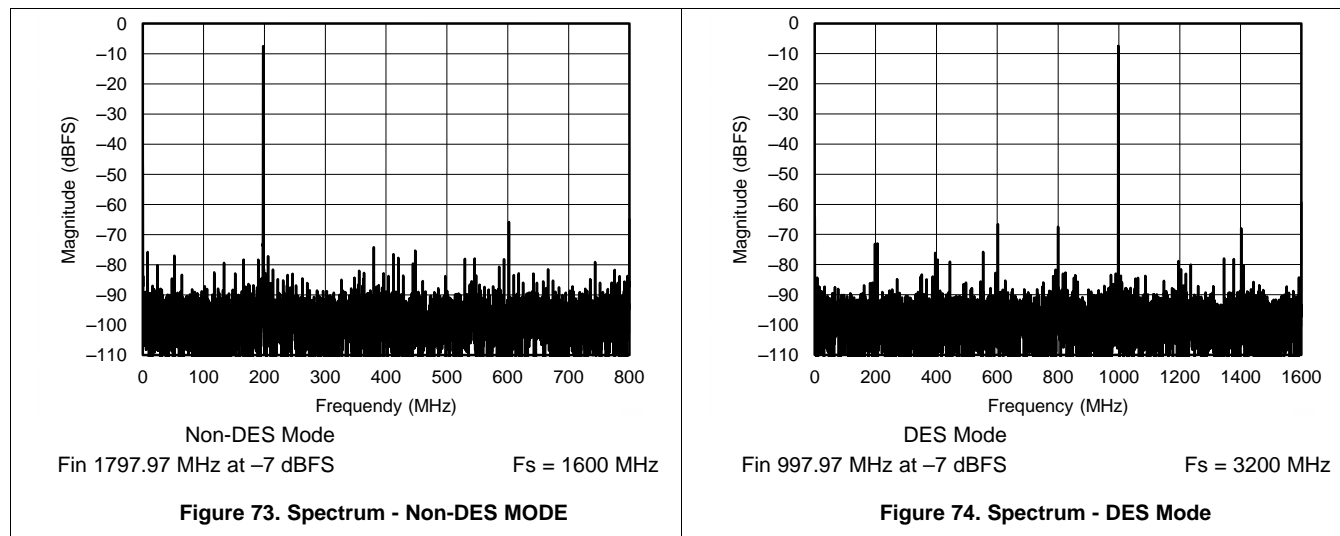

**Table 33. ADC12D1600 Performance for Single Tone Signal at 1797.97 MHz in NON-DES Mode**

PARAMETER	VALUE
SNR	49.7 dBc
SFDR	58.3 dBc
THD	-64.4 dBc
SINAD	49.6 dBc
ENOB	7.9 bits

**Table 34. ADC12D1600 Performance for Single Tone Signal at 997.97 MHz in DES Mode**

PARAMETER	VALUE
SNR	49.3 dBc
SFDR	53.6 dBc
THD	-63.8 dBc
SINAD	49.2 dBc
ENOB	7.8 bits

## 9 Power Supply Recommendations

Data-converter-based systems draw sufficient transient current to corrupt their own power supplies if not adequately bypassed. A 10- $\mu$ F capacitor must be placed within one inch (2.5 cm) of the device power pins for each supply voltage. A 0.1- $\mu$ F capacitor must be placed as close as possible to each supply pin, preferably within 0.5 cm. Leadless chip capacitors are preferred due to their low-lead inductance.

As is the case with all high-speed converters, the ADC12D1600 device must be assumed to have little power supply noise-rejection. Any power supply used for digital circuitry in a system where a large amount of digital power is consumed must not be used to supply power to the ADC12D1600 device. If not a dedicated supply, the ADC supplies must be the same supply used for other analog circuitry.

### 9.1 System Power-On Considerations

There are a couple important topics to consider associated with the system power-on event including configuration and calibration, and the Data Clock.

#### 9.1.1 Power-On, Configuration, and Calibration

Following the application of power to the ADC12D1x00, several events must take place before the output from the ADC12D1x00 is valid and at full performance; at least one full calibration must be executed with the device configured in the desired mode.

Following the application of power to the ADC12D1x00, there is a delay of  $t_{\text{CalDly}}$  and then the Power-on Calibration is executed. This is why TI recommends setting the CalDly Pin through an external pullup or pulldown resistor. This ensures that the state of that input will be properly set at the same time that power is applied to the ADC and  $t_{\text{CalDly}}$  will be a known quantity. For the purpose of this section, it is assumed that CalDly is set as recommended.

The Control Bits or Pins must be set or written to configure the ADC12D1x00 in the desired mode. This must take place through either Extended Control Mode or Non-ECM (Pin Control Mode) before subsequent calibrations will yield an output at full performance in that mode. Some examples of modes include DES/Non-DES Mode, Demux/Non-demux Mode, and Full-Scale Range.

The simplest case is when device is in Non-ECM and the Control Pins are set by pullup and pulldown resistors, see [Figure 75](#). For this case, the settings to the Control Pins ramp concurrently to the ADC voltage. Following the delay of  $t_{\text{CalDly}}$  and the calibration execution time,  $t_{\text{CAL}}$ , the output of the ADC12D1x00 is valid and at full performance. If it takes longer than  $t_{\text{CalDly}}$  for the system to stabilize at its operating temperature, TI recommends executing an on-command calibration at that time.

Another case is when the FPGA configures the Control Pins (Non-ECM) or writes to the SPI (ECM), see [Figure 76](#). It is always necessary to comply with the Operating Ratings and Absolute Maximum ratings, that is, the Control Pins may not be driven below the ground or above the supply, regardless of what the voltage currently applied to the supply is. Therefore, it is not recommended to write to the Control Pins or SPI before power is applied to the ADC12D1x00. As long as the FPGA has completed writing to the Control Pins or SPI, the Power-on Calibration will result in a valid output at full performance. Once again, if it takes longer than  $t_{\text{CalDly}}$  for the system to stabilize at its operating temperature, TI recommends executing an on-command calibration at that time.

Due to system requirements, it may not be possible for the FPGA to write to the Control Pins or SPI before the Power-on Calibration takes place, see [Figure 77](#). It is not critical to configure the device before the Power-on Calibration, but it is critical to realize that the output for such a case is not at its full performance. Following an On-command Calibration, the device will be at its full performance.

System Power-On Considerations (continued)

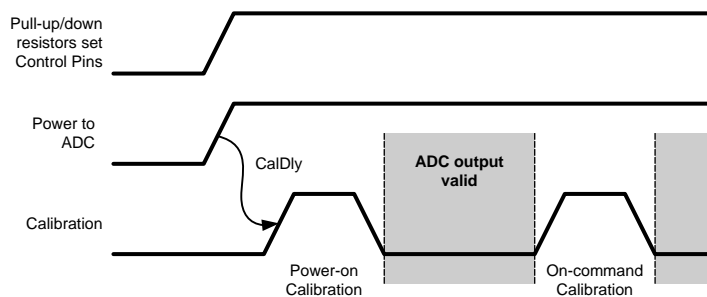

Figure 75. Power-On With Control Pins Set by Pullup and Pulldown Resistors

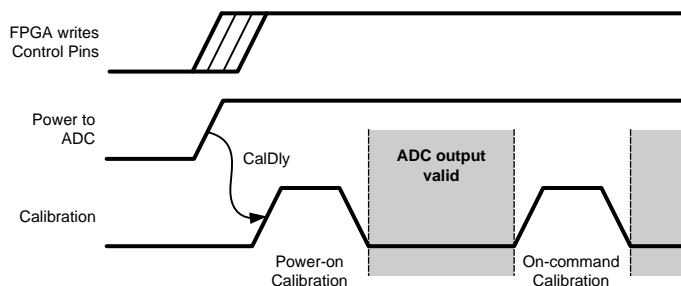

Figure 76. Power-On With Control Pins Set by FPGA Pre Power-on Cal

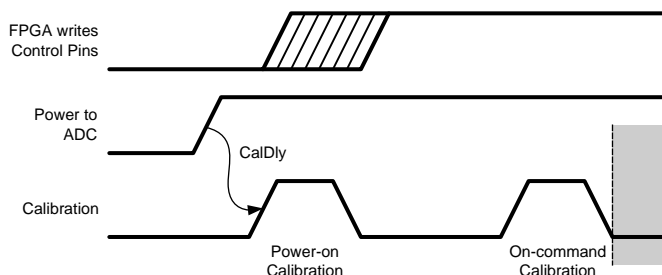
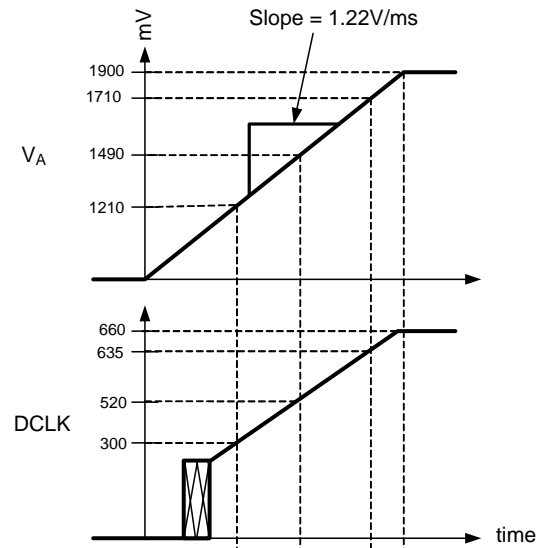

Figure 77. Power-On With Control Pins Set by FPGA Post Power-on Cal

9.1.2 Power-On and Data Clock (Dclk)

Many applications use the DCLK output for a system clock. For the ADC12D1x00, each I- and Q-channel has its own DCLKI and DCLKQ, respectively. The DCLK output is always active, unless that channel is powered-down or the DCLK Reset feature is used while the device is in Demux Mode. As the supply to the ADC12D1x00 ramps, the DCLK also comes up, see this example from the ADC12D1x00RB: [Figure 78](#). While the supply is too low, there is no output at DCLK. As the supply continues to ramp, DCLK functions intermittently with irregular frequency, but the amplitude continues to track with the supply. Much below the low end of operating supply range of the ADC12D1x00, the DCLK is already fully operational.

## System Power-On Considerations (continued)



**Figure 78. Supply and DCLK Ramping**

## 9.2 Supply Voltage

The ADC12D1600 device is specified to operate with nominal supply voltages of 1.9 V ( $V_A$ ,  $V_{TC}$ ,  $V_E$  and  $V_{DR}$ ). For detailed information regarding the operating voltage minimums and maximums see [Recommended Operating Conditions](#).

The voltage on a pin (except  $V_{inL\pm}$  and  $V_{inQ\pm}$ ), including a transient basis, must not have a voltage that is in excess of the supply voltage or below ground by more than 150 mV. A pin voltage that is higher than the supply or that is below ground can be a problem during start-up and shutdown of power. Ensure that the supplies to circuits driving any of the input pins, analog or digital, do not rise faster than the voltage at the ADC12D1600 power pins.

The values in [Absolute Maximum Ratings](#) must be strictly observed including during power up and power down. A power supply that produces a voltage spike at power turnon, turnoff, or both can destroy the ADC12D1600 device. Many linear regulators produce output spiking at power on unless there is a minimum load provided. Active devices draw very little current until the supply voltages reach a few hundred millivolts. The result can be a turnon spike that destroys the ADC12D1600 device, unless a minimum load is provided for the supply. A 100- $\Omega$  resistor at the regulator output provides a minimum output current during power up to ensure that no turnon spiking occurs. Whether a linear or switching regulator is used, TI recommends using a soft-start circuit to prevent overshoot of the supply.



## 10 Layout

### 10.1 Layout Guidelines

#### 10.1.1 Power Planes

All supply buses for the ADC should be sourced from a common linear voltage regulator. This ensures that all power buses to the ADC are turned on and off simultaneously. This single source will be split into individual sections of the power plane, with individual decoupling and connection to the different power supply buses of the ADC. Due to the low voltage but relatively high supply current requirement, the optimal solution may be to use a switching regulator to provide an intermediate low voltage, which is then regulated down to the final ADC supply voltage by a linear regulator. See the documentation provided for the ADC12D1x00RB for additional details on specific regulators that are recommended for this configuration.

Power for the ADC should be provided through a broad plane which is located on one layer adjacent to the ground planes. Placing the power and ground planes on adjacent layers will provide low impedance decoupling of the ADC supplies, especially at higher frequencies. The output of a linear regulator should feed into the power plane through a low impedance multi-via connection. The power plane should be split into individual power peninsulas near the ADC. Each peninsula should feed a particular power bus on the ADC, with decoupling for that power bus connecting the peninsula to the ground plane near each power/ground pin pair. Using this technique can be difficult on many printed circuit CAD tools. To work around this, 0-Ω resistors can be used to connect the power source net to the individual nets for the different ADC power buses. As a final step, the 0-Ω resistors can be removed and the plane and peninsulas can be connected manually after all other error checking is completed.

#### 10.1.2 Bypass Capacitors

The general recommendation is to have one 100-nF capacitor for each power/ground pin pair. The capacitors should be surface mount multi-layer ceramic chip capacitors similar to Panasonic part number ECJ-0EB1A104K.

#### 10.1.3 Ground Planes

Grounding should be done using continuous full ground planes to minimize the impedance for all ground return paths, and provide the shortest possible image/return path for all signal traces.

#### 10.1.4 Power System Example

The ADC12D1x00RB uses continuous ground planes (except where clear areas are needed to provide appropriate impedance management for specific signals), see [Figure 79](#). Power is provided on one plane, with the 1.9-V ADC supply being split into multiple zones or peninsulas for the specific power buses of the ADC. Decoupling capacitors are connected between these power bus peninsulas and the adjacent ground planes using vias. The capacitors are located as close to the individual power/ground pin pairs of the ADC as possible. In most cases, this means the capacitors are located on the opposite side of the PCB to the ADC.

**Layout Guidelines (continued)**

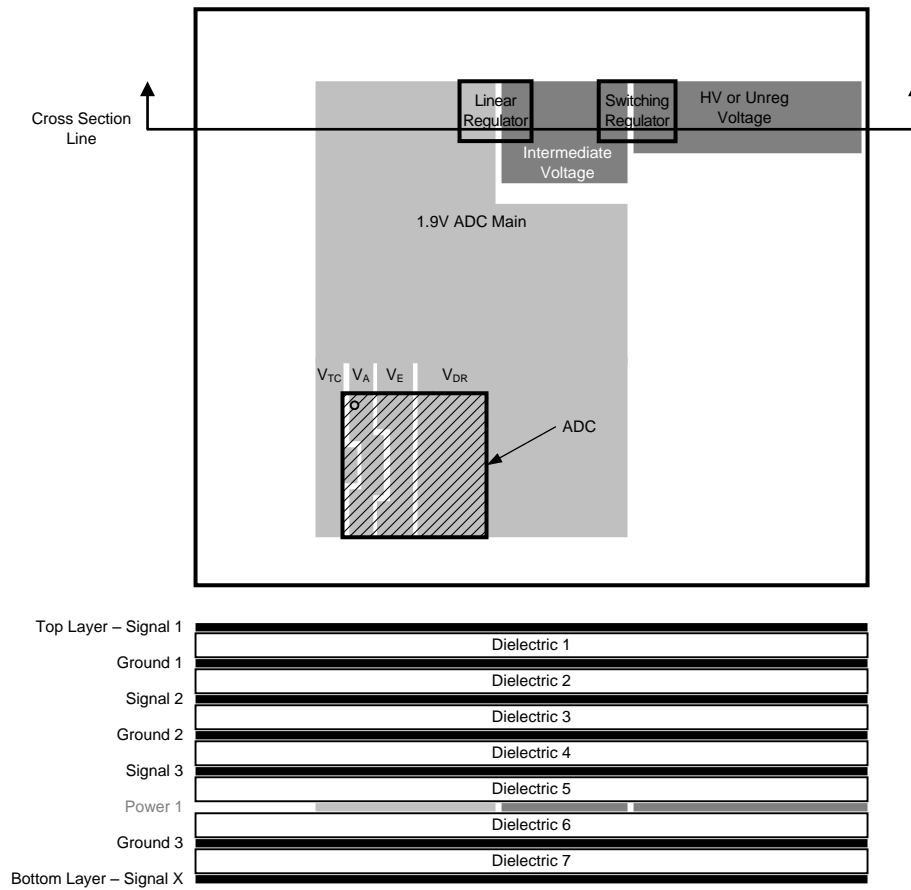

**Figure 79. Power and Grounding Example**

## 10.2 Layout Example

Figure 80 and Figure 81 show layout example plots. Figure 82 shows a typical stackup for a 10-layer board.

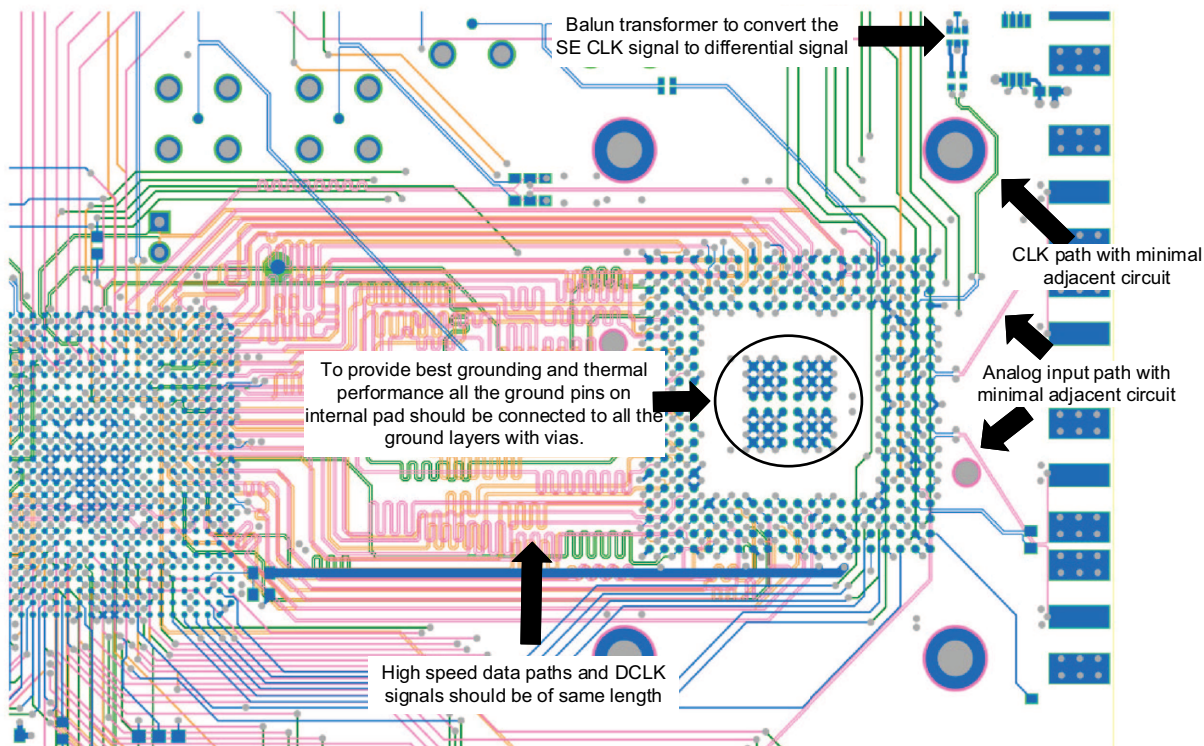

Figure 80. ADC12D1800RF Layout Example 1 – Top Side and Inner Layers

Layout Example (continued)

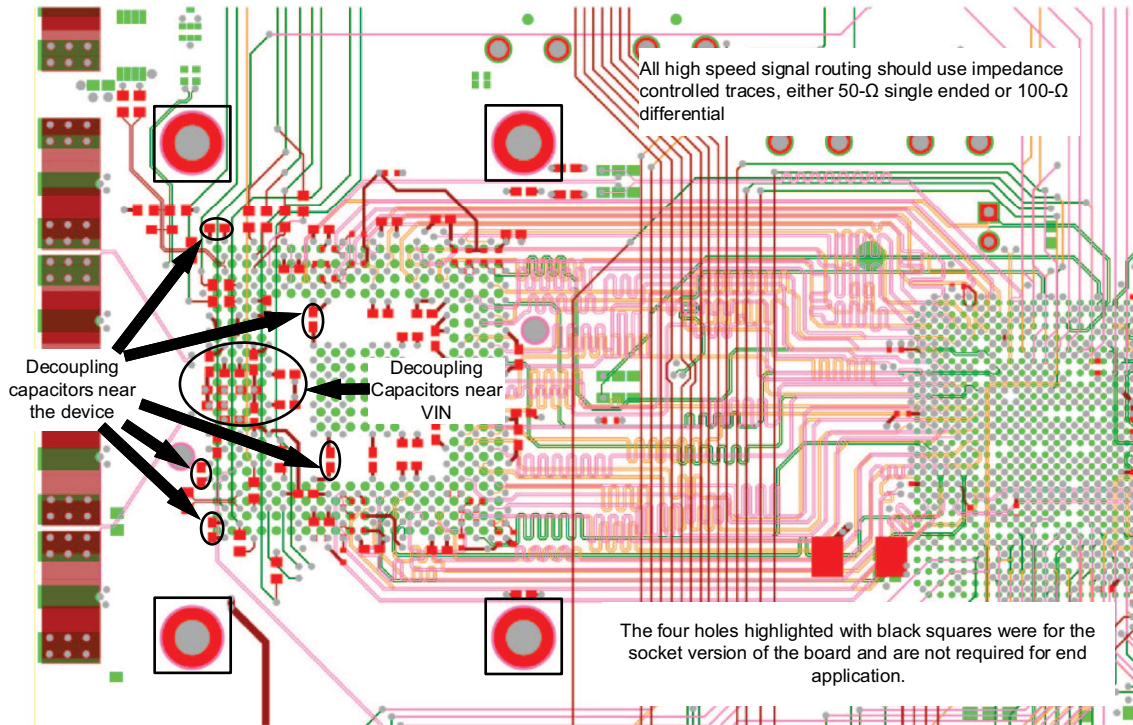

Figure 81. ADC12D1800RF Layout Example 1 – Bottom Side and Inner Layers

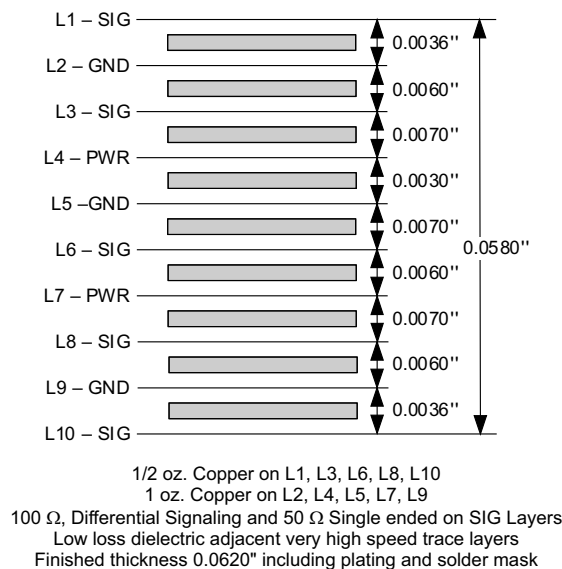
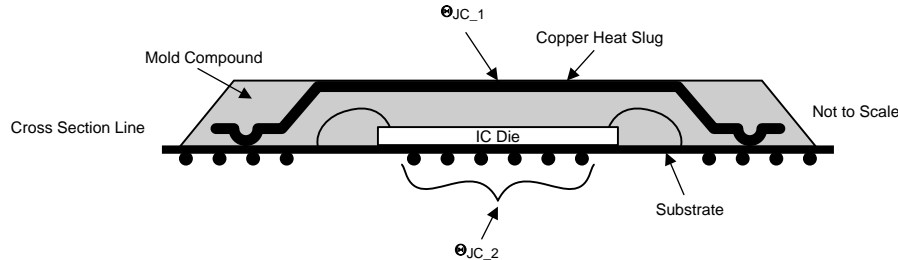

Figure 82. ADC12D1800RF Typical Stackup – 10 Layer Board

### 10.3 Thermal Management

The Heat Slug Ball Grid Array (HSBGA) package is a modified version of the industry standard plastic BGA (Ball Grid Array) package. Inside the package, a copper heat spreader cap is attached to the substrate top with exposed metal in the center top area of the package. This results in a 20% improvement (typical) in thermal performance over the standard plastic BGA package.



**Figure 83. HSBGA Conceptual Drawing**

The center balls are connected to the bottom of the die by vias in the package substrate, [Figure 83](#). This gives a low thermal resistance between the die and these balls. Connecting these balls to the PCB ground planes with a low thermal resistance path is the best way to dissipate the heat from the ADC. These pins should also be connected to the ground plane via a low impedance path for electrical purposes. The direct connection to the ground planes is an easy method to spread heat away from the ADC. Along with the ground plane, the parallel power planes will provide additional thermal dissipation.

The center ground balls should be soldered down to the recommended ball pads (see AN-1126 [[SNOA021](#)]). These balls will have wide traces which in turn have vias which connect to the internal ground planes, and a bottom ground pad/pour if possible. This ensures a good ground is provided for these balls, and that the optimal heat transfer will occur between these balls and the PCB ground planes.

In spite of these package enhancements, analysis using the standard JEDEC JESD51-7 four-layer PCB thermal model shows that ambient temperatures must be limited to 70/77°C to ensure a safe operating junction temperature for the ADC12D1x00. However, most applications using the ADC12D1x00 will have a printed-circuit-board (PCB) which is more complex than that used in JESD51-7. Typical circuit boards will have more layers than the JESD51-7 (eight or more), several of which will be used for ground and power planes. In those applications, the thermal resistance parameters of the ADC12D1x00 and the circuit board can be used to determine the actual safe ambient operating temperature up to a maximum of 85°C.

Three key parameters are provided to allow for modeling and calculations. Because there are two main thermal paths between the ADC die and external environment, the thermal resistance for each of these paths is provided.  $\theta_{JC1}$  represents the thermal resistance between the die and the exposed metal area on the top of the HSBGA package.  $\theta_{JC2}$  represents the thermal resistance between the die and the center group of balls on the bottom of the HSBGA package. The final parameter is the allowed maximum junction temperature,  $T_J$ .

In other applications, a heat sink or other thermally conductive path can be added to the top of the HSBGA package to remove heat. In those cases,  $\theta_{JC1}$  can be used along with the thermal parameters for the heat sink or other thermal coupling added. Representative heat sinks which might be used with the ADC12D1x00 include the Cool Innovations p/n 3-1212XXG and similar products from other vendors. In many applications, the PCB will provide the primary thermal path conducting heat away from the ADC package. In those cases,  $\theta_{JC2}$  can be used in conjunction with PCB thermal modeling software to determine the allowed operating conditions that will maintain the die temperature below the maximum allowable limit. Additional dissipation can be achieved by coupling a heat sink to the copper pour area on the bottom side of the PCB.

Typically, dissipation will occur through one predominant thermal path. In these cases, the following calculations can be used to determine the maximum safe ambient operating temperature for the ADC12D1600, for example:

$$T_J = T_A + P_D \times (\theta_{JC} + \theta_{CA}) \quad (2)$$

$$T_J = T_A + P_{C(MAX)} \times (\theta_{JC} + \theta_{CA}) \quad (3)$$

## Thermal Management (continued)

For  $\theta_{JC}$ , the value for the primary thermal path in the given application environment should be used ( $\theta_{JC1}$  or  $\theta_{JC2}$ ).  $\theta_{CA}$  is the thermal resistance from the case to ambient, which would typically be that of the heat sink used. Using this relationship and the desired ambient temperature, the required heat sink thermal resistance can be found. Alternately, the heat sink thermal resistance can be used to find the maximum ambient temperature. For more complex systems, thermal modeling software can be used to evaluate the PCB system and determine the expected junction temperature given the total system dissipation and ambient temperature.



## 11 Device and Documentation Support

### 11.1 Device Support

#### 11.1.1 Device Nomenclature

##### 11.1.1.1 Specification Definitions

**APERTURE (SAMPLING) DELAY** is the amount of delay, measured from the sampling edge of the CLK input, after which the signal present at the input pin is sampled inside the device.

**APERTURE JITTER ( $t_{AJ}$ )** is the variation in aperture delay from sample-to-sample. Aperture jitter can be effectively considered as noise at the input.

**CODE ERROR RATE (CER)** is the probability of error and is defined as the probable number of word errors on the ADC output per unit of time divided by the number of words seen in that amount of time. A CER of  $10^{-18}$  corresponds to a statistical error in one word about every 31.7 years for the ADC12D1000.

**CLOCK DUTY CYCLE** is the ratio of the time that the clock waveform is at a logic high to the total time of one clock period.

**DIFFERENTIAL NON-LINEARITY (DNL)** is the measure of the maximum deviation from the ideal step size of 1 LSB. It is measured at the relevant sample rate,  $f_{CLK}$ , with  $f_{IN} = 1\text{MHz}$  sine wave.

**EFFECTIVE NUMBER OF BITS (ENOB, or EFFECTIVE BITS)** is another method of specifying Signal-to-Noise and Distortion Ratio, or SINAD. ENOB is defined as  $(\text{SINAD} - 1.76) / 6.02$  and states that the converter is equivalent to a perfect ADC of this many (ENOB) number of bits.

**FULL POWER BANDWIDTH (FPBW)** is a measure of the frequency at which the reconstructed output fundamental drops to 3 dB below its low frequency value for a full-scale input.

**GAIN ERROR** is the deviation from the ideal slope of the transfer function. It can be calculated from Offset and Full-Scale Errors. The Positive Gain Error is the Offset Error minus the Positive Full-Scale Error. The Negative Gain Error is the Negative Full-Scale Error minus the Offset Error. The Gain Error is the Negative Full-Scale Error minus the Positive Full-Scale Error; it is also equal to the Positive Gain Error plus the Negative Gain Error.

**INTEGRAL NON-LINEARITY (INL)** is a measure of worst case deviation of the ADC transfer function from an ideal straight line drawn through the ADC transfer function. The deviation of any given code from this straight line is measured from the center of that code value step. The best fit method is used.

**INTERMODULATION DISTORTION (IMD)** is a measure of the near-in 3rd order distortion products ( $2f_2 - f_1$ ,  $2f_1 - f_2$ ) which occur when two tones which are close in frequency ( $f_1$ ,  $f_2$ ) are applied to the ADC input. It is measured from the input tones level to the higher of the two distortion products (dBc) or simply the level of the higher of the two distortion products (dBFS). The input tones are typically -7dBFS.

**LSB (LEAST SIGNIFICANT BIT)** is the bit that has the smallest value or weight of all bits. This value is

$$V_{FS} / 2^N$$

where

- $V_{FS}$  is the differential full-scale amplitude  $V_{IN\_FSR}$  as set by the FSR input and "N" is the ADC resolution in bits, which is 10 for the ADC12D1x00. (4)

**LOW VOLTAGE DIFFERENTIAL SIGNALING (LVDS) DIFFERENTIAL OUTPUT VOLTAGE ( $V_{ID}$  and  $V_{OD}$ )** is two times the absolute value of the difference between the  $V_{D+}$  and  $V_{D-}$  signals; each signal measured with respect to Ground.  $V_{OD}$  peak is  $V_{OD,P} = (V_{D+} - V_{D-})$  and  $V_{OD}$  peak-to-peak is  $V_{OD,P-P} = 2 * (V_{D+} - V_{D-})$ ; for this product, the  $V_{OD}$  is measured peak-to-peak.

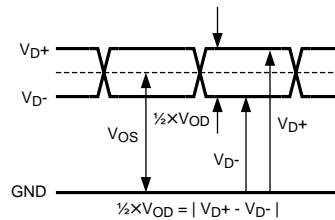
**Device Support (continued)**

**Figure 84. LVDS Output Signal Levels**

**LVDS OUTPUT OFFSET VOLTAGE ( $V_{OS}$ )** is the midpoint between the D+ and D- pins output voltage with respect to ground; that is,  $[(V_{D+}) + (V_{D-})]/2$ . See [Figure 84](#).

**MISSING CODES** are those output codes that are skipped and will never appear at the ADC outputs. These codes cannot be reached with any input value.

**MSB (MOST SIGNIFICANT BIT)** is the bit that has the largest value or weight. Its value is one half of full scale.

**NEGATIVE FULL-SCALE ERROR (NFSE)** is a measure of how far the first code transition is from the ideal 1/2 LSB above a differential  $-V_{IN}/2$  with the FSR pin low. For the ADC12D1x00 the reference voltage is assumed to be ideal, so this error is a combination of full-scale error and reference voltage error.

**NOISE FLOOR DENSITY** is a measure of the power density of the noise floor, expressed in dBFS/Hz and dBm/Hz. '0 dBFS' is defined as the power of a sinusoid which precisely uses the full-scale range of the ADC.

**NOISE POWER RATIO (NPR)** is the ratio of the sum of the power outside the notched bins to the sum of the power in an equal number of bins inside the notch, expressed in dB.

**OFFSET ERROR ( $V_{OFF}$ )** is a measure of how far the mid-scale point is from the ideal zero voltage differential input. Offset Error = Actual Input causing average of 8-k samples to result in an average code of 2047.5.

**OUTPUT DELAY ( $t_{OD}$ )** is the time delay (in addition to Latency) after the rising edge of CLK+ before the data update is present at the output pins.

**OVER-RANGE RECOVERY TIME** is the time required after the differential input voltages goes from  $\pm 1.2$  V to 0 V for the converter to recover and make a conversion with its rated accuracy.

**PIPELINE DELAY (LATENCY)** is the number of input clock cycles between initiation of conversion and when that data is presented to the output driver stage. The data lags the conversion by the Latency plus the  $t_{OD}$ .

**POSITIVE FULL-SCALE ERROR (PFSE)** is a measure of how far the last code transition is from the ideal 1-1/2 LSB below a differential  $+V_{IN}/2$ . For the ADC12D1x00 the reference voltage is assumed to be ideal, so this error is a combination of full-scale error and reference voltage error.

**SIGNAL TO NOISE RATIO (SNR)** is the ratio, expressed in dB, of the rms value of the fundamental for a single-tone to the rms value of the sum of all other spectral components below one-half the sampling frequency, not including harmonics or DC.

**SIGNAL TO NOISE PLUS DISTORTION (S/(N+D) or SINAD)** is the ratio, expressed in dB, of the rms value of the fundamental for a single-tone to the rms value of all of the other spectral components below half the input clock frequency, including harmonics but excluding DC.

**SPURIOUS-FREE DYNAMIC RANGE (SFDR)** is the difference, expressed in dB, between the rms values of the input signal at the output and the peak spurious signal, where a spurious signal is any signal present in the output spectrum that is not present at the input, excluding DC.

$\theta_{JA}$  is the thermal resistance between the junction to ambient.

$\theta_{JC1}$  represents the thermal resistance between the die and the exposed metal area on the top of the HSBGA package.



## Device Support (continued)

$\theta_{JC2}$  represents the thermal resistance between the die and the center group of balls on the bottom of the HSBGA package.

**TOTAL HARMONIC DISTORTION (THD)** is the ratio expressed in dB, of the rms total of the first nine harmonic levels at the output to the level of the fundamental at the output. THD is calculated as

$$\text{THD} = 20 \times \log \sqrt{\frac{A_{f2}^2 + \dots + A_{f10}^2}{A_{f1}^2}}$$

where

- $A_{f1}$  is the RMS power of the fundamental (output) frequency and  $A_{f2}$  through  $A_{f10}$  are the RMS power of the first 9 harmonic frequencies in the output spectrum. (5)

**Second Harmonic Distortion (2nd Harm)** is the difference, expressed in dB, between the RMS power in the input frequency seen at the output and the power in its 2nd harmonic level at the output.

**Third Harmonic Distortion (3rd Harm)** is the difference expressed in dB between the RMS power in the input frequency seen at the output and the power in its 3rd harmonic level at the output.

## 11.2 Documentation Support

### 11.2.1 Related Documentation

For related documentation, see the following:

- *AN-1126 BGA (Ball Grid Array)*, [SNOA021](#)
- *AN-2132 Synchronizing Multiple GSPS ADCs in a System: The AutoSync Feature*, [SNAA073](#)

### 11.3 Related Links

The table below lists quick access links. Categories include technical documents, support and community resources, tools and software, and quick access to sample or buy.

**Table 35. Related Links**

PARTS	PRODUCT FOLDER	SAMPLE & BUY	TECHNICAL DOCUMENTS	TOOLS & SOFTWARE	SUPPORT & COMMUNITY
ADC12D1000	<a href="#">Click here</a>	<a href="#">Click here</a>	<a href="#">Click here</a>	<a href="#">Click here</a>	<a href="#">Click here</a>
ADC12D1600	<a href="#">Click here</a>	<a href="#">Click here</a>	<a href="#">Click here</a>	<a href="#">Click here</a>	<a href="#">Click here</a>

### 11.4 Community Resources

The following links connect to TI community resources. Linked contents are provided "AS IS" by the respective contributors. They do not constitute TI specifications and do not necessarily reflect TI's views; see TI's [Terms of Use](#).

**TI E2E™ Online Community** *TI's Engineer-to-Engineer (E2E) Community*. Created to foster collaboration among engineers. At [e2e.ti.com](http://e2e.ti.com), you can ask questions, share knowledge, explore ideas and help solve problems with fellow engineers.

**Design Support** *TI's Design Support* Quickly find helpful E2E forums along with design support tools and contact information for technical support.

### 11.5 Trademarks

E2E is a trademark of Texas Instruments.  
All other trademarks are the property of their respective owners.

### 11.6 Electrostatic Discharge Caution



These devices have limited built-in ESD protection. The leads should be shorted together or the device placed in conductive foam during storage or handling to prevent electrostatic damage to the MOS gates.

## 11.7 Glossary

[SLYZ022](#) — *TI Glossary*.

This glossary lists and explains terms, acronyms, and definitions.

## 12 Mechanical, Packaging, and Orderable Information

The following pages include mechanical, packaging, and orderable information. This information is the most current data available for the designated devices. This data is subject to change without notice and revision of this document. For browser-based versions of this data sheet, refer to the left-hand navigation.

## PACKAGING INFORMATION

Orderable Device	Status (1)	Package Type	Package Drawing	Pins	Package Qty	Eco Plan (2)	Lead finish/ Ball material (6)	MSL Peak Temp (3)	Op Temp (°C)	Device Marking (4/5)	Samples
ADC12D1000CIUT	ACTIVE	BGA	NXA	292	40	Non-RoHS & Green	Call TI	Level-3-220C-168 HR	-40 to 85	ADC12D1000CIUT	<a href="#">Samples</a>
ADC12D1000CIUT/NOPB	ACTIVE	BGA	NXA	292	40	RoHS & Green	SNAG	Level-3-250C-168 HR	-40 to 85	ADC12D1000CIUT	<a href="#">Samples</a>
ADC12D1600CIUT	ACTIVE	BGA	NXA	292	40	Non-RoHS & Green	Call TI	Level-3-220C-168 HR	-40 to 85	ADC12D1600CIUT	<a href="#">Samples</a>
ADC12D1600CIUT/NOPB	ACTIVE	BGA	NXA	292	40	RoHS & Green	SNAG	Level-3-250C-168 HR	-40 to 85	ADC12D1600CIUT	<a href="#">Samples</a>

(1) The marketing status values are defined as follows:

**ACTIVE:** Product device recommended for new designs.

**LIFEBUY:** TI has announced that the device will be discontinued, and a lifetime-buy period is in effect.

**NRND:** Not recommended for new designs. Device is in production to support existing customers, but TI does not recommend using this part in a new design.

**PREVIEW:** Device has been announced but is not in production. Samples may or may not be available.

**OBSOLETE:** TI has discontinued the production of the device.

(2) **RoHS:** TI defines "RoHS" to mean semiconductor products that are compliant with the current EU RoHS requirements for all 10 RoHS substances, including the requirement that RoHS substance do not exceed 0.1% by weight in homogeneous materials. Where designed to be soldered at high temperatures, "RoHS" products are suitable for use in specified lead-free processes. TI may reference these types of products as "Pb-Free".

**RoHS Exempt:** TI defines "RoHS Exempt" to mean products that contain lead but are compliant with EU RoHS pursuant to a specific EU RoHS exemption.

**Green:** TI defines "Green" to mean the content of Chlorine (Cl) and Bromine (Br) based flame retardants meet JS709B low halogen requirements of <=1000ppm threshold. Antimony trioxide based flame retardants must also meet the <=1000ppm threshold requirement.

(3) MSL, Peak Temp. - The Moisture Sensitivity Level rating according to the JEDEC industry standard classifications, and peak solder temperature.

(4) There may be additional marking, which relates to the logo, the lot trace code information, or the environmental category on the device.

(5) Multiple Device Markings will be inside parentheses. Only one Device Marking contained in parentheses and separated by a "-" will appear on a device. If a line is indented then it is a continuation of the previous line and the two combined represent the entire Device Marking for that device.

(6) Lead finish/Ball material - Orderable Devices may have multiple material finish options. Finish options are separated by a vertical ruled line. Lead finish/Ball material values may wrap to two lines if the finish value exceeds the maximum column width.

**Important Information and Disclaimer:** The information provided on this page represents TI's knowledge and belief as of the date that it is provided. TI bases its knowledge and belief on information provided by third parties, and makes no representation or warranty as to the accuracy of such information. Efforts are underway to better integrate information from third parties. TI has taken and

continues to take reasonable steps to provide representative and accurate information but may not have conducted destructive testing or chemical analysis on incoming materials and chemicals. TI and TI suppliers consider certain information to be proprietary, and thus CAS numbers and other limited information may not be available for release.

In no event shall TI's liability arising out of such information exceed the total purchase price of the TI part(s) at issue in this document sold by TI to Customer on an annual basis.

**TRAY**

Chamfer on Tray corner indicates Pin 1 orientation of packed units.

\*All dimensions are nominal

Device	Package Name	Package Type	Pins	SPQ	Unit array matrix	Max temperature (°C)	L (mm)	W (mm)	K0 (µm)	P1 (mm)	CL (mm)	CW (mm)
ADC12D1000CIUT	NXA	BGA	292	40	4 X 10	150	322.6	135.9	7620	29.2	26.1	24.15
ADC12D1000CIUT/ NOPB	NXA	BGA	292	40	4 X 10	150	322.6	135.9	7620	29.2	26.1	24.15
ADC12D1600CIUT	NXA	BGA	292	40	4 X 10	150	322.6	135.9	7620	29.2	26.1	24.15
ADC12D1600CIUT/ NOPB	NXA	BGA	292	40	4 X 10	150	322.6	135.9	7620	29.2	26.1	24.15

NXA0292A

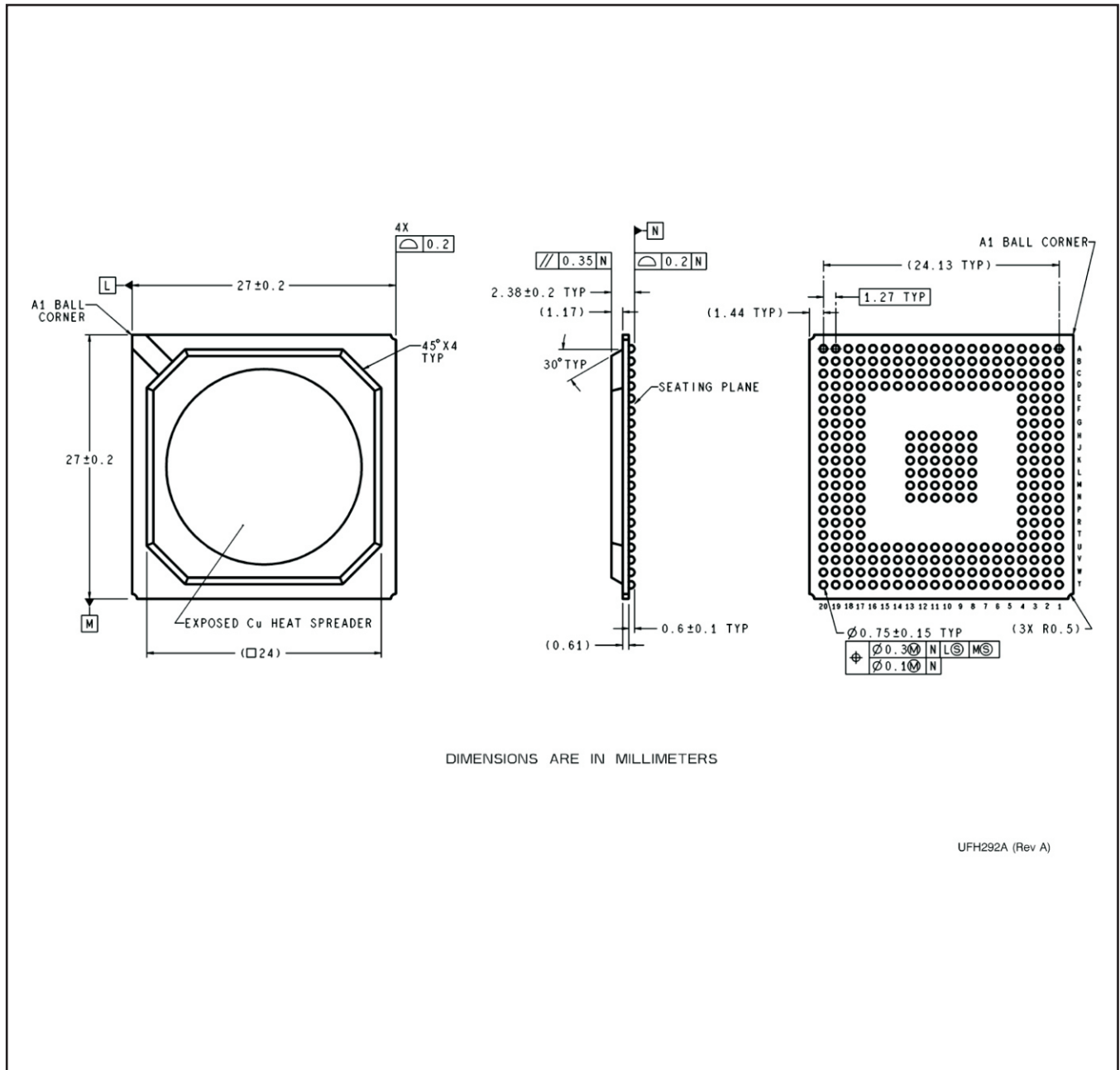

DIMENSIONS ARE IN MILLIMETERS

UFH292A (Rev A)

## IMPORTANT NOTICE AND DISCLAIMER

TI PROVIDES TECHNICAL AND RELIABILITY DATA (INCLUDING DATA SHEETS), DESIGN RESOURCES (INCLUDING REFERENCE DESIGNS), APPLICATION OR OTHER DESIGN ADVICE, WEB TOOLS, SAFETY INFORMATION, AND OTHER RESOURCES "AS IS" AND WITH ALL FAULTS, AND DISCLAIMS ALL WARRANTIES, EXPRESS AND IMPLIED, INCLUDING WITHOUT LIMITATION ANY IMPLIED WARRANTIES OF MERCHANTABILITY, FITNESS FOR A PARTICULAR PURPOSE OR NON-INFRINGEMENT OF THIRD PARTY INTELLECTUAL PROPERTY RIGHTS.

These resources are intended for skilled developers designing with TI products. You are solely responsible for (1) selecting the appropriate TI products for your application, (2) designing, validating and testing your application, and (3) ensuring your application meets applicable standards, and any other safety, security, regulatory or other requirements.

These resources are subject to change without notice. TI grants you permission to use these resources only for development of an application that uses the TI products described in the resource. Other reproduction and display of these resources is prohibited. No license is granted to any other TI intellectual property right or to any third party intellectual property right. TI disclaims responsibility for, and you will fully indemnify TI and its representatives against, any claims, damages, costs, losses, and liabilities arising out of your use of these resources.

TI's products are provided subject to [TI's Terms of Sale](#) or other applicable terms available either on [ti.com](https://www.ti.com) or provided in conjunction with such TI products. TI's provision of these resources does not expand or otherwise alter TI's applicable warranties or warranty disclaimers for TI products.

TI objects to and rejects any additional or different terms you may have proposed.

Mailing Address: Texas Instruments, Post Office Box 655303, Dallas, Texas 75265  
Copyright © 2023, Texas Instruments Incorporated