

CD54/74AC651, CD54/74AC652 CD54/74ACT651, CD54/74ACT652

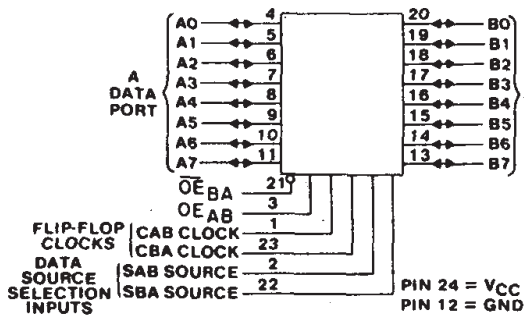

Data sheet acquired from Harris Semiconductor
SCHS294



FUNCTIONAL DIAGRAM

92CS-42677

Octal-Bus Transceiver/Registers, 3-State

CD54/74AC/ACT651 - Inverting
CD54/74AC/ACT652 - Non-Inverting

Type Features:

- Buffered inputs
- Typical propagation delay:
5.3 ns @ $V_{CC} = 5V$, $T_A = 25^\circ C$, $C_L = 50 pF$

The RCA CD54/74AC651 and CD54/74AC652 and the CD54/74ACT651 and CD54/74ACT652 3-state, octal-bus transceiver/registers use the RCA ADVANCED CMOS technology. The CD54/74AC651 and CD54/74ACT651 have inverting outputs. The CD54/74AC652 and CD54/74ACT652 have non-inverting outputs. These devices consist of bus transceiver circuits, D-type flip-flops, and control circuitry arranged for multiplexed transmission of data directly from the data bus or from the internal storage registers. Output Enables OE_{AB} and \overline{OE}_{BA} are provided to control the transceiver functions. SAB and SBA control pins are provided to select whether real-time or stored data is transferred. The circuitry used for select control will eliminate the typical decoding glitch that occurs in a multiplexer during the transition between stored and real-time data. A LOW input level selects real-time data, and a HIGH selects stored data. The following examples demonstrate the four fundamental bus-management functions that can be performed with the octal-bus transceivers and registers.

Data on the A or B data bus, or both, can be stored in the internal D flip-flops by low-to-high transitions at the appropriate clock pins (CAB or CBA) regardless of the select or enable control pins. When SAB and SBA are in the real-time transfer mode, it is also possible to store data without using the internal D-type flip-flops by simultaneously enabling OE_{AB} and \overline{OE}_{BA} . In this configuration, each output reinforces its input. Thus, when all other data sources to the two sets of bus lines are at high impedance, each set of bus lines will remain at its last state.

The CD74AC/ACT651 and CD74AC/ACT652 are supplied in 24-lead dual-in-line narrow-body plastic packages (EN suffix) and in 24-lead dual-in-line small-outline plastic packages (M suffix). Both package types are operable over the following temperature ranges: Commercial (0 to $70^\circ C$); Industrial (-40 to $+85^\circ C$); and Extended Industrial/Military (-55 to $+125^\circ C$).

The CD54AC/ACT651 and CD54AC/ACT652, available in chip form (H suffix), are operable over the -55 to $+125^\circ C$ temperature range.

Family Features:

- Exceeds 2-kV ESD Protection - MIL-STD-883, Method 3015
- SCR-Latchup-resistant CMOS process and circuit design
- Speed of bipolar FAST*/AS/S with significantly reduced power consumption
- Balanced propagation delays
- AC types feature 1.5-V to 5.5-V operation and balanced noise immunity at 30% of the supply
- ± 24 -mA output drive current
 - Fanout to 15 FAST* ICs
 - Drives 50-ohm transmission lines

*FAST is a Registered Trademark of Fairchild Semiconductor Corp.

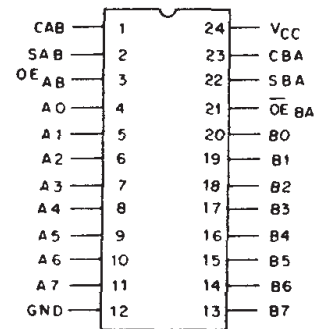

92CS-42678

TERMINAL ASSIGNMENT

This data sheet is applicable to the CD74AC652, CD74ACT651, and CD74ACT652. The CD54/74AC651, CD54AC652, CD54ACT651, and CD54ACT652 were not acquired from Harris Semiconductor.

CD54/74AC651, CD54/74AC652 CD54/74ACT651, CD54/74ACT652

FUNCTION TABLE

OE _{AB} OE _{BA}		INPUTS				DATA I/O		OPERATION OR FUNCTION	
		CAB	CBA	SAB	SBA	A0 THRU A7	B0 THRU B7	651	652
L	H	H or L	H or L	X	X	Input	Input	Isolation*	Isolation*
L	H			X	X	Input	Input	Store A and B Data	Store A and B Data
X	H		H or L	X	X	Input	Unspecified†	Store A, Hold B	Store A, Hold B
H	H			X‡	X	Input	Output	Store A in both registers	Store A in both registers
L	X	H or L		X	X	Unspecified†	Input	Hold A, Store B	Hold, A Store B
L	L			X	X‡	Output	Input	Store B in both registers	Store B in both registers
L	L	X	X	X	L	Output	Input	Real-Time B̄ Data to A Bus	Real-Time B Data to A Bus
L	L	X	H or L	X	H	Output	Input	Stored B̄ Data to A Bus	Stored B Data to A Bus
H	H	X	X	L	X	Input	Output	Real-Time Ā Data to B Bus	Real-Time A Data to B Bus
H	H	H or L	X	H	X	Input	Output	Stored Ā Data to B Bus	Stored A Data to B Bus
H	L	H or L	H or L	H	H	Output	Output	Stored Ā Data to B Bus and Stored B̄ Data to A bus	Stored A Data to B Bus Stored B Data to A Bus

* To prevent excess currents in the High-Z (isolation) modes, all I/O terminals should be terminated with 10kΩ to 1MΩ resistors.

† The data output functions may be enabled or disabled by various signals at the OE_{AB} or OE_{BA} inputs. Data input functions are always enabled, i.e., data at the bus pins will be stored on every low-to-high transition on the clock inputs.

‡ Select control = L: clocks can occur simultaneously.
Select control = H: clocks must be staggered in order to load both registers.

MAXIMUM RATINGS, Absolute-Maximum Values:

- DC SUPPLY-VOLTAGE (V_{CC}) -0.5 to 6 V
- DC INPUT DIODE CURRENT, I_{IK} (for V_I < -0.5 V or V_I > V_{CC} + 0.5 V) ±20 mA
- DC OUTPUT DIODE CURRENT, I_{OK} (for V_O < -0.5 V or V_O > V_{CC} + 0.5 V) ±50 mA
- DC OUTPUT SOURCE OR SINK CURRENT per Output Pin, I_O (for V_O > -0.5 V or V_O < V_{CC} + 0.5 V) ±50 mA
- DC V_{CC} or GROUND CURRENT (I_{CC} or I_{GND}) ±100 mA*
- POWER DISSIPATION PER PACKAGE (P_D):
 - For T_A = -55 to +100°C (PACKAGE TYPE E) 500 mW
 - For T_A = +100 to +125°C (PACKAGE TYPE E) Derate Linearly at 8 mW/°C to 300 mW
 - For T_A = -55 to +70°C (PACKAGE TYPE M) 400 mW
 - For T_A = +70 to +125°C (PACKAGE TYPE M) Derate Linearly at 6 mW/°C to 70 mW
- OPERATING-TEMPERATURE RANGE (T_A) -55 to +125°C
- STORAGE TEMPERATURE (T_{stg}) -65 to +150°C
- LEAD TEMPERATURE (DURING SOLDERING):
 - At distance 1/16 ± 1/32 in. (1.59 ± 0.79 mm) from case for 10 s maximum +265°C
 - Unit inserted into PC board min. thickness 1/16 in. (1.59 mm) with solder contacting lead tips only +300°C

*For up to 4 outputs per device; add ± 25 mA for each additional output.

RECOMMENDED OPERATING CONDITIONS:

For maximum reliability, normal operating conditions should be selected so that operation is always within the following ranges:

CHARACTERISTICS	LIMITS		UNITS
	MIN.	MAX.	
Supply-Voltage Range, V _{CC} *: (For T _A = Full Package-Temperature Range)			
AC Types	1.5	5.5	V
ACT Types	4.5	5.5	V
DC Input or Output Voltage, V _I , V _O	0	V _{CC}	V
Operating Temperature, T _A	-55	+125	°C
Input Rise and Fall Slew Rate, dt/dv			
at 1.5 V to 3 V (AC Types)	0	50	ns/V
at 3.6 V to 5.5 V (AC Types)	0	20	ns/V
at 4.5 V to 5.5 V (ACT Types)	0	10	ns/V

*Unless otherwise specified, all voltages are referenced to ground.



CD54/74AC651, CD54/74AC652 CD54/74ACT651, CD54/74ACT652

STATIC ELECTRICAL CHARACTERISTICS: AC Series

CHARACTERISTICS	TEST CONDITIONS		V _{CC} (V)	AMBIENT TEMPERATURE (T _A) - °C						UNITS
				+25		-40 to +85		-55 to +125		
	V _i (V)	I _o (mA)		MIN.	MAX.	MIN.	MAX.	MIN.	MAX.	
High-Level Input Voltage V _{IH}			1.5	1.2	—	1.2	—	1.2	—	V
			3	2.1	—	2.1	—	2.1	—	
			5.5	3.85	—	3.85	—	3.85	—	
Low-Level Input Voltage V _{IL}			1.5	—	0.3	—	0.3	—	0.3	V
			3	—	0.9	—	0.9	—	0.9	
			5.5	—	1.65	—	1.65	—	1.65	
High-Level Output Voltage V _{OH}	V _{IH} or V _{IL}	-0.05	1.5	1.4	—	1.4	—	1.4	—	V
		-0.05	3	2.9	—	2.9	—	2.9	—	
		-0.05	4.5	4.4	—	4.4	—	4.4	—	
		-4	3	2.58	—	2.48	—	2.4	—	
		-24	4.5	3.94	—	3.8	—	3.7	—	
		#, * }	5.5	—	—	3.85	—	—	—	
Low-Level Output Voltage V _{OL}	V _{IH} or V _{IL}	0.05	1.5	—	0.1	—	0.1	—	0.1	V
		0.05	3	—	0.1	—	0.1	—	0.1	
		0.05	4.5	—	0.1	—	0.1	—	0.1	
		12	3	—	0.36	—	0.44	—	0.5	
		24	4.5	—	0.36	—	0.44	—	0.5	
		#, * }	5.5	—	—	—	1.65	—	—	
Input Leakage Current I _I	V _{CC} or GND		5.5	—	±0.1	—	±1	—	±1	μA
3-State Leakage Current I _{OZ}	V _{IH} or V _{IL} V _O = V _{CC} or GND		5.5	—	±0.5	—	±5	—	±10	μA
Quiescent Supply Current, MSI I _{CC}	V _{CC} or GND	0	5.5	—	8	—	80	—	160	μA

#Test one output at a time for a 1-second maximum duration. Measurement is made by forcing current and measuring voltage to minimize power dissipation.

* Test verifies a minimum 50-ohm transmission-line-drive capability at +85°C, 75 ohms at +125°C.

CD54/74AC651, CD54/74AC652 CD54/74ACT651, CD54/74ACT652

STATIC ELECTRICAL CHARACTERISTICS: ACT Series

CHARACTERISTICS	TEST CONDITIONS		V _{cc} (V)	AMBIENT TEMPERATURE (T _A) - °C						UNITS	
				+25		-40 to +85		-55 to +125			
	V _i (V)	I _o (mA)		MIN.	MAX.	MIN.	MAX.	MIN.	MAX.		
High-Level Input Voltage	V _{IH}		4.5 to 5.5	2	—	2	—	2	—	V	
Low-Level Input Voltage	V _{IL}		4.5 to 5.5	—	0.8	—	0.8	—	0.8	V	
High-Level Output Voltage	V _{OH}	V _{IH} or V _{IL} #,*	-0.05	4.5	4.4	—	4.4	—	4.4	—	V
			-24	4.5	3.94	—	3.8	—	3.7	—	
			-75	5.5	—	—	3.85	—	—	—	
			-50	5.5	—	—	—	—	3.85	—	
Low-Level Output Voltage	V _{OL}	V _{IH} or V _{IL} #,*	0.05	4.5	—	0.1	—	0.1	—	0.1	V
			24	4.5	—	0.36	—	0.44	—	0.5	
			75	5.5	—	—	—	1.65	—	—	
			50	5.5	—	—	—	—	—	1.65	
Input Leakage Current	I _i	V _{cc} or GND	5.5	—	±0.1	—	±1	—	±1	μA	
3-State Leakage Current	I _{oz}	V _{IH} or V _{IL} V _O = V _{cc} or GND	5.5	—	±0.5	—	±5	—	±10	μA	
Quiescent Supply Current, MSI	I _{cc}	V _{cc} or GND	0	5.5	—	8	—	80	—	160	μA
Additional Quiescent Supply Current per Input Pin TTL Inputs High 1 Unit Load	ΔI _{cc}	V _{cc} -2.1	4.5 to 5.5	—	2.4	—	2.8	—	3	mA	

9

#Test one output at a time for a .1-second maximum duration. Measurement is made by forcing current and measuring voltage to minimize power dissipation.

*Test verifies a minimum 50-ohm transmission-line-drive capability at +85°C, 75 ohms at +125°C.

ACT INPUT LOADING TABLE

INPUT	UNIT LOAD*
CAB, CBA	1.25
SAB, SBA	1.2
OE _{AB}	0.67
OE _{BA}	1.17
An, Bn	0.4

*Unit load is ΔI_{cc} limit specified in Static Characteristics Chart, e.g., 2.4 mA max. @ 25°C.

CD54/74AC651, CD54/74AC652 CD54/74ACT651, CD54/74ACT652

PREREQUISITE FOR SWITCHING: AC Series

CHARACTERISTICS	SYMBOL	V _{CC} (V)	AMBIENT TEMPERATURE (T _A) - °C				UNITS
			-40 to +85		-55 to +125		
			MIN.	MAX.	MIN.	MAX.	
Max. Frequency	f _{max}	1.5	11	—	10	—	MHz
		3.3*	101	—	89	—	
		5†	143	—	125	—	
Setup Time Data to Clock	t _{SU}	1.5	27	—	31	—	ns
		3.3	3.1	—	3.5	—	
		5	2.2	—	2.5	—	
Hold Time Data to Clock	t _H	1.5	2	—	2	—	ns
		3.3	2	—	2	—	
		5	2	—	2	—	
Clock Pulse Data to Clock	t _w	1.5	44	—	50	—	ns
		3.3	4.9	—	5.6	—	
		5	3.5	—	4	—	

*3.3 V: min. is @ 3 V

†5 V: min. is @ 4.5 V

SWITCHING CHARACTERISTICS: AC Series; t_r, t_f = 3 ns, C_L = 50 pF

CHARACTERISTICS	SYMBOL	V _{CC} (V)	AMBIENT TEMPERATURE (T _A) - °C				UNITS
			-40 to +85		-55 to +125		
			MIN.	MAX.	MIN.	MAX.	
Propagation Delays: Store A Data to B Bus Store B Data to A Bus 652	t _{PLH} t _{PHL}	1.5	—	154	—	169	ns
		3.3*	4.8	17.1	4.7	18.9	
		5†	3.5	12.3	3.4	13.5	
Store A Data to B Bus Store B Data to A Bus 651	t _{PLH} t _{PHL}	1.5	—	154	—	169	ns
		3.3	4.8	17.1	4.7	18.9	
		5	3.5	12.3	3.4	13.5	
A Data to B Bus B Data to A Bus 652	t _{PLH} t _{PHL}	1.5	—	125	—	138	ns
		3.3	4	14	3.9	15.4	
		5	2.8	10	2.8	11	
A Data to B Bus B Data to A Bus 651	t _{PLH} t _{PHL}	1.5	—	125	—	138	ns
		3.3	4	14	3.9	15.4	
		5	2.8	10	2.8	11	
Select to Data 652	t _{PLH} t _{PHL}	1.5	—	136	—	150	ns
		3.3	4.3	15.3	4.2	16.8	
		5	3.1	10.9	3	12	
Select to Data 651	t _{PLH} t _{PHL}	1.5	—	136	—	150	ns
		3.3	4.3	15.3	4.2	16.8	
		5	3.1	10.9	3	12	
3-State Enabling/ Disabling Time Bus to Output or Register to Output	t _{PZL} t _{PZH} t _{PLZ} t _{PHZ}	1.5	—	154	—	169	ns
		3.3	5.2	18.4	5.1	20.2	
		5	3.5	12.3	3.4	13.5	
Power Dissipation Capacitance	C _{PD} §	—	150 Typ.		150 Typ.		pF
Min. (Valley) During Switching of Other Outputs (Output Under Test Not Switching)	V _{OH} V _{OHV} See Fig. 1	5	4 Typ. @ 25°C				V
Max. (Peak) During Switching of Other Outputs (Output Under Test Not Switching)	V _{OLP} See Fig. 1	5	1 Typ. @ 25°C				V
Input Capacitance	C _I	—	—	10	—	10	pF
3-State Output Capacitance	C _O	—	—	15	—	15	pF

*3.3 V: min. is @ 3.6 V
max. is @ 3 V

†5 V: min. is @ 5.5 V
max. is @ 4.5 V

§C_{PD} is used to determine the dynamic power consumption, per package.

$$P_D = V_{CC}^2 C_{PD} f_i + \sum (V_{CC}^2 C_{L} f_o)$$

where f_i = input frequency
f_o = output frequency
C_L = output load capacitance
V_{CC} = supply voltage.

CD54/74AC651, CD54/74AC652 CD54/74ACT651, CD54/74ACT652

PREREQUISITE FOR SWITCHING: ACT Series

CHARACTERISTICS	SYMBOL	V _{CC} (V)	AMBIENT TEMPERATURE (T _A) - °C				UNITS
			-40 to +85		-55 to +125		
			MIN.	MAX.	MIN.	MAX.	
Max. Frequency	f _{max}	5*	125	—	110	—	MHz
Setup Time Data to Clock	t _{SU}	5	2.2	—	2.5	—	ns
Hold Time Data to Clock	t _H	5	2	—	2	—	ns
Clock Pulse Width	t _w	5	3.9	—	4.5	—	ns

*5 V: min. is @ 4.5 V

SWITCHING CHARACTERISTICS: ACT Series; t_r, t_f = 3 ns, C_L = 50 pF

CHARACTERISTICS	SYMBOL	V _{CC} (V)	AMBIENT TEMPERATURE (T _A) - °C				UNITS
			-40 to +85		-55 to +125		
			MIN.	MAX.	MIN.	MAX.	
Propagation Delays: Store A Data to B Bus Store B Data to A Bus 652	t _{PLH} t _{PHL}	5*	4	14.1	3.9	15.5	ns
Store \bar{A} Data to B Bus Store B Data to A Bus 651	t _{PLH} t _{PHL}	5	4	14.1	3.9	15.5	ns
A Data to B Bus B Data to A Bus 652	t _{PLH} t _{PHL}	5	3.2	11.4	3.1	12.5	ns
\bar{A} Data to B Bus B Data to A Bus 651	t _{PLH} t _{PHL}	5	3.2	11.4	3.1	12.5	ns
Select to Data 652	t _{PLH} t _{PHL}	5	3.7	13.2	3.6	14.5	ns
Select to Data 651	t _{PLH} t _{PHL}	5	4	14.1	3.9	15.5	ns
3-State Enabling/ Disabling Time Bus to Output or Register to Output	t _{PZL} t _{PZH} t _{PLZ} t _{PHZ}	5	4	14.1	3.9	15.5	ns
Power Dissipation Capacitance	C _{PD} §	—	150 Typ.		150 Typ.		pF
Min. (Valley) During Switching of Other Outputs (Output Under Test Not Switching)	V _{OH} V _{OHV} See Fig. 1	5	4 Typ. @ 25°C				V
Max. (Peak) During Switching of Other Outputs (Output Under Test Not Switching)	V _{OL} V _{OLP} See Fig. 1	5	1 Typ. @ 25°C				V
Input Capacitance	C _I	—	—	10	—	10	pF
3-State Output Capacitance	C _O	—	—	15	—	15	pF

*5 V: min. is @ 5.5 V
max. is @ 4.5 V

§C_{PD} is used to determine the dynamic power consumption, per package

$$P_D = V_{CC}^2 C_{PD} f_i + \sum V_{CC}^2 C_L f_o + V_{CC} \Delta I_{CC}$$

where f_i = input frequency
f_o = output frequency
C_L = output load capacitance
V_{CC} = supply voltage.

CD54/74AC651, CD54/74AC652 CD54/74ACT651, CD54/74ACT652

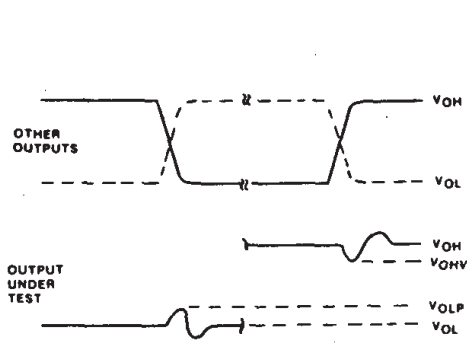

- NOTES:
1. V_{OHV} AND V_{OLP} ARE MEASURED WITH RESPECT TO A GROUND REFERENCE NEAR THE OUTPUT UNDER TEST.
 2. INPUT PULSES HAVE THE FOLLOWING CHARACTERISTICS:
PRR = 1 MHz, $t_r = 3$ ns, $t_f = 3$ ns, SKEW 1 ns.
 3. R.F. FIXTURE WITH 700-MHz DESIGN RULES REQUIRED.
IC SHOULD BE SOLDERED INTO TEST BOARD AND BYPASSED WITH 0.1 μ F CAPACITOR. SCOPE AND PROBES REQUIRE 700-MHz BANDWIDTH.

92CS-42405

Fig. 1 - Simultaneous switching transient waveforms.

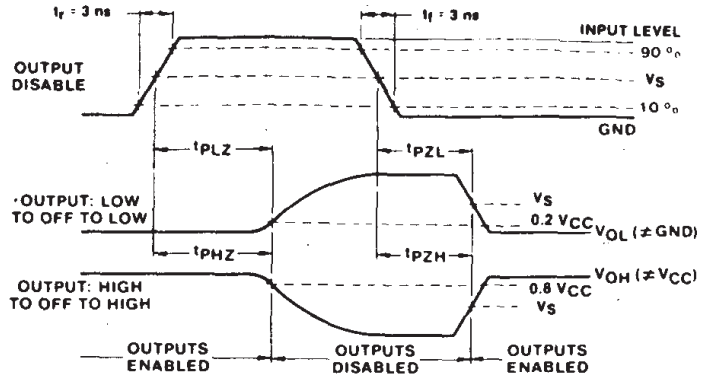

*FOR AC SERIES ONLY: WHEN $V_{CC} = 1.5$ V, $R_L = 1$ k Ω

92CM-42405

Fig. 2 - Three-state propagation delay waveforms and test circuit.

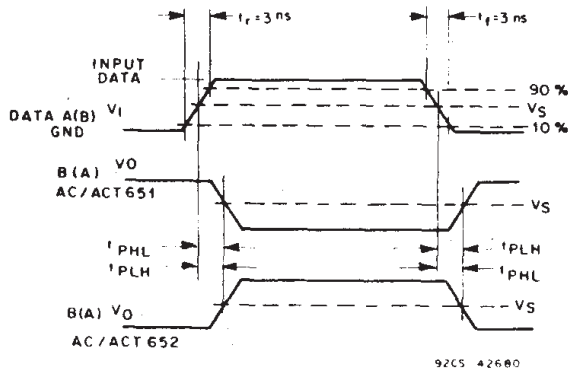

92CS-42680

Fig. 3 - Propagation delay times.

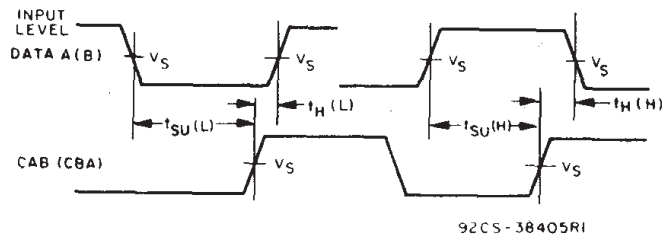

92CS-38405R1

Fig. 4 - Data setup and hold times.

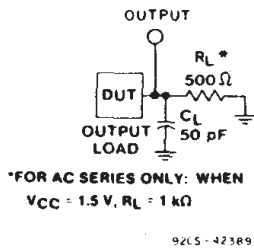

92CS-42389

Fig. 5 - Test circuit.

	CD54/74AC	CD54/74ACT
Input Level	V_{CC}	3 V
Input Switching Voltage, V_S	$0.5 V_{CC}$	1.5 V
Output Switching Voltage, V_S	$0.5 V_{CC}$	$0.5 V_{CC}$

PACKAGING INFORMATION

Orderable part number	Status (1)	Material type (2)	Package Pins	Package qty Carrier	RoHS (3)	Lead finish/ Ball material (4)	MSL rating/ Peak reflow (5)	Op temp (°C)	Part marking (6)
CD74AC652M	Obsolete	Production	SOIC (DW) 24	-	-	Call TI	Call TI	-55 to 125	AC652M
CD74AC652M96	Active	Production	SOIC (DW) 24	2000 LARGE T&R	Yes	NIPDAU	Level-1-260C-UNLIM	-55 to 125	AC652M
CD74AC652M96.A	Active	Production	SOIC (DW) 24	2000 LARGE T&R	Yes	NIPDAU	Level-1-260C-UNLIM	-55 to 125	AC652M
CD74ACT652M	Obsolete	Production	SOIC (DW) 24	-	-	Call TI	Call TI	-55 to 125	ACT652M
CD74ACT652M96	Active	Production	SOIC (DW) 24	2000 LARGE T&R	Yes	NIPDAU	Level-1-260C-UNLIM	-55 to 125	ACT652M
CD74ACT652M96.A	Active	Production	SOIC (DW) 24	2000 LARGE T&R	Yes	NIPDAU	Level-1-260C-UNLIM	-55 to 125	ACT652M

(1) **Status:** For more details on status, see our [product life cycle](#).

(2) **Material type:** When designated, preproduction parts are prototypes/experimental devices, and are not yet approved or released for full production. Testing and final process, including without limitation quality assurance, reliability performance testing, and/or process qualification, may not yet be complete, and this item is subject to further changes or possible discontinuation. If available for ordering, purchases will be subject to an additional waiver at checkout, and are intended for early internal evaluation purposes only. These items are sold without warranties of any kind.

(3) **RoHS values:** Yes, No, RoHS Exempt. See the [TI RoHS Statement](#) for additional information and value definition.

(4) **Lead finish/Ball material:** Parts may have multiple material finish options. Finish options are separated by a vertical ruled line. Lead finish/Ball material values may wrap to two lines if the finish value exceeds the maximum column width.

(5) **MSL rating/Peak reflow:** The moisture sensitivity level ratings and peak solder (reflow) temperatures. In the event that a part has multiple moisture sensitivity ratings, only the lowest level per JEDEC standards is shown. Refer to the shipping label for the actual reflow temperature that will be used to mount the part to the printed circuit board.

(6) **Part marking:** There may be an additional marking, which relates to the logo, the lot trace code information, or the environmental category of the part.

Multiple part markings will be inside parentheses. Only one part marking contained in parentheses and separated by a "~" will appear on a part. If a line is indented then it is a continuation of the previous line and the two combined represent the entire part marking for that device.

Important Information and Disclaimer: The information provided on this page represents TI's knowledge and belief as of the date that it is provided. TI bases its knowledge and belief on information provided by third parties, and makes no representation or warranty as to the accuracy of such information. Efforts are underway to better integrate information from third parties. TI has taken and continues to take reasonable steps to provide representative and accurate information but may not have conducted destructive testing or chemical analysis on incoming materials and chemicals. TI and TI suppliers consider certain information to be proprietary, and thus CAS numbers and other limited information may not be available for release.

In no event shall TI's liability arising out of such information exceed the total purchase price of the TI part(s) at issue in this document sold by TI to Customer on an annual basis.

TAPE AND REEL INFORMATION

QUADRANT ASSIGNMENTS FOR PIN 1 ORIENTATION IN TAPE

*All dimensions are nominal

Device	Package Type	Package Drawing	Pins	SPQ	Reel Diameter (mm)	Reel Width W1 (mm)	A0 (mm)	B0 (mm)	K0 (mm)	P1 (mm)	W (mm)	Pin1 Quadrant
CD74AC652M96	SOIC	DW	24	2000	330.0	24.4	10.75	15.7	2.7	12.0	24.0	Q1
CD74ACT652M96	SOIC	DW	24	2000	330.0	24.4	10.75	15.7	2.7	12.0	24.0	Q1

TAPE AND REEL BOX DIMENSIONS

*All dimensions are nominal

Device	Package Type	Package Drawing	Pins	SPQ	Length (mm)	Width (mm)	Height (mm)
CD74AC652M96	SOIC	DW	24	2000	350.0	350.0	43.0
CD74ACT652M96	SOIC	DW	24	2000	350.0	350.0	43.0

IMPORTANT NOTICE AND DISCLAIMER

TI PROVIDES TECHNICAL AND RELIABILITY DATA (INCLUDING DATA SHEETS), DESIGN RESOURCES (INCLUDING REFERENCE DESIGNS), APPLICATION OR OTHER DESIGN ADVICE, WEB TOOLS, SAFETY INFORMATION, AND OTHER RESOURCES "AS IS" AND WITH ALL FAULTS, AND DISCLAIMS ALL WARRANTIES, EXPRESS AND IMPLIED, INCLUDING WITHOUT LIMITATION ANY IMPLIED WARRANTIES OF MERCHANTABILITY, FITNESS FOR A PARTICULAR PURPOSE OR NON-INFRINGEMENT OF THIRD PARTY INTELLECTUAL PROPERTY RIGHTS.

These resources are intended for skilled developers designing with TI products. You are solely responsible for (1) selecting the appropriate TI products for your application, (2) designing, validating and testing your application, and (3) ensuring your application meets applicable standards, and any other safety, security, regulatory or other requirements.

These resources are subject to change without notice. TI grants you permission to use these resources only for development of an application that uses the TI products described in the resource. Other reproduction and display of these resources is prohibited. No license is granted to any other TI intellectual property right or to any third party intellectual property right. TI disclaims responsibility for, and you will fully indemnify TI and its representatives against, any claims, damages, costs, losses, and liabilities arising out of your use of these resources.

TI's products are provided subject to [TI's Terms of Sale](#) or other applicable terms available either on [ti.com](https://www.ti.com) or provided in conjunction with such TI products. TI's provision of these resources does not expand or otherwise alter TI's applicable warranties or warranty disclaimers for TI products.

TI objects to and rejects any additional or different terms you may have proposed.

Mailing Address: Texas Instruments, Post Office Box 655303, Dallas, Texas 75265

Copyright © 2025, Texas Instruments Incorporated