

DAC63202W I²C、SPI、または PMBus™ インターフェイスの自動検出機能付き (DSBGA パッケージ)、12 ビット、デュアル、電圧および電流出力、スマート D/A コンバータ

1 特長

- 柔軟な構成でプログラム可能な電圧または電流出力:
 - 電圧出力:
 - 1 LSB の DNL
 - 1×、1.5×、2×、3×、4× のゲイン
 - 電流出力:
 - 1 LSB INL および DNL (8 ビット)
 - ±25µA、±50µA、±125µA、±250µA の出力範囲を選択可能
- すべてのチャンネルでコンパレータ・モードにプログラム可能
- VDD オフ時にハイ・インピーダンス出力
- ハイ・インピーダンスおよび抵抗性プルダウンのパワーダウン・モード
- 50MHz、SPI 互換インターフェイス
- I²C、SPI、PMBus™ インターフェイスを自動検出
 - V_{IH}: 1.62V (V_{DD} = 5.5V)
- さまざまな機能に構成可能な汎用入出力 (GPIO)
- あらかじめ定義された波形生成: 正弦波、余弦波、三角波、のこぎり波
- ユーザーがプログラム可能な不揮発性メモリ (NVM)
- 基準電圧として、内部、外部または電源を使用可能
- 幅広い動作範囲:
 - 電源: 1.8V~5.5V
 - 温度: -40°C~+125°C
- 超小型パッケージ:
 - 16 ピン DSBGA: 1.72mm × 1.72mm (公称値)

2 アプリケーション

- 光学モジュール
- 高性能コンピューティング
- 標準的ノート PC

3 説明

DAC63202W は 12 ビット、デュアル・チャンネル、バッファ付き、電圧出力および電流出力のスマート D/A コンバータ (DAC) です。DAC63202W デバイスは、ハイ・インピーダンスのパワーダウン・モードと、電源オフ状態でのハイ・インピーダンス出力をサポートしています。DAC 出力は、プログラマブル・コンパレータおよび電流シンクとして使用するためのフォース・センス・オプションを備えています。このスマート DAC は、多機能 GPIO、機能生成、およびプログラム可能不揮発性メモリ (NVM) によって、プロセッサレス・アプリケーションや設計の再利用を実現できます。I²C、SPI、PMBus インターフェイスを自動的に検出します。また、内部基準電圧を搭載しています。

このスマート DAC は、小型パッケージおよび低消費電力という特長を備えており、電圧マージン設定およびスケールリング、バイアスおよびキャリブレーション用の DC セット・ポイント、波形生成などの用途に最適です。

パッケージ情報

部品番号	パッケージ ⁽¹⁾	本体サイズ (公称)
DAC63202W	YBH (DSBGA, 16)	1.72mm × 1.72mm

- (1) 利用可能なパッケージについては、データシートの末尾にある注釈情報を参照してください。

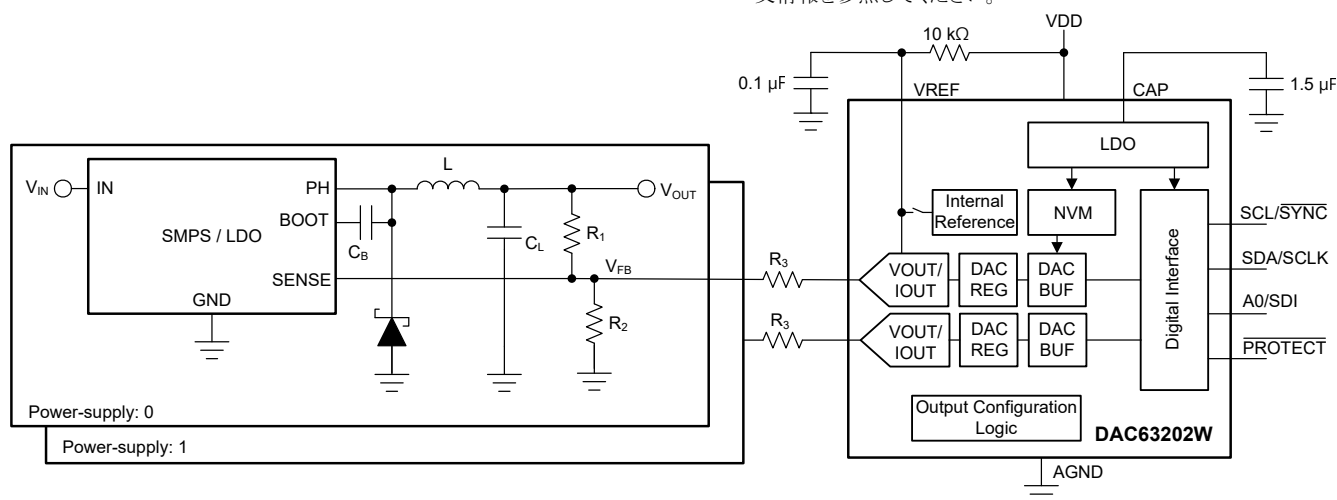

DAC63202W を使用した電圧マージン設定およびスケールリング



Table of Contents

1 特長	1	6.18 Typical Characteristics: Current Output.....	19
2 アプリケーション	1	6.19 Typical Characteristics: Comparator.....	23
3 説明	1	6.20 Typical Characteristics: General.....	24
4 Revision History	2	7 Detailed Description	25
5 Pin Configuration and Functions	3	7.1 Overview.....	25
6 Specifications	4	7.2 Functional Block Diagram.....	25
6.1 Absolute Maximum Ratings.....	4	7.3 Feature Description.....	26
6.2 ESD Ratings.....	4	7.4 Device Functional Modes.....	27
6.3 Recommended Operating Conditions.....	4	7.5 Programming.....	45
6.4 Thermal Information.....	4	7.6 Register Map.....	54
6.5 Electrical Characteristics: Voltage Output.....	5	8 Application and Implementation	72
6.6 Electrical Characteristics: Current Output.....	7	8.1 Application Information.....	72
6.7 Electrical Characteristics: Comparator Mode.....	8	8.2 Typical Application.....	72
6.8 Electrical Characteristics: General.....	9	8.3 Power Supply Recommendations.....	75
6.9 Timing Requirements: I ² C Standard Mode.....	10	8.4 Layout.....	75
6.10 Timing Requirements: I ² C Fast Mode.....	10	9 Device and Documentation Support	77
6.11 Timing Requirements: I ² C Fast Mode Plus.....	10	9.1 Documentation Support.....	77
6.12 Timing Requirements: SPI Write Operation.....	11	9.2 ドキュメントの更新通知を受け取る方法.....	77
6.13 Timing Requirements: SPI Read and Daisy Chain Operation (FSDO = 0).....	11	9.3 サポート・リソース.....	77
6.14 Timing Requirements: SPI Read and Daisy Chain Operation (FSDO = 1).....	11	9.4 Trademarks.....	77
6.15 Timing Requirements: GPIO.....	12	9.5 静電気放電に関する注意事項.....	77
6.16 Timing Diagrams.....	12	9.6 用語集.....	77
6.17 Typical Characteristics: Voltage Output.....	14	10 Mechanical, Packaging, and Orderable Information	77

4 Revision History

資料番号末尾の英字は改訂を表しています。その改訂履歴は英語版に準じています。

DATE	REVISION	NOTES
April 2023	*	Initial Release

5 Pin Configuration and Functions



図 5-1. YBH (16-pin DSBGA) Package, Top View

表 5-1. Pin Functions

PIN		TYPE	DESCRIPTION
NO.	NAME		
A1	VREF	Power	External reference input. Connect a capacitor (approximately 0.1 μF) between VREF and AGND. Use a pullup resistor to VDD when the external reference is not used. This pin must not ramp up before VDD. In case an external reference is used, make sure the reference ramps up after VDD.
A2	OUT0	Output	Analog output voltage from DAC channel 0.
A3	NC	NC	Not connected.
A4	GPIO/SDO	Input/Output	General-purpose input/output configurable as LDAC, PD, PROTECT, RESET, SDO, and STATUS. For STATUS and SDO, connect the pin to the IO voltage with an external pullup resistor. If unused, connect the GPIO pin to VDD or AGND using an external resistor. This pin can ramp up before VDD.
B1	VDD	Power	Supply voltage.
B2	FB0	Input	Voltage feedback pin for channel 0. In voltage-output mode, connect to OUT0 for closed-loop amplifier output. In current-output mode, keep this pin unconnected to minimize leakage current.
B3	NC	NC	Not connected.
B4	SCL/SYNC	Output	I ² C serial interface clock or SPI chip select input. This pin must be connected to the IO voltage using an external pullup resistor. This pin can ramp up before VDD.
C1	AGND	Ground	Ground reference point for all circuitry on the device.
C2	FB1	Input	Voltage feedback pin for channel 1. In voltage-output mode, connect to OUT1 for closed-loop amplifier output. In current-output mode, keep this pin unconnected to minimize leakage current.
C3	NC	NC	Not connected.
C4	A0/SDI	Input	Address configuration pin for I ² C or serial data input for SPI. For A0, connect this pin to VDD, AGND, SDA, or SCL for address configuration (セクション 7.5.2.2.1). For SDI, this pin need not be pulled up or pulled down. This pin can ramp up before VDD.
D1	CAP	Power	External bypass capacitor for the internal LDO. Connect a capacitor (approximately 1.5 μF) between CAP and AGND.
D2	OUT1	Output	Analog output voltage from DAC channel 01
D3	NC	NC	Not connected.
D4	SDA/SCLK	Input/Output	Bidirectional I ² C serial data bus or SPI clock input. This pin must be connected to the IO voltage using an external pullup resistor in the I ² C mode. This pin can ramp up before VDD.

6 Specifications

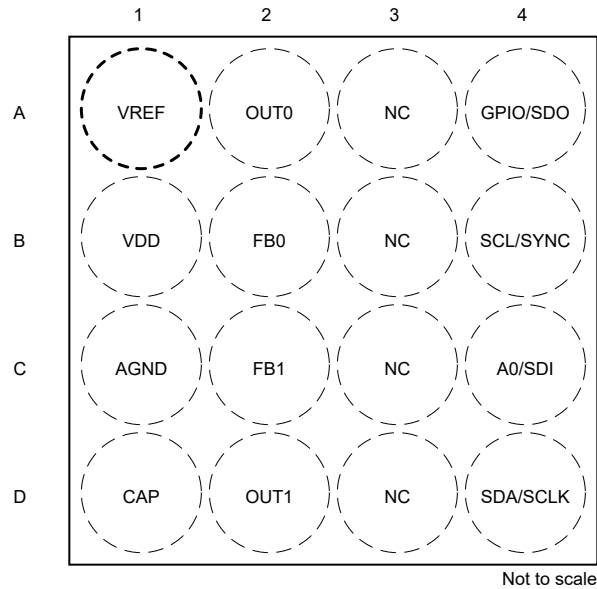
6.1 Absolute Maximum Ratings

over operating free-air temperature range (unless otherwise noted)⁽¹⁾

		MIN	MAX	UNIT
V _{DD}	Supply voltage, V _{DD} to AGND	-0.3	6	V
	Digital inputs to AGND	-0.3	V _{DD} + 0.3	V
	V _{FBX} to AGND	-0.3	V _{DD} + 0.3	V
	V _{OUTX} to AGND	-0.3	V _{DD} + 0.3	V
V _{REF}	External reference, V _{REF} to AGND	-0.3	V _{DD} + 0.3	V
	Current into any pin except the OUTx, VDD, and AGND pins	-10	10	mA
T _J	Junction temperature	-40	150	°C
T _{stg}	Storage temperature	-65	150	°C

- (1) Operation outside the Absolute Maximum Ratings may cause permanent device damage. Absolute Maximum Ratings do not imply functional operation of the device at these or any other conditions beyond those listed under Recommended Operating Conditions. If used outside the Recommended Operating Conditions but within the Absolute Maximum Ratings, the device may not be fully functional, and this may affect device reliability, functionality, performance, and shorten the device lifetime.

6.2 ESD Ratings

			VALUE	UNIT
V _(ESD)	Electrostatic discharge	Human body model (HBM), per ANSI/ESDA/JEDEC JS-001, all pins ⁽¹⁾	±2000	V
		Charged device model (CDM), per ANSI/ESDA/JEDEC JS-002, all pins ⁽²⁾	±500	

- (1) JEDEC document JEP155 states that 500-V HBM allows safe manufacturing with a standard ESD control process.
 (2) JEDEC document JEP157 states that 250-V CDM allows safe manufacturing with a standard ESD control process.

6.3 Recommended Operating Conditions

over operating free-air temperature range (unless otherwise noted)

		MIN	NOM	MAX	UNIT
V _{DD}	Positive supply voltage to ground (AGND)	1.7		5.5	V
V _{REF}	External reference to ground (AGND)	1.7		V _{DD}	V
V _{IH}	Digital input high voltage, 1.7 V < V _{DD} ≤ 5.5 V	1.62			V
V _{IL}	Digital input low voltage			0.4	V
C _{CAP}	External capacitor on CAP pin	0.5		15	µF
T _A	Ambient temperature	-40		125	°C

6.4 Thermal Information

THERMAL METRIC ⁽¹⁾		DAC63202W		UNIT
		YBH (DSBGA)		
		16 PINS		
R _{θJA}	Junction-to-ambient thermal resistance	80.2		°C/W
R _{θJC(top)}	Junction-to-case (top) thermal resistance	0.4		°C/W
R _{θJB}	Junction-to-board thermal resistance	18.8		°C/W
Ψ _{JT}	Junction-to-top characterization parameter	0.2		°C/W
Ψ _{JB}	Junction-to-board characterization parameter	18.8		°C/W

- (1) For information about traditional and new thermal metrics, see the [Semiconductor and IC Package Thermal Metrics application report](#).

6.5 Electrical Characteristics: Voltage Output

all minimum/maximum specifications at $-40^{\circ}\text{C} \leq T_A \leq +125^{\circ}\text{C}$ and typical specifications at $T_A = 25^{\circ}\text{C}$, $1.7\text{ V} \leq V_{DD} \leq 5.5\text{ V}$, DAC reference tied to VDD, gain = 1 ×, DAC output pin (OUT) loaded with resistive load ($R_L = 5\text{ k}\Omega$ to AGND) and capacitive load ($C_L = 200\text{ pF}$ to AGND), and digital inputs at VDD or AGND (unless otherwise noted)

PARAMETER		TEST CONDITIONS	MIN	TYP	MAX	UNIT
STATIC PERFORMANCE						
	Resolution		12			Bits
INL	Integral nonlinearity ⁽¹⁾		-5		5	LSB
DNL	Differential nonlinearity ⁽¹⁾		-1		1	LSB
	Zero-code error ⁽⁴⁾	Code 0d into DAC, external reference, $V_{DD} = 5.5\text{ V}$		6	12	mV
		Code 0d into DAC, internal V_{REF} , gain = 4 ×, $V_{DD} = 5.5\text{ V}$		6	15	
	Zero-code error temperature coefficient ⁽⁴⁾			±10		μV/°C
	Offset error ^{(4) (6)}	$1.7\text{ V} \leq V_{DD} < 2.7\text{ V}$, V_{FB} pin shorted to V_{OUT} , DAC code: 32d	-0.75	0.3	0.75	%FSR
		$2.7\text{ V} \leq V_{DD} \leq 5.5\text{ V}$, V_{FB} pin shorted to V_{OUT} , DAC code: 32d	-0.5	0.25	0.5	
	Offset-error temperature coefficient ⁽⁴⁾	V_{FB} pin shorted to V_{OUT} , DAC code: 32d		±0.0003		%FSR/°C
	Gain error ⁽⁴⁾	Between end-point codes: 32d to 4064d	-0.5	0.25	0.5	%FSR
	Gain-error temperature coefficient ⁽⁴⁾	Between end-point codes: 32d to 4064d		±0.0008		%FSR/°C
	Full-scale error ^{(4) (6)}	$1.7\text{ V} \leq V_{DD} < 2.7\text{ V}$, DAC at full-scale	-1		1	%FSR
		$2.7\text{ V} \leq V_{DD} \leq 5.5\text{ V}$, DAC at full-scale	-0.5		0.5	
	Full-scale-error temperature coefficient ⁽⁴⁾	DAC at full-scale		±0.0008		%FSR/°C
OUTPUT						
	Output voltage	Reference tied to V_{DD}	0		V_{DD}	V
C_L	Capacitive load ⁽²⁾	$R_L = \text{infinite}$, phase margin = 30°			200	pF
		Phase margin = 30°			1000	
	Short-circuit current	$V_{DD} = 1.7\text{ V}$, full-scale output shorted to AGND or zero-scale output shorted to V_{DD}		15		mA
		$V_{DD} = 2.7\text{ V}$, full-scale output shorted to AGND or zero-scale output shorted to V_{DD}		50		
		$V_{DD} = 5.5\text{ V}$, full-scale output shorted to AGND or zero-scale output shorted to V_{DD}		60		
	Output-voltage headroom ⁽²⁾	To V_{DD} (DAC output unloaded, internal reference = 1.21 V), $V_{DD} \geq 1.21\text{ V} \times \text{gain} + 0.2\text{ V}$	0.2			%FSR
		To V_{DD} and to AGND (DAC output unloaded, external reference at V_{DD} (gain = 1 ×), the V_{REF} pin is not shorted to V_{DD})	0.8			
		To V_{DD} and to AGND ($I_{LOAD} = 10\text{ mA}$ at $V_{DD} = 5.5\text{ V}$, $I_{LOAD} = 3\text{ mA}$ at $V_{DD} = 2.7\text{ V}$, $I_{LOAD} = 1\text{ mA}$ at $V_{DD} = 1.8\text{ V}$), external reference at V_{DD} (gain = 1 ×), the V_{REF} pin is not shorted to V_{DD})	10			
Z_O	V_{FB} dc output impedance ⁽³⁾	DAC output enabled, internal reference (gain = 1.5 × or 2 ×) or external reference at V_{DD} (gain = 1 ×), the V_{REF} pin is not shorted to V_{DD}	400	500	600	kΩ
		DAC output enabled, internal V_{REF} , gain = 3 × or 4 ×	325	400	485	
	Power supply rejection ratio (dc)	Internal V_{REF} , gain = 2 ×, DAC at midscale, $V_{DD} = 5\text{ V} \pm 10\%$		0.25		mV/V

6.5 Electrical Characteristics: Voltage Output (continued)

all minimum/maximum specifications at $-40^{\circ}\text{C} \leq T_A \leq +125^{\circ}\text{C}$ and typical specifications at $T_A = 25^{\circ}\text{C}$, $1.7\text{ V} \leq V_{DD} \leq 5.5\text{ V}$, DAC reference tied to VDD, gain = 1 ×, DAC output pin (OUT) loaded with resistive load ($R_L = 5\text{ k}\Omega$ to AGND) and capacitive load ($C_L = 200\text{ pF}$ to AGND), and digital inputs at VDD or AGND (unless otherwise noted)

PARAMETER		TEST CONDITIONS	MIN	TYP	MAX	UNIT
DYNAMIC PERFORMANCE						
t_{sett}	Output voltage settling time	1/4 to 3/4 scale and 3/4 to 1/4 scale settling to 10%FSR, $V_{DD} = 5.5\text{ V}$		20		μs
		1/4 to 3/4 scale and 3/4 to 1/4 scale settling to 10%FSR, $V_{DD} = 5.5\text{ V}$, internal V_{REF} , gain = 4 ×		25		
	Slew rate	$V_{DD} = 5.5\text{ V}$		0.3		$\text{V}/\mu\text{s}$
	Power-on glitch magnitude	At start-up (DAC output disabled)		75		mV
		At start-up (DAC output disabled), $R_L = 100\text{ k}\Omega$		200		
	Output-enable glitch magnitude	DAC output disabled to enabled (DAC registers at zero scale), $R_L = 100\text{ k}\Omega$		250		mV
V_n	Output noise voltage (peak to peak)	$f = 0.1\text{ Hz}$ to 10 Hz , DAC at midscale, $V_{DD} = 5.5\text{ V}$		50		μV_{PP}
		Internal V_{REF} , gain = 4 ×, $f = 0.1\text{ Hz}$ to 10 Hz , DAC at midscale, $V_{DD} = 5.5\text{ V}$		90		
	Output noise density	$f = 1\text{ kHz}$, DAC at midscale, $V_{DD} = 5.5\text{ V}$		0.35		$\mu\text{V}/\sqrt{\text{Hz}}$
		Internal V_{REF} , gain = 4 ×, $f = 1\text{ kHz}$, DAC at midscale, $V_{DD} = 5.5\text{ V}$		0.9		
	Power supply rejection ratio (ac) ⁽³⁾	Internal V_{REF} , gain = 4 ×, 200-mV 50-Hz or 60-Hz sine wave superimposed on power supply voltage, DAC at midscale		-68		dB
	Code change glitch impulse	± 1 LSB change around midscale (including feedthrough)		10		nV-s
	Code change glitch impulse magnitude	± 1 LSB change around midscale (including feedthrough)		15		mV
POWER						
I_{DD}	Current flowing into VDD ⁽⁴⁾ ⁽⁵⁾	Normal operation, DACs at full scale, digital pins static, external reference at V_{DD} but the V_{REF} pin is not shorted to V_{DD}		150		$\mu\text{A}/\text{ch}$

- (1) Measured with DAC output unloaded. For external reference and internal reference $V_{DD} \geq 1.21 \times \text{gain} + 0.2\text{ V}$, between end-point codes: 32d to 4064d.
- (2) Specified by design and characterization, not production tested.
- (3) Specified with 200-mV headroom with respect to reference value when internal reference is used.
- (4) Measured with DAC output unloaded.
- (5) The total power consumption is calculated by $I_{DD} \times (\text{total number of channels powered on}) + (\text{sleep-mode current})$.
- (6) When a DAC channel is configured in IOUT mode for long term and then switched to VOUT mode, the VOUT mode can show parametric drift.

6.6 Electrical Characteristics: Current Output

all minimum/maximum specifications at $-40^{\circ}\text{C} \leq T_A \leq +125^{\circ}\text{C}$ and typical specifications at $T_A = 25^{\circ}\text{C}$, $1.7\text{ V} \leq V_{DD} \leq 5.5\text{ V}$, $\pm 250\text{-}\mu\text{A}$ output range, and digital inputs at VDD or AGND (unless otherwise noted)

PARAMETER		TEST CONDITIONS	MIN	TYP	MAX	UNIT
STATIC PERFORMANCE						
	Resolution		8			Bits
INL	Integral nonlinearity	DAC codes between 0d and 255d	-1		1	LSB
DNL	Differential nonlinearity	DAC codes between 0d and 255d	-1		1	LSB
	Offset error	DAC output ranges: $\pm 25\ \mu\text{A}$, $\pm 50\ \mu\text{A}$, $\pm 125\ \mu\text{A}$, and $\pm 250\ \mu\text{A}$; DAC at midscale		± 1		%FSR
	Gain error	DAC output ranges: $\pm 25\ \mu\text{A}$, $\pm 50\ \mu\text{A}$, $\pm 125\ \mu\text{A}$, and $\pm 250\ \mu\text{A}$; DAC codes between 0d and 255d		± 1.3		%FSR
OUTPUT						
	Output compliance voltage ⁽¹⁾	DAC output ranges: $\pm 25\ \mu\text{A}$, $\pm 50\ \mu\text{A}$, $\pm 125\ \mu\text{A}$, and $\pm 250\ \mu\text{A}$; to V_{DD} and to AGND	400			mV
Z_O	I_{OUT} dc output impedance ⁽²⁾	DAC at midscale, DAC output kept at $V_{DD}/2$	60			M Ω
	Power supply rejection ratio (dc)	DAC at midscale, all bipolar ranges, V_{DD} changed from 4.5V to 5.5V		0.23		LSB/V
DYNAMIC PERFORMANCE						
t_{sett}	Output current settling time	1/4 to 3/4 scale and 3/4 to 1/4 scale settling to 1 LSB at 8-bit resolution, $V_{DD} = 5.5\text{ V}$, common-mode voltage at OUTx pin is $V_{DD}/2$		60		μs
V_n	Output noise current (peak to peak)	0.1 Hz to 10 Hz, DAC at midscale, $V_{DD} = 5.5\text{ V}$, $\pm 250\text{-}\mu\text{A}$ output range		150		nA _{pp}
	Output noise density	$f = 1\text{ kHz}$, DAC at midscale, $V_{DD} = 5.5\text{ V}$, $\pm 250\text{-}\mu\text{A}$ output range		1		nA/ $\sqrt{\text{Hz}}$
	Power supply rejection ratio (ac) ⁽³⁾	$\pm 250\text{-}\mu\text{A}$ output range, 200-mV 50-Hz or 60-Hz sine wave superimposed on power-supply voltage, DAC at midscale		0.65		LSB/V
POWER						
I_{DD}	Current flowing into VDD ^{(3) (4)}	Normal operation, DACs at full scale, $\pm 25\text{-}\mu\text{A}$ output range, digital pins static		42	50	$\mu\text{A}/\text{ch}$
		Normal operation, DACs at full scale, $\pm 50\text{-}\mu\text{A}$ output range, digital pins static		56	70	
		Normal operation, DACs at full scale, $\pm 125\text{-}\mu\text{A}$ output range, digital pins static		98	120	
		Normal operation, DACs at full scale, $\pm 250\text{-}\mu\text{A}$ output range, digital pins static		167	200	

(1) Measured between DAC codes 0d and 255d.

(2) Specified by design and characterization, not production tested.

(3) The current flowing into V_{DD} does not account for the load current sourced or sink on the OUTx pins. The V_{REF} pin is connected to V_{DD} .

(4) The total power consumption is calculated by $I_{DD} \times (\text{total number of channels powered on}) + (\text{sleep-mode current})$.

6.7 Electrical Characteristics: Comparator Mode

all minimum/maximum specifications at $-40^{\circ}\text{C} \leq T_A \leq +125^{\circ}\text{C}$ and typical specifications at $T_A = 25^{\circ}\text{C}$, $1.7\text{ V} \leq V_{DD} \leq 5.5\text{ V}$, DAC reference tied to VDD, gain = 1x in voltage output mode, DAC output pin (OUT) loaded with resistive load ($R_L = 5\text{ k}\Omega$ to AGND) and capacitive load ($C_L = 200\text{ pF}$ to AGND), and digital inputs at VDD or AGND (unless otherwise noted)

PARAMETER		TEST CONDITIONS	MIN	TYP	MAX	UNIT
STATIC PERFORMANCE						
	Offset error ^{(1) (2)}	$1.7\text{ V} \leq V_{DD} \leq 5.5\text{ V}$; DAC at midscale, comparator input at Hi-Z, and DAC operating with external reference.	-6	0	6	mV
	Offset error time drift ⁽¹⁾	$V_{DD} = 5.5\text{ V}$, external reference, $T_A = 125^{\circ}\text{C}$, FB in Hi-Z mode, DAC at full scale and V_{FB} at 0 V or DAC at zero scale and V_{FB} at 1.84 V, drift specified for 10 years of continuous operation		4		mV
OUTPUT						
	Input voltage	V_{REF} connected to V_{DD} , V_{FB} resistor network connected to ground	0		V_{DD}	V
		V_{REF} connected to V_{DD} , V_{FB} resistor network disconnected from ground	0		V_{DD} (1/3 – 1/100)	
V_{OL}	Logic low output voltage	$I_{LOAD} = 100\text{ }\mu\text{A}$, output in open-drain mode		0.1		V
DYNAMIC PERFORMANCE						
t_{resp}	Output response time	DAC at midscale with 10-bit resolution, FB input at Hi-Z, and transition step at FB node is ($V_{DAC} - 2\text{ LSB}$) to ($V_{DAC} + 2\text{ LSB}$), transition time measured between 10% and 90% of output, output current of 100 μA , comparator output configured in push-pull mode, load capacitor at DAC output is 25 pF		10		μs

(1) Specified by design and characterization, not production tested.

(2) This specification does not include the total unadjusted error (TUE) of the DAC.

6.8 Electrical Characteristics: General

all minimum/maximum specifications at $-40^{\circ}\text{C} \leq T_A \leq +125^{\circ}\text{C}$ and typical specifications at $T_A = 25^{\circ}\text{C}$, $1.7\text{ V} \leq V_{DD} \leq 5.5\text{ V}$, DAC reference tied to VDD, gain = 1 × in voltage output mode or $\pm 250\text{-}\mu\text{A}$ output range in current output mode, DAC output pin (OUT) loaded with resistive load ($R_L = 5\text{ k}\Omega$ to AGND) in voltage-output mode and capacitive load ($C_L = 200\text{ pF}$ to AGND), and digital inputs at VDD or AGND (unless otherwise noted)

PARAMETER		TEST CONDITIONS	MIN	TYP	MAX	UNIT
INTERNAL REFERENCE						
	Initial accuracy	$T_A = 25^{\circ}\text{C}$	1.1979	1.212	1.224	V
	Reference output temperature coefficient ^{(1) (2)}				50	ppm/ $^{\circ}\text{C}$
EXTERNAL REFERENCE						
	V_{REF} input impedance ^{(1) (3)}			192		k Ω /ch
EEPROM						
	Endurance ⁽¹⁾	$-40^{\circ}\text{C} \leq T_A \leq +85^{\circ}\text{C}$		20000		Cycles
		$T_A = 125^{\circ}\text{C}$		1000		
	Data retention ⁽¹⁾	$T_A = 25^{\circ}\text{C}$		50		Years
	EEPROM programming write cycle time ⁽¹⁾				200	ms
	Device boot-up time ⁽¹⁾	Time taken from power valid ($V_{DD} \geq 1.7\text{ V}$) to output valid state as programmed in EEPROM), 0.5- μF capacitor on the CAP pin		5		ms
DIGITAL INPUTS						
	Digital feedthrough	Voltage output mode, DAC output static at midscale, fast mode plus, SCL toggling		20		nV-s
I_{DD}	Current flowing into VDD	DAC in sleep mode, internal reference powered down, external reference at 5.5 V			28	μA
I_{DD}	Current flowing into VDD ⁽¹⁾	DAC in sleep mode, internal reference enabled, additional current through internal reference		10		μA
I_{DD}	Current flowing into VDD ⁽¹⁾	DAC channels enabled, internal reference enabled, additional current through internal reference per DAC channel in voltage-output mode		12.5		μA
	Pin capacitance	Per pin		10		pF
POWER-DOWN MODE						
HIGH-IMPEDANCE OUTPUT						
I_{LEAK}	Current flowing into V_{OUTX} and V_{FBX}	DAC in Hi-Z output mode, $1.7\text{ V} \leq V_{DD} \leq 5.5\text{ V}$		10		nA
		$V_{DD} = 0\text{ V}$, $V_{OUT} \leq 1.5\text{ V}$, decoupling capacitor between V_{DD} and AGND = 0.1 μF		200		nA
		$V_{DD} = 0\text{ V}$, $1.5\text{ V} < V_{OUT} \leq 5.5\text{ V}$, decoupling capacitor between V_{DD} and AGND = 0.1 μF		500		nA
		100 k Ω between V_{DD} and AGND, $V_{OUT} \leq 1.25\text{ V}$, series resistance of 10 k Ω at OUT pin		± 2		μA

- (1) Specified by design and characterization, not production tested.
(2) Measured at -40°C and $+125^{\circ}\text{C}$ and calculated the slope.
(3) Impedances for the DAC channels are connected in parallel.

6.9 Timing Requirements: I²C Standard Mode

all input signals are timed from VIL to 70% of $V_{pull-up}$, $1.7\text{ V} \leq V_{DD} \leq 5.5\text{ V}$, $-40^{\circ}\text{C} \leq T_A \leq +125^{\circ}\text{C}$, and $1.7\text{ V} \leq V_{pull-up} \leq V_{DD}\text{ V}$

		MIN	NOM	MAX	UNIT
f _{SCLK}	SCL frequency			100	kHz
t _{BUF}	Bus free time between stop and start conditions	4.7			μs
t _{HDSTA}	Hold time after repeated start	4			μs
t _{SUSTA}	Repeated start setup time	4.7			μs
t _{SUSTO}	Stop condition setup time	4			μs
t _{HDDAT}	Data hold time	0			ns
t _{SUDAT}	Data setup time	250			ns
t _{LOW}	SCL clock low period	4700			ns
t _{HIGH}	SCL clock high period	4000			ns
t _F	Clock and data fall time			300	ns
t _R	Clock and data rise time			1000	ns
t _{VDDAT}	Data valid time, R = 360 Ω, C _{trace} = 23 pF, C _{probe} = 10 pF			3.45	μs
t _{VDACK}	Data valid acknowledge time, R = 360 Ω, C _{trace} = 23 pF, C _{probe} = 10 pF			3.45	μs

6.10 Timing Requirements: I²C Fast Mode

all input signals are timed from VIL to 70% of $V_{pull-up}$, $1.7\text{ V} \leq V_{DD} \leq 5.5\text{ V}$, $-40^{\circ}\text{C} \leq T_A \leq +125^{\circ}\text{C}$, and $1.7\text{ V} \leq V_{pull-up} \leq V_{DD}\text{ V}$

		MIN	NOM	MAX	UNIT
f _{SCLK}	SCL frequency			400	kHz
t _{BUF}	Bus free time between stop and start conditions	1.3			μs
t _{HDSTA}	Hold time after repeated start	0.6			μs
t _{SUSTA}	Repeated start setup time	0.6			μs
t _{SUSTO}	Stop condition setup time	0.6			μs
t _{HDDAT}	Data hold time	0			ns
t _{SUDAT}	Data setup time	100			ns
t _{LOW}	SCL clock low period	1300			ns
t _{HIGH}	SCL clock high period	600			ns
t _F	Clock and data fall time			300	ns
t _R	Clock and data rise time			300	ns
t _{VDDAT}	Data valid time, R = 360 Ω, C _{trace} = 23 pF, C _{probe} = 10 pF			0.9	μs
t _{VDACK}	Data valid acknowledge time, R = 360 Ω, C _{trace} = 23 pF, C _{probe} = 10 pF			0.9	μs

6.11 Timing Requirements: I²C Fast Mode Plus

all input signals are timed from VIL to 70% of $V_{pull-up}$, $1.7\text{ V} \leq V_{DD} \leq 5.5\text{ V}$, $-40^{\circ}\text{C} \leq T_A \leq +125^{\circ}\text{C}$, and $1.7\text{ V} \leq V_{pull-up} \leq V_{DD}\text{ V}$

		MIN	NOM	MAX	UNIT
f _{SCLK}	SCL frequency			1	MHz
t _{BUF}	Bus free time between stop and start conditions	0.5			μs
t _{HDSTA}	Hold time after repeated start	0.26			μs
t _{SUSTA}	Repeated start setup time	0.26			μs
t _{SUSTO}	Stop condition setup time	0.26			μs
t _{HDDAT}	Data hold time	0			ns
t _{SUDAT}	Data setup time	50			ns
t _{LOW}	SCL clock low period	0.5			μs
t _{HIGH}	SCL clock high period	0.26			μs
t _F	Clock and data fall time			120	ns
t _R	Clock and data rise time			120	ns
t _{VDDAT}	Data valid time, R = 360 Ω, C _{trace} = 23 pF, C _{probe} = 10 pF			0.45	μs
t _{VDACK}	Data valid acknowledge time, R = 360 Ω, C _{trace} = 23 pF, C _{probe} = 10 pF			0.45	μs

6.12 Timing Requirements: SPI Write Operation

all input signals are specified with $t_r = t_f = 1 \text{ V/ns}$ (10% to 90% of V_{IO}) and timed from a voltage level of $(V_{IL} + V_{IH}) / 2$, $1.7 \text{ V} \leq V_{IO} \leq 5.5 \text{ V}$, $1.7 \text{ V} \leq V_{DD} \leq 5.5 \text{ V}$, and $-40^\circ\text{C} \leq T_A \leq +125^\circ\text{C}$

		MIN	NOM	MAX	UNIT
f_{SCLK}	Serial clock frequency			50	MHz
t_{SCLKHIGH}	SCLK high time	9			ns
t_{SCLKLOW}	SCLK low time	9			ns
t_{SDIS}	SDI setup time	8			ns
t_{SDIH}	SDI hold time	8			ns
t_{CSS}	$\overline{\text{CS}}$ to SCLK falling edge setup time	18			ns
t_{CSH}	SCLK falling edge to $\overline{\text{CS}}$ rising edge	10			ns
t_{CSHIGH}	$\overline{\text{CS}}$ high time	50			ns
t_{DACWAIT}	Sequential DAC update wait time (time between subsequent $\overline{\text{LDAC}}$ falling edges) for same channel	2			μs
$t_{\text{BCASTWAIT}}$	Broadcast DAC update wait time (time between subsequent $\overline{\text{LDAC}}$ falling edges)	2			μs

6.13 Timing Requirements: SPI Read and Daisy Chain Operation (FSDO = 0)

all input signals are specified with $t_r = t_f = 1 \text{ V/ns}$ (10% to 90% of V_{IO}) and timed from a voltage level of $(V_{IL} + V_{IH}) / 2$, $1.7 \text{ V} \leq V_{IO} \leq 5.5 \text{ V}$, $1.7 \text{ V} \leq V_{DD} \leq 5.5 \text{ V}$, $-40^\circ\text{C} \leq T_A \leq +125^\circ\text{C}$, and $\text{FSDO} = 0$

		MIN	NOM	MAX	UNIT
f_{SCLK}	Serial clock frequency			1.25	MHz
t_{SCLKHIGH}	SCLK high time	350			ns
t_{SCLKLOW}	SCLK low time	350			ns
t_{SDIS}	SDI setup time	8			ns
t_{SDIH}	SDI hold time	8			ns
t_{CSS}	$\overline{\text{SYNC}}$ to SCLK falling edge setup time	400			ns
t_{CSH}	SCLK falling edge to $\overline{\text{SYNC}}$ rising edge	400			ns
t_{CSHIGH}	$\overline{\text{SYNC}}$ high time	1			μs
t_{SDODLY}	SCLK rising edge to SDO falling edge, $I_{OL} \leq 5 \text{ mA}$, $C_L = 20 \text{ pF}$.			300	ns

6.14 Timing Requirements: SPI Read and Daisy Chain Operation (FSDO = 1)

all input signals are specified with $t_r = t_f = 1 \text{ V/ns}$ (10% to 90% of V_{IO}) and timed from a voltage level of $(V_{IL} + V_{IH}) / 2$, $1.7 \text{ V} \leq V_{IO} \leq 5.5 \text{ V}$, $1.7 \text{ V} \leq V_{DD} \leq 5.5 \text{ V}$, $-40^\circ\text{C} \leq T_A \leq +125^\circ\text{C}$, and $\text{FSDO} = 1$

		MIN	NOM	MAX	UNIT
f_{SCLK}	Serial clock frequency			2.5	MHz
t_{SCLKHIGH}	SCLK high time	175			ns
t_{SCLKLOW}	SCLK low time	175			ns
t_{SDIS}	SDI setup time	8			ns
t_{SDIH}	SDI hold time	8			ns
t_{CSS}	$\overline{\text{SYNC}}$ to SCLK falling edge setup time	300			ns
t_{CSH}	SCLK falling edge to $\overline{\text{SYNC}}$ rising edge	300			ns
t_{CSHIGH}	$\overline{\text{SYNC}}$ high time	1			μs
t_{SDODLY}	SCLK rising edge to SDO falling edge, $I_{OL} \leq 5 \text{ mA}$, $C_L = 20 \text{ pF}$.			300	ns

6.15 Timing Requirements: GPIO

all input signals are specified with $t_r = t_f = 1 \text{ V/ns}$ (10% to 90% of V_{IO}) and timed from a voltage level of $(V_{IL} + V_{IH}) / 2$, $1.7 \text{ V} \leq V_{IO} \leq 5.5 \text{ V}$, $1.7 \text{ V} \leq V_{DD} \leq 5.5 \text{ V}$, and $-40^\circ\text{C} \leq T_A \leq +125^\circ\text{C}$

		MIN	NOM	MAX	UNIT
$t_{GPIHIGH}$	GPI high time ⁽¹⁾	2			μs
t_{GPILOW}	GPI low time ⁽¹⁾	2			μs
t_{GPAWGD}	$\overline{\text{LDAC}}$ falling edge to DAC update delay ⁽⁴⁾			2	μs
$t_{CS2LDAC}$	$\overline{\text{SYNC}}$ rising edge to $\overline{\text{LDAC}}$ falling edge	1			μs
$t_{STP2LDAC}$	I ² C stop bit rising edge to $\overline{\text{LDAC}}$ falling edge	1			μs
t_{LDACW}	$\overline{\text{LDAC}}$ low time	2			μs

- (1) The SCL, SDA, A0, and A1 pins can be configured as GPIOs that perform different channel-specific or independent operations. The actual response time of the GPIO is determined by the delay provided by the configured function and the settling time of the DAC.
- (2) The GPIOs can be configured as channel-specific or global $\overline{\text{LDAC}}$ function.

6.16 Timing Diagrams

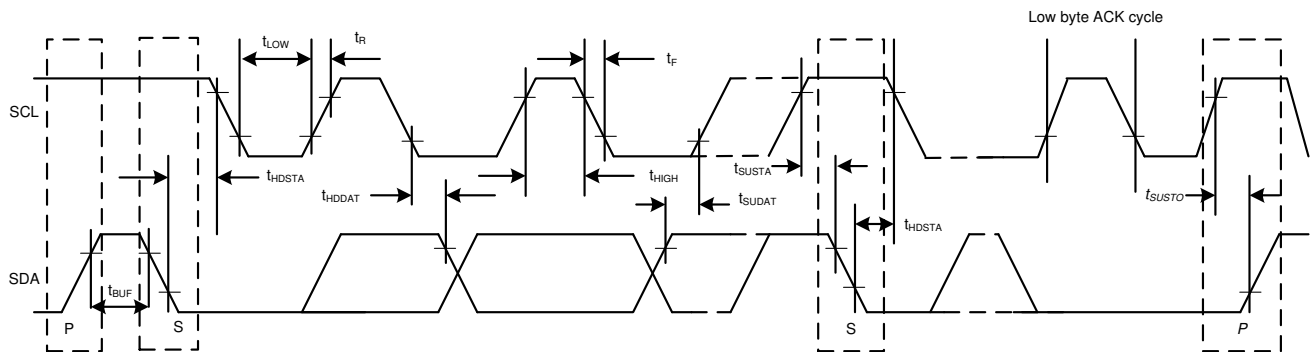

6-1. I²C Timing Diagram

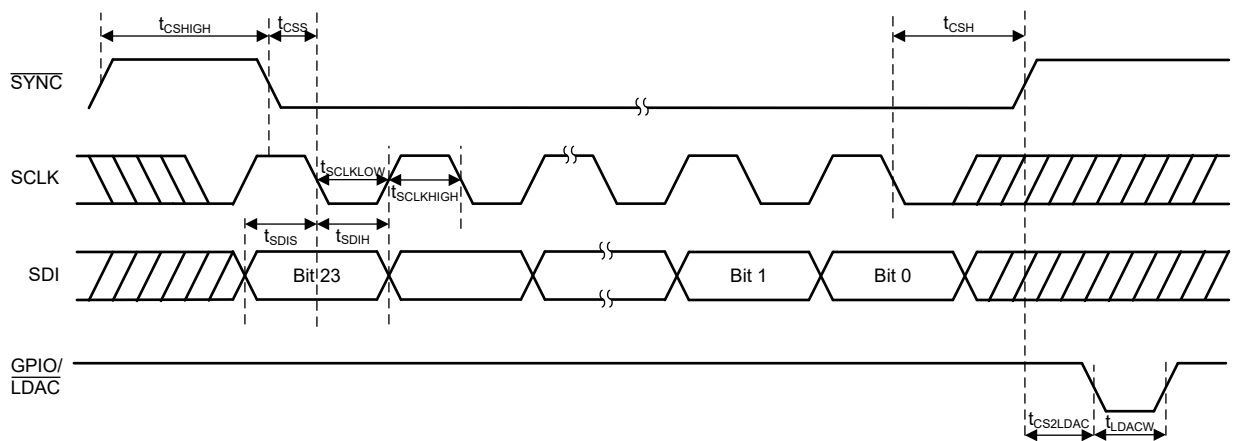

6-2. SPI Write Timing Diagram

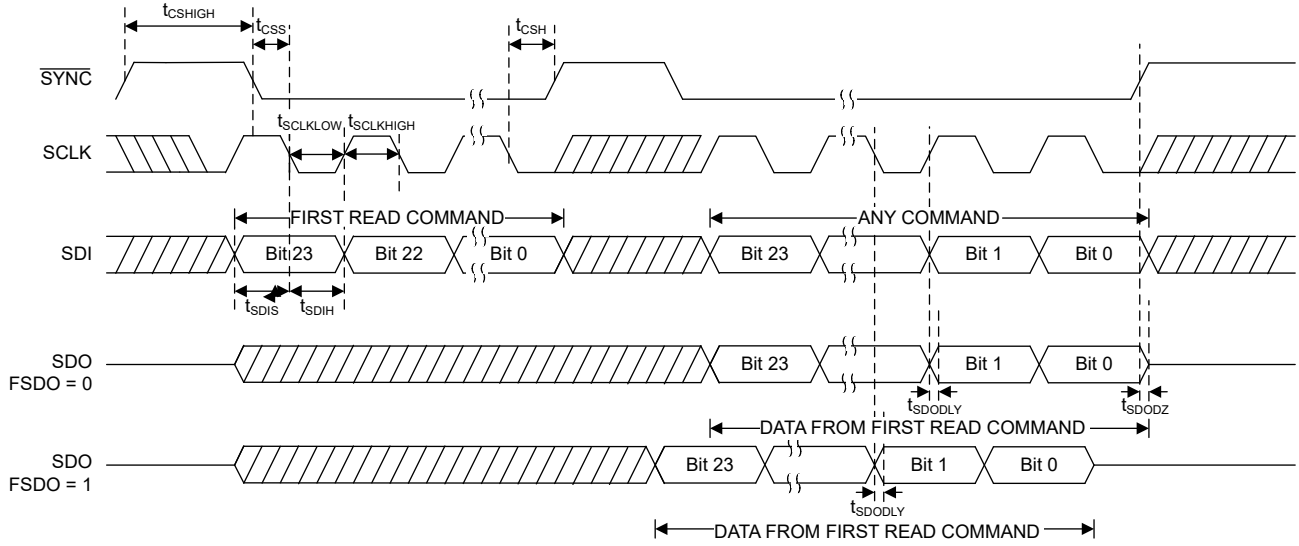

6-3. SPI Read Timing Diagram

6.17 Typical Characteristics: Voltage Output

at $T_A = 25^\circ\text{C}$, $V_{DD} = 5.5\text{ V}$, external reference = 5.5 V , gain = 1x, 12-bit resolution, and DAC outputs unloaded (unless otherwise noted)

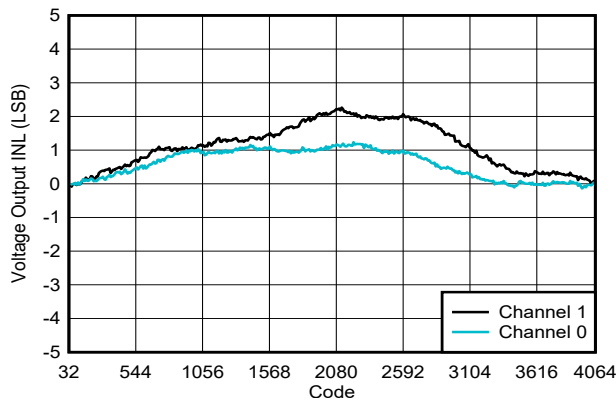

Internal reference, gain = 4x

6-4. Voltage Output INL vs Digital Input Code

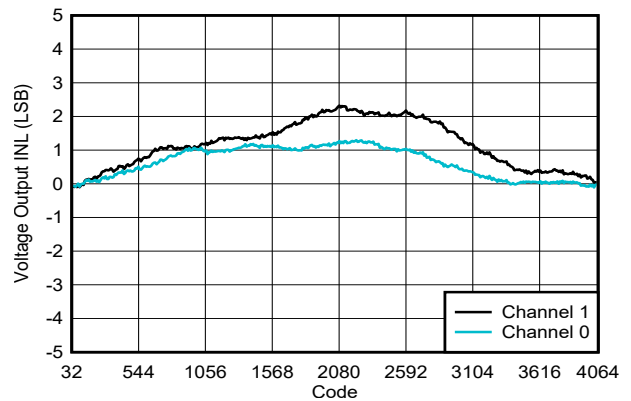

6-5. Voltage Output INL vs Digital Input Code

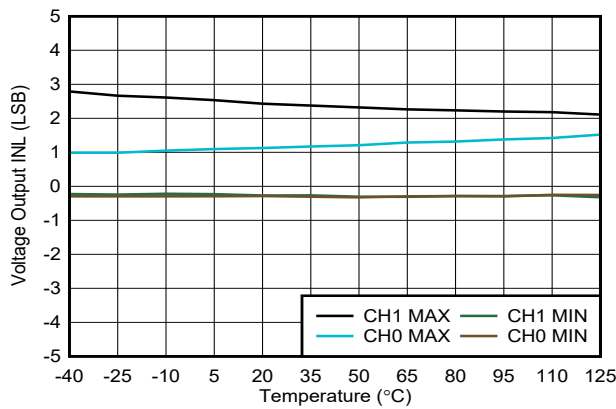

6-6. Voltage Output INL vs Temperature

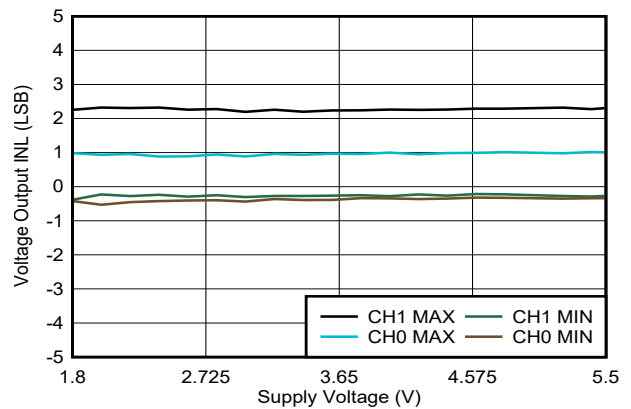

6-7. Voltage Output INL vs Supply Voltage

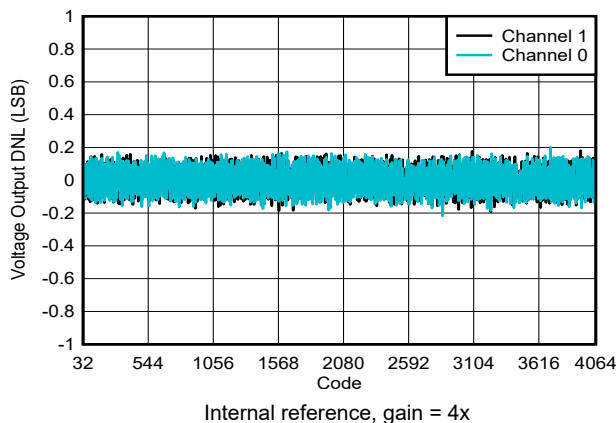

Internal reference, gain = 4x

6-8. Voltage Output DNL vs Digital Input Code

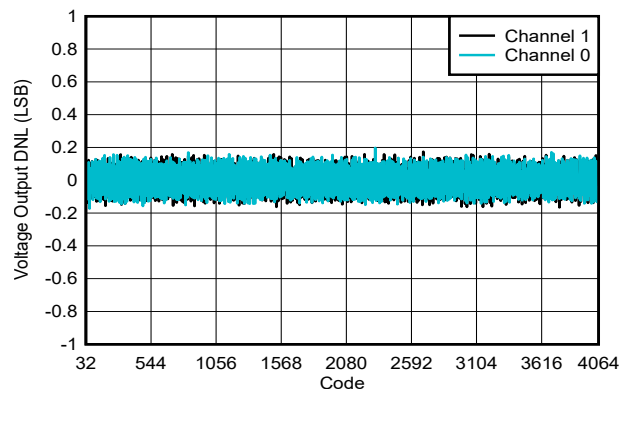

6-9. Voltage Output DNL vs Digital Input Code

6.17 Typical Characteristics: Voltage Output (continued)

at $T_A = 25^\circ\text{C}$, $V_{DD} = 5.5\text{ V}$, external reference = 5.5 V, gain = 1x, 12-bit resolution, and DAC outputs unloaded (unless otherwise noted)

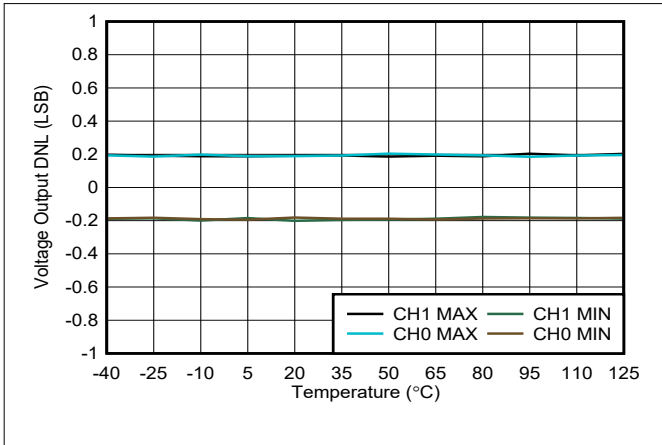

6-10. Voltage Output DNL vs Temperature

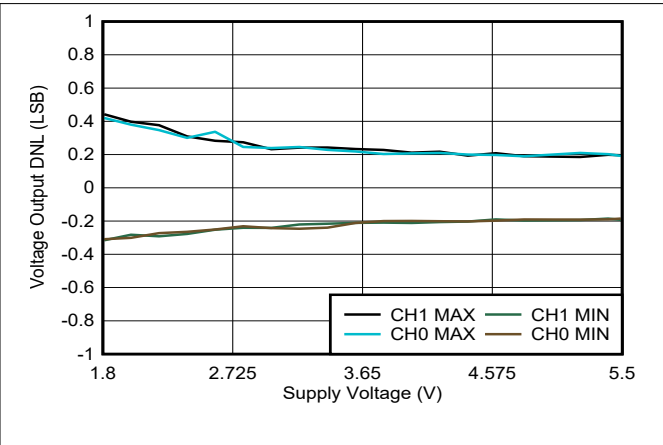

6-11. Voltage Output DNL vs Supply Voltage

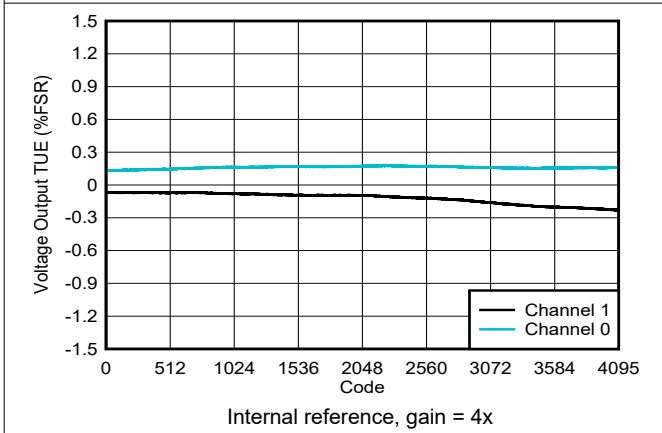

6-12. Voltage Output TUE vs Digital Input Code

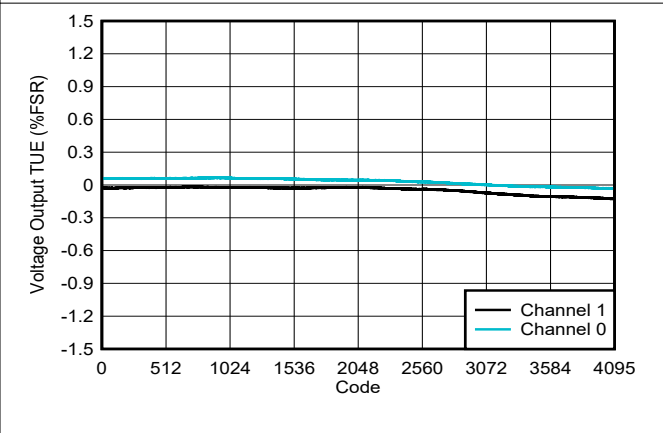

6-13. Voltage Output TUE vs Digital Input Code

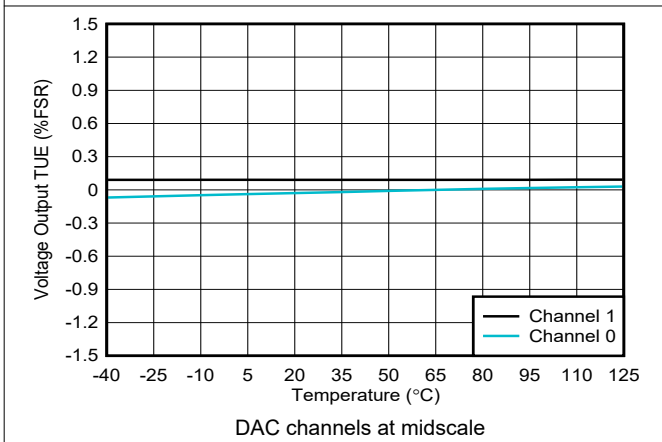

6-14. Voltage Output TUE vs Temperature

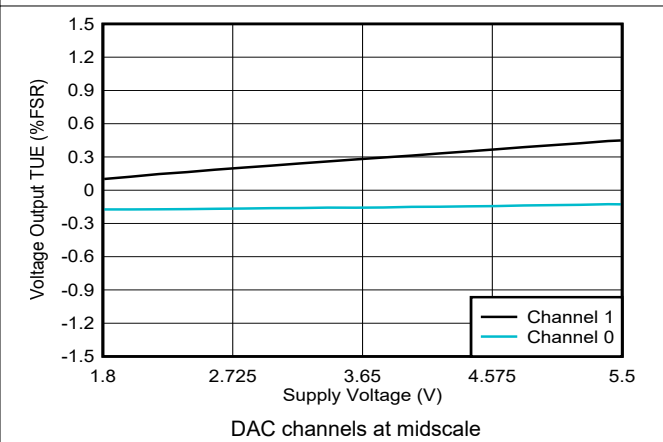

6-15. Voltage Output TUE vs Supply Voltage

6.17 Typical Characteristics: Voltage Output (continued)

at $T_A = 25^\circ\text{C}$, $V_{DD} = 5.5\text{ V}$, external reference = 5.5 V, gain = 1x, 12-bit resolution, and DAC outputs unloaded (unless otherwise noted)



图 6-16. Voltage Output Offset Error vs Temperature



图 6-17. Voltage Output Gain Error vs Temperature

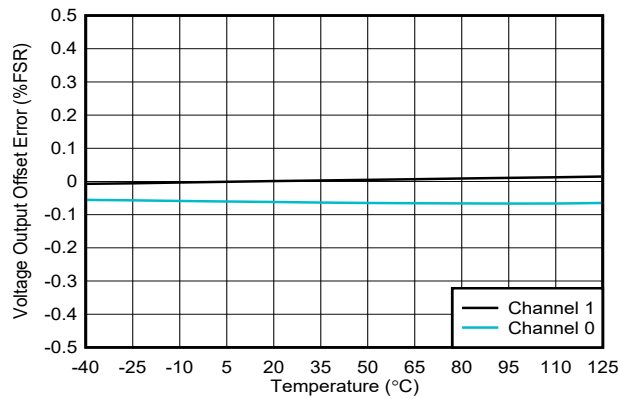

图 6-18. Voltage Output vs Load Current

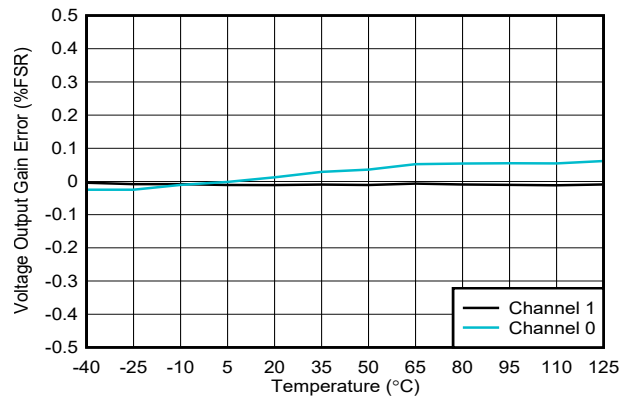

图 6-19. Voltage Output AC PSRR vs Frequency

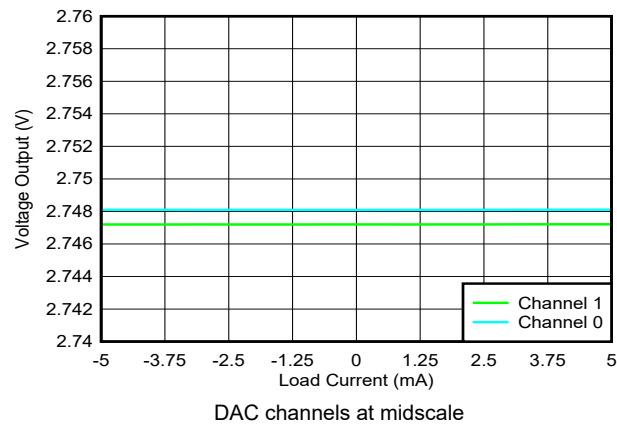

图 6-20. Voltage Output Code-to-Code Glitch - Rising Edge

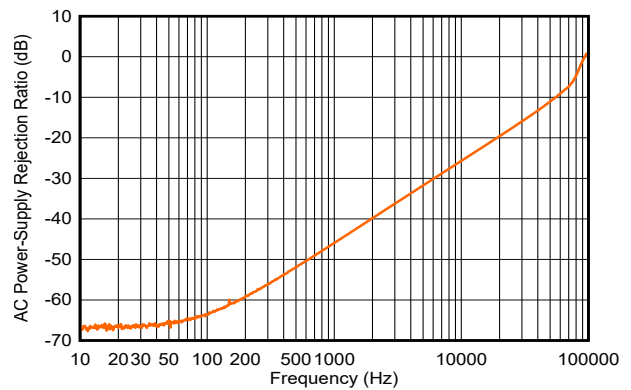

图 6-21. Voltage Output Code-to-Code Glitch - Falling Edge

6.17 Typical Characteristics: Voltage Output (continued)

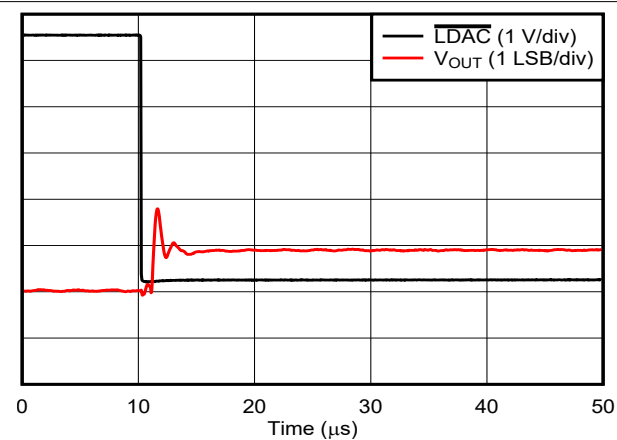
at $T_A = 25^\circ\text{C}$, $V_{DD} = 5.5\text{ V}$, external reference = 5.5 V, gain = 1x, 12-bit resolution, and DAC outputs unloaded (unless otherwise noted)

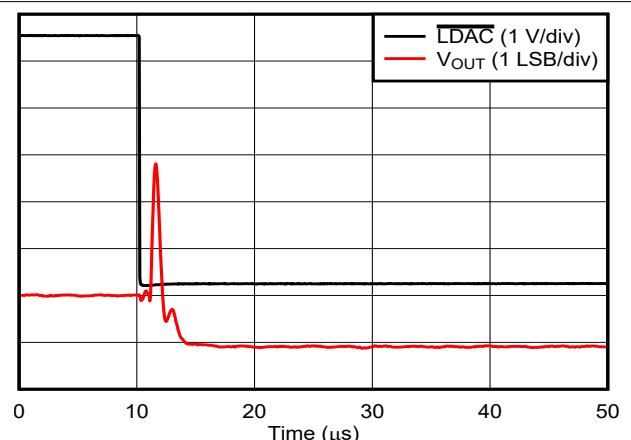
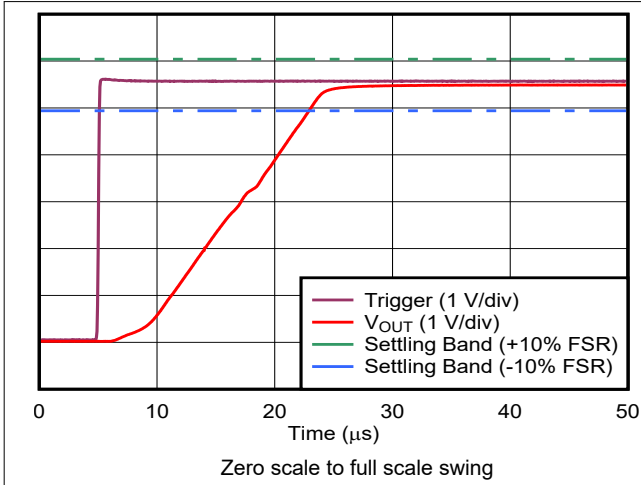

Figure 6-22. Voltage Output Setting Time - Rising Edge

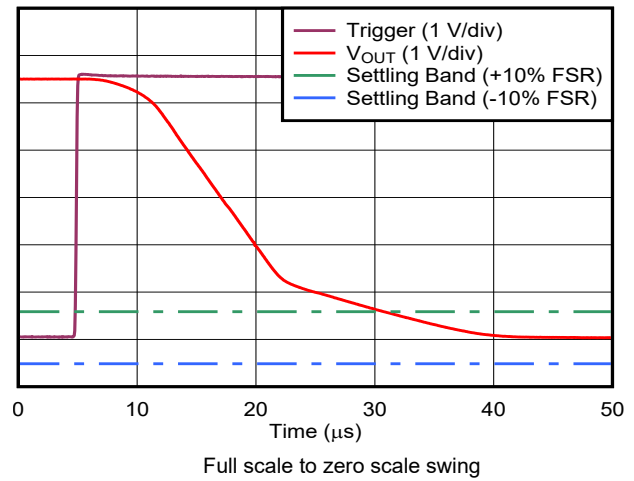

Figure 6-23. Voltage Output Setting Time - Falling Edge

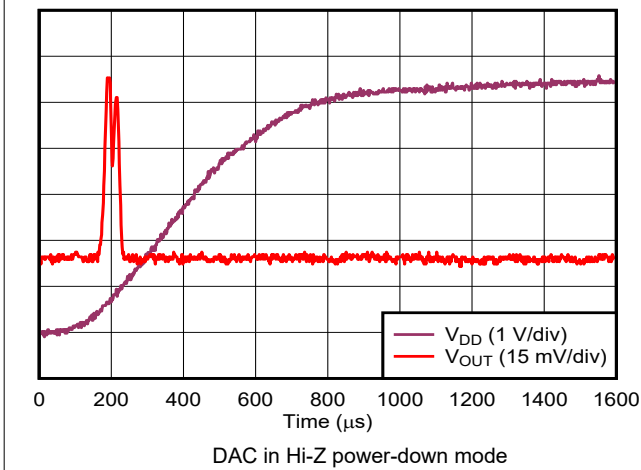

Figure 6-24. Voltage Output Power-On Glitch

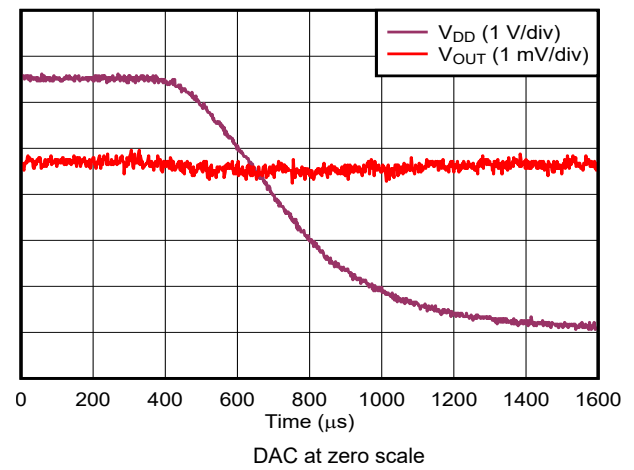

Figure 6-25. Voltage Output Power-Off Glitch

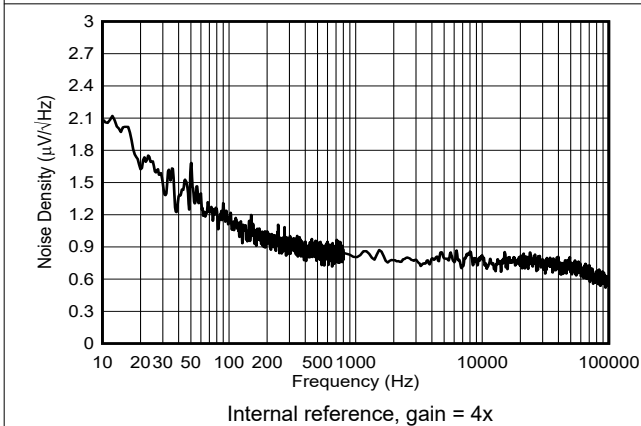

Figure 6-26. Voltage Output Noise Density

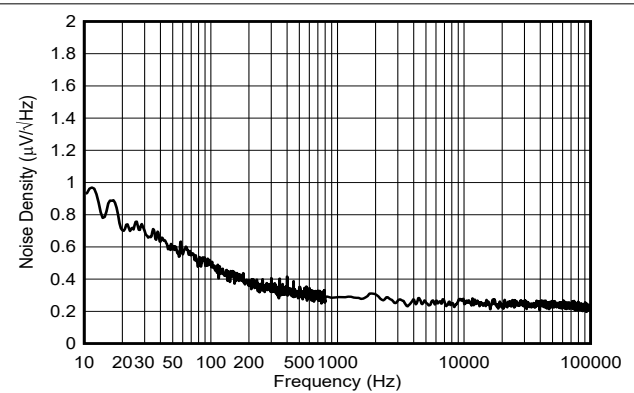
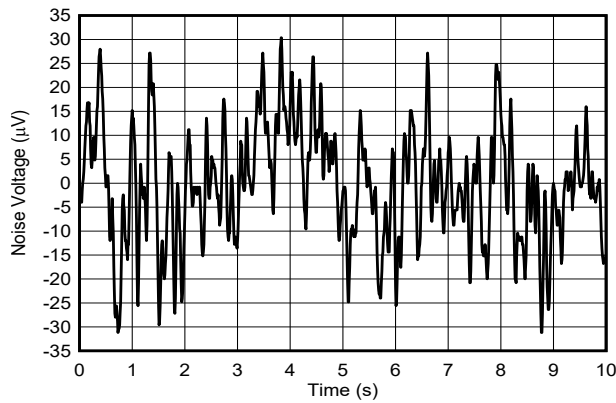



Figure 6-27. Voltage Output Noise Density

6.17 Typical Characteristics: Voltage Output (continued)

at $T_A = 25^\circ\text{C}$, $V_{DD} = 5.5\text{ V}$, external reference = 5.5 V, gain = 1x, 12-bit resolution, and DAC outputs unloaded (unless otherwise noted)



Internal reference, gain = 4x, $f = 0.1\text{ Hz to }10\text{ Hz}$

 6-28. Voltage Output Flicker Noise

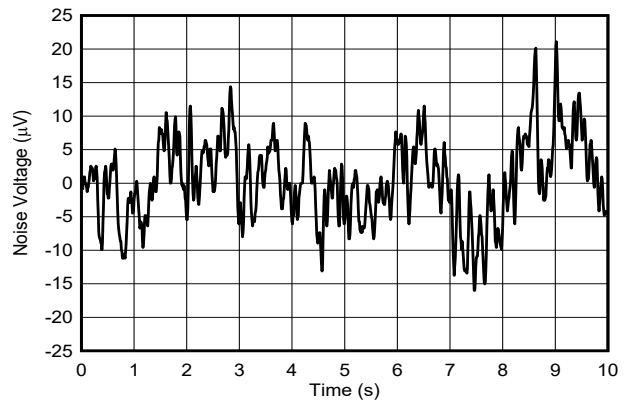

$f = 0.1\text{ Hz to }10\text{ Hz}$

 6-29. Voltage Output Flicker Noise

6.18 Typical Characteristics: Current Output

at $T_A = 25^\circ\text{C}$, $V_{DD} = 5.5\text{ V}$, output range: $\pm 250\ \mu\text{A}$ (unless otherwise noted)

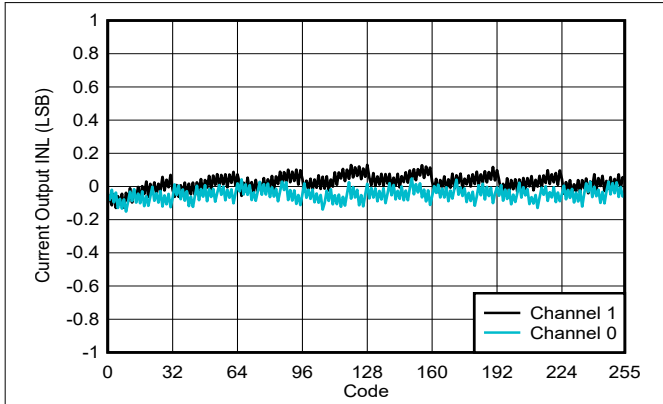

Figure 6-30. Current Output INL vs Digital Input Code

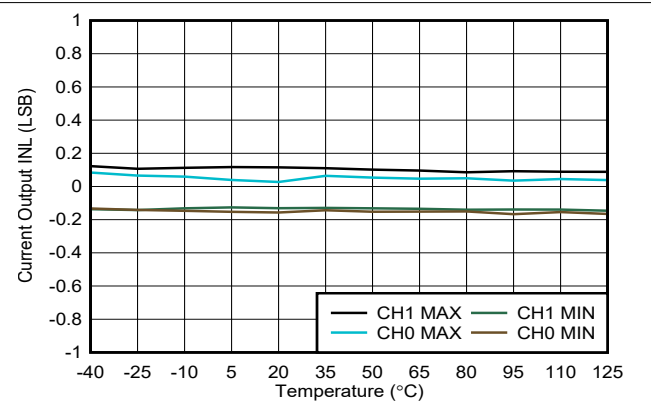

Figure 6-31. Current Output INL vs Temperature

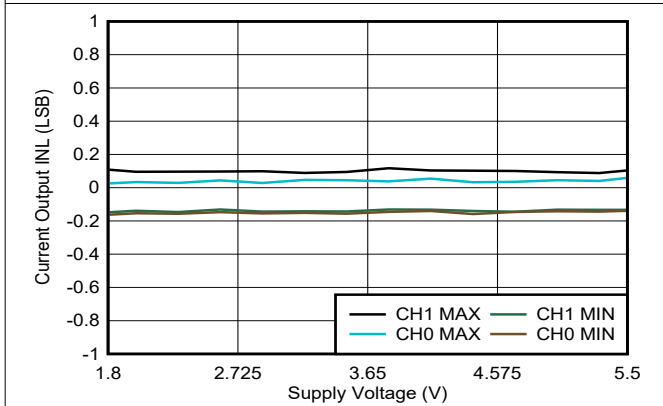

Figure 6-32. Current Output INL vs Supply Voltage

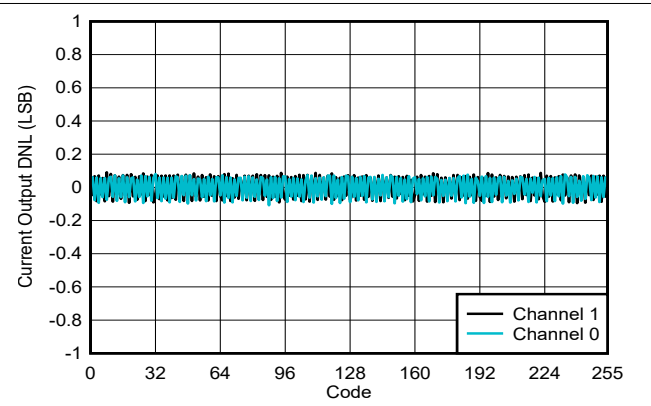

Figure 6-33. Current Output DNL vs Digital Input Code

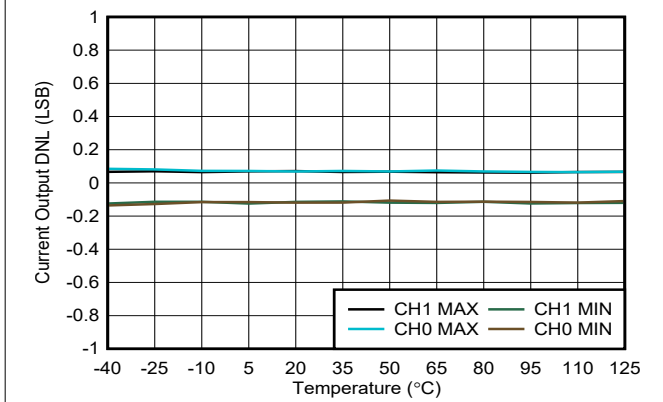

Figure 6-34. Current Output DNL vs Temperature

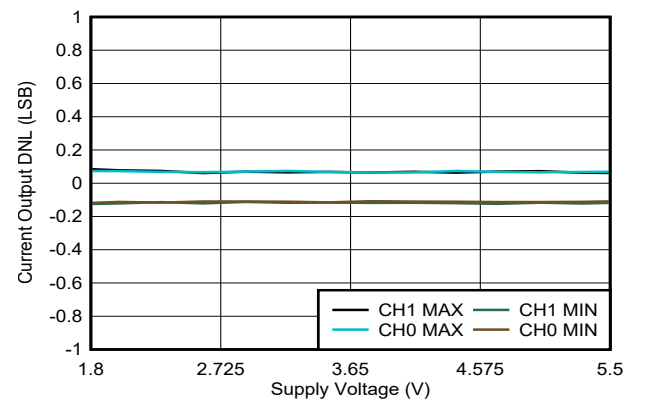
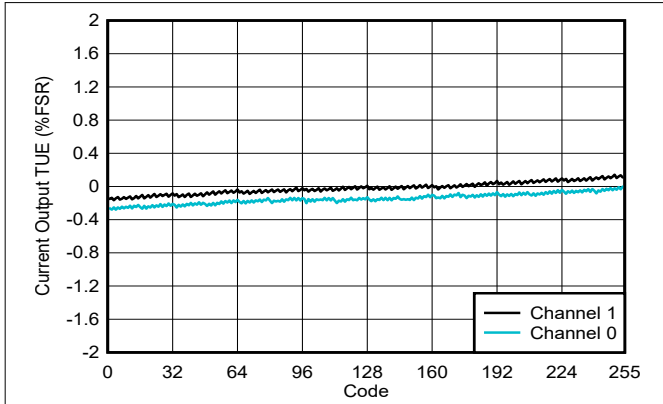

Figure 6-35. Current Output DNL vs Supply Voltage

6.18 Typical Characteristics: Current Output (continued)

at $T_A = 25^\circ\text{C}$, $V_{DD} = 5.5\text{ V}$, output range: $\pm 250\ \mu\text{A}$ (unless otherwise noted)



6-36. Current Output TUE vs Digital Input Code

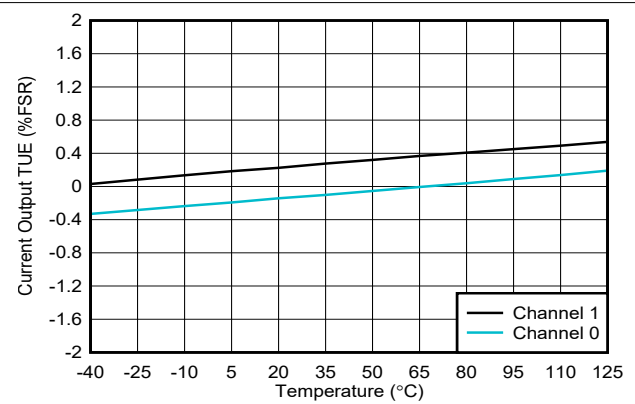

6-37. Current Output TUE vs Temperature

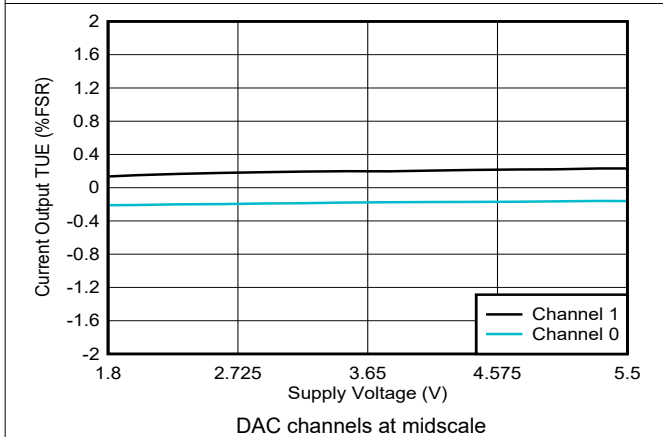

6-38. Current Output TUE vs Supply Voltage

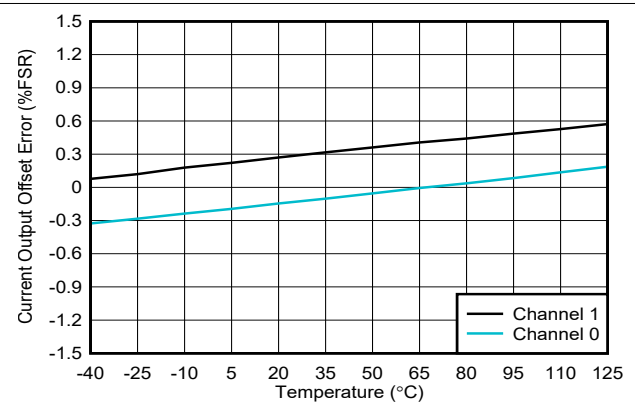

6-39. Current Output Offset Error vs Temperature

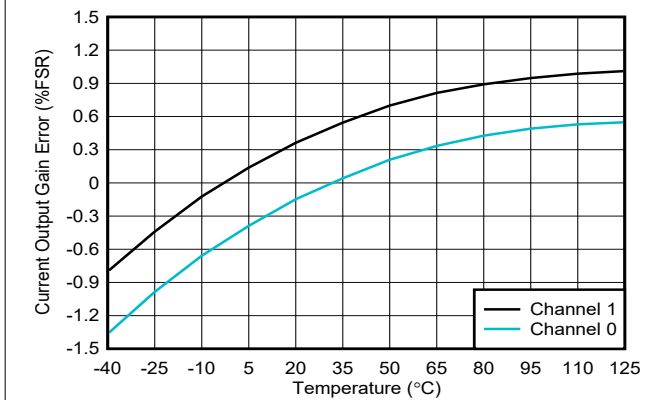

6-40. Current Output Gain Error vs Temperature

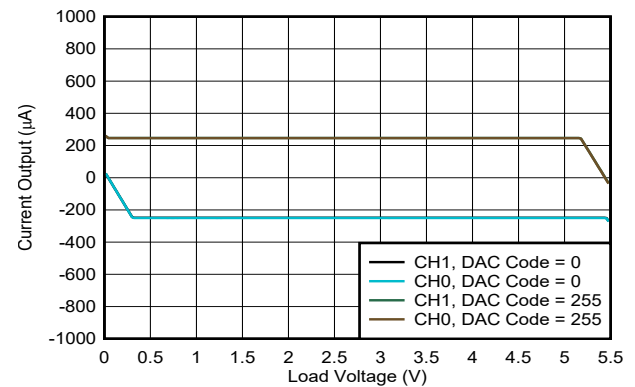

6-41. Current Output vs Load Voltage

6.18 Typical Characteristics: Current Output (continued)

at $T_A = 25^\circ\text{C}$, $V_{DD} = 5.5\text{ V}$, output range: $\pm 250\ \mu\text{A}$ (unless otherwise noted)

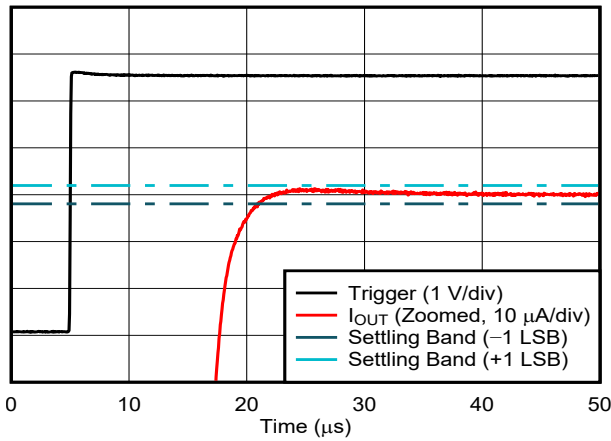

6-42. Current Output Setting Time, Rising Edge

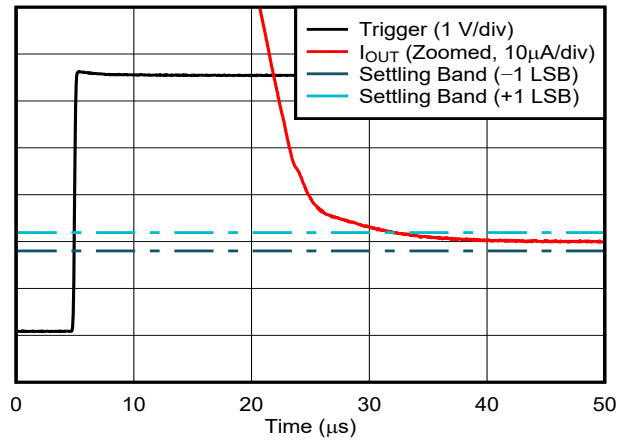

6-43. Current Output Setting Time, Falling Edge

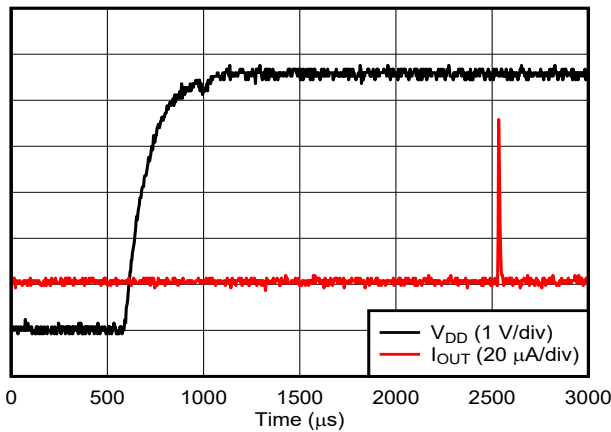

DAC at mid scale ($0\ \mu\text{A}$) stored in EEPROM

6-44. Current Output Power-On Glitch

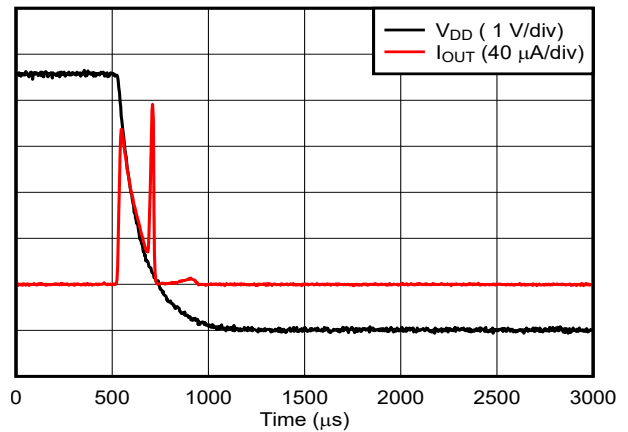

DAC at mid scale ($0\ \mu\text{A}$)

6-45. Current Output Power-Off Glitch

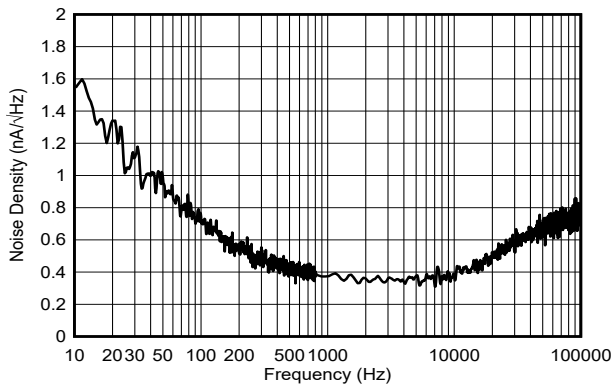

6-46. Current Output Noise Density

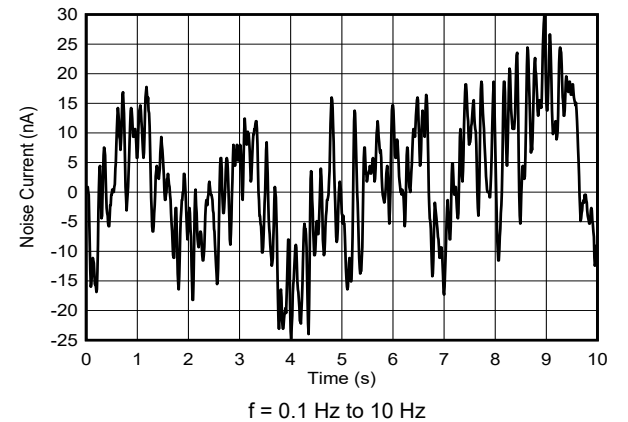

6-47. Current Output Flicker Noise

6.18 Typical Characteristics: Current Output (continued)

at $T_A = 25^\circ\text{C}$, $V_{DD} = 5.5\text{ V}$, output range: $\pm 250\ \mu\text{A}$ (unless otherwise noted)

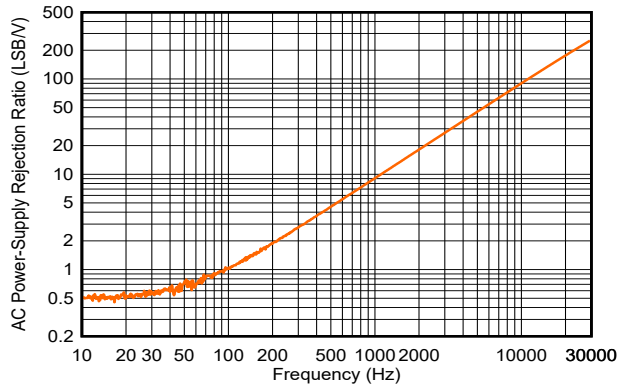

6-48. Current Output AC PSRR vs Frequency

6.19 Typical Characteristics: Comparator

at $T_A = 25^\circ\text{C}$, $V_{DD} = 5.5\text{ V}$, external reference = 5.5 V, gain = 1x, 12-bit resolution, FBx pin in Hi-Z mode, and DAC outputs unloaded (unless otherwise noted)

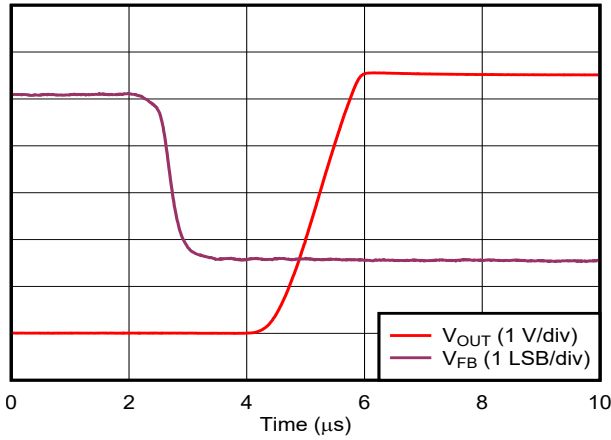

Comparator output in push-pull mode

ⓧ 6-49. Comparator Response Time: Low-to-High Transition

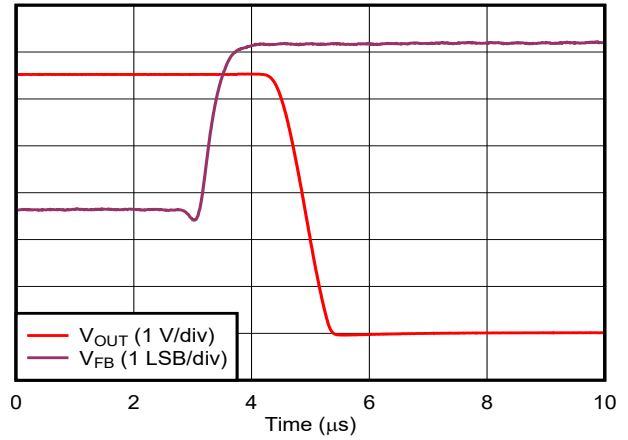

Comparator output in push-pull mode

ⓧ 6-50. Comparator Response Time: High-to-Low Transition

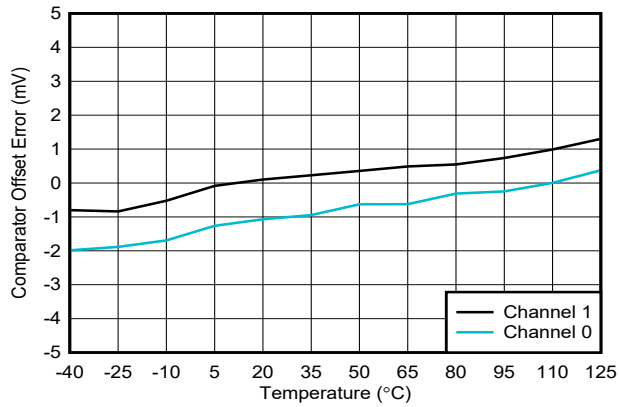

ⓧ 6-51. Comparator Offset Error vs Temperature

6.20 Typical Characteristics: General

at $T_A = 25^\circ\text{C}$, $V_{DD} = 5.5\text{ V}$, and DAC outputs unloaded (unless otherwise noted)

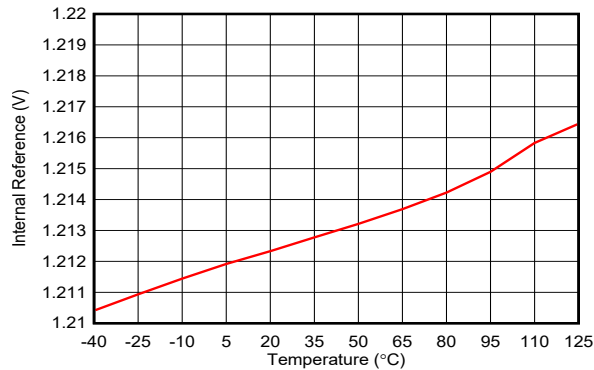

6-52. Internal Reference vs Temperature

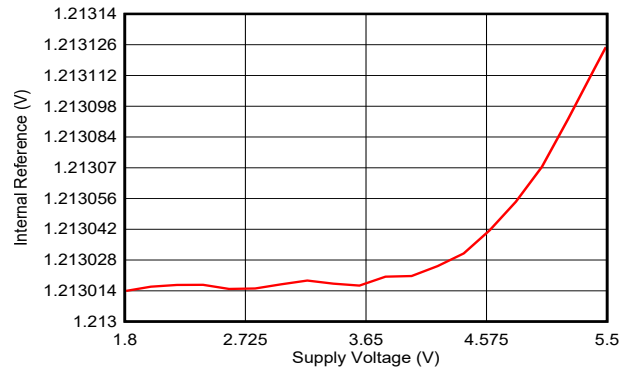

6-53. Internal Reference vs Supply Voltage

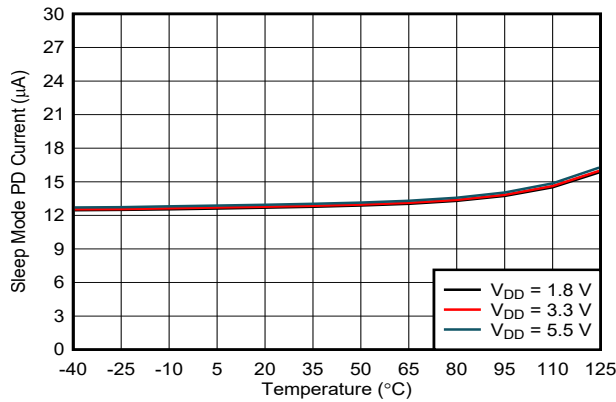

6-54. Power-Down Current vs Temperature

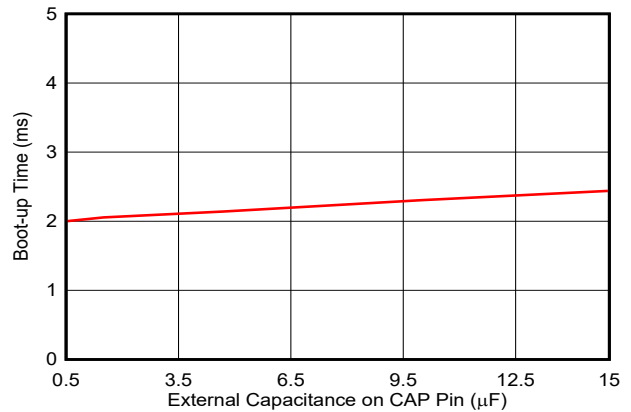

6-55. Boot-Up Time vs Capacitance on CAP pin

7 Detailed Description

7.1 Overview

The 12-bit DAC63202W is a dual-channel buffered voltage-output and current-output smart digital-to-analog converter (DAC). The DAC channels are independently configurable as voltage or current output. The DAC outputs change to Hi-Z when VDD is off; a feature useful in voltage-margining applications. This smart DAC contains nonvolatile memory (NVM), an internal reference, automatically detectable I²C or SPI, PMBus-compatibility in I²C mode, force-sense output, and a general-purpose input. This device supports Hi-Z power-down modes by default, which can be configured to 10 kΩ-GND or 100 kΩ-GND using the NVM. The DAC63202W has a power-on-reset (POR) circuit that makes sure all the registers start with default or user-programmed settings using NVM. The DAC63202W operates with either an internal reference, external reference, or with a power supply as the reference, and provide a full-scale output of 1.8 V to 5.5 V.

The DAC63202W supports I²C standard mode (100 kbps), fast mode (400 kbps), and fast mode plus (1 Mbps). The I²C interface can be configured with four target addresses using the A0 pin. This device also supports specific PMBus commands such as *turn on/off*, *margin high or low*, and more. SPI mode supports a 3-wire interface by default with up to 50-MHz SCLK input. The GPIO input can be configured as SDO in the NVM for SPI read capability. The GPIO input can alternatively be configurable as LDAC, PD, STATUS, FAULT-DUMP, RESET, and PROTECT functions.

The DAC63202W also includes digital slew rate control, and supports standard waveform generation such as *sine*, *cosine*, *triangular*, and *sawtooth* waveforms. This device can generate pulse-width modulation (PWM) output with the combination of the triangular or sawtooth waveform and the FB pin. The force-sense outputs of the DAC channels can be used as programmable comparators. The comparator mode allows programmable hysteresis, latching comparator, window comparator, and fault-dump to the NVM. These features enable the DAC63202W to go beyond the limitations of a conventional DAC that depends on a processor to function. As a result of *processor-less* operation and the *smart* feature set, the DAC63202W is called a smart DAC.

7.2 Functional Block Diagram

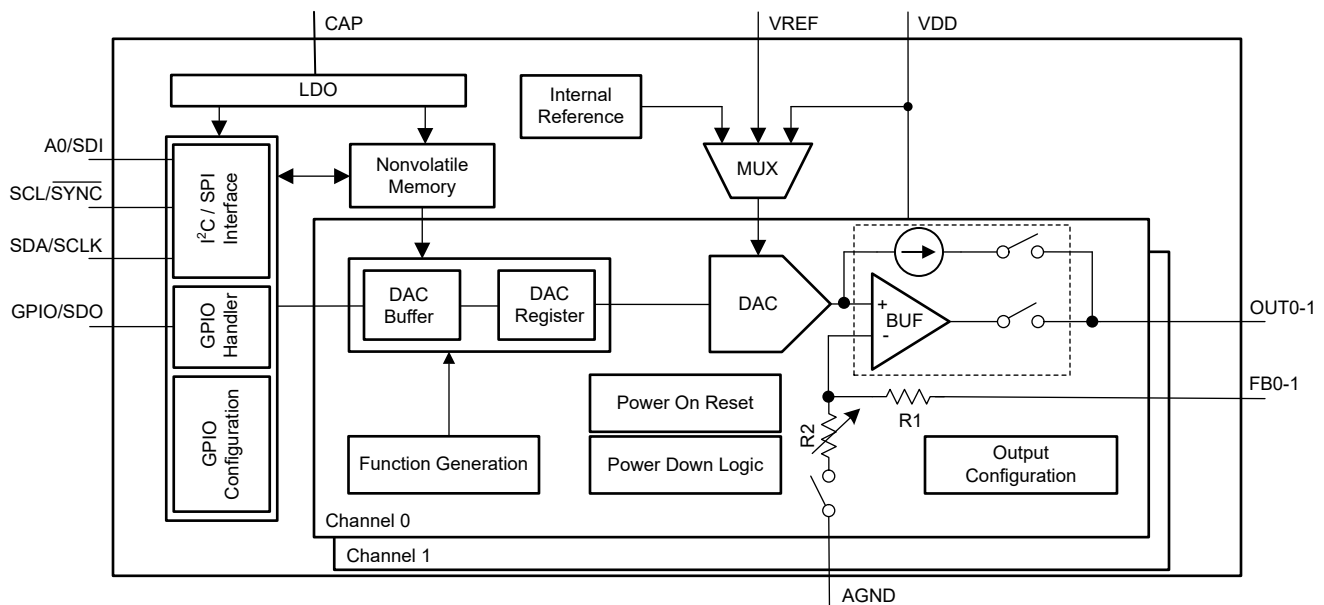

7-1. Functional Block Diagram

7.3 Feature Description

7.3.1 Smart Digital-to-Analog Converter (DAC) Architecture

The DAC63202W devices consist of a string architecture with a voltage-output amplifier, as well as an external FB pin and voltage-to-current converter for each channel. [セクション 7.2](#) shows the DAC architecture within the block diagram that operates from a 1.8-V to 5.5-V power supply. The DAC has an internal voltage reference of 1.21 V. Optionally, use an external reference on the VREF pin, or use the power supply as a reference. Voltage output mode uses one of these three reference options. Current output mode uses an internal band gap to generate the current outputs. Both the voltage- and current-output modes support multiple programmable output ranges.

The DAC63202W devices support Hi-Z output when VDD is off, maintaining very low leakage current at the output pins with up to 1.25 V of forced voltage. The DAC output pin also starts up in high-impedance mode by default, making these devices an excellent choice for voltage margining and scaling applications. To change the power-up mode to 10 k Ω -GND or 100 k Ω -GND, program the corresponding VOUT-PDN-X field in the COMMON-CONFIG register and load these bits in the device NVM.

The DAC63202W devices support an independent comparator mode for each channel. The respective FBx pin acts as an input for the comparator. The DAC architecture supports inversion of the comparator output using register settings. The comparator outputs can be push-pull or open-drain. The comparator mode supports programmable hysteresis using the *margin-high* and *margin-low* register fields, latching comparator, and window comparator. The comparator outputs are accessible internally by the device.

The DAC63202W devices include a *smart* feature set to enable *processor-less* operation and high integration. The NVM enables a predictable start-up. In the absence of a processor or when the processor or software fails, the GPIO triggers the DAC output without the I²C interface. The integrated functions and the FBx pin enable PWM output for control applications. The FBx pin enables this device to be used as a programmable comparator. The digital slew-rate control and the Hi-Z power-down modes enable a hassle-free voltage margining and scaling function.

7.3.2 Digital Input/Output

The DAC63202W have four digital IO pins that include I²C, SPI, PMBus, and GPIO interfaces. These devices automatically detect I²C and SPI protocols at the first successful communication after power-on, and then connect to the detected interface. After an interface protocol is connected, any change in the protocol is ignored. The I²C interface uses the A0 pin to select from among four address options. The SPI interface is a 3-wire interface by default. No readback capability is available in this mode. The GPIO pin can be configured in the register map and then programmed in to the NVM as the SDO pin. The SPI readback mode is slower than the write mode. The programming interface pins are:

- I²C: SCL, SDA, A0
- SPI: SCLK, SDI, $\overline{\text{SYNC}}$, SDO/GPIO

The GPIO can be configured as multiple functions other than SDO. These are $\overline{\text{LDAC}}$, $\overline{\text{PD}}$, $\overline{\text{STATUS}}$, $\overline{\text{PROTECT}}$, $\overline{\text{FAULT-DUMP}}$, and $\overline{\text{RESET}}$. All the digital pins are open-drain when used as outputs. Therefore, all the output pins must be pulled up to the desired IO voltage using external resistors.

7.3.3 Nonvolatile Memory (NVM)

The DAC63202W contain nonvolatile memory (NVM) bits. These memory bits are user programmable and erasable, and retain the set values in the absence of a power supply. All the register bits, shown in the highlighted gray cells in [セクション 7.6](#), can be stored in the NVM by setting NVM-PROG = 1 in the COMMON-TRIGGER register. The NVM-PROG is an autoresetting bit. The default values for all the registers in the DAC63202W are loaded from NVM as soon as a POR event is issued.

The DAC63202W also implement NVM-RELOAD bit in the COMMON-TRIGGER register. Set this bit to 1 and the device starts an NVM-reload operation. After completion, the device autoresets the NVM-RELOAD bit to 0. During the NVM write or reload operation, all read/write operations to the device are blocked. [セクション 6.8](#) provides the timing specification for the NVM write cycle. The processor must wait for the specified duration before resuming any read or write operation on the SPI or I²C interface.

7.4 Device Functional Modes

7.4.1 Voltage-Output Mode

The voltage-output mode for each DAC channel can be entered by selecting the power-up option in the VOUT-PDN-X fields in the COMMON-CONFIG register and simultaneously powering down the current output option for the respective channels using the IOOUT-PDN-X bits in the same register. Short the OUTx and FBx pins of respective channels externally for closed-loop amplifier output. An open FBx pin saturates the amplifier output. To achieve the desired voltage output, select the correct reference option, select the amplifier gain for the required output range, and program the DAC code in the DAC-X-DATA register of the respective channels.

7.4.1.1 Voltage Reference and DAC Transfer Function

Figure 7-2 shows that there are three voltage reference options possible with the DAC63202W: internal reference, external reference, and the power supply as reference. The DAC transfer function in the voltage-output and comparator modes changes based on the voltage reference selection.

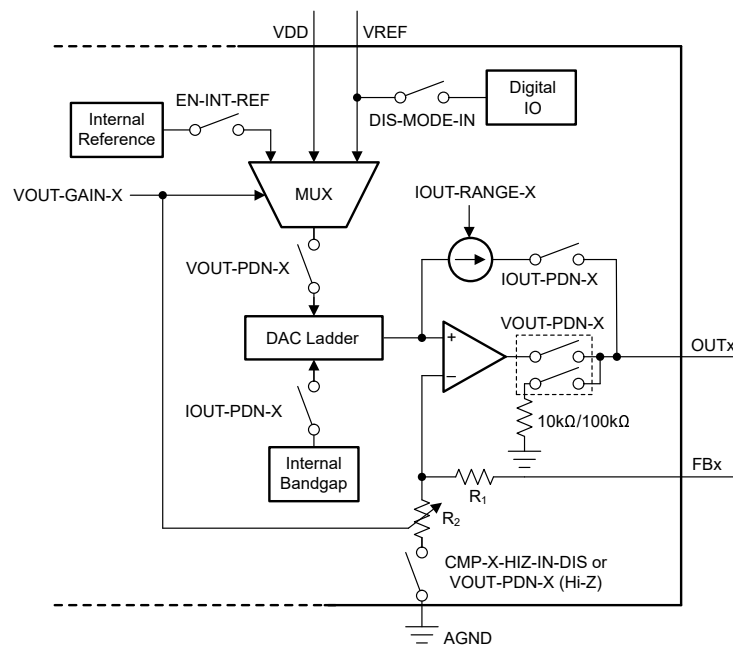

Figure 7-2. Voltage Reference Selection and Power-Down Logic

7.4.1.1.1 Internal Reference

The DAC63202W contains an internal reference that is disabled by default. To enable the internal reference, write 1 to bit EN-INT-REF in the COMMON-CONFIG register. The internal reference generates a fixed 1.21-V voltage (typical). Use the VOUT-GAIN-X bit in the DAC-X-VOUT-CMP-CONFIG register to achieve gains of 1.5 ×, 2 ×, 3 ×, or 4 × for the DAC output voltage (V_{OUT}). Equation 1 shows DAC transfer function using the internal reference.

$$V_{OUT} = \frac{DAC_DATA}{2^N} \times V_{REF} \times GAIN \quad (1)$$

where:

- N is the resolution in bits, 12.
- DAC_DATA is the decimal equivalent of the binary code that is loaded to the DAC-X-DATA bit in the DAC-X-DATA register. DAC_DATA ranges from 0 to 2^N – 1.
- V_{REF} is the internal reference voltage = 1.21 V (typical).
- GAIN = 1.5 ×, 2 ×, 3 ×, or 4 ×, based on VOUT-X-GAIN bits.

7.4.1.1.2 External Reference

By default, the DAC63202W operates from an external reference input. The external reference option can also be selected by configuring the VOUT-GAIN-X field in the DAC-X-VOUT-CMP-CONFIG register appropriately. Write 1 to the DIS-MODE-IN bit in the DEVICE-MODE-CONFIG register to minimize I_{DD}. The external reference can be between 1.7 V and V_{DD}. 式 2 shows DAC transfer function when the external reference is used. The gain at the output stage of the DAC is always 1 × in the external reference mode.

注

The external reference must be less than V_{DD} in both transient and steady-state conditions. Therefore, the external reference must ramp up after V_{DD} and ramp down before V_{DD}.

$$V_{OUT} = \frac{DAC_DATA}{2^N} \times V_{REF} \quad (2)$$

where:

- N is the resolution in bits, 12.
- DAC_DATA is the decimal equivalent of the binary code that is loaded to the DAC-X-DATA field in the DAC-X-DATA register. DAC_DATA ranges from 0 to 2^N – 1.
- V_{REF} is the external reference voltage.

7.4.1.1.3 Power-Supply as Reference

The DAC63202W can operate with the power-supply pin (V_{DD}) as a reference. 式 2 shows DAC transfer function when the power-supply pin is used as reference. The gain at the output stage is always 1 ×.

$$V_{OUT} = \frac{DAC_DATA}{2^N} \times V_{DD} \quad (3)$$

where:

- N is the resolution in bits, 12.
- DAC_DATA is the decimal equivalent of the binary code that is loaded to the DAC-X-DATA bit in the DAC-X-DATA register.
- DAC_DATA ranges from 0 to 2^N – 1.
- V_{DD} is used as the DAC reference voltage.

7.4.2 Current-Output Mode

To enter current-output mode for each DAC channel, disable the respective IOUT-PDN-X bits in the COMMON-CONFIG register, and set the respective VOUT-PDN-X bits in the same register to Hi-Z power-down mode. Select the desired current-output range by writing to the IOUT-RANGE-X bit in the DAC-X-IOUT-MISC-CONFIG register. To minimize leakage in current-output mode, disconnect the FBx pin. For the best power-on glitch performance, program the NVM with IOUT mode using the smallest output range before powering on the output channel, and then immediately program the DAC code and desired output range. The transfer function of the output current is shown in 式 4.

$$I_{OUT} = \frac{DAC_DATA \times (I_{MAX} - I_{MIN})}{2^8} + I_{MIN} \quad (4)$$

where:

- DAC_DATA is the decimal equivalent of the binary code that is loaded to the DAC-X-DATA bit as specified in [セクション 7.6.8](#). DAC_DATA ranges from 0 to 255.
- I_{MAX} is the signed maximum current in the IOUT-RANGE-X setting as specified in [セクション 7.6.5](#).
- I_{MIN} is the signed minimum current in the IOUT-RANGE-X setting as specified in [セクション 7.6.5](#).

7.4.3 Comparator Mode

All the DAC channels can be configured as programmable comparators in the voltage-output mode. To enter the comparator mode for a channel, write 1 to the CMP-X-EN bit in the respective DAC-X-VOUT-CMP-CONFIG register. The comparator output can be configured as push-pull or open-drain using the CMP-X-OD-EN bit. To enable the comparator output on the output pin, write 1 to the CMP-X-OUT-EN bit. To invert the comparator output, write 1 to the CMP-X-INV-EN bit. The FBx pin has a finite impedance. By default, the FBx pin is in the high-impedance mode. To disable high-impedance on the FBx pin, write 1 to the CMP-X-HIZ-IN-DIS bit. 表 7-1 shows the comparator output at the pin for different bit settings.

注

In the Hi-Z input mode, the comparator input range is limited to:

- For GAIN = 1x, 1.5x, or 2x: $V_{FB} \leq (V_{REF} \times GAIN) / 3$
- For GAIN = 3x, or 4x: $V_{FB} \leq (V_{REF} \times GAIN) / 6$

Any higher input voltage is clipped.

表 7-1. Comparator Output Configuration

CMP-X-EN	CMP-X-OUT-EN	CMP-X-OD-EN	CMP-X-INV-EN	CMPX-OUT PIN
0	X	X	X	Comparator not enabled
1	0	X	X	No output
1	1	0	0	Push-pull output
1	1	0	1	Push-pull and inverted output
1	1	1	0	Open-drain output
1	1	1	1	Open-drain and inverted output

图 7-3 shows the interface circuit when all the DAC channels are configured as comparators. The programmable comparator operation is as shown in 图 7-4. Individual comparator channels can be configured in no-hysteresis, with-hysteresis, and window-comparator modes using the CMP-X-MODE bit in the respective DAC-X-CMP-MODE-CONFIG register, as shown in 表 7-2.



图 7-3. Comparator Interface



图 7-4. Programmable Comparator Operation

表 7-2. Comparator Mode Selection

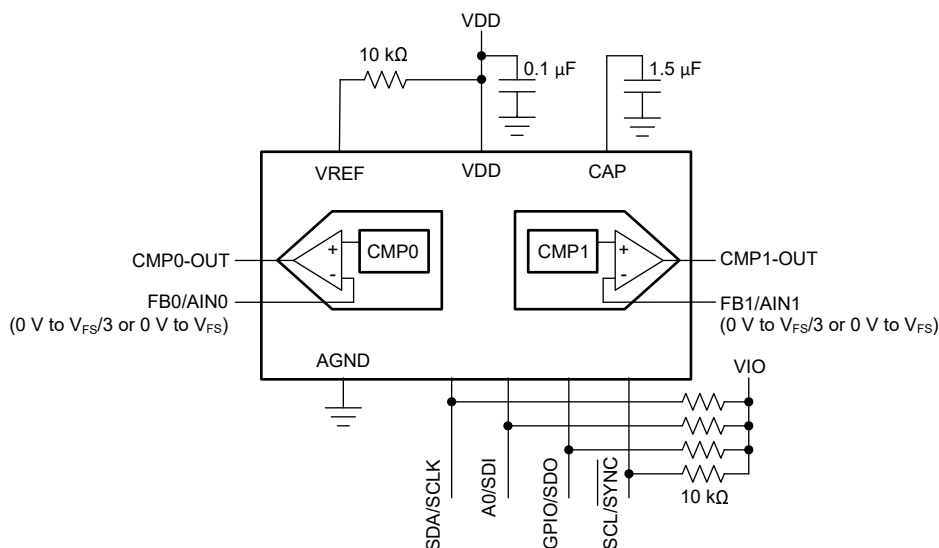
CMP-X-MODE BIT FIELD	COMPARATOR CONFIGURATION
00	Normal comparator mode. No hysteresis or window operation.
01	Hysteresis comparator mode. DAC-X-MARGIN-HIGH and DAC-X-MARGIN-LOW registers set the hysteresis.
10	Window comparator mode. DAC-X-MARGIN-HIGH and DAC-X-MARGIN-LOW registers set the window bounds.
11	Invalid setting

7.4.3.1 Programmable Hysteresis Comparator

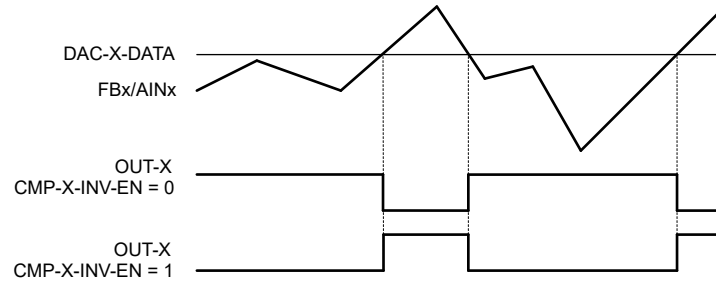
表 7-2 shows that comparator mode provides hysteresis when the CMP-X-MODE bit is set to 01b. 図 7-5 shows that the hysteresis is provided by the DAC-X-MARGIN-HIGH and DAC-X-MARGIN-LOW registers.

When the DAC-X-MARGIN-HIGH is set to full-code or the DAC-X-MARGIN-LOW is set to zero-code, the comparator works as a latching comparator that is, the output is latched after the threshold is crossed. The latched output can be reset by writing to the corresponding RST-CMP-FLAG-X bit in the COMMON-DAC-TRIG register. 図 7-6 shows the behavior of a latching comparator with active low output, and 図 7-7 shows the behavior of a latching comparator with active high output.

注

The value of the DAC-X-MARGIN-HIGH register must be greater than the value of the DAC-X-MARGIN-LOW register. The comparator output in the hysteresis mode can only be noninverting; that is, the CMP-X-INV-EN bit in the DAC-X-VOUT-CMP-CONFIG register must be set to 0. For the reset to take effect in latching mode, the input voltage must be within DAC-X-MARGIN-HIGH and DAC-X-MARGIN-LOW.



図 7-5. Programmable Hysteresis Without Latching Output



図 7-6. Latching Comparator With Active Low Output

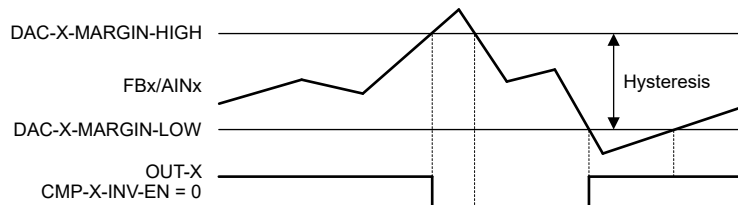

図 7-7. Latching Comparator With Active High Output

7.4.3.2 Programmable Window Comparator

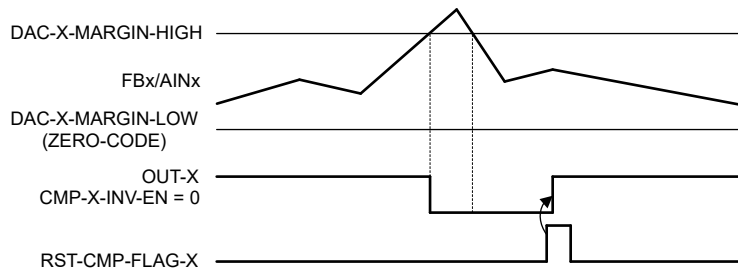
Window comparator mode is enabled by setting the CMP-X-MODE bit to 10b (see also 表 7-2). 図 7-8 shows that the window bounds are set by the DAC-X-MARGIN-HIGH and the DAC-X-MARGIN-LOW registers. The output of the window comparator for a given channel is indicated by the respective WIN-CMP-X bit in the CMP-STATUS register. The comparator output (WIN-CMP-X) can be latched by writing 1 to the WIN-LATCH-EN bit in the COMMON-CONFIG register. After being latched, the comparator output can be reset using the corresponding RST-CMP-FLAG-X bit in the COMMON-DAC-TRIG register. For the reset to take effect, the input must be within the window bounds.

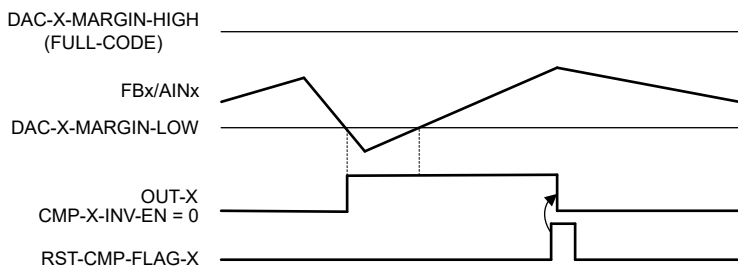

図 7-8. Window Comparator Operation

A single comparator is used per channel to check both the *margin-high* and *margin-low* limits of the window. Therefore, the window comparator function has a finite response time (see also セクション 6.7). The static behavior of the WIN-CMP-X bit is not reflected at the output pins. Set the CMP-X-OUT-EN bit to 0. The WIN-CMP-X bit must be read digitally using the communication interface. This bit can also be mapped to the GPIO pin (see also 表 7-19).

注

- The value of the DAC-X-MARGIN-HIGH register must be greater than that of the DAC-X-MARGIN-LOW register.
- Set the SLEW-RATE-X bit to 0000b (no-slew) and LOG-SLEW-EN-X bit to 0b in the DAC-X-FUNC-CONFIG register to get the best response time from the window comparator.
- The CMP-X-OUT-EN bit in the DAC-X-VOUT-CMP-CONFIG register can be set to 0b to eliminate undesired toggling of the OUT pin.

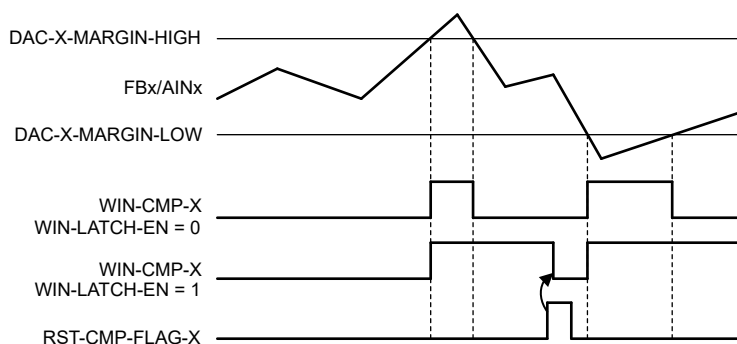
7.4.4 Fault-Dump Mode

The DAC63202W provides a feature to save a few registers into the NVM when the FAULT-DUMP bit is triggered or when the GPIO mapped to fault-dump is triggered (see also [表 7-18](#)). This feature is useful in system-level fault management to capture the state of the device or system just before a fault is triggered, and to allow diagnosis after the fault has occurred. The registers saved when fault-dump is triggered, are:

- CMP-STATUS[7:0]
- DAC-0-DATA[15:8]
- DAC-1-DATA[15:8]

注

When the fault-dump cycle is in progress, any change in the data can corrupt the final outcome. Make sure the comparator and the DAC codes are stable during the NVM write cycle.

[表 7-3](#) shows the storage format of the registers in the NVM.

表 7-3. Fault-Dump NVM Storage Format

NVM ROWS	B31-B24	B23-B16	B15-B8	B7-B0
Row1	CMP-STATUS[7:0]	Don't care		
Row2	DAC-1-DATA[15:8]	Don't care		DAC-1-DATA[15:8]

The data captured in the NVM after the fault dump can be read in a specific sequence:

1. Set the EE-READ-ADDR bit to 0b in the COMMON-CONFIG register, to select row1 of the NVM.
2. Trigger the read of the selected NVM row by writing 1 to the READ-ONE-TRIG in the COMMON-TRIGGER register; this bit autoresets. This action copies that data from the selected NVM row to SRAM addresses 0x9D (LSB 16 bits from the NVM) and 0x9E (MSB 16 bits from the NVM).
3. To read the SRAM data:
 - a. Write 0x009D to the SRAM-CONFIG register.
 - b. Read the data from the SRAM-DATA register to get the LSB 16 bits.
 - c. Write 0x009E to the SRAM-CONFIG register.
 - d. Read the data from the SRAM-DATA register again to get the MSB bits.
4. Set the EE-READ-ADDR bit to 1b in the COMMON-CONFIG register, to select row2 of the NVM. Repeat steps 2 and 3.

7.4.5 Application-Specific Modes

This section provides the details of application-specific functional modes available in the DAC63202W.

7.4.5.1 Voltage Margining and Scaling

Voltage margining or scaling is a primary application for the DAC63202W. This section provides specific features available for this application such as Hi-Z output, slew-rate control, $\overline{\text{PROTECT}}$ input, and PMBus compatibility.

7.4.5.1.1 High-Impedance Output and $\overline{\text{PROTECT}}$ Input

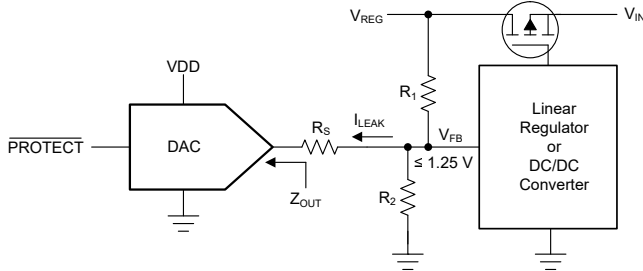
All the DAC output channels remain in a high-impedance state (Hi-Z) when VDD is off.  shows a simplified schematic of the DAC63202W used in a voltage-margining application. The series resistor R_S is needed in voltage-output mode, but is optional in current-output mode. Almost all linear regulators and DC/DC converters have a feedback voltage of ≤ 1.25 V. The low-leakage currents at the outputs are maintained for V_{FB} of ≤ 1.25 V. Thus, for all practical purposes, the DAC outputs appear as Hi-Z when VDD of the DAC is off in voltage margining and scaling applications. This feature allows for seamless integration of the DAC63202W into a system without any need for additional power-supply sequencing for the DAC.

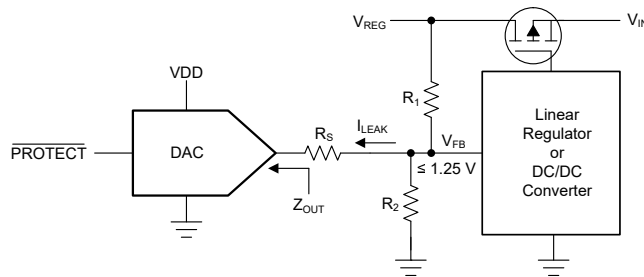

 **7-9. High-Impedance (Hi-Z) Output and $\overline{\text{PROTECT}}$ Input**

The DAC channels power down to Hi-Z at boot up. The outputs can power up with a preprogrammed code that corresponds to the nominal output of the DC/DC converter or the linear regulator. This feature allows for smooth power up and power down of the DAC without impacting the feedback loop of the DC/DC converter or the linear regulator.

表 7-18 shows how the GPIO pin of the DAC63202W can be configured as a $\overline{\text{PROTECT}}$ function. $\overline{\text{PROTECT}}$ takes the DAC outputs to a predictable state with a slewed or direct transition. This function is useful in systems where a fault condition (such as a brownout), a subsystem failure, or a software crash requires that the DAC outputs reach a predefined state without the involvement of a processor. The detected event can be fed to the GPIO pin that is configured as the $\overline{\text{PROTECT}}$ input. The $\overline{\text{PROTECT}}$ function can also be triggered using the PROTECT bit in the COMMON-TRIGGER register. 表 7-4 shows how to configure the behavior of the $\overline{\text{PROTECT}}$ function in the PROTECT-CONFIG field in the DEVICE-MODE-CONFIG register.

注

- After the $\overline{\text{PROTECT}}$ function is triggered, the write functionality is disabled on the communication interface until the function is completed.
- The PROTECT-FLAG bit in the CMP-STATUS register is set to 1 when the $\overline{\text{PROTECT}}$ function is triggered. This bit can be polled by reading the CMP-STATUS register. After the $\overline{\text{PROTECT}}$ function is complete, a read command on the CMP-STATUS register resets the PROTECT-FLAG bit.

表 7-4. $\overline{\text{PROTECT}}$ Function Configuration

PROTECT-CONFIG FIELD	FUNCTION
00	Switch to Hi-Z power-down (no slew).
01	Switch to DAC code stored in NVM (no slew) and then switch to Hi-Z power-down.
10	Slew to margin-low code and then switch to Hi-Z power-down.

表 7-4. PROTECT Function Configuration (continued)

PROTECT-CONFIG FIELD	FUNCTION
11	Slew to margin-high code and then switch to Hi-Z power-down.

7.4.5.1.2 Programmable Slew-Rate Control

When the DAC data registers are written, the voltage on DAC output (V_{OUT}) immediately transitions to the new code following the slew rate and settling time specified in the *Electrical Characteristics*.

The slew rate control feature allows the user to control the rate at which the output voltage (V_{OUT}) changes. When this feature is enabled (using the SLEW-RATE-X[3:0] bits), the DAC output changes from the current code to the code in the DAC-X-MARGIN-HIGH or DAC-X-MARGIN-LOW registers (when margin high or low commands are issued to the DAC) using the step size and time-period per step set in CODE-STEP-X and SLEW-RATE-X bits in the DAC-X-FUNC-CONFIG register:

- SLEW-RATE-X defines the time-period per step at which the digital slew updates.
- CODE-STEP-X defines the number of LSBs by which the output value changes at each update, for the corresponding channels.

表 7-5 和 表 7-6 show different settings available for CODE-STEP-X and SLEW-RATE-X. With the default slew rate control setting of no-slew, the output changes immediately at a rate limited by the output drive circuitry and the attached load.

When the slew rate control feature is used, the output changes happen at the programmed slew rate. 图 7-10 shows that this configuration results in a staircase formation at the output. Do not write to CODE-STEP-X, SLEW-RATE-X, or DAC-X-DATA during the output slew operation. 式 5 provides the equation for the calculating the slew time (t_{SLEW}).



图 7-10. Programmable Slew-Rate Control

$$t_{SLEW} = SLEW_RATE \times CEILING\left(\frac{MARGIN_HIGH - MARGIN_LOW}{CODE_STEP} + 1\right) \quad (5)$$

where:

- SLEW_RATE is the SLEW-RATE-X setting specified in 表 7-6.
- CODE_STEP is the CODE-STEP-X setting specified in 表 7-5.
- MARGIN_HIGH is the decimal value of the DAC-X-MAGIN-HIGH bits in the DAC-X-MARGIN-HIGH register.
- MARGIN_LOW is the decimal value of the DAC-X-MAGIN-LOW bits in the DAC-X-MARGIN-LOW register.

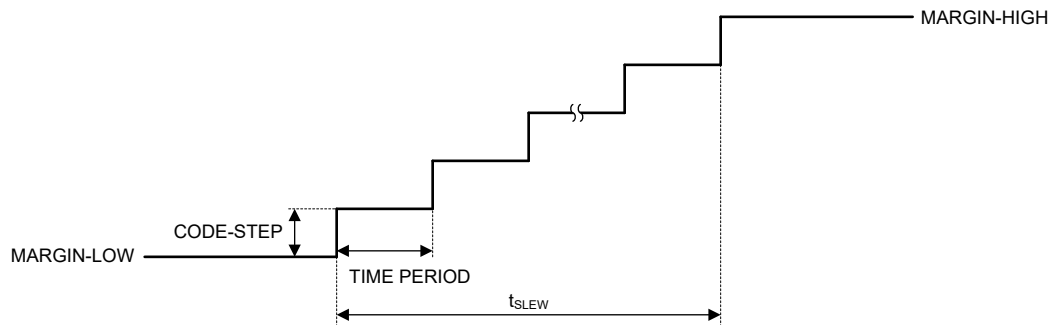
表 7-5. Code Step

REGISTER	CODE-STEP-X[2]	CODE-STEP-X[1]	CODE-STEP-X[0]	CODE STEP SIZE
DAC-X-FUNC-CONFIG	0	0	0	1 LSB (default)
	0	0	1	2 LSB
	0	1	0	3 LSB
	0	1	1	4 LSB
	1	0	0	6 LSB
	1	0	1	8 LSB
	1	1	0	16 LSB
	1	1	1	32 LSB

表 7-6. Slew Rate

REGISTER	SLEW-RATE-X[3]	SLEW-RATE-X[2]	SLEW-RATE-X[1]	SLEW-RATE-X[0]	TIME PERIOD (PER STEP)
DAC-X-FUNC-CONFIG	0	0	0	0	No slew (default)
	0	0	0	1	4 μ s
	0	0	1	0	8 μ s
	0	0	1	1	12 μ s
	0	1	0	0	18 μ s
	0	1	0	1	27 μ s
	0	1	1	0	40.5 μ s
	0	1	1	1	60.75 μ s
	1	0	0	0	91.13 μ s
	1	0	0	1	136.69 μ s
	1	0	1	0	239.2 μ s
	1	0	1	1	418.61 μ s
	1	1	0	0	732.56 μ s
	1	1	0	1	1281.98 μ s
	1	1	1	0	2563.96 μ s
	1	1	1	1	5127.92 μ s

7.4.5.1.3 PMBus Compatibility Mode

The PMBus protocol is an I²C-based communication standard for power-supply management. PMBus contains standard command codes tailored to power supply applications. The DAC63202W implement some PMBus commands such as *Turn Off*, *Turn On*, *Margin Low*, *Margin High*, *Communication Failure Alert Bit (CML)*, as well as *PMBUS revision*. [Figure 7-11](#) shows typical PMBus connections. The EN-PMBUS bit in the INTERFACE-CONFIG register must be set to 1 to enable the PMBus protocol.

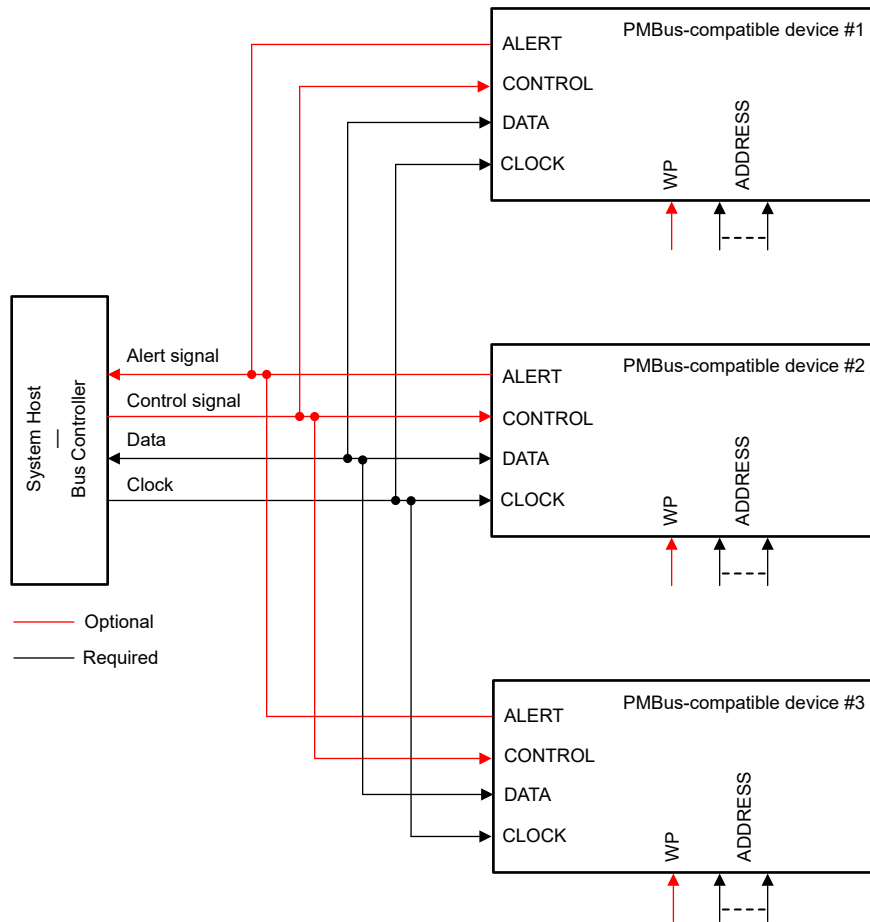

Figure 7-11. PMBus Connections

Similar to I²C, PMBus is a variable length packet of 8-bit data bytes, each with a receiver acknowledge, wrapped between a start and stop bit. The first byte is always a 7-bit *target address* followed by a *write* bit, sometimes called the *even address*, that identifies the intended receiver of the packet. The second byte is an 8-bit *command* byte, identifying the PMBus command being transmitted using the respective command code. After the command byte, the transmitter either sends data associated with the command to write to the receiver command register (from least significant byte to most significant byte; see also 表 7-7), or sends a new start bit indicating the desire to read the data associated with the command register from the receiver. Then the receiver transmits the data following the same least significant byte first format; see also 表 7-8.

表 7-7. PMBus Update Sequence

MSB	...	LSB	ACK	MSB	...	LSB	ACK	MSB	...	LSB	ACK	MSB	...	LSB	ACK
Address (A) byte セクション 7.5.2.2.1				Command byte セクション 7.5.2.2.2				Data byte - LSDB				Data byte - MSDB (Optional)			
DB [31:24]				DB [23:16]				DB [15:8]				DB [7:0]			

表 7-8. PMBus Read Sequence

S	MSB	...	R/W (0)	ACK	MSB	...	LSB	ACK	Sr	MSB	...	R/W (1)	ACK	MSB	...	LSB	ACK	MSB	...	LSB	ACK
	Address byte セクション 7.5.2.2.1				Command byte セクション 7.5.2.2.2				Sr	Address byte セクション 7.5.2.2.1				LSDB				MSDB (Optional)			
	From controller			Target	From controller			Target		From controller			Target	From target			Controller	From target			Controller

The DAC63202W I²C interface implements some of the PMBus commands. 表 7-9 shows the supported PMBus commands that are implemented in DAC63202W. The DAC uses DAC-X-MARGIN-LOW, DAC-X-MARGIN-HIGH bits, SLEW-RATE-X, and CODE-STEP-X bits for PMBUS-OPERATION-CMD-X. To access multiple channels, write the PMBus page address specified in the *Register Names* table in the *Register Map* section to the PMBUS-PAGE register first, followed by a write to the channel-specific register.

表 7-9. PMBus Operation Commands

REGISTER	PMBUS-OPERATION-CMD-X[15:8]	DESCRIPTION
PMBUS-OP-CMD-X	00h	Turn off
	80h	Turn on
	94h	Margin low
	A4h	Margin high

The DAC63202W also implement PMBus features such as group command protocol and communication timeout failure. The CML bit in the PMBUS-CML register indicates a communication fault in the PMBus. This bit is reset by writing 1.

To get the PMBus version, read the PMBUS-VERSION register.

7.4.5.2 Function Generation

The DAC63202W implement a continuous function or waveform generation feature. These devices can generate a triangular wave, sawtooth wave, and sine wave independently for every channel.

7.4.5.2.1 Triangular Waveform Generation

 [7-12](#) shows that the triangular waveform uses the DAC-X-MARGIN-LOW (FUNCTION-MIN) and DAC-X-MARGIN-HIGH (FUNCTION-MAX) registers for minimum and maximum levels, respectively. The frequency of the waveform depends on the min and max levels, CODE-STEP and SLEW-RATE settings as shown in [式 6](#). An external RC load with a time-constant larger than the slew-rate settings can be dominant over the internal frequency calculation. The CODE-STEP-X and SLEW-RATE-X settings are available in the DAC-X-FUNC-CONFIG register. Writing 0b000 to the FUNC-CONFIG-X bit field in the DAC-X-FUNC-CONFIG register selects triangular waveform.

$$f_{\text{TRIANGLE}} = \frac{1}{2 \times \text{TIME_STEP} \times \text{CEILING}\left(\frac{\text{FUNCTION_MAX} - \text{FUNCTION_MIN}}{\text{CODE_STEP}}\right)} \quad (6)$$

where

- TIME_STEP is the SLEW-RATE-X setting specified in [表 7-6](#).
- CODE_STEP is the CODE-STEP-X setting specified in [表 7-5](#).
- FUNCTION_MAX is the decimal value of DAC-X-MAGIN-HIGH bits in the DAC-X-MARGIN-HIGH register.
- FUNCTION_MIN is the decimal value of the DAC-X-MAGIN-LOW bits in the DAC-X-MARGIN-LOW register.

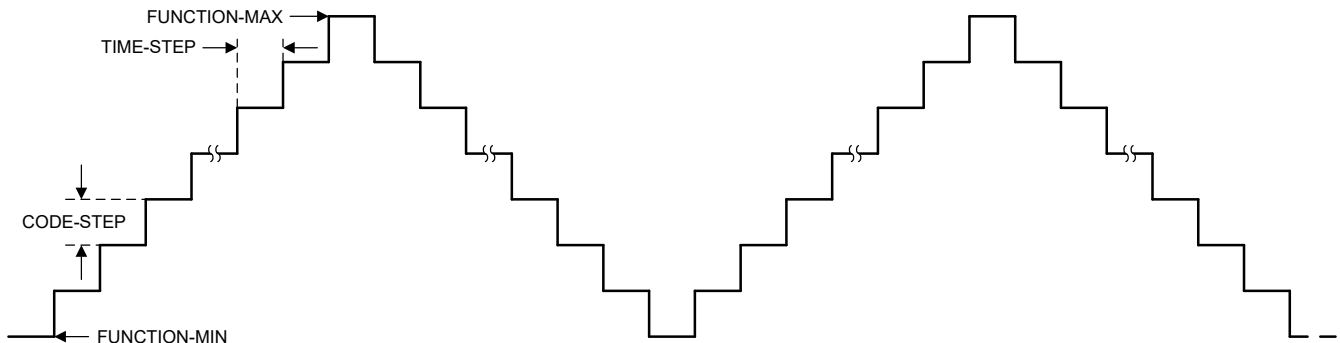

 **7-12. Triangle Waveform**

7.4.5.2.2 Sawtooth Waveform Generation

Figure 7-13 shows the sawtooth and the inverse sawtooth waveforms use the DAC-X-MARGIN-LOW (FUNCTION-MIN) and DAC-X-MARGIN-HIGH (FUNCTION-MAX) registers for minimum and maximum levels, respectively. The frequency of the waveform depends on the min and max levels, CODE-STEP and SLEW-RATE settings as shown in Equation 7. An external RC load with a time constant larger than the slew-rate settings can be dominant over the internal frequency calculation. The CODE-STEP-X and SLEW-RATE-X settings are available in the DAC-X-FUNC-CONFIG register. Write 0b001 to the FUNC-CONFIG-X bit field in the DAC-X-FUNC-CONFIG register to select sawtooth waveform, and write 0b010 to select inverse sawtooth waveform.

$$f_{\text{SAWTOOTH}} = \frac{1}{\text{TIME_STEP} \times \text{CEILING}\left(\frac{\text{FUNCTION_MAX} - \text{FUNCTION_MIN}}{\text{CODE_STEP}} + 1\right)} \quad (7)$$

where

- TIME_STEP is the SLEW-RATE-X setting specified in Table 7-6.
- CODE_STEP is the CODE-STEP-X setting specified in Table 7-5.
- FUNCTION_MAX is the decimal value of the DAC-X-MARGIN-HIGH bits in the DAC-X-MARGIN-HIGH register.
- FUNCTION_MIN is the decimal value of the DAC-X-MARGIN-LOW bits in the DAC-X-MARGIN-LOW register.

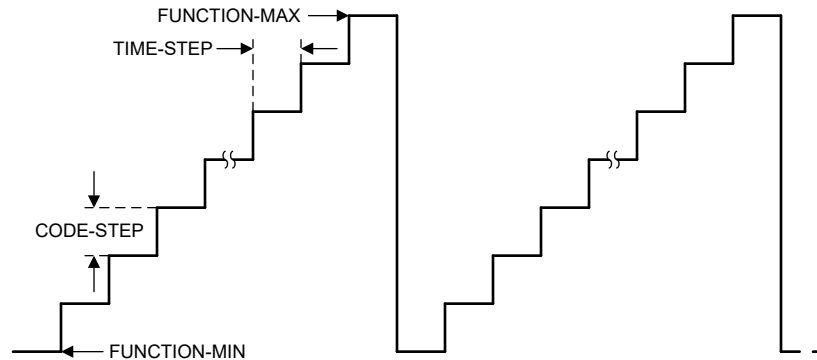

Figure 7-13. Sawtooth Waveform

7.4.5.2.3 Sine Waveform Generation

The sine wave function uses 24 preprogrammed points per cycle. The frequency of the sine wave depends on the SLEW-RATE settings as shown in 式 8:

$$f_{\text{SINE_WAVE}} = \frac{1}{24 \times \text{SLEW_RATE}} \quad (8)$$

where SLEW_RATE is the SLEW-RATE-X setting as specified in 表 7-6.

An external RC load with a time constant larger than the slew-rate settings can be dominant over the internal frequency calculation. The SLEW-RATE-X setting is available in the DAC-X-FUNC-CONFIG register. Writing 0b100 to the FUNC-CONFIG-X bit field in the DAC-X-FUNC-CONFIG register selects sine wave. The codes for the sine wave are fixed. Use the gain settings at the output amplifier for changing the full-scale output using the internal reference option. The gain settings are accessible through the VOUT-GAIN-X bits in the DAC-X-VOUT-CMP-CONFIG register. 表 7-10 shows the list of hard-coded discrete points for the sine wave with 12-bit resolution and 图 7-14 shows the pictorial representation of the sine wave. There are four phase settings available for the sine wave that are selected using the PHASE-SEL-X bit in the DAC-X-FUNC-CONFIG register.

表 7-10. Sine Wave Data Points

SEQUENCE	12-BIT VALUE	SEQUENCE	12-BIT VALUE
0 (0° phase start)	0x800	12	0x800
1	0x9A8	13	0x658
2	0xB33	14	0x4CD
3	0xC87	15	0x379
4	0xD8B	16 (240° phase start)	0x275
5	0xE2F	17	0x1D1
6 (90° phase start)	0xE66	18	0x19A
7	0xE2F	19	0x1D1
8 (120° phase start)	0xD8B	20	0x275
9	0xC87	21	0x379
10	0xB33	22	0x4CD
11	0x9A8	23	0x658



图 7-14. Sine Wave Generation

7.4.6 Device Reset and Fault Management

This section provides the details of power-on-reset (POR), software reset, and other diagnostics and fault-management features of DAC63202W.

7.4.6.1 Power-On Reset (POR)

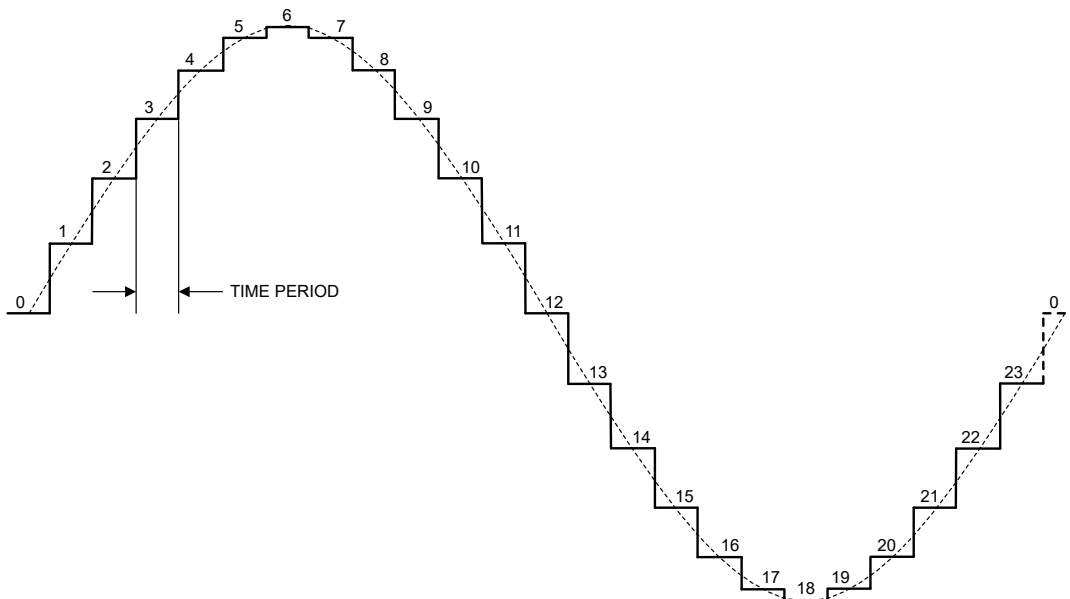
The DAC63202W family of devices includes a power-on reset (POR) function that controls the output voltage at power up. After the V_{DD} supply has been established, a POR event is issued. The POR causes all registers to initialize to default values, and communication with the device is valid only after a POR (boot-up) delay. The default value for all the registers in the DAC63202W is loaded from NVM as soon as the POR event is issued.

When the device powers up, a POR circuit sets the device to the default mode. [Figure 7-15](#) indicates that the POR circuit requires specific V_{DD} levels to make sure that the internal capacitors discharge and reset the device at power up. To make sure that a POR occurs, V_{DD} must be less than 0.7 V for at least 1 ms. When V_{DD} drops to less than 1.65 V, but remains greater than 0.7 V (shown as the undefined region), the device may or may not reset under all specified temperature and power-supply conditions. In this case, initiate a POR. When V_{DD} remains greater than 1.65 V, a POR does not occur.

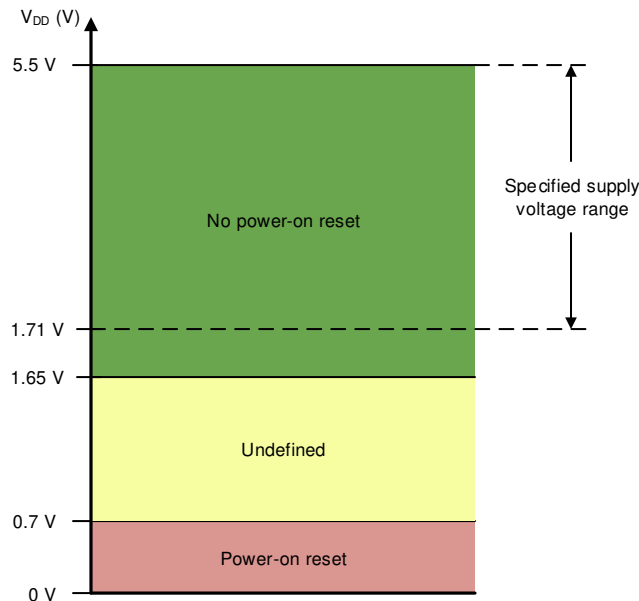

Figure 7-15. Threshold Levels for V_{DD} POR Circuit

7.4.6.2 External Reset

An external reset to the device can be triggered through the GPIO pin or through the register map. To initiate a device software reset event, write the reserved code 1010 to the RESET field in the COMMON-TRIGGER register. A software reset initiates a POR event. [Table 7-18](#) shows how the GPIO pin can be configured as a RESET pin. This configuration must be programmed into the NVM so that the setting is not cleared after the device reset. The RESET input must be a low pulse. The device starts the boot-up sequence after the falling edge of the RESET input. The rising edge of the RESET input does not have any effect.

7.4.6.3 Register-Map Lock

The DAC63202W implement a register-map lock feature that prevents an accidental or unintended write to the DAC registers. The device locks all the registers when the DEV-LOCK bit in the COMMON-CONFIG register is set to 1. However, the software reset function through the COMMON-TRIGGER register is not blocked when using the I²C interface. To bypass the DEV-LOCK setting, write 0101 to the DEV-UNLOCK bits in the COMMON-TRIGGER register.

7.4.6.4 NVM Cyclic Redundancy Check (CRC)

The DAC63202W implement a cyclic redundancy check (CRC) feature for the NVM to make sure that the data stored in the NVM is uncorrupted. There are two types of CRC alarm bits implemented in DAC63202W:

- NVM-CRC-FAIL-USER
- NVM-CRC-FAIL-INT

The NVM-CRC-FAIL-USER bit indicates the status of user-programmable NVM bits, and the NVM-CRC-FAIL-INT bit indicates the status of internal NVM bits. The CRC feature is implemented by storing a 16-bit CRC (CRC-16-CCITT) along with the NVM data each time NVM program operation (write or reload) is performed and during the device start up. The device reads the NVM data and validates the data with the stored CRC. The CRC alarm bits (NVM-CRC-FAIL-USER and NVM-CRC-FAIL-INT in the GENERAL-STATUS register) report any errors after the data are read from the device NVM. The alarm bits are set only at boot up.

7.4.6.4.1 NVM-CRC-FAIL-USER Bit

A logic 1 on NVM-CRC-FAIL-USER bit indicates that the user-programmable NVM data are corrupt. During this condition, all registers in the DAC are initialized with factory reset values, and any DAC registers can be written to or read from. To reset the alarm bits to 0, issue a software reset (see also [セクション 7.4.6.2](#)) command, or cycle power to the DAC. A software reset or power-cycle also reloads the user-programmable NVM bits. In case the failure persists, reprogram the NVM.

7.4.6.4.2 NVM-CRC-FAIL-INT Bit

A logic 1 on NVM-CRC-FAIL-INT bit indicates that the internal NVM data are corrupt. During this condition, all registers in the DAC are initialized with factory reset values, and any DAC registers can be written to or read from. In case of a temporary failure, to reset the alarm bits to 0, issue a software reset (see also [セクション 7.4.6.2](#)) command or cycle power to the DAC. A permanent failure in the NVM makes the device unusable.

7.4.7 Power-Down Mode

The DAC63202W output amplifier and internal reference can be independently powered down through the EN-INT-REF, VOUT-PDN-X, and IOUT-PDN-X bits in the COMMON-CONFIG register (see also [Figure 7-2](#)). At power up, the DAC output and the internal reference are disabled by default. In power-down mode, the DAC outputs (OUTx pins) are in a high-impedance state. To change this state to 10 kΩ-AGND or 100 kΩ-AGND in the voltage-output mode (at power up), use the VOUT-PDN-X bits. The power-down state for current-output mode is always high-impedance.

The DAC power-up state can be programmed to any state (power-down or normal mode) using the NVM. [Table 7-11](#) shows the DAC power-down bits. The individual channel power-down bits or the global device power-down function can be mapped to the GPIO pin using the GPIO-CONFIG register.

表 7-11. DAC Power-Down Bits

REGISTER	VOUT-PDN-X[1]	VOUT-PDN-X[0]	IOUT-PDN-X	DESCRIPTION
COMMON-CONFIG	0	0	1	Power up VOUT-X.
	0	1	1	Power down VOUT-X with 10 kΩ to AGND. Power down IOUT-X to Hi-Z.
	1	0	1	Power down VOUT-X with 100 kΩ to AGND. Power down IOUT-X to Hi-Z.
	1	1	1	Power down VOUT-X to Hi-Z. Power down IOUT-X to Hi-Z (default).
	1	1	0	Power down VOUT-X to Hi-Z. Power up IOUT-X.

7.5 Programming

The DAC63202W are programmed through either a 3-wire SPI or 2-wire I²C interface. A 4-wire SPI mode is enabled by mapping the GPIO pin as SDO. The SPI readback operates at a lower SCLK than the standard SPI write operation. The type of interface is determined based on the first protocol to communicate after device power up. After the interface type is determined, the device ignores any change in the type while the device is on. The interface type can be changed after a power cycle.

7.5.1 SPI Programming Mode

An SPI access cycle for DAC63202W is initiated by asserting the $\overline{\text{SYNC}}$ pin low. The serial clock, SCLK, can be a continuous or gated clock. SDI data are clocked on SCLK falling edges. The SPI frame for DAC63202W is 24 bits long. Therefore, the $\overline{\text{SYNC}}$ pin must stay low for at least 24 SCLK falling edges. The access cycle ends when the $\overline{\text{SYNC}}$ pin is deasserted high. If the access cycle contains less than the minimum clock edges, the communication is ignored. By default, the SDO pin is not enabled (three-wire SPI). In the three-wire SPI mode, if the access cycle contains more than the minimum clock edges, only the first 24 bits are used by the device. When $\overline{\text{SYNC}}$ is high, the SCLK and SDI signals are blocked, and SDO becomes Hi-Z to allow data readback from other devices connected on the bus.

表 7-12 and 図 7-16 describe the format for the 24-bit SPI access cycle. The first byte input to SDI is the instruction cycle. The instruction cycle identifies the request as a read or write command and the 7-bit address that is to be accessed. The last 16 bits in the cycle form the data cycle.

表 7-12. SPI Read/Write Access Cycle

BIT	FIELD	DESCRIPTION
23	R/W	Identifies the communication as a read or write command to the address register: R/W = 0 sets a write operation. R/W = 1 sets a read operation
22-16	A[6:0]	Register address: specifies the register to be accessed during the read or write operation
15-0	D[15:0]	Data cycle bits: If a write command, the data cycle bits are the values to be written to the register with address A[6:0]. If a read command, the data cycle bits are <i>don't care</i> values.



図 7-16. SPI Write Cycle

Read operations require that the SDO pin is first enabled by setting the SDO-EN bit in the INTERFACE-CONFIG register. This configuration is called four-wire SPI. A read operation is initiated by issuing a read command access cycle. After the read command, a second access cycle must be issued to get the requested data. 表 7-13 and 図 7-17 show the output data format. Data are clocked out on the SDO pin either on the falling edge or rising edge of SCLK according to the FSDO bit (see also 図 6-3).

表 7-13. SDO Output Access Cycle

BIT	FIELD	DESCRIPTION
23	R/W	Echo R/W from previous access cycle
22-16	A[6:0]	Echo register address from previous access cycle

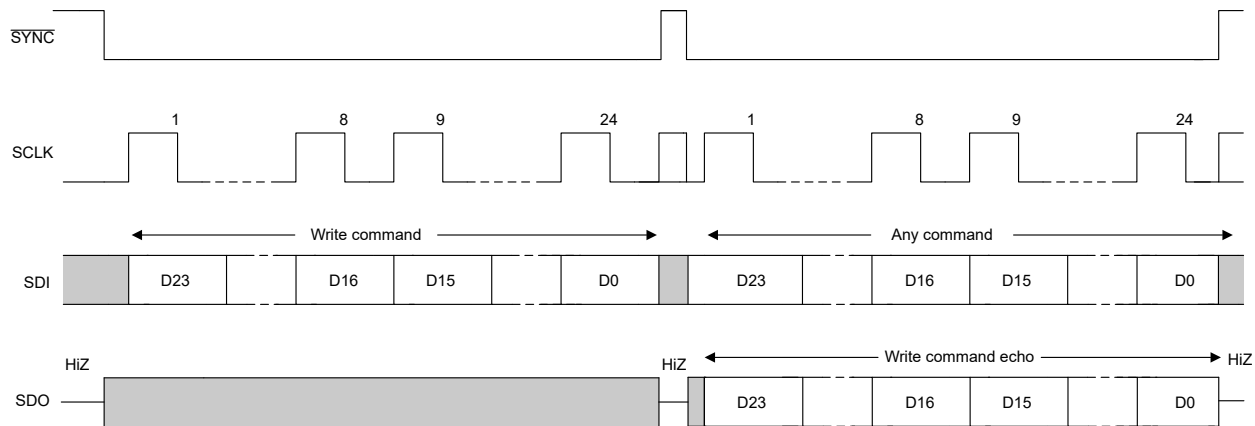
表 7-13. SDO Output Access Cycle (continued)

BIT	FIELD	DESCRIPTION
15-0	DI[15:0]	Readback data requested on previous access cycle



图 7-17. SPI Read Cycle

The daisy-chain operation is also enabled with the SDO pin. [图 7-18](#) shows that in daisy-chain mode, multiple devices are connected in a *chain* with the SDO pin of one device is connected to SDI pin of the following device. The SPI host drives the SDI pin of the first device in the chain. The SDO pin of the last device in the chain is connected to the POCI pin of the SPI host. In four-wire SPI mode, if the access cycle contains multiples of 24 clock edges, only the last 24 bits are used by the device first device in the chain. If the access cycle contains clock edges that are not in multiples of 24, the SPI packet is ignored by the device. [图 7-19](#) describes the packet format for the daisy-chain write cycle.



图 7-18. SPI Daisy-Chain Connection

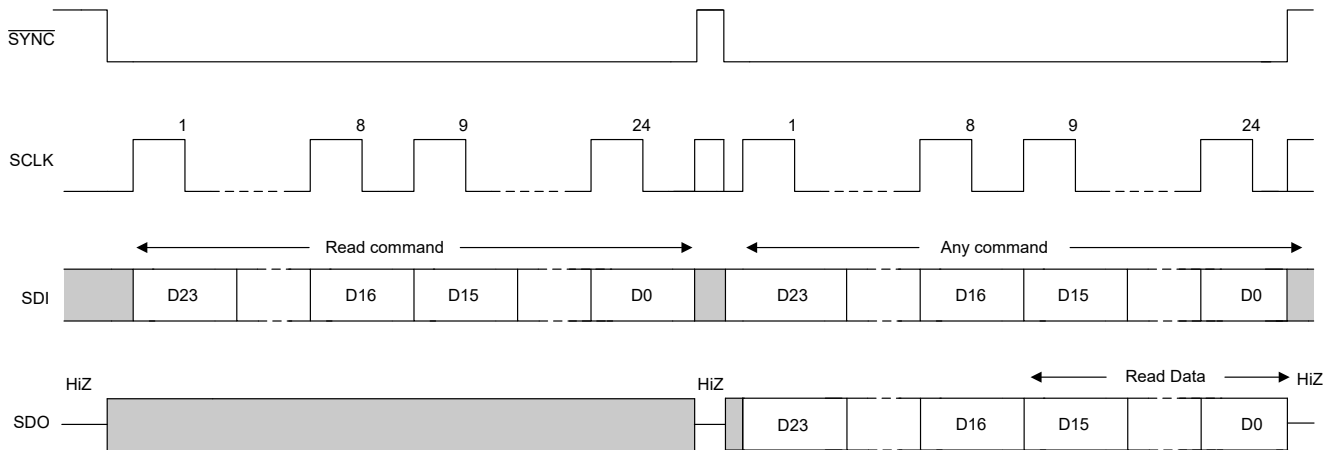

7-19. SPI Daisy-Chain Write Cycle

7.5.2 I²C Programming Mode

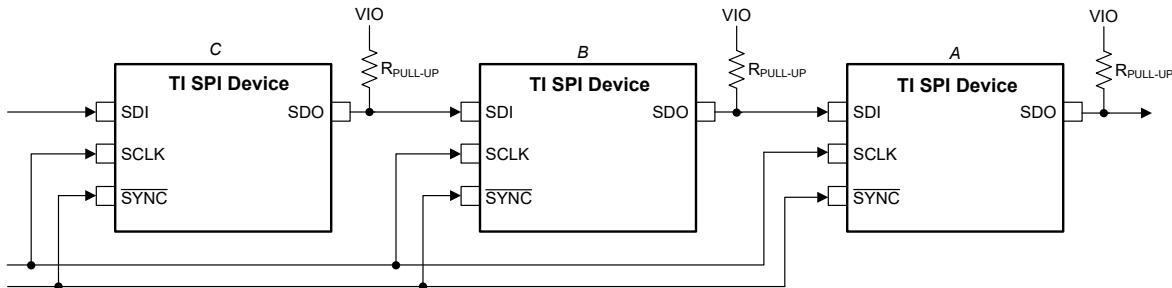
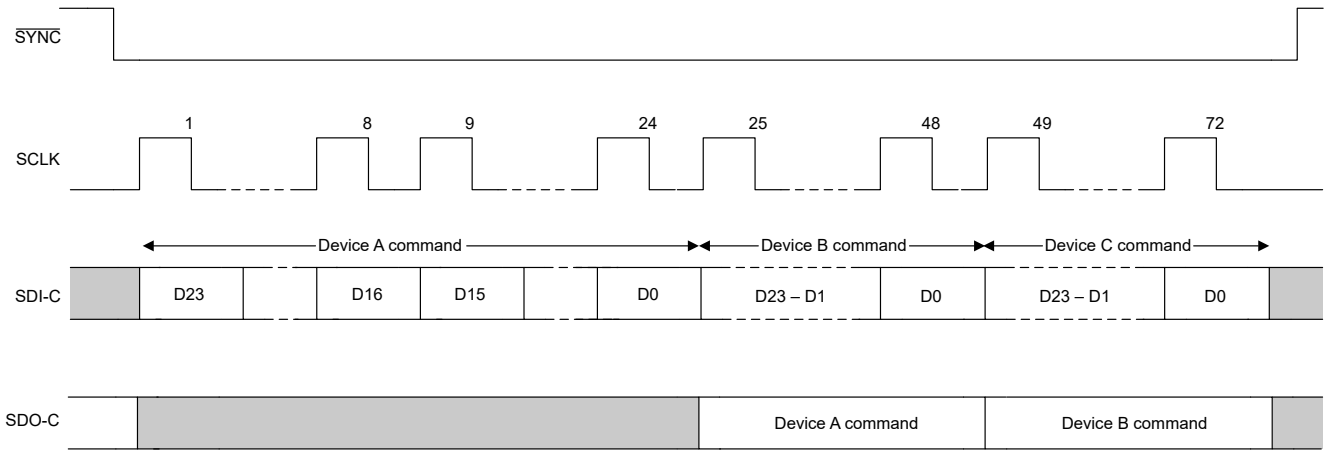
The DAC63202W devices have a 2-wire serial interface (SCL and SDA), and one address pin (A0); see also the pin diagram in the *Pin Configuration and Functions* section. The I²C bus consists of a data line (SDA) and a clock line (SCL) with pullup structures. When the bus is idle, both SDA and SCL lines are pulled high. All the I²C-compatible devices connect to the I²C bus through the open drain I/O pins, SDA and SCL.

The I²C specification states that the device that controls communication is called a *controller*, and the devices that are controlled by the controller are called *targets*. The controller generates the SCL signal. The controller also generates special timing conditions (start condition, repeated start condition, and stop condition) on the bus to indicate the start or stop of a data transfer. Device addressing is completed by the controller. The controller on an I²C bus is typically a microcontroller or digital signal processor (DSP). The DAC63202W family operates as a target on the I²C bus. A target acknowledges controller commands, and upon controller control, receives or transmits data.

Typically, the DAC63202W family operates as a target receiver. A controller writes to the DAC63202W, a target receiver. However, if a controller requires the DAC63202W internal register data, the DAC63202W operate as a target transmitter. In this case, the controller reads from the DAC63202W. According to I²C terminology, read and write refer to the controller.

The DAC63202W family supports the following data transfer modes:

- Standard mode (100kbps)
- Fast mode (400kbps)
- Fast mode plus (1.0Mbps)

The data transfer protocol for standard and fast modes is exactly the same; therefore, both modes are referred to as *F/S-mode* in this document. The fast mode plus protocol is supported in terms of data transfer speed, but not output current. The low-level output current is 3 mA; similar to the case of standard and fast modes. The DAC63202W family supports 7-bit addressing. The 10-bit addressing mode is not supported. The device supports the general call reset function. Sending the following sequence initiates a software reset within the device: start or repeated start, 0x00, 0x06, stop. The reset is asserted within the device on the rising edge of the ACK bit, following the second byte.

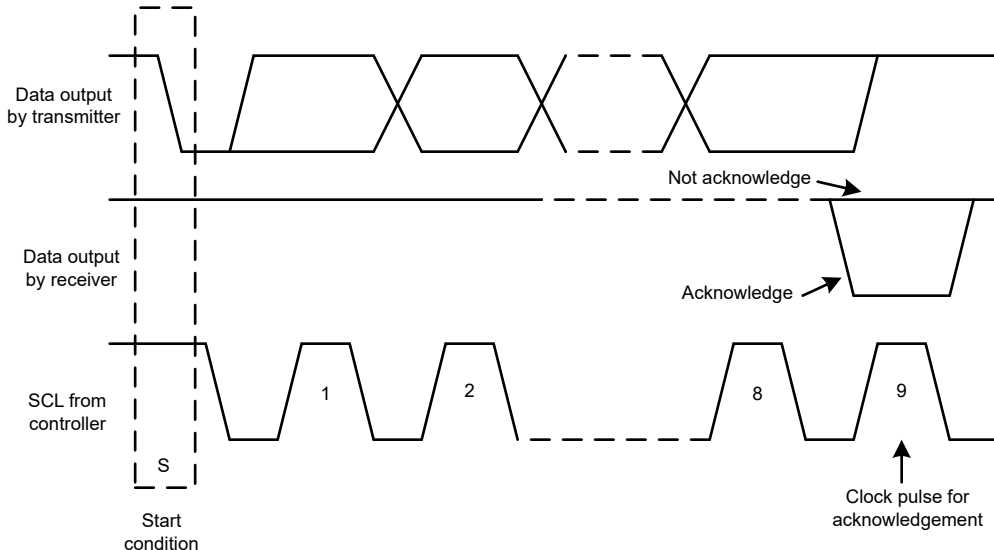
Other than specific timing signals, the I²C interface works with serial bytes. At the end of each byte, a ninth clock cycle generates and detects an acknowledge signal. An acknowledge is when the SDA line is pulled low during the high period of the ninth clock cycle.  depicts a not-acknowledge, when the SDA line is left high during the high period of the ninth clock cycle.

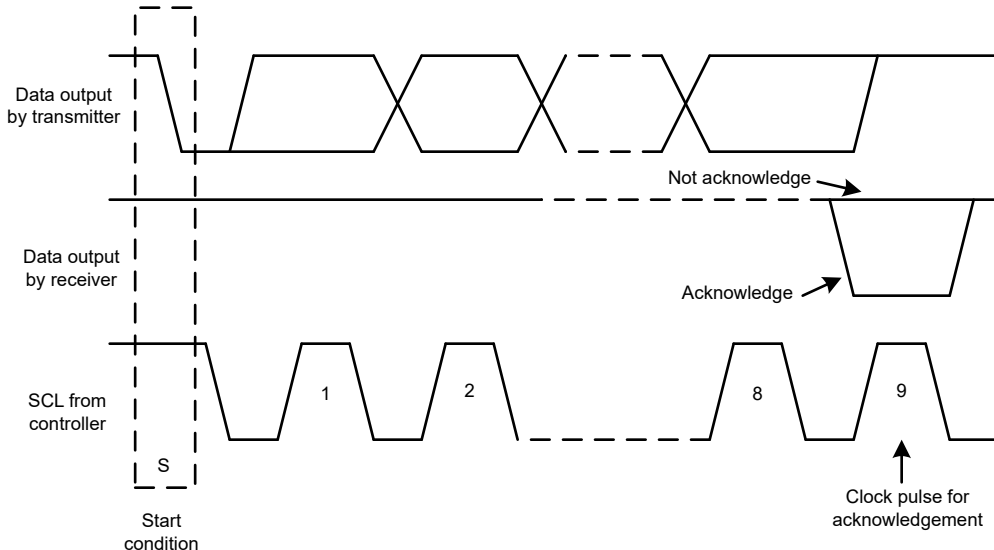

 **7-20. Acknowledge and Not Acknowledge on the I²C Bus**

7.5.2.1 F/S Mode Protocol

The following steps explain a complete transaction in F/S mode.

1. The controller initiates data transfer by generating a start condition. [Figure 7-21](#) shows that the start condition is when a high-to-low transition occurs on the SDA line while SCL is high. All I²C-compatible devices recognize a start condition.
2. The controller then generates the SCL pulses, and transmits the 7-bit address and the read/write direction bit (R/\overline{W}) on the SDA line. During all transmissions, the controller makes sure that data are valid. [Figure 7-22](#) shows that a valid data condition requires the SDA line to be stable during the entire high period of the clock pulse. All devices recognize the address sent by the controller and compare the address to the respective internal fixed address. Only the target device with a matching address generates an acknowledge by pulling the SDA line low during the entire high period of the 9th SCL cycle (see also [Figure 7-20](#)). When the controller detects this acknowledge, the communication link with a target has been established.
3. The controller generates further SCL cycles to transmit (R/\overline{W} bit 0) or receive (R/\overline{W} bit 1) data to the target. In either case, the receiver must acknowledge the data sent by the transmitter. The acknowledge signal can be generated by the controller or by the target, depending on which is the receiver. The 9-bit valid data sequences consists of eight data bits and one acknowledge-bit, and can continue as long as necessary.
4. [Figure 7-21](#) shows that to signal the end of the data transfer, the controller generates a stop condition by pulling the SDA line from low-to-high while the SCL line is high. This action releases the bus and stops the communication link with the addressed target. All I²C-compatible devices recognize the stop condition. Upon receipt of a stop condition, the bus is released, and all target devices then wait for a start condition followed by a matching address.

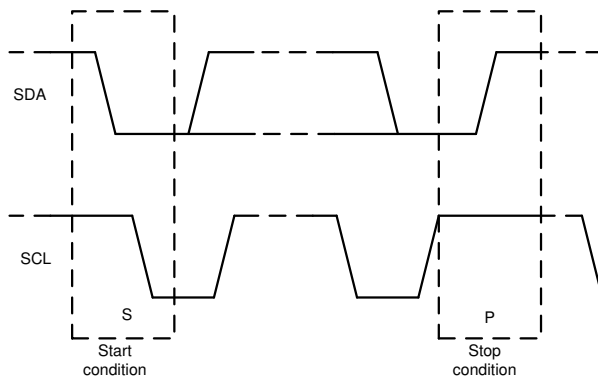

Figure 7-21. Start and Stop Conditions

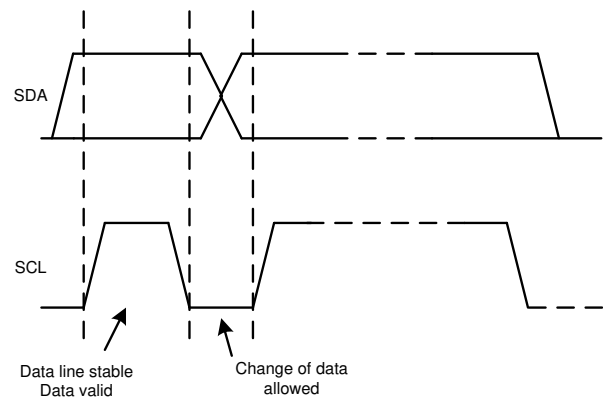

Figure 7-22. Bit Transfer on the I²C Bus

7.5.2.2 I²C Update Sequence

表 7-14 shows that for a single update, the DAC63202W require a start condition, a valid I²C address byte, a command byte, and two data bytes.

表 7-14. Update Sequence

MSB	LSB	ACK	MSB	...	LSB	ACK	MSB	...	LSB	ACK	MSB	...	LSB	ACK
Address (A) byte セクション 7.5.2.2.1				Command byte セクション 7.5.2.2.2				Data byte - MSDB				Data byte - LSDB			
DB [31:24]				DB [23:16]				DB [15:8]				DB [7:0]			

図 7-23 shows that after each byte is received, the DAC63202W family acknowledges the byte by pulling the SDA line low during the high period of a single clock pulse. These four bytes and acknowledge cycles make up the 36 clock cycles required for a single update to occur. A valid I²C address byte selects the DAC63202W.



図 7-23. I²C Bus Protocol

The command byte sets the operating mode of the selected DAC63202W device. For a data update to occur when the operating mode is selected by this byte, the DAC63202W device must receive two data bytes: the most significant data byte (MSDB) and least significant data byte (LSDB). The DAC63202W device performs an update on the falling edge of the acknowledge signal that follows the LSDB.

When using fast mode (clock = 400 kHz), the maximum DAC update rate is limited to 10 kSPS. Using fast mode plus (clock = 1 MHz), the maximum DAC update rate is limited to 25 kSPS. When a stop condition is received, the DAC63202W device releases the I²C bus and awaits a new start condition.

7.5.2.2.1 Address Byte

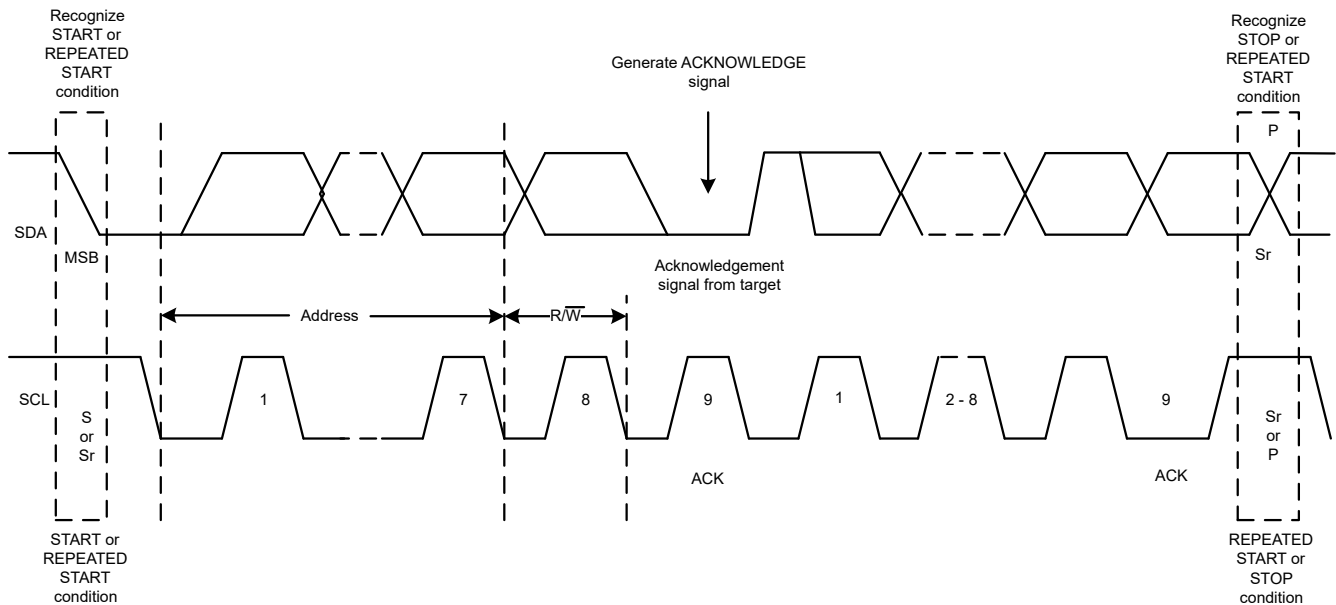
表 7-15 depicts the address byte, the first byte received from the controller device following the start condition. The first four bits (MSBs) of the address are factory preset to 1001. The next three bits of the address are controlled by the A0 pin. The A0 pin input can be connected to VDD, AGND, SCL, or SDA. The A0 pin is sampled during the first byte of each data frame to determine the address. The device latches the value of the address pin, and consequently responds to that particular address according to 表 7-16.

表 7-15. Address Byte

COMMENT	MSB							LSB
	AD6	AD5	AD4	AD3	AD2	AD1	AD0	
—								R/W
General address	1	0	0	1	See 表 7-16 (target address column)			0 or 1
Broadcast address	1	0	0	0	1	1	1	0

表 7-16. Address Format

TARGET ADDRESS	A0 PIN
000	AGND
001	VDD
010	SDA
011	SCL

The DAC63202W supports broadcast addressing, which is used for synchronously updating or powering down multiple DAC63202W devices. When the broadcast address is used, the DAC63202W responds regardless of the address pin state. Broadcast is supported only in write mode.

7.5.2.2.2 Command Byte

The *Register Names* table in the *Register Map* section lists the command byte in the ADDRESS column.

7.5.2.3 I²C Read Sequence

To read any register the following command sequence must be used:

1. Send a start or repeated start command with a target address and the R/\overline{W} bit set to 0 for writing. The device acknowledges this event.
2. Send a command byte for the register to be read. The device acknowledges this event again.
3. Send a repeated start with the target address and the R/\overline{W} bit set to 1 for reading. The device acknowledges this event.
4. The device writes the MSDB byte of the addressed register. The controller must acknowledge this byte.
5. Finally, the device writes out the LSDB of the register.

The broadcast address cannot be used for reading.

表 7-17. Read Sequence

S	MSB	...	R/W (0)	ACK	MSB	...	LSB	ACK	Sr	MSB	...	R/W (1)	ACK	MSB	...	LSB	ACK	MSB	...	LSB	ACK
	Address byte セクション 7.5.2.2.1				Command byte セクション 7.5.2.2.2				Sr	Address byte セクション 7.5.2.2.1				MSDB				LSDB			
	From controller			Target	From controller			Target		From controller			Target	From target			Controller	From target			Controller

7.5.3 General-Purpose Input/Output (GPIO) Modes

Together with I²C and SPI, the DAC63202W also support a GPIO that can be configured in the NVM for multiple functions. This pin allows for updating the DAC output channels and reading status bits without using the programming interface, thus enabling *processor-less* operation. In the GPIO-CONFIG register, write 1 to the GPI-EN bit to set the GPIO pin as an input, or write 1 to the GPO-EN bit to set the pin as output. There are global and channel-specific functions mapped to the GPIO pin. For channel-specific functions, select the channels using the GPI-CH-SEL field in the GPIO-CONFIG register. 表 7-18 lists the functional options available for the GPIO as input and 表 7-19 lists the options for the GPIO as output. Some of the GP input operations are edge-triggered after the device boots up. After the power supply ramps up, the device registers the GPI level and executes the associated command. This feature allows the user to configure the initial output state at power-on. By default, the GPIO pin is not mapped to any operation. When the GPIO pin is mapped to a specific input function, the corresponding software bit functionality is disabled to avoid a race condition. When used as a $\overline{\text{RESET}}$ input, the GPIO pin must transmit an active-low pulse for triggering a device reset. All other constraints of the functions are applied to the GPIO-based trigger.

注

Pull the GPIO pin high or low when not used. When the GPIO pin is used as $\overline{\text{RESET}}$, the configuration must be programmed into the NVM. Otherwise, the setting is cleared after the device resets.

表 7-18. General-Purpose Input Function Map

REGISTER	BIT FIELD	VALUE	CHANNELS	GPIO EDGE / LEVEL	FUNCTION
GPIO-CONFIG	GPIO-CONFIG	0010	All	Falling edge	Trigger FAULT-DUMP
				Rising edge	No effect
		0011	As per GPI-CH-SEL	Falling edge	IOUT power-down
				Rising edge	IOUT power-up
		0100	As per GPI-CH-SEL	Falling edge	VOUT power-down. Pulldown resistor as per the VOUT-PDN-X setting
				Rising edge	VOUT power-up
		0101	All	Falling edge	Trigger PROTECT function
				Rising edge	No effect
		0111	All	Falling edge	Trigger CLR function
				Rising edge	No effect
		1000	As per GPI-CH-SEL, both the SYNC-CONFIG-X and the GPI-CH-SEL must be configured for every channel.	Falling edge	Trigger LDAC function
				Rising edge	No effect
		1001	As per GPI-CH-SEL	Falling edge	Stop function generation
				Rising edge	Start function generation
		1010	As per GPI-CH-SEL	Falling edge	Trigger margin-low
				Rising edge	Trigger margin-high
		1011	All	Low pulse	Trigger device RESET. The RESET configuration must be programmed into the NVM.
				Rising edge	No effect
		1100	All	Falling edge	Allows NVM programming
				Rising edge	Blocks NVM programming
1101	All	Falling edge	Allows register map update		
		Rising edge	Blocks register map write except a write to the DEV-UNLOCK field through I ² C or SPI and the RESET fields through I ² C		
Others	N/A	N/A	Not applicable		

表 7-19. General-Purpose Output (STATUS) Function Map

REGISTER	BIT FIELD	VALUE	FUNCTION
GPIO-CONFIG	GPO-CONFIG	0001	NVM-BUSY
		0100	DAC-1-BUSY
		0111	DAC-0-BUSY
		1000	WIN-CMP-1
		1011	WIN-CMP-0
		Others	Not applicable

7.6 Register Map

表 7-20. Register Map

REGISTER ^{(1) (2)}	MOST SIGNIFICANT DATA BYTE (MSDB)								LEAST SIGNIFICANT DATA BYTE (LSDB)										
	BIT15	BIT14	BIT13	BIT12	BIT11	BIT10	BIT9	BIT8	BIT7	BIT6	BIT5	BIT4	BIT3	BIT2	BIT1	BIT0			
NOP	NOP																		
DAC-X-MARGIN-HIGH	DAC-X-MARGIN-HIGH												X						
DAC-X-MARGIN-LOW	DAC-X-MARGIN-LOW												X						
DAC-X-VOUT-CMP-CONFIG	X		VOUT-X-GAIN				X				CMP-X-OD-EN	CMP-X-OUT-EN	CMP-X-HIZ-IN-DIS	CMP-X-INV-EN	CMP-X-EN				
DAC-X-IOUT-MISC-CONFIG	X		IOUT-X-RANGE				X												
DAC-X-CMP-MODE-CONFIG	X				CMP-X-MODE		X												
DAC-X-FUNC-CONFIG	CLR-SEL-X	SYNC-CONFIG-X	BRD-CONFIG-X	FUNC-GEN-CONFIG-BLOCK-X															
DAC-X-DATA	DAC-X-DATA												X						
COMMON-CONFIG	WIN-LATCH-EN	DEV-LOCK	EE-READ-ADDR	EN-INT-REF	VOUT-PDN-0		IOUT-PDN-0	X						VOUT-PDN-1		IOUT-PDN-1			
COMMON-TRIGGER	DEV-UNLOCK				RESET				LDAC	CLR	X	FAULT-DUMP	PROTECT	READ-ONE-TRIG	NVM-PROG	NVM-RELOAD			
COMMON-DAC-TRIG	RST-CMP-FLAG-1	TRIG-MAR-LO-1	TRIG-MAR-HI-1	START-FUNC-1	X											RST-CMP-FLAG-0	TRIG-MAR-LO-0	TRIG-MAR-HI-0	START-FUNC-0
GENERAL-STATUS	NVM-CRC-FAIL-INT	NVM-CRC-FAIL-USER	X	DAC-BUSY-0	X		DAC-BUSY-1	NVM-BUSY	DEVICE-ID										
CMP-STATUS	X							PROTECT-FLAG	WIN-CMP-0	X		WIN-CMP-1	CMP-FLAG-0	X		CMP-FLAG-1			
GPIO-CONFIG	GF-EN	X	GPO-EN	GPO-CONFIG				GPI-CH-SEL				GPI-CONFIG				GPI-EN			
DEVICE-MODE-CONFIG	RESERVED		DIS-MODE-IN	RESERVED				PROTECT-CONFIG		RESERVED				X					
INTERFACE-CONFIG	X			TIMEOUT-EN	X			EN-PMBUS	X						FAST-SDO-EN	X	SDO-EN		
SRAM-CONFIG	X								SRAM-ADDR										
SRAM-DATA	SRAM-DATA																		
BRDCAST-DATA	BRDCAST-DATA												X						
PMBUS-PAGE	PMBUS-PAGE								Not applicable										
PMBUS-OP-CMD	PMBUS-OPERATION-CMD-X								Not applicable										
PMBUS-CML	X						CML	X	Not applicable										
PMBUS-VERSION	PMBUS-VERSON								Not applicable										

- (1) The highlighted gray cells indicate the register bits or fields that are stored in the NVM.
(2) X = Don't care.

表 7-21. Register Names

I ² C/SPI ADDRESS	PMBUS PAGE ADDR	PMBUS REGISTER ADDR	REGISTER NAME	SECTION
00h	FFh	D0h	NOP	セクション 7.6.1
01h	00h	25h	DAC-1-MARGIN-HIGH	セクション 7.6.2
02h	00h	26h	DAC-1-MARGIN-LOW	セクション 7.6.3
03h	FFh	D1h	DAC-1-VOOUT-CMP-CONFIG	セクション 7.6.4
04h	FFh	D2h	DAC-1-IOOUT-MISC-CONFIG	セクション 7.6.5
05h	FFh	D3h	DAC-1-CMP-MODE-CONFIG	セクション 7.6.6
06h	FFh	D4h	DAC-1-FUNC-CONFIG	セクション 7.6.7
13h	03h	25h	DAC-0-MARGIN-HIGH	セクション 7.6.2
14h	03h	26h	DAC-0-MARGIN-LOW	セクション 7.6.3
15h	FFh	DDh	DAC-0-VOOUT-CMP-CONFIG	セクション 7.6.4
16h	FFh	DEh	DAC-0-IOOUT-MISC-CONFIG	セクション 7.6.5
17h	FFh	DFh	DAC-0-CMP-MODE-CONFIG	セクション 7.6.6
18h	FFh	E0h	DAC-0-FUNC-CONFIG	セクション 7.6.7
19h	00h	21h	DAC-1-DATA	セクション 7.6.8
1Ch	03h	21h	DAC-0-DATA	セクション 7.6.8
1Fh	FFh	E3h	COMMON-CONFIG	セクション 7.6.9
20h	FFh	E4h	COMMON-TRIGGER	セクション 7.6.10
21h	FFh	E5h	COMMON-DAC-TRIG	セクション 7.6.11
22h	FFh	E6h	GENERAL-STATUS	セクション 7.6.12
23h	FFh	E7h	CMP-STATUS	セクション 7.6.13
24h	FFh	E8h	GPIO-CONFIG	セクション 7.6.14
25h	FFh	E9h	DEVICE-MODE-CONFIG	セクション 7.6.15
26h	FFh	EAh	INTERFACE-CONFIG	セクション 7.6.16
2Bh	FFh	EFh	SRAM-CONFIG	セクション 7.6.17
2Ch	FFh	F0h	SRAM-DATA	セクション 7.6.18
50h	FFh	F1h	BRDCAST-DATA	セクション 7.6.19
NA	All pages	00h	PMBUS-PAGE	セクション 7.6.20
NA	00h	01h	PMBIS-OP-CMD-0	セクション 7.6.21
NA	01h	01h	PMBUS-OP-CMD-1	セクション 7.6.21
NA	02h	01h	PMBUS-OP-CMD-2	セクション 7.6.21
NA	03h	01h	PMBUS-OP-CMD-3	セクション 7.6.21
NA	All pages	78h	PMBUS-CML	セクション 7.6.22
NA	All pages	98h	PMBUS-VERSION	セクション 7.6.23

表 7-22. Access Type Codes

Access Type	Code	Description
X	X	Don't care
Read Type		
R	R	Read
Write Type		
W	W	Write
Reset or Default Value		
-n		Value after reset or the default value

7.6.1 NOP Register (address = 00h) [reset = 0000h]

PMBus page address = FFh, PMBus register address = D0h

図 7-24. NOP Register

15	14	13	12	11	10	9	8	7	6	5	4	3	2	1	0
NOP															
R-0h															

表 7-23. NOP Register Field Descriptions

Bit	Field	Type	Reset	Description
15-0	NOP	R	0000h	No operation

7.6.2 DAC-X-MARGIN-HIGH Register (address = 13h, 01h) [reset = 0000h]

PMBus page address = 03h, 00h, PMBus register address = 25h

図 7-25. DAC-X-MARGIN-HIGH Register (X = 0, 1)

15	14	13	12	11	10	9	8	7	6	5	4	3	2	1	0
VOUT: DAC-X-MARGIN-HIGH[11:0] IOUT: DAC-X-MARGIN-HIGH[7:0]												X			
R/W-0h												X-0h			

表 7-24. DAC-X-MARGIN-HIGH Register Field Descriptions

Bit	Field	Type	Reset	Description
15-4	VOUT: DAC-X-MARGIN-HIGH[11:0] IOUT: DAC-X-MARGIN-HIGH[7:0]	R/W	000h	Margin-high code for DAC output Data are in straight-binary format. MSB left aligned. Use the following bit alignment: VOUT: {DAC-X-MARGIN-HIGH[11:0] IOUT: {DAC-X-MARGIN-HIGH[7:0], X, X, X, X} X = Don't care bits.
3-0	X	X	0	Don't care

7.6.3 DAC-X-MARGIN-LOW Register (address = 14h, 02h) [reset = 0000h]

PMBus page address = 03h, 00h, PMBus register address = 26h

図 7-26. DAC-X-MARGIN-LOW Register (X = 0, 1)

15	14	13	12	11	10	9	8	7	6	5	4	3	2	1	0
VOUT: DAC-X-MARGIN-LOW[11:0] IOUT: DAC-X-MARGIN-LOW[7:0]												X			
R/W-0h												X-0h			

表 7-25. DAC-X-MARGIN-LOW Register Field Descriptions

Bit	Field	Type	Reset	Description
15-4	VOUT: DAC-X-MARGIN-LOW[11:0] IOUT: DAC-X-MARGIN-LOW[7:0]	R/W	000h	Margin-low code for DAC output Data are in straight-binary format. MSB left aligned. Use the following bit alignment: VOUT: {DAC-X-MARGIN-LOW[11:0] IOUT: {DAC-X-MARGIN-LOW[7:0], X, X, X, X} X = Don't care bits.
3-0	X	X	0	Don't care

7.6.4 DAC-X-VOUT-CMP-CONFIG Register (address = 15h, 03h) [reset = 0000h]

PMBus page address = FFh, PMBus register address = DDh, D1h

图 7-27. DAC-X-VOUT-CMP-CONFIG Register (X = 0, 1)

15	14	13	12	11	10	9	8	7	6	5	4	3	2	1	0
X		VOUT-GAIN-X					X			CMP-X-OD-EN	CMP-X-OUT-EN	CMP-X-HIZ-IN-DIS	CMP-X-INV-EN	CMP-X-EN	
X-0h		R/W-0h					X-0h			R/W-0h	R/W-0h	R/W-0h	R/W-0h	R/W-0h	

表 7-26. DAC-X-VOUT-CMP-CONFIG Register Field Descriptions

Bit	Field	Type	Reset	Description
15-13	X	X	0h	Don't care
12-10	VOUT-GAIN-X	R/W	0h	000: Gain = 1 ×, external reference on VREF pin 001: Gain = 1 ×, VDD as reference 010: Gain = 1.5 ×, internal reference 011: Gain = 2 ×, internal reference 100: Gain = 3 ×, internal reference 101: Gain = 4 ×, internal reference Others: Invalid
9-5	X	X	0h	Don't care
4	CMP-X-OD-EN	R/W	0	0: Set OUTx pin as push-pull 1: Set OUTx pin as open-drain in comparator mode (CMP-X-EN = 1 and CMP-X-OUT-EN = 1)
3	CMP-X-OUT-EN	R/W	0	0: Generate comparator output but consume internally 1: Bring comparator output to the respective OUTx pin
2	CMP-X-HIZ-IN-DIS	R/W	0	0: FBx input has high-impedance. Input voltage range is limited. 1: FBx input is connected to resistor divider and has finite impedance. Input voltage range is same as full-scale.
1	CMP-X-INV-EN	R/W	0	0: Don't invert the comparator output 1: Invert the comparator output
0	CMP-X-EN	R/W	0	0: Disable comparator mode 1: Enable comparator mode. Current-output must be in power-down. Voltage-output mode must be enabled.

7.6.5 DAC-X-IOUT-MISC-CONFIG Register (address = 16h, 04h) [reset = 0000h]

PMBus page address = FFh, PMBus register address = DEh, D2h

☒ 7-28. DAC-X-IOUT-MISC-CONFIG Register (X = 0, 1)

15	14	13	12	11	10	9	8	7	6	5	4	3	2	1	0
X			IOUT-RANGE-X						X						
X-0h			R/W-0h						X-0h						

表 7-27. DAC-X-IOUT-MISC-CONFIG Register Field Descriptions

Bit	Field	Type	Reset	Description
15-13	X	X	0h	Don't care
12-9	IOUT-RANGE-X	R/W	0000	1000: -25 μ A to +25 μ A 1001: -50 μ A to +50 μ A 1010: -125 μ A to +125 μ A 1011: -250 μ A to +250 μ A Others: Invalid
8-0	X	X	000h	Don't care

7.6.6 DAC-X-CMP-MODE-CONFIG Register (address = 17h, 05h) [reset = 0000h]

PMBus page address = FFh, PMBus register address = DFh, D3h

☒ 7-29. DAC-X-CMP-MODE-CONFIG Register (X = 0, 1)

15	14	13	12	11	10	9	8	7	6	5	4	3	2	1	0
X			CMP-X-MODE			X									
X-0h			R/W-0h			X-0h									

表 7-28. DAC-X-CMP-MODE-CONFIG Register Field Descriptions

Bit	Field	Type	Reset	Description
15-12	X	X	00h	Don't care
11-10	CMP-X-MODE	R/W	00	00: No hysteresis or window function 01: Hysteresis provided using DAC-X-MARGIN-HIGH and DAC-X-MARGIN-LOW registers 10: Window comparator mode with DAC-X-MARGIN-HIGH and DAC-X-MARGIN-LOW registers setting window bounds 11: Invalid
9-0	X	X	000h	Don't care

7.6.7 DAC-X-FUNC-CONFIG Register (address = 18h, 06h) [reset = 0000h]

PMBus page address = FFh, PMBus register address = E0h, D4h

图 7-30. DAC-X-FUNC-CONFIG Register (X = 0, 1)

15	14	13	12	11	10	9	8	7	6	5	4	3	2	1	0
CLR-SEL-X	SYNC-CONFIG-X	BRD-CONFIG-X	FUNC-GEN-CONFIG-BLOCK												
R/W-0h	R/W-0h	R/W-0h	R/W-0h												

表 7-29. DAC-X-FUNC-CONFIG Register Field Descriptions

Bit	Field	Type	Reset	Description
15	CLR-SEL-X	R/W	0	0: Clear DAC-X to zero-scale 1: Clear DAC-X to mid-scale
14	SYNC-CONFIG-X	R/W	0	0: DAC-X output updates immediately after a write command 1: DAC-X output updates with LDAC pin falling-edge or when the LDAC bit in the COMMON-TRIGGER register is set to 1
13	BRD-CONFIG-X	R/W	0	0: Don't update DAC-X with broadcast command 1: Update DAC-X with broadcast command

表 7-30. Linear-Slew Mode: FUNC-GEN-CONFIG-BLOCK Field Descriptions

Bit	Field	Type	Reset	Description
12-11	PHASE-SEL-X	R/W	0	00: 0° 01: 120° 10: 240° 11: 90°
10-8	FUNC-CONFIG-X	R/W	0	000: Triangular wave 001: Sawtooth wave 010: Inverse sawtooth wave 100: Sine wave 111: Disable function generation Others: Invalid
7	LOG-SLEW-EN-X	R/W	0	0: Enable linear slew
6-4	CODE-STEP-X	R/W	0	CODE-STEP for linear slew mode: 000: 1-LSB 001: 2-LSB 010: 3-LSB 011: 4-LSB 100: 6-LSB 101: 8-LSB 110: 16-LSB 111: 32-LSB
3-0	SLEW-RATE-X	R/W	0	SLEW-RATE for linear slew mode: 0000: No slew for margin-high and margin-low. Invalid for waveform generation. 0001: 4 µs/step 0010: 8 µs/step 0011: 12 µs/step 0100: 18 µs/step 0101: 27.04 µs/step 0110: 40.48 µs/step 0111: 60.72 µs/step 1000: 91.12 µs/step 1001: 136.72 µs/step 1010: 239.2 µs/step 1011: 418.64 µs/step 1100: 732.56 µs/step 1101: 1282 µs/step 1110: 2563.96 µs/step 1111: 5127.92 µs/step

表 7-31. Logarithmic-Slew Mode: FUNC-GEN-CONFIG-BLOCK Field Descriptions

Bit	Field	Type	Reset	Description
12-11	PHASE-SEL-X	R/W	0	00: 0° 01: 120° 10: 240° 11: 90°
10-8	FUNC-CONFIG-X	R/W	0	000: Triangular wave 001: Sawtooth wave 010: Inverse sawtooth wave 100: Sine wave 111: Disable function generation Others: Invalid
7	LOG-SLEW-EN-X	R/W	0	1: Enable logarithmic slew. In logarithmic slew mode, the DAC output moves from the DAC-X-MARGIN-LOW code to the DAC-X-MARGIN-HIGH code, or vice versa, in 3.125% steps. When slewing in the positive direction, the next step is (1 + 0.03125) times the current step. When slewing in the negative direction, the next step is (1 – 0.03125) times the current step. When DAC-X-MARGIN-LOW is 0, the slew starts from code 1. The time interval for each step is defined by RISE-SLEW-X and FALL-SLEW-X.
6-4	RISE-SLEW-X	R/W	0	SLEW-RATE for logarithmic slew mode (DAC-X-MARGIN-LOW to DAC-X-MARGIN-HIGH): 000: 4 μs/step 001: 12 μs/step 010: 27.04 μs/step 011: 60.72 μs/step 100: 136.72 μs/step 101: 418.64 μs/step 110: 1282 μs/step 111: 5127.92 μs/step
3-1	FALL-SLEW-X	R/W	0	SLEW-RATE for logarithmic slew mode (DAC-X-MARGIN-HIGH to DAC-X-MARGIN-LOW): 000: 4 μs/step 001: 12 μs/step 010: 27.04 μs/step 011: 60.72 μs/step 100: 136.72 μs/step 101: 418.64 μs/step 110: 1282 μs/step 111: 5127.92 μs/step
0	X	X	0	Don't care

7.6.8 DAC-X-DATA Register (address = 1Ch, 19h) [reset = 0000h]

PMBus page address = 03h, 00h, PMBus register address = 21h

图 7-31. DAC-X-DATA Register (X = 0, 1)

15	14	13	12	11	10	9	8	7	6	5	4	3	2	1	0
VOUT: DAC-X-DATA[11:0] IOUT: DAC-X-DATA[7:0]												X			
R/W-0h												X-0h			

表 7-32. DAC-X-DATA Register Field Descriptions

Bit	Field	Type	Reset	Description
15-4	VOUT: DAC-X-DATA[11:0] IOUT: DAC-X-DATA[7:0]	R/W	000h	Data for DAC output Data are in straight-binary format. MSB left-aligned. MSB left-aligned. Use the following bit-alignment: VOUT: {DAC-X-DATA[11:0]} IOUT: {DAC-X-DATA[7:0], X, X, X, X} X = Don't care bits.
3-0	X	X	0h	Don't care

7.6.9 COMMON-CONFIG Register (address = 1Fh) [reset = 0FFFh]

PMBus page address = FFh, PMBus register address = E3h

图 7-32. COMMON-CONFIG Register

15	14	13	12	11	10	9	8	7	6	5	4	3	2	1	0
WIN-LATCH-EN	DEV-LOCK	EE-READ-ADDR	EN-INT-REF	VOUT-PDN-0	IOUT-PDN-0	Don't care						VOUT-PDN-1	IOUT-PDN-1		
R/W-0h	R/W-0h	R/W-0h	R/W-0h	R/W-11b	R/W-1b	X-11h						R/W-11b	R/W-1b		

表 7-33. COMMON-CONFIG Register Field Descriptions

Bit	Field	Type	Reset	Description
15	WIN-LATCH-EN	R/W	0	0: Non-latching window-comparator output 1: Latching window-comparator output
14	DEV-LOCK	R/W	0	0: Device not locked 1: Device locked, the device locks all the registers. To set this bit back to 0 (unlock device), write to the unlock code to the DEV-UNLOCK field in the COMMON-TRIGGER register first, followed by a write to the DEV-LOCK bit as 0.
13	EE-READ-ADDR	R/W	0	0: Fault-dump read enable at address 0x00 1: Fault-dump read enable at address 0x01
12	EN-INT-REF	R/W	0	0: Disable internal reference 1: Enable internal reference. This bit must be set before using internal reference gain settings.
11-10, 2-1	VOUT-PDN-X	R/W	11	00: Power-up VOUT-X 01: Power-down VOUT-X with 10 kΩ to AGND 10: Power-down VOUT-X with 100 kΩ to AGND 11: Power-down VOUT-X with Hi-Z to AGND
9, 0	IOUT-PDN-X	R/W	1	0: Power-up IOUT-X 1: Power-down IOUT-X
8-3	X	X	11h	Don't care

7.6.10 COMMON-TRIGGER Register (address = 20h) [reset = 0000h]

PMBus page address = FFh, PMBus register address = E4h

图 7-33. COMMON-TRIGGER Register

15	14	13	12	11	10	9	8	7	6	5	4	3	2	1	0	
DEV-UNLOCK				RESET				LDAC	CLR	X	FAULT-DUMP	PROTECT	READ-ONE-TRIG	NVM-PROG	NVM-RELOAD	
R/W-0h				R/W-0h				R/W-0h	R/W-0h	X-0h	R/W-0h	R/W-0h	R/W-0h	R/W-0h	R/W-0h	R/W-0h

表 7-34. COMMON-TRIGGER Register Field Descriptions

Bit	Field	Type	Reset	Description
15-12	DEV-UNLOCK	R/W	0000	0101: Device unlocking password Others: Don't care
11-8	RESET	W	0000	1010: POR reset triggered. This bit self-resets. Others: Don't care
7	LDAC	R/W	0	0: LDAC operation not triggered 1: LDAC operation triggered if the respective SYNC-CONFIG-X bit in the DAC-X-FUNC-CONFIG register is 1. This bit self-resets.
6	CLR	R/W	0	0: DAC registers and outputs unaffected 1: DAC registers and outputs set to zero-code or mid-code based on the respective CLR-SEL-X bit in the DAC-X-FUNC-CONFIG register. This bit self-resets.
5	X	X	0	Don't care
4	FAULT-DUMP	R/W	0	0: Fault-dump is not triggered 1: Triggers fault-dump sequence. This bit self-resets.
3	PROTECT	R/W	0	0: PROTECT function not triggered 1: Trigger PROTECT function. This bit self-resets.
2	READ-ONE-TRIG	R/W	0	0: Fault-dump read not triggered 1: Read one row of NVM for fault-dump. This bit self-resets.
1	NVM-PROG	R/W	0	0: NVM write not triggered 1: NVM write triggered. This bit self-resets.
0	NVM-RELOAD	R/W	0	0: NVM reload not triggered 1: Reload data from NVM to register map. This bit self-resets.

7.6.11 COMMON-DAC-TRIG Register (address = 21h) [reset = 0000h]

PMBus page address = FFh, PMBus register address = E5h

图 7-34. COMMON-DAC-TRIG Register

15	14	13	12	11	10	9	8	7	6	5	4	3	2	1	0
RESET-CMP-FLAG-1	TRIG-MAR-LO-1	TRIG-MAR-HI-1	START-FUNC-1	Don't care								RESET-CMP-FLAG-0	TRIG-MAR-LO-0	TRIG-MAR-HI-0	START-FUNC-0
W-0h	W-0h	W-0h	R/W-0h	X-0h								W-0h	W-0h	W-0h	R/W-0h

表 7-35. COMMON-DAC-TRIG Register Field Descriptions

Bit	Field	Type	Reset	Description
15, 3	RESET-CMP-FLAG-X	\overline{W}	0	0: Latching-comparator output unaffected 1: Reset latching-comparator and window-comparator output. This bit self-resets.
14, 2	TRIG-MAR-LO-X	W	0	0: Don't care 1: Trigger margin-low command. This bit self-resets.
13, 1	TRIG-MAR-HI-X	\overline{W}	0	0: Don't care 1: Trigger margin-high command. This bit self-resets.
12, 0	START-FUNC-X	R/ \overline{W}	0	0: Stop function generation 1: Start function generation as per FUNC-GEN-CONFIG-X in the DAC-X-FUNC-CONFIG register.
11-4	X	X	0h	Don't care

7.6.12 GENERAL-STATUS Register (address = 22h) [reset = 00h, DEVICE-ID, VERSION-ID]

PMBus page address = FFh, PMBus register address = E6h

图 7-35. GENERAL-STATUS Register

15	14	13	12	11	10	9	8	7	6	5	4	3	2	1	0
NVM-CRC-FAIL-INT	NVM-CRC-FAIL-USER	X	DAC-0-BUSY	X		DAC-1-BUSY	X	DEVICE-ID						VERSION-ID	
R-0h	R-0h	R-0h	R-0h	X-0h		R-0h	X-0h	R						R-0h	

表 7-36. GENERAL-STATUS Register Field Descriptions

Bit	Field	Type	Reset	Description
15	NVM-CRC-FAIL-INT	R	0	0: No CRC error in OTP 1: Indicates a failure in OTP loading. A software reset or power-cycle can bring the device out of this condition in case of temporary failure.
14	NVM-CRC-FAIL-USER	R	0	0: No CRC error in NVM loading 1: Indicates a failure in NVM loading. The register settings are corrupted. The device allows all operations during this error condition. Reprogram the NVM to get original state. A software reset brings the device out of this temporary error condition.
13	X	R	0	Don't care
12	DAC-0-BUSY	R	0	0: DAC-0 channel can accept commands 1: DAC-0 channel does not accept commands
11-10	X	X	0	Don't care
9	DAC-1-BUSY	R	0	0: DAC-1 channel can accept commands 1: DAC-1 channel does not accept commands
8	X	R	0	Don't care
7-2	DEVICE-ID	R	06h	Device identifier.
1-0	VERSION-ID	R	00	Version identifier.

7.6.13 CMP-STATUS Register (address = 23h) [reset = 0000h]

PMBus page address = FFh, PMBus register address = E7h

图 7-36. CMP-STATUS Register

15	14	13	12	11	10	9	8	7	6	5	4	3	2	1	0
			X				PROTECT-FLAG	WIN-CMP-0	X		WIN-CMP-1	CMP-FLAG-0	X		CMP-FLAG-1
			X-0h				R-0h	R-0h	X-0h		R-0h	R-0h	X-0h		R-0h

表 7-37. CMP-STATUS Register Field Descriptions

Bit	Field	Type	Reset	Description
15-9, 6-5, 2-1	X	X	0	Don't care
8	PROTECT-FLAG	R	0	0: PROTECT operation not triggered. 1: PROTECT function is completed or in progress. This bit resets to 0 when read.
7, 4	WIN-CMP-X	R	0	Window comparator output from respective channels. The output is latched or unlatched based on the WINDOW-LATCH-EN setting in the COMMON-CONFIG register.
3, 0	CMP-FLAG-X	R	0	Synchronized comparator output from respective channels.

7.6.14 GPIO-CONFIG Register (address = 24h) [reset = 0000h]

PMBus page address = FFh, PMBus register address = E8h

图 7-37. GPIO-CONFIG Register

15	14	13	12	11	10	9	8	7	6	5	4	3	2	1	0
GF-EN	X	GPO-EN	GPO-CONFIG			GPI-CH-SEL			GPI-CONFIG			GPI-EN			
R/W-0h	X-0h	R/W-0h	R/W-0h			R/W-0h			R/W-0h			R/W-0h			

表 7-38. GPIO-CONFIG Register Field Descriptions

Bit	Field	Type	Reset	Description
15	GF-EN	R/W	0	0: Glitch filter disabled for GP input. This setting provides faster response. 1: Glitch filter enabled for GPI. This setting introduces additional propagation delay but provides robustness.
14	X	X	0	Don't care.
13	GPO-EN	R/W	0	0: Disable output mode for GPIO pin. 1: Enable output mode for GPIO pin.
12-9	GPO-CONFIG	R/W	0000	STATUS function setting. The GPIO pin is mapped to the following register bits as output: 0001: NVM-BUSY 0100: DAC-1-BUSY 0111: DAC-0-BUSY 1000: WIN-CMP-1 1011: WIN-CMP-0 Others: NA
8-5	GPI-CH-SEL	R/W	0000	Two bits correspond to two DAC channels. 0b is <i>disabled</i> and 1b is <i>enabled</i> . GPI-CH-SEL[0]: Channel 1 GPI-CH-SEL[3]: Channel 0 Example: when GPI-CH-SEL is 1001, both channel 0 and channel 1 are enabled.

表 7-38. GPIO-CONFIG Register Field Descriptions (continued)

Bit	Field	Type	Reset	Description
4-1	GPI-CONFIG	R/W	0000	<p>GPIO pin input configuration. Global settings act on the entire device. Channel-specific settings depend on the channel selection by the GPI-CH-SEL bits:</p> <p>0010: $\overline{\text{FAULT-DUMP}}$ (global). GPIO falling edge triggers fault dump, GPIO = 1 has no effect.</p> <p>0011: IOUT power up-down (channel-specific). GPIO falling edge triggers power down, GPIO rising edge triggers power up.</p> <p>0100: VOUT power up-down (channel-specific). The output load is as per the VOUT-PDN-X setting. GPIO falling edge triggers power down, GPIO rising edge triggers power up.</p> <p>0101: $\overline{\text{PROTECT}}$ input (global). GPIO falling edge asserts $\overline{\text{PROTECT}}$ function, GPIO = 1 has no effect.</p> <p>0111: $\overline{\text{CLR}}$ input (global). GPIO = 0 asserts $\overline{\text{CLR}}$ function, GPIO = 1 has no effect.</p> <p>1000: $\overline{\text{LDAC}}$ input (channel-specific). GPIO falling edge asserts $\overline{\text{LDAC}}$ function, GPIO = 1 has no effect. Both the SYNC-CONFIG-X and the GPI-CH-SEL must be configured for every channel.</p> <p>1001: Start and stop function generation (channel-specific). GPIO falling edge stops function generation. GPIO rising edge starts function generation.</p> <p>1010: Trigger margin high-low (channel-specific). GPIO falling edge triggers margin low. GPIO rising edge triggers margin high.</p> <p>1011: $\overline{\text{RESET}}$ input (global). The falling edge of the GPIO pin asserts the $\overline{\text{RESET}}$ function. The $\overline{\text{RESET}}$ input must be a pulse. The GPIO rising edge brings the device out of reset. The $\overline{\text{RESET}}$ configuration must be programmed into the NVM. Otherwise, the setting is cleared after the device reset.</p> <p>1100: NVM write protection (global). GPIO falling edge allows NVM programming. GPIO rising edge blocks NVM programming.</p> <p>1101: Register-map lock (global). GPIO falling edge allows update to the register map. GPIO rising edge blocks any register map update except a write to the DEV-UNLOCK field through I²C or SPI and to the $\overline{\text{RESET}}$ field through I²C.</p> <p>Others: Invalid</p>
0	GPI-EN	R/W	0	<p>0: Disable input mode for GPIO pin. 1: Enable input mode for GPIO pin.</p>

7.6.15 DEVICE-MODE-CONFIG Register (address = 25h) [reset = 0000h]

PMBus page address = FFh, PMBus register address = E9h

图 7-38. DEVICE-MODE-CONFIG Register

15	14	13	12	11	10	9	8	7	6	5	4	3	2	1	0
RESERVED		DIS-MODE-IN	RESERVED			PROTECT-CONFIG	RESERVED			X					
R/W-0h		R/W-0h	R/W-0h			R/W-0h	R/W-0h			X-0h					

表 7-39. DEVICE-MODE-CONFIG Register Field Descriptions

Bit	Field	Type	Reset	Description
15-14	RESERVED	R/W	00	Always write 0b00
13	DIS-MODE-IN	R/W	0	Write 1 to this bit for low-power consumption.
12-10	RESERVED	R/W	0	Always write 0b000
9-8	PROTECT-CONFIG	R/W	00	00: Switch to Hi-Z power-down (no slew) 01: Switch to DAC code stored in NVM (no slew) and then switch to Hi-Z power-down 10: Slew to margin-low code and then switch to Hi-Z power-down 11: Slew to margin-high code and then switch to Hi-Z power-down
7-5	RESERVED	R/W	0	Always write 0b000
4-0	X	R/W	00h	Don't care

7.6.16 INTERFACE-CONFIG Register (address = 26h) [reset = 0000h]

图 7-39. INTERFACE-CONFIG Register

15	14	13	12	11	10	9	8	7	6	5	4	3	2	1	0
X		TIMEOUT-EN	X			EN-PMBUS	X			FSDO-EN	X	SDO-EN			
X-0h		R/W-0h	X-0h			R/W-0h	X-0h			R/W-0h	X-0h	R/W-0h			

表 7-40. INTERFACE-CONFIG Register Field Descriptions

Bit	Field	Type	Reset	Description
15-13	X	X	0h	Don't care
12	TIMEOUT-EN	R/W	0	0: I ² C timeout disabled 1: I ² C timeout enabled
11-9	X	X	0h	Don't care
8	EN-PMBUS	R/W	0	0: PMBus disabled 1: Enable PMBus
7-3	X	X	00h	Don't care
2	FSDO-EN	R/W	0	0: Fast SDO disabled 1: Fast SDO enabled
1	X	X	0	Don't care
0	SDO-EN	R/W	0	0: SDO disabled 1: SDO enabled on GPIO pin

7.6.17 SRAM-CONFIG Register (address = 2Bh) [reset = 0000h]

PMBus page address = FFh, PMBus register address = EFh

図 7-40. SRAM-CONFIG Register

15	14	13	12	11	10	9	8	7	6	5	4	3	2	1	0
X										SRAM-ADDR					
X-0h										R/W-0h					

表 7-41. SRAM-CONFIG Register Field Descriptions

Bit	Field	Type	Reset	Description
15-8	X	X	0h	Don't care
7-0	SRAM-ADDR	R/W	0h	8-bit SRAM address. Writing to this register field configures the SRAM address to be accessed next. This address automatically increments after a write to the SRAM.

7.6.18 SRAM-DATA Register (address = 2Ch) [reset = 0000h]

PMBus page address = FFh, PMBus register address = F0h

図 7-41. SRAM-DATA Register

15	14	13	12	11	10	9	8	7	6	5	4	3	2	1	0
SRAM-DATA															
R/W-0h															

表 7-42. SRAM-DATA Register Field Descriptions

Bit	Field	Type	Reset	Description
15-0	SRAM-ADDR	R/W	0h	16-bit SRAM data. This data is written to or read from the address configured in the SRAM-CONFIG register.

7.6.19 BRDCAST-DATA Register (address = 50h) [reset = 0000h]

PMBus page address = FFh, PMBus register address = F1h

図 7-42. BRDCAST-DATA Register

15	14	13	12	11	10	9	8	7	6	5	4	3	2	1	0
VOUT: BRDCAST-DATA[11:0] IOUT: BRDCAST-DATA[7:0]												X			
R/W-0h												X-0h			

表 7-43. BRDCAST-DATA Register Field Descriptions

Bit	Field	Type	Reset	Description
15-4	VOUT: BRDCAST-DATA[11:0] IOUT: BRDCAST-DATA[7:0]	R/W	000h	Broadcast code for all DAC channels Data are in straight-binary format. MSB left-aligned. Use the following bit-alignment: VOUT: {BROADCAST-DATA[11:0]} IOUT: {BROADCAST-DATA[7:0], X, X, X, X} X = Don't care bits. The BRD-CONFIG-X bit in the DAC-X-FUNC-CONFIG register must be enabled for the respective channels.
3-0	X	X	0h	Don't care.

7.6.20 PMBUS-PAGE Register [reset = 0300h]

PMBus page address = X, PMBus register address = 00h

图 7-43. PMBUS-PAGE Register

15	14	13	12	11	10	9	8	7	6	5	4	3	2	1	0
PMBUS-PAGE								X							
R/W-03h								X-00h							

表 7-44. PMBUS_OPERATION Register Field Descriptions

Bit	Field	Type	Reset	Description
15-8	PMBUS-PAGE	R/W	03h	8-bit PMBus page address as specified in 表 7-21.
7-0	X	X	00h	Not applicable

7.6.21 PMBUS-OP-CMD-X Register [reset = 0000h]

PMBus page address = 00h, 01h, 02h, 03h, PMBus register address = 01h

图 7-44. PMBUS-OP-CMD-X Register (X = 0, 1, 2, 3)

15	14	13	12	11	10	9	8	7	6	5	4	3	2	1	0
PMBUS-OPERATION-CMD-X								X							
R/W-00h								X-00h							

表 7-45. PMBUS-OP-CMD-X Register Field Descriptions

Bit	Field	Type	Reset	Description
15-8	PMBUS-OPERATION-CMD-X	R/W	00h	PMBus operation commands: 00h: Turn off 80h: Turn on A4h: Margin high, DAC output margins high to DAC-X-MARGIN-HIGH code 94h: Margin low, DAC output margins low to DAC-X-MARGIN-LOW code
7-0	X	X	00h	Not applicable

7.6.22 PMBUS-CML Register [reset = 0000h]

PMBus page address = X, PMBus register address = 78h

图 7-45. PMBUS-CML Register

15	14	13	12	11	10	9	8	7	6	5	4	3	2	1	0
X						CML	X	N/A							
X-00h						R/W-0h	X-0h	X-00h							

表 7-46. PMBUS-CML Register Field Descriptions

Bit	Field	Type	Reset	Description
15-10	X	X	00h	Don't care
9	CML	R/W	0h	0: No communication fault 1: PMBus communication fault for write with incorrect number of clocks, read before write command, invalid command address, and invalid or unsupported data value; reset this bit by writing 1.
8	X	X	0h	Don't care
7-0	X	X	00h	Not applicable

7.6.23 PMBUS-VERSION Register [reset = 2200h]

PMBus page address = X, PMBus register address =98h

 7-46. PMBUS-VERSION Register

15	14	13	12	11	10	9	8	7	6	5	4	3	2	1	0
PMBUS-VERSION								X							
R-22h								X-00h							

表 7-47. PMBUS-VERSION Register Field Descriptions

Bit	Field	Type	Reset	Description
15-8	PMBUS-VERSION	R	22h	PMBus version
7-0	X	X	00h	Not applicable

8 Application and Implementation

注

Information in the following applications sections is not part of the TI component specification, and TI does not warrant its accuracy or completeness. TI's customers are responsible for determining suitability of components for their purposes, as well as validating and testing their design implementation to confirm system functionality.

8.1 Application Information

The DAC63202W is a dual-channel buffered, force-sense output, voltage-output and current-output smart DAC that includes an NVM and internal reference, and available in a tiny 1.72-mm × 1.72-mm (nominal) package.

- In voltage-output mode, short the OUTx and FBx pins for each channel. In current-output mode, leave the FBx pins unconnected. The FBx pins function as inputs in comparator mode.
- The external reference must not exceed VDD, either during transient or steady-state conditions. For the best Hi-Z output performance, use a pullup resistor on the VREF pin to VDD. In case the VDD remains floating during the off condition, place a 100-kΩ resistor to AGND for proper detection of the VDD off condition.
- All the digital outputs are open drain; use external pullup resistors on these pins.
- The interface protocol is detected at power-on, and the device locks to the protocol as long as VDD is on.
- When allocating nonoverlapping I²C addresses on a system I²C bus, consider the broadcast address as well. I²C timeout can be enabled for robustness.
- SPI mode is 3-wire by default. Configure the GPIO pin as SDO in the NVM for SPI readback capability. The SPI clock speed in readback mode is slower than that in write mode.
- Power-down mode sets the DAC outputs in Hi-Z by default. Change the configuration appropriately for different power-down settings. The DAC channels can also power-up with a programmed DAC code in the NVM.

8.2 Typical Application

A power-supply margining and scaling circuit is used to trim, scale, or test the output of a power converter. This example circuit is used to test a system by margining the power supplies for adaptive voltage scaling or to program a desired value at the output. Adjustable power supplies, such as low-dropout regulators (LDOs) and DC/DC converters, provide a feedback or adjust the input that is used to set the desired output. A precision voltage-output DAC is the best choice for controlling the power-supply output linearly.  8-1 shows a control circuit for a switch-mode power supply (SMPS) using the DAC63202W. Typical applications of power-supply margining are communications equipment, enterprise servers, test and measurement, and general-purpose power-supply modules.



图 8-1. Voltage Margining and Scaling

8.2.1 Design Requirements

表 8-1. Design Parameters

PARAMETER	VALUE
Power-supply nominal output	3.3 V
Reference voltage of the converter (V_{FB})	0.6 V
Margin	$\pm 10\%$ (that is, 2.97 V to 3.63 V)
DAC output range	1.8 V
Nominal current through R_1 and R_2	100 μ A

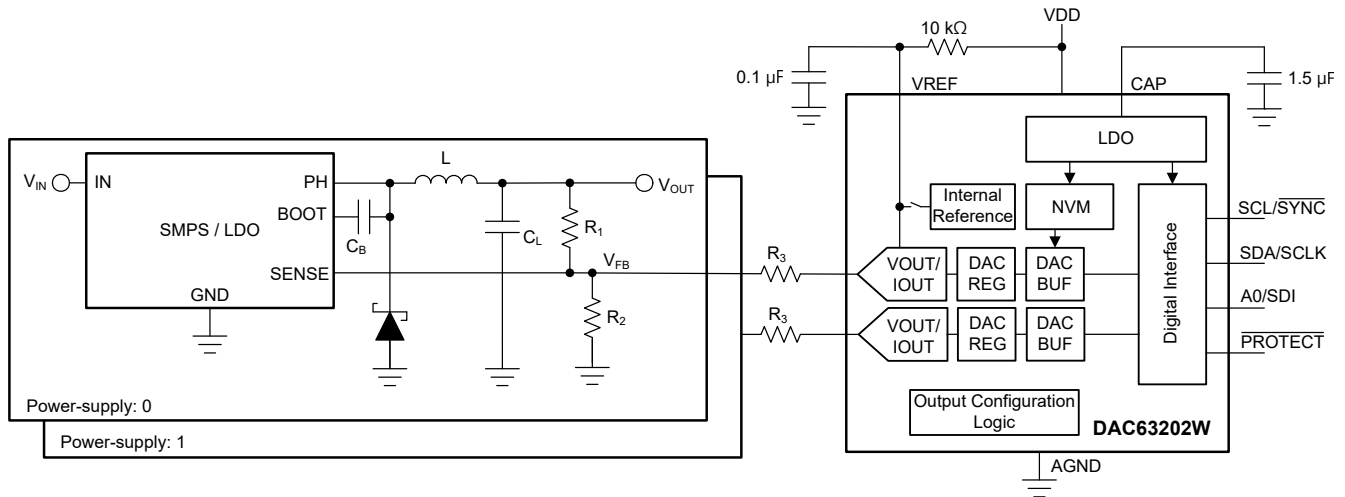
8.2.2 Detailed Design Procedure

The DAC63202W features a Hi-Z power-down mode that is set by default at power-up, unless the device is programmed otherwise using the NVM. When the DAC output is at Hi-Z, the current through R_3 is zero and the SMPS is set at the nominal output voltage of 3.3 V. To have the same nominal condition when the DAC powers up, bring up the device at the same output as V_{FB} (that is 0.6 V). This configuration makes sure there is no current through R_3 even at power-up. Calculate R_1 as $(V_{OUT} - V_{FB}) / 100 \mu\text{A} = 27 \text{ k}\Omega$.

To achieve $\pm 10\%$ margin-high and margin-low conditions, the DAC must sink or source additional current through R_1 . Calculate the current from the DAC (I_{MARGIN}) using 式 9 as 12 μA .

$$I_{MARGIN} = \left(\frac{V_{OUT} \times (1 + MARGIN) - V_{FB}}{R_1} \right) - I_{NOMINAL} \quad (9)$$

where

- I_{MARGIN} is the margin current sourced or sinked from the DAC.
- MARGIN is the percentage margin value divided by 100.
- $I_{NOMINAL}$ is the nominal current through R_1 and R_2 .
- V_{OUT} is the output voltage of the respective DAC channel.
- V_{FB} is the reference voltage at the SENSE node of the power converter.
- R_1 is the resistance between the output and SENSE pin of the power converter.

To calculate the value of R_3 , first decide the DAC output range, and make sure to avoid the codes near zero-scale and full-scale for safe operation in the linear region. A DAC output of 20 mV is a safe consideration as the minimum output, and $(1.8 \text{ V} - 0.6 \text{ V} - 20 \text{ mV} = 1.18 \text{ V})$ as the maximum output. When the DAC output is at 20 mV, the power supply goes to margin high, and when the DAC output is at 1.18 V, the power supply goes to margin low. Calculate the value of R_3 using 式 10 as 48.3 k Ω . Choose a standard resistor value and adjust the

DAC outputs. Choosing $R_3 = 47 \text{ k}\Omega$ makes the DAC margin high code as 1.164 V and the DAC margin low code as 36 mV.

$$R_3 = \frac{|V_{\text{DAC}} - V_{\text{FB}}|}{I_{\text{MARGIN}}} \quad (10)$$

When the DAC63202W are set to current-output mode, series resistor R_3 is not required. Set the DAC output at the current-output range of $-25 \mu\text{A}$ to $+25 \mu\text{A}$, and set the DAC code accordingly to achieve a margin current of $\pm 12 \mu\text{A}$.

The DAC63202W have a slew-rate feature that is used to toggle between margin high, margin low, and nominal outputs with a defined slew rate; see also [セクション 7.6.7](#).

注

The DAC-X-MARGIN-HIGH register value in DAC63202W results in the *margin-low* value at the power supply output. Similarly, the DAC-X-MARGIN-LOW register value in DAC63202W results in the *margin-high* value at the power-supply output.

The pseudocode for getting started with a power-supply control application is as follows:

```
//SYNTAX: WRITE <REGISTER NAME (Hex code)>, <MSB DATA>, <LSB DATA>
//Write DAC code for nominal output (repeat for all DAC channels)
//For a 1.8-V output range, the 10-bit hex code for 0.6 V is 0x155. With 16-bit left alignment,
this becomes 0x5540
WRITE DAC_0_DATA(0x1C), 0x55, 0x40
//Power-up voltage output on both the channels, enables internal reference
WRITE COMMON-CONFIG(0x1F), 0x12, 0x01
//Set channel 0 gain setting to 1.5x internal reference (1.8 V)
WRITE DAC-0-VOOUT-CMP-CONFIG(0x15), 0x08, 0x00
//Set channel 1 gain setting to 1.5x internal reference (1.8 V)
WRITE DAC-1-VOOUT-CMP-CONFIG(0x3), 0x08, 0x00
//Configure GPI for Margin-High, Low trigger for all channels
WRITE GPIO-CONFIG(0x24), 0x01, 0x35
//Set slew rate and code step (repeat for all channels)
//CODE_STEP: 2 LSB, SLEW_RATE: 60.72 μs/step
WRITE DAC-0-FUNC-CONFIG(0x18), 0x00, 0x17
//Write DAC margin high code (repeat for all channels)
//For a 1.8-V output range, the 10-bit hex code for 1.164 V is 0x296. With 16-bit left alignment,
this becomes 0xA540
WRITE DAC-0-MARGIN-HIGH(0x13), 0xA5, 0x40
//Write DAC margin low code (repeat for all channels)
//For a 1.8-V output range, the 10-bit hex code for 36 mV is 0x14. With 16-bit left alignment, this
becomes 0x0500
WRITE DAC-0-MARGIN-LOW(0x14), 0x05, 0x00
//Save settings to NVM
WRITE COMMON-TRIGGER(0x20), 0x00, 0x02
```

8.2.3 Application Curves

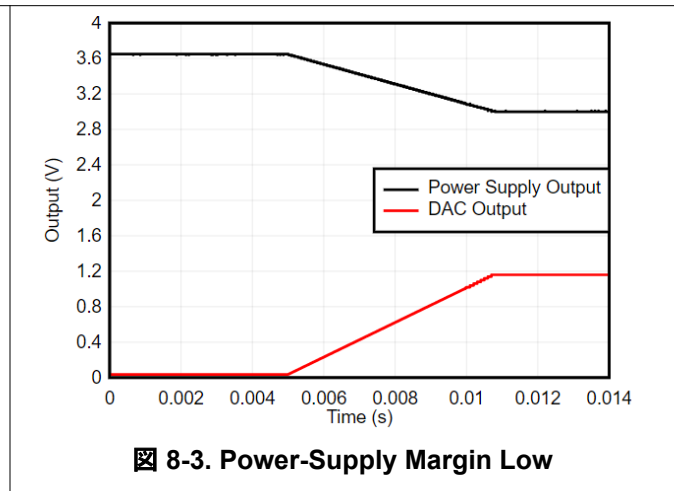
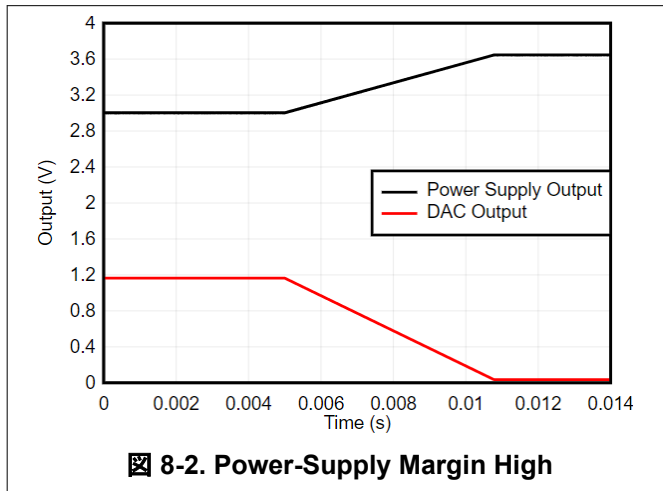

8.3 Power Supply Recommendations

The DAC63202W family of devices does not require specific power-supply sequencing. These devices require a single power supply, V_{DD} . However, make sure the external voltage reference is applied after V_{DD} . Use a 0.1- μF decoupling capacitor for the V_{DD} pin. Use a bypass capacitor with a value approximately 1.5 μF for the CAP pin.

8.4 Layout

8.4.1 Layout Guidelines

The DAC63202W pin configuration separates the analog, digital, and power pins for an optimized layout. For signal integrity, separate the digital and analog traces, and place decoupling capacitors close to the device pins.

8.4.2 Layout Example

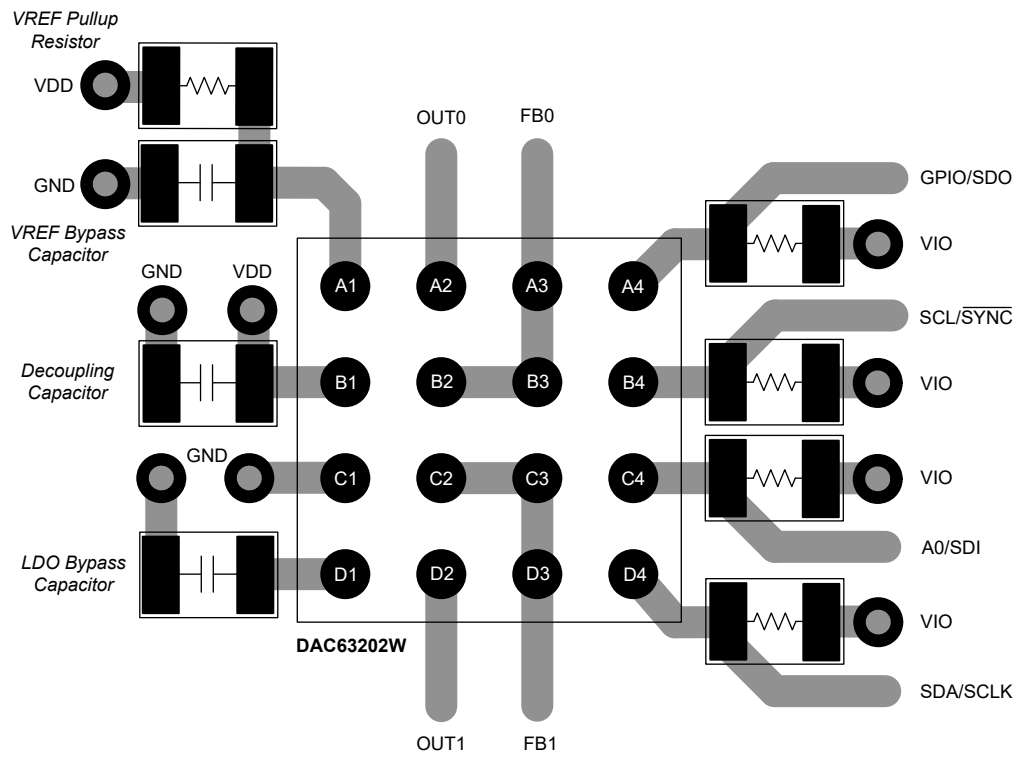

8-4. Layout Example

Note: The ground and power planes have been omitted for clarity. Connect the thermal pad to ground.

9 Device and Documentation Support

TI offers an extensive line of development tools. Tools and software to evaluate the performance of the device, generate code, and develop solutions are listed below.

9.1 Documentation Support

9.1.1 Related Documentation

The following EVM user's guide is available: [DACx3204 Evaluation Module user's guide](#)

9.2 ドキュメントの更新通知を受け取る方法

ドキュメントの更新についての通知を受け取るには、[ti.com](#) のデバイス製品フォルダを開いてください。「更新の通知を受け取る」をクリックして登録すると、変更されたすべての製品情報に関するダイジェストを毎週受け取れます。変更の詳細については、修正されたドキュメントに含まれている改訂履歴をご覧ください。

9.3 サポート・リソース

[TI E2E™ サポート・フォーラム](#)は、エンジニアが検証済みの回答と設計に関するヒントをエキスパートから迅速かつ直接得ることができる場所です。既存の回答を検索したり、独自の質問をしたりすることで、設計に必要な支援を迅速に得ることができます。

リンクされているコンテンツは、該当する貢献者により、現状のまま提供されるものです。これらは TI の仕様を構成するものではなく、必ずしも TI の見解を反映したものではありません。TI の[使用条件](#)を参照してください。

9.4 Trademarks

PMBus™ is a trademark of SMIF, Inc..

TI E2E™ is a trademark of Texas Instruments.

すべての商標は、それぞれの所有者に帰属します。

9.5 静電気放電に関する注意事項



この IC は、ESD によって破損する可能性があります。テキサス・インスツルメンツは、IC を取り扱う際には常に適切な注意を払うことを推奨します。正しい取り扱いおよび設置手順に従わない場合、デバイスを破損するおそれがあります。

ESD による破損は、わずかな性能低下からデバイスの完全な故障まで多岐にわたります。精密な IC の場合、パラメータがわずかに変化するだけで公表されている仕様から外れる可能性があるため、破損が発生しやすくなっています。

9.6 用語集

[テキサス・インスツルメンツ用語集](#) この用語集には、用語や略語の一覧および定義が記載されています。

10 Mechanical, Packaging, and Orderable Information

The following pages include mechanical, packaging, and orderable information. This information is the most current data available for the designated devices. This data is subject to change without notice and revision of this document. For browser-based versions of this data sheet, refer to the left-hand navigation.

PACKAGING INFORMATION

Orderable Device	Status (1)	Package Type	Package Drawing	Pins	Package Qty	Eco Plan (2)	Lead finish/ Ball material (6)	MSL Peak Temp (3)	Op Temp (°C)	Device Marking (4/5)	Samples
DAC63202YBHR	ACTIVE	DSBGA	YBH	16	3000	RoHS & Green	SNAGCU	Level-1-260C-UNLIM	-40 to 125	DAC 63202	Samples

(1) The marketing status values are defined as follows:

ACTIVE: Product device recommended for new designs.

LIFEBUY: TI has announced that the device will be discontinued, and a lifetime-buy period is in effect.

NRND: Not recommended for new designs. Device is in production to support existing customers, but TI does not recommend using this part in a new design.

PREVIEW: Device has been announced but is not in production. Samples may or may not be available.

OBSOLETE: TI has discontinued the production of the device.

(2) **RoHS:** TI defines "RoHS" to mean semiconductor products that are compliant with the current EU RoHS requirements for all 10 RoHS substances, including the requirement that RoHS substance do not exceed 0.1% by weight in homogeneous materials. Where designed to be soldered at high temperatures, "RoHS" products are suitable for use in specified lead-free processes. TI may reference these types of products as "Pb-Free".

RoHS Exempt: TI defines "RoHS Exempt" to mean products that contain lead but are compliant with EU RoHS pursuant to a specific EU RoHS exemption.

Green: TI defines "Green" to mean the content of Chlorine (Cl) and Bromine (Br) based flame retardants meet JS709B low halogen requirements of <=1000ppm threshold. Antimony trioxide based flame retardants must also meet the <=1000ppm threshold requirement.

(3) MSL, Peak Temp. - The Moisture Sensitivity Level rating according to the JEDEC industry standard classifications, and peak solder temperature.

(4) There may be additional marking, which relates to the logo, the lot trace code information, or the environmental category on the device.

(5) Multiple Device Markings will be inside parentheses. Only one Device Marking contained in parentheses and separated by a "~" will appear on a device. If a line is indented then it is a continuation of the previous line and the two combined represent the entire Device Marking for that device.

(6) Lead finish/Ball material - Orderable Devices may have multiple material finish options. Finish options are separated by a vertical ruled line. Lead finish/Ball material values may wrap to two lines if the finish value exceeds the maximum column width.

Important Information and Disclaimer:The information provided on this page represents TI's knowledge and belief as of the date that it is provided. TI bases its knowledge and belief on information provided by third parties, and makes no representation or warranty as to the accuracy of such information. Efforts are underway to better integrate information from third parties. TI has taken and continues to take reasonable steps to provide representative and accurate information but may not have conducted destructive testing or chemical analysis on incoming materials and chemicals. TI and TI suppliers consider certain information to be proprietary, and thus CAS numbers and other limited information may not be available for release.

In no event shall TI's liability arising out of such information exceed the total purchase price of the TI part(s) at issue in this document sold by TI to Customer on an annual basis.

YBH0016

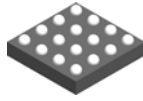

PACKAGE OUTLINE

DSBGA - 0.4 mm max height

DIE SIZE BALL GRID ARRAY

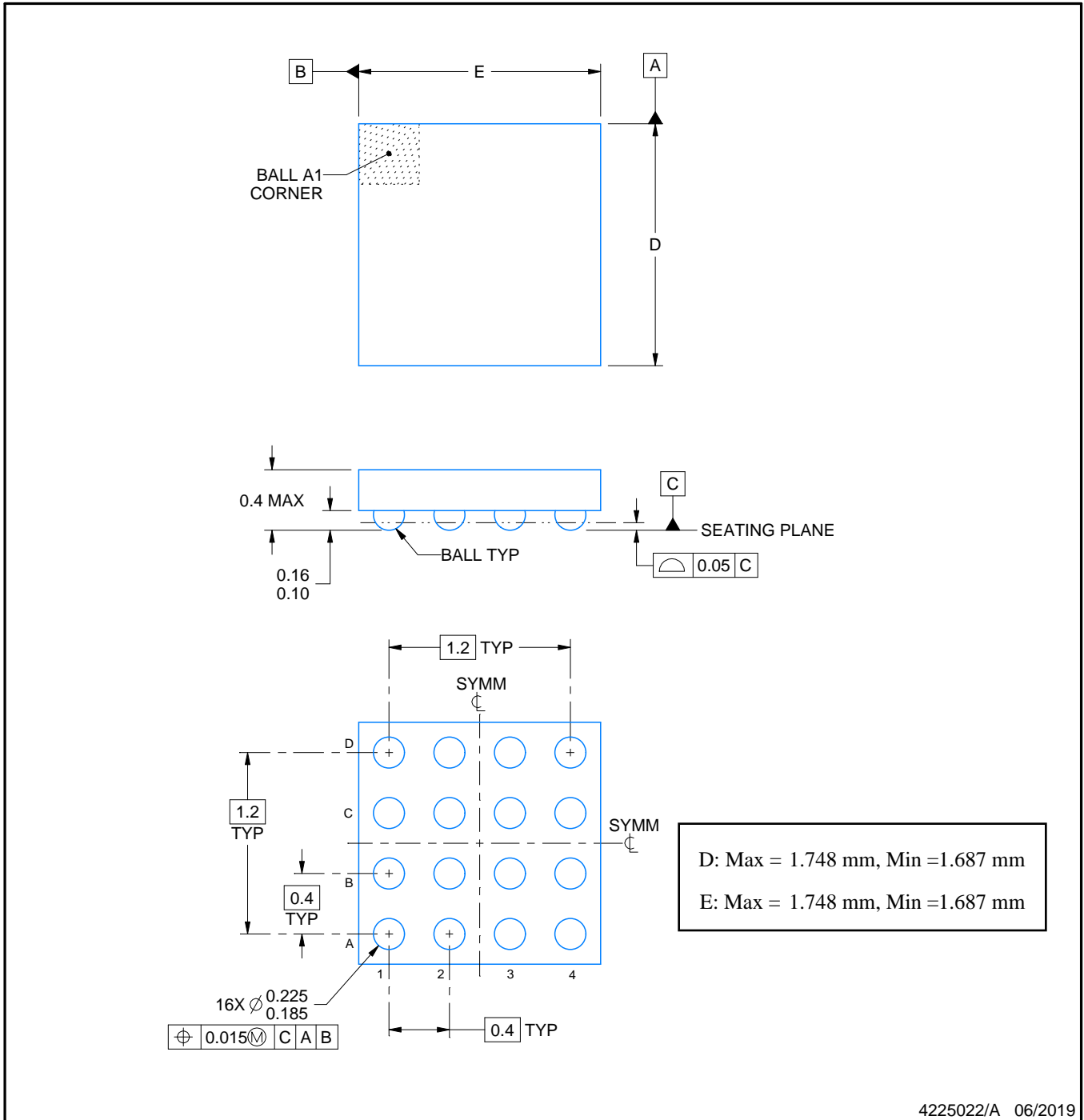

NOTES:

- 1. All linear dimensions are in millimeters. Any dimensions in parenthesis are for reference only. Dimensioning and tolerancing per ASME Y14.5M.
- 2. This drawing is subject to change without notice.

EXAMPLE BOARD LAYOUT

YBH0016

DSBGA - 0.4 mm max height

DIE SIZE BALL GRID ARRAY

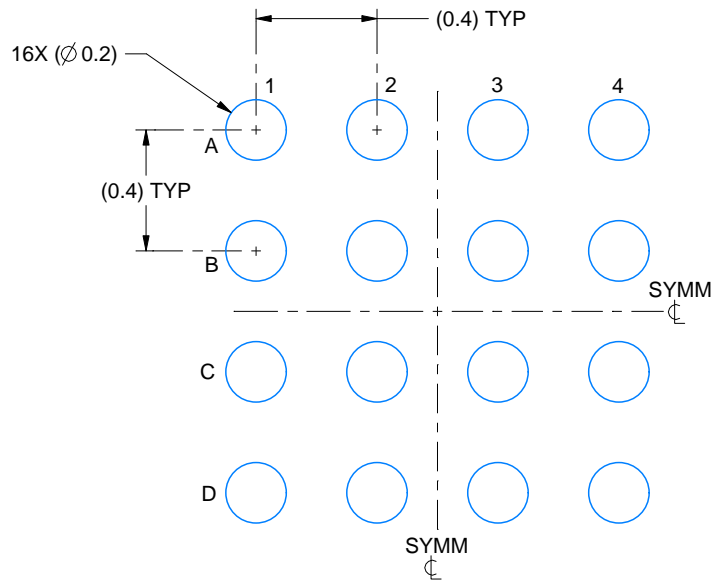

LAND PATTERN EXAMPLE
EXPOSED METAL SHOWN
SCALE: 40X

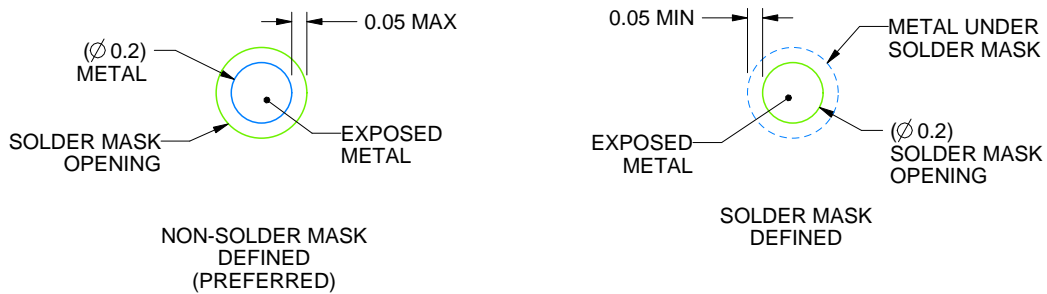

SOLDER MASK DETAILS
NOT TO SCALE

4225022/A 06/2019

NOTES: (continued)

- Final dimensions may vary due to manufacturing tolerance considerations and also routing constraints. See Texas Instruments Literature No. SNVA009 (www.ti.com/lit/snva009).

EXAMPLE STENCIL DESIGN

YBH0016

DSBGA - 0.4 mm max height

DIE SIZE BALL GRID ARRAY

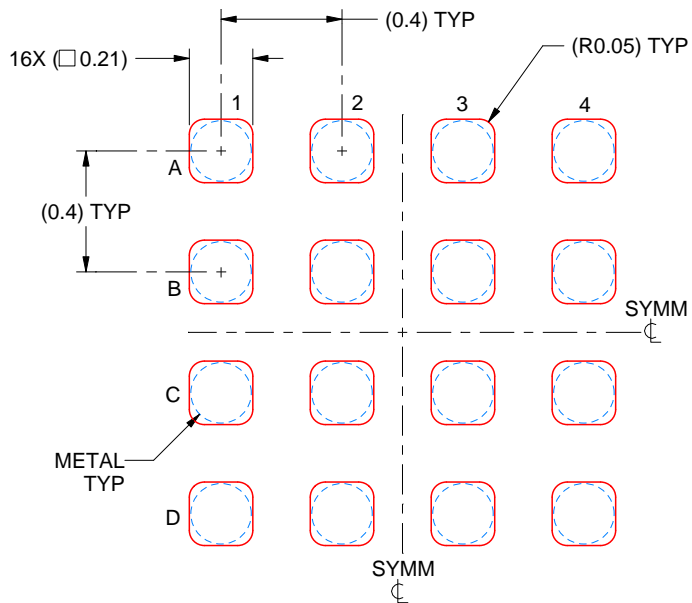

SOLDER PASTE EXAMPLE
BASED ON 0.075 mm THICK STENCIL
SCALE: 40X

4225022/A 06/2019

NOTES: (continued)

4. Laser cutting apertures with trapezoidal walls and rounded corners may offer better paste release.

重要なお知らせと免責事項

TI は、技術データと信頼性データ (データシートを含みます)、設計リソース (リファレンス・デザインを含みます)、アプリケーションや設計に関する各種アドバイス、Web ツール、安全性情報、その他のリソースを、欠陥が存在する可能性のある「現状のまま」提供しており、商品性および特定目的に対する適合性の黙示保証、第三者の知的財産権の非侵害保証を含むいかなる保証も、明示的または黙示的にかかわらず拒否します。

これらのリソースは、TI 製品を使用する設計の経験を積んだ開発者への提供を意図したものです。(1) お客様のアプリケーションに適した TI 製品の選定、(2) お客様のアプリケーションの設計、検証、試験、(3) お客様のアプリケーションに該当する各種規格や、その他のあらゆる安全性、セキュリティ、規制、または他の要件への確実な適合に関する責任を、お客様のみが単独で負うものとし、

上記の各種リソースは、予告なく変更される可能性があります。これらのリソースは、リソースで説明されている TI 製品を使用するアプリケーションの開発の目的でのみ、TI はその使用をお客様に許諾します。これらのリソースに関して、他の目的で複製することや掲載することは禁止されています。TI や第三者の知的財産権のライセンスが付与されている訳ではありません。お客様は、これらのリソースを自身で使用した結果発生するあらゆる申し立て、損害、費用、損失、責任について、TI およびその代理人を完全に補償するものとし、TI は一切の責任を拒否します。

TI の製品は、[TI の販売条件](#)、または [ti.com](https://www.ti.com) やかかる TI 製品の関連資料などのいずれかを通じて提供する適用可能な条項の下で提供されています。TI がこれらのリソースを提供することは、適用される TI の保証または他の保証の放棄の拡大や変更を意味するものではありません。

お客様がいかなる追加条項または代替条項を提案した場合でも、TI はそれらに異議を唱え、拒否します。

郵送先住所 : Texas Instruments, Post Office Box 655303, Dallas, Texas 75265
Copyright © 2023, Texas Instruments Incorporated