

## DRV5055-Q1 車載用レシオメトリック・リニア・ホール効果センサ

### 1 特長

- レシオメトリックリニア ホール効果磁気センサ
- 3.3V～5V 電源で動作
- $V_{CC}/2$  の静止オフセット付きのアナログ出力
- 磁気感度オプション ( $V_{CC} = 5V$  時)
  - A1: 100mV/mT,  $\pm 21mT$  範囲
  - A2/Z2: 50mV/mT,  $\pm 42mT$  範囲
  - A3: 25mV/mT,  $\pm 85mT$  範囲
  - A4: 12.5mV/mT,  $\pm 169mT$  範囲
  - A5: -100mV/mT,  $\pm 21mT$  範囲
- 高速な 20kHz センシング帯域幅
- $\pm 1mA$  駆動の低ノイズ出力
- Aバージョンでは磁石の温度ドリフトの補償があるが、Zバージョンでは補償なし
- 車載アプリケーション用に AEC-Q100 認定済み:
  - 温度グレード 0: -40°C～150°C
- 標準の産業用パッケージ:
  - 表面実装の SOT-23
  - スルーホールの TO-92

### 2 アプリケーション

- 車載用位置センシング
- ブレーキ、アクセル、クラッチ ペダル
- トルク センサ
- ギア シフタ
- スロットル ポジション
- 高さレベリング
- パワートレインおよびトランスミッション コンポーネント
- 絶対角度のエンコード
- 電流検出

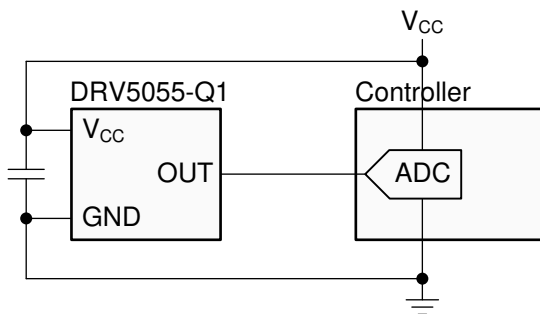

代表的な回路図

### 3 概要

DRV5055-Q1 デバイスは、リニア ホール効果センサで、磁束密度に正比例して応答します。このデバイスは、広範なアプリケーションにおいて、正確な位置センシングに使用できます。

このデバイスは、3.3V または 5V の電源で動作します。磁界が存在しないとき、アナログ出力は  $V_{CC}$  の半分に駆動されます。出力は、印加される磁束密度に対して線形的に変化し、つの各種感度オプションによって、必要なセンシング範囲に基づいて出力電圧スイングを最大化できます。磁界の N 極と S 極がそれぞれ固有の電圧を生成します。

パッケージの上面に垂直な磁束が検出され、2 つのパッケージ オプションでセンシング方向が異なります。

このデバイスは、レシオメトリック アーキテクチャを使用し、外部のアナログ / デジタル コンバータ (ADC) が基準として同じ  $V_{CC}$  を使用しているとき、 $V_{CC}$  許容範囲から誤差を除去できます。さらに、デバイスには磁石温度補償が搭載されており、磁石のドリフトを補償することで、-40°C～+150°Cの広い温度範囲にわたって線形のパフォーマンスを実現します。

#### パッケージ情報

部品番号	パッケージ (1)	パッケージ サイズ(2)
DRV5055-Q1	DBZ (SOT-23, 3)	2.92mm × 2.37mm
	LPG (TO-92, 3)	4mm × 1.52mm

- 利用可能なすべてのパッケージについては、データシートの末尾にある注文情報を参照してください。
- パッケージ サイズ (長さ×幅) は公称値であり、該当する場合はピンも含まれます

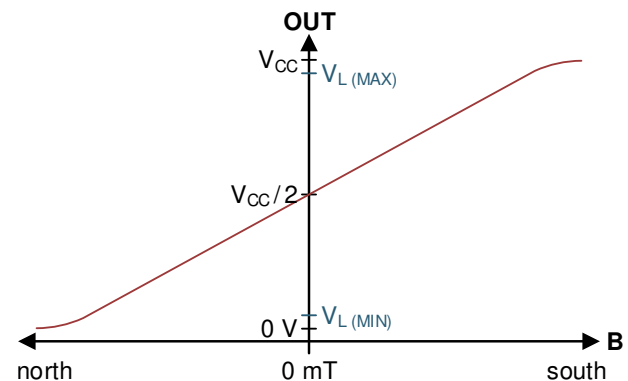

磁気応答 (A1、A2、A3、A4、Z2 バージョン)



## Table of Contents

<b>1 特長</b> .....	<b>1</b>	<b>7 Application and Implementation</b> .....	<b>15</b>
<b>2 アプリケーション</b> .....	<b>1</b>	7.1 Application Information.....	15
<b>3 概要</b> .....	<b>1</b>	7.2 Typical Application.....	16
<b>4 Pin Configuration and Functions</b> .....	<b>3</b>	7.3 Best Design Practices.....	18
<b>5 Specifications</b> .....	<b>4</b>	7.4 Power Supply Recommendations.....	19
5.1 Absolute Maximum Ratings.....	4	7.5 Layout.....	19
5.2 ESD Ratings.....	4	<b>8 Device and Documentation Support</b> .....	<b>20</b>
5.3 Recommended Operating Conditions.....	4	8.1 Documentation Support.....	20
5.4 Thermal Information.....	4	8.2 ドキュメントの更新通知を受け取る方法.....	20
5.5 Electrical Characteristics.....	5	8.3 サポート・リソース.....	20
5.6 Magnetic Characteristics.....	6	8.4 Trademarks.....	20
5.7 Typical Characteristics.....	7	8.5 静電気放電に関する注意事項.....	20
<b>6 Detailed Description</b> .....	<b>10</b>	8.6 用語集.....	20
6.1 Overview.....	10	<b>9 Revision History</b> .....	<b>20</b>
6.2 Functional Block Diagram.....	10	<b>10 Mechanical, Packaging, and Orderable Information</b> .....	<b>21</b>
6.3 Feature Description.....	10		
6.4 Device Functional Modes.....	14		

## 4 Pin Configuration and Functions



図 4-1. DBZ Package 3-Pin SOT-23 Top View



図 4-2. LPG Package 3-Pin TO-92 Top View

表 4-1. Pin Functions

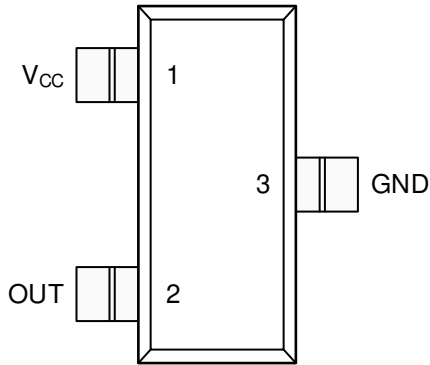
NAME	PIN		I/O	DESCRIPTION
	SOT-23	TO-92		
V <sub>CC</sub>	1	1	—	Power supply. TI recommends connecting this pin to a ceramic capacitor to ground with a value of at least 0.01 $\mu$ F.
OUT	2	3	O	Analog output
GND	3	2	—	Ground reference

## 5 Specifications

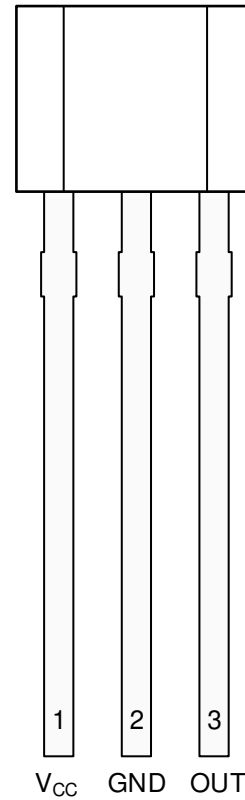
### 5.1 Absolute Maximum Ratings

over operating free-air temperature range (unless otherwise noted)<sup>(1)</sup>

		MIN	MAX	UNIT
Power supply voltage	V <sub>CC</sub>	-0.3	7	V
Output voltage	OUT	-0.3	V <sub>CC</sub> + 0.3	V
Magnetic flux density, B <sub>MAX</sub>		Unlimited		T
Operating junction temperature, T <sub>J</sub>		-40	170	°C
Storage temperature, T <sub>stg</sub>		-65	150	°C

- (1) Stresses beyond those listed under *Absolute Maximum Ratings* may cause permanent damage to the device. These are stress ratings only, which do not imply functional operation of the device at these or any other conditions beyond those indicated under *Recommended Operating Conditions*. Exposure to absolute-maximum-rated conditions for extended periods may affect device reliability.

### 5.2 ESD Ratings

		VALUE	UNIT
V <sub>(ESD)</sub>	Electrostatic discharge	Human body model (HBM), per AEC Q100-002 <sup>(1)</sup>	±2500
		Charged device model (CDM), per AEC Q100-011	±750

- (1) AEC Q100-002 indicates that HBM stressing shall be in accordance with the ANSI/ESDA/JEDEC JS-001 specification.

### 5.3 Recommended Operating Conditions

over operating free-air temperature range (unless otherwise noted)

		MIN	MAX	UNIT
V <sub>CC</sub>	Power supply voltage <sup>(1)</sup>	3	3.63	V
		4.5	5.5	
I <sub>O</sub>	Output continuous current	-1	1	mA
T <sub>A</sub>	Operating ambient temperature <sup>(2)</sup>	-40	150	°C

- (1) There are two isolated operating V<sub>CC</sub> ranges. For more information see the [Operating V<sub>CC</sub> Ranges](#) section.  
 (2) Power dissipation and thermal limits must be observed.

### 5.4 Thermal Information

THERMAL METRIC <sup>(1)</sup>		DRV5055-Q1		UNIT
		SOT-23 (DBZ)	TO-92 (LPG)	
		3 PINS	3 PINS	
R <sub>θJA</sub>	Junction-to-ambient thermal resistance	170	121	°C/W
R <sub>θJC(top)</sub>	Junction-to-case (top) thermal resistance	66	67	°C/W
R <sub>θJB</sub>	Junction-to-board thermal resistance	49	97	°C/W
Y <sub>JT</sub>	Junction-to-top characterization parameter	1.7	7.6	°C/W
Y <sub>JB</sub>	Junction-to-board characterization parameter	48	97	°C/W

- (1) For more information about traditional and new thermal metrics, see the [Semiconductor and IC Package Thermal Metrics](#) application note.

## 5.5 Electrical Characteristics

for  $V_{CC} = 3V$  to  $3.63V$  and  $4.5V$  to  $5.5V$ , over operating free-air temperature range (unless otherwise noted)

PARAMETER		TEST CONDITIONS <sup>(1)</sup>		MIN	TYP	MAX	UNIT
$I_{CC}$	Operating supply current				6	10	mA
$t_{ON}$	Power-on time (see <a href="#">6-4</a> )				175	330	$\mu s$
$f_{BW}$	Sensing bandwidth				20		kHz
$t_d$	Propagation delay time	From change in B to change in OUT			10		$\mu s$
$B_{ND}$	Input-referred RMS noise density	$V_{CC} = 5V$			130		$nT/\sqrt{Hz}$
		$V_{CC} = 3.3V$			215		
$B_N$	Input-referred noise	$B_{ND} \times 6.6 \times \sqrt{20 \text{ kHz}}$	$V_{CC} = 5V$		0.12		$mT_{PP}$
			$V_{CC} = 3.3V$		0.2		
$V_N$	Output-referred noise <sup>(2)</sup>	$B_N \times S$	DRV5055A1, DRV5055A5		12		$mV_{PP}$
			DRV5055A2, DRV5055Z2		6		$mV_{PP}$
			DRV5055A3		3		$mV_{PP}$
			DRV5055A4		1.5		$mV_{PP}$

(1) B is the applied magnetic flux density.

(2)  $V_N$  describes voltage noise on the device output. If the full device bandwidth is not needed, noise can be reduced with an RC filter.

## 5.6 Magnetic Characteristics

for  $V_{CC} = 3V$  to  $3.63V$  and  $4.5V$  to  $5.5V$ , over operating free-air temperature range (unless otherwise noted)

PARAMETER		TEST CONDITIONS <sup>(1)</sup>		MIN	TYP	MAX	UNIT	
$V_Q$	Quiescent voltage	$B = 0\text{ mT}, T_A = 25^\circ\text{C}$	$V_{CC} = 5V$	2.43	2.5	2.57	V	
			$V_{CC} = 3.3V$	1.59	1.65	1.71		
$V_{Q\Delta T}$	Quiescent voltage temperature drift	$B = 0\text{ mT}, T_A = -40^\circ\text{C}$ to $150^\circ\text{C}$ versus $25^\circ\text{C}$		$\pm 1\% \times V_{CC}$			V	
$V_{QRE}$	Quiescent voltage ratiometry error <sup>(2)</sup>			$\pm 0.2$			%	
$V_{Q\Delta L}$	Quiescent voltage lifetime drift	High-temperature operating stress for 1000 hours		<0.5			%	
S	Sensitivity	$V_{CC} = 5V,$ $T_A = 25^\circ\text{C}$	DRV5055A1	95	100	105	mV/mT	
			DRV5055A2/Z2	47.5	50	52.5		
			DRV5055A3	23.8	25	26.2		
			DRV5055A4	11.9	12.5	13.2		
			DRV5055A5	-105	-100	-95		
		$V_{CC} = 3.3V,$ $T_A = 25^\circ\text{C}$	DRV5055A1	57	60	63		
			DRV5055A2/Z2	28.5	30	31.5		
			DRV5055A3	14.3	15	15.8		
			DRV5055A4	7.1	7.5	7.9		
			DRV5055A5	-63	-60	-57		
$B_L$	Linear magnetic sensing range <sup>(3) (4)</sup>	$V_{CC} = 5V,$ $T_A = 25^\circ\text{C}$	DRV5055A1, DRV5055A5	$\pm 21$			mT	
			DRV5055A2/Z2	$\pm 42$			mT	
			DRV5055A3	$\pm 85$			mT	
			DRV5055A4	$\pm 169$			mT	
		$V_{CC} = 3.3V,$ $T_A = 25^\circ\text{C}$	DRV5055A1, DRV5055A5	$\pm 22$			mT	
			DRV5055A2/Z2	$\pm 44$			mT	
			DRV5055A3	$\pm 88$			mT	
			DRV5055A4	$\pm 176$			mT	
$V_L$	Linear range of output voltage <sup>(4)</sup>			0.2	$V_{CC} - 0.2$		V	
$S_{TC}$	Sensitivity temperature compensation for magnets <sup>(5)</sup>	DRV5055A1/A2/A3/A4		0.12			%/°C	
		DRV5055Z2		0			%/°C	
$S_{LE}$	Sensitivity linearity error <sup>(4)</sup>	$V_{OUT}$ is within $V_L$		$\pm 1$			%	
$S_{SE}$	Sensitivity symmetry error <sup>(4)</sup>	$V_{OUT}$ is within $V_L$		$\pm 1$			%	
$S_{RE}$	Sensitivity ratiometry error <sup>(2)</sup>	$T_A = 25^\circ\text{C},$ with respect to $V_{CC} = 3.3V$ or $5V$		-2.5			2.5	%
$S_{\Delta L}$	Sensitivity lifetime drift	High-temperature operating stress for 1000 hours		<0.5			%	

(1) B is the applied magnetic flux density.

(2) See the [Ratiometric Architecture](#) section.

(3)  $B_L$  describes the minimum linear sensing range at  $25^\circ\text{C}$  taking into account the maximum  $V_Q$  and Sensitivity tolerances.

(4) See the [Sensitivity Linearity](#) section.

(5)  $S_{TC}$  describes the rate the device increases Sensitivity with temperature. For more information, see the [Sensitivity Temperature Compensation for Magnets](#) section.

## 5.7 Typical Characteristics

for  $T_A = 25^\circ\text{C}$  (unless otherwise noted)



図 5-1. Quiescent Voltage vs Temperature



図 5-2. Quiescent Voltage vs Supply Voltage

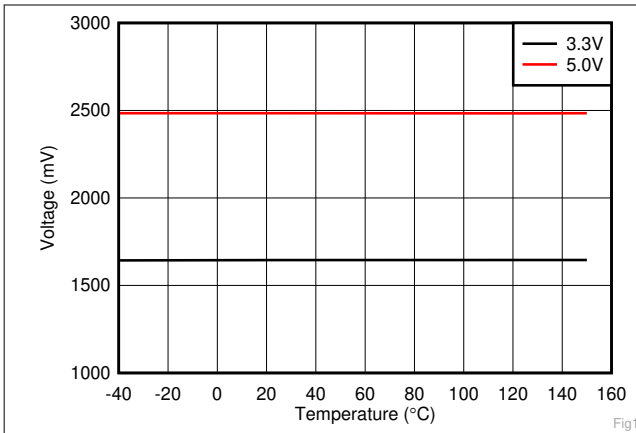

図 5-3. Sensitivity vs Supply Voltage

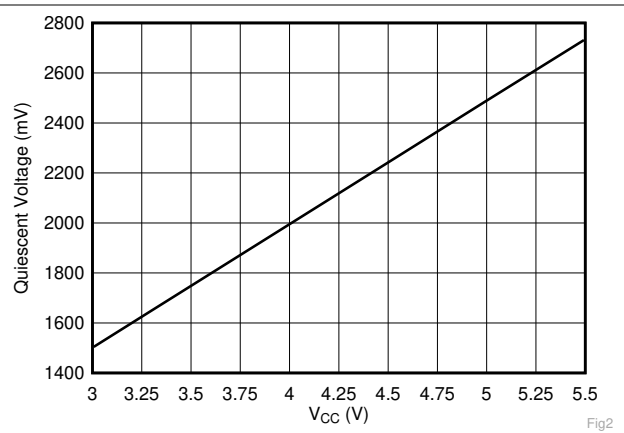

図 5-4. Sensitivity vs Supply Voltage

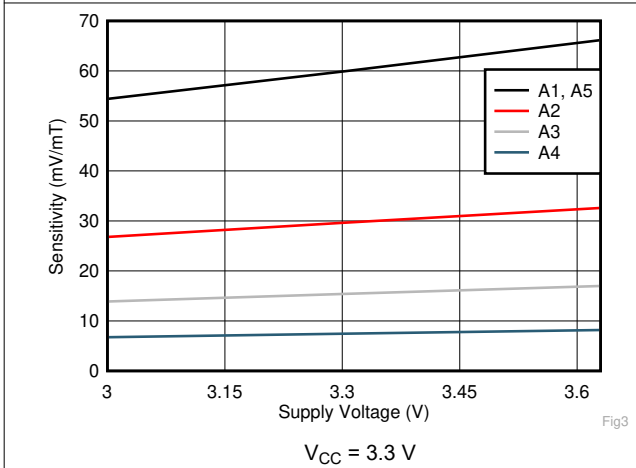

図 5-5. Supply Current vs. Temperature

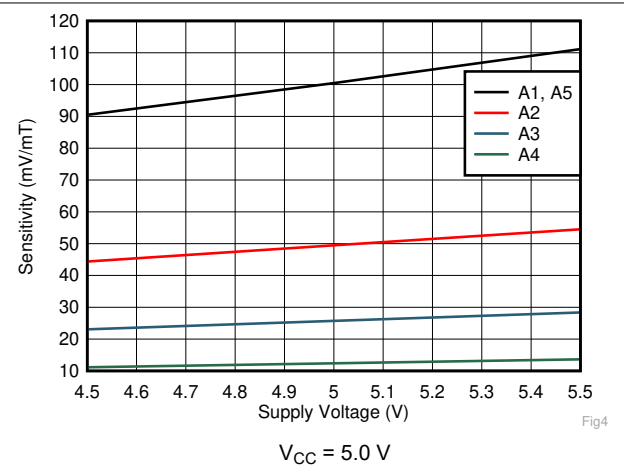

図 5-6. Sensitivity vs Temperature

### 5.7 Typical Characteristics (continued)

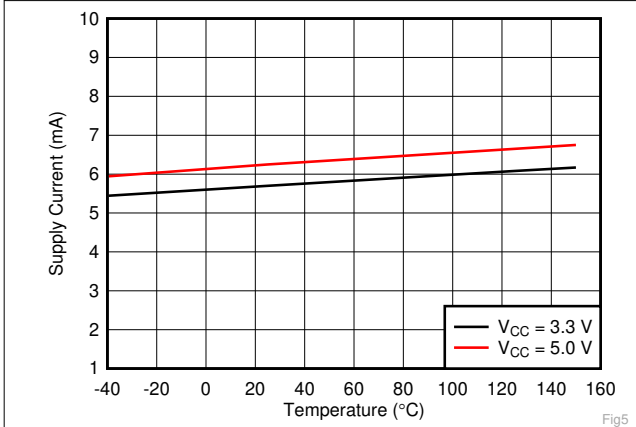
for  $T_A = 25^\circ\text{C}$  (unless otherwise noted)

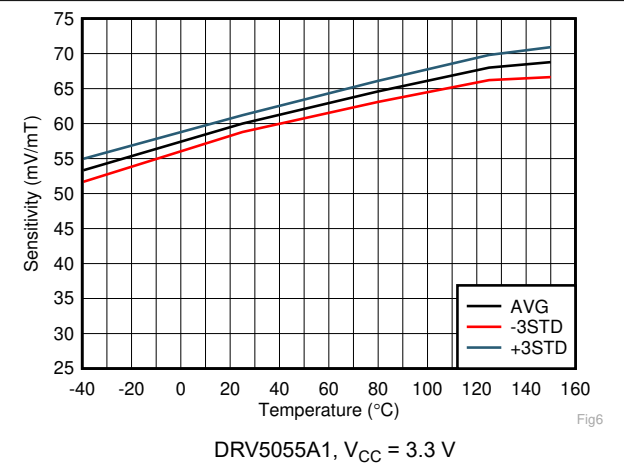
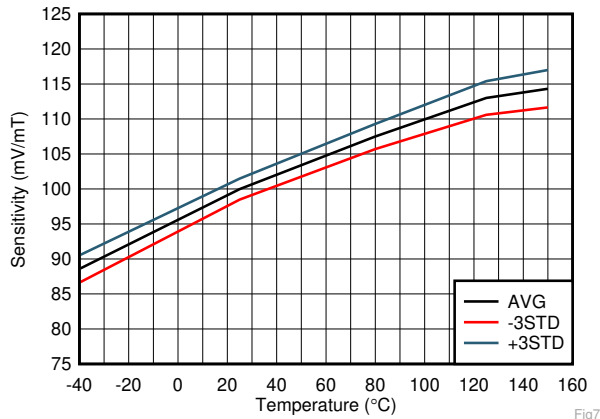

DRV5055A1,  $V_{CC} = 5.0\text{ V}$

5-7. Sensitivity vs Temperature

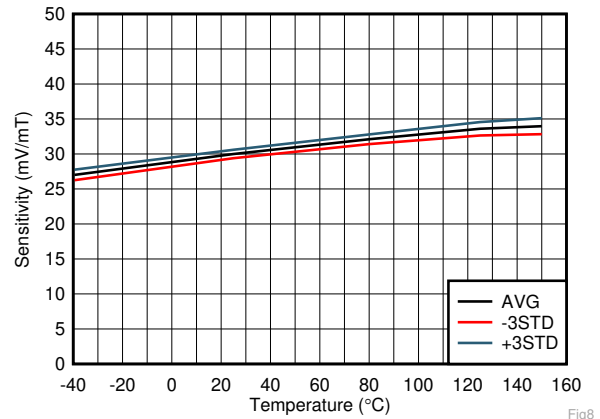

DRV5055A2,  $V_{CC} = 3.3\text{ V}$

5-8. Sensitivity vs Temperature

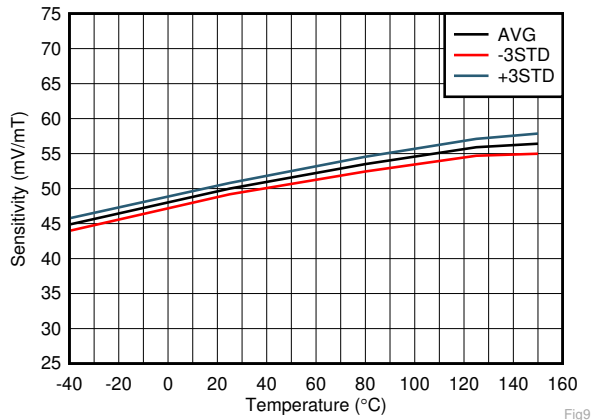

DRV5055A2,  $V_{CC} = 5.0\text{ V}$

5-9. Sensitivity vs. Temperature

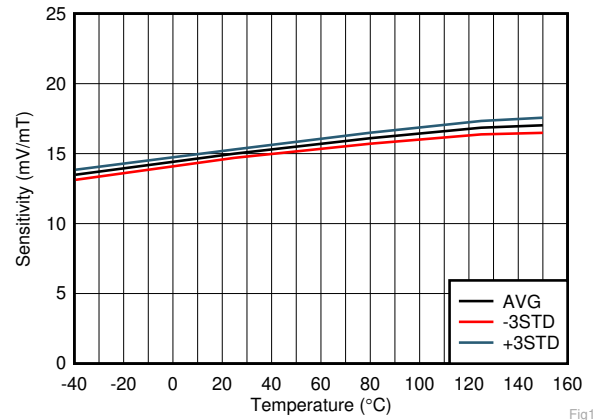

DRV5055A3,  $V_{CC} = 3.3\text{ V}$

5-10. Sensitivity vs. Temperature

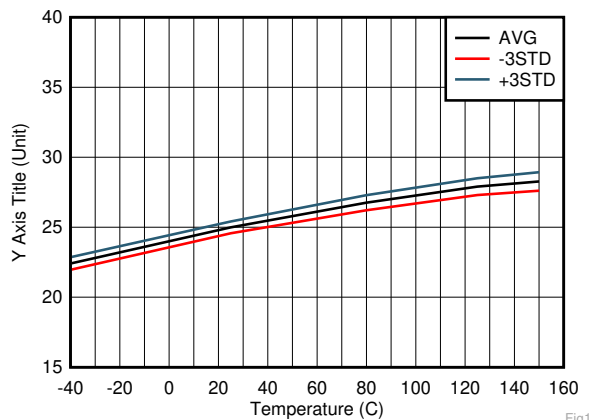

DRV5055A3,  $V_{CC} = 5.0\text{ V}$

5-11. Sensitivity vs. Temperature

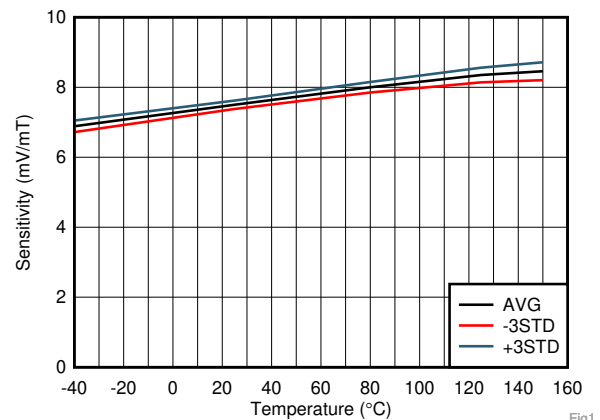

DRV5055A4,  $V_{CC} = 3.3\text{ V}$

5-12. Sensitivity vs. Temperature



### 5.7 Typical Characteristics (continued)

for  $T_A = 25^\circ\text{C}$  (unless otherwise noted)

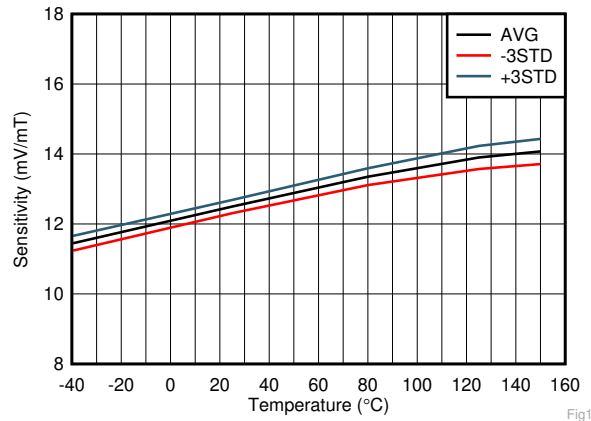

DRV5055A4,  $V_{CC} = 5.0\text{ V}$

Fig1  
図 5-13. Sensitivity vs Temperature

## 6 Detailed Description

### 6.1 Overview

The DRV5055-Q1 is a 3-pin linear Hall effect sensor with fully integrated signal conditioning, temperature compensation circuits, mechanical stress cancellation, and amplifiers. The device operates from 3.3-V and 5-V ( $\pm 10\%$ ) power supplies, measures magnetic flux density, and outputs a proportional analog voltage that is referenced to  $V_{CC}$ .

### 6.2 Functional Block Diagram

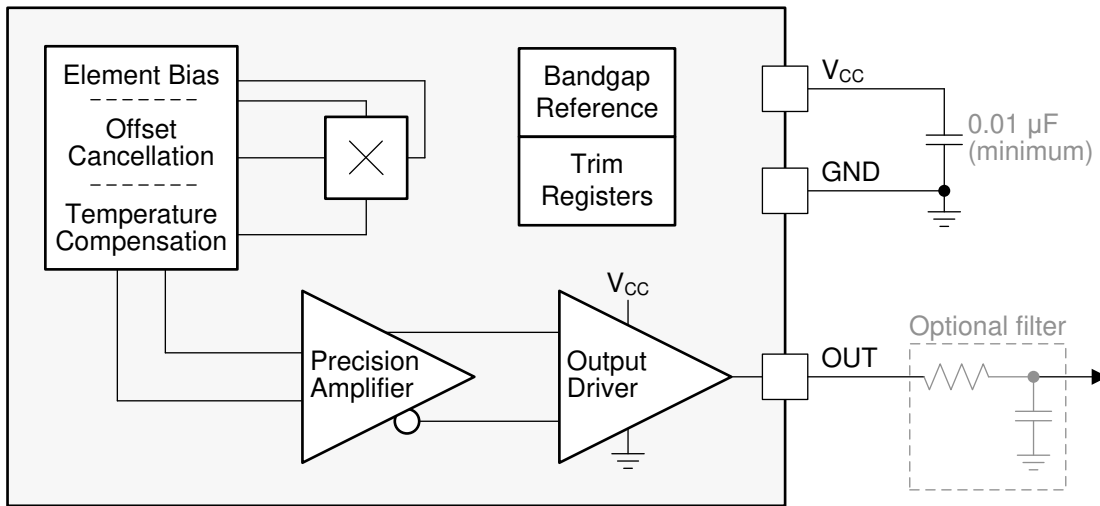

### 6.3 Feature Description

#### 6.3.1 Magnetic Flux Direction

As shown in  6-1, the DRV5055-Q1 is sensitive to the magnetic field component that is perpendicular to the top of the package.

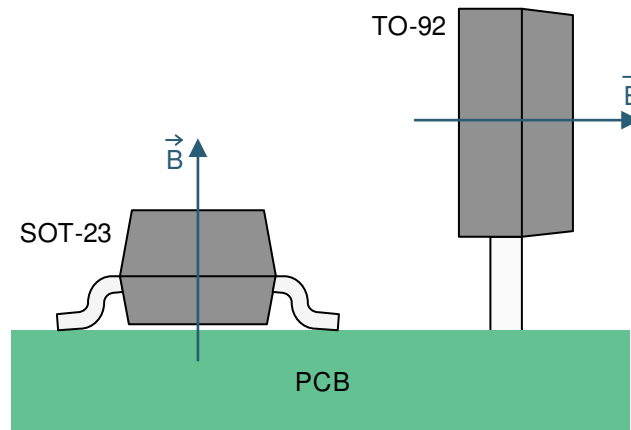

**図 6-1. Direction of Sensitivity**

Magnetic flux that travels from the bottom to the top of the package is considered positive in this document. This condition exists when a south magnetic pole is near the top (marked-side) of the package. Magnetic flux that travels from the top to the bottom of the package results in negative millitesla values.



図 6-2. The Flux Direction for Positive B

### 6.3.2 Magnetic Response

When the DRV5055-Q1 is powered, the DRV5055-Q1 outputs an analog voltage according to 式 1:

$$V_{OUT} = V_Q + B \times (\text{Sensitivity}_{(25^\circ\text{C})} \times (1 + S_{TC} \times (T_A - 25^\circ\text{C}))) \quad (1)$$

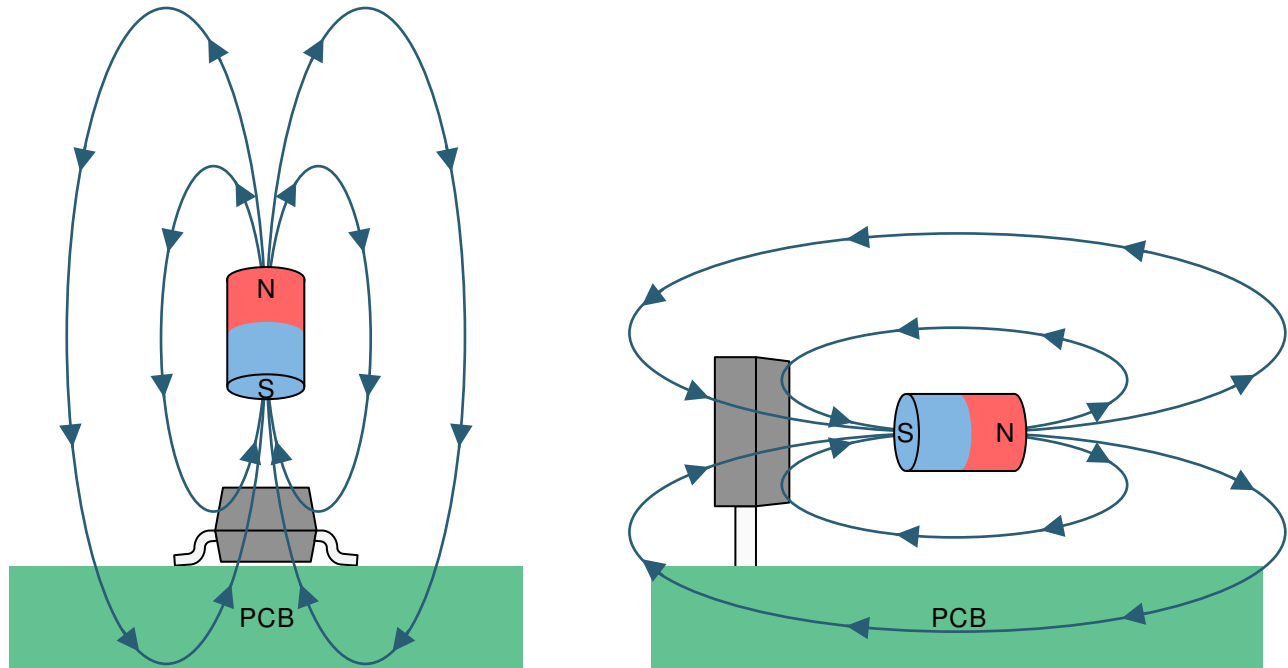
where

- $V_Q$  is typically half of  $V_{CC}$
- $B$  is the applied magnetic flux density
- $\text{Sensitivity}_{(25^\circ\text{C})}$  depends on the device option and  $V_{CC}$
- $S_{TC}$  is typically 0.12%/°C for device options DRV5055A1 - DRV5055A4 and is 0%/°C for DRV5055Z2
- $T_A$  is the ambient temperature
- $V_{OUT}$  is within the  $V_L$  range

As an example, consider the DRV5055A3 with  $V_{CC} = 3.3\text{ V}$ , a temperature of  $50^\circ\text{C}$ , and  $67\text{ mT}$  applied. Excluding tolerances,  $V_{OUT} = 1650\text{ mV} + 67\text{ mT} \times (15\text{ mV/mT} \times (1 + 0.0012/^\circ\text{C} \times (50^\circ\text{C} - 25^\circ\text{C}))) = 2685\text{ mV}$ .

### 6.3.3 Sensitivity Linearity

The device produces a linear response when the output voltage is within the specified  $V_L$  range. Outside this range, sensitivity is reduced and nonlinear. 図 6-3 graphs the magnetic response.



图 6-3. Magnetic Response

式 2 calculates parameter  $B_L$ , the minimum linear sensing range at 25°C taking into account the maximum quiescent voltage and sensitivity tolerances.

$$B_{L(MIN)} = \frac{V_{L(MAX)} - V_{Q(MAX)}}{S_{(MAX)}} \quad (2)$$

The parameter  $S_{LE}$  defines linearity error as the difference in sensitivity between any two positive  $B$  values, and any two negative  $B$  values, while the output is within the  $V_L$  range.

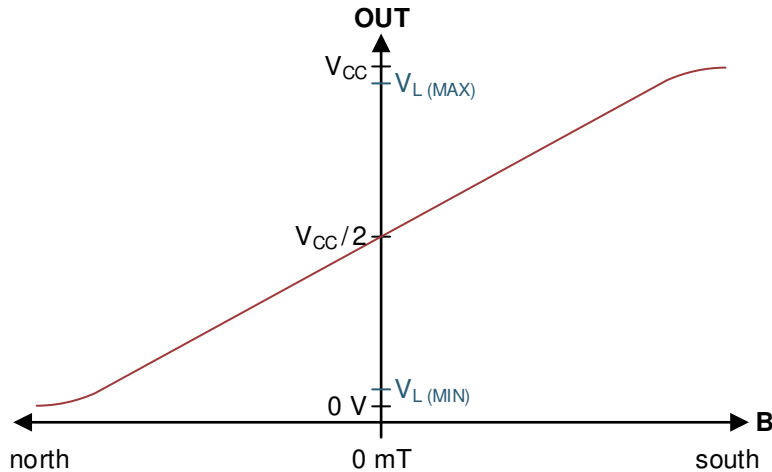
The parameter  $S_{SE}$  defines symmetry error as the difference in sensitivity between any positive  $B$  value and the negative  $B$  value of the same magnitude, while the output voltage is within the  $V_L$  range.

### 6.3.4 Ratiometric Architecture

The DRV5055-Q1 has a ratiometric analog architecture that scales the quiescent voltage and sensitivity linearly with the power-supply voltage. For example, the quiescent voltage and sensitivity are 5% higher when  $V_{CC} = 5.25$  V compared to  $V_{CC} = 5$  V. This behavior enables external ADCs to digitize a consistent value regardless of the power-supply voltage tolerance, when the ADC uses  $V_{CC}$  as its reference.

式 3 calculates the sensitivity ratiometry error:

$$S_{RE} = 1 - \frac{S_{(VCC)} / S_{(5V)}}{V_{CC} / 5V} \quad \text{for } V_{CC} = 4.5 \text{ V to } 5.5 \text{ V}, \quad S_{RE} = 1 - \frac{S_{(VCC)} / S_{(3.3V)}}{V_{CC} / 3.3V} \quad \text{for } V_{CC} = 3 \text{ V to } 3.63 \text{ V} \quad (3)$$

where

- $S_{(VCC)}$  is the sensitivity at the current  $V_{CC}$  voltage
- $S_{(5V)}$  or  $S_{(3.3V)}$  is the sensitivity when  $V_{CC} = 5$  V or 3.3 V
- $V_{CC}$  is the current  $V_{CC}$  voltage

式 4 calculates the quiescent voltage ratiometry error:

$$V_{QRE} = 1 - \frac{V_{Q(VCC)} / V_{Q(5V)}}{V_{CC} / 5V} \quad \text{for } V_{CC} = 4.5 \text{ V to } 5.5 \text{ V}, \quad V_{QRE} = 1 - \frac{V_{Q(VCC)} / V_{Q(3.3V)}}{V_{CC} / 3.3V} \quad \text{for } V_{CC} = 3 \text{ V to } 3.63 \text{ V} \quad (4)$$

where

- $V_{Q(VCC)}$  is the quiescent voltage at the current  $V_{CC}$  voltage
- $V_{Q(5V)}$  or  $V_{Q(3.3V)}$  is the quiescent voltage when  $V_{CC} = 5$  V or 3.3 V

- $V_{CC}$  is the current  $V_{CC}$  voltage

### 6.3.5 Operating $V_{CC}$ Ranges

The DRV5055-Q1 has two recommended operating  $V_{CC}$  ranges: 3 V to 3.63 V and 4.5 V to 5.5 V. When  $V_{CC}$  is in the middle region between 3.63 V to 4.5 V, the device continues to function, but sensitivity is less known because there is a crossover threshold near 4 V that adjusts device characteristics.

### 6.3.6 Sensitivity Temperature Compensation for Magnets

Magnets generally produce weaker fields as temperature increases. The DRV5055-Q1 compensates by increasing sensitivity with temperature, as defined by the parameter  $S_{TC}$ . For device options DRV5055A1 - DRV5055A4, the sensitivity at  $T_A = 150^\circ\text{C}$  is typically 12% higher than at  $T_A = 25^\circ\text{C}$ . For device options DRV5055Z2, the sensitivity at  $T_A = 150^\circ\text{C}$  is typically same as the value at  $T_A = 25^\circ\text{C}$ .

### 6.3.7 Power-On Time

After the  $V_{CC}$  voltage is applied, the DRV5055-Q1 requires a short initialization time before the output is set. The parameter  $t_{ON}$  describes the time from when  $V_{CC}$  crosses 3 V until OUT is within 5% of  $V_Q$ , with 0 mT applied and no load attached to OUT.  6-4 shows this timing diagram.

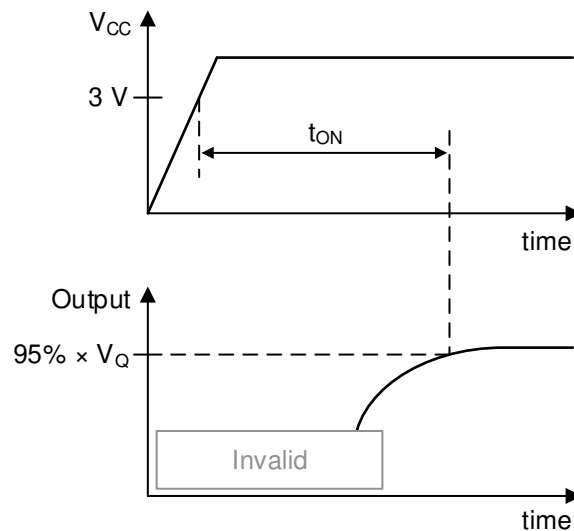

 6-4.  $t_{ON}$  Definition

### 6.3.8 Hall Element Location

Figure 6-5 shows the location of the sensing element inside each package option.

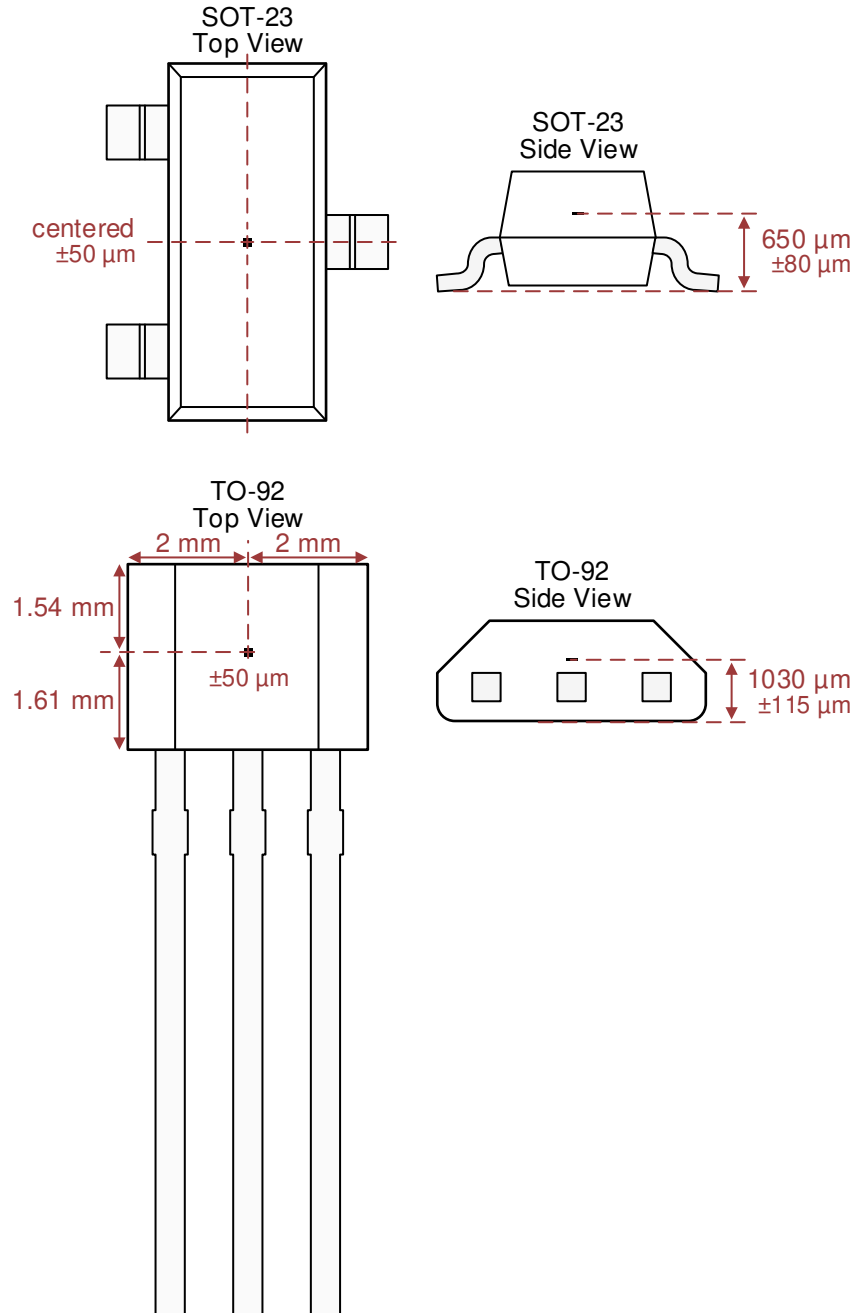

Figure 6-5. Hall Element Location

### 6.4 Device Functional Modes

The DRV5055-Q1 has one mode of operation that applies when the *Recommended Operating Conditions* are met.

## 7 Application and Implementation

### 注

以下のアプリケーション情報は、TI の製品仕様に含まれるものではなく、TI ではその正確性または完全性を保証いたしません。個々の目的に対する製品の適合性については、お客様の責任で判断していただくこととなります。お客様は自身の設計実装を検証しテストすることで、システムの機能を確認する必要があります。

### 7.1 Application Information

#### 7.1.1 Selecting the Sensitivity Option

Select the highest DRV5055-Q1 sensitivity option that can measure the required range of magnetic flux density, so that the output voltage swing is maximized.

Larger-sized magnets and farther sensing distances can generally enable better positional accuracy than very small magnets at close distances, because magnetic flux density increases exponentially with the proximity to a magnet. TI created an online tool to help with simple magnet calculations at <https://www.ti.com/product/drv5013>.

#### 7.1.2 Temperature Compensation for Magnets

The DRV5055-Q1 temperature compensation is designed to directly compensate the average drift of neodymium (NdFeB) magnets and partially compensate ferrite magnets. The residual induction ( $B_r$ ) of a magnet typically reduces by 0.12%/°C for NdFeB, and 0.20%/°C for ferrite. When the operating temperature of a system is reduced, temperature drift errors are also reduced.

#### 7.1.3 Adding a Low-Pass Filter

As shown in *Functional Block Diagram*, an RC low-pass filter can be added to the device output for the purpose of minimizing voltage noise when the full 20-kHz bandwidth is not needed. This filter can improve the signal-to-noise ratio (SNR) and overall accuracy. Do not connect a capacitor directly to the device output without a resistor in between because doing so can make the output unstable.

#### 7.1.4 Designing for Wire Break Detection

Some systems must detect if interconnect wires become open or shorted. The DRV5055-Q1 can support this function.

First, select a sensitivity option that causes the output voltage to stay within the  $V_L$  range during normal operation. Second, add a pullup resistor between OUT and  $V_{CC}$ . TI recommends a value between 20 k $\Omega$  to 100 k $\Omega$ , and the current through OUT must not exceed the  $I_O$  specification, including current going into an external ADC. Then, if the output voltage is ever measured to be within 150 mV of  $V_{CC}$  or GND, a fault condition exists. 図 7-1 shows the circuit, and 表 7-1 describes fault scenarios.



図 7-1. Wire Fault Detection Circuit

**表 7-1. Fault Scenarios and the Resulting  $V_{OUT}$**

FAULT SCENARIO	$V_{OUT}$
$V_{CC}$ disconnects	Close to GND
GND disconnects	Close to $V_{CC}$
$V_{CC}$ shorts to OUT	Close to $V_{CC}$
GND shorts to OUT	Close to GND

## 7.2 Typical Application

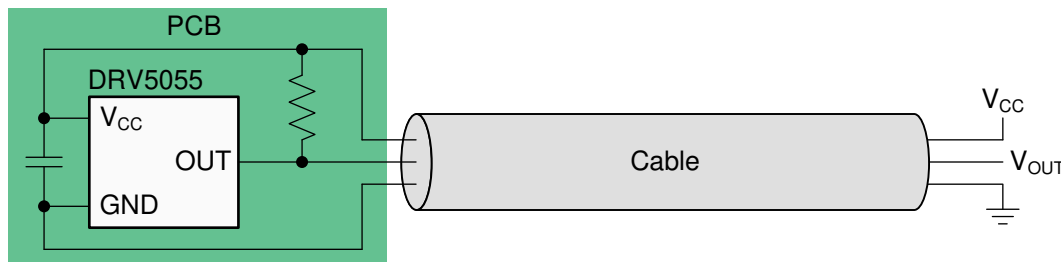
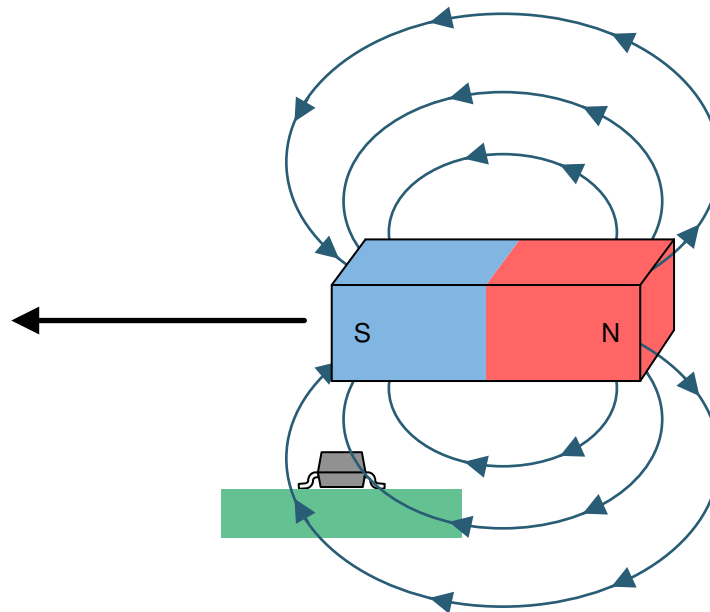

**図 7-2. Common Magnet Orientation**

### 7.2.1 Design Requirements

Use the parameters listed in [表 7-2](#) for this design example.

**表 7-2. Design Parameters**

DESIGN PARAMETER	EXAMPLE VALUE
$V_{CC}$	5 V
Magnet	15 × 5 × 5 mm NdFeB
Travel distance	12 mm
Maximum B at the sensor at 25°C	±75 mT
Device option	DRV5055A3

### 7.2.2 Detailed Design Procedure

Linear Hall effect sensors provide flexibility in mechanical design, because many possible magnet orientations and movements produce a usable response from the sensor. [図 7-2](#) shows one of the most common orientations, which uses the full north to south range of the sensor and causes a close-to-linear change in magnetic flux density as the magnet moves across.

When designing a linear magnetic sensing system, always consider these three variables: the magnet, sensing distance, and the range of the sensor. Select the DRV5055-Q1 with the highest sensitivity that has a  $B_L$  (linear magnetic sensing range) that is larger than the maximum magnetic flux density in the application. To determine



the magnetic flux density the sensor receives, TI recommends using magnetic field simulation software, referring to magnet specifications, and testing.

### 7.2.3 Application Curve

☒ 7-3 shows the simulated magnetic flux from a NdFeB magnet.

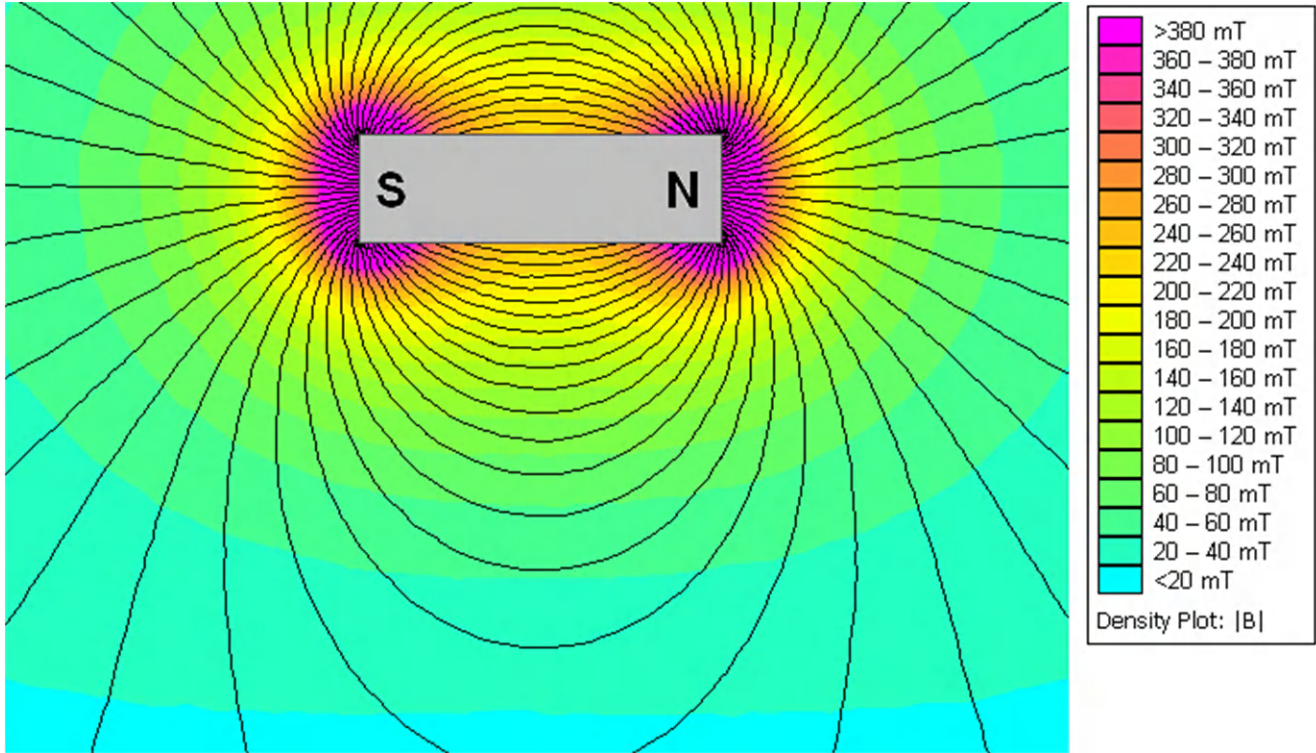

☒ 7-3. Simulated Magnetic Flux

### 7.3 Best Design Practices

The Hall element is sensitive to magnetic fields that are perpendicular to the top of the package, therefore a correct magnet approach must be used for the sensor to detect the field.  7-4 shows correct and incorrect approaches.

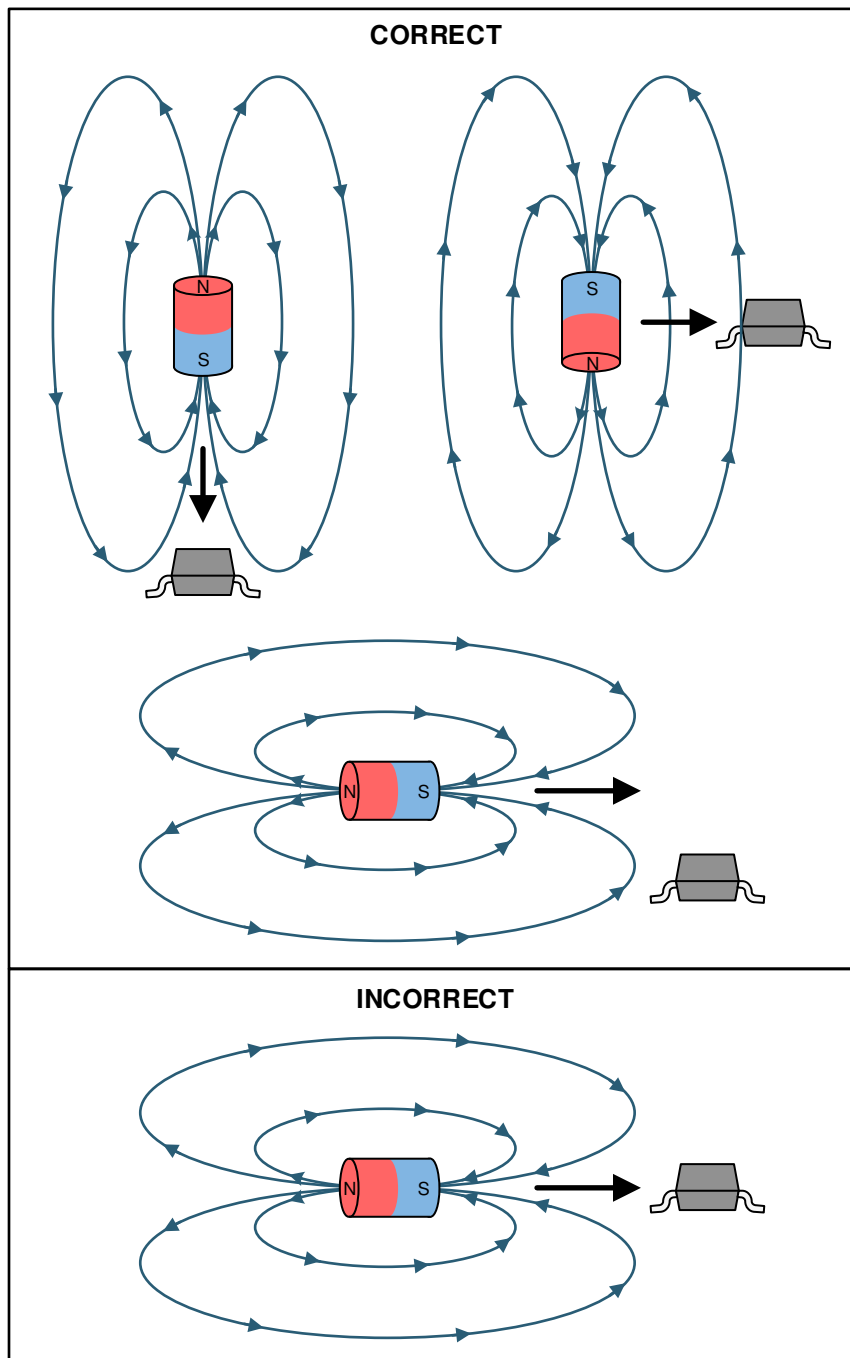

 7-4. Correct and Incorrect Magnet Approaches

## 7.4 Power Supply Recommendations

A decoupling capacitor close to the device must be used to provide local energy with minimal inductance. TI recommends using a ceramic capacitor with a value of at least 0.01  $\mu\text{F}$ .

## 7.5 Layout

### 7.5.1 Layout Guidelines

Magnetic fields pass through most nonferromagnetic materials with no significant disturbance. Embedding Hall effect sensors within plastic or aluminum enclosures and sensing magnets on the outside is common practice. Magnetic fields also easily pass through most printed circuit boards, which makes placing the magnet on the opposite side possible.

### 7.5.2 Layout Examples

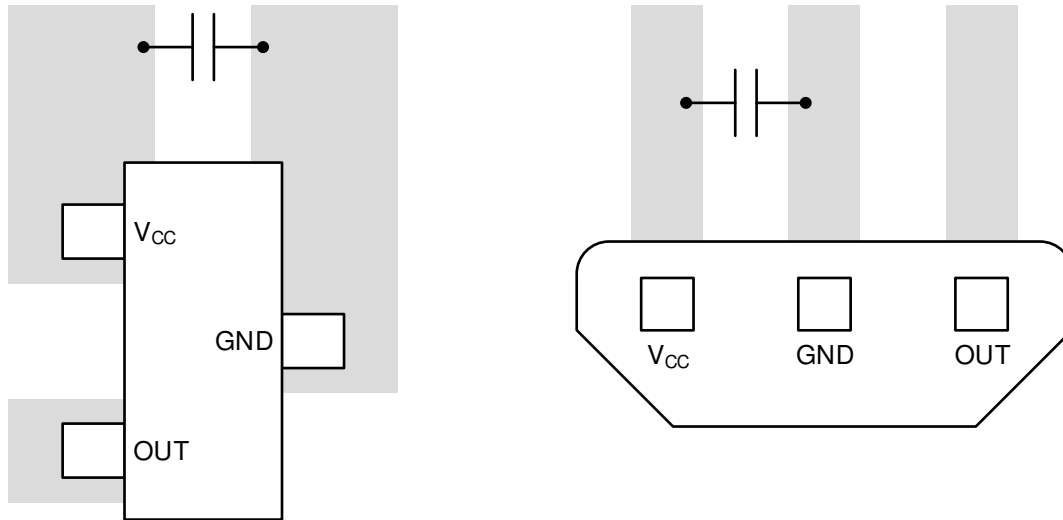

☒ 7-5. Layout Examples

## 8 Device and Documentation Support

### 8.1 Documentation Support

#### 8.1.1 Related Documentation

For related documentation see the following:

- Texas Instruments, [Overview Using Linear Hall Effect Sensors to Measure Angle application brief](#)
- Texas Instruments, [Incremental Rotary Encoder Design Considerations application brief](#)

### 8.2 ドキュメントの更新通知を受け取る方法

ドキュメントの更新についての通知を受け取るには、[www.tij.co.jp](http://www.tij.co.jp) のデバイス製品フォルダを開いてください。[通知] をクリックして登録すると、変更されたすべての製品情報に関するダイジェストを毎週受け取ることができます。変更の詳細については、改訂されたドキュメントに含まれている改訂履歴をご覧ください。

### 8.3 サポート・リソース

テキサス・インスツルメンツ E2E™ サポート・フォーラムは、エンジニアが検証済みの回答と設計に関するヒントをエキスパートから迅速かつ直接得ることができる場所です。既存の回答を検索したり、独自の質問をしたりすることで、設計に必要な支援を迅速に得ることができます。

リンクされているコンテンツは、各寄稿者により「現状のまま」提供されるものです。これらはテキサス・インスツルメンツの仕様を構成するものではなく、必ずしもテキサス・インスツルメンツの見解を反映したものではありません。テキサス・インスツルメンツの[使用条件](#)を参照してください。

### 8.4 Trademarks

テキサス・インスツルメンツ E2E™ is a trademark of Texas Instruments.

すべての商標は、それぞれの所有者に帰属します。

### 8.5 静電気放電に関する注意事項



この IC は、ESD によって破損する可能性があります。テキサス・インスツルメンツは、IC を取り扱う際には常に適切な注意を払うことを推奨します。正しい取り扱いおよび設置手順に従わない場合、デバイスを破損するおそれがあります。

ESD による破損は、わずかな性能低下からデバイスの完全な故障まで多岐にわたります。精密な IC の場合、パラメータがわずかに変化するだけで公表されている仕様から外れる可能性があるため、破損が発生しやすくなっています。

### 8.6 用語集

[テキサス・インスツルメンツ用語集](#) この用語集には、用語や略語の一覧および定義が記載されています。

## 9 Revision History

資料番号末尾の英字は改訂を表しています。その改訂履歴は英語版に準じています。

Changes from Revision C (July 2018) to Revision D (June 2024)	Page
• ドキュメント全体にわたって表、図、相互参照の採番方法を更新.....	1
• 「製品情報」表を「パッケージ情報」に変更 .....	1
• 「概要」で感度オプションの数を 5 つから各種に変更 .....	1
• データシートに Z2 デバイス バリエントを追加.....	1
• Changed <i>Dos and Donts</i> table to <i>Best Design Practices</i> .....	18

Changes from Revision B (January 2018) to Revision C (July 2018)	Page
• 量産用にリリース.....	1

## 10 Mechanical, Packaging, and Orderable Information

The following pages include mechanical, packaging, and orderable information. This information is the most current data available for the designated devices. This data is subject to change without notice and revision of this document. For browser-based versions of this data sheet, refer to the left-hand navigation.

**PACKAGING INFORMATION**

Orderable Device	Status (1)	Package Type	Package Drawing	Pins	Package Qty	Eco Plan (2)	Lead finish/ Ball material (6)	MSL Peak Temp (3)	Op Temp (°C)	Device Marking (4/5)	Samples
DRV5055A1EDBZRQ1	ACTIVE	SOT-23	DBZ	3	3000	RoHS & Green	SN	Level-3-260C-168 HR	-40 to 150	55A1Z	<a href="#">Samples</a>
DRV5055A1ELPGMQ1	ACTIVE	TO-92	LPG	3	3000	RoHS & Green	SN	N / A for Pkg Type	-40 to 150	55A1Z	<a href="#">Samples</a>
DRV5055A1ELPGQ1	ACTIVE	TO-92	LPG	3	1000	RoHS & Green	SN	N / A for Pkg Type	-40 to 150	55A1Z	<a href="#">Samples</a>
DRV5055A2EDBZRQ1	ACTIVE	SOT-23	DBZ	3	3000	RoHS & Green	SN	Level-3-260C-168 HR	-40 to 150	55A2Z	<a href="#">Samples</a>
DRV5055A2ELPGMQ1	ACTIVE	TO-92	LPG	3	3000	RoHS & Green	SN	N / A for Pkg Type	-40 to 150	55A2Z	<a href="#">Samples</a>
DRV5055A2ELPGQ1	ACTIVE	TO-92	LPG	3	1000	RoHS & Green	SN	N / A for Pkg Type	-40 to 150	55A2Z	<a href="#">Samples</a>
DRV5055A3EDBZRQ1	ACTIVE	SOT-23	DBZ	3	3000	RoHS & Green	SN	Level-3-260C-168 HR	-40 to 150	55A3Z	<a href="#">Samples</a>
DRV5055A3ELPGMQ1	ACTIVE	TO-92	LPG	3	3000	RoHS & Green	SN	N / A for Pkg Type	-40 to 150	55A3Z	<a href="#">Samples</a>
DRV5055A3ELPGQ1	ACTIVE	TO-92	LPG	3	1000	RoHS & Green	SN	N / A for Pkg Type	-40 to 150	55A3Z	<a href="#">Samples</a>
DRV5055A4EDBZRQ1	ACTIVE	SOT-23	DBZ	3	3000	RoHS & Green	SN	Level-3-260C-168 HR	-40 to 150	55A4Z	<a href="#">Samples</a>
DRV5055A4ELPGMQ1	ACTIVE	TO-92	LPG	3	3000	RoHS & Green	SN	N / A for Pkg Type	-40 to 150	55A4Z	<a href="#">Samples</a>
DRV5055A4ELPGQ1	ACTIVE	TO-92	LPG	3	1000	RoHS & Green	SN	N / A for Pkg Type	-40 to 150	55A4Z	<a href="#">Samples</a>
DRV5055Z2EDBZRQ1	ACTIVE	SOT-23	DBZ	3	3000	RoHS & Green	SN	Level-1-260C-UNLIM	-40 to 150	55Z2	<a href="#">Samples</a>

(1) The marketing status values are defined as follows:

**ACTIVE:** Product device recommended for new designs.

**LIFEBUY:** TI has announced that the device will be discontinued, and a lifetime-buy period is in effect.

**NRND:** Not recommended for new designs. Device is in production to support existing customers, but TI does not recommend using this part in a new design.

**PREVIEW:** Device has been announced but is not in production. Samples may or may not be available.

**OBSELETE:** TI has discontinued the production of the device.

(2) **RoHS:** TI defines "RoHS" to mean semiconductor products that are compliant with the current EU RoHS requirements for all 10 RoHS substances, including the requirement that RoHS substance do not exceed 0.1% by weight in homogeneous materials. Where designed to be soldered at high temperatures, "RoHS" products are suitable for use in specified lead-free processes. TI may reference these types of products as "Pb-Free".

**RoHS Exempt:** TI defines "RoHS Exempt" to mean products that contain lead but are compliant with EU RoHS pursuant to a specific EU RoHS exemption.

**Green:** TI defines "Green" to mean the content of Chlorine (Cl) and Bromine (Br) based flame retardants meet JS709B low halogen requirements of <=1000ppm threshold. Antimony trioxide based flame retardants must also meet the <=1000ppm threshold requirement.

(3) MSL, Peak Temp. - The Moisture Sensitivity Level rating according to the JEDEC industry standard classifications, and peak solder temperature.

(4) There may be additional marking, which relates to the logo, the lot trace code information, or the environmental category on the device.

(5) Multiple Device Markings will be inside parentheses. Only one Device Marking contained in parentheses and separated by a "~" will appear on a device. If a line is indented then it is a continuation of the previous line and the two combined represent the entire Device Marking for that device.

(6) Lead finish/Ball material - Orderable Devices may have multiple material finish options. Finish options are separated by a vertical ruled line. Lead finish/Ball material values may wrap to two lines if the finish value exceeds the maximum column width.

**Important Information and Disclaimer:**The information provided on this page represents TI's knowledge and belief as of the date that it is provided. TI bases its knowledge and belief on information provided by third parties, and makes no representation or warranty as to the accuracy of such information. Efforts are underway to better integrate information from third parties. TI has taken and continues to take reasonable steps to provide representative and accurate information but may not have conducted destructive testing or chemical analysis on incoming materials and chemicals. TI and TI suppliers consider certain information to be proprietary, and thus CAS numbers and other limited information may not be available for release.

In no event shall TI's liability arising out of such information exceed the total purchase price of the TI part(s) at issue in this document sold by TI to Customer on an annual basis.

**OTHER QUALIFIED VERSIONS OF DRV5055-Q1 :**

- Catalog : [DRV5055](#)

NOTE: Qualified Version Definitions:

- Catalog - TI's standard catalog product

## TAPE AND REEL INFORMATION



### QUADRANT ASSIGNMENTS FOR PIN 1 ORIENTATION IN TAPE



\*All dimensions are nominal

Device	Package Type	Package Drawing	Pins	SPQ	Reel Diameter (mm)	Reel Width W1 (mm)	A0 (mm)	B0 (mm)	K0 (mm)	P1 (mm)	W (mm)	Pin1 Quadrant
DRV5055A1EDBZRQ1	SOT-23	DBZ	3	3000	180.0	8.4	3.15	2.77	1.22	4.0	8.0	Q3
DRV5055A2EDBZRQ1	SOT-23	DBZ	3	3000	180.0	8.4	3.15	2.77	1.22	4.0	8.0	Q3
DRV5055A3EDBZRQ1	SOT-23	DBZ	3	3000	180.0	8.4	3.15	2.77	1.22	4.0	8.0	Q3
DRV5055A4EDBZRQ1	SOT-23	DBZ	3	3000	180.0	8.4	3.15	2.77	1.22	4.0	8.0	Q3
DRV5055Z2EDBZRQ1	SOT-23	DBZ	3	3000	180.0	8.4	3.2	2.85	1.3	4.0	8.0	Q3



**TAPE AND REEL BOX DIMENSIONS**

\*All dimensions are nominal

Device	Package Type	Package Drawing	Pins	SPQ	Length (mm)	Width (mm)	Height (mm)
DRV5055A1EDBZRQ1	SOT-23	DBZ	3	3000	213.0	191.0	35.0
DRV5055A2EDBZRQ1	SOT-23	DBZ	3	3000	213.0	191.0	35.0
DRV5055A3EDBZRQ1	SOT-23	DBZ	3	3000	213.0	191.0	35.0
DRV5055A4EDBZRQ1	SOT-23	DBZ	3	3000	213.0	191.0	35.0
DRV5055Z2EDBZRQ1	SOT-23	DBZ	3	3000	210.0	185.0	35.0

# DBZ0003A



# PACKAGE OUTLINE

## SOT-23 - 1.12 mm max height

SMALL OUTLINE TRANSISTOR

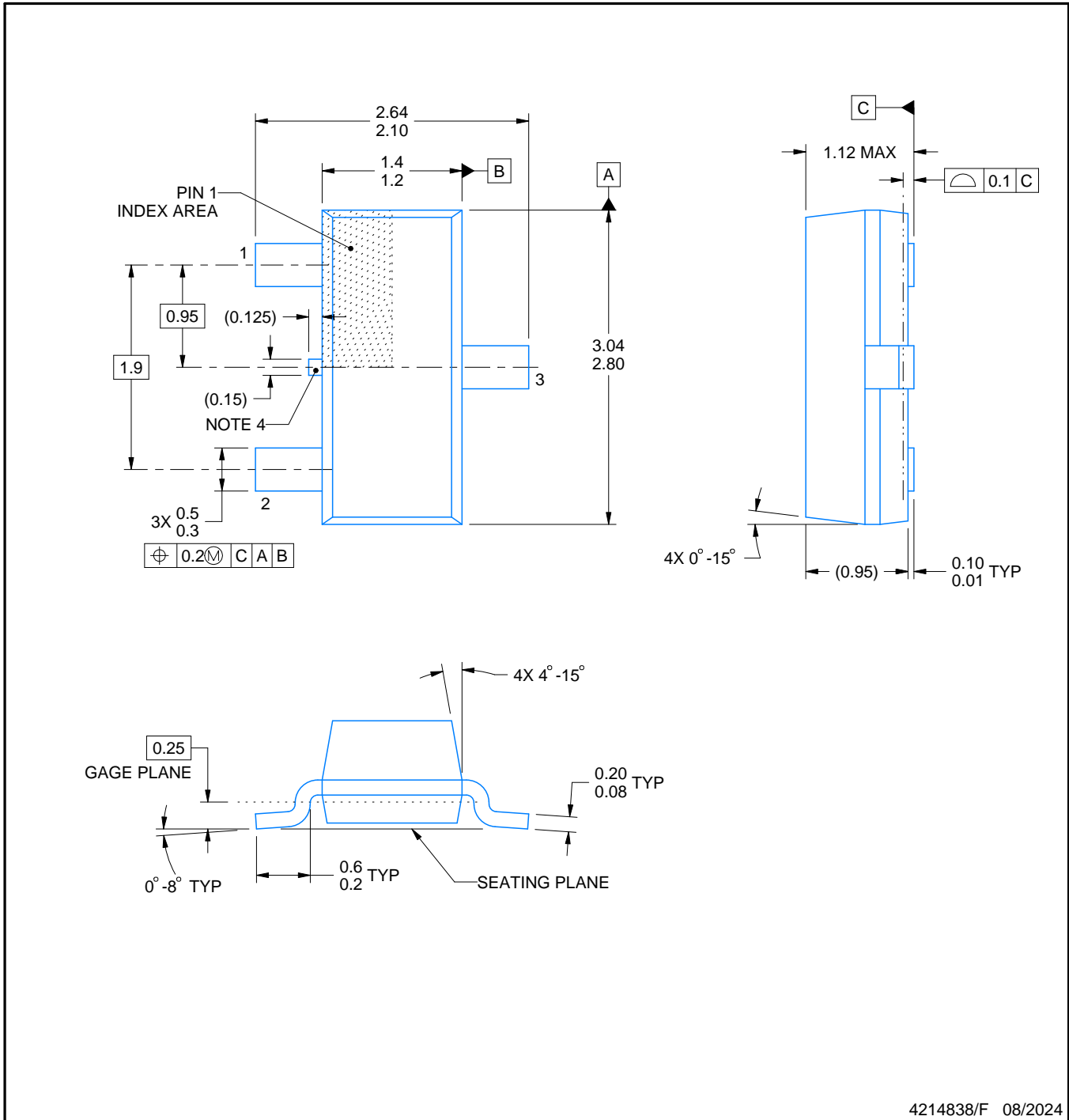

4214838/F 08/2024

### NOTES:

1. All linear dimensions are in millimeters. Any dimensions in parenthesis are for reference only. Dimensioning and tolerancing per ASME Y14.5M.
2. This drawing is subject to change without notice.
3. Reference JEDEC registration TO-236, except minimum foot length.
4. Support pin may differ or may not be present.
5. Body dimensions do not include mold flash, protrusions, or gate burrs. Mold flash, protrusions, or gate burrs shall not exceed 0.25mm per side

# EXAMPLE BOARD LAYOUT

DBZ0003A

SOT-23 - 1.12 mm max height

SMALL OUTLINE TRANSISTOR



LAND PATTERN EXAMPLE  
SCALE:15X



SOLDER MASK DETAILS

4214838/F 08/2024

NOTES: (continued)

5. Publication IPC-7351 may have alternate designs.
6. Solder mask tolerances between and around signal pads can vary based on board fabrication site.

# EXAMPLE STENCIL DESIGN

DBZ0003A

SOT-23 - 1.12 mm max height

SMALL OUTLINE TRANSISTOR



SOLDER PASTE EXAMPLE  
BASED ON 0.125 THICK STENCIL  
SCALE:15X

4214838/F 08/2024

NOTES: (continued)

7. Laser cutting apertures with trapezoidal walls and rounded corners may offer better paste release. IPC-7525 may have alternate design recommendations.
8. Board assembly site may have different recommendations for stencil design.

# LPG0003A



# PACKAGE OUTLINE

## TO-92 - 5.05 mm max height

TRANSISTOR OUTLINE



4221343/C 01/2018

### NOTES:

1. All linear dimensions are in millimeters. Any dimensions in parenthesis are for reference only. Dimensioning and tolerancing per ASME Y14.5M.
2. This drawing is subject to change without notice.

# EXAMPLE BOARD LAYOUT

LPG0003A

TO-92 - 5.05 mm max height

TRANSISTOR OUTLINE



LAND PATTERN EXAMPLE  
NON-SOLDER MASK DEFINED  
SCALE:20X

4221343/C 01/2018

# TAPE SPECIFICATIONS

LPG0003A

TO-92 - 5.05 mm max height

TRANSISTOR OUTLINE



## 重要なお知らせと免責事項

TI は、技術データと信頼性データ (データシートを含みます)、設計リソース (リファレンス・デザインを含みます)、アプリケーションや設計に関する各種アドバイス、Web ツール、安全性情報、その他のリソースを、欠陥が存在する可能性のある「現状のまま」提供しており、商品性および特定目的に対する適合性の黙示保証、第三者の知的財産権の非侵害保証を含むいかなる保証も、明示的または黙示的にかかわらず拒否します。

これらのリソースは、TI 製品を使用する設計の経験を積んだ開発者への提供を意図したものです。(1) お客様のアプリケーションに適した TI 製品の選定、(2) お客様のアプリケーションの設計、検証、試験、(3) お客様のアプリケーションに該当する各種規格や、その他のあらゆる安全性、セキュリティ、規制、または他の要件への確実な適合に関する責任を、お客様のみが単独で負うものとし、

上記の各種リソースは、予告なく変更される可能性があります。これらのリソースは、リソースで説明されている TI 製品を使用するアプリケーションの開発の目的でのみ、TI はその使用をお客様に許諾します。これらのリソースに関して、他の目的で複製することや掲載することは禁止されています。TI や第三者の知的財産権のライセンスが付与されている訳ではありません。お客様は、これらのリソースを自身で使用した結果発生するあらゆる申し立て、損害、費用、損失、責任について、TI およびその代理人を完全に補償するものとし、TI は一切の責任を拒否します。

TI の製品は、[TI の販売条件](#)、または [ti.com](#) やかかる TI 製品の関連資料などのいずれかを通じて提供する適用可能な条項の下で提供されています。TI がこれらのリソースを提供することは、適用される TI の保証または他の保証の放棄の拡大や変更を意味するものではありません。

お客様がいかなる追加条項または代替条項を提案した場合でも、TI はそれらに異議を唱え、拒否します。

郵送先住所 : Texas Instruments, Post Office Box 655303, Dallas, Texas 75265  
Copyright © 2024, Texas Instruments Incorporated