

INA310x -4V~110V、1.3MHz、超高精度電流センス・アンプ、オープン・ドレイン・コンパレータおよび基準電圧付き

1 特長

- 広いコモン・モード電圧範囲:
 - 動作電圧: -4V~+110V
 - 残存電圧: -20V~+120V
- 高い信号帯域幅: 1.3MHz
- スルーレート: 2.5V/μs
- 非常に優れた CMRR: 160dB
- 精度
 - ゲイン誤差 (最大値)
 - バージョン A: 0.15%、10ppm/°Cのドリフト
 - バージョン B: 0.5%、20ppm/°Cのドリフト
 - オフセット電圧 (最大値)
 - バージョン A: ±20μV、±0.25μV/°Cのドリフト
 - バージョン B: ±150μV、±1μV/°Cのドリフト
- オンボードのオープン・ドレイン・コンパレータ
- 内部のコンパレータ基準電圧: 0.6V
- 伝搬遅延時間: 1μs
- コンパレータのラッチ機能
- 利用可能なゲイン:
 - INA310A1, INA310B1: 20V/V
 - INA310A2, INA310B2: 50V/V
 - INA310A3, INA310B3: 100V/V
 - INA310A4, INA310B4: 200V/V
 - INA310A5, INA310B5: 500V/V
- パッケージ・オプション: VSSOP-8

2 アプリケーション

- 48V DC/DC コンバータ
- 48V バッテリ管理システム (BMS)
- 試験および測定機器
- マクロ・リモート無線ユニット (RRU)
- 48V ラック・サーバー
- 48V 商用ネットワーク / サーバー電源 (PSU)
- ソレノイドとアクチュエータ

3 概要

INA310x は、電源電圧に関係なく内蔵のコンパレータにより、-4V~110V の広い同相電圧範囲にわたってシャント抵抗両端での電圧降下を測定できる超高精度の電流センス・アンプです。低いオフセット電圧 (最大値 20μV)、小さいゲイン誤差 (最大値 0.15%)、高い DC CMRR (代表値 160dB) の組み合わせにより、高精度の電流測定が可能です。INA310x は、高電圧 DC 電流測定や、高速過電流保護などの高速アプリケーション向けに設計された、1.3MHz の高い信号帯域幅を備えています。

また、INA310x にはオープン・ドレインのコンパレータと内部基準電圧が組み込まれており、0.6V のスレッシュホールドを実現します。外付けの抵抗分圧器により、電流トリップ・ポイントが設定されます。コンパレータにはラッチ機能があり、RESET ピンをグラウンドに接続 (またはオープンに保持) することで透過的にできます。

INA310x は 2.7V~20V 単電源で動作し、消費電流は 1.6mA です。INA310x には次の 5 種類のゲイン・オプションが提供されています: 20V/V、50V/V、100V/V、200V/V、500V/V。これらのゲインを選択できるため、ダイナミック・レンジの広い電流センシング・アプリケーションに対応できます。

INA310x は、-40°C~+125°Cの動作温度範囲が規定されており、省スペースの 8 ピン VSSOP パッケージで供給されます。

パッケージ情報⁽¹⁾

部品番号	パッケージ	本体サイズ (公称)
INA310A	VSSOP (8)	3.00mm × 3.00mm
INA310B		

- (1) 利用可能なパッケージについては、データシートの末尾にあるパッケージ・オプションについての付録を参照してください。

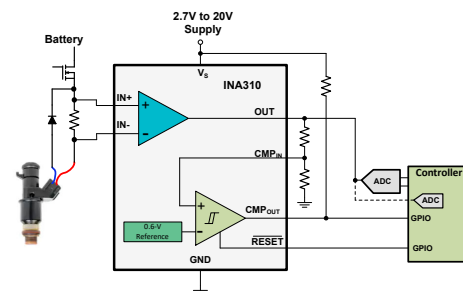

代表的なアプリケーション



Table of Contents

1 特長.....	1	7.3 Feature Description.....	14
2 アプリケーション.....	1	7.4 Device Functional Modes.....	17
3 概要.....	1	8 Application and Implementation.....	21
4 Revision History.....	2	8.1 Application Information.....	21
5 Pin Configuration and Functions.....	3	8.2 Typical Application.....	22
6 Specifications.....	4	8.3 Power Supply Recommendations.....	25
6.1 Absolute Maximum Ratings.....	4	8.4 Layout.....	26
6.2 ESD Ratings.....	4	9 Device and Documentation Support.....	27
6.3 Recommended Operating Conditions.....	4	9.1 Receiving Notification of Documentation Updates....	27
6.4 Thermal Information.....	4	9.2 サポート・リソース.....	27
6.5 Electrical Characteristics.....	5	9.3 Trademarks.....	27
6.6 Typical Characteristics.....	7	9.4 静電気放電に関する注意事項.....	27
7 Detailed Description.....	14	9.5 用語集.....	27
7.1 Overview.....	14	10 Mechanical, Packaging, and Orderable	
7.2 Functional Block Diagram.....	14	Information.....	27

4 Revision History

DATE	REVISION	NOTES
March 2023	*	Initial release

5 Pin Configuration and Functions



図 5-1. INA310x: DKG Package 8-Pin VSSOP Top View

表 5-1. Pin Functions

PIN		TYPE	DESCRIPTION
NAME	NO		
V _S	1	Power	Power supply, 2.7 V to 20 V
OUT	2	Output	Output voltage
CMP _{IN}	3	Input	Comparator input
GND	4	Ground	Ground
RESET	5	Input	Comparator reset pin, active low (Low: Transparent Mode, High: Latch Mode)
CMP _{OUT}	6	Output	Comparator output (latch high when $\overline{\text{RESET}} = \text{High}$)
IN ₋	7	Input	Shunt resistor negative sense input. For high-side applications, connect to load side of sense resistor. For low-side applications, connect to ground side of sense resistor.
IN ₊	8	Input	Shunt resistor positive sense input. For high-side applications, connect to bus-voltage side of sense resistor. For low-side applications, connect to load side of sense resistor.

6 Specifications

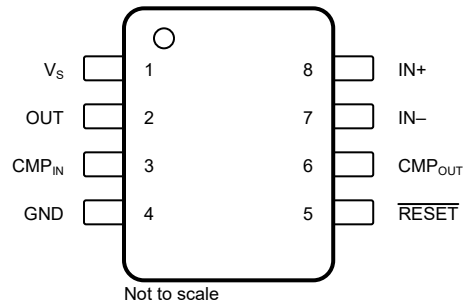
6.1 Absolute Maximum Ratings

over operating free-air temperature range (unless otherwise noted)⁽¹⁾

		MIN	MAX	UNIT	
V _S	Supply voltage	-0.3	22	V	
V _{IN+} , V _{IN-}	Analog inputs	Differential (V _{IN+}) – (V _{IN-}) ⁽²⁾	-12	12	V
		V _{IN+} , V _{IN-} , with respect to GND ⁽²⁾	-20	120	
V _{OUT}	Analog output	GND – 0.3	(V _S) + 0.3	V	
	Comparator reset pin	GND – 0.3	(V _S) + 0.3	V	
	Comparator analog input	GND – 0.3	MIN of 5.5 or V _S	V	
	Comparator Output	GND – 0.3	22	V	
	Input current into any pin		5	mA	
T _A	Operating temperature	-55	150	°C	
T _J	Junction temperature	-65	150	°C	
T _{stg}	Storage temperature	-65	150	°C	

- Operation outside the Absolute Maximum Ratings may cause permanent device damage. Absolute Maximum Ratings do not imply functional operation of the device at these or any other conditions beyond those listed under Recommended Operating Conditions. If used outside the Recommended Operating Conditions but within the Absolute Maximum Ratings, the device may not be fully functional, and this may affect device reliability, functionality, performance, and shorten the device lifetime.
- V_{IN+} and V_{IN-} are the voltages at the IN+ and IN- pins, respectively.

6.2 ESD Ratings

			VALUE	UNIT
V _(ESD)	Electrostatic discharge	Human body model (HBM), per ANSI/ESDA/ JEDEC JS-001, all pins ⁽¹⁾	±2000	V
		Charged device model (CDM), per ANSI/ESDA/JEDEC JS-002, all pins ⁽²⁾	±1000	

- JEDEC document JEP155 states that 500-V HBM allows safe manufacturing with a standard ESD control process.
- JEDEC document JEP157 states that 250-V CDM allows safe manufacturing with a standard ESD control process.

6.3 Recommended Operating Conditions

over operating free-air temperature range (unless otherwise noted)

		MIN	NOM	MAX	UNIT
V _{CM}	Common-mode input range	-4	48	110	V
V _S	Operating supply voltage	2.7	5	20	V
V _{SENSE}	Differential sense input range	0		V _S / G	V
T _A	Operating free-air temperature	-40		125	°C

6.4 Thermal Information

THERMAL METRIC ⁽¹⁾		INA310x	UNIT
		DGK (VSSOP)	
		8 PINS	
R _{θJA}	Junction-to-ambient thermal resistance	172.2	°C/W
R _{θJC(top)}	Junction-to-case (top) thermal resistance	63.5	°C/W
R _{θJB}	Junction-to-board thermal resistance	93.8	°C/W
Ψ _{JT}	Junction-to-top characterization parameter	9.8	°C/W
Ψ _{JB}	Junction-to-board characterization parameter	92.2	°C/W

- For more information about traditional and new thermal metrics, see the [Semiconductor and IC Package Thermal Metrics](#) application report.

6.5 Electrical Characteristics

at $T_A = 25^\circ\text{C}$, $V_{\text{SENSE}} = V_{\text{IN}+} - V_{\text{IN}-} = 0.5\text{ V}$ / Gain, $V_S = 5.0\text{ V}$, $V_{\text{CM}} = V_{\text{IN}-} = 48\text{ V}$, and $R_{\text{PULLUP}} = 5.1\text{ k}\Omega$ connected from CMP_{out} to V_S , (unless otherwise noted)

PARAMETER		CONDITIONS	MIN	TYP	MAX	UNIT
INPUT						
V_{CM}	Common-mode input range	$T_A = -40^\circ\text{C}$ to $+125^\circ\text{C}$	-4		110	V
CMRR	Common-mode rejection ratio	INA310Ax, $V_{\text{IN}+} = -4\text{ V}$ to 110 V , $T_A = -40^\circ\text{C}$ to $+125^\circ\text{C}$	140	160		dB
		INA310Ax, $f = 50\text{ kHz}$		85		
		INA310Bx, $V_{\text{IN}+} = -4\text{ V}$ to 110 V , $T_A = -40^\circ\text{C}$ to $+125^\circ\text{C}$	120	140		
		INA310Bx, $f = 50\text{ kHz}$		65		
V_{OS}	Offset voltage, RTI ⁽¹⁾	INA310A1		± 30	± 150	μV
		INA310B1		± 100	± 500	
		INA310A2		± 15	± 80	
		INA310B2		± 55	± 300	
		INA310A3		± 10	± 50	
		INA310B3		± 30	± 250	
		INA310A4		± 5	± 30	
		INA310B4		± 30	± 200	
		INA310A5		± 2	± 20	
dV_{OS}/dT	Offset drift, RTI	$T_A = -40^\circ\text{C}$ to $+125^\circ\text{C}$, INA310A1, INA310A2, INA310A3		± 0.05	± 0.5	$\mu\text{V}/^\circ\text{C}$
		$T_A = -40^\circ\text{C}$ to $+125^\circ\text{C}$, INA310A4, INA310A5		± 0.025	± 0.25	
		$T_A = -40^\circ\text{C}$ to $+125^\circ\text{C}$, INA310Bx		± 0.1	± 1	
PSRR	Power-supply rejection ratio, RTI	INA310A1, $2.7\text{ V} \leq V_S \leq 20\text{ V}$, $T_A = -40^\circ\text{C}$ to $+125^\circ\text{C}$		± 1	± 8	$\mu\text{V}/\text{V}$
		INA310A2, INA310A3, $2.7\text{ V} \leq V_S \leq 20\text{ V}$, $T_A = -40^\circ\text{C}$ to $+125^\circ\text{C}$		± 0.3	± 3	
		INA310A4, INA310A5, $2.7\text{ V} \leq V_S \leq 20\text{ V}$, $T_A = -40^\circ\text{C}$ to $+125^\circ\text{C}$		± 0.1	± 1	
		INA310Bx $2.7\text{ V} \leq V_S \leq 20\text{ V}$, $T_A = -40^\circ\text{C}$ to $+125^\circ\text{C}$		± 1.5	± 10	
I_B	Input bias current	I_{B+} , I_{B-} , $V_{\text{SENSE}} = 0\text{ mV}$	10	20	30	μA
OUTPUT						
G	Gain	INA310A1, INA310B1		20		V/V
		INA310A2, INA310B2		50		
		INA310A3, INA310B3		100		
		INA310A4, INA310B4		200		
		INA310A5, INA310B5		500		
G_{ERR}	Gain error	INA310Ax, $\text{GND} + 50\text{ mV} \leq V_{\text{OUT}} \leq V_S - 200\text{ mV}$		$\pm 0.02\%$	$\pm 0.15\%$	ppm/ $^\circ\text{C}$
		INA310Bx, $\text{GND} + 50\text{ mV} \leq V_{\text{OUT}} \leq V_S - 200\text{ mV}$		$\pm 0.07\%$	$\pm 0.5\%$	
		INA310Ax, $T_A = -40^\circ\text{C}$ to $+125^\circ\text{C}$		1	10	
		INA310Bx, $T_A = -40^\circ\text{C}$ to $+125^\circ\text{C}$		2	20	
NL_{ERR}	Nonlinearity error	$\text{GND} + 50\text{ mV} \leq V_{\text{OUT}} \leq V_S - 200\text{ mV}$		± 0.01		%
	Maximum capacitive load	No sustained oscillation, no isolation resistor		500		pF
VOLTAGE OUTPUT						
V_{SP}	Swing to V_S (Power-supply rail)	$R_{\text{LOAD}} = 10\text{ k}\Omega$ to GND, $T_A = -40^\circ\text{C}$ to $+125^\circ\text{C}$		$(V_S) - 70$	$(V_S) - 150$	mV
V_{SN}	Swing to GND	$R_{\text{LOAD}} = 10\text{ k}\Omega$ to GND, $T_A = -40^\circ\text{C}$ to $+125^\circ\text{C}$, $V_{\text{SENSE}} = 0\text{ mV}$		$(V_{\text{GND}}) + 5$	$(V_{\text{GND}}) + 20$	mV

at $T_A = 25^\circ\text{C}$, $V_{\text{SENSE}} = V_{\text{IN}+} - V_{\text{IN}-} = 0.5\text{ V}$ / Gain, $V_S = 5.0\text{ V}$, $V_{\text{CM}} = V_{\text{IN}-} = 48\text{ V}$, and $R_{\text{PULLUP}} = 5.1\text{ k}\Omega$ connected from CMP_{out} to V_S , (unless otherwise noted)

PARAMETER		CONDITIONS	MIN	TYP	MAX	UNIT
FREQUENCY RESPONSE						
BW	Bandwidth	INA310A1, INA310B1, $C_{\text{LOAD}} = 5\text{ pF}$, $V_{\text{SENSE}} = 200\text{mV}$		1300		kHz
		INA310A2, INA310B2, $C_{\text{LOAD}} = 5\text{ pF}$, $V_{\text{SENSE}} = 80\text{mV}$		1300		
		INA310A3, INA310B3, $C_{\text{LOAD}} = 5\text{ pF}$, $V_{\text{SENSE}} = 40\text{mV}$		1000		
		INA310A4, INA310B4, $C_{\text{LOAD}} = 5\text{ pF}$, $V_{\text{SENSE}} = 20\text{mV}$		900		
		INA310A5, INA310B5, $C_{\text{LOAD}} = 5\text{ pF}$, $V_{\text{SENSE}} = 8\text{mV}$		900		
SR	Slew rate	Rising edge		2.5		V/ μs
t_s	Settling time	$V_{\text{OUT}} = 4\text{ V} \pm 0.1\text{ V}$ step, Output settles to 0.5%		10		μs
		$V_{\text{OUT}} = 4\text{ V} \pm 0.1\text{ V}$ step, Output settles to 1%		5		μs
		$V_{\text{OUT}} = 4\text{ V} \pm 0.1\text{ V}$ step, Output settles to 5%		1		μs
NOISE						
V_{en}	Voltage noise density			50		nV/ $\sqrt{\text{Hz}}$
COMPARATOR						
$V_{\text{THRESHOLD}}$	Alert threshold	$T_A = 25^\circ\text{C}$	585	600	615	mV
		$T_A = -40^\circ\text{C}$ to $+125^\circ\text{C}$	580		620	mV
	Hysteresis	$T_A = 25^\circ\text{C}$		8		mV
t_p	Small-signal propagation delay	Comparator input overdrive = 20 mV		1		μs
	Slew-rate-limited propagation delay	V_{OUT} step = 0.5 V to 4.5 V, $V_{\text{LIMIT}}^{(3)} = 4\text{ V}$		1.6		μs
I_{BCMPIN}	Input bias current, CMP_{in} PIN	$T_A = 25^\circ\text{C}$, $V_{\text{CMPIN}} = 0.4\text{ V}$ to 1.2 V	-20	1	20	nA
		$T_A = -40^\circ\text{C}$ to $+125^\circ\text{C}$, $V_{\text{CMPIN}} = 0.4\text{ V}$ to 1.2 V			250	nA
I_{LKG}	High-level leakage current	$V_{\text{CMPout}} = V_S$			1	μA
V_{OL}	Low-level output voltage	$I_{\text{OL}} = 2.35\text{ mA}$			300	mV
		$T_A = -40^\circ\text{C}$ to $+125^\circ\text{C}$, $I_{\text{OL}} = 2.35\text{ mA}$			350	mV
V_{IH}	RESET High-level input voltage threshold (2)	$T_A = -40^\circ\text{C}$ to $+125^\circ\text{C}$	1.2			V
V_{IL}	RESET Low-level input voltage threshold (2)	$T_A = -40^\circ\text{C}$ to $+125^\circ\text{C}$			0.4	V
	Minimum RESET pulse width	$T_A = -40^\circ\text{C}$ to $+125^\circ\text{C}$		100	200	ns
	RESET propagation delay			250		ns
POWER SUPPLY						
V_S	Supply voltage range	$T_A = -40^\circ\text{C}$ to $+125^\circ\text{C}$	2.7		20	V
I_Q	Quiescent current			1.6	2	mA
		$T_A = -40^\circ\text{C}$ to $+125^\circ\text{C}$			2.25	mA

- (1) RTI = referred-to-input.
- (2) The RESET input has an internal 2 M Ω (typical) pull-down. Leaving RESET open results in a LOW state, with transparent comparator operation.
- (3) V_{LIMIT} is V_{OUT} at the overcurrent threshold set by external resistors.

6.6 Typical Characteristics

at $T_A = 25^\circ\text{C}$, $V_S = 5\text{ V}$, $V_{\text{SENSE}} = V_{\text{IN}+} - V_{\text{IN}-} = 0.5\text{ V} / \text{Gain}$, $V_{\text{CM}} = V_{\text{IN}-} = 48\text{ V}$, and $R_{\text{PULLUP}} = 5.1\text{ k}\Omega$ (unless otherwise noted).

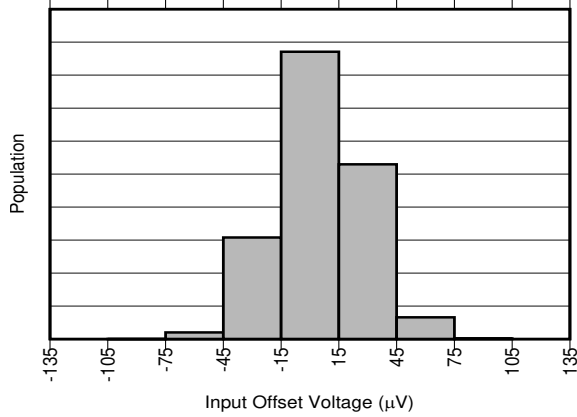

6-1. INA310A1 Input Offset Production Distribution

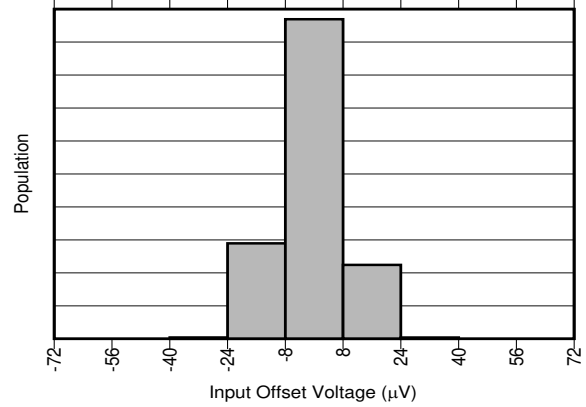

6-2. INA310A2 Input Offset Production Distribution

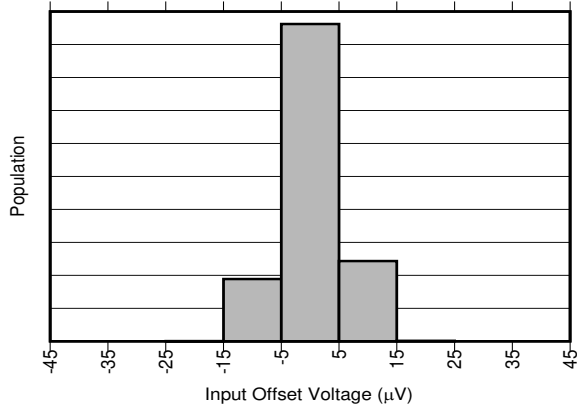

6-3. INA310A3 Input Offset Production Distribution

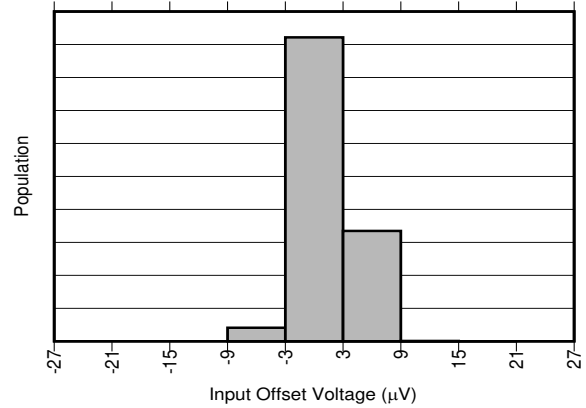

6-4. INA310A4 Input Offset Production Distribution

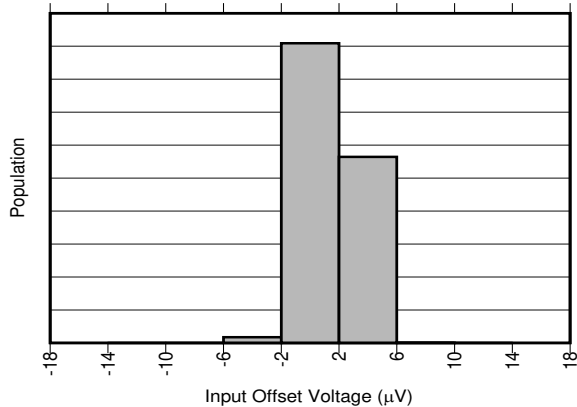

6-5. INA310A5 Input Offset Production Distribution

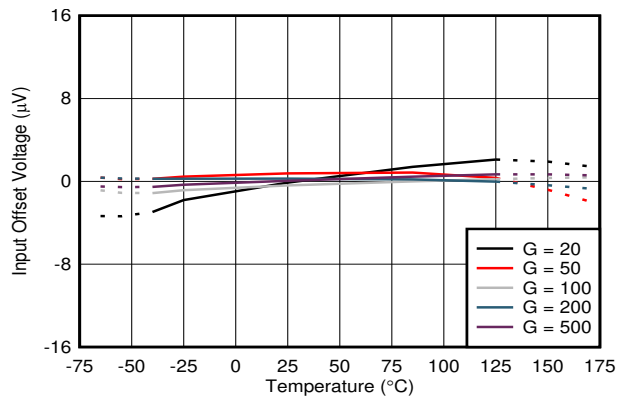

6-6. Input Offset Voltage vs Temperature

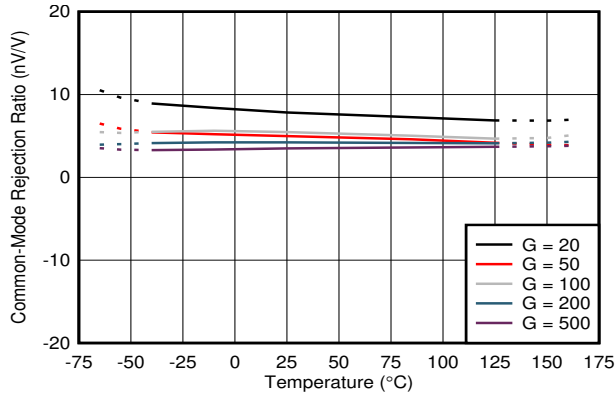

6-7. Common-Mode Rejection Ratio vs Temperature

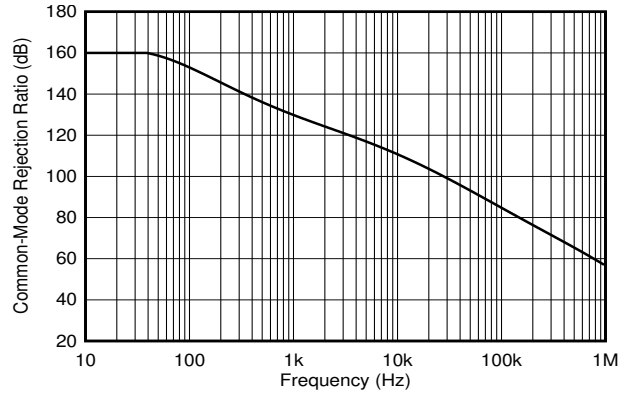

6-8. Common-Mode Rejection Ratio vs Frequency

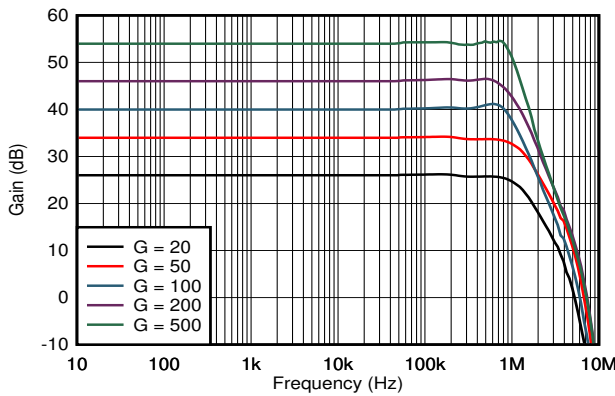

6-9. Gain vs Frequency

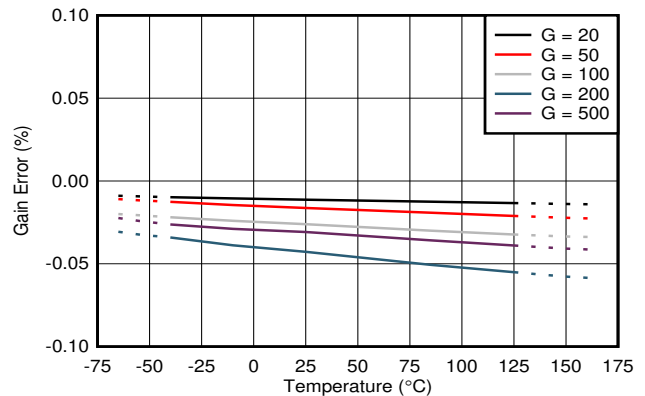

6-10. INA310A Gain Error vs Temperature

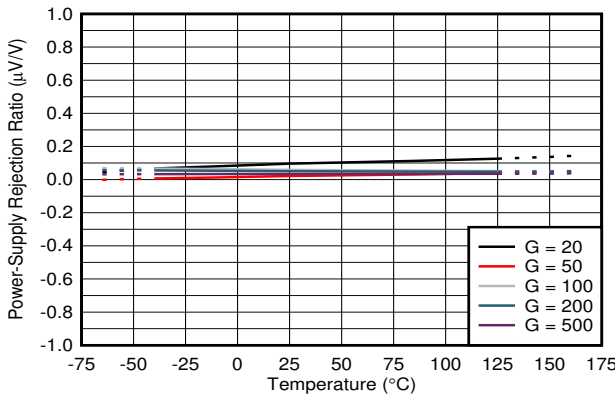

6-11. Power-Supply Rejection Ratio vs Temperature

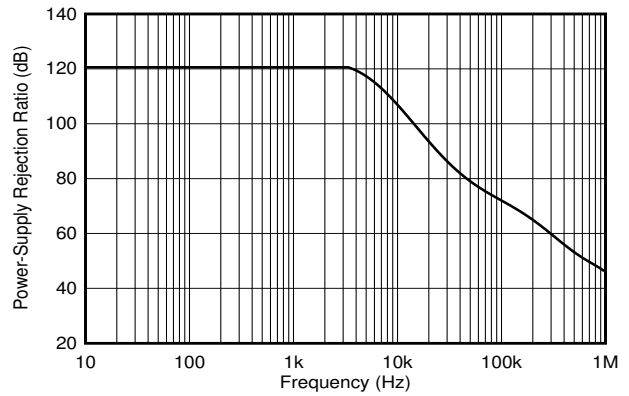

6-12. Power-Supply Rejection Ratio vs Frequency

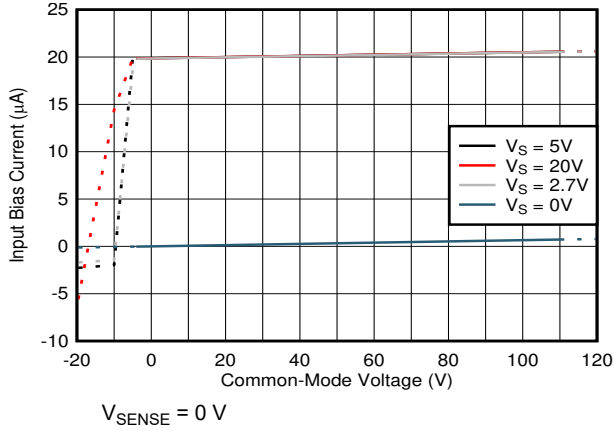

6-13. Input Bias Current vs Common-Mode Voltage

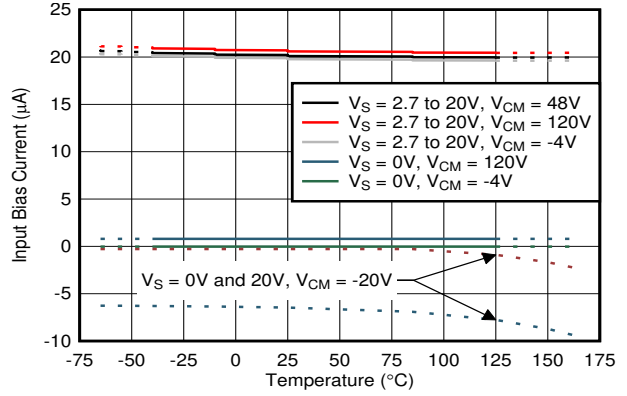

6-14. Input Bias Current vs Temperature

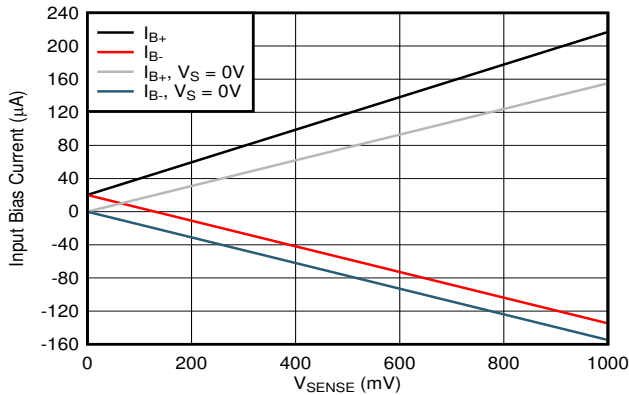

6-15. INA310x1 Input Bias Current vs V_{SENSE}

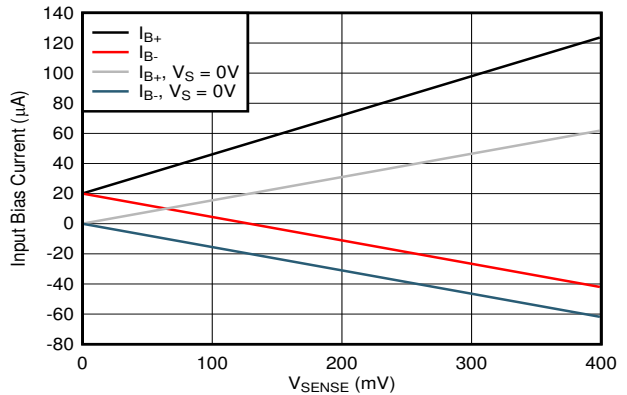

6-16. INA310x2, INA310x3 Input Bias Current vs V_{SENSE}

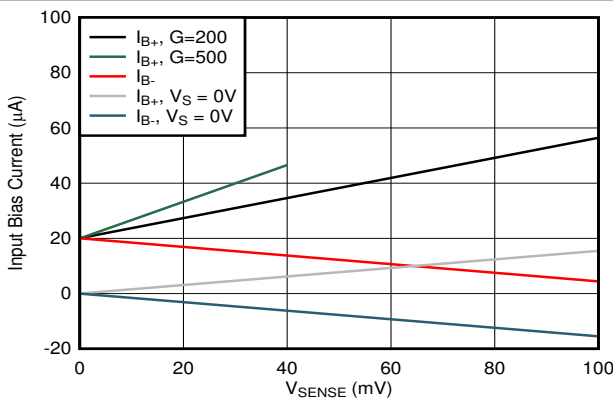

6-17. INA310x4, INA310x5 Input Bias Current vs V_{SENSE}

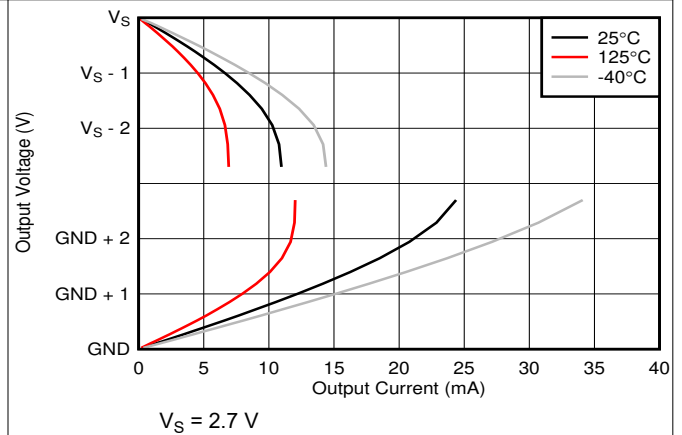

6-18. Output Voltage vs Output Current

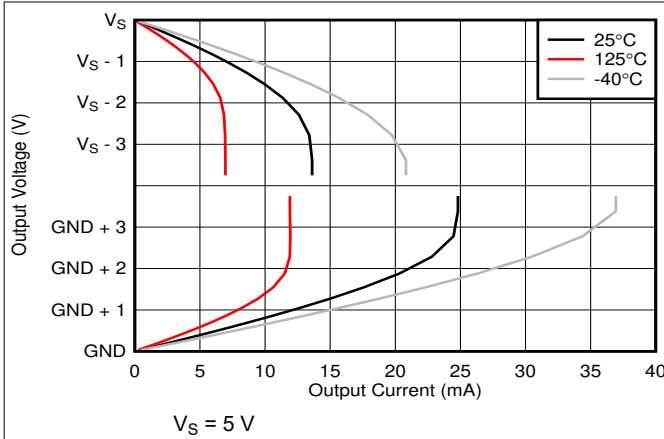

6-19. Output Voltage vs Output Current

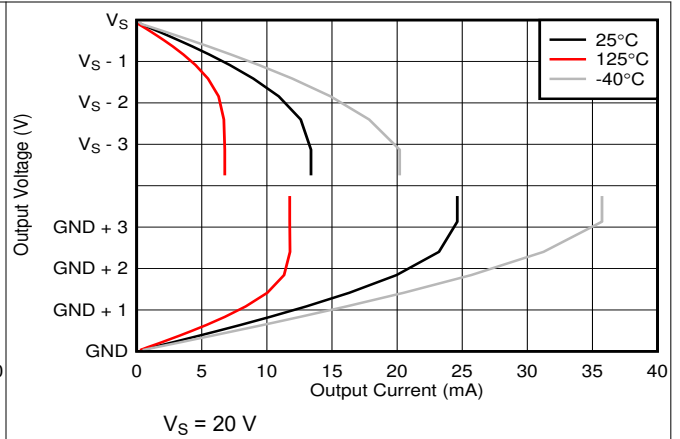

6-20. Output Voltage vs Output Current

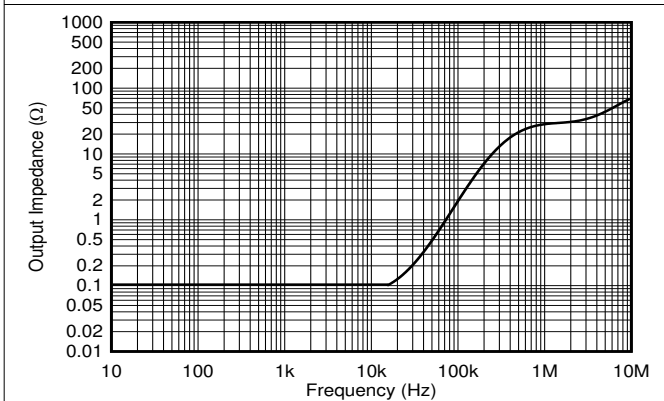

6-21. Output Impedance vs Frequency

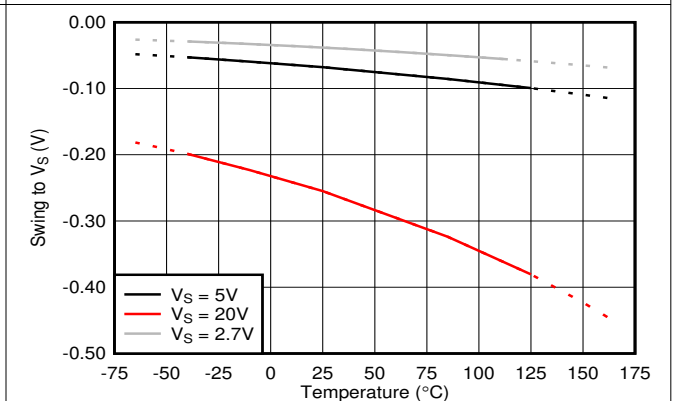

6-22. Swing to Supply vs Temperature

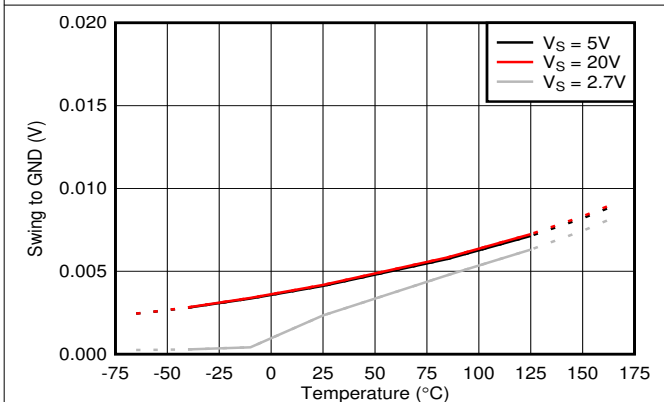

6-23. Swing to GND vs Temperature

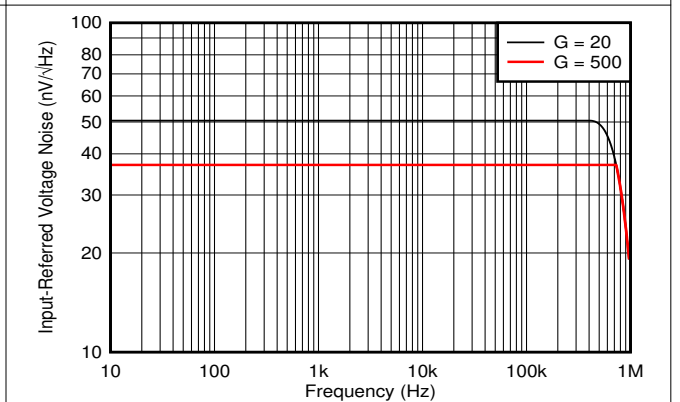

6-24. Input Referred Noise vs Frequency

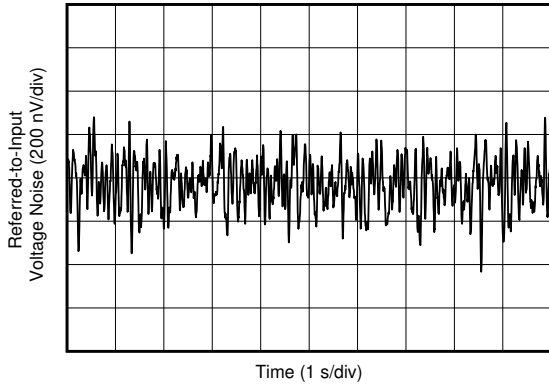

6-25. Input Referred Noise

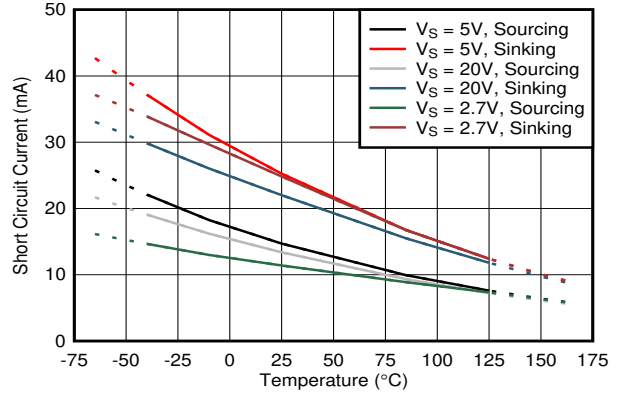

6-26. Short-Circuit Current vs Temperature

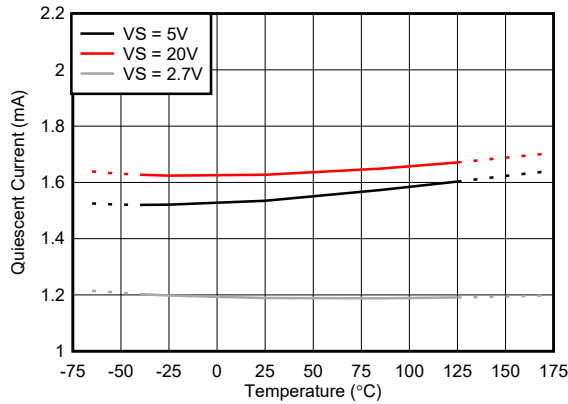

6-27. Quiescent Current vs Temperature

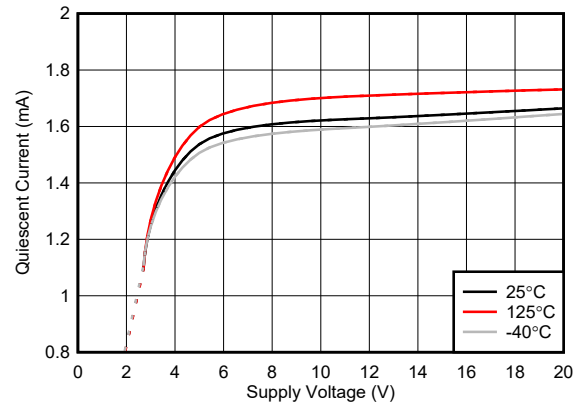

6-28. Quiescent Current vs Supply Voltage

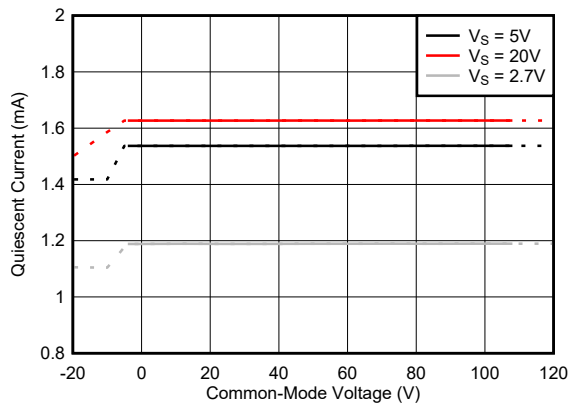

6-29. Quiescent Current vs Common-Mode Voltage

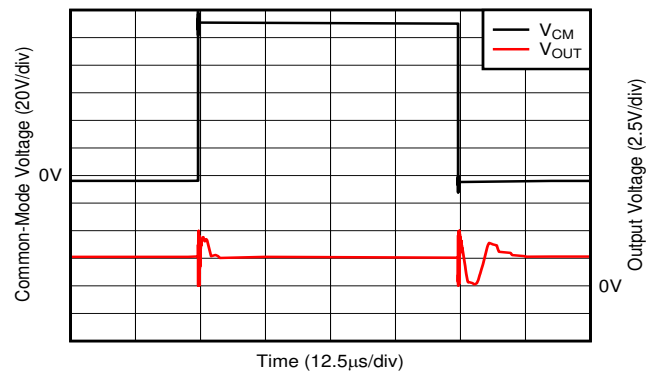

6-30. Common-Mode Voltage Fast Transient Pulse

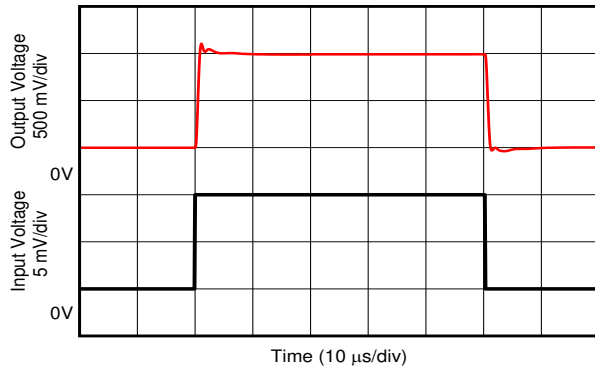

6-31. INA310x3 Step Response

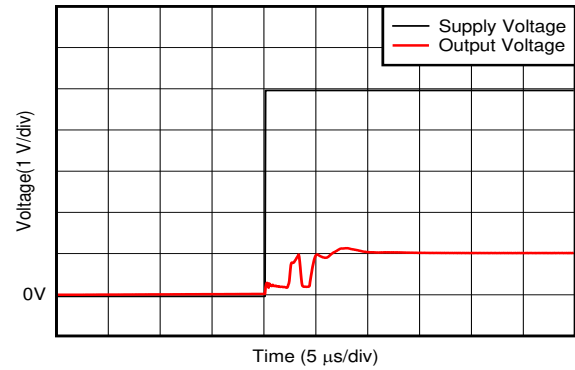

6-32. Start-Up Response

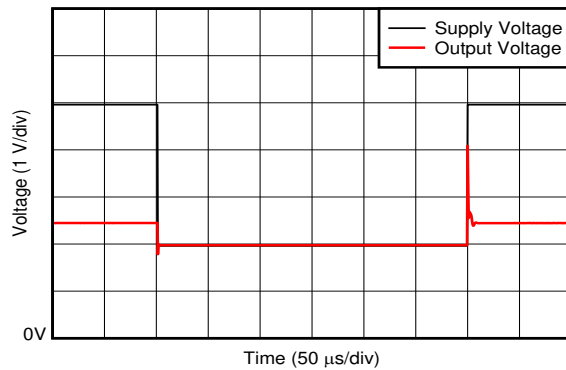

6-33. Supply Transient Response

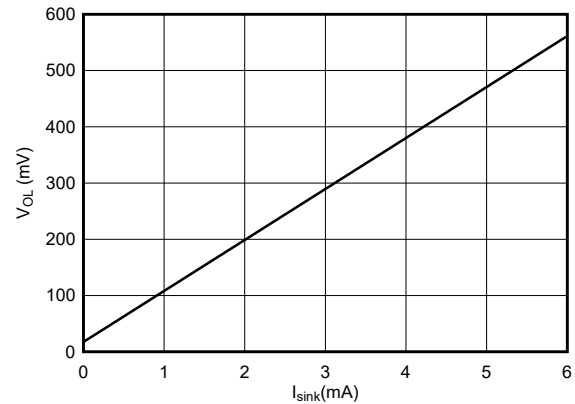

6-34. Comparator V_{OL} vs I_{SINK}

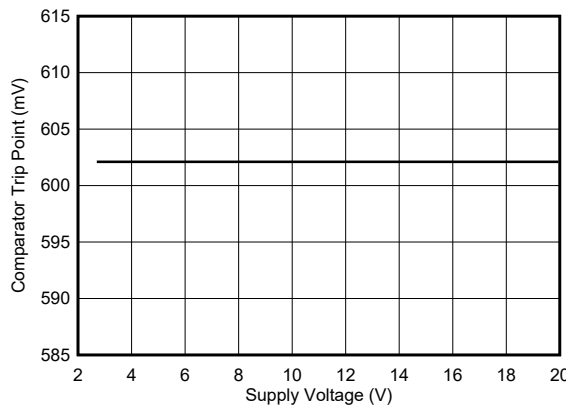

6-35. Comparator Trip Point vs Supply Voltage

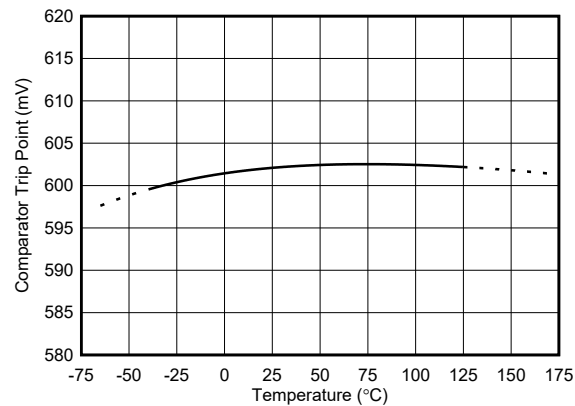

6-36. Comparator Trip Point vs Temperature

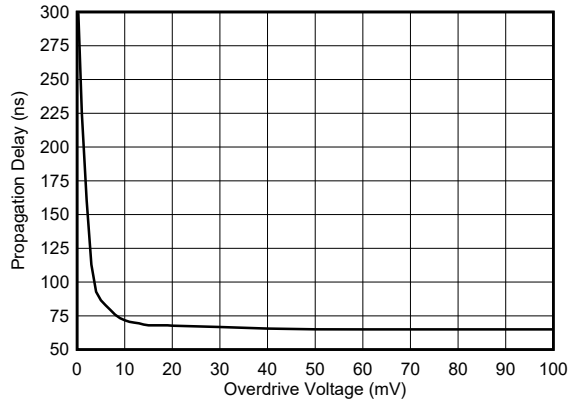

6-37. Comparator Propagation Delay vs Overdrive Voltage

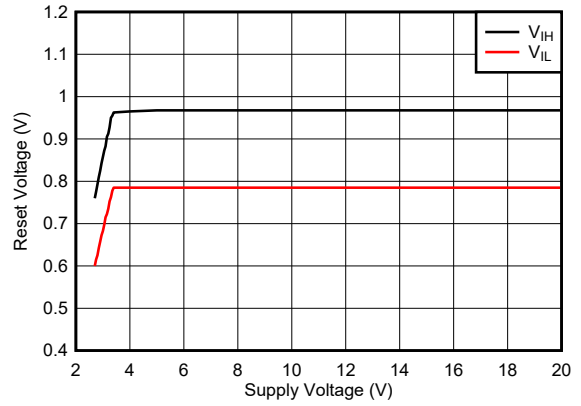

6-38. Comparator Reset Voltage vs Supply Voltage

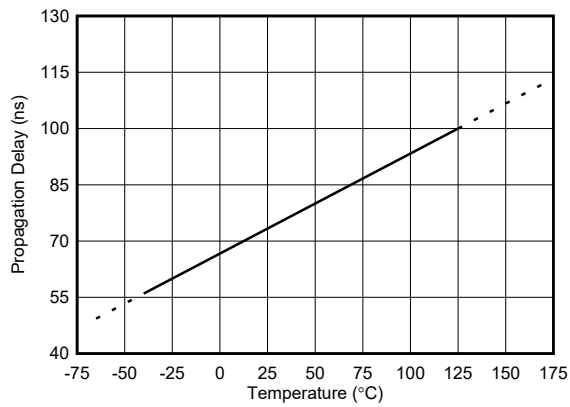

6-39. Comparator Propagation Delay vs Temperature

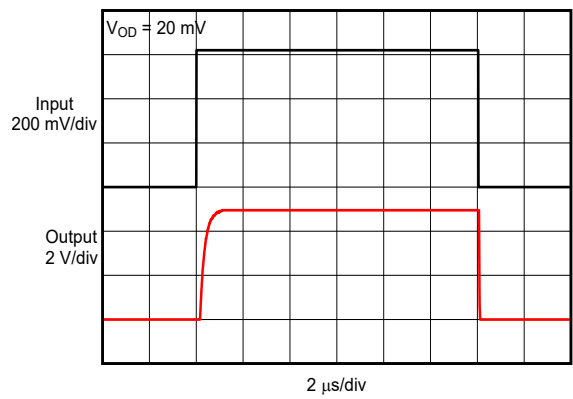

6-40. Comparator Propagation Delay

7 Detailed Description

7.1 Overview

The INA310x is a high or low-side high-speed current-sense amplifier that offers a wide common-mode range, precision zero-drift topology, excellent common-mode rejection ratio (CMRR) and fast slew rate. Different gain versions are available to optimize the output dynamic range based on the application. The INA310x is designed using an architecture that enables low input bias current of 20 μA with a specified common-mode voltage range from -4 V to 110 V with signal bandwidths up to 1.3 MHz. The INA310x incorporates an open-drain comparator and internal reference providing a 0.6-V threshold. An external resistor divider sets the current trip point. The comparator includes a latching capability, that can be made transparent by grounding (or leaving open) the $\overline{\text{RESET}}$ pin (see the [RESET Function](#) section).

7.2 Functional Block Diagram

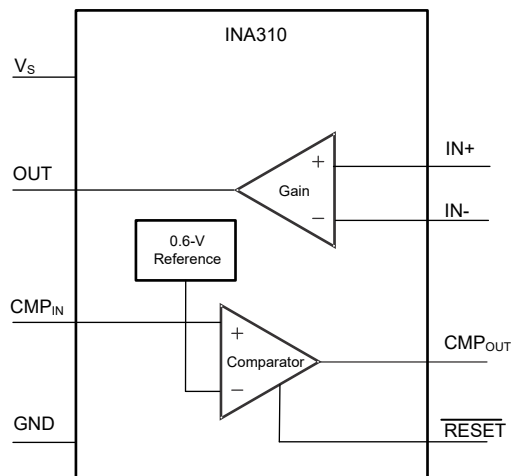

7.3 Feature Description

7.3.1 Amplifier Input Common-Mode Signal

The INA310x supports large input common-mode voltages from -4 V to $+110\text{ V}$. The internal topology of the INA310x enables the common-mode range to not be restricted by the power-supply voltage (V_S). Due to this feature, the INA310x can be used for both low-side and high-side current-sensing applications that extend beyond the supply range of 2.7 V to 20 V .

7.3.2 Input-Signal Bandwidth

The INA310x is available with several gain options, including 20 V/V, 50 V/V, 100 V/V, 200 V/V, and 500 V/V. The unique multistage design enables the amplifier to achieve high bandwidth at all gains. This high bandwidth provides the throughput and fast response that is required for the rapid detection and processing of overcurrent events.

7.3.3 Low Input Bias Current

The INA310x inputs draw a $20\text{-}\mu\text{A}$ input bias current per pin at a common-mode voltage as high as 110 V , which enables precision current sensing on applications that require lower current leakage. Unlike many high voltage current sense amplifiers whose input bias currents are proportional to the common-mode voltage, the input bias current of the INA310x remains flat over the entire common-mode voltage range.

7.3.4 Low V_{SENSE} Operation

The INA310x features high performance operation across the entire valid V_{SENSE} range. The zero-drift input architecture of the INA310x provides the low offset voltage and low offset drift needed to measure low V_{SENSE} levels accurately across the wide operating temperature of -40°C to $+125^\circ\text{C}$. Low V_{SENSE} operation is particularly beneficial when using low ohmic shunts for high current measurements, as power losses across the

shunt are significantly reduced. V_{SENSE} low level is only limited by the output swing to GND (V_{SN}). The minimum V_{SENSE} is limited to V_{SN} divided by Gain.

7.3.5 Wide Fixed Gain Output

The INA310x maximum gain error is 0.15% at room temperature, with a maximum drift of 10 ppm/°C over the full temperature range of -40°C to $+125^{\circ}\text{C}$. The INA310x is available in multiple gain options of 20 V/V, 50 V/V, 100 V/V, 200 V/V, and 500 V/V, which the system designer should select based on their desired signal-to-noise ratio and other system requirements, such as the dynamic current range and full-scale output voltage target.

The INA310x closed-loop gain is set by a precision, low-drift internal resistor network. The ratio of these resistors are excellently matched, while the absolute values may vary significantly. TI does not recommend adding additional resistance around the INA310x to change the effective gain because of this variation.

7.3.6 Wide Supply Range

The INA310x operates with a wide supply range from 2.7 V to 20 V. While the input voltage range of the INA310x is independent of the supply voltage, the output voltage is bound by the supply voltage applied to the device. The output voltage can range from as low as 20 mV to as high as 200 mV below the supply voltage.

7.3.7 Integrated Comparator

The INA310x incorporates an open-drain comparator with an internal reference providing a 0.6-V threshold. The comparator input (CMP_{IN}) can take voltage from 0 V up to 5.5 V or equal to power-supply voltage (if it is lower than 5.5 V). The comparator has a built-in hysteresis of 8 mV (typical). [Figure 7-1](#) shows the hysteresis, which is the difference between the rising-edge threshold and the falling-edge threshold. The hysteresis makes stable switching at the comparator output by providing noise immunity at comparator input.

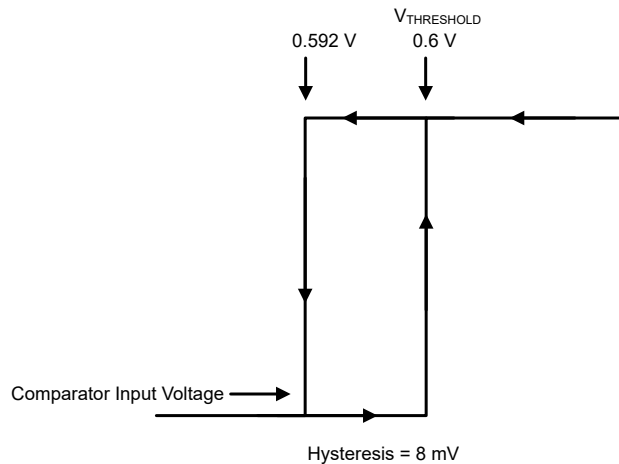

Figure 7-1. The Comparator Threshold and Hysteresis

The open-drain output of the comparator can be tied to voltage range of 0 to 20 V (independent of power supply) through a pullup resistor. When the voltage at the comparator input (CMP_{IN}) exceeds 0.6 V, the output of the comparator goes high. When the voltage at the comparator input falls below falling-threshold ($0.6\text{ V} - \text{Hysteresis}$), the output of the comparator is pulled low by an internal open-drain transistor.

7.3.8 RESET Function

The $\overline{\text{RESET}}$ function allows the comparator to work in transparent mode or latching mode. [Figure 7-2](#) shows the two modes of the $\overline{\text{RESET}}$ function. When the $\overline{\text{RESET}}$ pin is left open or connected to GND the comparator functions in a transparent mode. In transparent mode comparator output (CMP_{OUT}) responds as a normal comparator. When the $\overline{\text{RESET}}$ pin is connected to the supply voltage, the pin operates in latching mode. In the latching mode when the comparator is triggered by the comparator input going higher than 0.6 V, the output of the comparator stays high irrespective of comparator input after. To release the comparator from the latching mode, the $\overline{\text{RESET}}$

pin must be pulled to GND or released to open. The $\overline{\text{RESET}}$ pin can take a voltage range from 0 V to the power-supply voltage.

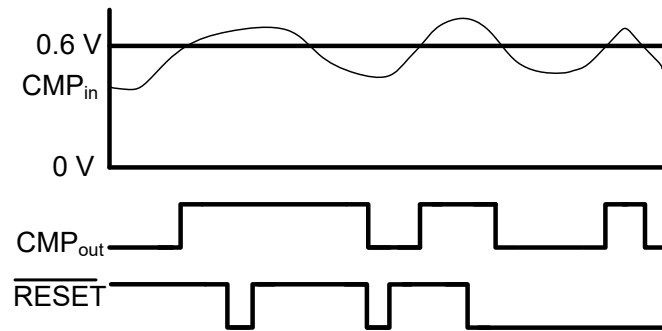

7-2. The Comparator $\overline{\text{RESET}}$ Function

7.3.9 Short Propagation Delay

The combination of a high-speed current sense amplifier and a fast comparator provides a short total propagation delay of 1 μs . The sense voltage (across the shunt resistor) propagates through the output where the output is divided down with the resistor divider to the comparator input and then to the comparator output. An external resistor divider at V_{OUT} sets overcurrent threshold. The total propagation delay is time taken from when the sense voltage (across the shunt resistor) exceeds the overcurrent threshold to when the comparator output drives high. The short propagation delay makes the INA310x well suited for overcurrent protection in systems sensitive to overcurrent events.

7.3.10 Comparator Input Bias Current

The INA310x comparator input has a built-in circuit to protect the input devices in case of large input differential voltage. This circuit results in the input bias current (I_{BCMPIN}) curve against input voltage (V_{CMPIN}) as shown in [7-3](#). The I_{BCMPIN} reduces with V_{CMPIN} from 0 V to 0.4 V, I_{BCMPIN} is under 20 nA at 25°C for V_{CMPIN} range from 0.4 V to 1.2 V, and I_{BCMPIN} increases with V_{CMPIN} from 1.8 V to 5.5 V. The nature of I_{BCMPIN} does not contribute to the inaccuracy of the comparator alert threshold voltage ($V_{\text{THRESHOLD}}$) significantly because the I_{BCMPIN} goes below 20 nA when the input voltage is close to the threshold voltage (0.6 V). Avoid using a high-value resistor for the divider network for better $V_{\text{THRESHOLD}}$ accuracy. The sum of the two resistors in the divider network as shown in [Overcurrent Threshold Connection](#) is recommended to keep lower than 100 k Ω .

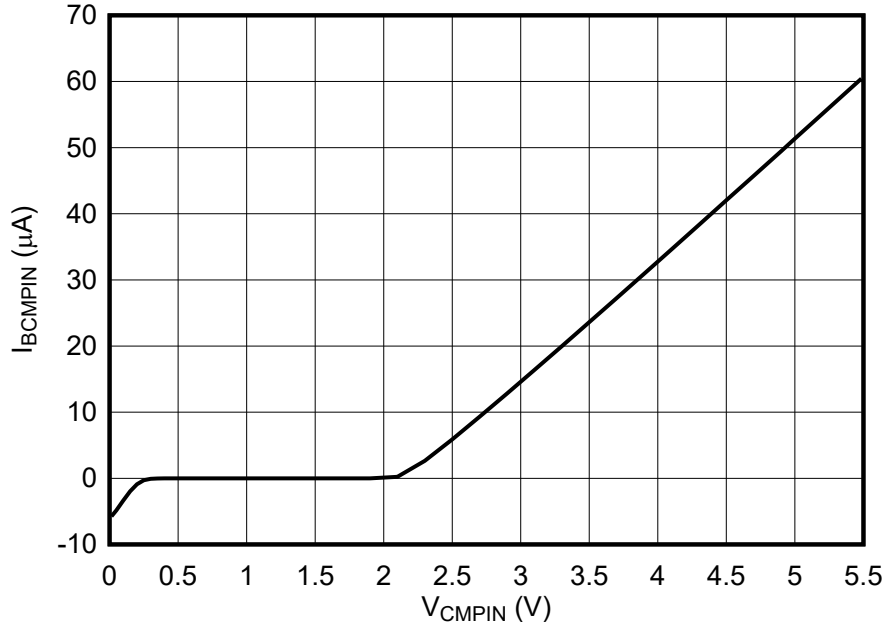

 **7-3. Comparator I_{BCMPIN} vs V_{CMPIIN}**

7.4 Device Functional Modes

7.4.1 Basic Connections

 **7-4** shows a basic circuit connection for INA310x. The INA310x is configurable to allow for unidirectional high-side or low-side, current-sensing operation. The input pins (IN+ and IN–) must be connected as closely as possible with Kelvin connections to the shunt resistor to minimize any resistance in series with the shunt resistance. The [Layout](#) section provides the layout guidelines and a layout example.

Power-supply bypass capacitors are required for stability. Applications with noisy or high-impedance power supplies may require additional decoupling capacitors to reject power-supply noise. Connect bypass capacitors close to the device V_S pin. The recommended value of a bypass capacitor is 0.01 μ F

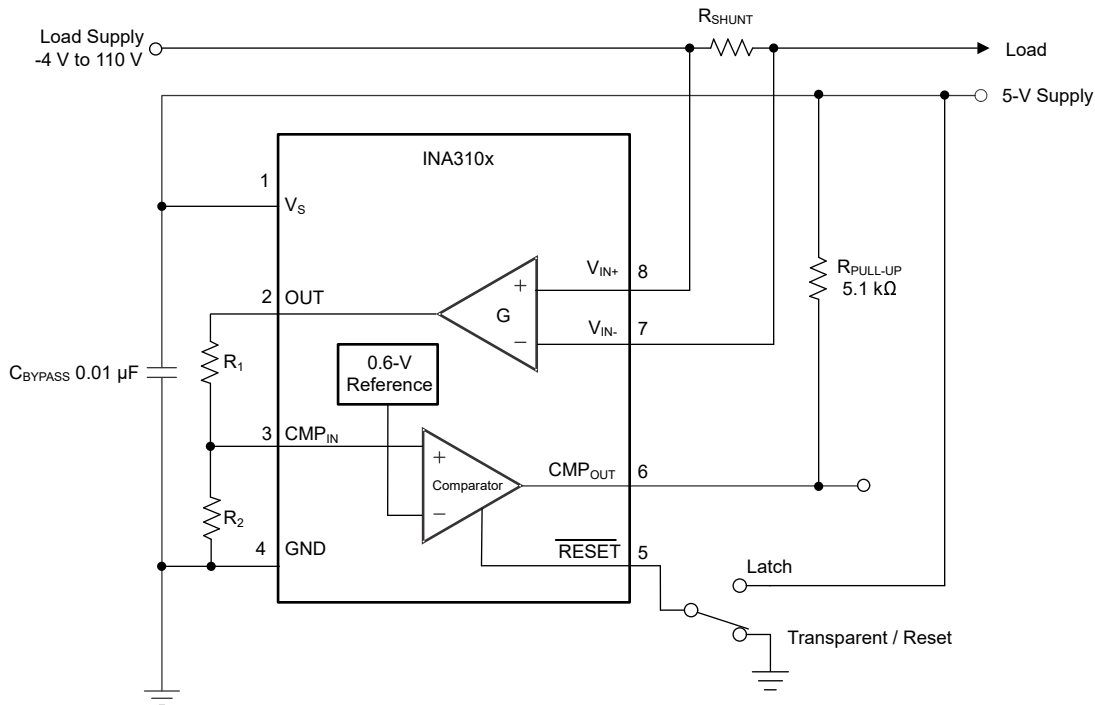

7-4. INA310 Basic Connections

7.4.1.1 Overcurrent Threshold Connection

The INA310x comparator in 7-4 is configured to provide overcurrent alert signal when the current through R_{SHUNT} exceeds the overcurrent threshold. OUT voltage times R_2 divided by R_1 and R_2 compared to the internal reference voltage (0.6 V) sets the overcurrent threshold. 1 shows the relation of the overcurrent threshold with gain, R_{SHUNT} , R_1 and R_2 .

$$I_{Sense_Alert_Threshold} = \frac{0.6 \times (R_1 + R_2)}{R_2 \times G \times R_{shunt}} \quad (1)$$

R_1 and R_2 load OUT, therefore TI recommends to set the sum of these resistors higher than 10k. This helps keep the high swing range at the OUT and lower total supply current. The high value of these resistors will contribute to inaccuracy in comparator alert threshold voltage ($V_{THRESHOLD}$) as mentioned in [Comparator Input Bias Current](#). The [Design Requirements](#) section shows an example of resistors values to set the overcurrent threshold.

7.4.2 High-Side Switch Overcurrent Shutdown

The INA310x measures differential voltage developed by current flowing through a current-shunt resistor. [Figure 7-5](#) shows the circuit with INA310x used for turning off the high-side switch in case of overcurrent. When the current exceeds overcurrent threshold, the comparator output (CMP_{OUT}) signal goes high. This signal from the comparator drives through the Q1 transistor to the gate of the high-side switch, causing the switch to shut down. The Q1 transistor helps isolate CMP_{OUT} from the high voltage of the Supply. There are three location options to have shunt resistor to measure unidirectional current. Option 1 and Option 2 are high-side current sensing, and Option 3 is low-side current sensing. Though both are high-side current sensing, Option 1 accounts for the current flowing through the Q1 transistor, and Option 2 does not. The advantages of high-side current sensing are that high-side sensing options do not contribute to ground disturbances and that high-side sensing can detect load shorts. In high-side current sensing, input common-mode is close to the power supply so a current-sensing amplifier with high CMRR and high common-mode is required for high-accuracy measurement. The low-side current sensing does not require a high-voltage, current-sensing amplifier as common mode remains very close to the ground. The disadvantages of low-side current sensing are that low-side sensing options contribute to ground disturbances and that low-side current sensing cannot detect load shorts.

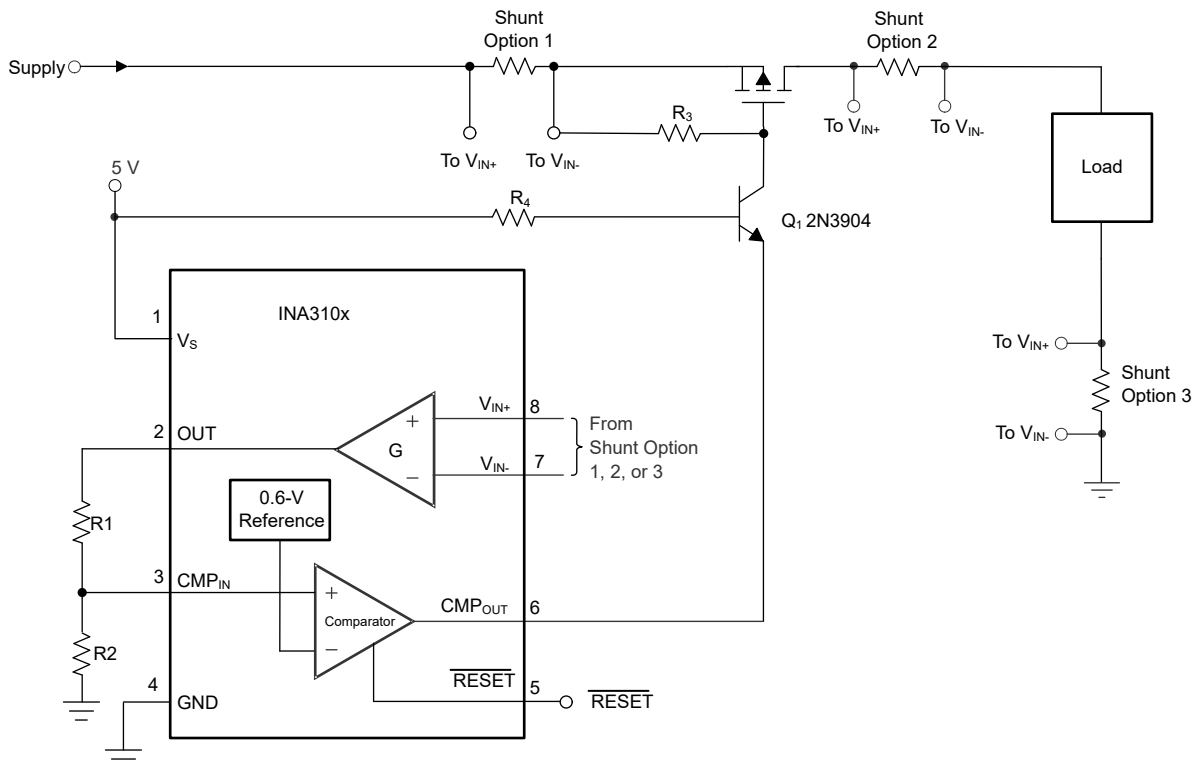

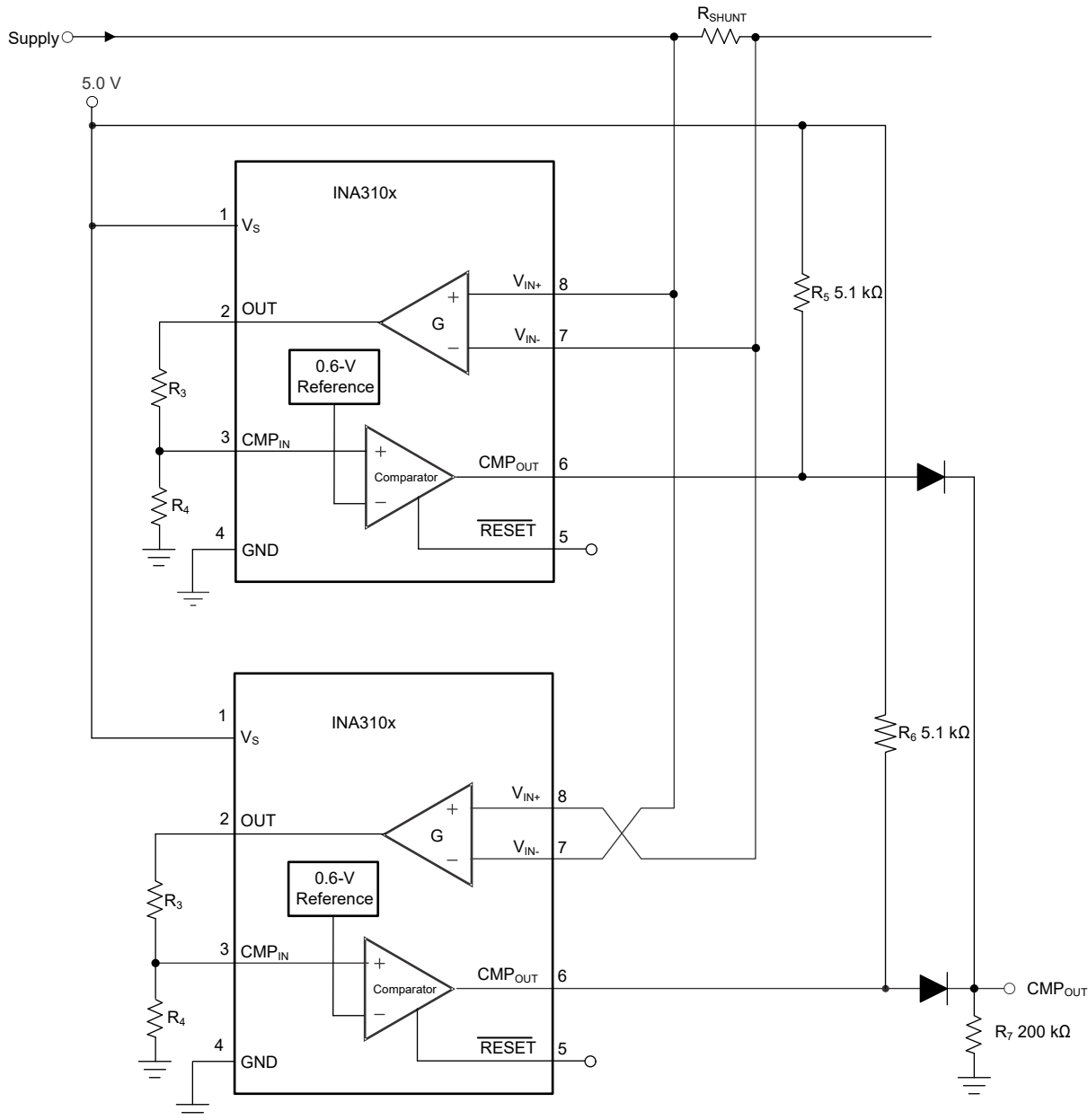

Figure 7-5. High-Side Switch for Overcurrent Shutdown

7.4.3 Bidirectional Overcurrent Comparator

The INA310x can operate only in unidirectional mode, but  7-6 shows that two INA310xs can be configured to provide a bidirectional overcurrent alert signal. The polarity of the differential voltage measured across the shunt resistor is in reverse for one current sense amplifier. Two INA310x function to cover the opposite current directions, and therefore provide bidirectional overcurrent monitor function.



 7-6. Ground Referenced Output

8 Application and Implementation

注

以下のアプリケーション情報は、TI の製品仕様に含まれるものではなく、TI ではその正確性または完全性を保証いたしません。個々の目的に対する製品の適合性については、お客様の責任で判断していただくこととなります。お客様は自身の設計実装を検証しテストすることで、システムの機能を確認する必要があります。

8.1 Application Information

The INA310x amplifies the voltage developed across a current-sensing resistor as current flows through the resistor to the load. The wide input common-mode voltage range and high common-mode rejection of the INA310x make the device usable over a wide range of voltage rails while still maintaining accurate current measurement.

8.1.1 R_{SENSE} and Device Gain Selection

To maximize the accuracy of a current sense amplifier, TI recommends to choose the largest current sense resistor value possible in an application. A larger value sense resistor maximizes the differential input signal for a given amount of current flow and reduces the error contribution of the offset voltage. However, there are practical limits as to how large the current-sense resistor value can be in a given application because of the physical dimensions of the resistor, package construction and maximum power dissipation. 式 2 gives the maximum value for the current-sense resistor for a given power dissipation budget:

$$R_{\text{SENSE}} < \frac{PD_{\text{MAX}}}{I_{\text{MAX}}^2} \quad (2)$$

where:

- PD_{MAX} is the maximum allowable power dissipation in R_{SENSE}.
- I_{MAX} is the maximum current that will flow through R_{SENSE}.

An additional limitation on the size of the current sense resistor and device gain is due to the power-supply voltage, V_S, and device swing-to-rail limitations. To make sure that the current-sense signal is properly passed to the output, both positive and negative output swing limitations must be examined. 式 3 provides the maximum values of R_{SENSE} and GAIN to keep the device from exceeding the positive swing limitation.

$$I_{\text{MAX}} \times R_{\text{SENSE}} \times \text{GAIN} < V_{\text{SP}} \quad (3)$$

where:

- I_{MAX} is the maximum current that will flow through R_{SENSE}.
- GAIN is the gain of the current-sense amplifier.
- V_{SP} is the positive output swing as specified in the data sheet.

To avoid positive output swing limitations when selecting the value of R_{SENSE}, there is always a trade-off between the value of the sense resistor and the gain of the device under consideration. If the sense resistor selected for the maximum power dissipation is too large, then it is possible to select a lower-gain device to avoid positive swing limitations.

The negative swing limitation places a limit on how small the sense resistor value can be for a given application. 式 4 provides the limit on the minimum value of the sense resistor.

$$I_{\text{MIN}} \times R_{\text{SENSE}} \times \text{GAIN} > V_{\text{SN}} \quad (4)$$

where:

- I_{MIN} is the minimum current that will flow through R_{SENSE}.

- GAIN is the gain of the current-sense amplifier.
- V_{SN} is the negative output swing of the device.

表 8-1 shows an example of the different results obtained from using five different gain versions of the INA310x. From the table data, the highest gain device allows a smaller current-shunt resistor and decreased power dissipation in the element.

表 8-1. R_{SENSE} Selection and Power Dissipation⁽¹⁾

PARAMETER		EQUATION	RESULTS AT $V_S = 5\text{ V}$				
			A1, B1 DEVICES	A2, B2 DEVICES	A3, B3 DEVICES	A4, B4 DEVICES	A5, B5 DEVICES
G	Gain		20 V/V	50 V/V	100 V/V	200 V/V	500 V/V
V_{DIFF}	Ideal differential input voltage	$V_{DIFF} = V_{OUT} / G$	250 mV	100 mV	50 mV	25 mV	10mV
R_{SENSE}	Current sense resistor value	$R_{SENSE} = V_{DIFF} / I_{MAX}$	25 mΩ	10 mΩ	5 mΩ	2.5 mΩ	1 mΩ
P_{SENSE}	Current-sense resistor power dissipation	$R_{SENSE} \times I_{MAX}^2$	2.5 W	1 W	0.5 W	0.25 W	0.1 W

(1) Design example with 10-A full-scale current with maximum output voltage set to 5 V.

8.2 Typical Application

The INA310x is a unidirectional, current-sense amplifier capable of measuring currents through a resistive shunt with shunt common-mode voltages from -4 V to $+110\text{ V}$.

8.2.1 Current Sensing in a Solenoid Application



图 8-1. Current Sensing in a Solenoid Application

8.2.1.1 Design Requirements

In this example application, the common-mode voltage ranges from 0 V to 24 V. The maximum sense current is 1.5 A, an alert must be indicated if the current exceeds 1.9 A, and a 5 V supply is available for the INA310x. Following the design guidelines from [R_{SENSE} and Device Gain Selection](#), a R_{SENSE} of 50 mΩ and a gain of 50 V/V are selected to provide good output dynamic range. 表 8-2 lists the design setup for this application.

表 8-2. Design Parameters

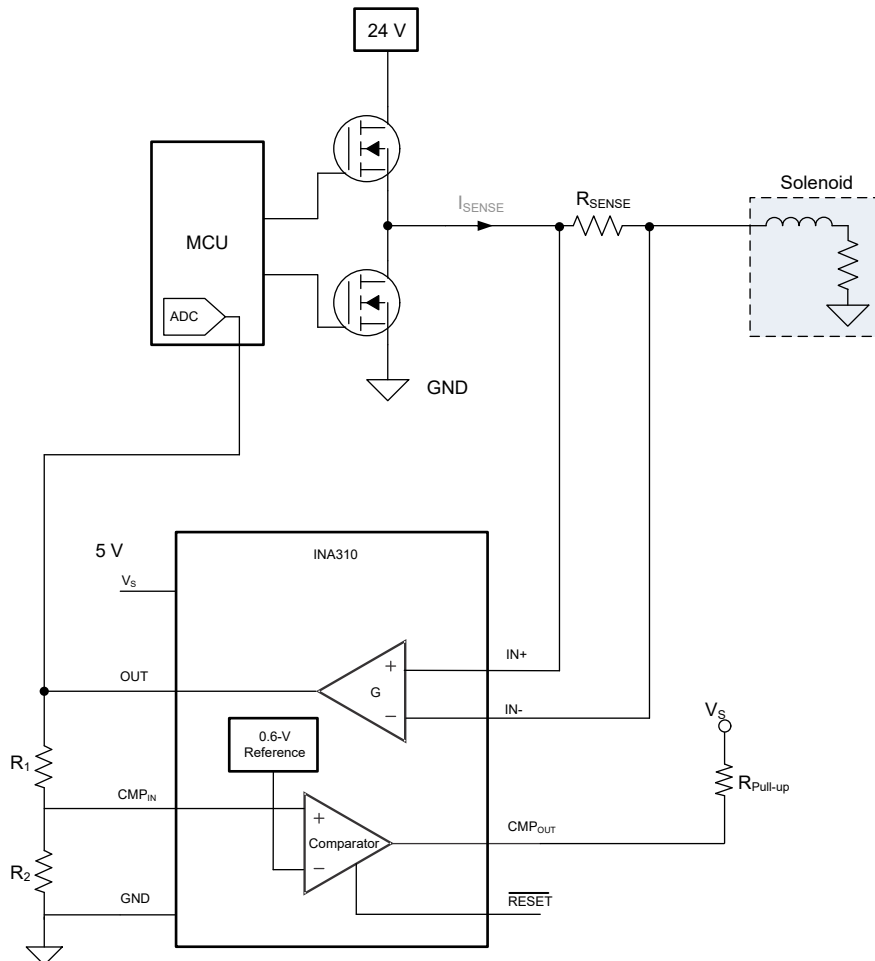
DESIGN PARAMETERS	EXAMPLE VALUE
Power supply voltage	5 V
Common mode voltage range	0 V to 24 V
Maximum sense current	1.5 A
R _{SENSE} resistor	50 mΩ
Gain option	50 V/V
Over-current Threshold	1.9 A
R ₁	69.15 kΩ
R ₂	10 kΩ

8.2.1.2 Detailed Design Procedure

The INA310x is designed to measure current in a typical solenoid application. The INA310x measures current across the 50-mΩ shunt that is placed at the output of the half-bridge. The INA310x measures the differential voltage across the shunt resistor, and the signal is internally amplified with a gain of 50 V/V. The output of the INA310x is connected to the analog-to-digital converter (ADC) of an MCU to digitize the current measurements.

R₂ is fixed as 10 kΩ to avoid loading of OUT as recommended in [Overcurrent Threshold Connection](#). R₁ is calculated as 69.15 kΩ using 式 1.

$$1.9 \text{ A} = \frac{0.6 \text{ V} \times (R_1 + 10 \text{ k}\Omega)}{10 \text{ k}\Omega \times 50 \times 50 \text{ m}\Omega}$$

R₁ (69.15 kΩ) and R₂ (10 kΩ) divides down the output which is an input to the comparator. This sets the overcurrent alert threshold of 1.9 A.

Solenoid loads are highly inductive and are often prone to failure. Solenoids are often used for position control, precise fluid control, and fluid regulation. Measuring real-time current on the solenoid continuously can indicate premature failure of the solenoid, which can lead to a faulty control loop in the system. Measuring high-side current also indicates if there are any ground faults on the solenoid or the FETs that can be damaged in an application. The INA310x, with high bandwidth and slew rate, can be used to detect fast overcurrent conditions to prevent the solenoid damage from short-to-ground faults.

8.2.1.2.1 Overload Recovery With Negative V_{SENSE}

The INA310x is a unidirectional current sense amplifier that is meant to operate with a positive differential input voltage (V_{SENSE}). If negative V_{SENSE} is applied, the device is placed in an overload or saturated condition and requires time to recover after V_{SENSE} returns positive. The required overload recovery time increases with more negative V_{SENSE}.

8.2.1.3 Application Curve

Figure 8-2 shows the output response of a solenoid.

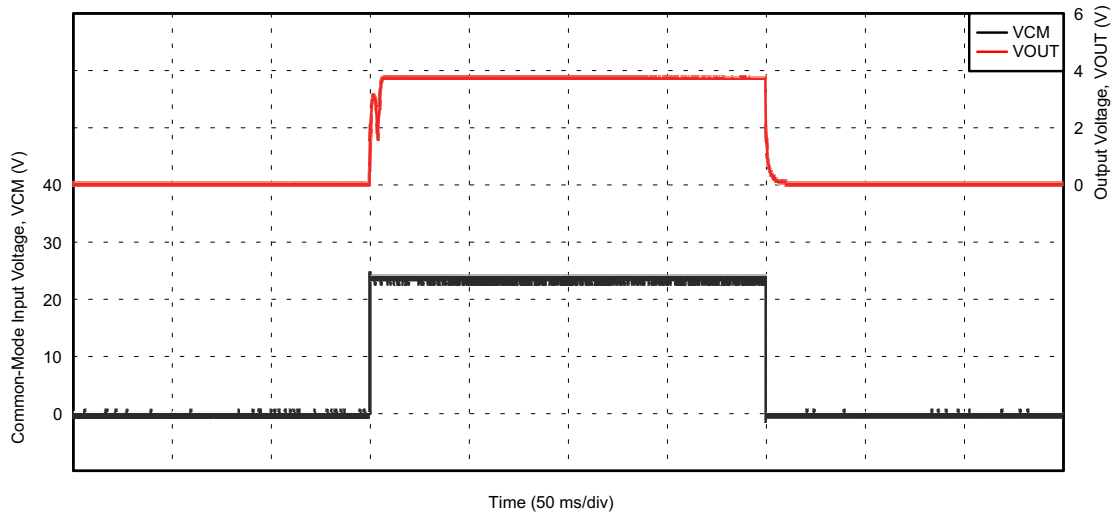

Figure 8-2. Solenoid Control Current Response

8.2.2 Low-Side Switch Overcurrent Shutdown

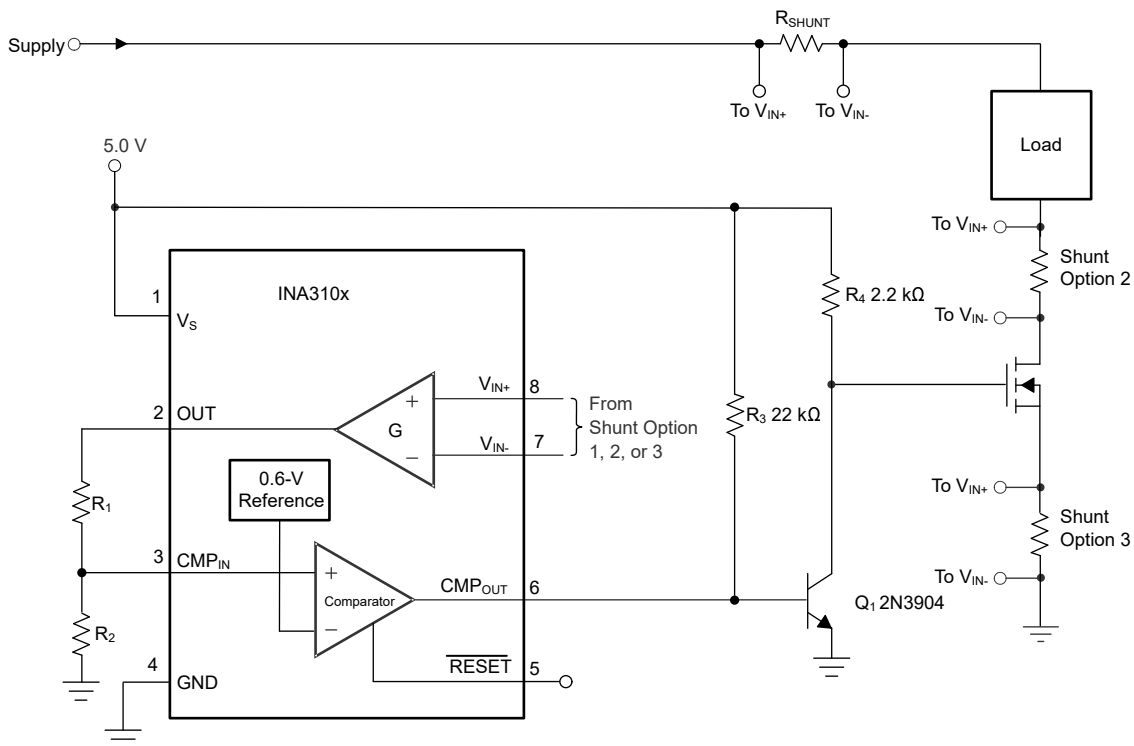

Figure 8-3. Low-Side Switch Overcurrent Shutdown

8.2.2.1 Design Requirements

The INA310x measures current through a resistive shunt with current flowing in one direction that enables detection of an overcurrent event only when the differential input voltage exceeds the threshold limit. When the current reaches the set limit of the divider of R_1 and R_2 , the output of comparator (CMP_{OUT}) transitions high, which turns on Q_1 , pulls the gate of the pass-FET low, and turns off the flow of the current. In this example

application, the common-mode voltage is set at 5 V. The maximum sense current is 1 A, an alert must be indicated if the current exceeds 1.2 A, and a 5 V supply is available for the INA310x. Following the design guidelines from *R_{SENSE} and Device Gain Selection*, a R_{SHUNT} of 100 mΩ and a gain of 20 V/V are selected to provide a good output dynamic range. 表 8-3 lists the design setup for this application.

表 8-3. Design Parameters

DESIGN PARAMETERS	EXAMPLE VALUE
Power supply voltage	5 V
Common mode voltage range	5 V
Maximum sense current	1 A
R _{SENSE} resistor	100 mΩ
Gain option	20 V/V
Over-current Threshold	1.2 A
R ₁	10.2 kΩ
R ₂	3.4 kΩ

8.2.2.2 Detailed Design Procedure

图 8-3 shows the basic connections to the INA310x. The inputs terminals (IN+ and IN-) must be connected to the current sense resistor as close as possible to minimize any resistance in series with the shunt resistor. The INA310x measures current across the 100-mΩ shunt that is placed in series with load. The INA310x measures the differential voltage across the shunt resistor, and the signal is internally amplified with a gain of 20 V/V.

R₁ is fixed as 10.2 kΩ to avoid loading of OUT as recommended in *Overcurrent Threshold Connection*. R₂ is calculated as 3.4 kΩ using 式 1. R₁ (10.2 kΩ) and R₂ (3.4 kΩ) divides down the output which is an input to the comparator. This sets the overcurrent alert threshold of 1.2 A.

8.2.2.3 Application Curve

图 8-4 shows the output response the current sense amplifier and the comparator in event of overcurrent.



图 8-4. Low-Side Switch Overcurrent Shutdown Response

8.3 Power Supply Recommendations

The INA310x makes accurate measurements beyond the connected power-supply voltage (V_S) because the inputs (IN+ and IN-) can operate anywhere between -4 V and 110 V independent of V_S . For example, with the V_S power supply equal to 5 V, the common-mode voltage of the measured shunt can be as high as 110 V.

8.3.1 Power Supply Decoupling

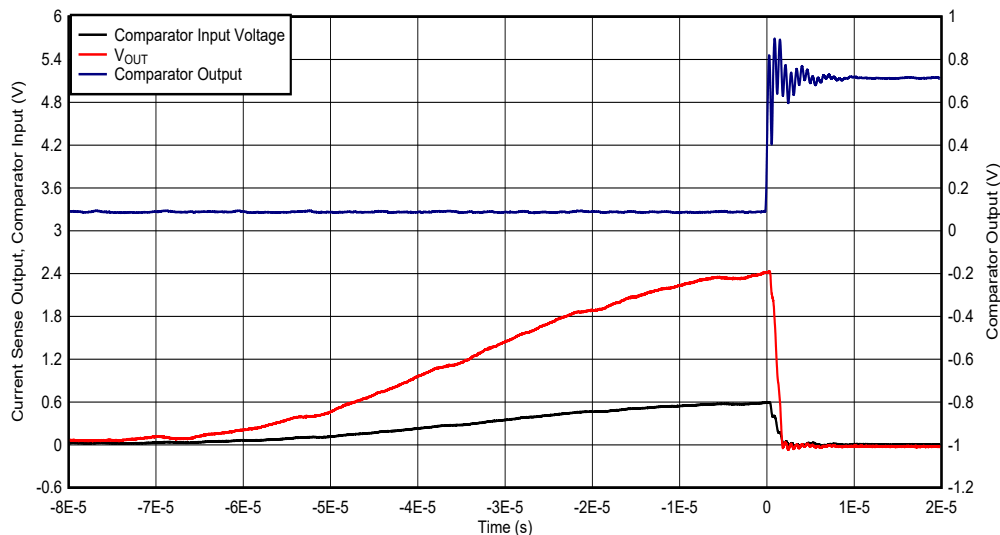
Place the power-supply bypass capacitor as close to the power-supply and ground pins as possible. TI recommends a bypass capacitor value of 0.1 μF . Additional decoupling capacitance can be added to compensate for noisy or high-impedance power supplies.

8.4 Layout

8.4.1 Layout Guidelines

Attention to good layout practices is always recommended.

- Connect the input pins to the sensing resistor using a Kelvin or 4-wire connection. This connection technique makes sure that only the current-sensing resistor impedance is detected between the input pins. Poor routing of the current-sensing resistor commonly results in additional resistance present between the input pins. Given the very low ohmic value of the current resistor, any additional high-current carrying impedance can cause significant measurement errors.
- Place the power-supply bypass capacitor as close to the device power-supply and ground pins as possible. The recommended value of this bypass capacitor is 0.1 μF . Additional decoupling capacitance can be added to compensate for noisy or high-impedance power supplies.

8.4.2 Layout Example

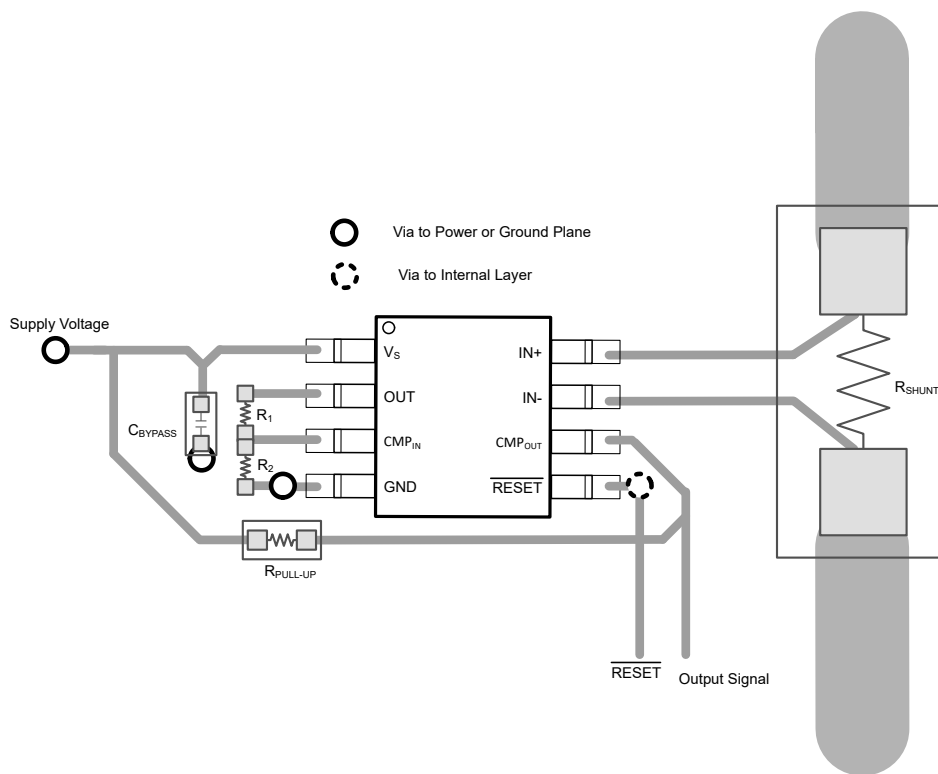

 **8-5. INA310xx Recommended Layout**

9 Device and Documentation Support

9.1 Receiving Notification of Documentation Updates

To receive notification of documentation updates, navigate to the device product folder on ti.com. In the upper right corner, click on *Alert me* to register and receive a weekly digest of any product information that has changed. For change details, review the revision history included in any revised document.

9.2 サポート・リソース

[TI E2E™ サポート・フォーラム](#)は、エンジニアが検証済みの回答と設計に関するヒントをエキスパートから迅速かつ直接得ることができる場所です。既存の回答を検索したり、独自の質問をしたりすることで、設計に必要な支援を迅速に得ることができます。

リンクされているコンテンツは、該当する貢献者により、現状のまま提供されるものです。これらは TI の仕様を構成するものではなく、必ずしも TI の見解を反映したものではありません。TI の[使用条件](#)を参照してください。

9.3 Trademarks

TI E2E™ is a trademark of Texas Instruments.

すべての商標は、それぞれの所有者に帰属します。

9.4 静電気放電に関する注意事項



この IC は、ESD によって破損する可能性があります。テキサス・インスツルメンツは、IC を取り扱う際には常に適切な注意を払うことを推奨します。正しい取り扱いおよび設置手順に従わない場合、デバイスを破損するおそれがあります。

ESD による破損は、わずかな性能低下からデバイスの完全な故障まで多岐にわたります。精密な IC の場合、パラメータがわずかに変化するだけで公表されている仕様から外れる可能性があるため、破損が発生しやすくなっています。

9.5 用語集

[テキサス・インスツルメンツ用語集](#) この用語集には、用語や略語の一覧および定義が記載されています。

10 Mechanical, Packaging, and Orderable Information

The following pages include mechanical, packaging, and orderable information. This information is the most current data available for the designated devices. This data is subject to change without notice and revision of this document. For browser-based versions of this data sheet, refer to the left-hand navigation.

PACKAGING INFORMATION

Orderable Device	Status (1)	Package Type	Package Drawing	Pins	Package Qty	Eco Plan (2)	Lead finish/ Ball material (6)	MSL Peak Temp (3)	Op Temp (°C)	Device Marking (4/5)	Samples
INA310A1IDGKR	ACTIVE	VSSOP	DGK	8	2500	RoHS & Green	NIPDAU	Level-2-260C-1 YEAR	-40 to 125	2OZB	Samples
INA310A2IDGKR	ACTIVE	VSSOP	DGK	8	2500	RoHS & Green	NIPDAU	Level-2-260C-1 YEAR	-40 to 125	2P1B	Samples
INA310A3IDGKR	ACTIVE	VSSOP	DGK	8	2500	RoHS & Green	NIPDAU	Level-2-260C-1 YEAR	-40 to 125	2P2B	Samples
INA310A4IDGKR	ACTIVE	VSSOP	DGK	8	2500	RoHS & Green	NIPDAU	Level-2-260C-1 YEAR	-40 to 125	2P3B	Samples
INA310A5IDGKR	ACTIVE	VSSOP	DGK	8	2500	RoHS & Green	NIPDAU	Level-2-260C-1 YEAR	-40 to 125	2P4B	Samples
INA310B1IDGKR	ACTIVE	VSSOP	DGK	8	2500	RoHS & Green	NIPDAU	Level-2-260C-1 YEAR	-40 to 125	2P5B	Samples
INA310B2IDGKR	ACTIVE	VSSOP	DGK	8	2500	RoHS & Green	NIPDAU	Level-2-260C-1 YEAR	-40 to 125	2P6B	Samples
INA310B3IDGKR	ACTIVE	VSSOP	DGK	8	2500	RoHS & Green	NIPDAU	Level-2-260C-1 YEAR	-40 to 125	2P7B	Samples
INA310B4IDGKR	ACTIVE	VSSOP	DGK	8	2500	RoHS & Green	NIPDAU	Level-2-260C-1 YEAR	-40 to 125	2P8B	Samples
INA310B5IDGKR	ACTIVE	VSSOP	DGK	8	2500	RoHS & Green	NIPDAU	Level-2-260C-1 YEAR	-40 to 125	2P9B	Samples

(1) The marketing status values are defined as follows:

ACTIVE: Product device recommended for new designs.

LIFEBUY: TI has announced that the device will be discontinued, and a lifetime-buy period is in effect.

NRND: Not recommended for new designs. Device is in production to support existing customers, but TI does not recommend using this part in a new design.

PREVIEW: Device has been announced but is not in production. Samples may or may not be available.

OBSOLETE: TI has discontinued the production of the device.

(2) **RoHS:** TI defines "RoHS" to mean semiconductor products that are compliant with the current EU RoHS requirements for all 10 RoHS substances, including the requirement that RoHS substance do not exceed 0.1% by weight in homogeneous materials. Where designed to be soldered at high temperatures, "RoHS" products are suitable for use in specified lead-free processes. TI may reference these types of products as "Pb-Free".

RoHS Exempt: TI defines "RoHS Exempt" to mean products that contain lead but are compliant with EU RoHS pursuant to a specific EU RoHS exemption.

Green: TI defines "Green" to mean the content of Chlorine (Cl) and Bromine (Br) based flame retardants meet JS709B low halogen requirements of <=1000ppm threshold. Antimony trioxide based flame retardants must also meet the <=1000ppm threshold requirement.

(3) MSL, Peak Temp. - The Moisture Sensitivity Level rating according to the JEDEC industry standard classifications, and peak solder temperature.

(4) There may be additional marking, which relates to the logo, the lot trace code information, or the environmental category on the device.

⁽⁵⁾ Multiple Device Markings will be inside parentheses. Only one Device Marking contained in parentheses and separated by a "~" will appear on a device. If a line is indented then it is a continuation of the previous line and the two combined represent the entire Device Marking for that device.

⁽⁶⁾ Lead finish/Ball material - Orderable Devices may have multiple material finish options. Finish options are separated by a vertical ruled line. Lead finish/Ball material values may wrap to two lines if the finish value exceeds the maximum column width.

Important Information and Disclaimer:The information provided on this page represents TI's knowledge and belief as of the date that it is provided. TI bases its knowledge and belief on information provided by third parties, and makes no representation or warranty as to the accuracy of such information. Efforts are underway to better integrate information from third parties. TI has taken and continues to take reasonable steps to provide representative and accurate information but may not have conducted destructive testing or chemical analysis on incoming materials and chemicals. TI and TI suppliers consider certain information to be proprietary, and thus CAS numbers and other limited information may not be available for release.

In no event shall TI's liability arising out of such information exceed the total purchase price of the TI part(s) at issue in this document sold by TI to Customer on an annual basis.

DGK0008A



PACKAGE OUTLINE

VSSOP - 1.1 mm max height

SMALL OUTLINE PACKAGE



4214862/A 04/2023

NOTES:

PowerPAD is a trademark of Texas Instruments.

1. All linear dimensions are in millimeters. Any dimensions in parenthesis are for reference only. Dimensioning and tolerancing per ASME Y14.5M.
2. This drawing is subject to change without notice.
3. This dimension does not include mold flash, protrusions, or gate burrs. Mold flash, protrusions, or gate burrs shall not exceed 0.15 mm per side.
4. This dimension does not include interlead flash. Interlead flash shall not exceed 0.25 mm per side.
5. Reference JEDEC registration MO-187.

EXAMPLE BOARD LAYOUT

DGK0008A

™ VSSOP - 1.1 mm max height

SMALL OUTLINE PACKAGE



LAND PATTERN EXAMPLE
EXPOSED METAL SHOWN
SCALE: 15X



4214862/A 04/2023

NOTES: (continued)

6. Publication IPC-7351 may have alternate designs.
7. Solder mask tolerances between and around signal pads can vary based on board fabrication site.
8. Vias are optional depending on application, refer to device data sheet. If any vias are implemented, refer to their locations shown on this view. It is recommended that vias under paste be filled, plugged or tented.
9. Size of metal pad may vary due to creepage requirement.

EXAMPLE STENCIL DESIGN

DGK0008A

TM VSSOP - 1.1 mm max height

SMALL OUTLINE PACKAGE



SOLDER PASTE EXAMPLE
SCALE: 15X

4214862/A 04/2023

NOTES: (continued)

11. Laser cutting apertures with trapezoidal walls and rounded corners may offer better paste release. IPC-7525 may have alternate design recommendations.
12. Board assembly site may have different recommendations for stencil design.

重要なお知らせと免責事項

TI は、技術データと信頼性データ（データシートを含みます）、設計リソース（リファレンス・デザインを含みます）、アプリケーションや設計に関する各種アドバイス、Web ツール、安全性情報、その他のリソースを、欠陥が存在する可能性のある「現状のまま」提供しており、商品性および特定目的に対する適合性の黙示保証、第三者の知的財産権の非侵害保証を含むいかなる保証も、明示的または黙示的にかかわらず拒否します。

これらのリソースは、TI 製品を使用する設計の経験を積んだ開発者への提供を意図したものです。(1) お客様のアプリケーションに適した TI 製品の選定、(2) お客様のアプリケーションの設計、検証、試験、(3) お客様のアプリケーションに該当する各種規格や、その他のあらゆる安全性、セキュリティ、規制、または他の要件への確実な適合に関する責任を、お客様のみが単独で負うものとします。

上記の各種リソースは、予告なく変更される可能性があります。これらのリソースは、リソースで説明されている TI 製品を使用するアプリケーションの開発の目的でのみ、TI はその使用をお客様に許諾します。これらのリソースに関して、他の目的で複製することや掲載することは禁止されています。TI や第三者の知的財産権のライセンスが付与されている訳ではありません。お客様は、これらのリソースを自身で使用した結果発生するあらゆる申し立て、損害、費用、損失、責任について、TI およびその代理人を完全に補償するものとし、TI は一切の責任を拒否します。

TI の製品は、[TI の販売条件](#)、または [ti.com](#) やかかる TI 製品の関連資料などのいずれかを通じて提供する適用可能な条項の下で提供されています。TI がこれらのリソースを提供することは、適用される TI の保証または他の保証の放棄の拡大や変更を意味するものではありません。

お客様がいかなる追加条項または代替条項を提案した場合でも、TI はそれらに異議を唱え、拒否します。

郵送先住所：Texas Instruments, Post Office Box 655303, Dallas, Texas 75265
Copyright © 2024, Texas Instruments Incorporated