

INA819 35 μ V オフセット、8nV/ $\sqrt{\text{Hz}}$ ノイズ、低消費電力、高精度計装アンプ

1 特長

- 低いオフセット電圧: 10 μ V (標準値)、35 μ V (最大値)
- ゲイン・ドリフト: 5ppm/ $^{\circ}\text{C}$ ($G = 1$)、35ppm/ $^{\circ}\text{C}$ ($G > 1$) (最大値)
- ノイズ: 8nV/ $\sqrt{\text{Hz}}$
- 帯域幅: 2 MHz ($G = 1$)、270 kHz ($G = 100$)
- 1nF の容量性負荷で安定
- $\pm 60\text{V}$ まで入力を保護
- 同相除去: 110dB、 $G = 10$ (最小値)
- 電源除去: 110dB、 $G = 1$ (最小値)
- 消費電流: 385 μA (最大値)
- 電源電圧範囲:
 - 単一電源: 4.5V \sim 36V
 - デュアル電源: $\pm 2.25\text{V} \sim \pm 18\text{V}$
- 仕様温度範囲: $-40^{\circ}\text{C} \sim +125^{\circ}\text{C}$
- パッケージ: 8ピン SOIC、VSSOP、WSON

2 アプリケーション

- アナログ入力モジュール
- 流量トランスミッタ
- バッテリ試験装置
- LCD テスト
- 心電図 (ECG)
- 外科用機器
- プロセス分析 (pH、ガス、濃度、力、湿度)

3 概要

INA819 は、単一電源またはデュアル電源の非常に幅広い電圧範囲で動作する、低消費電力の高精度計装アンプです。1 個の外付け抵抗により、1 \sim 10,000 の範囲で任意のゲインを設定できます。このデバイスは、入力オフセット電圧、オフセット電圧ドリフト、入力バイアス電流、入力電圧ノイズ、入力電流ノイズを極めて低く抑えるスーパー β 入力トランジスタを使用することで、高い精度を実現します。追加回路により、 $\pm 60\text{V}$ までの過電圧から入力を保護します。

INA819 は、非常に高い同相除去比を実現するよう最適化されています。 $G = 1$ での同相除去比は、全入力同相範囲を通じて 90dB を上回ります。このデバイスは、4.5V 単一電源および最大 $\pm 18\text{V}$ のデュアル電源による低電圧動作に設計されています。

INA819 は 8 ピン SOIC、VSSOP、WSON パッケージで供給され、 $-40^{\circ}\text{C} \sim +125^{\circ}\text{C}$ の温度範囲で動作が規定されています。

製品情報⁽¹⁾

部品番号	パッケージ	本体サイズ (公称)
INA819	SOIC (8)	4.90mm \times 3.91mm
	VSSOP (8)	3.00mm \times 3.00mm
	WSON (8)	3.00mm \times 3.00mm

- (1) 利用可能なパッケージについては、データシートの末尾にあるパッケージ・オプションについての付録を参照してください。

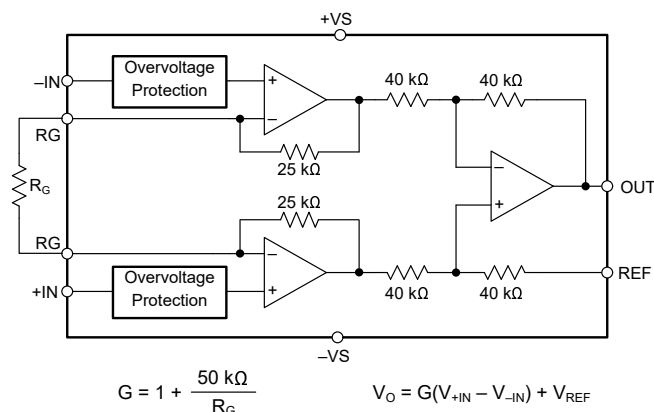

INA819 の内部概略回路図

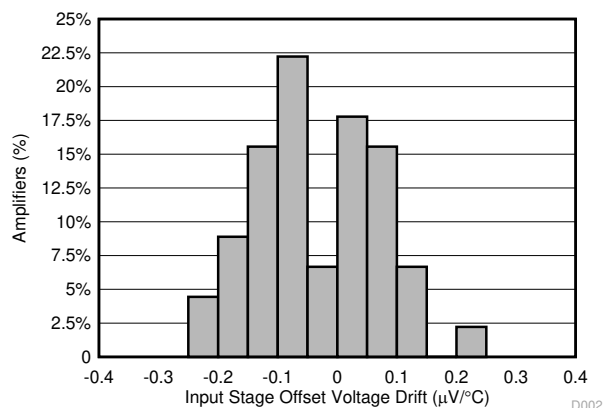

入力段のオフセット電圧ドリフトの代表的な分布



Table of Contents

1 特長	1	9 Application and Implementation	26
2 アプリケーション	1	9.1 Application Information.....	26
3 概要	1	9.2 Typical Applications.....	29
4 Revision History	2	10 Power Supply Recommendations	32
5 Device Comparison Table	3	11 Layout	32
6 Pin Configuration and Functions	4	11.1 Layout Guidelines.....	32
7 Specifications	5	11.2 Layout Example.....	33
7.1 Absolute Maximum Ratings.....	5	12 Device and Documentation Support	34
7.2 ESD Ratings.....	5	12.1 Device Support.....	34
7.3 Recommended Operating Conditions.....	5	12.2 Documentation Support.....	34
7.4 Thermal Information.....	5	12.3 Receiving Notification of Documentation Updates.....	34
7.5 Electrical Characteristics.....	6	12.4 サポート・リソース.....	34
7.6 Typical Characteristics.....	8	12.5 Trademarks.....	34
8 Detailed Description	19	12.6 Electrostatic Discharge Caution.....	35
8.1 Overview.....	19	12.7 Glossary.....	35
8.2 Functional Block Diagram.....	19	13 Mechanical, Packaging, and Orderable Information	35
8.3 Feature Description.....	20		
8.4 Device Functional Modes.....	26		

4 Revision History

資料番号末尾の英字は改訂を表しています。その改訂履歴は英語版に準じています。

Changes from Revision C (June 2020) to Revision D (April 2022)	Page
• Changed input stage offset voltage specification for INA819DRG from 10 μV typical to 6 μV typical, and from 35 μV maximum to 30 μV maximum, in <i>Typical Characteristics</i>	6
• Changed maximum input stage offset voltage vs temperature specification for INA819DRG from 0.4 $\mu\text{V}/^\circ\text{C}$ to 0.35 $\mu\text{V}/^\circ\text{C}$ in <i>Typical Characteristics</i>	6
• Changed Figures 7-10 and 7-11 to correct units from nA to pA.....	8
• Changed input common-mode range calculator link from outdated Common-Mode Input Range Calculator for Instrumentation Amplifiers to Analog Engineers Calculator.....	22
Changes from Revision B (July 2019) to Revision C (June 2020)	Page
• DRG (WSON) パッケージおよび関連する内容をデータシートに追加.....	1
• Added row for thermal pad to <i>Pin Functions</i> table	4
• Added bullet regarding exposed thermal pad to end of <i>Layout Guidelines</i> section	32
Changes from Revision A (May 2019) to Revision B (July 2019)	Page
• DGK (VSSOP) パッケージを事前情報 (プレビュー) から量産データ (アクティブ) に変更.....	1
Changes from Revision * (December 2018) to Revision A (April 2019)	Page
• 8ピン DGK (VSSOP) 事前情報パッケージおよび関連する内容をデータシートに追加.....	1
• 「アプリケーション」の箇条書きを変更.....	1

5 Device Comparison Table

DEVICE	DESCRIPTION	GAIN EQUATION	RG PINS AT PIN
INA819	35- μ V Offset, 0.4- μ V/ $^{\circ}$ C V_{OS} Drift, 8-nV/ $\sqrt{\text{Hz}}$ Noise, Low-Power, Precision Instrumentation Amplifier	$G = 1 + 50 \text{ k}\Omega / R_G$	2, 3
INA818	35- μ V Offset, 0.4- μ V/ $^{\circ}$ C V_{OS} Drift, 8-nV/ $\sqrt{\text{Hz}}$ Noise, Low-Power, Precision Instrumentation Amplifier	$G = 1 + 50 \text{ k}\Omega / R_G$	1, 8
INA821	35- μ V Offset, 0.4- μ V/ $^{\circ}$ C V_{OS} Drift, 7-nV/ $\sqrt{\text{Hz}}$ Noise, High-Bandwidth, Precision Instrumentation Amplifier	$G = 1 + 49.4 \text{ k}\Omega / R_G$	2, 3
INA828	50- μ V Offset, 0.5- μ V/ $^{\circ}$ C V_{OS} Drift, 7-nV/ $\sqrt{\text{Hz}}$ Noise, Low-Power, Precision Instrumentation Amplifier	$G = 1 + 50 \text{ k}\Omega / R_G$	1, 8
INA333	25- μ V V_{OS} , 0.1- μ V/ $^{\circ}$ C V_{OS} Drift, 1.8-V to 5-V, RRO, 50- μ A I_Q , Chopper-Stabilized INA	$G = 1 + 100 \text{ k}\Omega / R_G$	1, 8
PGA280	20-mV to ± 10 -V Programmable Gain IA With 3-V or 5-V Differential Output; Analog Supply up to ± 18 V	Digital programmable	N/A
INA159	$G = 0.2$ V Differential Amplifier for ± 10 -V to 3-V and 5-V Conversion	$G = 0.2 \text{ V/V}$	N/A
PGA112	Precision Programmable Gain Op Amp With SPI	Digital programmable	N/A

6 Pin Configuration and Functions



图 6-1. D (8-Pin SOIC) and DGK (8-Pin VSSOP) Packages, Top View



图 6-2. DRG Package, 8-Pin WSON, Top View

表 6-1. Pin Functions

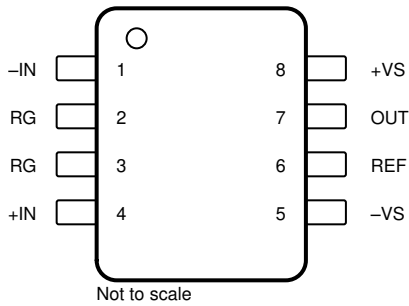
PIN		TYPE	DESCRIPTION
NAME	NO.		
-IN	1	Input	Negative (inverting) input
+IN	4	Input	Positive (noninverting) input
OUT	7	Output	Output
RG	2, 3	—	Gain setting pin. Place a gain resistor between pin 2 and pin 3.
REF	6	Input	Reference input. This pin must be driven by a low impedance source.
-VS	5	—	Negative supply
+VS	8	—	Positive supply
Thermal pad	—	—	Thermal pad internally connected to -VS. Connect externally to -VS or leave floating.

7 Specifications

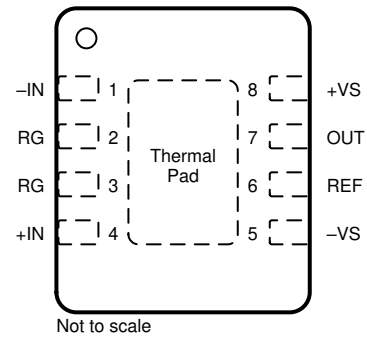
7.1 Absolute Maximum Ratings

over operating free-air temperature range (unless otherwise noted)⁽¹⁾

	MIN	MAX	UNIT
Supply voltage dual supply, $V_S = (V+) - (V-)$		±20	V
Supply voltage single supply, $V_S = (V+) - (V-)$		40	V
Signal input pins	-60	60	V
VREF pin	-20	20	V
Signal output pins maximum voltage	$(-V_S) - 0.5$	$(+V_S) + 0.5$	V
Signal output pins maximum current	-50	50	mA
Output short-circuit ⁽²⁾	Continuous		
Operating Temperature, T_A	-50	150	°C
Junction Temperature, T_J		175	°C
Storage Temperature, T_{stg}	-65	150	°C

- (1) Stresses beyond those listed under *Absolute Maximum Ratings* may cause permanent damage to the device. These are stress ratings only, which do not imply functional operation of the device at these or any other conditions beyond those indicated under *Recommended Operating Conditions*. Exposure to absolute-maximum-rated conditions for extended periods may affect device reliability.
- (2) Short-circuit to $V_S / 2$.

7.2 ESD Ratings

			VALUE	UNIT
$V_{(ESD)}$	Electrostatic discharge	Human-body model (HBM), per ANSI/ESDA/JEDEC JS-001 ⁽¹⁾	±1500	V
		Charged-device model (CDM), per JEDEC specification JESD22-C101 ⁽²⁾	±750	

- (1) JEDEC document JEP155 states that 500-V HBM allows safe manufacturing with a standard ESD control process.
- (2) JEDEC document JEP157 states that 250-V CDM allows safe manufacturing with a standard ESD control process.

7.3 Recommended Operating Conditions

over operating free-air temperature range (unless otherwise noted)

		MIN	MAX	UNIT
Supply voltage, V_S	Single-supply	4.5	36	V
	Dual-supply	±2.25	±18	
Specified temperature, T_A	Specified temperature	-40	125	°C

7.4 Thermal Information

THERMAL METRIC ⁽¹⁾		INA819			UNIT
		D (SOIC)	DGK (VSSOP)	DRG (WSON)	
		8 PINS	8 PINS	8 PINS	
$R_{\theta JA}$	Junction-to-ambient thermal resistance	119.6	215.4	55.6	°C/W
$R_{\theta JC(top)}$	Junction-to-case (top) thermal resistance	66.3	66.3	57.9	°C/W
$R_{\theta JB}$	Junction-to-board thermal resistance	61.9	97.8	28.6	°C/W
ψ_{JT}	Junction-to-top characterization parameter	20.5	10.5	1.8	°C/W
ψ_{JB}	Junction-to-board characterization parameter	61.4	96.1	28.6	°C/W
$R_{\theta JC(bot)}$	Junction-to-case (bottom) thermal resistance	N/A	N/A	12.1	°C/W

- (1) For more information about traditional and new thermal metrics, see the [Semiconductor and IC Package Thermal Metrics](#) application report.

7.5 Electrical Characteristics

at $T_A = 25^\circ\text{C}$, $V_S = \pm 15\text{ V}$, $R_L = 10\text{ k}\Omega$, $V_{\text{REF}} = 0\text{ V}$, and $G = 1$ (unless otherwise noted)

PARAMETER		TEST CONDITIONS	MIN	TYP	MAX	UNIT
INPUT						
V_{OSI}	Input stage offset voltage ^{(1) (3)}		INA819ID	10	35	μV
			INA819IDGK		40	
			INA819IDRG	6	30	
		$T_A = -40^\circ\text{C to } +125^\circ\text{C}^{(2)}$	INA819ID, INA819DRG		75	
			INA819IDGK		80	
			vs temperature, $T_A = -40^\circ\text{C to } +125^\circ\text{C}$	INA819D, INA819DGK		0.4
INA819DRG		0.35				
V_{OSO}	Output stage offset voltage ^{(1) (3)}			50	300	μV
			$T_A = -40^\circ\text{C to } +125^\circ\text{C}^{(2)}$		800	
		vs temperature, $T_A = -40^\circ\text{C to } +125^\circ\text{C}$			5	$\mu\text{V}/^\circ\text{C}$
PSRR	Power-supply rejection ratio	G = 1, RTI	110	120	dB	
		G = 10, RTI	114	130		
		G = 100, RTI	130	135		
		G = 1000, RTI	136	140		
Z_{id}	Differential impedance		100 1		$\text{G}\Omega \parallel \text{pF}$	
Z_{ic}	Common-mode impedance		100 4		$\text{G}\Omega \parallel \text{pF}$	
	RFI filter, -3-dB frequency			32	MHz	
V_{CM}	Operating input range ⁽⁴⁾	$V_S = \pm 2.25\text{ V to } \pm 18\text{ V}$, $T_A = -40^\circ\text{C to } +125^\circ\text{C}$	(V-) + 2		(V+) - 2	V
			See 7-51 through 7-54			
	Input overvoltage range	$T_A = -40^\circ\text{C to } +125^\circ\text{C}^{(2)}$			± 60	V
CMRR	Common-mode rejection ratio	At DC to 60 Hz, RTI, $V_{\text{CM}} = (V-) + 2\text{ V to } (V+) - 2\text{ V}$, G = 1	90	105	dB	
		At DC to 60 Hz, RTI, $V_{\text{CM}} = (V-) + 2\text{ V to } (V+) - 2\text{ V}$, G = 10	110	125		
		At DC to 60 Hz, RTI, $V_{\text{CM}} = (V-) + 2\text{ V to } (V+) - 2\text{ V}$, G = 100	130	145		
		At DC to 60 Hz, RTI, $V_{\text{CM}} = (V-) + 2\text{ V to } (V+) - 2\text{ V}$, G = 1000	140	150		
BIAS CURRENT						
I_B	Input bias current	$V_{\text{CM}} = V_S / 2$		0.15	0.5	nA
		$T_A = -40^\circ\text{C to } +125^\circ\text{C}$			2	
I_{OS}	Input offset current	$V_{\text{CM}} = V_S / 2$		0.15	0.5	nA
		$T_A = -40^\circ\text{C to } +125^\circ\text{C}$			2	
NOISE VOLTAGE						
e_{NI}	Input stage voltage noise ⁽⁶⁾	f = 1 kHz, G = 100, $R_S = 0\ \Omega$		8		$\text{nV}/\sqrt{\text{Hz}}$
		$f_B = 0.1\text{ Hz to } 10\text{ Hz}$, G = 100, $R_S = 0\ \Omega$		0.19		μV_{PP}
e_{NO}	Output stage voltage noise ⁽⁶⁾	f = 1 kHz, $R_S = 0\ \Omega$		80		$\text{nV}/\sqrt{\text{Hz}}$
		$f_B = 0.1\text{ Hz to } 10\text{ Hz}$, $R_S = 0\ \Omega$		2.6		μV_{PP}
I_n	Noise current	f = 1 kHz		130		$\text{fA}/\sqrt{\text{Hz}}$
		$f_B = 0.1\text{ Hz to } 10\text{ Hz}$, G = 100		4.7		pA_{PP}

7.5 Electrical Characteristics (continued)

at $T_A = 25^\circ\text{C}$, $V_S = \pm 15\text{ V}$, $R_L = 10\text{ k}\Omega$, $V_{REF} = 0\text{ V}$, and $G = 1$ (unless otherwise noted)

PARAMETER		TEST CONDITIONS	MIN	TYP	MAX	UNIT
GAIN						
	Gain equation		$1 + (50\text{ k}\Omega / R_G)$			V/V
G	Gain		1		10000	V/V
GE	Gain error	$G = 1, V_O = \pm 10\text{ V}$		$\pm 0.005\%$	$\pm 0.025\%$	
		$G = 10, V_O = \pm 10\text{ V}$		$\pm 0.025\%$	$\pm 0.15\%$	
		$G = 100, V_O = \pm 10\text{ V}$		$\pm 0.025\%$	$\pm 0.15\%$	
		$G = 1000, V_O = \pm 10\text{ V}$		$\pm 0.05\%$		
	Gain vs temperature ⁽⁵⁾	$G = 1, T_A = -40^\circ\text{C to } +125^\circ\text{C}$			± 5	ppm/ $^\circ\text{C}$
		$G > 1, T_A = -40^\circ\text{C to } +125^\circ\text{C}$			± 35	
	Gain nonlinearity	$G = 1\text{ to } 10, V_O = -10\text{ V to } +10\text{ V}, R_L = 10\text{ k}\Omega$		1	10	ppm
		$G = 100, V_O = -10\text{ V to } +10\text{ V}, R_L = 10\text{ k}\Omega$			15	
		$G = 1000, V_O = -10\text{ V to } +10\text{ V}, R_L = 10\text{ k}\Omega$		10		
		$G = 1\text{ to } 100, V_O = -10\text{ V to } +10\text{ V}, R_L = 2\text{ k}\Omega$		30		
OUTPUT						
	Voltage swing		$(V-) + 0.15$		$(V+) - 0.15$	V
	Load capacitance stability			1000		pF
Z_O	Closed-loop output impedance	$f = 10\text{ kHz}$		5.0		Ω
I_{SC}	Short-circuit current	Continuous to $V_S / 2$		± 20		mA
FREQUENCY RESPONSE						
BW	Bandwidth, -3 dB	$G = 1$		2.0		MHz
		$G = 10$		890		kHz
		$G = 100$		270		
		$G = 1000$		30		
SR	Slew rate	$G = 1, V_O = \pm 10\text{ V}$		0.9		V/ μs
t_s	Settling time	0.01%, $G = 1\text{ to } 100, V_{STEP} = 10\text{ V}$		12		μs
		0.01%, $G = 1000, V_{STEP} = 10\text{ V}$		40		
		0.001%, $G = 1\text{ to } 100, V_{STEP} = 10\text{ V}$		16		
		0.001%, $G = 1000, V_{STEP} = 10\text{ V}$		60		
REFERENCE INPUT						
R_{IN}	Input impedance			40		k Ω
	Voltage range		$(V-)$		$(V+)$	V
	Gain to output			1		V/V
	Reference gain error			0.01%		
POWER SUPPLY						
I_Q	Quiescent current	$V_{IN} = 0\text{ V}$		350	385	μA
		vs temperature, $T_A = -40^\circ\text{C to } +125^\circ\text{C}$			520	

- (1) Total offset, referred-to-input (RTI): $V_{OS} = (V_{OSI}) + (V_{OSO} / G)$.
- (2) Specified by characterization.
- (3) Offset drifts are uncorrelated. Input-referred offset drift is calculated using: $\Delta V_{OS(RTI)} = \sqrt{[\Delta V_{OSI}]^2 + (\Delta V_{OSO} / G)^2}$.
- (4) Input voltage range of the Instrumentation Amplifier input stage. The input range depends on the common-mode voltage, differential voltage, gain, and reference voltage.
- (5) The values specified for $G > 1$ do not include the effects of the external gain-setting resistor, R_G .
- (6) Total RTI voltage noise is equal to: $e_{N(RTI)} = \sqrt{[e_{NI}]^2 + (e_{NO} / G)^2}$.

7.6 Typical Characteristics

at $T_A = 25^\circ\text{C}$, $V_S = \pm 15\text{ V}$, $R_L = 10\text{ k}\Omega$, $V_{REF} = 0\text{ V}$, and $G = 1$ (unless otherwise noted)

表 7-1. Table of Graphs

DESCRIPTION	FIGURE
Typical Distribution of Input Stage Offset Voltage	图 7-1
Typical Distribution of Input Stage Offset Voltage Drift	图 7-2
Typical Distribution of Output Stage Offset Voltage	图 7-3
Typical Distribution of Output Stage Offset Voltage Drift	图 7-4
Input Stage Offset Voltage vs Temperature	图 7-5
Output Stage Offset Voltage vs Temperature	图 7-6
Typical Distribution of Input Bias Current, $T_A = 25^\circ\text{C}$	图 7-7
Typical Distribution of Input Bias Current, $T_A = 90^\circ\text{C}$	图 7-8
Typical Distribution of Input Offset Current	图 7-9
Input Bias Current vs Temperature	图 7-10
Input Offset Current vs Temperature	图 7-11
Typical CMRR Distribution, $G = 1$	图 7-12
Typical CMRR Distribution, $G = 10$	图 7-13
CMRR vs Temperature, $G = 1$	图 7-14
CMRR vs Temperature, $G = 10$	图 7-15
Input Current vs Input Overvoltage	图 7-16
CMRR vs Frequency (RTI)	图 7-17
CMRR vs Frequency (RTI, 1-k Ω source imbalance)	图 7-18
Positive PSRR vs Frequency (RTI)	图 7-19
Negative PSRR vs Frequency (RTI)	图 7-20
Gain vs Frequency	图 7-21
Voltage Noise Spectral Density vs Frequency (RTI)	图 7-22
Current Noise Spectral Density vs Frequency (RTI)	图 7-23
0.1-Hz to 10-Hz RTI Voltage Noise, $G = 1$	图 7-24
0.1-Hz to 10-Hz RTI Voltage Noise, $G = 1000$	图 7-25
0.1-Hz to 10-Hz RTI Current Noise	图 7-26
Input Bias Current vs Common-Mode Voltage	图 7-27
Typical Distribution of Gain Error, $G = 1$	图 7-28
Typical Distribution of Gain Error, $G = 10$	图 7-29
Gain Error vs Temperature, $G = 1$	图 7-30
Gain Error vs Temperature, $G = 10$	图 7-31
Supply Current vs Temperature	图 7-32
Gain Nonlinearity, $G = 1$	图 7-33
Gain Nonlinearity, $G = 10$	图 7-34
Offset Voltage vs Negative Common-Mode Voltage	图 7-35
Offset Voltage vs Positive Common-Mode Voltage	图 7-36
Positive Output Voltage Swing vs Output Current	图 7-37
Negative Output Voltage Swing vs Output Current	图 7-38
Short Circuit Current vs Temperature	图 7-39
Large-Signal Frequency Response	图 7-40

7.6 Typical Characteristics

at $T_A = 25^\circ\text{C}$, $V_S = \pm 15\text{ V}$, $R_L = 10\text{ k}\Omega$, $V_{REF} = 0\text{ V}$, and $G = 1$ (unless otherwise noted)

表 7-1. Table of Graphs (continued)

DESCRIPTION	FIGURE
THD+N vs Frequency	图 7-41
Overshoot vs Capacitive Loads	图 7-42
Small-Signal Response, $G = 1$	图 7-43
Small-Signal Response, $G = 10$	图 7-44
Small-Signal Response, $G = 100$	图 7-45
Small-Signal Response, $G = 1000$	图 7-46
Large Signal Step Response	图 7-47
Closed-Loop Output Impedance	图 7-48
Differential-Mode EMI Rejection Ratio	图 7-49
Common-Mode EMI Rejection Ratio	图 7-50
Input Common-Mode Voltage vs Output Voltage, $G = 1$, $V_S = 5\text{ V}$	图 7-51
Input Common-Mode Voltage vs Output Voltage, $G = 100$, $V_S = 5\text{ V}$	图 7-52
Input Common-Mode Voltage vs Output Voltage, $V_S = \pm 5\text{ V}$	图 7-53
Input Common-Mode Voltage vs Output Voltage, $V_S = \pm 15\text{ V}$	图 7-54

7.6 Typical Characteristics

at $T_A = 25^\circ\text{C}$, $V_S = \pm 15\text{ V}$, $R_L = 10\text{ k}\Omega$, $V_{REF} = 0\text{ V}$, and $G = 1$ (unless otherwise noted)

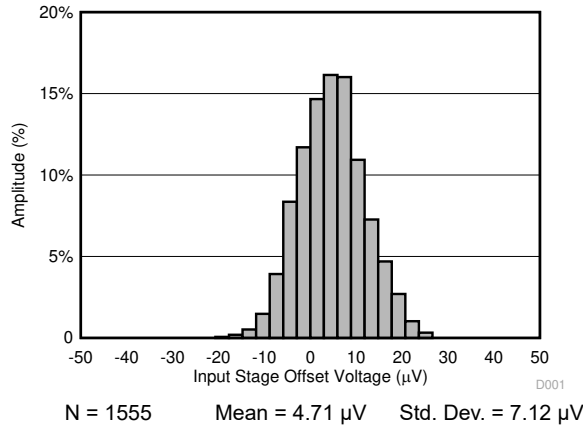

7-1. Typical Distribution of Input Stage Offset Voltage

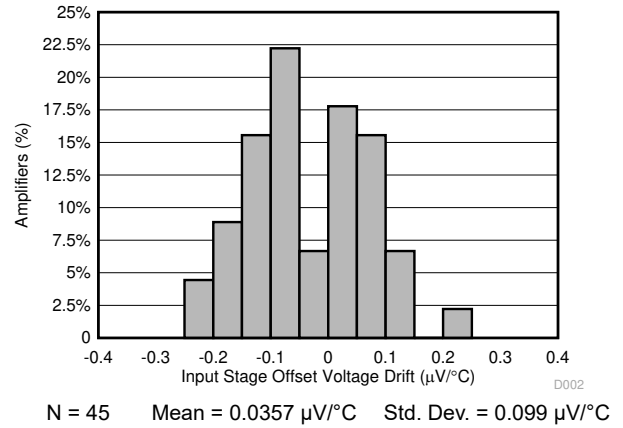

7-2. Typical Distribution of Input Stage Offset Voltage Drift

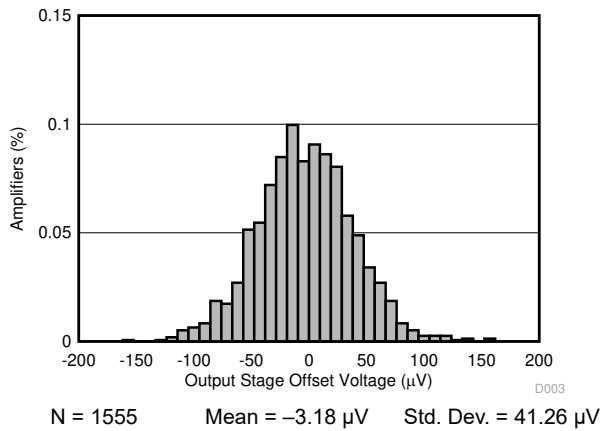

7-3. Typical Distribution of Output Stage Offset Voltage

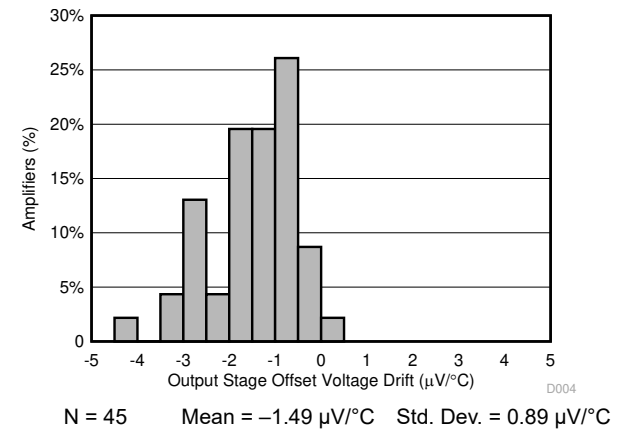

7-4. Typical Distribution of Output Stage Offset Voltage Drift

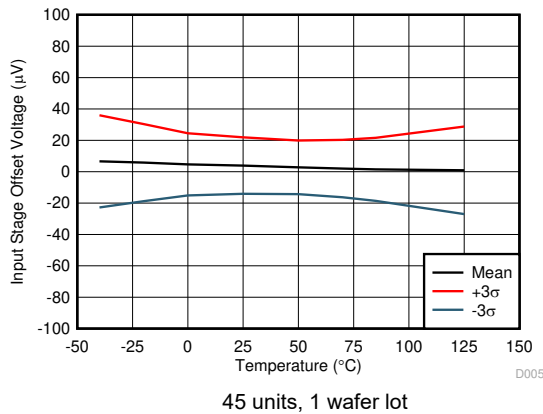

7-5. Input Stage Offset Voltage vs Temperature

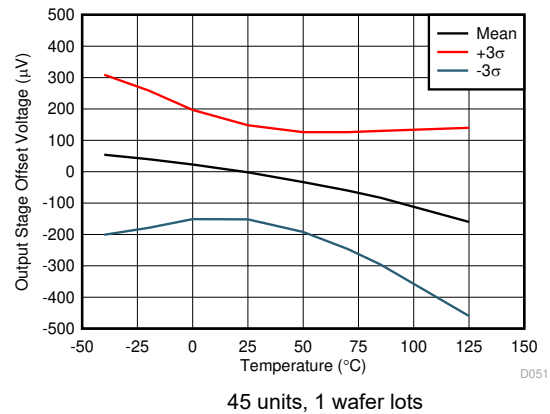

7-6. Output Stage Offset Voltage vs Temperature

7.6 Typical Characteristics (continued)

at $T_A = 25^\circ\text{C}$, $V_S = \pm 15\text{ V}$, $R_L = 10\text{ k}\Omega$, $V_{REF} = 0\text{ V}$, and $G = 1$ (unless otherwise noted)

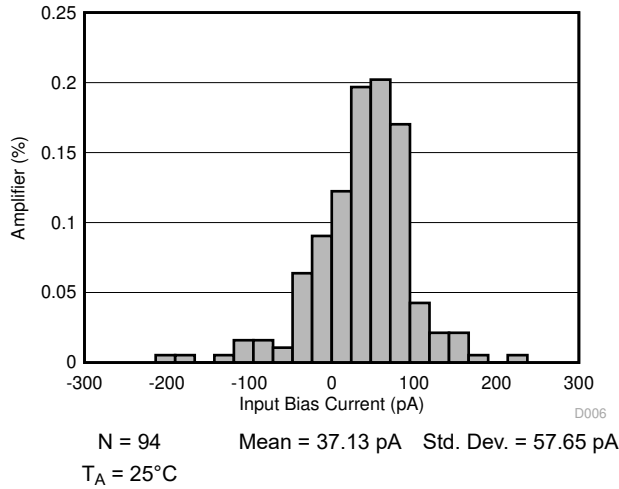

7-7. Typical Distribution of Input Bias Current

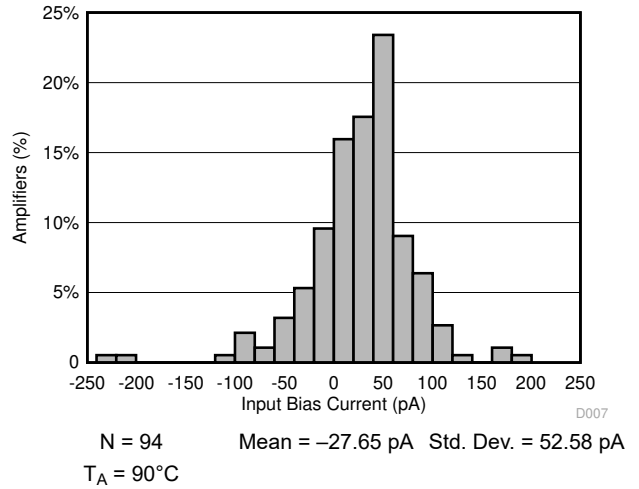

7-8. Typical Distribution of Input Bias Current

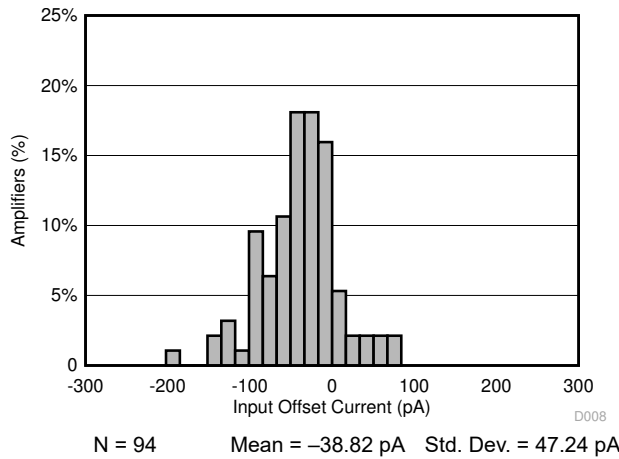

7-9. Typical Distribution of Input Offset Current

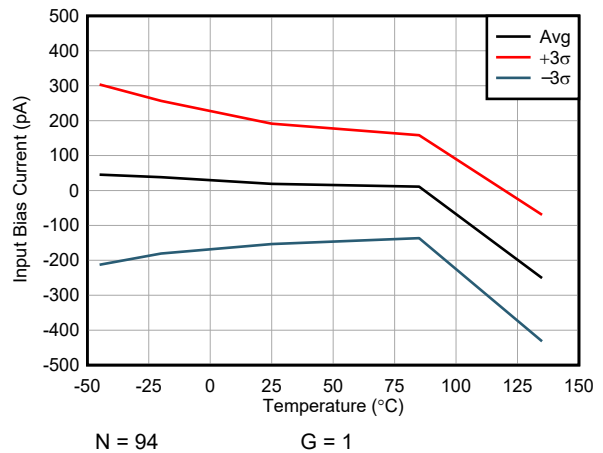

7-10. Input Bias Current vs Temperature

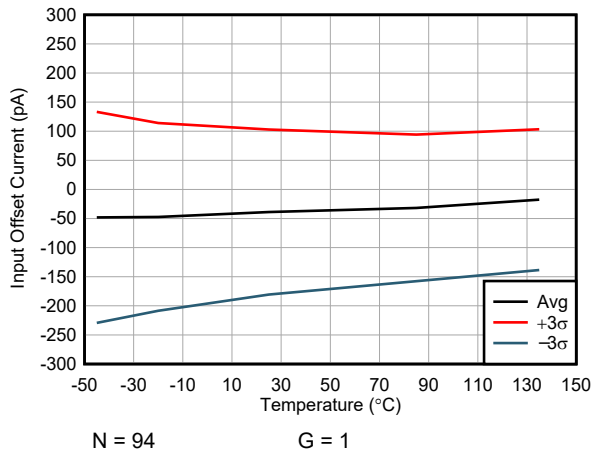

7-11. Input Offset Current vs Temperature

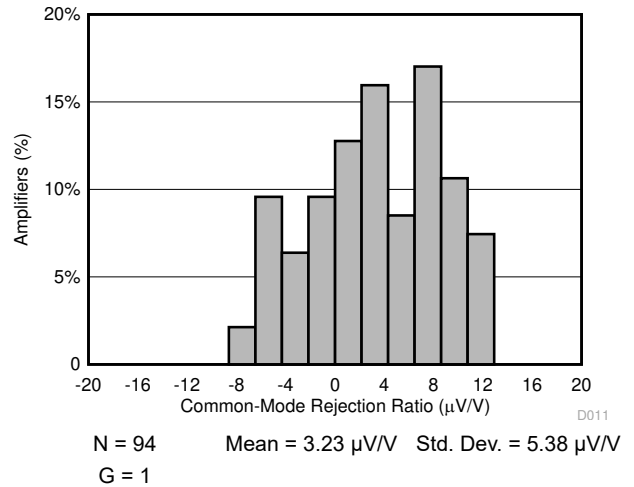

7-12. Typical CMRR Distribution

7.6 Typical Characteristics (continued)

at $T_A = 25^\circ\text{C}$, $V_S = \pm 15\text{ V}$, $R_L = 10\text{ k}\Omega$, $V_{REF} = 0\text{ V}$, and $G = 1$ (unless otherwise noted)

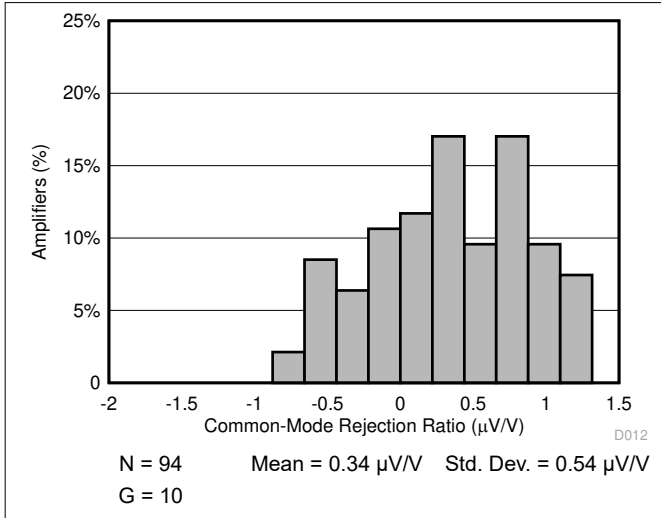

7-13. Typical CMRR Distribution

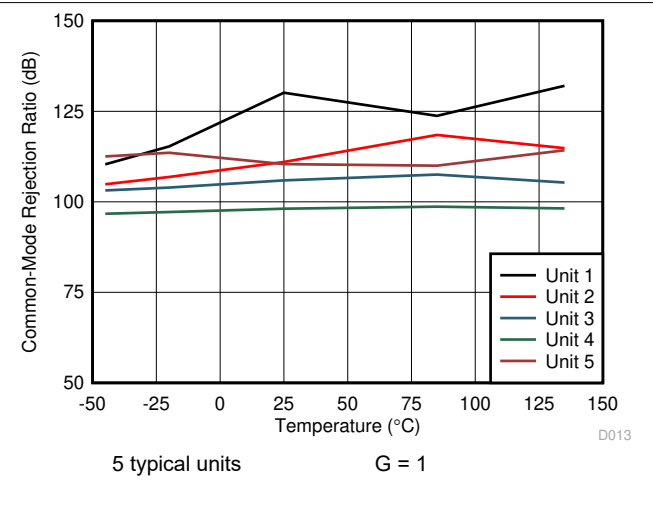

7-14. CMRR vs Temperature

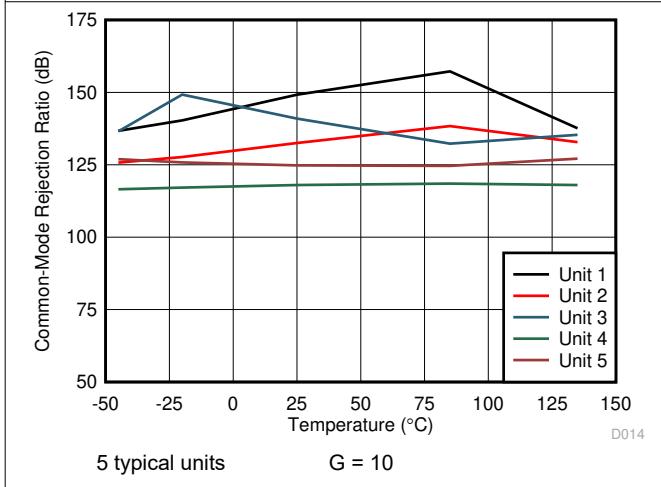

7-15. CMRR vs Temperature

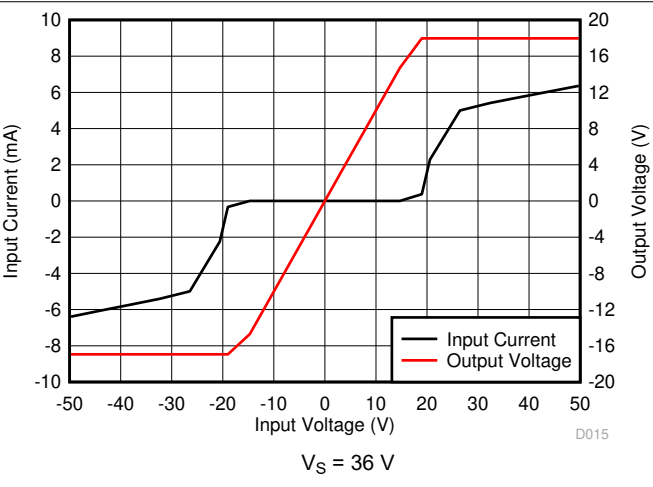

7-16. Input Current vs Input Overvoltage

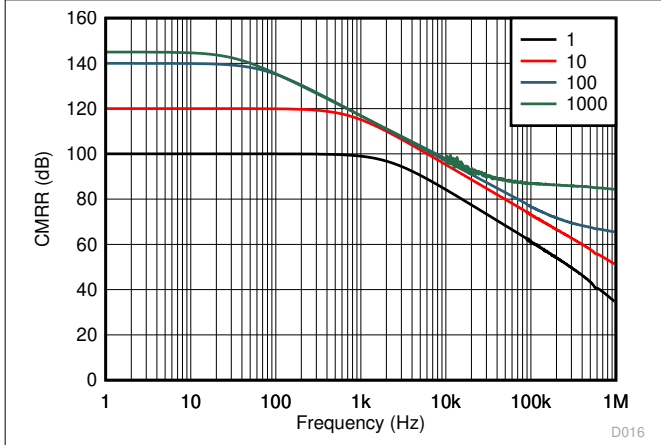

7-17. CMRR vs Frequency (RTI)

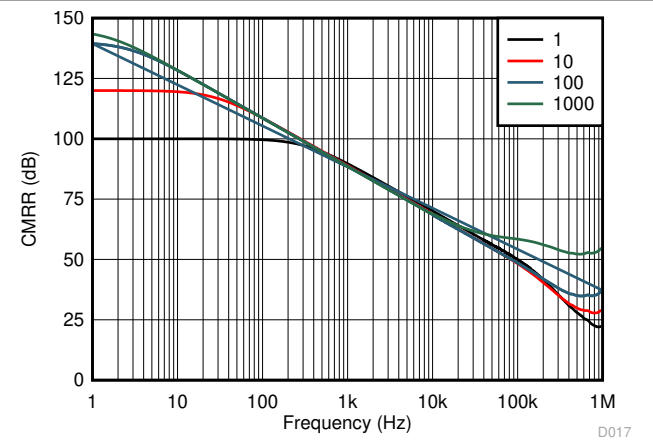

7-18. CMRR vs Frequency (RTI)

7.6 Typical Characteristics (continued)

at $T_A = 25^\circ\text{C}$, $V_S = \pm 15\text{ V}$, $R_L = 10\text{ k}\Omega$, $V_{REF} = 0\text{ V}$, and $G = 1$ (unless otherwise noted)

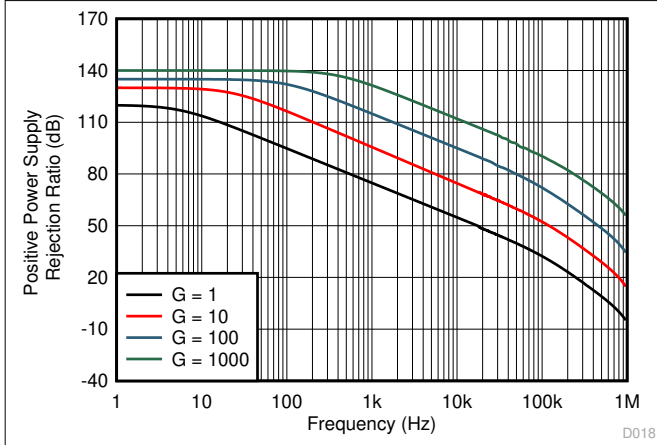

7-19. Positive PSRR vs Frequency (RTI)

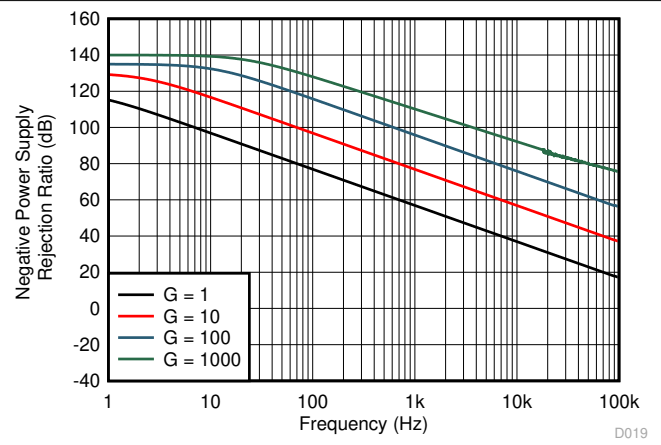

7-20. Negative PSRR vs Frequency (RTI)

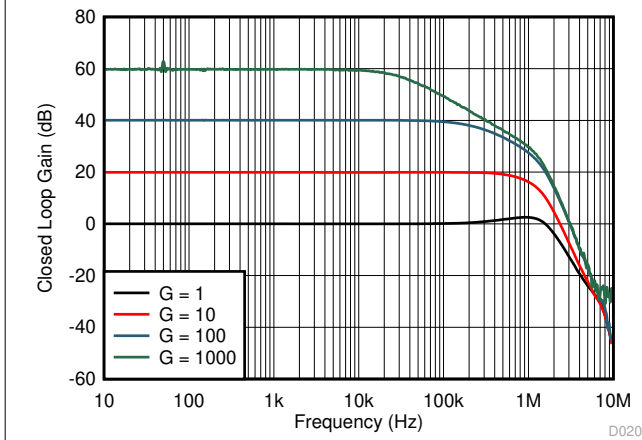

7-21. Gain vs Frequency

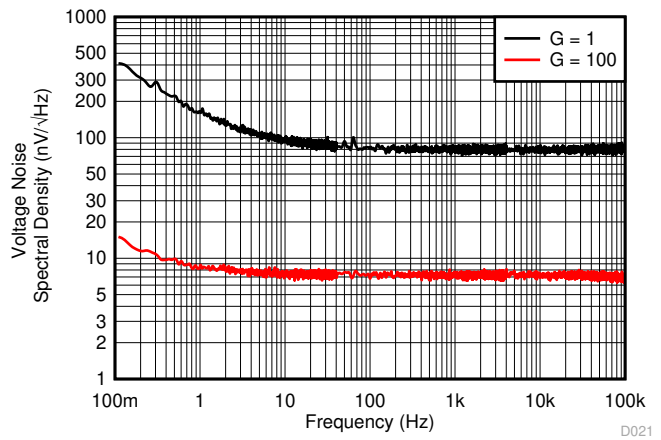

7-22. Voltage Noise Spectral Density vs Frequency (RTI)

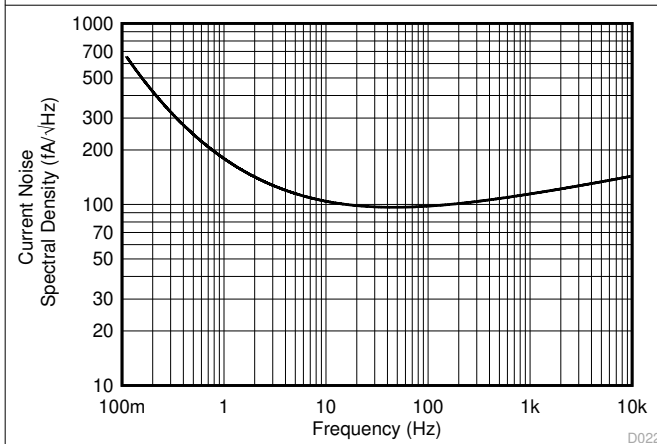

7-23. Current Noise Spectral Density vs Frequency (RTI)

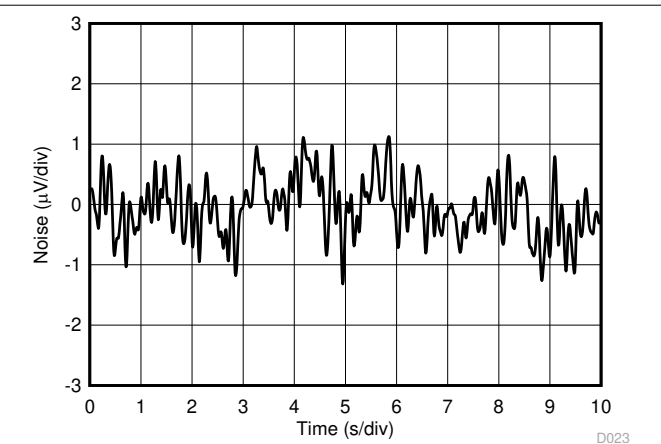

7-24. 0.1-Hz to 10-Hz RTI Voltage Noise

7.6 Typical Characteristics (continued)

at $T_A = 25^\circ\text{C}$, $V_S = \pm 15\text{ V}$, $R_L = 10\text{ k}\Omega$, $V_{REF} = 0\text{ V}$, and $G = 1$ (unless otherwise noted)

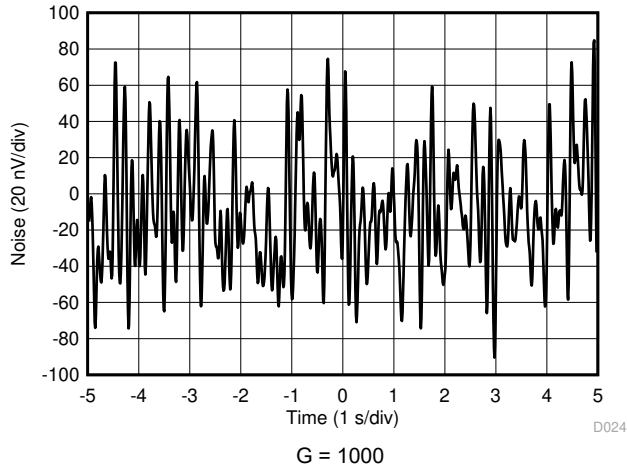

7-25. 0.1-Hz to 10-Hz RTI Voltage Noise

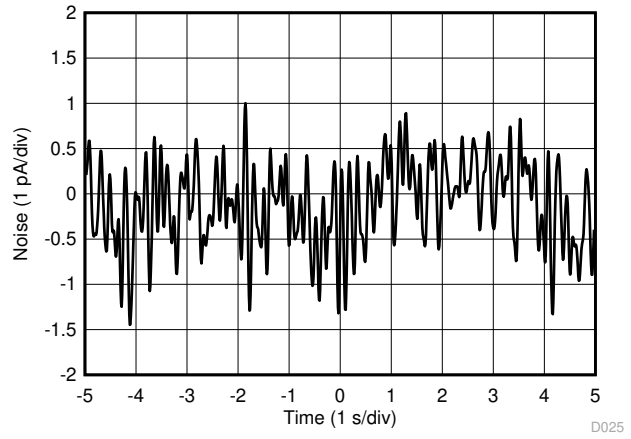

7-26. 0.1-Hz to 10-Hz RTI Current Noise

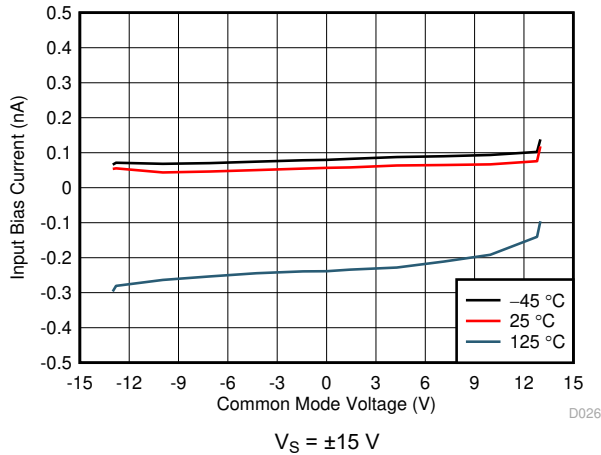

7-27. Input Bias Current vs Common-Mode Voltage

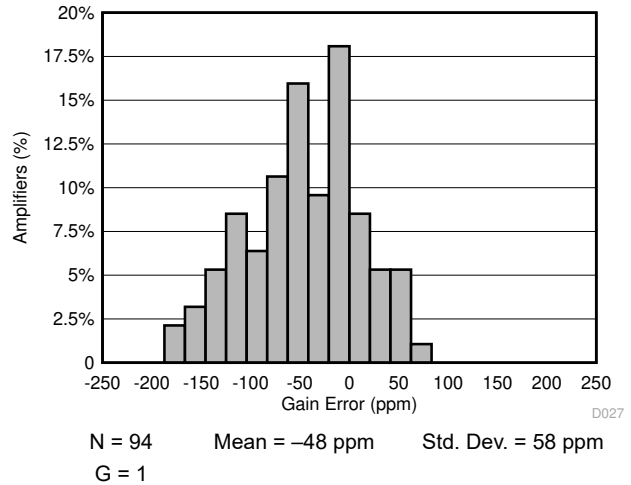

7-28. Typical Distribution of Gain Error, G = 1

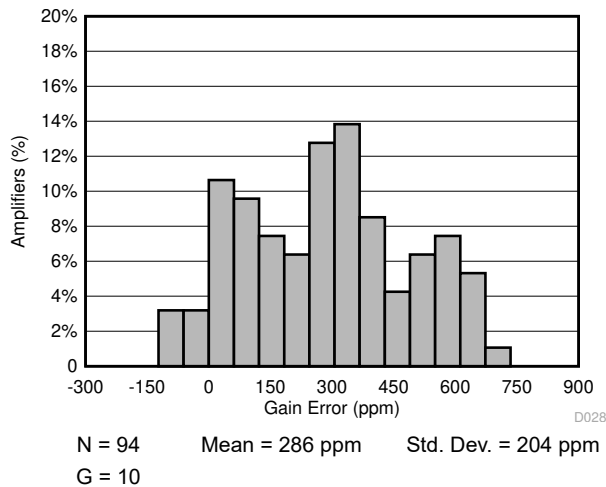

7-29. Typical Distribution of Gain Error, G = 10

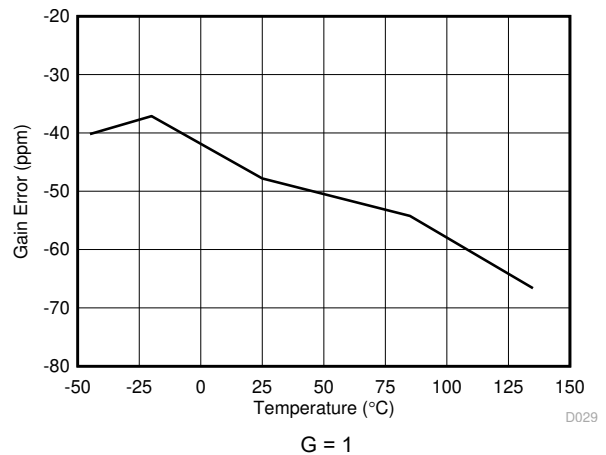

7-30. Gain Error vs Temperature

7.6 Typical Characteristics (continued)

at $T_A = 25^\circ\text{C}$, $V_S = \pm 15\text{ V}$, $R_L = 10\text{ k}\Omega$, $V_{REF} = 0\text{ V}$, and $G = 1$ (unless otherwise noted)

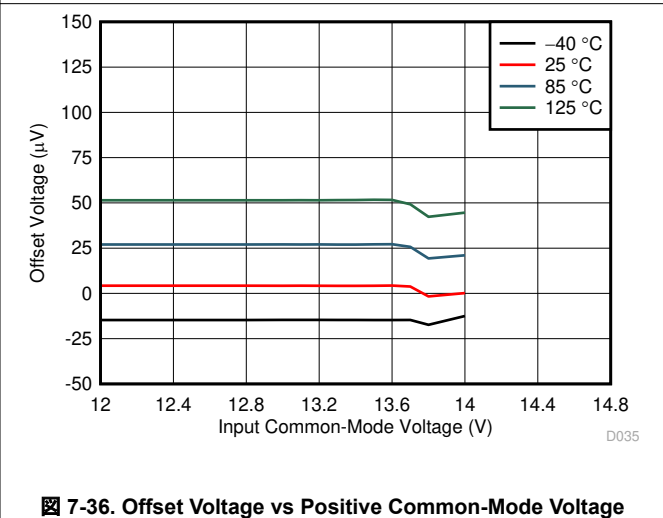
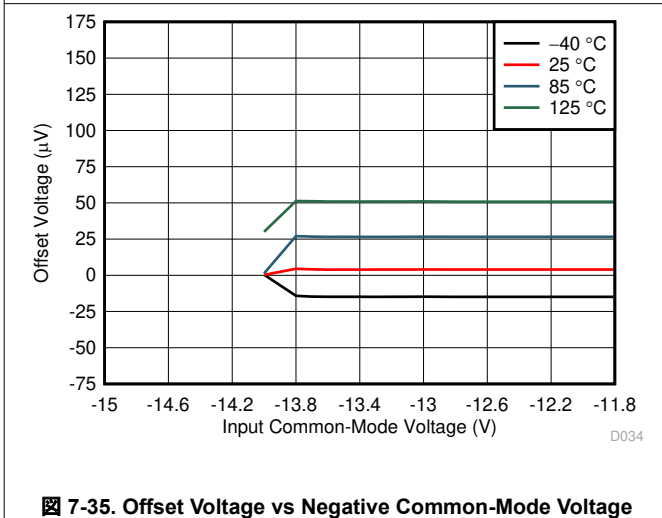
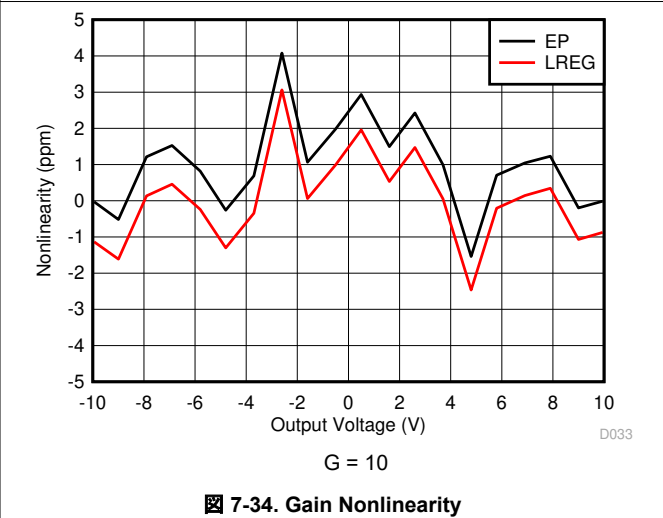
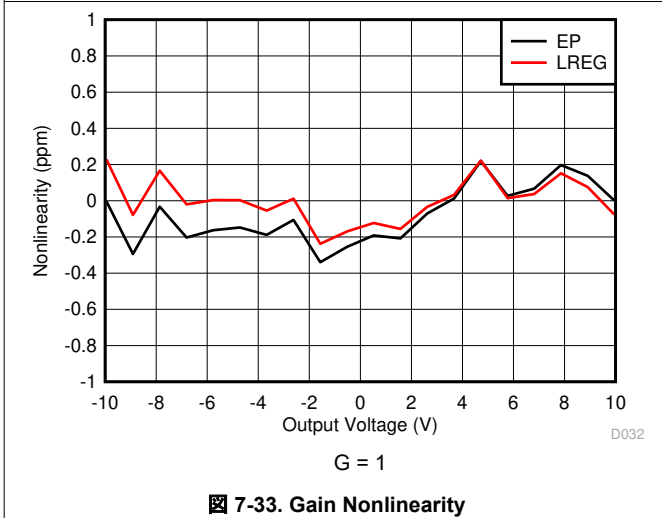
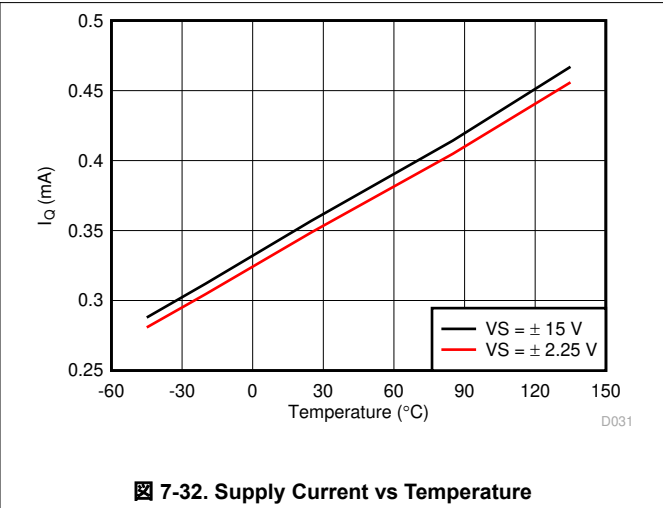
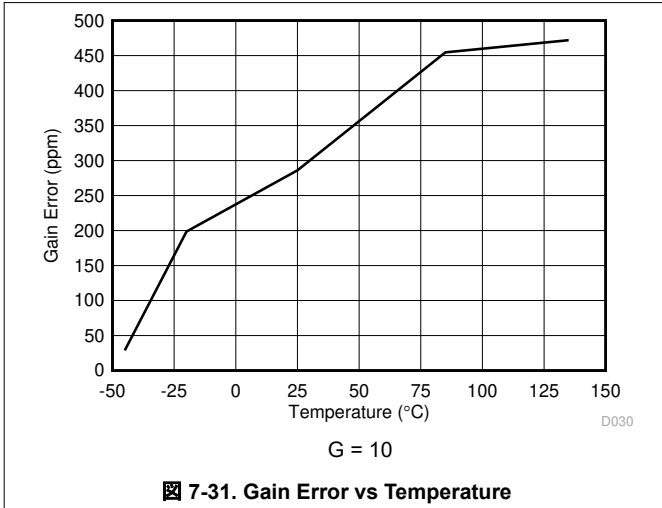

7.6 Typical Characteristics (continued)

at $T_A = 25^\circ\text{C}$, $V_S = \pm 15\text{ V}$, $R_L = 10\text{ k}\Omega$, $V_{REF} = 0\text{ V}$, and $G = 1$ (unless otherwise noted)

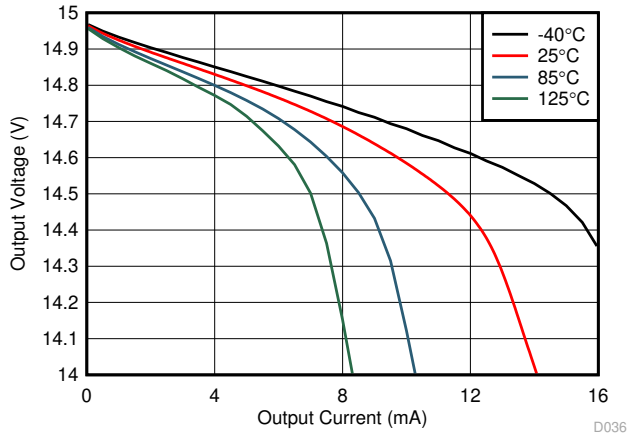

7-37. Positive Output Voltage Swing vs Output Current

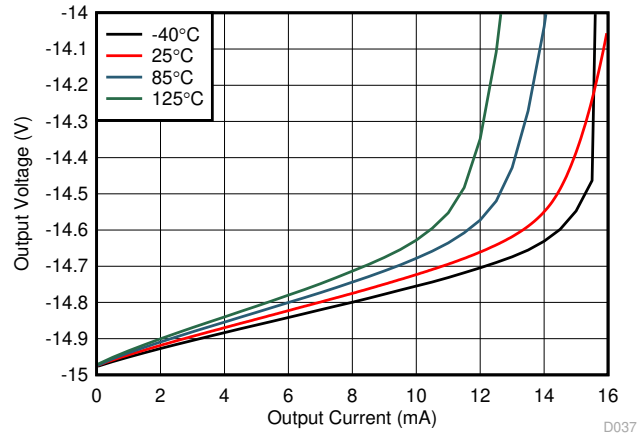

7-38. Negative Output Voltage Swing vs Output Current

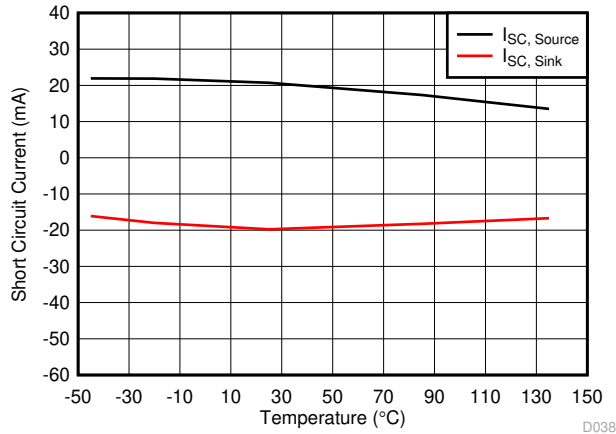

7-39. Short Circuit Current vs Temperature

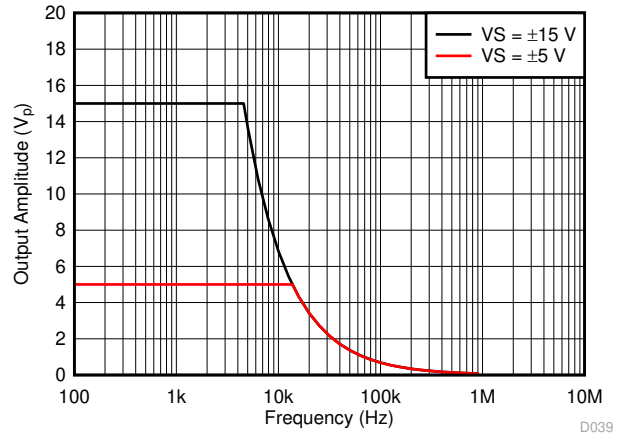

7-40. Large-Signal Frequency Response

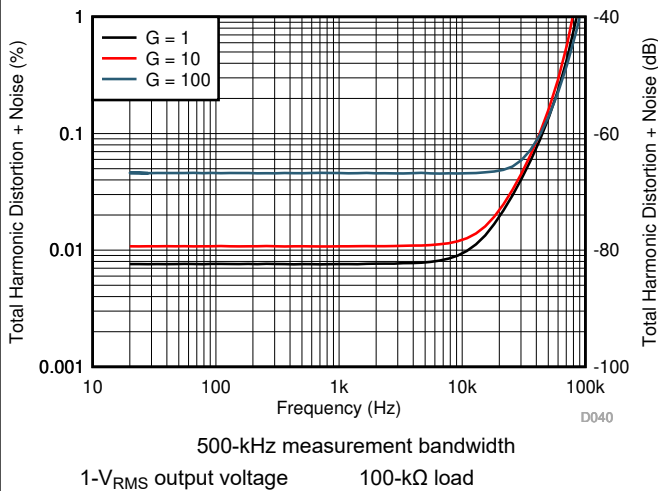

7-41. THD+N vs Frequency

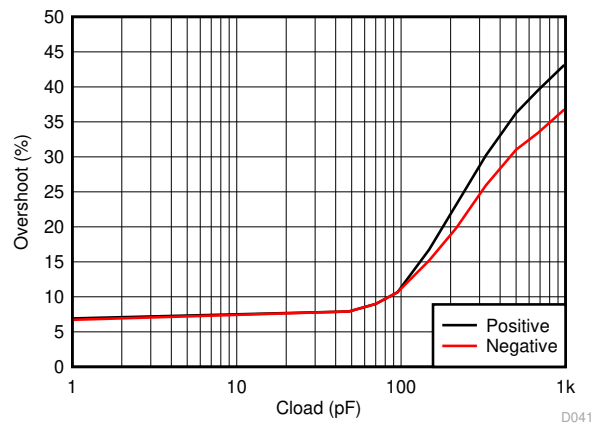

7-42. Overshoot vs Capacitive Loads

7.6 Typical Characteristics (continued)

at $T_A = 25^\circ\text{C}$, $V_S = \pm 15\text{ V}$, $R_L = 10\text{ k}\Omega$, $V_{REF} = 0\text{ V}$, and $G = 1$ (unless otherwise noted)

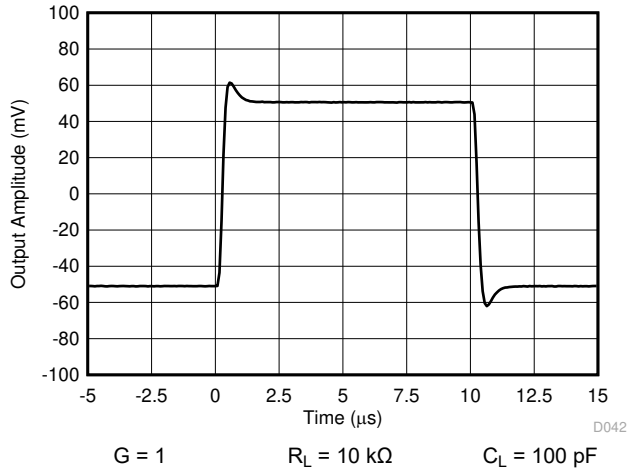

7-43. Small-Signal Response

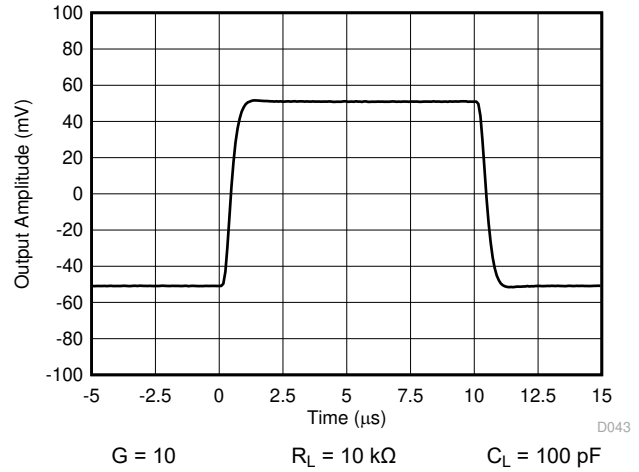

7-44. Small-Signal Response

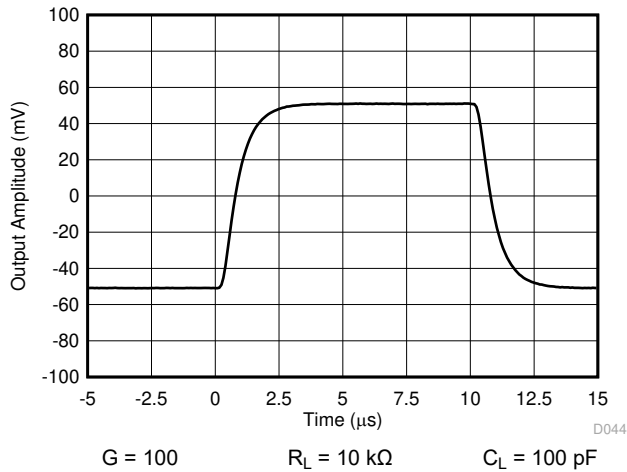

7-45. Small-Signal Response

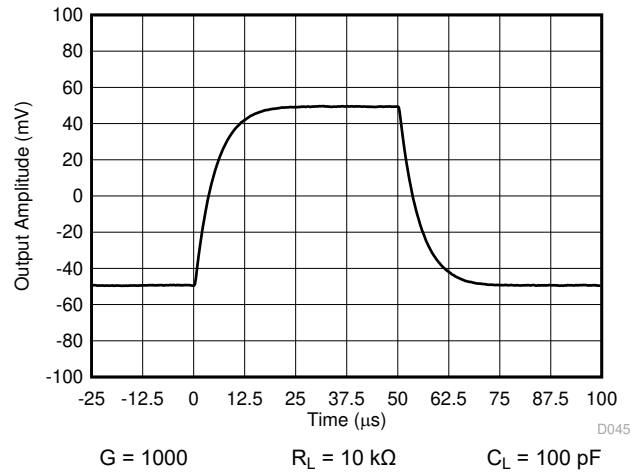

7-46. Small-Signal Response

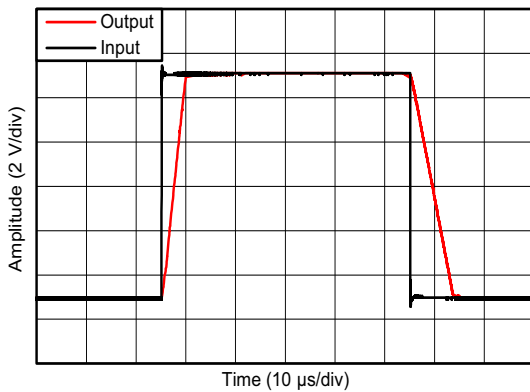

7-47. Large Signal Step Response

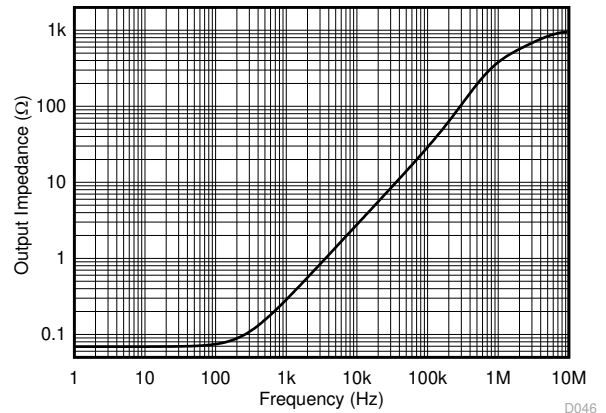

7-48. Closed-Loop Output Impedance

7.6 Typical Characteristics (continued)

at $T_A = 25^\circ\text{C}$, $V_S = \pm 15\text{ V}$, $R_L = 10\text{ k}\Omega$, $V_{REF} = 0\text{ V}$, and $G = 1$ (unless otherwise noted)

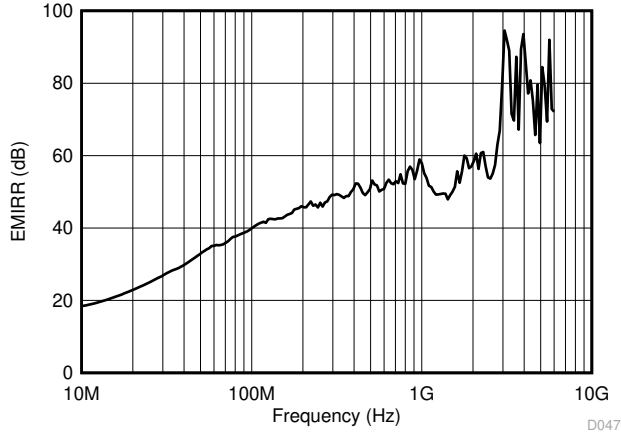

7-49. Differential-Mode EMI Rejection Ratio

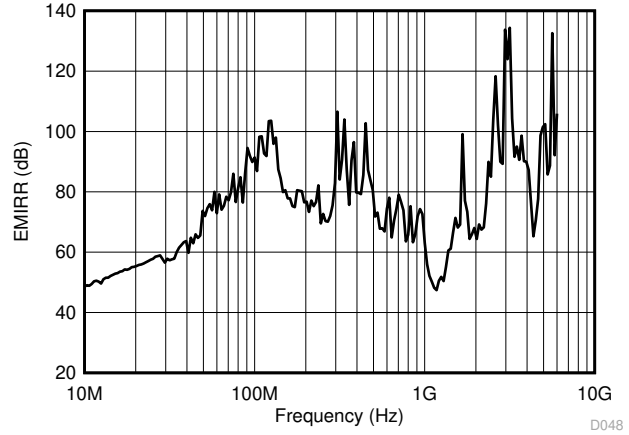

7-50. Common-Mode EMI Rejection Ratio

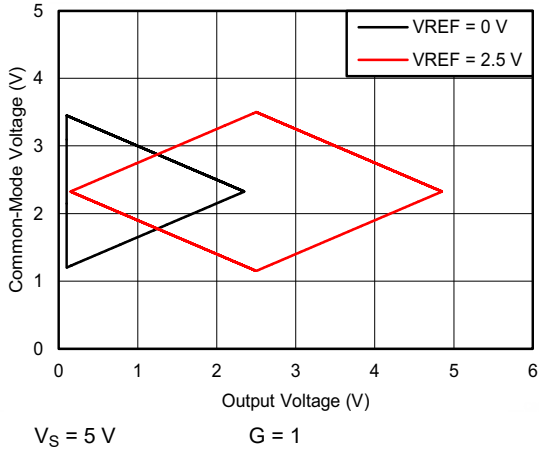

7-51. Input Common-Mode Voltage vs Output Voltage

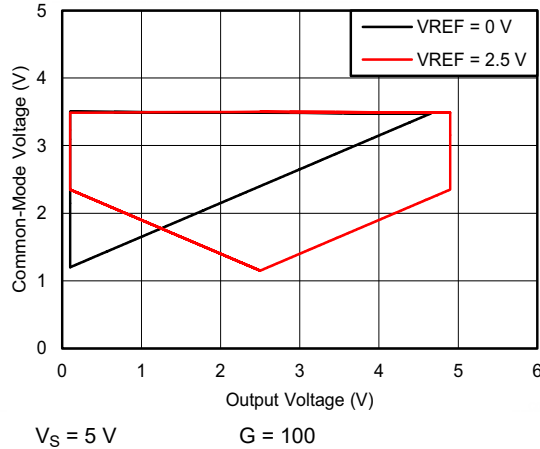

7-52. Input Common-Mode Voltage vs Output Voltage

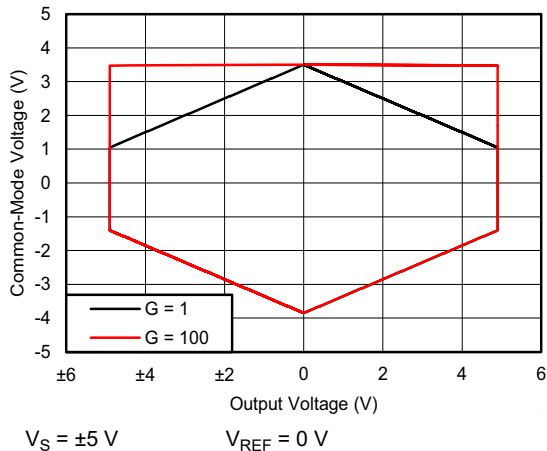

7-53. Input Common-Mode Voltage vs Output Voltage

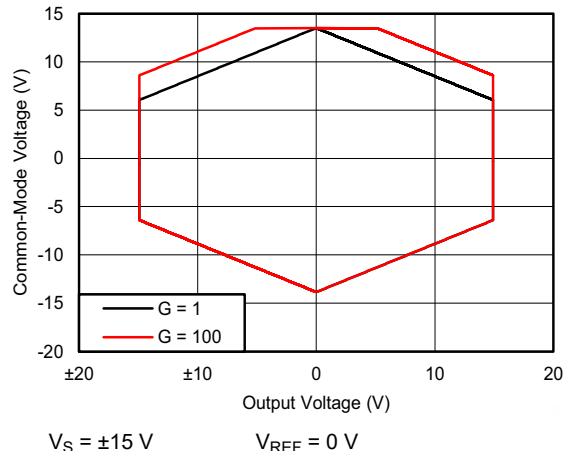

7-54. Input Common-Mode Voltage vs Output Voltage

8 Detailed Description

8.1 Overview

The INA819 is a monolithic precision instrumentation amplifier that incorporates a current-feedback input stage and a four-resistor difference amplifier output stage. The functional block diagram in the next section shows how the differential input voltage is buffered by Q_1 and Q_2 and is forced across R_G , which causes a signal current to flow through R_G , R_1 , and R_2 . The output difference amplifier, A_3 , removes the common-mode component of the input signal and refers the output signal to the REF pin. The V_{BE} and voltage drop across R_1 and R_2 produce output voltages on A_1 and A_2 that are approximately 0.8 V lower than the input voltages.

Each input is protected by two field-effect transistors (FETs) that provide a low series resistance under normal signal conditions, and preserve excellent noise performance. When excessive voltage is applied, these transistors limit input current to approximately 8 mA.

8.2 Functional Block Diagram

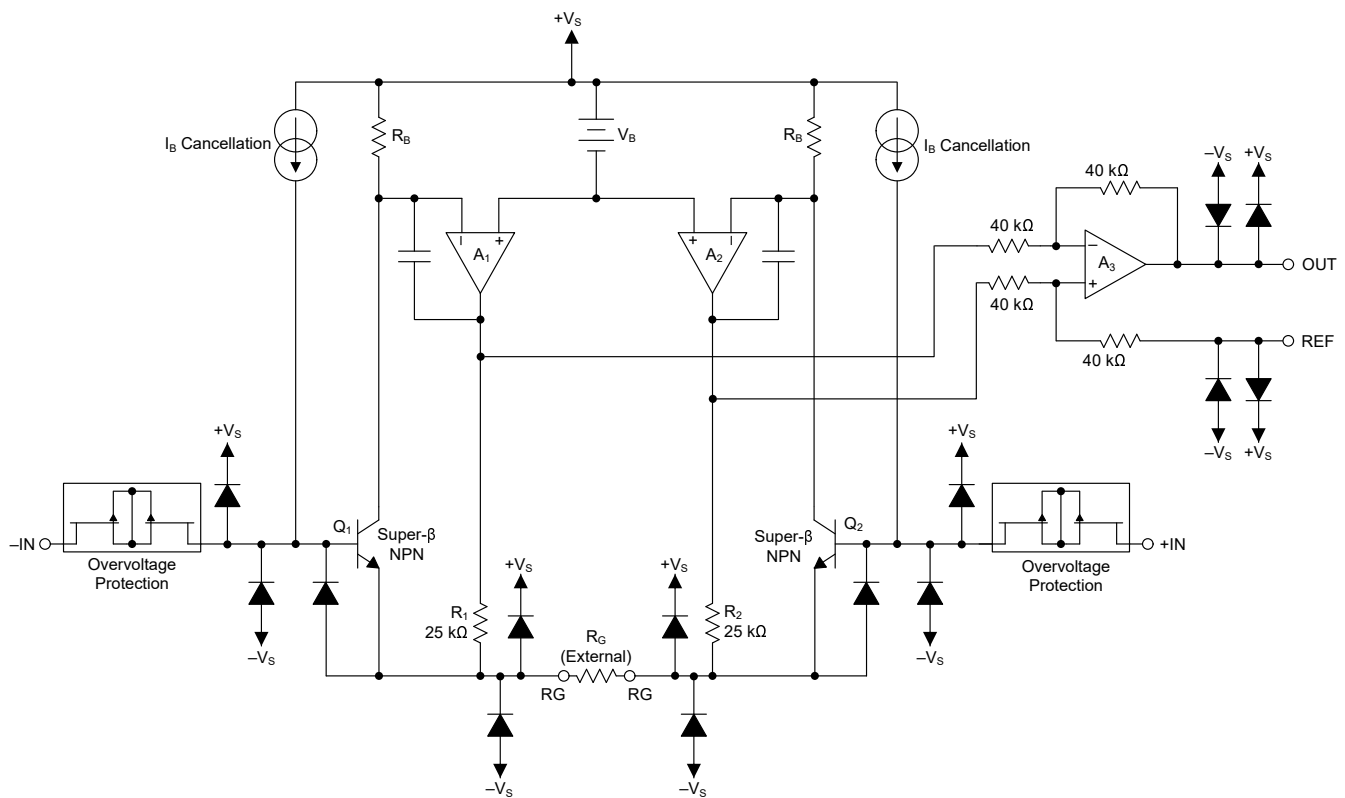

8.3 Feature Description

8.3.1 Setting the Gain

Figure 8-1 shows that the gain of the INA819 is set by a single external resistor (R_G) connected between the R_G pins (pins 1 and 8).

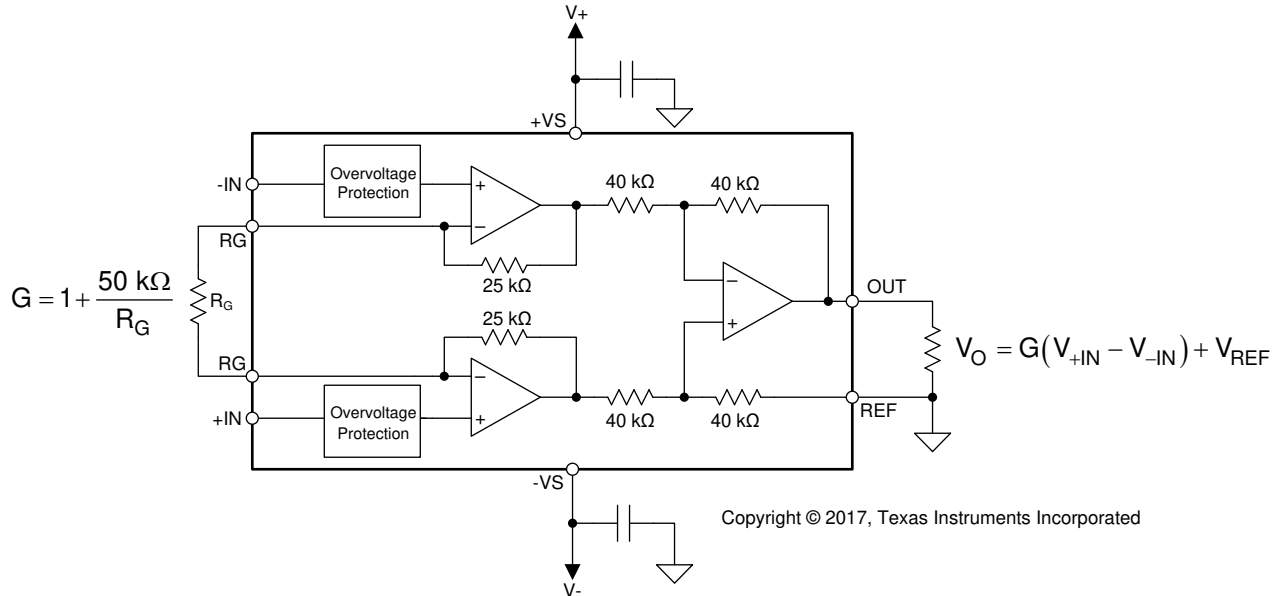

Figure 8-1. Simplified Diagram of the INA819 With Gain and Output Equations

The value of R_G is selected according to Equation 1:

$$G = 1 + \frac{50 \text{ k}\Omega}{R_G} \tag{1}$$

Table 8-1 lists several commonly used gains and resistor values. The 50-k Ω term in Equation 1 is a result of the sum of the two internal 25-k Ω feedback resistors. These on-chip resistors are laser-trimmed to accurate absolute values. The accuracy and temperature coefficients of these resistors are included in the gain accuracy and drift specifications of the INA819. As shown in Figure 8-1 and explained in more details in Section 11, make sure to connect low-ESR, 0.1- μ F ceramic bypass capacitors between each supply pin and ground that are placed as close to the device as possible.

Table 8-1. Commonly Used Gains and Resistor Values

DESIRED GAIN	R_G (Ω)	NEAREST 1% R_G (Ω)
1	NC	NC
2	50 k	49.9 k
5	12.5 k	12.4 k
10	5.556 k	5.49 k
20	2.632 k	2.61 k
50	1.02 k	1.02 k
100	505.1	511
200	251.3	249
500	100.2	100
1000	50.05	49.9

8.3.1.1 Gain Drift

The stability and temperature drift of the external gain setting resistor (R_G) also affects gain. The contribution of R_G to gain accuracy and drift is determined from 式 1.

The best gain drift of 5 ppm/°C (maximum) is achieved when the INA819 uses $G = 1$ without R_G connected. In this case, gain drift is limited by the mismatch of the temperature coefficient of the integrated 40-kΩ resistors in the differential amplifier (A_3). At gains greater than 1, gain drift increases as a result of the individual drift of the 25-kΩ resistors in the feedback of A_1 and A_2 , relative to the drift of the external gain resistor (R_G .) The low temperature coefficient of the internal feedback resistors improves the overall temperature stability of applications using gains greater than 1 V/V over alternate solutions.

Low resistor values required for high gain make wiring resistance an important consideration. Sockets add to the wiring resistance and contribute additional gain error (such as a possible unstable gain error) at gains of approximately 100 or greater. To maintain stability, avoid parasitic capacitance of more than a few picofarads at R_G connections. Careful matching of any parasitics on the R_G pins maintains optimal CMRR over frequency; see 图 7-17.

8.3.2 EMI Rejection

Texas Instruments developed a method to accurately measure the immunity of an amplifier over a broad frequency spectrum extending from 10 MHz to 6 GHz. This method uses an EMI rejection ratio (EMIRR) to quantify the ability of the INA819 to reject EMI. The offset resulting from an input EMI signal is calculated using Equation 2:

$$\Delta V_{OS} = \left(\frac{V_{RF_PEAK}^2}{100 \text{ mV}_P} \right) \cdot 10^{-\left(\frac{EMIRR \text{ (dB)}}{20} \right)} \quad (2)$$

where

- V_{RF_PEAK} is the peak amplitude of the input EMI signal.

图 8-2 and 图 8-3 show the INA819 EMIRR graph for differential and common-mode EMI rejection across this frequency range. 表 8-2 lists the EMIRR values for the INA819 at frequencies commonly encountered in real-world applications. Applications listed in 表 8-2 are centered on or operated near the frequency shown. Depending on the end-system requirements, additional EMI filters may be required near the signal inputs of the system. Incorporating known good practices such as using short traces, low-pass filters, and damping resistors combined with parallel and shielded signal routing may be required.



表 8-2. INA819 EMIRR for Frequencies of Interest

FREQUENCY	APPLICATION OR ALLOCATION	DIFFERENTIAL EMIRR	COMMON-MODE EMIRR
400 MHz	Mobile radio, mobile satellite, space operation, weather, radar, ultrahigh-frequency (UHF) applications	52 dB	80 dB
900 MHz	Global system for mobile communications (GSM) applications, radio communication, navigation, GPS (up to 1.6 GHz), GSM, aeronautical mobile, UHF applications	55 dB	71 dB
1.8 GHz	GSM applications, mobile personal communications, broadband, satellite, L-band (1 GHz to 2 GHz)	58 dB	73 dB
2.4 GHz	802.11b, 802.11g, 802.11n, Bluetooth®, mobile personal communications, industrial, scientific and medical (ISM) radio band, amateur radio and satellite, S-band (2 GHz to 4 GHz)	59 dB	95 dB
3.6 GHz	Radiolocation, aero communication and navigation, satellite, mobile, S-band	78 dB	96 dB
5 GHz	802.11a, 802.11n, aero communication and navigation, mobile communication, space and satellite operation, C-band (4 GHz to 8 GHz)	70 dB	100 dB

8.3.3 Input Common-Mode Range

The linear input voltage range of the INA819 input circuitry extends within 1.5 volts (typical) of both power supplies and maintains excellent common-mode rejection throughout this range. The common-mode range for the most common operating conditions are shown in [Figure 8-4](#) to [Figure 8-7](#). The common-mode range for other operating conditions is best calculated using the [Analog Engineers Calculator](#).

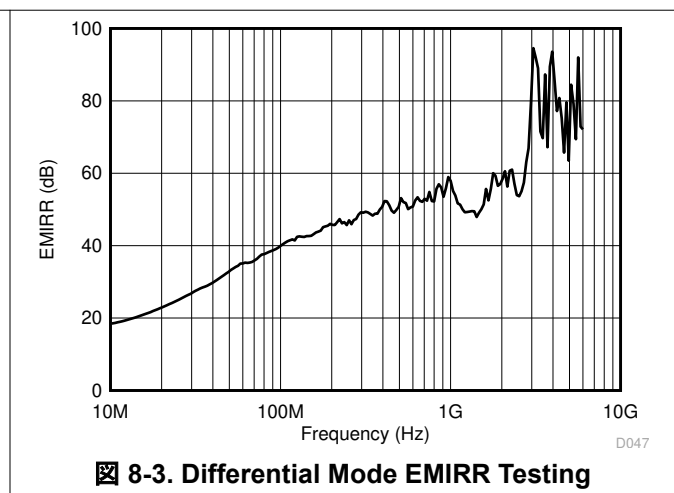
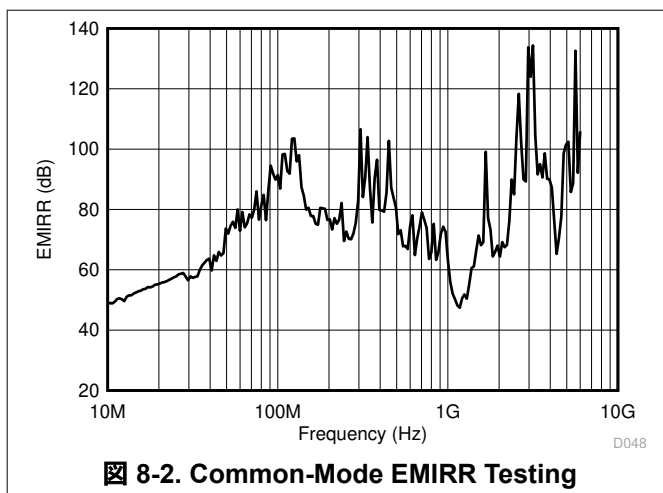
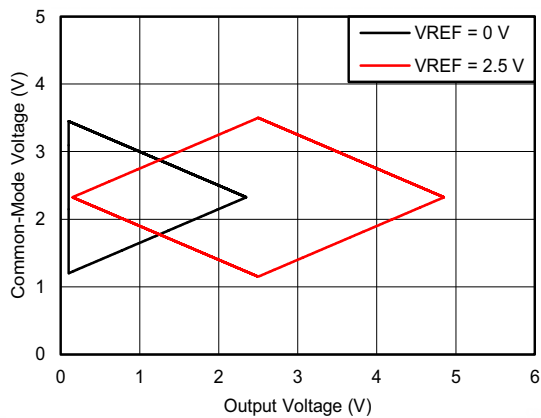

$V_S = 5\text{ V}$

$G = 1$

Figure 8-4. Input Common-Mode Voltage vs Output Voltage

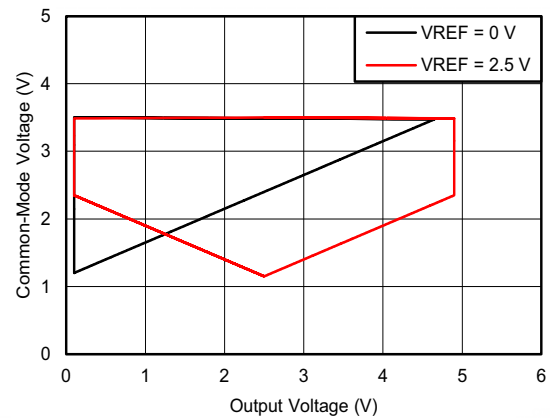

$V_S = 5\text{ V}$

$G = 100$

Figure 8-5. Input Common-Mode Voltage vs Output Voltage

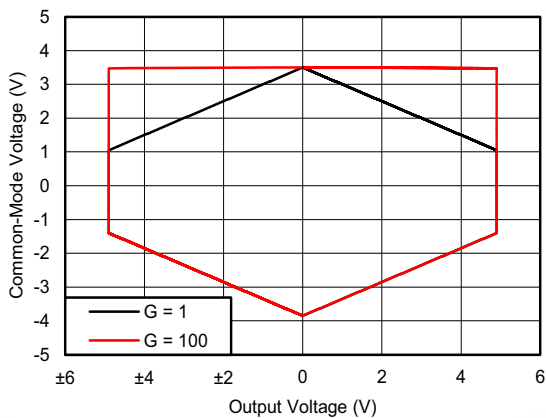

$V_S = \pm 5\text{ V}$

$V_{REF} = 0\text{ V}$

Figure 8-6. Input Common-Mode Voltage vs Output Voltage

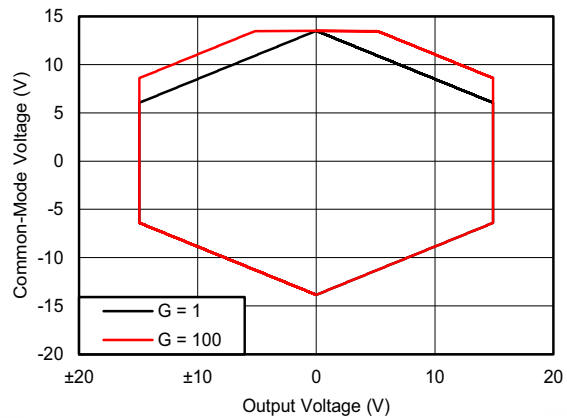

$V_S = \pm 15\text{ V}$

$V_{REF} = 0\text{ V}$

Figure 8-7. Input Common-Mode Voltage vs Output Voltage

8.3.4 Input Protection

The inputs of the INA819 device are individually protected for voltages up to ± 60 V. For example, a condition of -60 V on one input and $+60$ V on the other input does not cause damage. Internal circuitry on each input provides low series impedance under normal signal conditions. If the input is overloaded, the protection circuitry limits the input current to a value of approximately 8 mA.

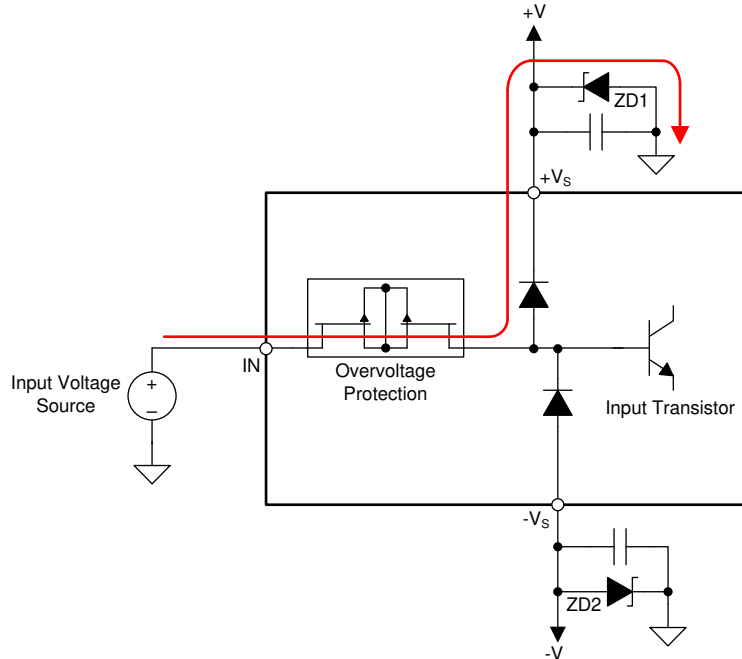

8-8. Input Current Path During an Overvoltage Condition

During an input overvoltage condition, current flows through the input protection diodes into the power supplies; see 8-8. If the power supplies are unable to sink current, then Zener diode clamps (ZD1 and ZD2 in 8-8) must be placed on the power supplies to provide a current pathway to ground. 8-9 shows the input current for input voltages from -50 V to 50 V when the INA819 is powered by ± 15 -V supplies.

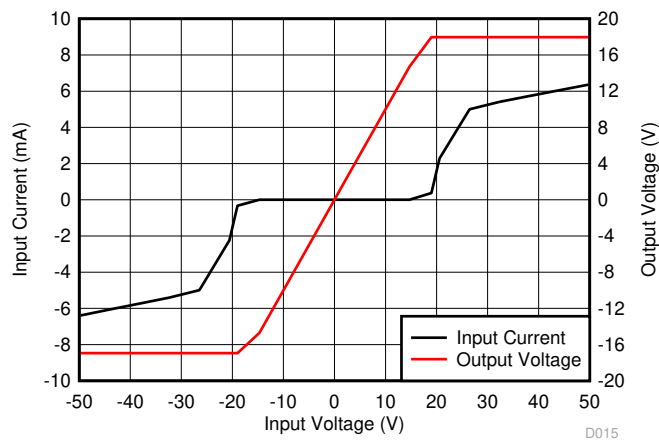

8-9. Input Current vs Input Overvoltage

8.3.5 Operating Voltage

The INA819 operates over a power-supply range of 4.5 V to 36 V (± 2.25 V to ± 18 V).

CAUTION

Supply voltages higher than 40 V (± 20 V) can permanently damage the device. Parameters that vary over supply voltage or temperature are shown in [セクション 7.6](#).

8.3.6 Error Sources

Most modern signal-conditioning systems calibrate errors at room temperature. However, calibration of errors that result from a change in temperature is normally difficult and costly. Therefore, minimize these errors by choosing high-precision components, such as the INA819, that have improved specifications in critical areas that impact the precision of the overall system. [図 8-10](#) shows an example application.



図 8-10. Example Application with $G = 10$ V/V and 1-V Output Voltage

Resistor-adjustable devices (such as the INA819) show the lowest gain error in $G = 1$ because of the inherently well-matched drift of the internal resistors of the differential amplifier. At gains greater than 1 (for instance, $G = 10$ V/V or $G = 100$ V/V), the gain error becomes a significant error source because of the contribution of the resistor drift of the 25-k Ω feedback resistors in conjunction with the external gain resistor. Except for very high gain applications, the gain drift is by far the largest error contributor compared to other drift errors, such as offset drift.

The INA819 offers excellent gain error over temperature for both $G > 1$ and $G = 1$ (no external gain resistor). [表 8-4](#) summarizes the major error sources in common INA applications and compares the three cases of $G = 1$ (no external resistor) and $G = 10$ (5.49-k Ω external resistor) and $G = 100$ (511- Ω external resistor). All calculations are assuming an output voltage of $V_{OUT} = 1$ V. Thus, the input signal V_{DIFF} (given by $V_{DIFF} = V_{OUT}/G$) exhibits smaller and smaller amplitudes with increasing gain G . In this example, $V_{DIFF} = 1$ mV at $G = 1000$. All calculations refer the error to the input for easy comparison and system evaluation. As [表 8-4](#) shows, errors generated by the input stage (such as input offset voltage) are more dominant at higher gain, while the effects of output stage are suppressed because they are divided by the gain when referring them back to the input. The gain error and gain drift error are much more significant for gains greater than 1 because of the contribution of the resistor drift of the 25-k Ω feedback resistors in conjunction with the external gain resistor. In most applications, static errors (absolute accuracy errors) can readily be removed during calibration in production, while the drift errors are the key factors limiting overall system performance.

表 8-3. System Specifications for Error Calculation

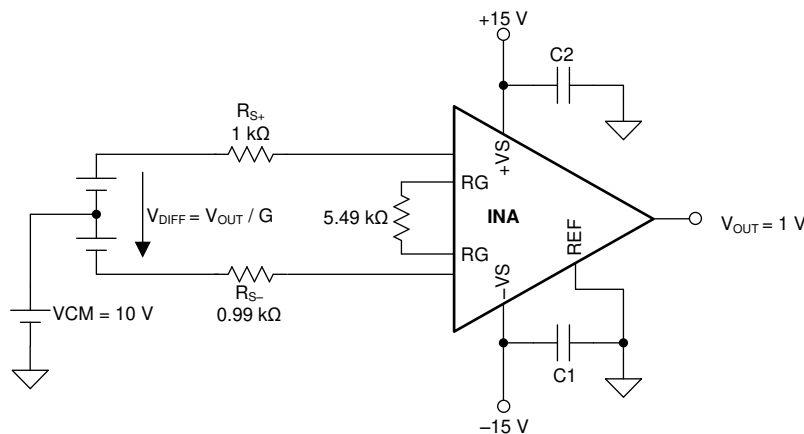
QUANTITY	VALUE	UNIT
V _{OUT}	1	V
V _{CM}	10	V
V _S	1	V
R _{S+}	1000	Ω
R _{S-}	999	Ω
RG tolerance	0.01	%
RG drift	10	ppm/°C
Temperature range upper limit	105	°C

表 8-4. Error Calculation

ERROR SOURCE	ERROR CALCULATION	INA819 VALUES				
		SPECIFICATION	UNIT	G = 1 ERROR (ppm)	G = 100 ERROR (ppm)	G = 1000 ERROR (ppm)
ABSOLUTE ACCURACY AT 25°C						
Input offset voltage	V _{OSI} / V _{DIFF}	35	μV	35	350	3500
Output offset voltage	V _{OSO} / (G × V _{DIFF})	300	μV	300	300	300
Input offset current	I _{OS} × maximum (R _{S+} , R _{S-}) / V _{DIFF}	0.5	nA	1	5	50
CMRR (min)	V _{CM} / (10 ^{CMRR/20} × V _{DIFF})	90 (G = 1), 110 (G = 10), 130 (G = 100)	dB	316	316	316
PSRR (min)	(V _{CC} - V _S) / (10 ^{PSRR/20} × V _{DIFF})	110 (G = 1), 114 (G = 10), 130 (G = 100)	dB	3	20	32
Gain error from INA (max)	GE(%) × 10 ⁴	0.02 (G = 1), 0.15 (G = 10, 100)	%	200	1500	1500
Gain error from external resistor RG (max)	GE(%) × 10 ⁴	0.01	%	100	100	100
Total absolute accuracy error (ppm) at 25°C, worst case	sum of all errors	—	—	955	2591	5798
Total absolute accuracy error (ppm) at 25°C, average	rms sum of all errors	—	—	491	1604	3835
DRIFT TO 105°C						
Gain drift from INA (max)	GTC × (T _A - 25)	5 (G = 1), 35 (G = 10, 100)	ppm/°C	400	2800	2800
Gain drift from external resistor RG (max)	GTC × (T _A - 25)	10	ppm/°C	800	800	800
Input offset voltage drift (max)	(V _{OSI_TC} / V _{DIFF}) × (T _A - 25)	0.4	μV/°C	32	320	3200
Output offset voltage drift	[V _{OSO_TC} / (G × V _{DIFF})] × (T _A - 25)	5	μV/°C	400	400	400
Offset current drift	I _{OS_TC} × maximum (R _{S+} , R _{S-}) × (T _A - 25) / V _{DIFF}	20	pA/°C	2	16	160
Total drift error to 105°C (ppm), worst case	sum of all errors	—	—	1634	4336	7360
Total drift error to 105°C (ppm), typical	rms sum of all errors	—	—	980	2957	4348
RESOLUTION						
Gain nonlinearity		10 (G = 1, 10), 15 (G = 100)	ppm of FS	10	10	15
Voltage noise (at 1 kHz)	$\sqrt{BW} \times \sqrt{(e_{NI})^2 + \left(\frac{e_{NO}}{G}\right)^2} \times \frac{6}{V_{DIFF}}$	e _{NI} = 8, e _{NO} = 90	μV _{PP}	1204	1070	3941
Current noise (at 1kHz)	I _N × maximum (R _{S+} , R _{S-}) × √BW / V _{DIFF}	0.13	pA/√Hz	0.3	2	11
Total resolution error (ppm), worst case	sum of all errors	—	—	1214	1080	3956
Total resolution error (ppm), typical	rms sum of all errors	—	—	1204	1070	3941
TOTAL ERROR						
Total error (ppm), worst case	sum of all errors	—	—	3802	8007	17113
Total error (ppm), typical	rms sum of all errors	—	—	1628	3530	7010

8.4 Device Functional Modes

The INA819 has a single functional mode and operates when the power-supply voltage is greater than 4.5 V (± 2.25 V). The maximum power-supply voltage for the INA819 is 36 V (± 18 V).

9 Application and Implementation

Note

以下のアプリケーション情報は、TI の製品仕様に含まれるものではなく、TI ではその正確性または完全性を保証いたしません。個々の目的に対する製品の適合性については、お客様の責任で判断していただくこととなります。お客様は自身の設計実装を検証しテストすることで、システムの機能を確認する必要があります。

9.1 Application Information

9.1.1 Reference Pin

The output voltage of the INA819 is developed with respect to the voltage on the reference pin (REF.) Often, in dual-supply operation, REF (pin 6) is connected to the low-impedance system ground. In single-supply operation, offsetting the output signal to a precise midsupply level is useful (for example, 2.5 V in a 5-V supply environment). To accomplish this level shift, a voltage source must be connected to the REF pin to level-shift the output so that the INA819 drives a single-supply analog-to-digital converter (ADC).

The voltage source applied to the reference pin must have a low output impedance. As shown in [Figure 9-1](#), any resistance at the reference pin (shown as R_{REF} in [Figure 9-1](#)) is in series with an internal 40-k Ω resistor.

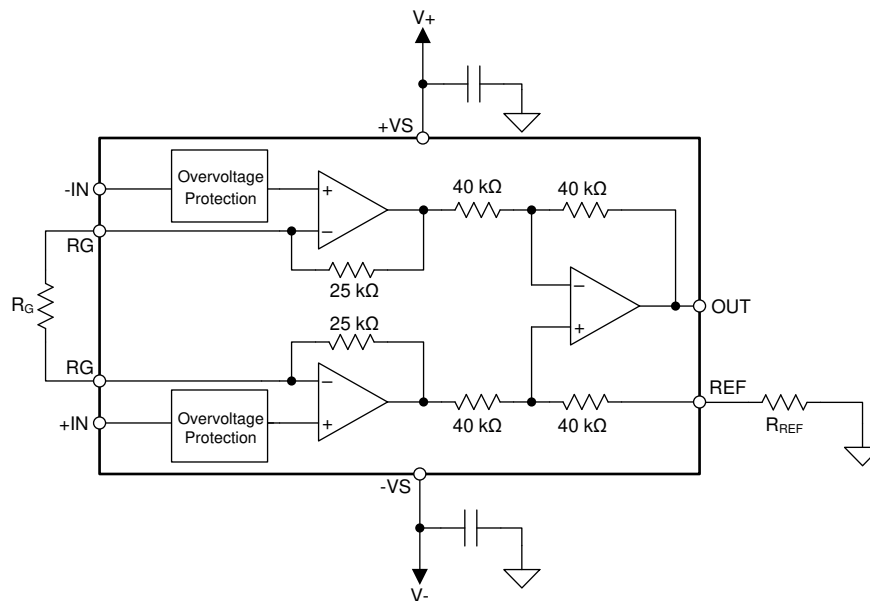

Figure 9-1. Parasitic Resistance Shown at the Reference Pin

The parasitic resistance at the reference pin (R_{REF}) creates an imbalance in the four resistors of the internal difference amplifier that results in a degraded common-mode rejection ratio (CMRR). [Figure 9-2](#) shows the degradation in CMRR of the INA819 as a result of increased resistance at the reference pin. For the best performance, keep the source impedance to the REF pin (R_{REF}) less than $5\ \Omega$.

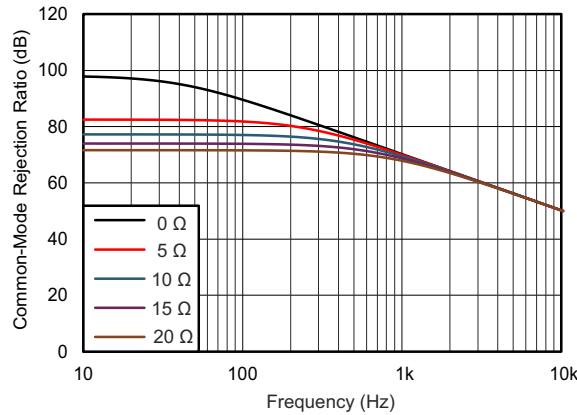
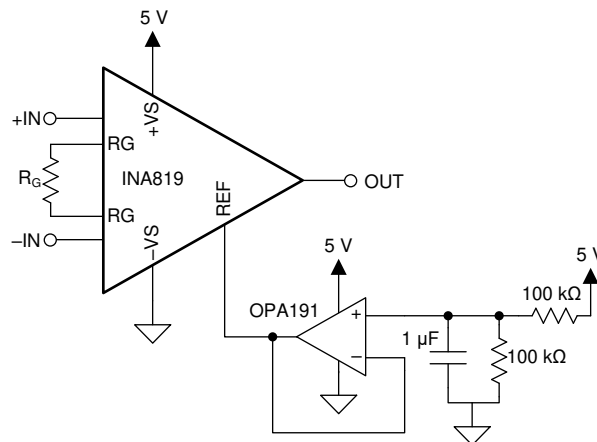

Figure 9-2. The Effect of Increasing Resistance at the Reference Pin

Voltage reference devices are an excellent option for providing a low-impedance voltage source for the reference pin. However, if a resistor voltage divider generates a reference voltage, the divider must be buffered by an op amp, as [Figure 9-3](#) shows, to avoid CMRR degradation.





Copyright © 2017, Texas Instruments Incorporated

Figure 9-3. Using an Op Amp to Buffer Reference Voltages

9.1.2 Input Bias Current Return Path

The input impedance of the INA819 is extremely high—approximately 100 GΩ. However, a path must be provided for the input bias current of both inputs. This input bias current is typically 150 pA. High input impedance means that this input bias current changes very little with varying input voltage.

For proper operation, input circuitry must provide a path for input bias current.  9-4 shows various provisions for an input bias current path. Without a bias current path, the inputs float to a potential that exceeds the common-mode range of the INA819, and the input amplifiers saturate. If the differential source resistance is low, the bias current return path can connect to one input (as shown in the thermocouple example in  9-4). With a higher source impedance, using two equal resistors provides a balanced input with possible advantages of a lower input offset voltage as a result of bias current and better high-frequency common-mode rejection.

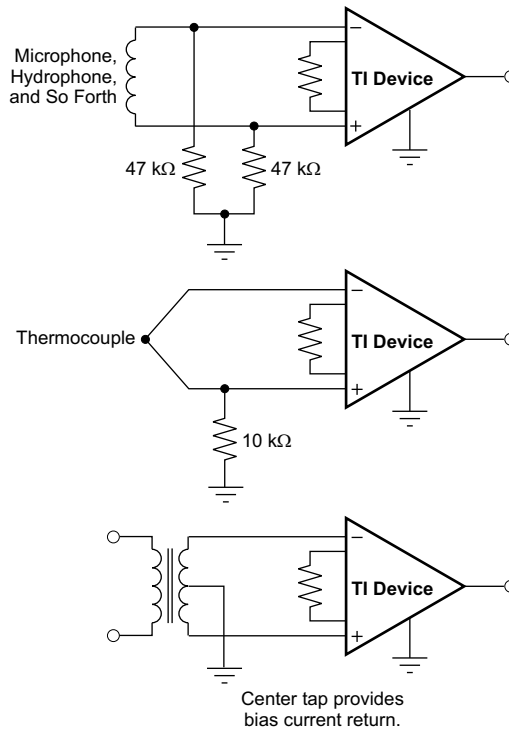

Copyright © 2017, Texas Instruments Incorporated

 9-4. Providing an Input Common-Mode Current Path

9.2 Typical Applications

9.2.1 Three-Pin Programmable Logic Controller (PLC)

Figure 9-5 shows a three-pin programmable-logic controller (PLC) design for the INA819. This PLC reference design accepts inputs of ± 10 V or ± 20 mA. The output is a single-ended voltage of 2.5 V ± 2.3 V (or 200 mV to 4.8 V). Many PLCs typically have these input and output ranges.

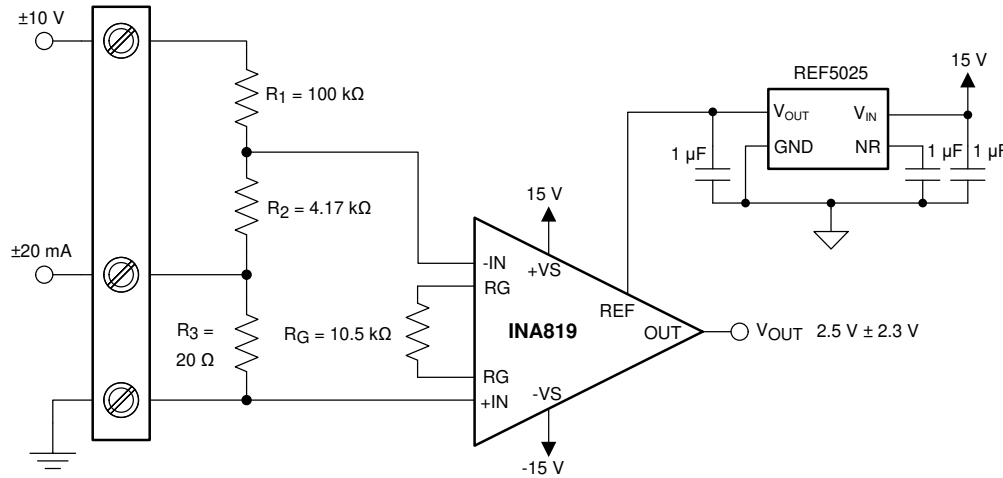

Copyright © 2018, Texas Instruments Incorporated

Figure 9-5. PLC Input (± 10 V, 4 mA to 20 mA)

9.2.1.1 Design Requirements

For this application, the design requirements are as follows:

- 4-mA to 20-mA input with less than 20- Ω burden
- ± 20 -mA input with less than 20- Ω burden
- ± 10 -V input with impedance of approximately 100 k Ω
- Maximum 4-mA to 20-mA or ± 20 -mA burden voltage equal to ± 0.4 V
- Output range within 0 V to 5 V

9.2.1.2 Detailed Design Procedure

There are two modes of operation for the circuit shown in Figure 9-5: current input and voltage input. This design requires $R_1 \gg R_2 \gg R_3$. Given this relationship, Equation 3 calculates the current input mode transfer function.

$$V_{OUT-I} = V_D \times G + V_{REF} = -(I_{IN} \times R_3) \times G + V_{REF} \quad (3)$$

where

- G represents the gain of the instrumentation amplifier.
- V_D represents the differential voltage at the INA819 inputs.
- V_{REF} is the voltage at the INA819 REF pin.
- I_{IN} is the input current.

Equation 4 shows the transfer function for the voltage input mode.

$$V_{OUT-V} = V_D \times G + V_{REF} = -\left[V_{IN} \times \frac{R_2}{R_1 + R_2}\right] \times G + V_{REF} \quad (4)$$

where

- V_{IN} is the input voltage.

R_1 sets the input impedance of the voltage input mode. The minimum typical input impedance is 100 k Ω . The R_1 value is 100 k Ω because increasing the R_1 value also increases noise. The value of R_3 must be extremely small compared to R_1 and R_2 . 20 Ω for R_3 is selected because that resistance value is much smaller than R_1 and yields an input voltage of ± 400 mV when operated in current mode (± 20 mA).

Use Equation 5 to calculate R_2 given $V_D = \pm 400$ mV, $V_{IN} = \pm 10$ V, and $R_1 = 100$ k Ω .

$$V_D = V_{IN} \times \frac{R_2}{R_1 + R_2} \rightarrow R_2 = \frac{R_1 \times V_D}{V_{IN} - V_D} = 4.167 \text{ k}\Omega \quad (5)$$

The value obtained from Equation 5 is not a standard 0.1% value, so 4.17 k Ω is selected. R_1 and R_2 also use 0.1% tolerance resistors to minimize error.

Use Equation 6 to calculate the ideal gain of the instrumentation amplifier.

$$G = \frac{V_{OUT} - V_{REF}}{V_D} = \frac{4.8 \text{ V} - 2.5 \text{ V}}{400 \text{ mV}} = 5.75 \frac{\text{V}}{\text{V}} \quad (6)$$

Equation 7 calculates the gain-setting resistor value using the INA819 gain equation (式 1).

$$R_G = \frac{50 \text{ k}\Omega}{G - 1} = \frac{50 \text{ k}\Omega}{5.75 - 1} = 10.5 \text{ k}\Omega \quad (7)$$

Use a standard 0.1% resistor value of 10.5 k Ω for this design.

9.2.1.3 Application Curves

Figure 9-6 and Figure 9-7 show typical characteristic curves for the circuit in Figure 9-5.

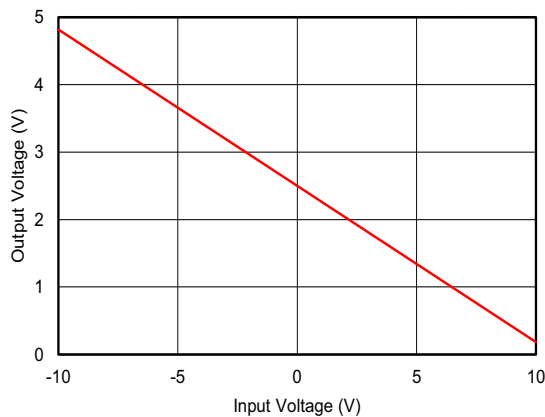

Figure 9-6. PLC Output Voltage vs Input Voltage

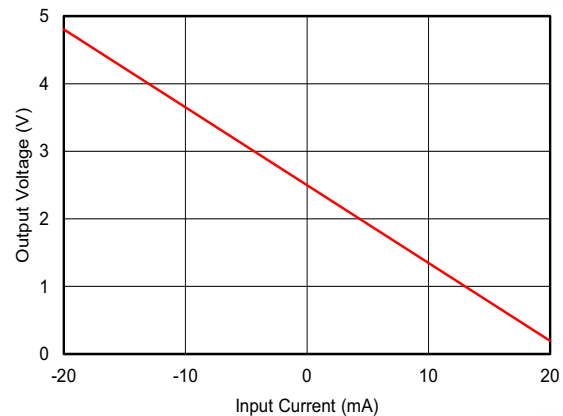
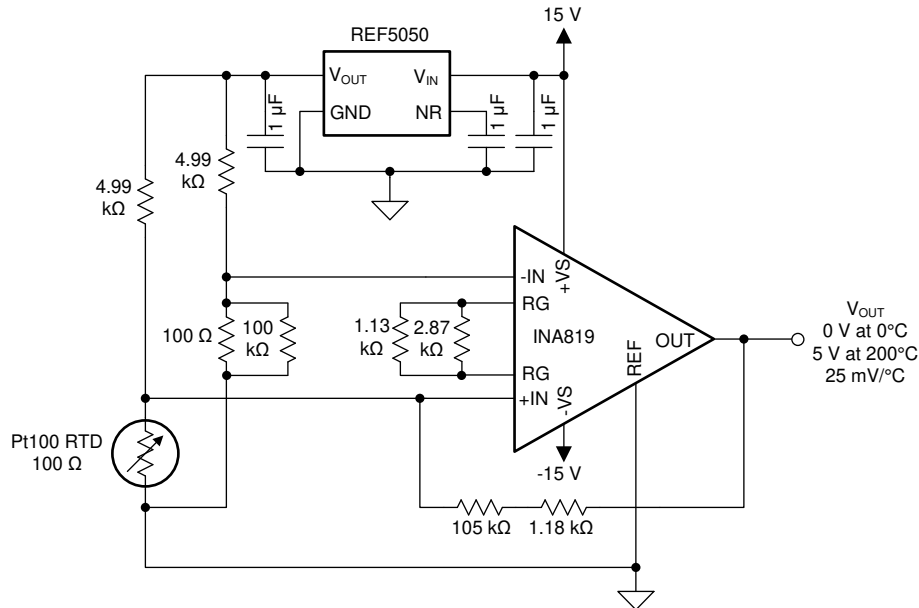

Figure 9-7. PLC Output Voltage vs Input Current

9.2.2 Resistance Temperature Detector Interface

Figure 9-8 illustrates a 3-wire interface circuit for resistance temperature detectors (RTDs). The circuit incorporates analog linearization and has an output voltage range from 0 V to 5 V. The linearization technique employed is described in *Analog linearization of resistance temperature detectors analog application journal*. Series and parallel combinations of standard 1% resistor values are used to achieve less than 0.02°C of error over a 200°C temperature span.



Copyright © 2018, Texas Instruments Incorporated

Figure 9-8. A 3-Wire Interface for RTDs With Analog Linearization

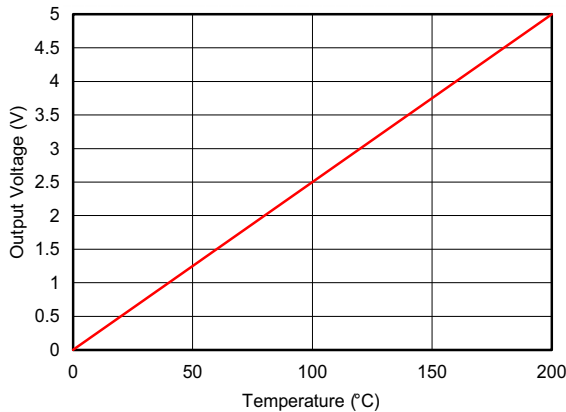

Figure 9-9. Transfer Function of a 3-Wire RTD Interface

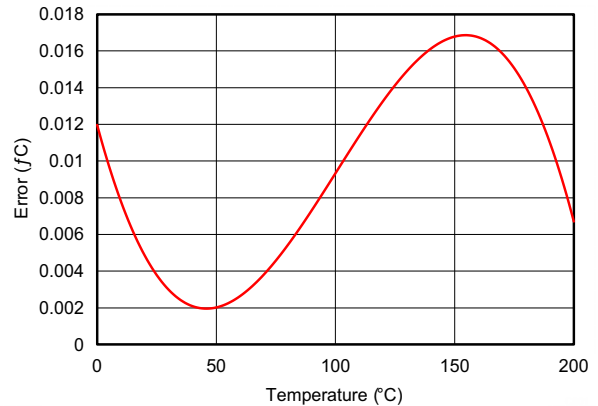

Figure 9-10. Temperature Error Over the Full Temperature Range

10 Power Supply Recommendations

The nominal performance of the INA819 is specified with a supply voltage of ± 15 V and midsupply reference voltage. The device also operates using power supplies from ± 2.25 V (4.5 V) to ± 18 V (36 V) and non-midsupply reference voltages with excellent performance. Parameters that can vary significantly with operating voltage and reference voltage are shown in the [セクション 7.6](#) section.

11 Layout

11.1 Layout Guidelines

Attention to good layout practices is always recommended. For best operational performance of the device, use good PCB layout practices, including:

- Take care to make sure that both input paths are well-matched for source impedance and capacitance to avoid converting common-mode signals into differential signals. Even slight mismatch in parasitic capacitance at the gain setting pins can degrade CMRR over frequency. For example, in applications that implement gain switching using switches or PhotoMOS[®] relays to change the value of R_G , select the component so that the switch capacitance is as small as possible and most importantly so that capacitance mismatch between the R_G pins is minimized.
- Noise can propagate into analog circuitry through the power pins of the circuit as a whole and of the device. Bypass capacitors reduce the coupled noise by providing low-impedance power sources local to the analog circuitry.
 - Connect low-ESR, 0.1- μ F ceramic bypass capacitors between each supply pin and ground, placed as close to the device as possible. A single bypass capacitor from $V+$ to ground is applicable for single-supply applications.
- To reduce parasitic coupling, run the input traces as far away from the supply or output traces as possible. If these traces cannot be kept separate, crossing the sensitive trace perpendicular is much better than in parallel with the noisy trace.
- Place the external components as close to the device as possible. As shown in [図 11-1](#), keep R_G close to the pins to minimize parasitic capacitance.
- Keep the traces as short as possible.
- Connect exposed thermal pad to negative supply $-V$.

11.2 Layout Example

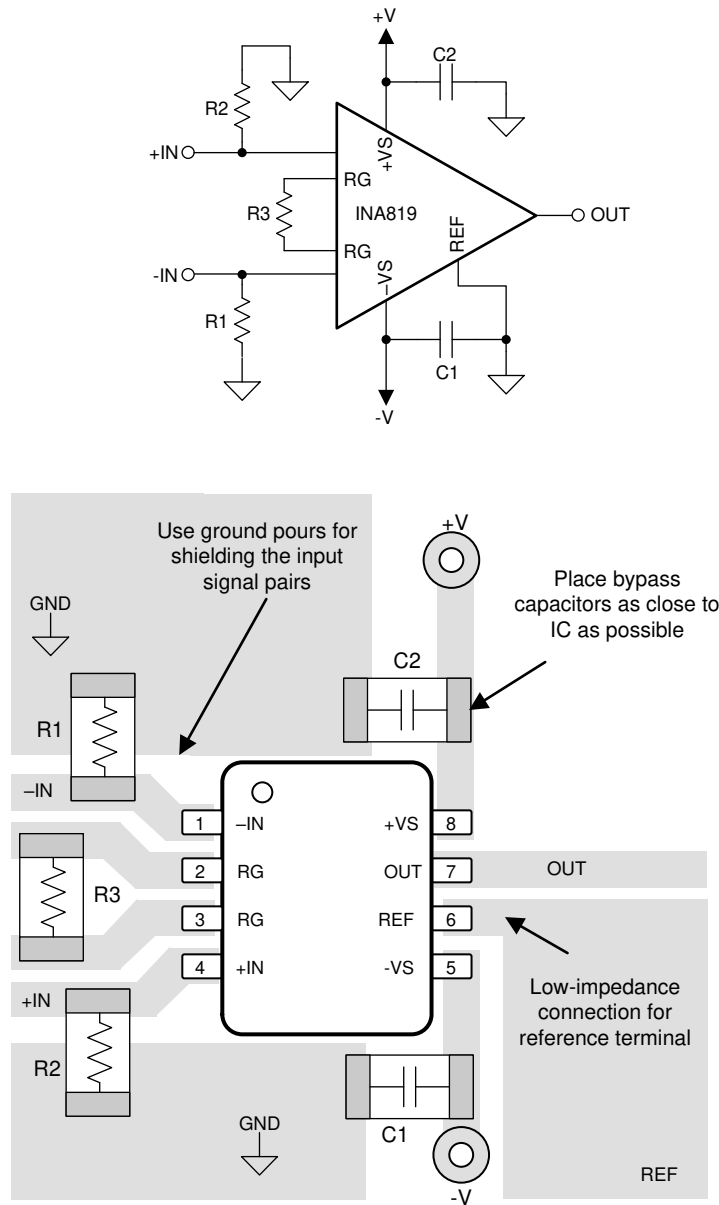

Copyright © 2017, Texas Instruments Incorporated

11-1. Example Schematic and Associated PCB Layout

12 Device and Documentation Support

12.1 Device Support

12.1.1 Development Support

12.1.1.1 PSpice® for TI

PSpice® for TI is a design and simulation environment that helps evaluate performance of analog circuits. Create subsystem designs and prototype solutions before committing to layout and fabrication, reducing development cost and time to market.

12.1.1.2 TINA-TI™ Simulation Software (Free Download)

TINA-TI™ simulation software is a simple, powerful, and easy-to-use circuit simulation program based on a SPICE engine. TINA-TI simulation software is a free, fully-functional version of the TINA™ software, preloaded with a library of macromodels, in addition to a range of both passive and active models. TINA-TI simulation software provides all the conventional dc, transient, and frequency domain analysis of SPICE, as well as additional design capabilities.

Available as a [free download](#) from the Analog eLab Design Center, TINA-TI simulation software offers extensive post-processing capability that allows users to format results in a variety of ways. Virtual instruments offer the ability to select input waveforms and probe circuit nodes, voltages, and waveforms, creating a dynamic quick-start tool.

Note

These files require that either the TINA software or TINA-TI software be installed. Download the free TINA-TI simulation software from the [TINA-TI™ software folder](#).

12.2 Documentation Support

12.2.1 Related Documentation

For related documentation see the following:

Texas Instruments, [Comprehensive Error Calculation for Instrumentation Amplifiers application note](#)

12.3 Receiving Notification of Documentation Updates

To receive notification of documentation updates, navigate to the device product folder on [ti.com](#). Click on *Subscribe to updates* to register and receive a weekly digest of any product information that has changed. For change details, review the revision history included in any revised document.

12.4 サポート・リソース

TI E2E™ サポート・フォーラムは、エンジニアが検証済みの回答と設計に関するヒントをエキスパートから迅速かつ直接得ることができる場所です。既存の回答を検索したり、独自の質問をしたりすることで、設計に必要な支援を迅速に得ることができます。

リンクされているコンテンツは、該当する貢献者により、現状のまま提供されるものです。これらは TI の仕様を構成するものではなく、必ずしも TI の見解を反映したものではありません。TI の[使用条件](#)を参照してください。

12.5 Trademarks

TINA-TI™ and TI E2E™ are trademarks of Texas Instruments.

TINA™ is a trademark of DesignSoft, Inc.

Bluetooth® is a registered trademark of Bluetooth SIG, Inc.

PhotoMOS® is a registered trademark of Panasonic Electric Works Europe AG.

PSpice® is a registered trademark of Cadence Design Systems, Inc.

すべての商標は、それぞれの所有者に帰属します。

12.6 Electrostatic Discharge Caution



This integrated circuit can be damaged by ESD. Texas Instruments recommends that all integrated circuits be handled with appropriate precautions. Failure to observe proper handling and installation procedures can cause damage.

ESD damage can range from subtle performance degradation to complete device failure. Precision integrated circuits may be more susceptible to damage because very small parametric changes could cause the device not to meet its published specifications.

12.7 Glossary

[TI Glossary](#) This glossary lists and explains terms, acronyms, and definitions.

13 Mechanical, Packaging, and Orderable Information

The following pages include mechanical, packaging, and orderable information. This information is the most current data available for the designated devices. This data is subject to change without notice and revision of this document. For browser-based versions of this data sheet, refer to the left-hand navigation.

PACKAGING INFORMATION

Orderable Device	Status (1)	Package Type	Package Drawing	Pins	Package Qty	Eco Plan (2)	Lead finish/ Ball material (6)	MSL Peak Temp (3)	Op Temp (°C)	Device Marking (4/5)	Samples
INA819ID	ACTIVE	SOIC	D	8	75	RoHS & Green	NIPDAU	Level-2-260C-1 YEAR	-40 to 125	INA819	Samples
INA819IDGKR	ACTIVE	VSSOP	DGK	8	2500	RoHS & Green	NIPDAUAG SN	Level-2-260C-1 YEAR	-40 to 125	1X3Q	Samples
INA819IDGKT	ACTIVE	VSSOP	DGK	8	250	RoHS & Green	NIPDAUAG SN	Level-2-260C-1 YEAR	-40 to 125	1X3Q	Samples
INA819IDR	ACTIVE	SOIC	D	8	2500	RoHS & Green	NIPDAU	Level-2-260C-1 YEAR	-40 to 125	INA819	Samples
INA819IDRGR	ACTIVE	SON	DRG	8	3000	RoHS & Green	NIPDAU	Level-1-260C-UNLIM	-40 to 125	INA819	Samples
INA819IDRGT	ACTIVE	SON	DRG	8	250	RoHS & Green	NIPDAU	Level-1-260C-UNLIM	-40 to 125	INA819	Samples

(1) The marketing status values are defined as follows:

ACTIVE: Product device recommended for new designs.

LIFEBUY: TI has announced that the device will be discontinued, and a lifetime-buy period is in effect.

NRND: Not recommended for new designs. Device is in production to support existing customers, but TI does not recommend using this part in a new design.

PREVIEW: Device has been announced but is not in production. Samples may or may not be available.

OBSOLETE: TI has discontinued the production of the device.

(2) **RoHS:** TI defines "RoHS" to mean semiconductor products that are compliant with the current EU RoHS requirements for all 10 RoHS substances, including the requirement that RoHS substance do not exceed 0.1% by weight in homogeneous materials. Where designed to be soldered at high temperatures, "RoHS" products are suitable for use in specified lead-free processes. TI may reference these types of products as "Pb-Free".

RoHS Exempt: TI defines "RoHS Exempt" to mean products that contain lead but are compliant with EU RoHS pursuant to a specific EU RoHS exemption.

Green: TI defines "Green" to mean the content of Chlorine (Cl) and Bromine (Br) based flame retardants meet JS709B low halogen requirements of <=1000ppm threshold. Antimony trioxide based flame retardants must also meet the <=1000ppm threshold requirement.

(3) MSL, Peak Temp. - The Moisture Sensitivity Level rating according to the JEDEC industry standard classifications, and peak solder temperature.

(4) There may be additional marking, which relates to the logo, the lot trace code information, or the environmental category on the device.

(5) Multiple Device Markings will be inside parentheses. Only one Device Marking contained in parentheses and separated by a "~" will appear on a device. If a line is indented then it is a continuation of the previous line and the two combined represent the entire Device Marking for that device.

(6) Lead finish/Ball material - Orderable Devices may have multiple material finish options. Finish options are separated by a vertical ruled line. Lead finish/Ball material values may wrap to two lines if the finish value exceeds the maximum column width.

Important Information and Disclaimer: The information provided on this page represents TI's knowledge and belief as of the date that it is provided. TI bases its knowledge and belief on information provided by third parties, and makes no representation or warranty as to the accuracy of such information. Efforts are underway to better integrate information from third parties. TI has taken and continues to take reasonable steps to provide representative and accurate information but may not have conducted destructive testing or chemical analysis on incoming materials and chemicals. TI and TI suppliers consider certain information to be proprietary, and thus CAS numbers and other limited information may not be available for release.

In no event shall TI's liability arising out of such information exceed the total purchase price of the TI part(s) at issue in this document sold by TI to Customer on an annual basis.

TAPE AND REEL INFORMATION



QUADRANT ASSIGNMENTS FOR PIN 1 ORIENTATION IN TAPE



*All dimensions are nominal

Device	Package Type	Package Drawing	Pins	SPQ	Reel Diameter (mm)	Reel Width W1 (mm)	A0 (mm)	B0 (mm)	K0 (mm)	P1 (mm)	W (mm)	Pin1 Quadrant
INA819IDGKR	VSSOP	DGK	8	2500	330.0	12.4	5.25	3.35	1.25	8.0	12.0	Q1
INA819IDGKT	VSSOP	DGK	8	250	330.0	12.4	5.25	3.35	1.25	8.0	12.0	Q1
INA819IDR	SOIC	D	8	2500	330.0	12.4	6.4	5.2	2.1	8.0	12.0	Q1
INA819IDRGR	SON	DRG	8	3000	330.0	12.4	3.3	3.3	1.1	8.0	12.0	Q2
INA819IDRGT	SON	DRG	8	250	180.0	12.4	3.3	3.3	1.1	8.0	12.0	Q2

TAPE AND REEL BOX DIMENSIONS



*All dimensions are nominal

Device	Package Type	Package Drawing	Pins	SPQ	Length (mm)	Width (mm)	Height (mm)
INA819IDGKR	VSSOP	DGK	8	2500	366.0	364.0	50.0
INA819IDGKT	VSSOP	DGK	8	250	366.0	364.0	50.0
INA819IDR	SOIC	D	8	2500	356.0	356.0	35.0
INA819IDRGR	SON	DRG	8	3000	367.0	367.0	35.0
INA819IDRGT	SON	DRG	8	250	210.0	185.0	35.0

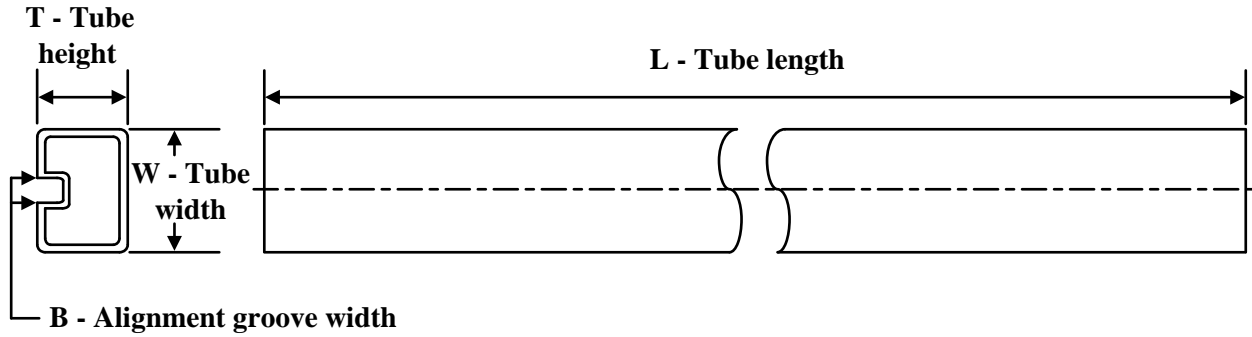
TUBE

*All dimensions are nominal

Device	Package Name	Package Type	Pins	SPQ	L (mm)	W (mm)	T (μm)	B (mm)
INA819ID	D	SOIC	8	75	506.6	8	3940	4.32



D0008A

PACKAGE OUTLINE

SOIC - 1.75 mm max height

SMALL OUTLINE INTEGRATED CIRCUIT



4214825/C 02/2019

NOTES:

1. Linear dimensions are in inches [millimeters]. Dimensions in parenthesis are for reference only. Controlling dimensions are in inches. Dimensioning and tolerancing per ASME Y14.5M.
2. This drawing is subject to change without notice.
3. This dimension does not include mold flash, protrusions, or gate burrs. Mold flash, protrusions, or gate burrs shall not exceed $.006$ [0.15] per side.
4. This dimension does not include interlead flash.
5. Reference JEDEC registration MS-012, variation AA.

EXAMPLE BOARD LAYOUT

D0008A

SOIC - 1.75 mm max height

SMALL OUTLINE INTEGRATED CIRCUIT



LAND PATTERN EXAMPLE
EXPOSED METAL SHOWN
SCALE:8X



SOLDER MASK DETAILS

4214825/C 02/2019

NOTES: (continued)

- 6. Publication IPC-7351 may have alternate designs.
- 7. Solder mask tolerances between and around signal pads can vary based on board fabrication site.

EXAMPLE STENCIL DESIGN

D0008A

SOIC - 1.75 mm max height

SMALL OUTLINE INTEGRATED CIRCUIT



SOLDER PASTE EXAMPLE
BASED ON .005 INCH [0.125 MM] THICK STENCIL
SCALE:8X

4214825/C 02/2019

NOTES: (continued)

8. Laser cutting apertures with trapezoidal walls and rounded corners may offer better paste release. IPC-7525 may have alternate design recommendations.
9. Board assembly site may have different recommendations for stencil design.

DRG (S-PWSON-N8)

PLASTIC SMALL OUTLINE NO-LEAD

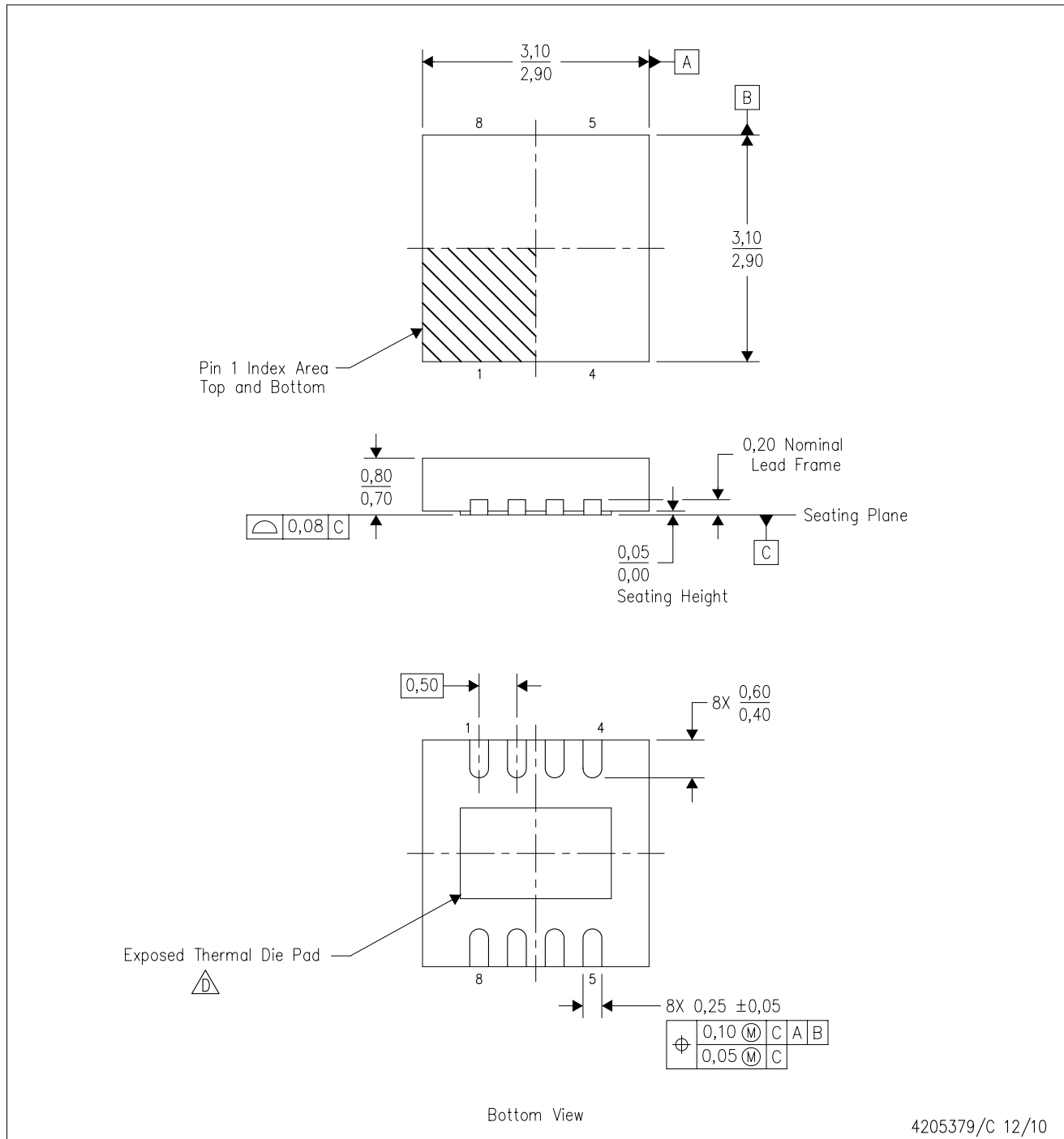

- NOTES:
- A. All linear dimensions are in millimeters. Dimensioning and tolerancing per ASME Y14.5M-1994.
 - B. This drawing is subject to change without notice.
 - C. SON (Small Outline No-Lead) package configuration.
 - △ The package thermal pad must be soldered to the board for thermal and mechanical performance. See the Product Data Sheet for details regarding the exposed thermal pad dimensions.
 - E. JEDEC MO-229 package registration pending.

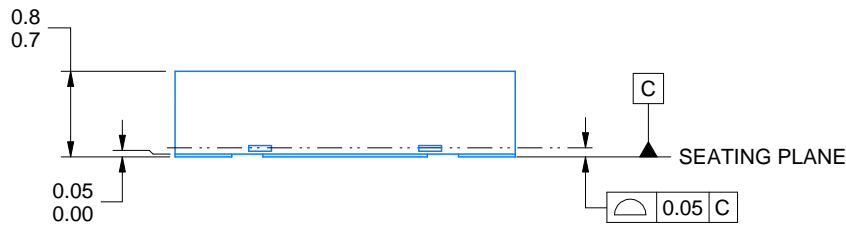
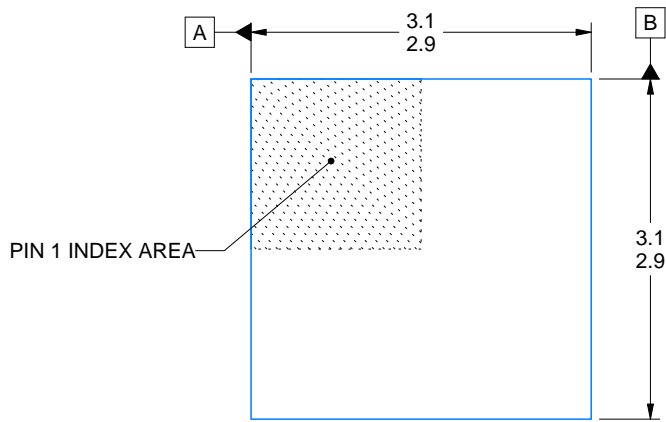
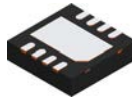

DIMENSION A	
OPTION 01	(0.1)
OPTION 02	(0.2)

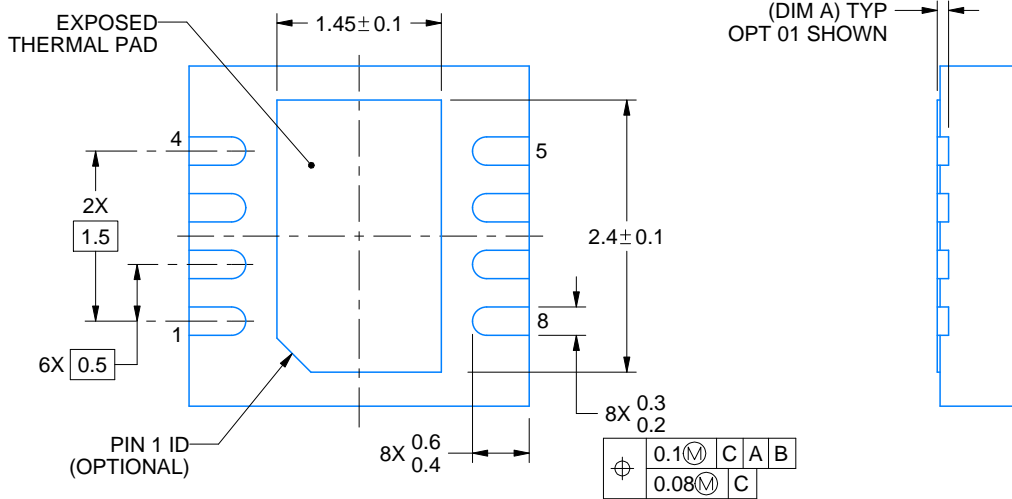

4218886/A 01/2020

NOTES:

1. All linear dimensions are in millimeters. Any dimensions in parenthesis are for reference only. Dimensioning and tolerancing per ASME Y14.5M.
2. This drawing is subject to change without notice.
3. The package thermal pad must be soldered to the printed circuit board for thermal and mechanical performance.

EXAMPLE BOARD LAYOUT

DRG0008B

WSON - 0.8 mm max height

PLASTIC SMALL OUTLINE - NO LEAD

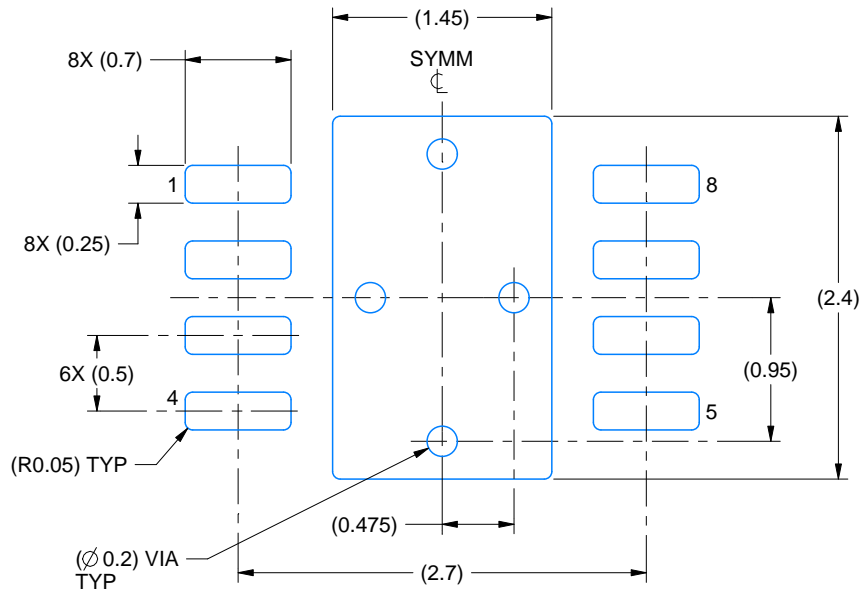

LAND PATTERN EXAMPLE
SCALE:20X

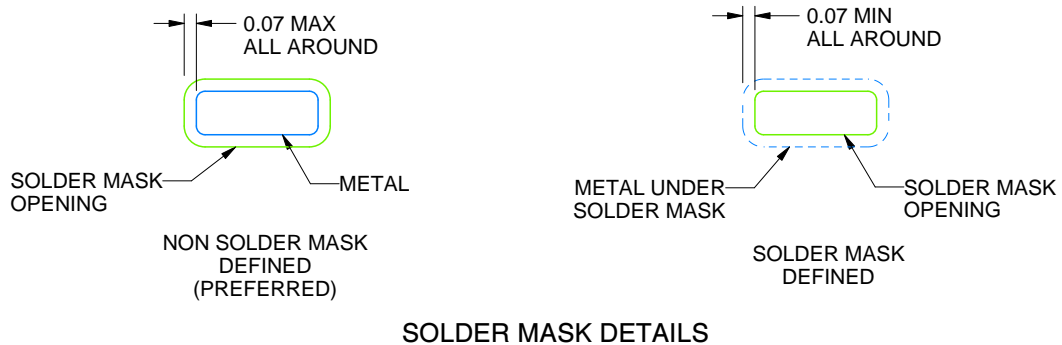

SOLDER MASK DETAILS

4218886/A 01/2020

NOTES: (continued)

4. This package is designed to be soldered to a thermal pad on the board. For more information, see Texas Instruments literature number SLUA271 (www.ti.com/lit/slua271).
5. Vias are optional depending on application, refer to device data sheet. If any vias are implemented, refer to their locations shown on this view. It is recommended that vias under paste be filled, plugged or tented.

EXAMPLE STENCIL DESIGN

DRG0008B

WSO - 0.8 mm max height

PLASTIC SMALL OUTLINE - NO LEAD

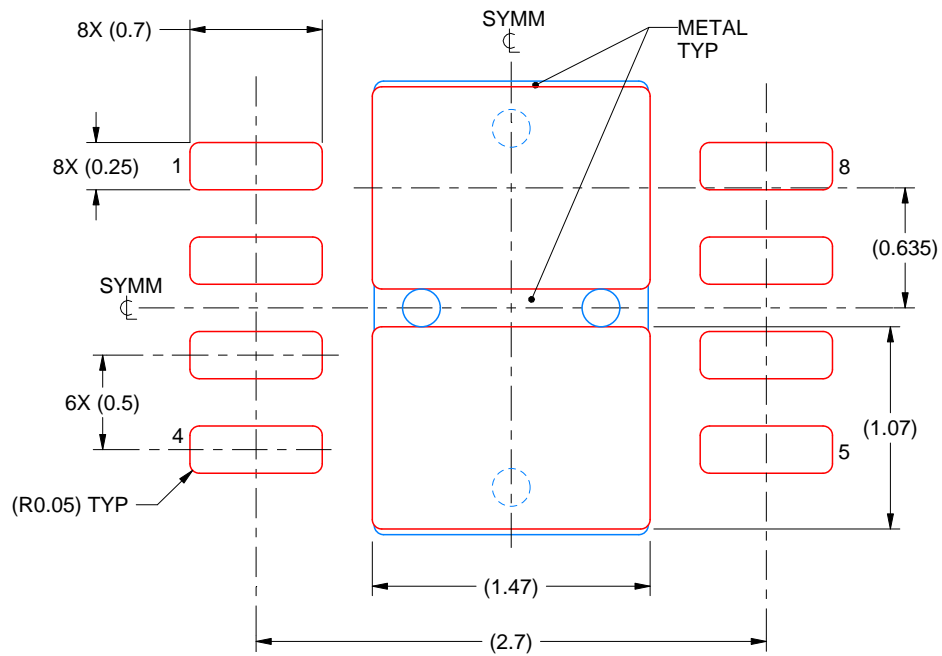

SOLDER PASTE EXAMPLE
BASED ON 0.125 mm THICK STENCIL

EXPOSED PAD
82% PRINTED SOLDER COVERAGE BY AREA
SCALE:25X

4218886/A 01/2020

NOTES: (continued)

6. Laser cutting apertures with trapezoidal walls and rounded corners may offer better paste release. IPC-7525 may have alternate design recommendations.

DGK0008A



PACKAGE OUTLINE

VSSOP - 1.1 mm max height

SMALL OUTLINE PACKAGE



4214862/A 04/2023

PowerPAD is a trademark of Texas Instruments.

NOTES:

- All linear dimensions are in millimeters. Any dimensions in parenthesis are for reference only. Dimensioning and tolerancing per ASME Y14.5M.
- This drawing is subject to change without notice.
- This dimension does not include mold flash, protrusions, or gate burrs. Mold flash, protrusions, or gate burrs shall not exceed 0.15 mm per side.
- This dimension does not include interlead flash. Interlead flash shall not exceed 0.25 mm per side.
- Reference JEDEC registration MO-187.

EXAMPLE BOARD LAYOUT

DGK0008A

™ VSSOP - 1.1 mm max height

SMALL OUTLINE PACKAGE



LAND PATTERN EXAMPLE
EXPOSED METAL SHOWN
SCALE: 15X



SOLDER MASK DETAILS

4214862/A 04/2023

NOTES: (continued)

6. Publication IPC-7351 may have alternate designs.
7. Solder mask tolerances between and around signal pads can vary based on board fabrication site.
8. Vias are optional depending on application, refer to device data sheet. If any vias are implemented, refer to their locations shown on this view. It is recommended that vias under paste be filled, plugged or tented.
9. Size of metal pad may vary due to creepage requirement.

EXAMPLE STENCIL DESIGN

DGK0008A

™ VSSOP - 1.1 mm max height

SMALL OUTLINE PACKAGE



SOLDER PASTE EXAMPLE
SCALE: 15X

4214862/A 04/2023

NOTES: (continued)

11. Laser cutting apertures with trapezoidal walls and rounded corners may offer better paste release. IPC-7525 may have alternate design recommendations.
12. Board assembly site may have different recommendations for stencil design.

重要なお知らせと免責事項

TI は、技術データと信頼性データ（データシートを含みます）、設計リソース（リファレンス・デザインを含みます）、アプリケーションや設計に関する各種アドバイス、Web ツール、安全性情報、その他のリソースを、欠陥が存在する可能性のある「現状のまま」提供しており、商品性および特定目的に対する適合性の黙示保証、第三者の知的財産権の非侵害保証を含むいかなる保証も、明示的または黙示的にかかわらず拒否します。

これらのリソースは、TI 製品を使用する設計の経験を積んだ開発者への提供を意図したものです。(1) お客様のアプリケーションに適した TI 製品の選定、(2) お客様のアプリケーションの設計、検証、試験、(3) お客様のアプリケーションに該当する各種規格や、その他のあらゆる安全性、セキュリティ、規制、または他の要件への確実な適合に関する責任を、お客様のみが単独で負うものとし、

上記の各種リソースは、予告なく変更される可能性があります。これらのリソースは、リソースで説明されている TI 製品を使用するアプリケーションの開発の目的でのみ、TI はその使用をお客様に許諾します。これらのリソースに関して、他の目的で複製することや掲載することは禁止されています。TI や第三者の知的財産権のライセンスが付与されている訳ではありません。お客様は、これらのリソースを自身で使用した結果発生するあらゆる申し立て、損害、費用、損失、責任について、TI およびその代理人を完全に補償するものとし、TI は一切の責任を拒否します。

TI の製品は、[TI の販売条件](#)、または [ti.com](#) やかかる TI 製品の関連資料などのいずれかを通じて提供する適用可能な条項の下で提供されています。TI がこれらのリソースを提供することは、適用される TI の保証または他の保証の放棄の拡大や変更を意味するものではありません。

お客様がいかなる追加条項または代替条項を提案した場合でも、TI はそれらに異議を唱え、拒否します。

郵送先住所：Texas Instruments, Post Office Box 655303, Dallas, Texas 75265
Copyright © 2024, Texas Instruments Incorporated