

## LM2903-Q1 および LM2903B-Q1 車載用デュアルコンパレータ

### 特長

- 車載アプリケーション認定済み
- 以下の結果で AEC-Q100 認定済み:
  - デバイス温度グレード 0: -40°C ~ 150°C の動作時周囲温度範囲 (LM2903E-Q1)
  - デバイス温度グレード 1: 動作時周囲温度範囲 -40°C ~ 125°C
  - デバイス HBM ESD 分類レベル H1C
  - デバイス CDM ESD 分類レベル C4B
- 「B」デバイスの HBM ESD を 2kV に改善
- 「B」デバイスでは 3 温度テストが利用可能
- シングル電源またはデュアル電源
- 電源電圧に依存しない低い消費電流、コンパレータあたり 200µA (代表値) (「B」バージョン)
- 低い入力バイアス電流、3.5nA (代表値) (「B」デバイス)
- 低い入力オフセット電流、0.5nA (代表値) (「B」デバイス)
- 低い入力オフセット電圧、±0.37mV (代表値) (「B」デバイス)
- 同相入力電圧範囲にグランドを含む
- 差動入力電圧範囲は最大定格電源電圧と同じ ±36V
- TTL、MOS、CMOS 互換出力
- 機能安全対応
  - 機能安全システムの設計に役立つ資料を利用可能

### アプリケーション

- 車載用
  - HEV/EV およびパワートレイン
  - インフォテインメントおよびクラスタ
  - ボディコントロール モジュール
- 産業用
- 電化製品

### 概要

LM2903B-Q1 デバイスは、業界標準の LM2903-Q1 コンパレータファミリの次世代バージョンです。この次世代ファミリは、小さいオフセット電圧、高い電源電圧への対応、小さい消費電流、小さい入力バイアス電流、短い伝搬遅延時間、優れた 2kV の ESD 性能などの特長と、ドロップイン互換で置換可能という利便性を兼ね備えており、コスト制約が厳しい用途で大きな価値を提供します。

すべてのデバイスは、広い電圧範囲にわたって動作するように設計された 2 つの独立した電圧コンパレータで構成されています。デュアル電源でも、2 つの電源間の差分が 2V ~ 36V の範囲内であり、VCC が入力同相電圧より 1.5V 以上高ければ、動作可能です。出力は、他のオープンコレクタ出力に接続できます。

LM2903-Q1 と LM2903B-Q1 は、AEC-Q100 グレード 1 の温度範囲 (-40°C ~ +125°C) で認定済みです。LM2903E-Q1 はグレード 0 の拡張温度範囲 (-40°C ~ +150°C) で認定済みです。

### 製品情報

| 部品番号       | パッケージ <sup>(1)</sup> | 本体サイズ (公称)       |
|------------|----------------------|------------------|
| LM2903B-Q1 | SOIC (8)             | 4.90mm × 3.91mm  |
|            | TSSOP (8)            | 3.00mm × 4.40mm  |
|            | VSSOP(8)             | 3.00 mm × 3.00mm |
|            | WSON (8)             | 2.00 mm × 2.00mm |
|            | SOT-23 (8)           | 1.60mm × 2.90mm  |
| LM2903-Q1  | SOIC (8)             | 4.90mm × 3.91mm  |
|            | TSSOP (8)            | 3.00mm × 4.40mm  |
|            | VSSOP(8)             | 3.00 mm × 3.00mm |
| LM2903E-Q1 | TSSOP (8)            | 3.00mm × 4.40mm  |

(1) 利用可能なすべてのパッケージについては、データシートの末尾にある注文情報を参照してください。

### ファミリ比較表

| 仕様                                | LM2903B-Q1 | LM2903-Q1 | LM2903-Q1<br>「A」デバイス | LM2903-Q1<br>「AV」デバイス | LM2903E-Q1 | 単位   |
|-----------------------------------|------------|-----------|----------------------|-----------------------|------------|------|
| 電源電圧仕様                            | 2~36       | 2~30      | 2~30                 | 2~32                  | 2~30       | V    |
| 総電源電流 (5V ~ V <sub>S</sub> (最大値)) | 0.6~0.8    | 1~2.5     | 1~2.5                | 1~2.5                 | 1~2.5      | mA   |
| 温度範囲                              | -40~125    | -40~125   | -40~125              | -40~125               | -40~150    | °C   |
| ESD (HBM / CDM)                   | 2k / 1k    | 1k / 750  | 1k / 750             | 1k / 750              | 1k / 750   | V    |
| オフセット電圧 (全温度範囲での最大値)              | ±4         | ±15       | ±4                   | ±4                    | ±15        | mV   |
| 入力バイアス電流 (標準値 / 最大値)              | 3.5 / 25   | 25 / 250  | 25 / 250             | 25 / 250              | 25 / 250   | nA   |
| 応答時間 (標準値)                        | 1          | 1.3       | 1.3                  | 1.3                   | 1.3        | µsec |



## Table of Contents

|  |          |   |           |
|--|----------|---|-----------|
| 特長.....  | 1        | 2.13 Switching Characteristics, LM2903-Q1 and LM2903E-Q1..... | 7         |
| アプリケーション.....  | 1        | 2.14 Typical Characteristics.....                             | 8         |
| 概要.....  | 1        | <b>3 Detailed Description.....</b>                            | <b>14</b> |
| <b>1 Pin Configuration and Functions.....</b>                  | <b>3</b> | 3.1 Overview.....   | 14        |
| 1.1 Pin Functions.....   | 3        | 3.2 Functional Block Diagram.....                             | 14        |
| <b>2 Specifications.....</b>                                   | <b>4</b> | 3.3 Feature Description.....                                  | 14        |
| 2.1 Absolute Maximum Ratings, LM2903-Q1 and LM2903E-Q1.....    | 4        | 3.4 Device Functional Modes.....                              | 15        |
| 2.2 Absolute Maximum Ratings, LM2903B-Q1.....                  | 4        | <b>4 Application and Implementation.....</b>                  | <b>16</b> |
| 2.3 ESD Ratings, LM2903-Q1 and LM2903E-Q1.....                 | 4        | 4.1 Application Information.....                              | 16        |
| 2.4 ESD Ratings, LM2903B-Q1.....                               | 4        | 4.2 Typical Application.....                                  | 16        |
| 2.5 Recommended Operating Conditions, LM2903B-Q1.....          | 5        | 4.3 Power Supply Recommendations.....                         | 18        |
| 2.6 Recommended Operating Conditions, LM2903-Q1.....           | 5        | 4.4 Layout.....   | 18        |
| 2.7 Recommended Operating Conditions, LM2903E-Q1.....          | 5        | <b>5 Device and Documentation Support.....</b>                | <b>18</b> |
| 2.8 Thermal Information.....                                   | 5        | 5.1 Documentation Support.....                                | 18        |
| 2.9 Electrical Characteristics LM2903B - Q1.....               | 6        | 5.2 Receiving Notification of Documentation Updates....       | 19        |
| 2.10 Switching Characteristics LM2903B - Q1.....               | 6        | 5.3 サポート・リソース.....  | 19        |
| 2.11 LM2903B-Q1 "T", "R" and "H" Temperature Test Options..... | 6        | 5.4 Trademarks.....   | 19        |
| 2.12 Electrical Characteristics, LM2903-Q1 and LM2903E-Q1..... | 7        | 5.5 静電気放電に関する注意事項.....  | 19        |
|  |          | 5.6 用語集.....  | 19        |
|  |          | <b>6 Revision History.....</b>                                | <b>20</b> |
|  |          | <b>7 Mechanical, Packaging, and Orderable Information..</b>   | <b>21</b> |

## 1 Pin Configuration and Functions

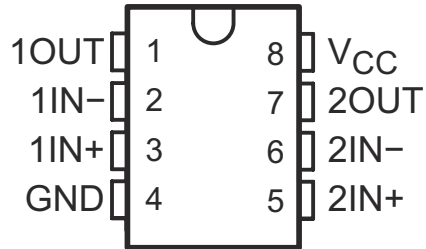

1-1. D, DGK, DDF OR PW PACKAGE  
Top View

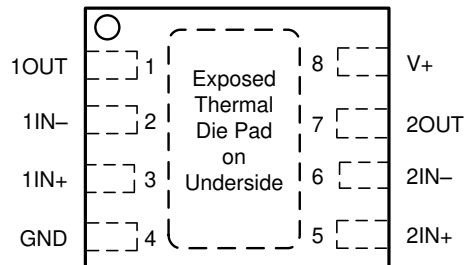

Connect thermal pad directly to GND pin.

1-2. DSG Package  
8-Pin WSON With Exposed Pad  
Top View

### 1.1 Pin Functions

| NAME            | PIN                                  |     | I/O    | DESCRIPTION                        |
|-----------------|--------------------------------------|-----|--------|------------------------------------|
|                 | SOIC, VSSOP, PDIP, SO, DDF and TSSOP | DSG |        |                                    |
| 1OUT            | 1                                    | 1   | Output | Output pin of comparator 1         |
| 1IN-            | 2                                    | 2   | Input  | Negative input pin of comparator 1 |
| 1IN+            | 3                                    | 3   | Input  | Positive input pin of comparator 1 |
| GND             | 4                                    | 4   | —      | Ground                             |
| 2IN+            | 5                                    | 5   | Input  | Positive input pin of comparator 2 |
| 2IN-            | 6                                    | 6   | Input  | Negative input pin of comparator 2 |
| 2OUT            | 7                                    | 7   | Output | Output pin of comparator 2         |
| V <sub>CC</sub> | 8                                    | 8   | —      | Positive Supply                    |
| Thermal Pad     | —                                    | PAD | —      | Connect directly to GND pin        |

## 2 Specifications

### 2.1 Absolute Maximum Ratings, LM2903-Q1 and LM2903E-Q1

over operating free-air temperature range (unless otherwise noted) <sup>(1)</sup>

|                  |  | MIN  | MAX       | UNIT |
|------------------|--|------|-----------|------|
| V <sub>CC</sub>  | Supply voltage <sup>(2)</sup>                  |      | 36        | V    |
| V <sub>CC</sub>  | Supply voltage, LM2903E-Q1 Only <sup>(2)</sup> |      | 32        | V    |
| V <sub>ID</sub>  | Differential input voltage <sup>(3)</sup>      | -36  | 36        | V    |
| V <sub>I</sub>   | Input voltage range (either input)             | -0.3 | 36        | V    |
| V <sub>O</sub>   | Output voltage                                 |      | 36        | V    |
| I <sub>O</sub>   | Output current                                 |      | 20        | mA   |
| T <sub>J</sub>   | Operating virtual-junction temperature         |      | 150       | °C   |
| T <sub>SCG</sub> | Duration of output short-circuit to ground     |      | Unlimited | s    |

(1) Stresses beyond those listed under *Absolute Maximum Ratings* can cause permanent damage to the device. These are stress ratings only, and functional operation of the device at these or any other conditions beyond those indicated under *Recommended Operating Conditions* is not implied. Exposure to absolute-maximum-rated conditions for extended periods can affect device reliability.

(2) All voltage values, except differential voltages, are with respect to GND.

(3) Differential voltages are at IN+ with respect to IN-.

### 2.2 Absolute Maximum Ratings, LM2903B-Q1

over operating free-air temperature range (unless otherwise noted)<sup>(1)</sup>

|   |  | MIN  | MAX       | UNIT |
|---|--|------|-----------|------|
| Supply voltage: V <sub>S</sub> = (V+) – (V-)                |  | -0.3 | 38        | V    |
| Differential input voltage : V <sub>ID</sub> <sup>(2)</sup> |  |      | ±38       | V    |
| Input pins (IN+, IN-)                                       |  | -0.3 | 38        | V    |
| Current into input pins (IN+, IN-)                          |  |      | -50       | mA   |
| Output pin (OUT)  |  | -0.3 | 38        | V    |
| Output sink current   |  |      | 25        | mA   |
| Operating virtual-junction temperature                      |  |      | 150       | °C   |
| Output short-circuit duration <sup>(3)</sup>                |  |      | Unlimited | s    |

(1) Stresses beyond those listed under *Absolute Maximum Ratings* can cause permanent damage to the device. These are stress ratings only, which do not imply functional operation of the device at these or any other conditions beyond those indicated under *Recommended Operating Conditions*. Exposure to absolute-maximum-rated conditions for extended periods can affect device reliability.

(2) Differential voltages are at IN+ with respect to IN-

(3) Short circuits from outputs to V+ can cause excessive heating and eventual destruction.

### 2.3 ESD Ratings, LM2903-Q1 and LM2903E-Q1

|                    |                           |   | MIN      | MAX  | UNIT |
|--------------------|---------------------------|---|----------|------|------|
| T <sub>stg</sub>   | Storage temperature range | LM2903-Q1 Only  | -65      | 150  | °C   |
| V <sub>(ESD)</sub> | Electrostatic discharge   | Human body model (HBM), per AEC Q100-002 <sup>(1)</sup> | -1000    | 1000 | V    |
|                    |                           | Charged device model (CDM), per AEC Q100-011            | All pins | -750 |      |

(1) AEC Q100-002 indicates HBM stressing is done in accordance with the ANSI/ESDA/JEDEC JS-001 specification.

### 2.4 ESD Ratings, LM2903B-Q1

|                    |                           |   | MIN      | MAX   | UNIT |
|--------------------|---------------------------|---|----------|-------|------|
| T <sub>stg</sub>   | Storage temperature range |   | -65      | 150   | °C   |
| V <sub>(ESD)</sub> | Electrostatic discharge   | Human body model (HBM), per AEC Q100-002 <sup>(1)</sup> | -2000    | 2000  | V    |
|                    |                           | Charged device model (CDM), per AEC Q100-011            | All pins | -1000 |      |

(1) AEC Q100-002 indicates HBM stressing is done in accordance with the ANSI/ESDA/JEDEC JS-001 specification.

## 2.5 Recommended Operating Conditions, LM2903B-Q1

over operating free-air temperature range (unless otherwise noted)

|                                      | MIN  | MAX      | UNIT |
|--------------------------------------|------|----------|------|
| Supply voltage: $V_S = (V+) - (V-)$  | 2    | 36       | V    |
| Ambient temperature, $T_A$ , LM2903B | -40  | 125      | °C   |
| Input voltage range, $V_{IVR}$       | -0.1 | (V+) - 2 | V    |

## 2.6 Recommended Operating Conditions, LM2903-Q1

over operating free-air temperature range (unless otherwise noted)

|                            | MIN | MAX | UNIT |
|----------------------------|-----|-----|------|
| $V_{CC}$ (non-V devices)   | 2   | 30  | V    |
| $V_{CC}$ (V devices)       | 2   | 32  | V    |
| $T_J$ Junction Temperature | -40 | 125 | °C   |

## 2.7 Recommended Operating Conditions, LM2903E-Q1

over operating free-air temperature range (unless otherwise noted)

|                            | MIN | MAX | UNIT |
|----------------------------|-----|-----|------|
| $V_{CC}$                   | 2   | 30  | V    |
| $T_J$ Junction Temperature | -40 | 150 | °C   |

## 2.8 Thermal Information

| THERMAL METRIC <sup>(1)</sup>                                     | LM2903x-Q1 |             |            |            |              | UNIT |
|---|------------|-------------|------------|------------|--------------|------|
|   | D (SOIC)   | DGK (VSSOP) | PW (TSSOP) | DSG (WSON) | DDF (SOT-23) |      |
|   | 8 PINS     | 8 PINS      | 8 PINS     | 8 PINS     | 8 PINS       |      |
| $R_{\theta JA}$ Junction-to-ambient thermal resistance            | 154.1      | 176.5       | 182.9      | 102.1      | 197.9        | °C/W |
| $R_{\theta JC(top)}$ Junction-to-case (top) thermal resistance    | 96.5       | 85.5        | 87.1       | 126.0      | 119.2        |      |
| $R_{\theta JB}$ Junction-to-board thermal resistance              | 97.7       | 112.4       | 123.2      | 68.6       | 115.4        |      |
| $\Psi_{JT}$ Junction-to-top characterization parameter            | 45.7       | 17.3        | 16.7       | 15.9       | 19.4         |      |
| $\Psi_{JB}$ Junction-to-board characterization parameter          | 96.9       | 110.1       | 120.4      | 68.4       | 113.7        |      |
| $R_{\theta JC(bot)}$ Junction-to-case (bottom) thermal resistance | -          | -           | -          | 43.9       | -            |      |

(1) For more information about traditional and new thermal metrics, see the [Semiconductor and IC Package Thermal Metrics](#) application report.

## 2.9 Electrical Characteristics LM2903B - Q1

 $V_S = 5V$ ,  $V_{CM} = (V-)$ ;  $T_A = 25^\circ C$  (unless otherwise noted).

| PARAMETER    |   |  | TEST CONDITIONS   | MIN  | TYP        | MAX        | UNIT    |
|--------------|---|--|---|------|------------|------------|---------|
| $V_{IO}$     | Input offset voltage, DGK package only          | Input offset voltage, DGK package only | $V_S = 5$ to 36V  | -3.5 | $\pm 0.37$ | 3.5        | mV      |
| $V_{IO}$     | Input offset voltage, DGK package only          | Input offset voltage, DGK package only | $V_S = 5$ to 36V, $T_A = -40^\circ C$ to $+125^\circ C$                       | -5   |            | 5          | mV      |
| $V_{IO}$     | Input offset voltage                            |  | $V_S = 5$ to 36V  | -2.5 | $\pm 0.37$ | 2.5        | mV      |
|              |   |  | $V_S = 5$ to 36V, $T_A = -40^\circ C$ to $+125^\circ C$                       | -4   |            | 4          | mV      |
| $I_B$        | Input bias current                              |  |   | -25  | -3.5       |            | nA      |
|              |   |  | $T_A = -40^\circ C$ to $+125^\circ C$   | -50  |            |            | nA      |
| $I_{OS}$     | Input offset current                            |  |   | -10  | $\pm 0.5$  | 10         | nA      |
|              |   |  | $T_A = -40^\circ C$ to $+125^\circ C$   | -25  |            | 25         | nA      |
| $V_{CM}$     | Common mode range <sup>(1)</sup>                |  | $V_S = 3$ to 36V  | (V-) |            | (V+) - 1.5 | V       |
|              |   |  | $V_S = 3$ to 36V, $T_A = -40^\circ C$ to $+125^\circ C$                       | (V-) |            | (V+) - 2.0 | V       |
| $A_{VD}$     | Large signal differential voltage amplification |  | $V_S = 15V$ , $V_O = 1.4V$ to $11.4V$ ;<br>$R_L \geq 15k$ to (V+)             | 50   | 200        |            | V/mV    |
| $V_{OL}$     | Low level output Voltage (swing from (V-))      |  | $I_{SINK} \leq 4mA$ , $V_{ID} = -1V$  |      | 110        | 400        | mV      |
|              |   |  | $I_{SINK} \leq 4mA$ , $V_{ID} = -1V$<br>$T_A = -40^\circ C$ to $+125^\circ C$ |      |            | 550        | mV      |
| $I_{OH-LKG}$ | High-level output leakage current               |  | (V+) = $V_O = 5V$ ; $V_{ID} = 1V$   |      | 0.1        | 20         | nA      |
|              |   |  | (V+) = $V_O = 36V$ ; $V_{ID} = 1V$  |      | 0.3        | 50         | nA      |
| $I_{OL}$     | Low level output current                        |  | $V_{OL} = 1.5V$ ; $V_{ID} = -1V$ ; $V_S = 5V$                                 | 6    | 21         |            | mA      |
| $I_Q$        | Quiescent current (all comparators)             |  | $V_S = 5V$ , no load  |      | 400        | 600        | $\mu A$ |
|              |   |  | $V_S = 36V$ , no load, $T_A = -40^\circ C$ to $+125^\circ C$                  |      | 550        | 800        | $\mu A$ |

(1) The voltage at any input should not be allowed to go negative by more than 0.3V. The upper end of the input voltage range is  $V_{CC} - 1.5V$  for one input, and the other input can exceed the  $V_{CC}$  level; the comparator provides a proper output state. Either or both inputs can go to 36V without damage.

## 2.10 Switching Characteristics LM2903B - Q1

 $V_S = 5V$ ,  $V_O$  PULLUP = 5V,  $V_{CM} = V_S/2$ ,  $C_L = 15pF$ ,  $R_L = 5.1k\Omega$ ,  $T_A = 25^\circ C$  (unless otherwise noted).

| PARAMETER      |  |  | TEST CONDITIONS                           | MIN | TYP  | MAX | UNIT |
|----------------|--|--|---|-----|------|-----|------|
| $t_{response}$ | Propagation delay time, high-to-low; TTL input signal <sup>(1)</sup>         |  | TTL input with $V_{ref} = 1.4V$           |     | 300  |     | ns   |
| $t_{response}$ | Propagation delay time, high-to-low; Small scale input signal <sup>(1)</sup> |  | Input overdrive = 5mV, Input step = 100mV |     | 1000 |     | ns   |

(1) High-to-low and low-to-high refers to the transition at the input.

## 2.11 LM2903B-Q1 "T", "R" and "H" Temperature Test Options

The following table describes the production temperature testing for the LM2903B-Q1 "H", "R" and "T" options. Specifications are the same as the LM2903B-Q1 above.

| Test             | LM2903B-Q1 | LM2903BR-Q1 | LM2903BH-Q1 | LM2903BT-Q1     |
|------------------|------------|-------------|-------------|-----------------|
| Probe (Wafer)    | -          | 25°C        | 125°C       | -40°C and 125°C |
| Final (Packaged) | 25°C       | 25°C        | 25°C        | 25°C            |

## 2.12 Electrical Characteristics, LM2903-Q1 and LM2903E-Q1

at specified free-air temperature,  $V_{CC} = 5V$  (unless otherwise noted)

| PARAMETER  | TEST CONDITIONS   |                  | $T_A$ <sup>(1)</sup>        | MIN               | TYP | MAX  | UNIT    |    |
|--|---|------------------|-----------------------------|-------------------|-----|------|---------|----|
| $V_{IO}$ Input offset voltage                            | $V_O = 1.4V$ ,<br>$V_{IC} = V_{IC(min)}$ ,<br>$V_{CC} = 5V$ to MAX <sup>(2)</sup> | Non-A devices    | 25°C                        | 2                 | 7   |      | mV      |    |
|  |   |                  | Full range                  |                   |     | 15   |         |    |
|  |   | A-suffix devices | 25°C                        |                   | 1   | 2    |         |    |
|  |   |                  | Full range                  |                   |     |      |         | 4  |
| $I_{IO}$ Input offset current                            | $V_O = 1.4V$  |                  | 25°C                        |                   | 5   | 50   | nA      |    |
|  |   |                  | Full range                  |                   |     | 200  |         |    |
| $I_{IB}$ Input bias current                              | $V_O = 1.4V$  |                  | 25°C                        |                   | -25 | -250 | nA      |    |
|  |   |                  | Full range                  |                   |     | -500 |         |    |
| $V_{ICR}$ Common-mode input voltage range <sup>(3)</sup> |   |                  | 25°C                        | 0 to $V_{CC}-1.5$ |     |      | V       |    |
|  |   |                  | Full range                  | 0 to $V_{CC}-2$   |     |      |         |    |
| $A_{VD}$ Large-signal differential-voltage amplification | $V_{CC} = 15V$ ,<br>$V_O = 1.4V$ to 11.4V,<br>$R_L \geq 15k\Omega$ to $V_{CC}$    |                  | 25°C                        | 25                | 100 |      | V/mV    |    |
| $I_{OH}$ High-level output current                       | $V_{OH} = 5V$   | $V_{ID} = 1V$    | 25°C                        |                   | 0.1 | 50   | nA      |    |
|  | $V_{OH} = V_{CC} \text{ MAX}^{(2)}$   |                  | Full range                  |                   |     | 1    | $\mu A$ |    |
| $V_{OL}$ Low-level output voltage                        | $I_{OL} = 4mA$ ,  | $V_{ID} = -1V$   | 25°C                        |                   | 150 | 400  | mV      |    |
|  |   |                  | Full range                  |                   |     | 700  |         |    |
| $I_{OL}$ Low-level output current                        | $V_{OL} = 1.5V$ ,   | $V_{ID} = -1V$   | 25°C                        |                   | 6   |      | mA      |    |
| $I_{CC}$ Supply current                                  | $R_L = \infty$  |                  | $V_{CC} = 5V$               | 25°C              |     | 0.8  | 1       | mA |
|  |   |                  | $V_{CC} = \text{MAX}^{(2)}$ | Full range        |     |      |         |    |

- (1) Full range (MIN or MAX) for LM2903-Q1 is  $-40^\circ C$  to  $125^\circ C$  and  $-40^\circ C$  to  $150^\circ C$  for the LM2903E-Q1. All characteristics are measured with zero common-mode input voltage, unless otherwise specified.
- (2)  $V_{CC} \text{ MAX} = 30V$  for non-V devices and 32V for V-suffix devices.
- (3) The voltage at either input or common-mode can not be allowed to go negative by more than 0.3V. The upper end of the common-mode voltage range is  $V_{CC+} - 1.5V$  for the inverting input (-), and the non-inverting input (+) can exceed the  $V_{CC}$  level; the comparator provides a proper output state. Either or both inputs can go to 30V (32V for V-suffix devices) without damage.

## 2.13 Switching Characteristics, LM2903-Q1 and LM2903E-Q1

$V_{CC} = 5V$ ,  $T_A = 25^\circ C$

| PARAMETER     | TEST CONDITIONS                               |                                    | TYP | UNIT    |
|---------------|---|------------------------------------|-----|---------|
| Response time | $R_L$ connected to 5V through 5.1k $\Omega$ , | 100m input step with 5mV overdrive | 1.3 | $\mu s$ |
|               | $C_L = 15pF^{(1)}$ <sup>(2)</sup>             | TTL-level input step               | 0.3 |         |

- (1)  $C_L$  includes probe and jig capacitance.
- (2) The response time specified is the interval between the input step function and the instant when the output crosses 1.4V.

## 2.14 Typical Characteristics

$T_A = 25^\circ\text{C}$ ,  $V_S = 5\text{V}$ ,  $R_{\text{PULLUP}} = 5.1\text{k}$ ,  $C_L = 15\text{pF}$ ,  $V_{\text{CM}} = 0\text{V}$ ,  $V_{\text{UNDERDRIVE}} = 100\text{mV}$ ,  $V_{\text{OVERDRIVE}} = 100\text{mV}$  unless otherwise noted.

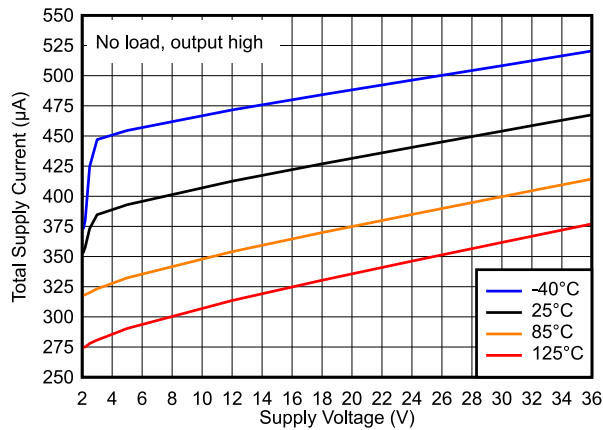

2-1. Total Supply Current vs. Supply Voltage

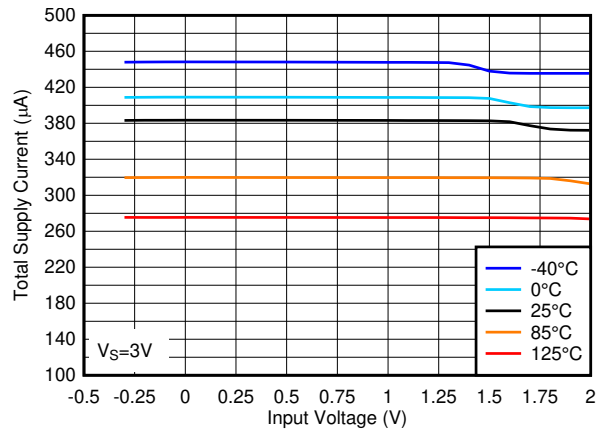

2-2. Total Supply Current vs. Input Voltage at 3V

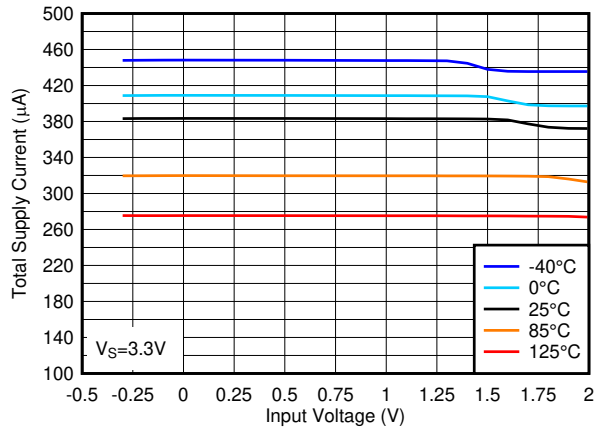

2-3. Total Supply Current vs. Input Voltage at 3.3V

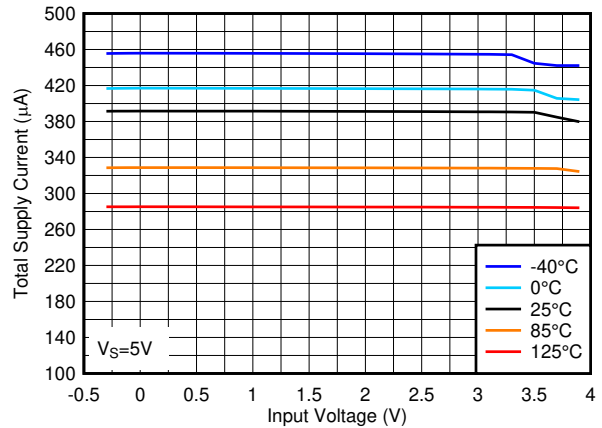

2-4. Total Supply Current vs. Input Voltage at 5V

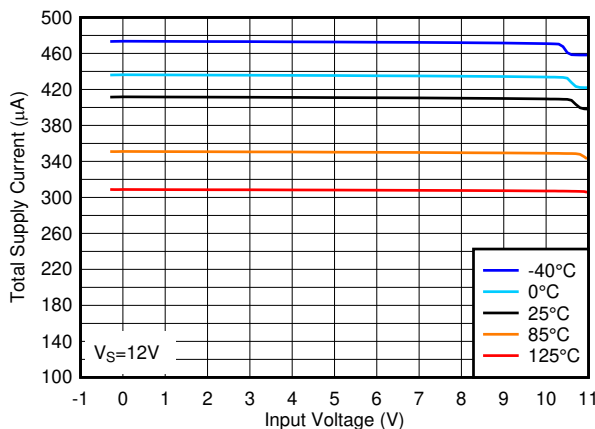

2-5. Total Supply Current vs. Input Voltage at 12V

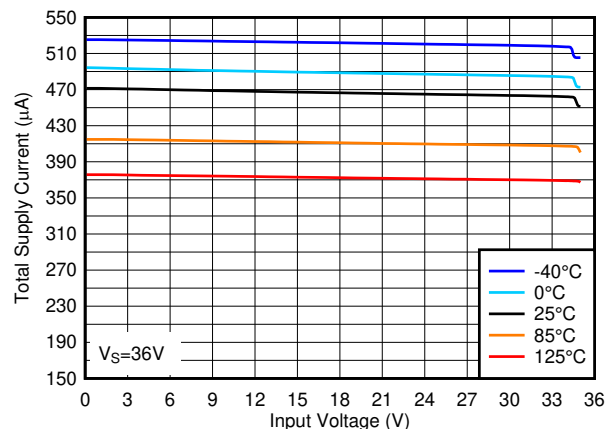

2-6. Total Supply Current vs. Input Voltage at 36V

## 2.14 Typical Characteristics (continued)

$T_A = 25^\circ\text{C}$ ,  $V_S = 5\text{V}$ ,  $R_{\text{PULLUP}} = 5.1\text{k}$ ,  $C_L = 15\text{pF}$ ,  $V_{\text{CM}} = 0\text{V}$ ,  $V_{\text{UNDERDRIVE}} = 100\text{mV}$ ,  $V_{\text{OVERDRIVE}} = 100\text{mV}$  unless otherwise noted.

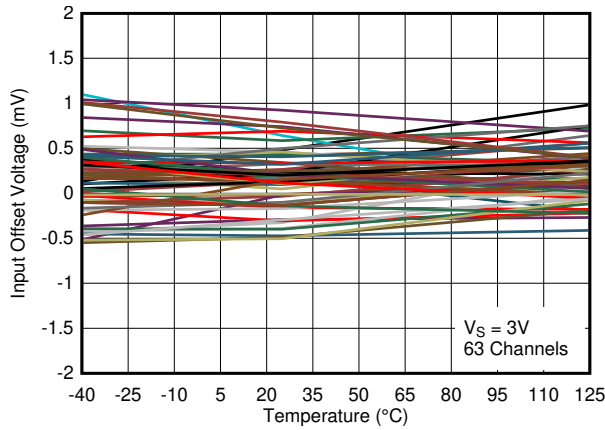

2-7. Input Offset Voltage vs. Temperature at 3V

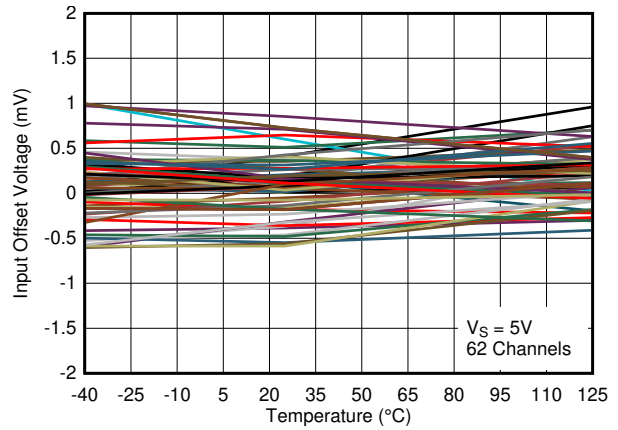

2-8. Input Offset Voltage vs. Temperature at 5V

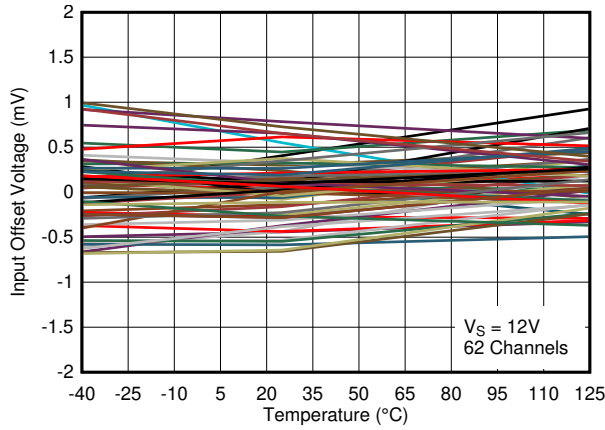

2-9. Input Offset Voltage vs. Temperature at 12V

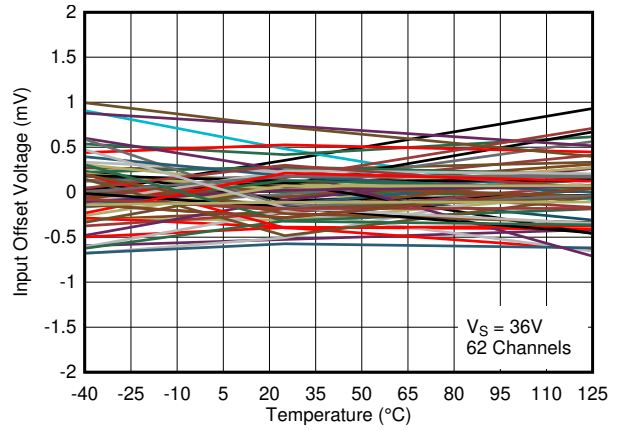

2-10. Input Offset Voltage vs. Temperature at 36V

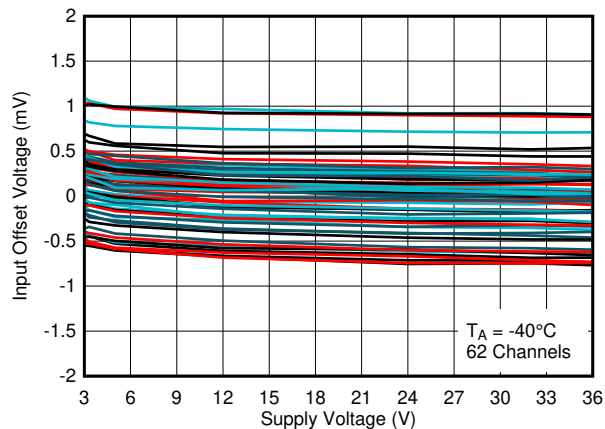

2-11. Input Offset Voltage vs. Supply Voltage at  $-40^\circ\text{C}$

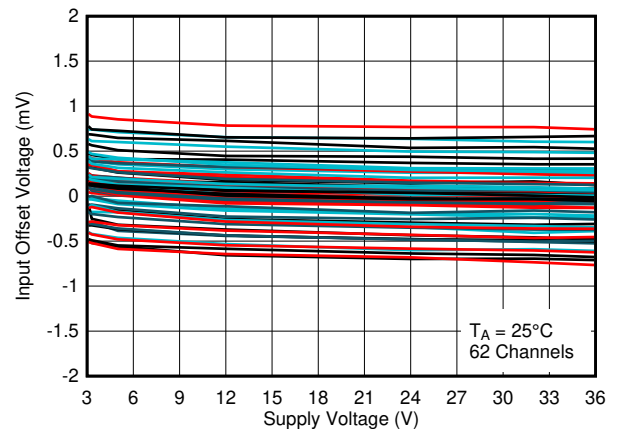

2-12. Input Offset Voltage vs. Supply Voltage at  $25^\circ\text{C}$

## 2.14 Typical Characteristics (continued)

$T_A = 25^\circ\text{C}$ ,  $V_S = 5\text{V}$ ,  $R_{\text{PULLUP}} = 5.1\text{k}$ ,  $C_L = 15\text{pF}$ ,  $V_{\text{CM}} = 0\text{V}$ ,  $V_{\text{UNDERDRIVE}} = 100\text{mV}$ ,  $V_{\text{OVERDRIVE}} = 100\text{mV}$  unless otherwise noted.



图 2-13. Input Offset Voltage vs. Supply Voltage at 85°C



图 2-14. Input Offset Voltage vs. Supply Voltage at 125°C

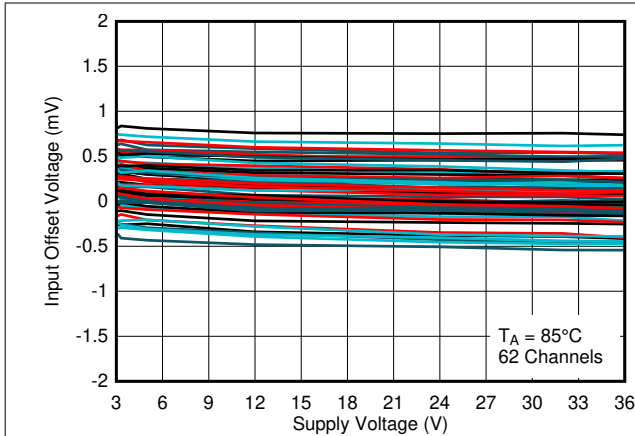

图 2-15. Input Bias Current vs. Supply Voltage

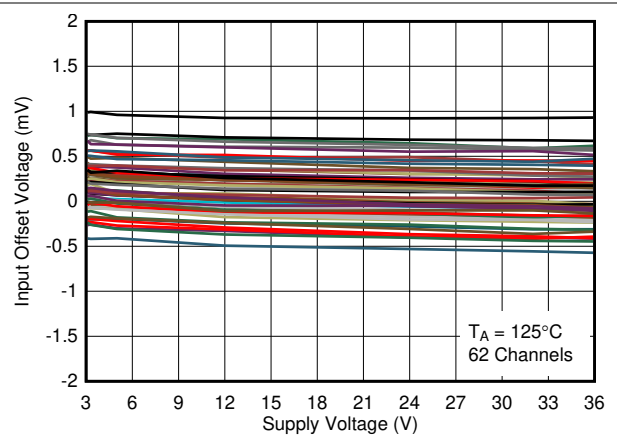

图 2-16. Input Bias Current vs. Input Voltage at 5V

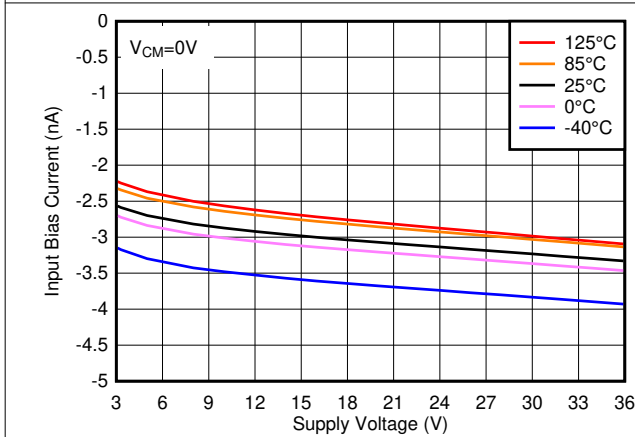

图 2-17. Input Bias Current vs. Input Voltage at 12V

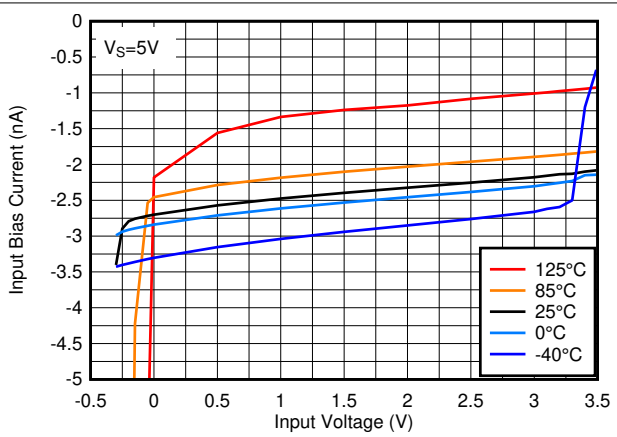

图 2-18. Input Bias Current vs. Input Voltage at 36V

## 2.14 Typical Characteristics (continued)

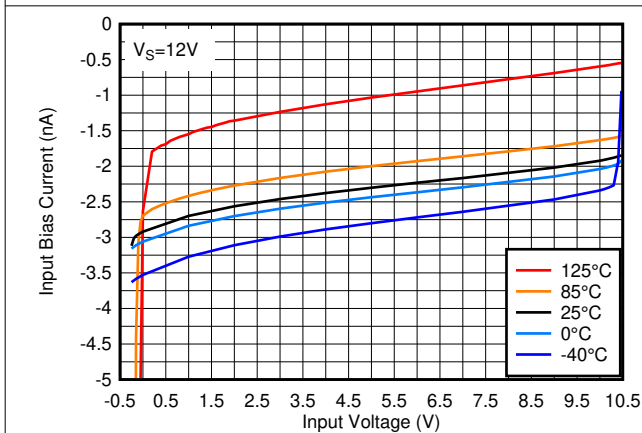
$T_A = 25^\circ\text{C}$ ,  $V_S = 5\text{V}$ ,  $R_{\text{PULLUP}} = 5.1\text{k}$ ,  $C_L = 15\text{pF}$ ,  $V_{\text{CM}} = 0\text{V}$ ,  $V_{\text{UNDERDRIVE}} = 100\text{mV}$ ,  $V_{\text{OVERDRIVE}} = 100\text{mV}$  unless otherwise noted.

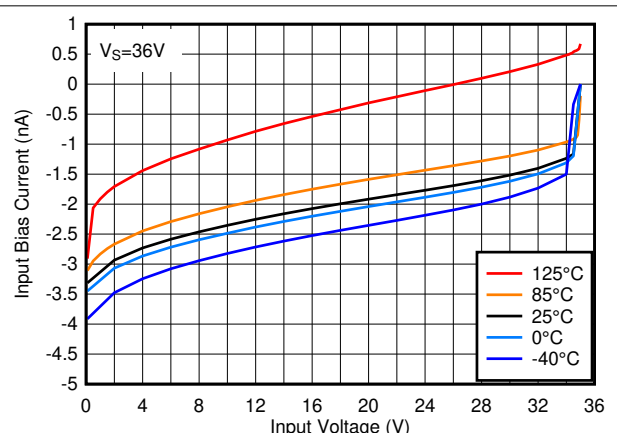
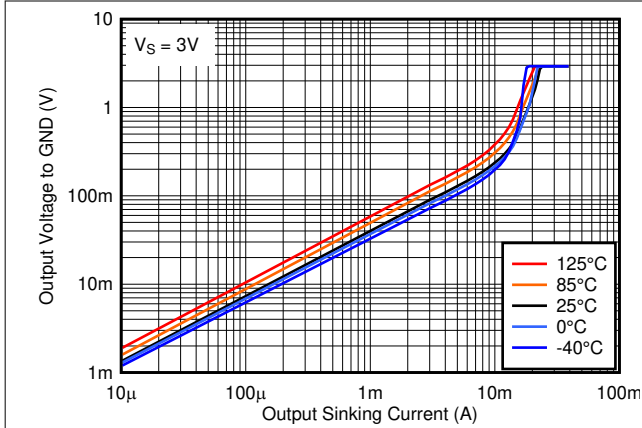

2-19. Output Low Voltage vs. Output Sinking Current at 3V



2-20. Output Low Voltage vs. Output Sinking Current at 5V

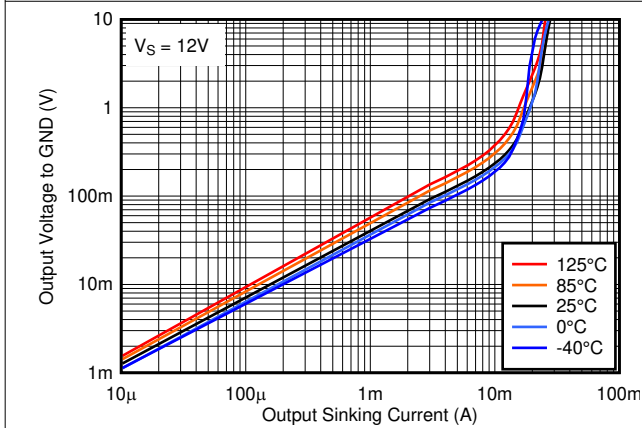

2-21. Output Low Voltage vs. Output Sinking Current at 12V

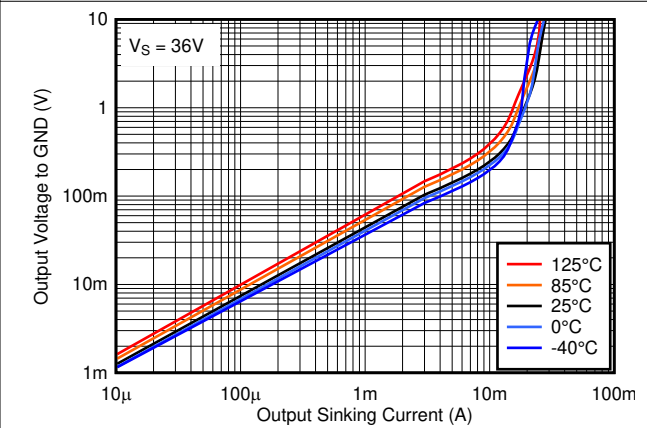

2-22. Output Low Voltage vs. Output Sinking Current at 36V

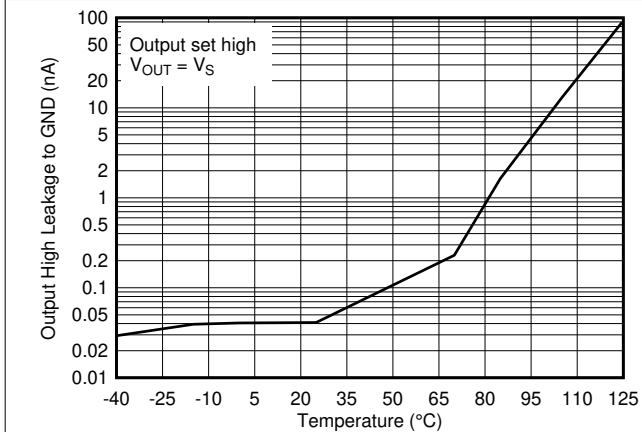

2-23. Output High Leakage Current vs. Temperature at 5V

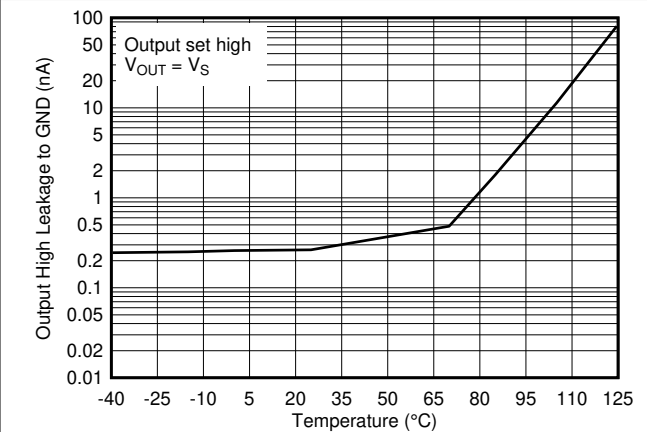

2-24. Output High Leakage Current vs. Temperature at 36V

## 2.14 Typical Characteristics (continued)

$T_A = 25^\circ\text{C}$ ,  $V_S = 5\text{V}$ ,  $R_{\text{PULLUP}} = 5.1\text{k}$ ,  $C_L = 15\text{pF}$ ,  $V_{\text{CM}} = 0\text{V}$ ,  $V_{\text{UNDERDRIVE}} = 100\text{mV}$ ,  $V_{\text{OVERDRIVE}} = 100\text{mV}$  unless otherwise noted.

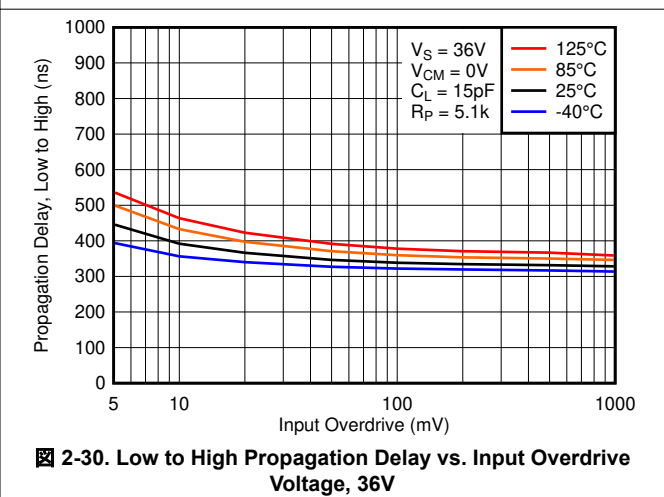
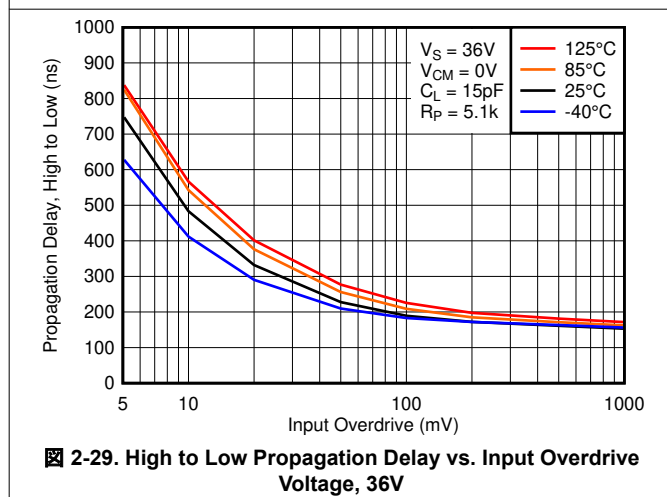
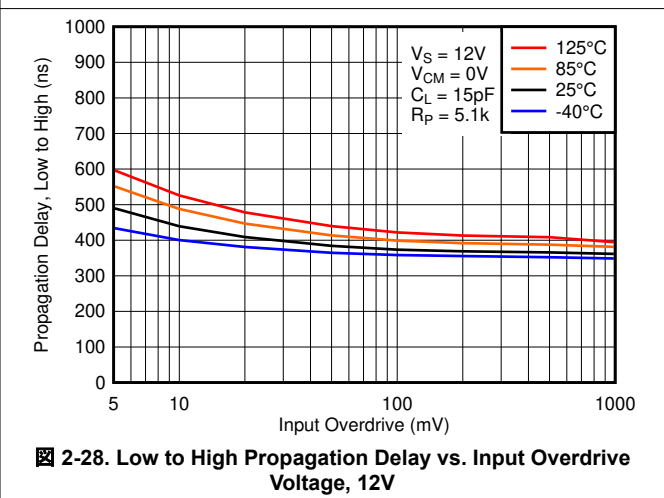
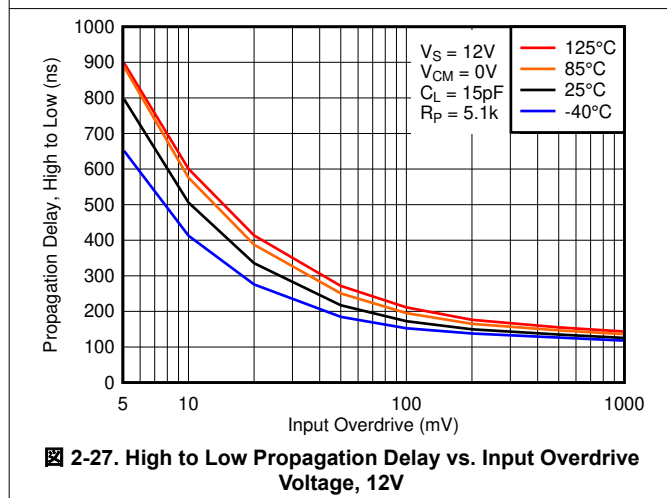
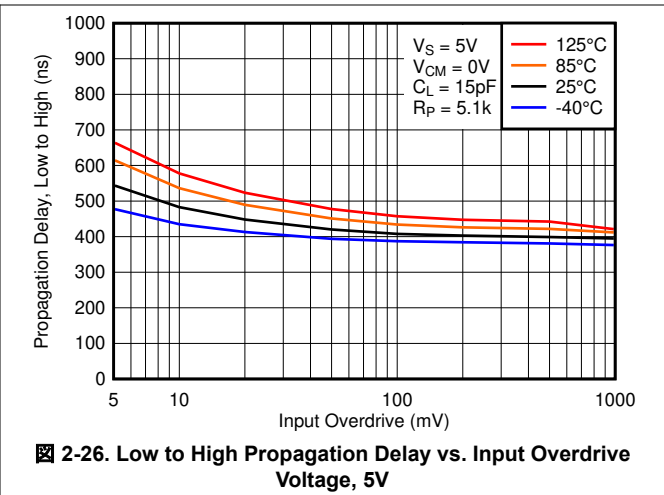
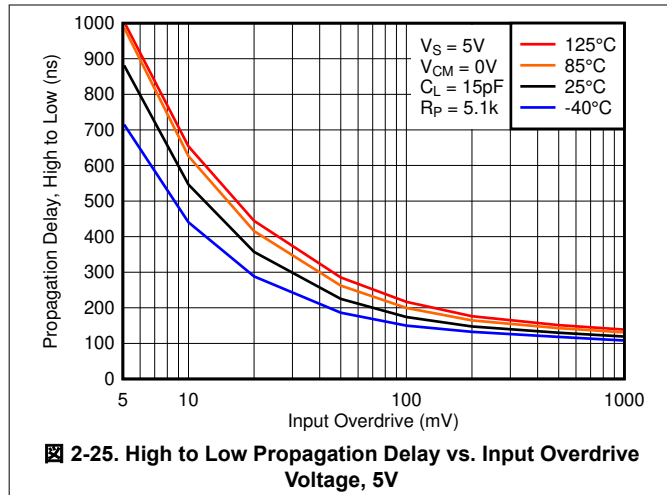

## 2.14 Typical Characteristics (continued)

$T_A = 25^\circ\text{C}$ ,  $V_S = 5\text{V}$ ,  $R_{\text{PULLUP}} = 5.1\text{k}$ ,  $C_L = 15\text{pF}$ ,  $V_{\text{CM}} = 0\text{V}$ ,  $V_{\text{UNDERDRIVE}} = 100\text{mV}$ ,  $V_{\text{OVERDRIVE}} = 100\text{mV}$  unless otherwise noted.

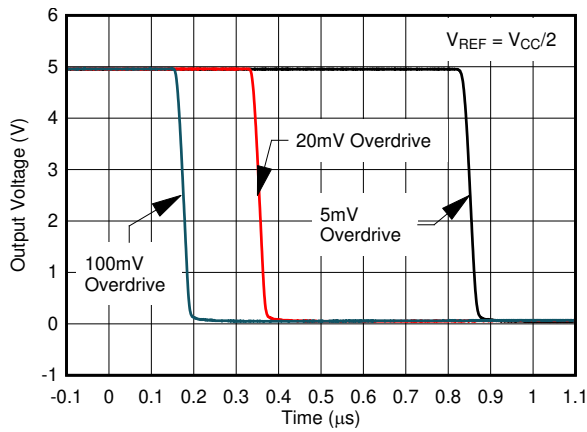

2-31. Response Time for Various Overdrives, High-to-Low Transition

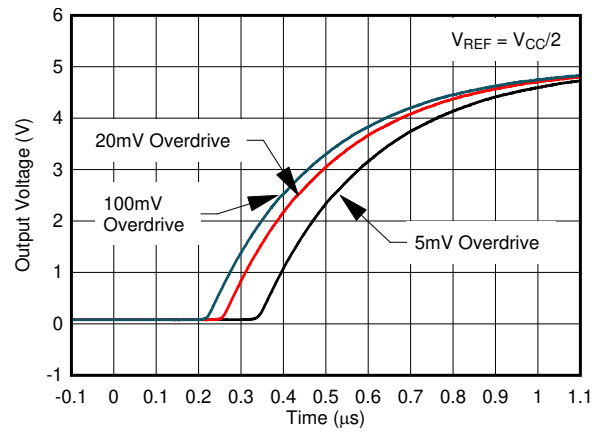

2-32. Response Time for Various Overdrives, Low-to-High Transition

## 3 Detailed Description

### 3.1 Overview

The LM2903-Q1 family is a dual comparator with the ability to operate up to 36V on the supply pin. This standard device has proven ubiquity and versatility across a wide range of applications. This is due to its very wide supply voltages range (2V to 36V), low  $I_q$  and fast response.

This device is AEC-Q100 qualified and can operate over a wide temperature range of  $-40^{\circ}\text{C}$  to  $125^{\circ}\text{C}$  (LM2903-Q1 and LM2903B-Q1) or  $-40^{\circ}\text{C}$  to  $150^{\circ}\text{C}$  (LM2903E-Q1).

The open-drain output allows the user to configure the output's logic low voltage ( $V_{OL}$ ) and can be utilized to enable the comparator to be used in AND functionality.

The "B" versions add dedicated ESD protections on all the pins for improved ESD performance as well as improved negative input voltage handling. Please see Application Note [SNOAA35](#) for more information

### 3.2 Functional Block Diagram



図 3-1. Schematic (Each Comparator)

### 3.3 Feature Description

LM2903-Q1 family consists of a PNP darlington pair input, allowing the device to operate with very high gain and fast response with minimal input bias current. The input Darlington pair creates a limit on the input common mode voltage capability, allowing LM2903-Q1 to accurately function from ground to  $V_{CC}-1.5\text{V}$  differential input. This enables much head room for modern day supplies of 3.3V and 5.0V. A clamp (Q15) was added around Q3 to force the output low when both inputs are taken above the VCM range.

The output consists of an open drain NPN (pull-down or low side) transistor. The output NPN sinks current when the negative input voltage is higher than the positive input voltage and the offset voltage. The  $V_{OL}$  is resistive and scales with the output current. Please see [Output Low Voltage vs. Output Sinking Current at 5V](#) in the [Typical Characteristics](#) section for  $V_{OL}$  values with respect to the output current.

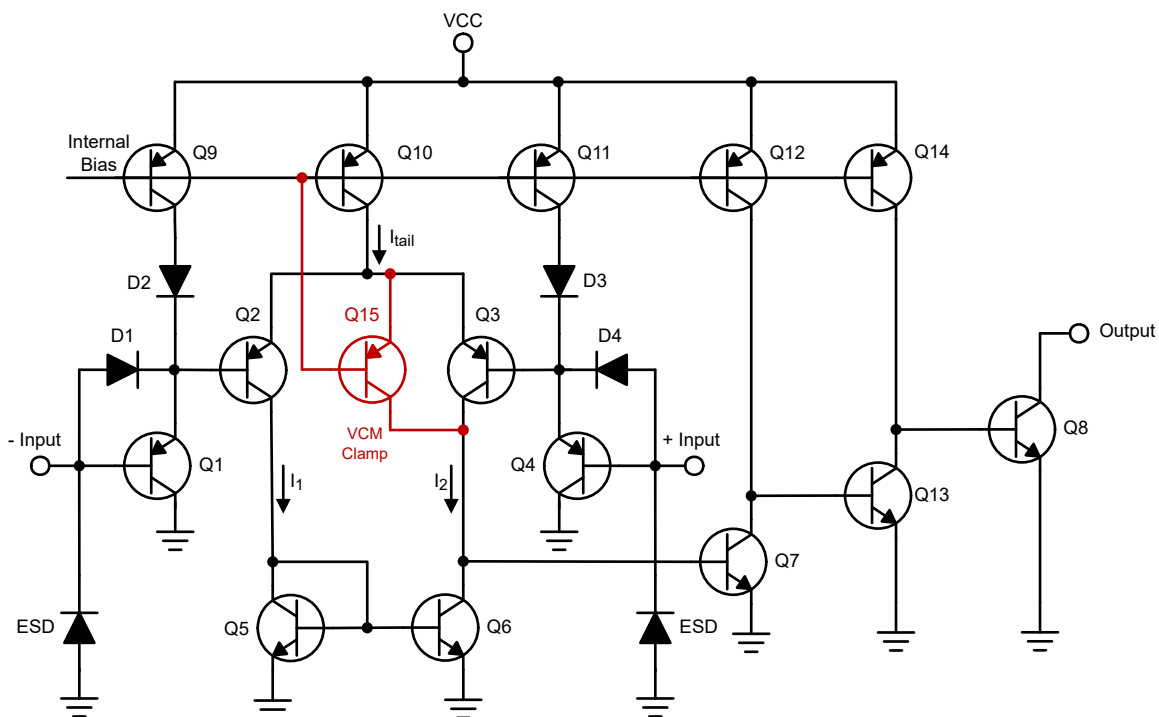
## 3.4 Device Functional Modes

### 3.4.1 Voltage Comparison

The LM2903-Q1 family operates solely as a voltage comparator, comparing the differential voltage between the positive and negative pins and outputting a logic low or high impedance (logic high with pull-up) based on the input differential polarity.

## 4 Application and Implementation

### 注

以下のアプリケーション情報は、TI の製品仕様に含まれるものではなく、TI ではその正確性または完全性を保証いたしません。個々の目的に対する製品の適合性については、お客様の責任で判断していただくこととなります。お客様は自身の設計実装を検証しテストすることで、システムの機能を確認する必要があります。

### 4.1 Application Information

LM2903-Q1 will typically be used to compare a single signal to a reference or two signals against each other. Many users take advantage of the open drain output to drive the comparison logic output to a logic voltage level to an MCU or logic device. The wide supply range and high voltage capability makes LM2903Q1 optimal for level shifting to a higher or lower voltage.

### 4.2 Typical Application



図 4-1. Single-ended and Differential Comparator Configurations

#### 4.2.1 Design Requirements

For this design example, use the parameters listed in 表 4-1 as the input parameters.

表 4-1. Design Parameters

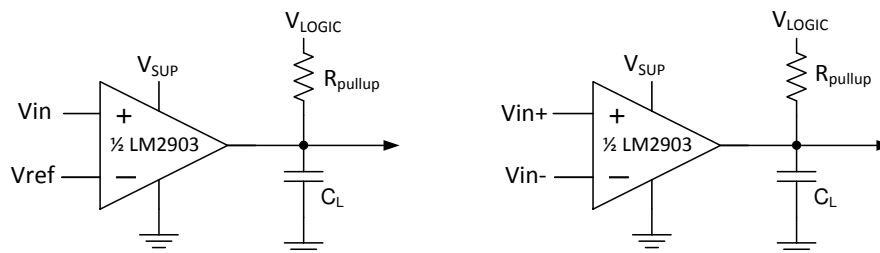
| DESIGN PARAMETER                      | EXAMPLE VALUE   |
|---------------------------------------|-----------------|
| Input Voltage Range                   | 0V to Vsup-1.5V |
| Supply Voltage                        | 2V to 36V       |
| Logic Supply Voltage                  | 2V to 36V       |
| Output Current (R <sub>PULLUP</sub> ) | 1μA to 20mA     |
| Input Overdrive Voltage               | 100mV           |
| Reference Voltage                     | 2.5V            |
| Load Capacitance (C <sub>L</sub> )    | 15pF            |

#### 4.2.2 Detailed Design Procedure

When using LM2903-Q1 family in a general comparator application, determine the following:

- Input Voltage Range
- Minimum Overdrive Voltage
- Output and Drive Current
- Response Time

##### 4.2.2.1 Input Voltage Range

When choosing the input voltage range, the input common mode voltage range ( $V_{ICR}$ ) must be taken in to account. If temperature operation is above or below 25°C the  $V_{ICR}$  can range from 0V to  $V_{CC} - 2V$ . This limits the input voltage range to as high as  $V_{CC} - 2.0V$  and as low as 0V. Operation outside of this range can yield incorrect comparisons.

Below is a list of input voltage situation and the outcomes:

1. When both IN- and IN+ are both within the common mode range:
  - a. If IN- is higher than IN+ and the offset voltage, the output is low and the output transistor is sinking current
  - b. If IN- is lower than IN+ and the offset voltage, the output is high impedance and the output transistor is not conducting
2. When IN- is higher than common mode and IN+ is within common mode, the output is low and the output transistor is sinking current
3. When IN+ is higher than common mode and IN- is within common mode, the output is high impedance and the output transistor is not conducting
4. When IN- and IN+ are both higher than common mode, see Section 2 of [Application Design Guidelines for LM339, LM393, TL331 Family Comparators Including the New B-versions](#)

#### 4.2.2.2 Minimum Overdrive Voltage

Overdrive Voltage is the differential voltage produced between the positive and negative inputs of the comparator over the offset voltage ( $V_{IO}$ ). To make an accurate comparison the Overdrive Voltage ( $V_{OD}$ ) must be higher than the input offset voltage ( $V_{IO}$ ). Overdrive voltage can also determine the response time of the comparator, with the response time decreasing with increasing overdrive. [Figure 4-2](#) and [Figure 4-3](#) show positive and negative response times with respect to overdrive voltage.

#### 4.2.2.3 Output and Drive Current

Output current is determined by the load/pull-up resistance and logic/pull-up voltage. The output current produces a output low voltage ( $V_{OL}$ ) from the comparator. In which  $V_{OL}$  is proportional to the output current. Use [Figure 2-21](#) to determine  $V_{OL}$  based on the output current.

The output current can also effect the transient response. More explanation is in the next section.

#### 4.2.2.4 Response Time

The transient response can be determined by the load capacitance ( $C_L$ ), load/pull-up resistance ( $R_{PULLUP}$ ) and equivalent collector-emitter resistance ( $R_{CE}$ ).

- The positive response time ( $T_P$ ) is approximately  $T_P = R_{PULLUP} \times C_L$
- The negative response time ( $T_N$ ) is approximately  $T_N = R_{CE} \times C_L$ 
  - $R_{CE}$  can be determine by taking the slope of [Figure 2-21](#) in it's linear region at the desired temperature, or by dividing the  $V_{OL}$  by  $I_{out}$

#### 4.2.3 Application Curves

The following curves were generated with 5V on  $V_{CC}$  and  $V_{Logic}$ ,  $R_{PULLUP} = 5.1k\Omega$ , and 50pF scope probe.



图 4-2. Response Time for Various Overdrives (Positive Transition)



图 4-3. Response Time for Various Overdrives (Negative Transition)

### 4.3 Power Supply Recommendations

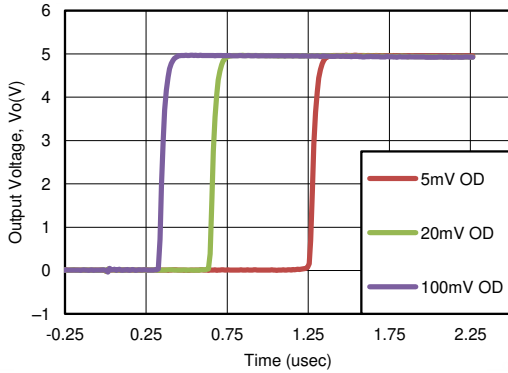
A bypass capacitor is recommended on the supply pin to reject any variation on the supply voltage. This variation can eat into the comparator's input common mode range and create an inaccurate comparison.

### 4.4 Layout

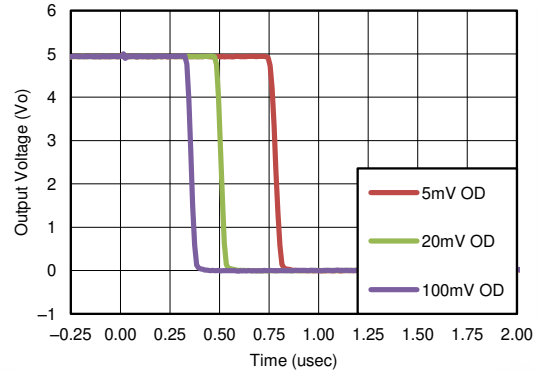
#### 4.4.1 Layout Guidelines

For accurate comparator applications without hysteresis, a stable power supply with minimal noise must be maintained. To achieve this, the best practice is to add a bypass capacitor between the supply voltage and ground. This can be implemented on the positive power supply and negative supply (if available). If a negative supply is not being used, do not put a capacitor between the IC's GND pin and system ground.

#### 4.4.2 Layout Example



图 4-4. LM2903Q1 Layout Example

## 5 Device and Documentation Support

### 5.1 Documentation Support

#### 5.1.1 Related Documentation

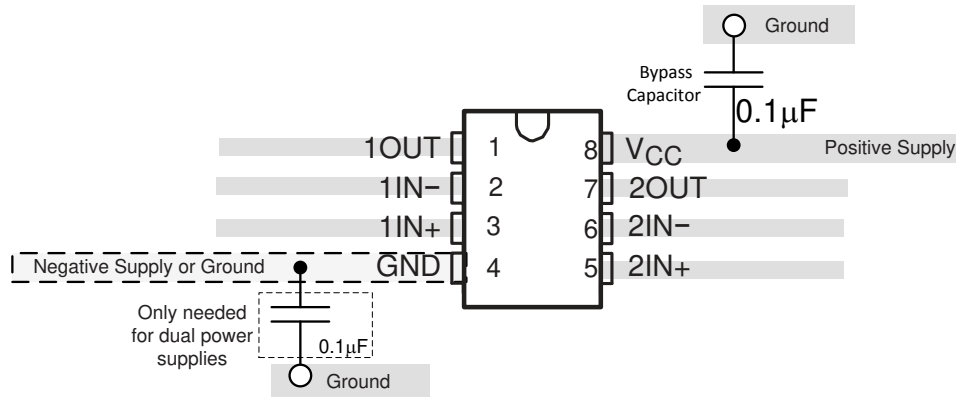
[LM2903B-Q1 Functional Safety FIT Rate, FMD and Pin FMA - SLCA005](#)

[Application Design Guidelines for LM339, LM393, TL331 Family Comparators - SNOAA35](#)

[Analog Engineers Circuit Cookbook: Amplifiers \(See Comparators section\) - SLYY137](#)

## 5.2 Receiving Notification of Documentation Updates

To receive notification of documentation updates, navigate to the device product folder on ti.com. In the upper right corner, click on *Alert me* to register and receive a weekly digest of any product information that has changed. For change details, review the revision history included in any revised document.

## 5.3 サポート・リソース

テキサス・インスツルメンツ E2E™ サポート・フォーラムは、エンジニアが検証済みの回答と設計に関するヒントをエキスパートから迅速かつ直接得ることができる場所です。既存の回答を検索したり、独自の質問をしたりすることで、設計に必要な支援を迅速に得ることができます。

リンクされているコンテンツは、各寄稿者により「現状のまま」提供されるものです。これらはテキサス・インスツルメンツの仕様を構成するものではなく、必ずしもテキサス・インスツルメンツの見解を反映したものではありません。テキサス・インスツルメンツの [使用条件](#) を参照してください。

## 5.4 Trademarks

テキサス・インスツルメンツ E2E™ is a trademark of Texas Instruments.

すべての商標は、それぞれの所有者に帰属します。

## 5.5 静電気放電に関する注意事項



この IC は、ESD によって破損する可能性があります。テキサス・インスツルメンツは、IC を取り扱う際には常に適切な注意を払うことを推奨します。正しい取り扱いおよび設置手順に従わない場合、デバイスを破損するおそれがあります。

ESD による破損は、わずかな性能低下からデバイスの完全な故障まで多岐にわたります。精密な IC の場合、パラメータがわずかに変化するだけで公表されている仕様から外れる可能性があるため、破損が発生しやすくなっています。

## 5.6 用語集

[テキサス・インスツルメンツ用語集](#)

この用語集には、用語や略語の一覧および定義が記載されています。

## 6 Revision History

資料番号末尾の英字は改訂を表しています。その改訂履歴は英語版に準じています。

| <b>Changes from Revision L (August 2023) to Revision M (December 2024)</b> | <b>Page</b> |
|--|-------------|
| • Updated thermal table .....  | 5           |
| • Updated Typical Characteristics.....                                     | 8           |
| • Updated Functional Block Diagram.....                                    | 14          |

| <b>Changes from Revision K (August 2022) to Revision L (August 2023)</b> | <b>Page</b> |
|--|-------------|
| • Added reference to Application Note.....                               | 16          |

| <b>Changes from Revision J (November 2020) to Revision K (August 2022)</b> | <b>Page</b> |
|--|-------------|
| • Added T, R and H Temp Test Options table.....                            | 6           |

| <b>Changes from Revision I (June 2020) to Revision J (November 2020)</b> | <b>Page</b> |
|--|-------------|
| • データシート全体を通して、LM2903B-Q1 の最小推奨電源電圧を 2V に変更.....                         | 1           |
| • Added Operating Virtual Temp to Abs Max Table for both versions.....   | 4           |
| • Updated Supply Voltage vs Supply Current graph for 2V.....             | 4           |

| <b>Changes from Revision G (November 2018) to Revision H (January 2020)</b> | <b>Page</b> |
|---|-------------|
| • データシートに LM2903B-Q1 を追加.....   | 1           |
| • 「製品情報」表を追加。.....  | 1           |
| • Added "B" device graphs .....   | 8           |
| • Changed incorrect input text in Feature Description in Apps Section.....  | 14          |

| <b>Changes from Revision F (May 2018) to Revision G (November 2018)</b> | <b>Page</b> |
|---|-------------|
|---|-------------|

| <b>Changes from Revision H (January 2020) to Revision I (June 2020)</b> | <b>Page</b> |
|---|-------------|
| • 機能安全のテキストとリンクを追加.....   | 1           |
| • 「B」の「製品情報」の一覧に VSSOP パッケージを追加.....                                    | 1           |
| • Added DGK to "B" Thermal Table.....                                   | 5           |
| • Added text to Apps Overview section for ESD.....                      | 14          |

## 7 Mechanical, Packaging, and Orderable Information

The following pages include mechanical, packaging, and orderable information. This information is the most current data available for the designated devices. This data is subject to change without notice and revision of this document. For browser-based versions of this data sheet, refer to the left-hand navigation.

**PACKAGING INFORMATION**

| Orderable part number            | Status<br>(1) | Material type<br>(2) | Package   Pins        | Package qty   Carrier | RoHS<br>(3) | Lead finish/<br>Ball material<br>(4) | MSL rating/<br>Peak reflow<br>(5) | Op temp (°C) | Part marking<br>(6) |
|----------------------------------|---------------|----------------------|-----------------------|-----------------------|-------------|--------------------------------------|-----------------------------------|--------------|---------------------|
| <a href="#">LM2903AVQDRG4Q1</a>  | Active        | Production           | SOIC (D)   8          | 2500   LARGE T&R      | Yes         | NIPDAU                               | Level-1-260C-UNLIM                | -40 to 125   | 2903AVQ             |
| LM2903AVQDRG4Q1.A                | Active        | Production           | SOIC (D)   8          | 2500   LARGE T&R      | Yes         | NIPDAU                               | Level-1-260C-UNLIM                | -40 to 125   | 2903AVQ             |
| LM2903AVQDRG4Q1.B                | Active        | Production           | SOIC (D)   8          | 2500   LARGE T&R      | Yes         | NIPDAU                               | Level-1-260C-UNLIM                | -40 to 125   | 2903AVQ             |
| <a href="#">LM2903AVQDRQ1</a>    | Active        | Production           | SOIC (D)   8          | 2500   LARGE T&R      | Yes         | NIPDAU                               | Level-1-260C-UNLIM                | -40 to 125   | (2903AVQ, 903AVQ)   |
| LM2903AVQDRQ1.A                  | Active        | Production           | SOIC (D)   8          | 2500   LARGE T&R      | Yes         | NIPDAU                               | Level-1-260C-UNLIM                | -40 to 125   | (2903AVQ, 903AVQ)   |
| LM2903AVQDRQ1.B                  | Active        | Production           | SOIC (D)   8          | 2500   LARGE T&R      | Yes         | NIPDAU                               | Level-1-260C-UNLIM                | -40 to 125   | (2903AVQ, 903AVQ)   |
| <a href="#">LM2903AVQPWRG4Q1</a> | Active        | Production           | TSSOP (PW)   8        | 2000   LARGE T&R      | Yes         | NIPDAU                               | Level-1-260C-UNLIM                | -40 to 125   | 2903AVQ             |
| LM2903AVQPWRG4Q1.A               | Active        | Production           | TSSOP (PW)   8        | 2000   LARGE T&R      | Yes         | NIPDAU                               | Level-1-260C-UNLIM                | -40 to 125   | 2903AVQ             |
| <a href="#">LM2903AVQPWRQ1</a>   | Active        | Production           | TSSOP (PW)   8        | 2000   LARGE T&R      | Yes         | NIPDAU                               | Level-1-260C-UNLIM                | -40 to 125   | 2903AVQ             |
| LM2903AVQPWRQ1.A                 | Active        | Production           | TSSOP (PW)   8        | 2000   LARGE T&R      | Yes         | NIPDAU                               | Level-1-260C-UNLIM                | -40 to 125   | 2903AVQ             |
| <a href="#">LM2903BHQDGKRQ1</a>  | Active        | Production           | VSSOP (DGK)   8       | 2500   LARGE T&R      | Yes         | NIPDAU                               | Level-1-260C-UNLIM                | -40 to 125   | 3BHQ                |
| LM2903BHQDGKRQ1.A                | Active        | Production           | VSSOP (DGK)   8       | 2500   LARGE T&R      | Yes         | NIPDAU                               | Level-1-260C-UNLIM                | -40 to 125   | 3BHQ                |
| LM2903BHQDGKRQ1.B                | Active        | Production           | VSSOP (DGK)   8       | 2500   LARGE T&R      | Yes         | NIPDAU                               | Level-1-260C-UNLIM                | -40 to 125   | 3BHQ                |
| <a href="#">LM2903BHQDRQ1</a>    | Active        | Production           | SOIC (D)   8          | 3000   LARGE T&R      | Yes         | NIPDAU                               | Level-1-260C-UNLIM                | -40 to 125   | 903BHQ              |
| LM2903BHQDRQ1.A                  | Active        | Production           | SOIC (D)   8          | 3000   LARGE T&R      | Yes         | NIPDAU                               | Level-1-260C-UNLIM                | -40 to 125   | 903BHQ              |
| LM2903BHQDRQ1.B                  | Active        | Production           | SOIC (D)   8          | 3000   LARGE T&R      | Yes         | NIPDAU                               | Level-1-260C-UNLIM                | -40 to 125   | 903BHQ              |
| <a href="#">LM2903BHQPWRQ1</a>   | Active        | Production           | TSSOP (PW)   8        | 3000   LARGE T&R      | Yes         | NIPDAU                               | Level-1-260C-UNLIM                | -40 to 125   | 2903BH              |
| LM2903BHQPWRQ1.A                 | Active        | Production           | TSSOP (PW)   8        | 3000   LARGE T&R      | Yes         | NIPDAU                               | Level-1-260C-UNLIM                | -40 to 125   | 2903BH              |
| LM2903BHQPWRQ1.B                 | Active        | Production           | TSSOP (PW)   8        | 3000   LARGE T&R      | Yes         | NIPDAU                               | Level-1-260C-UNLIM                | -40 to 125   | 2903BH              |
| <a href="#">LM2903BQDDFRQ1</a>   | Active        | Production           | SOT-23-THIN (DDF)   8 | 3000   LARGE T&R      | Yes         | NIPDAU                               | Level-1-260C-UNLIM                | -40 to 125   | 903BQ               |
| LM2903BQDDFRQ1.B                 | Active        | Production           | SOT-23-THIN (DDF)   8 | 3000   LARGE T&R      | Yes         | NIPDAU                               | Level-1-260C-UNLIM                | -40 to 125   | 903BQ               |
| <a href="#">LM2903BQDGKRQ1</a>   | Active        | Production           | VSSOP (DGK)   8       | 2500   LARGE T&R      | Yes         | NIPDAU                               | Level-1-260C-UNLIM                | -40 to 125   | 03BQ                |
| LM2903BQDGKRQ1.A                 | Active        | Production           | VSSOP (DGK)   8       | 2500   LARGE T&R      | Yes         | NIPDAU                               | Level-1-260C-UNLIM                | -40 to 125   | 03BQ                |
| LM2903BQDGKRQ1.B                 | Active        | Production           | VSSOP (DGK)   8       | 2500   LARGE T&R      | Yes         | NIPDAU                               | Level-1-260C-UNLIM                | -40 to 125   | 03BQ                |
| <a href="#">LM2903BQDRQ1</a>     | Active        | Production           | SOIC (D)   8          | 2500   LARGE T&R      | Yes         | NIPDAU                               | Level-1-260C-UNLIM                | -40 to 125   | 2903BQ              |
| LM2903BQDRQ1.A                   | Active        | Production           | SOIC (D)   8          | 2500   LARGE T&R      | Yes         | NIPDAU                               | Level-1-260C-UNLIM                | -40 to 125   | 2903BQ              |
| LM2903BQDRQ1.B                   | Active        | Production           | SOIC (D)   8          | 2500   LARGE T&R      | Yes         | NIPDAU                               | Level-1-260C-UNLIM                | -40 to 125   | 2903BQ              |
| <a href="#">LM2903BQPWRQ1</a>    | Active        | Production           | TSSOP (PW)   8        | 2000   LARGE T&R      | Yes         | NIPDAU                               | Level-1-260C-UNLIM                | -40 to 125   | 2903BQ              |
| LM2903BQPWRQ1.A                  | Active        | Production           | TSSOP (PW)   8        | 2000   LARGE T&R      | Yes         | NIPDAU                               | Level-1-260C-UNLIM                | -40 to 125   | 2903BQ              |

| Orderable part number           | Status<br>(1) | Material type<br>(2) | Package   Pins  | Package qty   Carrier | RoHS<br>(3) | Lead finish/<br>Ball material<br>(4) | MSL rating/<br>Peak reflow<br>(5) | Op temp (°C) | Part marking<br>(6) |
|---------------------------------|---------------|----------------------|-----------------|-----------------------|-------------|--------------------------------------|-----------------------------------|--------------|---------------------|
| LM2903BQPWRQ1.B                 | Active        | Production           | TSSOP (PW)   8  | 2000   LARGE T&R      | Yes         | NIPDAU                               | Level-1-260C-UNLIM                | -40 to 125   | 2903BQ              |
| <a href="#">LM2903BRQDGKRQ1</a> | Active        | Production           | VSSOP (DGK)   8 | 2500   LARGE T&R      | Yes         | NIPDAU                               | Level-1-260C-UNLIM                | -40 to 125   | 3BRQ                |
| LM2903BRQDGKRQ1.A               | Active        | Production           | VSSOP (DGK)   8 | 2500   LARGE T&R      | Yes         | NIPDAU                               | Level-1-260C-UNLIM                | -40 to 125   | 3BRQ                |
| LM2903BRQDGKRQ1.B               | Active        | Production           | VSSOP (DGK)   8 | 2500   LARGE T&R      | Yes         | NIPDAU                               | Level-1-260C-UNLIM                | -40 to 125   | 3BRQ                |
| <a href="#">LM2903BRQDRQ1</a>   | Active        | Production           | SOIC (D)   8    | 3000   LARGE T&R      | Yes         | NIPDAU                               | Level-1-260C-UNLIM                | -40 to 125   | 903BRQ              |
| LM2903BRQDRQ1.A                 | Active        | Production           | SOIC (D)   8    | 3000   LARGE T&R      | Yes         | NIPDAU                               | Level-1-260C-UNLIM                | -40 to 125   | 903BRQ              |
| LM2903BRQDRQ1.B                 | Active        | Production           | SOIC (D)   8    | 3000   LARGE T&R      | Yes         | NIPDAU                               | Level-1-260C-UNLIM                | -40 to 125   | 903BRQ              |
| <a href="#">LM2903BRQPWRQ1</a>  | Active        | Production           | TSSOP (PW)   8  | 3000   LARGE T&R      | Yes         | NIPDAU                               | Level-1-260C-UNLIM                | -40 to 125   | 2903BR              |
| LM2903BRQPWRQ1.A                | Active        | Production           | TSSOP (PW)   8  | 3000   LARGE T&R      | Yes         | NIPDAU                               | Level-1-260C-UNLIM                | -40 to 125   | 2903BR              |
| LM2903BRQPWRQ1.B                | Active        | Production           | TSSOP (PW)   8  | 3000   LARGE T&R      | Yes         | NIPDAU                               | Level-1-260C-UNLIM                | -40 to 125   | 2903BR              |
| <a href="#">LM2903BTQDGKRQ1</a> | Active        | Production           | VSSOP (DGK)   8 | 2500   LARGE T&R      | Yes         | NIPDAU                               | Level-1-260C-UNLIM                | -40 to 125   | 3BTQ                |
| LM2903BTQDGKRQ1.A               | Active        | Production           | VSSOP (DGK)   8 | 2500   LARGE T&R      | Yes         | NIPDAU                               | Level-1-260C-UNLIM                | -40 to 125   | 3BTQ                |
| LM2903BTQDGKRQ1.B               | Active        | Production           | VSSOP (DGK)   8 | 2500   LARGE T&R      | Yes         | NIPDAU                               | Level-1-260C-UNLIM                | -40 to 125   | 3BTQ                |
| <a href="#">LM2903BTQDRQ1</a>   | Active        | Production           | SOIC (D)   8    | 3000   LARGE T&R      | Yes         | NIPDAU                               | Level-1-260C-UNLIM                | -40 to 125   | 903BTQ              |
| LM2903BTQDRQ1.A                 | Active        | Production           | SOIC (D)   8    | 3000   LARGE T&R      | Yes         | NIPDAU                               | Level-1-260C-UNLIM                | -40 to 125   | 903BTQ              |
| LM2903BTQDRQ1.B                 | Active        | Production           | SOIC (D)   8    | 3000   LARGE T&R      | Yes         | NIPDAU                               | Level-1-260C-UNLIM                | -40 to 125   | 903BTQ              |
| <a href="#">LM2903BTQPWRQ1</a>  | Active        | Production           | TSSOP (PW)   8  | 3000   LARGE T&R      | Yes         | NIPDAU                               | Level-1-260C-UNLIM                | -40 to 125   | 2903BT              |
| LM2903BTQPWRQ1.A                | Active        | Production           | TSSOP (PW)   8  | 3000   LARGE T&R      | Yes         | NIPDAU                               | Level-1-260C-UNLIM                | -40 to 125   | 2903BT              |
| LM2903BTQPWRQ1.B                | Active        | Production           | TSSOP (PW)   8  | 3000   LARGE T&R      | Yes         | NIPDAU                               | Level-1-260C-UNLIM                | -40 to 125   | 2903BT              |
| <a href="#">LM2903BWDSGRQ1</a>  | Active        | Production           | WSON (DSG)   8  | 3000   LARGE T&R      | Yes         | Call TI   Sn                         | Level-2-260C-1 YEAR               | -40 to 125   | 3BWQ                |
| LM2903BWDSGRQ1.A                | Active        | Production           | WSON (DSG)   8  | 3000   LARGE T&R      | Yes         | SN                                   | Level-2-260C-1 YEAR               | -40 to 125   | 3BWQ                |
| LM2903BWDSGRQ1.B                | Active        | Production           | WSON (DSG)   8  | 3000   LARGE T&R      | Yes         | SN                                   | Level-2-260C-1 YEAR               | -40 to 125   | 3BWQ                |
| <a href="#">LM2903EPWRQ1</a>    | Active        | Production           | TSSOP (PW)   8  | 2000   LARGE T&R      | Yes         | NIPDAU                               | Level-2-260C-1 YEAR               | -40 to 150   | 2903Q0              |
| LM2903EPWRQ1.A                  | Active        | Production           | TSSOP (PW)   8  | 2000   LARGE T&R      | Yes         | NIPDAU                               | Level-2-260C-1 YEAR               | -40 to 150   | 2903Q0              |
| <a href="#">LM2903QDGKRQ1</a>   | Active        | Production           | VSSOP (DGK)   8 | 2500   LARGE T&R      | Yes         | NIPDAU                               | Level-1-260C-UNLIM                | -40 to 125   | KACQ                |
| LM2903QDGKRQ1.A                 | Active        | Production           | VSSOP (DGK)   8 | 2500   LARGE T&R      | Yes         | NIPDAU                               | Level-1-260C-UNLIM                | -40 to 125   | KACQ                |
| <a href="#">LM2903QDRG4Q1</a>   | Active        | Production           | SOIC (D)   8    | 2500   LARGE T&R      | Yes         | NIPDAU                               | Level-1-260C-UNLIM                | -40 to 125   | 2903Q1              |
| LM2903QDRG4Q1.A                 | Active        | Production           | SOIC (D)   8    | 2500   LARGE T&R      | Yes         | NIPDAU                               | Level-1-260C-UNLIM                | -40 to 125   | 2903Q1              |
| <a href="#">LM2903QDRQ1</a>     | Active        | Production           | SOIC (D)   8    | 2500   LARGE T&R      | Yes         | NIPDAU                               | Level-1-260C-UNLIM                | -40 to 125   | 2903Q1              |
| LM2903QDRQ1.A                   | Active        | Production           | SOIC (D)   8    | 2500   LARGE T&R      | Yes         | NIPDAU                               | Level-1-260C-UNLIM                | -40 to 125   | 2903Q1              |
| LM2903QDRQ1.B                   | Active        | Production           | SOIC (D)   8    | 2500   LARGE T&R      | Yes         | NIPDAU                               | Level-1-260C-UNLIM                | -40 to 125   | 2903Q1              |

| Orderable part number | Status<br>(1) | Material type<br>(2) | Package   Pins | Package qty   Carrier | RoHS<br>(3) | Lead finish/<br>Ball material<br>(4) | MSL rating/<br>Peak reflow<br>(5) | Op temp (°C) | Part marking<br>(6) |
|-----------------------|---------------|----------------------|----------------|-----------------------|-------------|--------------------------------------|-----------------------------------|--------------|---------------------|
| LM2903QPWRG4Q1        | Active        | Production           | TSSOP (PW)   8 | 2000   LARGE T&R      | Yes         | NIPDAU                               | Level-1-260C-UNLIM                | -40 to 125   | 2903Q1              |
| LM2903QPWRG4Q1.A      | Active        | Production           | TSSOP (PW)   8 | 2000   LARGE T&R      | Yes         | NIPDAU                               | Level-1-260C-UNLIM                | -40 to 125   | 2903Q1              |
| LM2903QPWRQ1          | Active        | Production           | TSSOP (PW)   8 | 2000   LARGE T&R      | Yes         | NIPDAU                               | Level-1-260C-UNLIM                | -40 to 125   | 2903Q1              |
| LM2903QPWRQ1.A        | Active        | Production           | TSSOP (PW)   8 | 2000   LARGE T&R      | Yes         | NIPDAU                               | Level-1-260C-UNLIM                | -40 to 125   | 2903Q1              |
| LM2903VQDRG4Q1        | Obsolete      | Production           | SOIC (D)   8   | -                     | -           | Call TI                              | Call TI                           | -40 to 125   | 2903VQ1             |
| LM2903VQDRQ1          | Active        | Production           | SOIC (D)   8   | 2500   LARGE T&R      | Yes         | NIPDAU                               | Level-1-260C-UNLIM                | -40 to 125   | 2903VQ1             |
| LM2903VQDRQ1.A        | Active        | Production           | SOIC (D)   8   | 2500   LARGE T&R      | Yes         | NIPDAU                               | Level-1-260C-UNLIM                | -40 to 125   | 2903VQ1             |
| LM2903VQDRQ1.B        | Active        | Production           | SOIC (D)   8   | 2500   LARGE T&R      | Yes         | NIPDAU                               | Level-1-260C-UNLIM                | -40 to 125   | 2903VQ1             |
| LM2903VQPWRG4Q1       | Active        | Production           | TSSOP (PW)   8 | 2000   LARGE T&R      | Yes         | NIPDAU                               | Level-1-260C-UNLIM                | -40 to 125   | 2903VQ              |
| LM2903VQPWRG4Q1.A     | Active        | Production           | TSSOP (PW)   8 | 2000   LARGE T&R      | Yes         | NIPDAU                               | Level-1-260C-UNLIM                | -40 to 125   | 2903VQ              |
| LM2903VQPWRG4Q1.B     | Active        | Production           | TSSOP (PW)   8 | 2000   LARGE T&R      | Yes         | NIPDAU                               | Level-1-260C-UNLIM                | -40 to 125   | 2903VQ              |
| LM2903VQPWRQ1         | Active        | Production           | TSSOP (PW)   8 | 2000   LARGE T&R      | Yes         | NIPDAU                               | Level-1-260C-UNLIM                | -40 to 125   | 2903VQ              |
| LM2903VQPWRQ1.A       | Active        | Production           | TSSOP (PW)   8 | 2000   LARGE T&R      | Yes         | NIPDAU                               | Level-1-260C-UNLIM                | -40 to 125   | 2903VQ              |
| LM2903VQPWRQ1.B       | Active        | Production           | TSSOP (PW)   8 | 2000   LARGE T&R      | Yes         | NIPDAU                               | Level-1-260C-UNLIM                | -40 to 125   | 2903VQ              |

(1) **Status:** For more details on status, see our [product life cycle](#).

(2) **Material type:** When designated, preproduction parts are prototypes/experimental devices, and are not yet approved or released for full production. Testing and final process, including without limitation quality assurance, reliability performance testing, and/or process qualification, may not yet be complete, and this item is subject to further changes or possible discontinuation. If available for ordering, purchases will be subject to an additional waiver at checkout, and are intended for early internal evaluation purposes only. These items are sold without warranties of any kind.

(3) **RoHS values:** Yes, No, RoHS Exempt. See the [TI RoHS Statement](#) for additional information and value definition.

(4) **Lead finish/Ball material:** Parts may have multiple material finish options. Finish options are separated by a vertical ruled line. Lead finish/Ball material values may wrap to two lines if the finish value exceeds the maximum column width.

(5) **MSL rating/Peak reflow:** The moisture sensitivity level ratings and peak solder (reflow) temperatures. In the event that a part has multiple moisture sensitivity ratings, only the lowest level per JEDEC standards is shown. Refer to the shipping label for the actual reflow temperature that will be used to mount the part to the printed circuit board.

(6) **Part marking:** There may be an additional marking, which relates to the logo, the lot trace code information, or the environmental category of the part.

Multiple part markings will be inside parentheses. Only one part marking contained in parentheses and separated by a "-" will appear on a part. If a line is indented then it is a continuation of the previous line and the two combined represent the entire part marking for that device.

**Important Information and Disclaimer:** The information provided on this page represents TI's knowledge and belief as of the date that it is provided. TI bases its knowledge and belief on information provided by third parties, and makes no representation or warranty as to the accuracy of such information. Efforts are underway to better integrate information from third parties. TI has taken and continues to take reasonable steps to provide representative and accurate information but may not have conducted destructive testing or chemical analysis on incoming materials and chemicals. TI and TI suppliers consider certain information to be proprietary, and thus CAS numbers and other limited information may not be available for release.

In no event shall TI's liability arising out of such information exceed the total purchase price of the TI part(s) at issue in this document sold by TI to Customer on an annual basis.

**OTHER QUALIFIED VERSIONS OF LM2903-Q1, LM2903B-Q1 :**

- Catalog : [LM2903](#), [LM2903B](#)

NOTE: Qualified Version Definitions:

- Catalog - TI's standard catalog product

## TAPE AND REEL INFORMATION



### QUADRANT ASSIGNMENTS FOR PIN 1 ORIENTATION IN TAPE

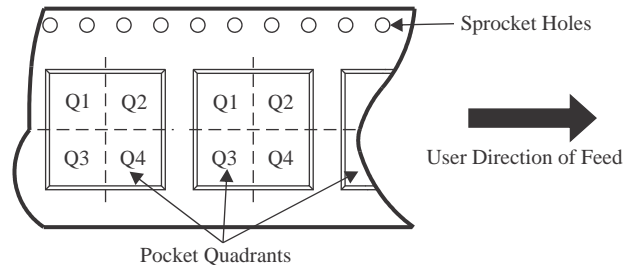

\*All dimensions are nominal

| Device           | Package Type | Package Drawing | Pins | SPQ  | Reel Diameter (mm) | Reel Width W1 (mm) | A0 (mm) | B0 (mm) | K0 (mm) | P1 (mm) | W (mm) | Pin1 Quadrant |
|------------------|--------------|-----------------|------|------|--------------------|--------------------|---------|---------|---------|---------|--------|---------------|
| LM2903AVQDRG4Q1  | SOIC         | D               | 8    | 2500 | 330.0              | 12.4               | 6.4     | 5.2     | 2.1     | 8.0     | 12.0   | Q1            |
| LM2903AVQDRG4Q1  | SOIC         | D               | 8    | 2500 | 330.0              | 12.4               | 6.4     | 5.2     | 2.1     | 8.0     | 12.0   | Q1            |
| LM2903AVQDRQ1    | SOIC         | D               | 8    | 2500 | 330.0              | 12.5               | 6.4     | 5.2     | 2.1     | 8.0     | 12.0   | Q1            |
| LM2903AVQDRQ1    | SOIC         | D               | 8    | 2500 | 330.0              | 12.4               | 6.4     | 5.2     | 2.1     | 8.0     | 12.0   | Q1            |
| LM2903AVQPWRG4Q1 | TSSOP        | PW              | 8    | 2000 | 330.0              | 12.4               | 7.0     | 3.6     | 1.6     | 8.0     | 12.0   | Q1            |
| LM2903AVQPWRQ1   | TSSOP        | PW              | 8    | 2000 | 330.0              | 12.4               | 7.0     | 3.6     | 1.6     | 8.0     | 12.0   | Q1            |
| LM2903BHQDGKRQ1  | VSSOP        | DGK             | 8    | 2500 | 330.0              | 12.4               | 5.25    | 3.35    | 1.25    | 8.0     | 12.0   | Q1            |
| LM2903BHQDRQ1    | SOIC         | D               | 8    | 3000 | 330.0              | 12.4               | 6.4     | 5.2     | 2.1     | 8.0     | 12.0   | Q1            |
| LM2903BHQPWRQ1   | TSSOP        | PW              | 8    | 3000 | 330.0              | 12.4               | 7.0     | 3.6     | 1.6     | 8.0     | 12.0   | Q1            |
| LM2903BQDDFRQ1   | SOT-23-THIN  | DDF             | 8    | 3000 | 180.0              | 8.4                | 3.2     | 3.2     | 1.4     | 4.0     | 8.0    | Q3            |
| LM2903BQDGKRQ1   | VSSOP        | DGK             | 8    | 2500 | 330.0              | 12.4               | 5.25    | 3.35    | 1.25    | 8.0     | 12.0   | Q1            |
| LM2903BQDRQ1     | SOIC         | D               | 8    | 2500 | 330.0              | 12.4               | 6.4     | 5.2     | 2.1     | 8.0     | 12.0   | Q1            |
| LM2903BQPWRQ1    | TSSOP        | PW              | 8    | 2000 | 330.0              | 12.4               | 7.0     | 3.6     | 1.6     | 8.0     | 12.0   | Q1            |
| LM2903BRQDGKRQ1  | VSSOP        | DGK             | 8    | 2500 | 330.0              | 12.4               | 5.25    | 3.35    | 1.25    | 8.0     | 12.0   | Q1            |
| LM2903BRQDRQ1    | SOIC         | D               | 8    | 3000 | 330.0              | 12.4               | 6.4     | 5.2     | 2.1     | 8.0     | 12.0   | Q1            |

| Device          | Package Type | Package Drawing | Pins | SPQ  | Reel Diameter (mm) | Reel Width W1 (mm) | A0 (mm) | B0 (mm) | K0 (mm) | P1 (mm) | W (mm) | Pin1 Quadrant |
|-----------------|--------------|-----------------|------|------|--------------------|--------------------|---------|---------|---------|---------|--------|---------------|
| LM2903BRQPWRQ1  | TSSOP        | PW              | 8    | 3000 | 330.0              | 12.4               | 7.0     | 3.6     | 1.6     | 8.0     | 12.0   | Q1            |
| LM2903BTQDGKRQ1 | VSSOP        | DGK             | 8    | 2500 | 330.0              | 12.4               | 5.25    | 3.35    | 1.25    | 8.0     | 12.0   | Q1            |
| LM2903BTQDRQ1   | SOIC         | D               | 8    | 3000 | 330.0              | 12.4               | 6.4     | 5.2     | 2.1     | 8.0     | 12.0   | Q1            |
| LM2903BTQPWRQ1  | TSSOP        | PW              | 8    | 3000 | 330.0              | 12.4               | 7.0     | 3.6     | 1.6     | 8.0     | 12.0   | Q1            |
| LM2903BWDSGRQ1  | WSON         | DSG             | 8    | 3000 | 180.0              | 8.4                | 2.2     | 2.2     | 1.2     | 4.0     | 8.0    | Q2            |
| LM2903EPWRQ1    | TSSOP        | PW              | 8    | 2000 | 330.0              | 12.4               | 7.0     | 3.6     | 1.6     | 8.0     | 12.0   | Q1            |
| LM2903QDGKRQ1   | VSSOP        | DGK             | 8    | 2500 | 330.0              | 12.4               | 6.4     | 5.2     | 2.1     | 8.0     | 12.0   | Q1            |
| LM2903QDRG4Q1   | SOIC         | D               | 8    | 2500 | 330.0              | 12.4               | 6.4     | 5.2     | 2.1     | 8.0     | 12.0   | Q1            |
| LM2903QDRG4Q1   | SOIC         | D               | 8    | 2500 | 330.0              | 12.4               | 6.4     | 5.2     | 2.1     | 8.0     | 12.0   | Q1            |
| LM2903QDRQ1     | SOIC         | D               | 8    | 2500 | 330.0              | 12.4               | 6.4     | 5.2     | 2.1     | 8.0     | 12.0   | Q1            |
| LM2903QPWRG4Q1  | TSSOP        | PW              | 8    | 2000 | 330.0              | 12.4               | 7.0     | 3.6     | 1.6     | 8.0     | 12.0   | Q1            |
| LM2903QPWRQ1    | TSSOP        | PW              | 8    | 2000 | 330.0              | 12.4               | 7.0     | 3.6     | 1.6     | 8.0     | 12.0   | Q1            |
| LM2903VQDRQ1    | SOIC         | D               | 8    | 2500 | 330.0              | 12.4               | 6.4     | 5.2     | 2.1     | 8.0     | 12.0   | Q1            |
| LM2903VQPWRG4Q1 | TSSOP        | PW              | 8    | 2000 | 330.0              | 12.4               | 7.0     | 3.6     | 1.6     | 8.0     | 12.0   | Q1            |
| LM2903VQPWRQ1   | TSSOP        | PW              | 8    | 2000 | 330.0              | 12.4               | 7.0     | 3.6     | 1.6     | 8.0     | 12.0   | Q1            |

**TAPE AND REEL BOX DIMENSIONS**

\*All dimensions are nominal

| Device           | Package Type | Package Drawing | Pins | SPQ  | Length (mm) | Width (mm) | Height (mm) |
|------------------|--------------|-----------------|------|------|-------------|------------|-------------|
| LM2903AVQDRG4Q1  | SOIC         | D               | 8    | 2500 | 353.0       | 353.0      | 32.0        |
| LM2903AVQDRG4Q1  | SOIC         | D               | 8    | 2500 | 340.5       | 338.1      | 20.6        |
| LM2903AVQDRQ1    | SOIC         | D               | 8    | 2500 | 353.0       | 353.0      | 32.0        |
| LM2903AVQDRQ1    | SOIC         | D               | 8    | 2500 | 340.5       | 338.1      | 20.6        |
| LM2903AVQPWRG4Q1 | TSSOP        | PW              | 8    | 2000 | 353.0       | 353.0      | 32.0        |
| LM2903AVQPWRQ1   | TSSOP        | PW              | 8    | 2000 | 353.0       | 353.0      | 32.0        |
| LM2903BHQDGKRQ1  | VSSOP        | DGK             | 8    | 2500 | 366.0       | 364.0      | 50.0        |
| LM2903BHQDRQ1    | SOIC         | D               | 8    | 3000 | 340.5       | 338.1      | 20.6        |
| LM2903BHQPWRQ1   | TSSOP        | PW              | 8    | 3000 | 353.0       | 353.0      | 32.0        |
| LM2903BQDDFRQ1   | SOT-23-THIN  | DDF             | 8    | 3000 | 210.0       | 185.0      | 35.0        |
| LM2903BQDGKRQ1   | VSSOP        | DGK             | 8    | 2500 | 366.0       | 364.0      | 50.0        |
| LM2903BQDRQ1     | SOIC         | D               | 8    | 2500 | 353.0       | 353.0      | 32.0        |
| LM2903BQPWRQ1    | TSSOP        | PW              | 8    | 2000 | 353.0       | 353.0      | 32.0        |
| LM2903BRQDGKRQ1  | VSSOP        | DGK             | 8    | 2500 | 366.0       | 364.0      | 50.0        |
| LM2903BRQDRQ1    | SOIC         | D               | 8    | 3000 | 340.5       | 338.1      | 20.6        |
| LM2903BRQPWRQ1   | TSSOP        | PW              | 8    | 3000 | 353.0       | 353.0      | 32.0        |
| LM2903BTQDGKRQ1  | VSSOP        | DGK             | 8    | 2500 | 366.0       | 364.0      | 50.0        |
| LM2903BTQDRQ1    | SOIC         | D               | 8    | 3000 | 340.5       | 338.1      | 20.6        |

| Device          | Package Type | Package Drawing | Pins | SPQ  | Length (mm) | Width (mm) | Height (mm) |
|-----------------|--------------|-----------------|------|------|-------------|------------|-------------|
| LM2903BTQPWRQ1  | TSSOP        | PW              | 8    | 3000 | 353.0       | 353.0      | 32.0        |
| LM2903BWDSGRQ1  | WSON         | DSG             | 8    | 3000 | 213.0       | 191.0      | 35.0        |
| LM2903EPWRQ1    | TSSOP        | PW              | 8    | 2000 | 353.0       | 353.0      | 32.0        |
| LM2903QDGKRQ1   | VSSOP        | DGK             | 8    | 2500 | 353.0       | 353.0      | 32.0        |
| LM2903QDRG4Q1   | SOIC         | D               | 8    | 2500 | 340.5       | 338.1      | 20.6        |
| LM2903QDRG4Q1   | SOIC         | D               | 8    | 2500 | 353.0       | 353.0      | 32.0        |
| LM2903QDRQ1     | SOIC         | D               | 8    | 2500 | 353.0       | 353.0      | 32.0        |
| LM2903QPWRG4Q1  | TSSOP        | PW              | 8    | 2000 | 353.0       | 353.0      | 32.0        |
| LM2903QPWRQ1    | TSSOP        | PW              | 8    | 2000 | 353.0       | 353.0      | 32.0        |
| LM2903VQDRQ1    | SOIC         | D               | 8    | 2500 | 353.0       | 353.0      | 32.0        |
| LM2903VQPWRG4Q1 | TSSOP        | PW              | 8    | 2000 | 353.0       | 353.0      | 32.0        |
| LM2903VQPWRQ1   | TSSOP        | PW              | 8    | 2000 | 353.0       | 353.0      | 32.0        |

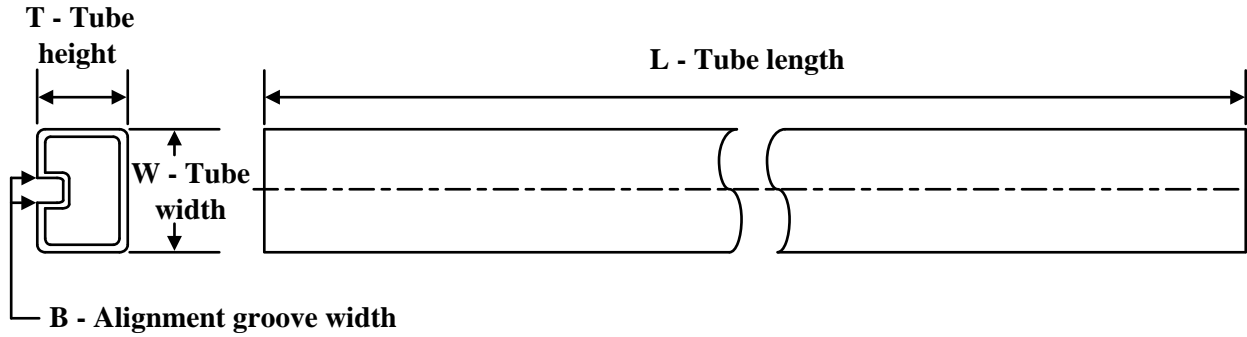
**TUBE**

\*All dimensions are nominal

| Device           | Package Name | Package Type | Pins | SPQ  | L (mm) | W (mm) | T (μm) | B (mm) |
|------------------|--------------|--------------|------|------|--------|--------|--------|--------|
| LM2903BQDGKRQ1   | DGK          | VSSOP        | 8    | 2500 | 328    | 7.98   | 550    | NA     |
| LM2903BQDGKRQ1.A | DGK          | VSSOP        | 8    | 2500 | 328    | 7.98   | 550    | NA     |
| LM2903BQDGKRQ1.B | DGK          | VSSOP        | 8    | 2500 | 328    | 7.98   | 550    | NA     |

# DDF0008A



# PACKAGE OUTLINE

## SOT-23-THIN - 1.1 mm max height

PLASTIC SMALL OUTLINE

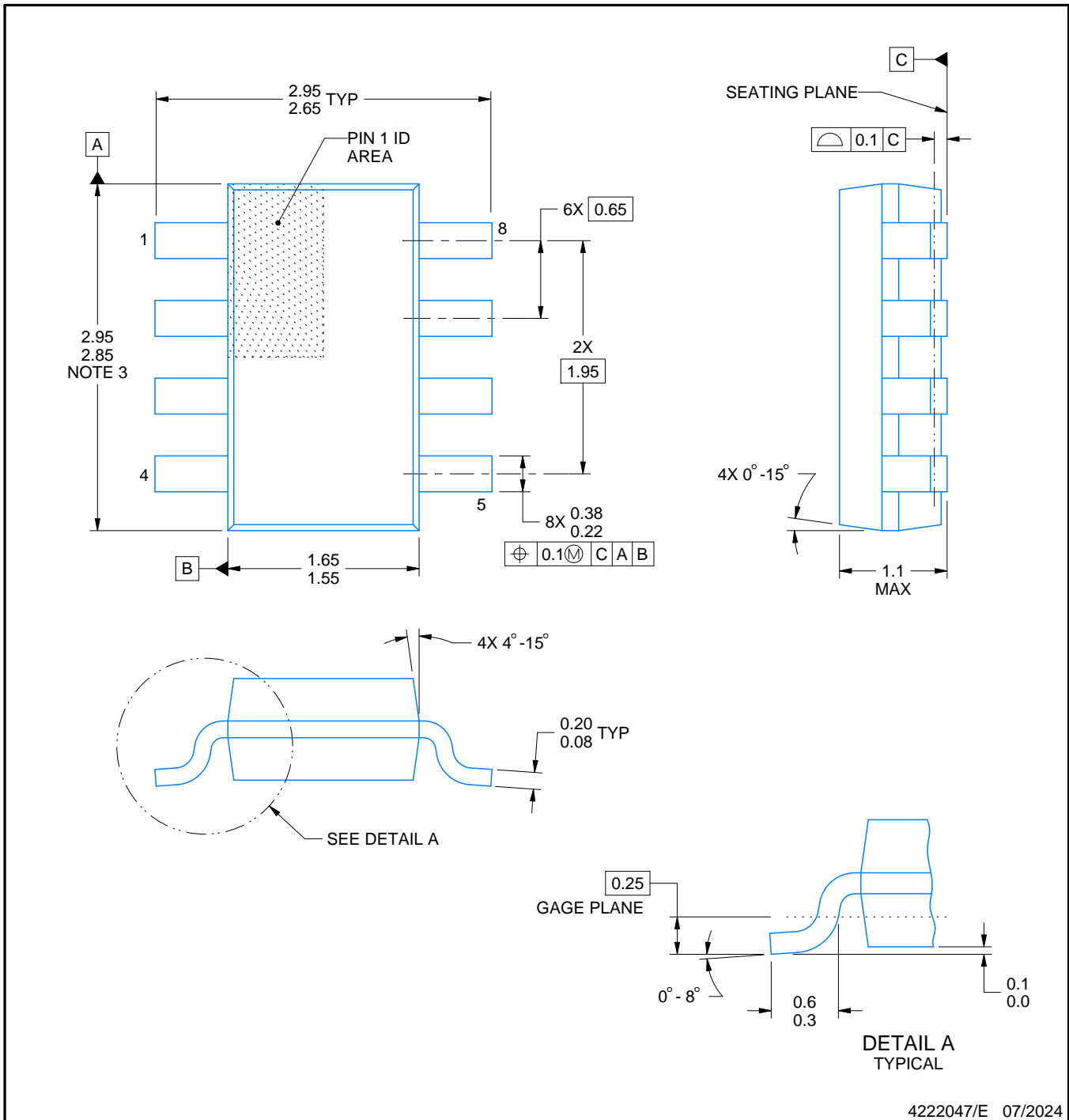

4222047/E 07/2024

### NOTES:

- All linear dimensions are in millimeters. Any dimensions in parenthesis are for reference only. Dimensioning and tolerancing per ASME Y14.5M.
- This drawing is subject to change without notice.
- This dimension does not include mold flash, protrusions, or gate burrs. Mold flash, protrusions, or gate burrs shall not exceed 0.15 mm per side.

# EXAMPLE BOARD LAYOUT

DDF0008A

SOT-23-THIN - 1.1 mm max height

PLASTIC SMALL OUTLINE

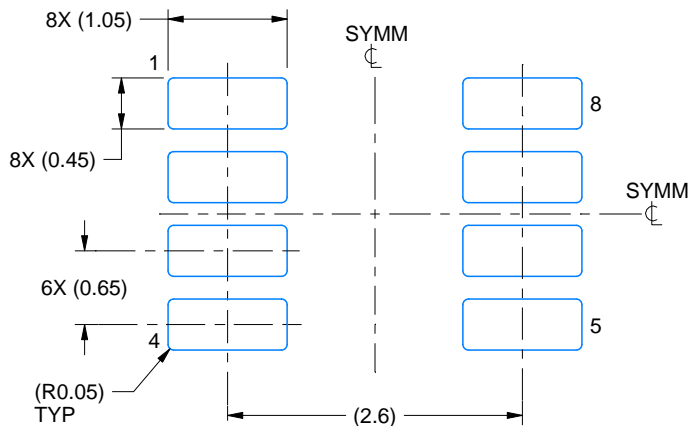

LAND PATTERN EXAMPLE  
EXPOSED METAL SHOWN  
SCALE:15X

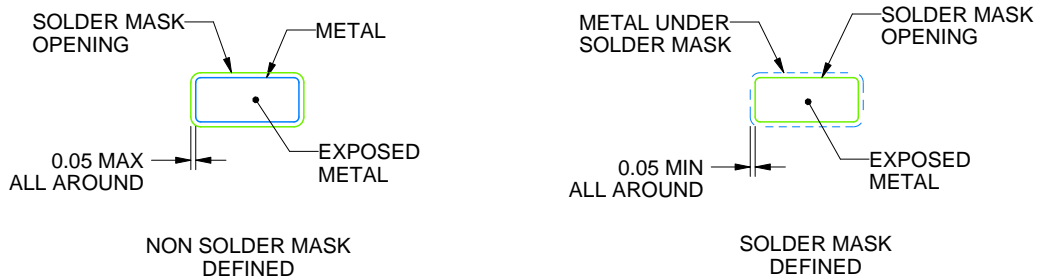

SOLDER MASK DETAILS

4222047/E 07/2024

NOTES: (continued)

- 4. Publication IPC-7351 may have alternate designs.
- 5. Solder mask tolerances between and around signal pads can vary based on board fabrication site.

# EXAMPLE STENCIL DESIGN

DDF0008A

SOT-23-THIN - 1.1 mm max height

PLASTIC SMALL OUTLINE

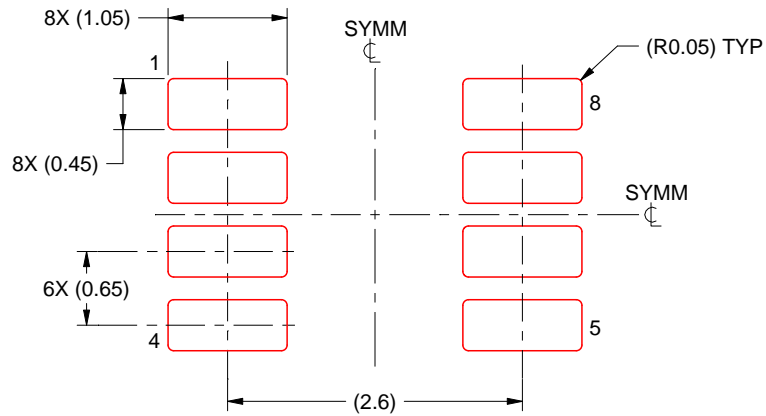

SOLDER PASTE EXAMPLE  
BASED ON 0.125 mm THICK STENCIL  
SCALE:15X

4222047/E 07/2024

NOTES: (continued)

6. Laser cutting apertures with trapezoidal walls and rounded corners may offer better paste release. IPC-7525 may have alternate design recommendations.
7. Board assembly site may have different recommendations for stencil design.



D0008A

# PACKAGE OUTLINE

SOIC - 1.75 mm max height

SMALL OUTLINE INTEGRATED CIRCUIT



4214825/C 02/2019

### NOTES:

1. Linear dimensions are in inches [millimeters]. Dimensions in parenthesis are for reference only. Controlling dimensions are in inches. Dimensioning and tolerancing per ASME Y14.5M.
2. This drawing is subject to change without notice.
3. This dimension does not include mold flash, protrusions, or gate burrs. Mold flash, protrusions, or gate burrs shall not exceed  $.006$  [0.15] per side.
4. This dimension does not include interlead flash.
5. Reference JEDEC registration MS-012, variation AA.

# EXAMPLE BOARD LAYOUT

D0008A

SOIC - 1.75 mm max height

SMALL OUTLINE INTEGRATED CIRCUIT



LAND PATTERN EXAMPLE  
 EXPOSED METAL SHOWN  
 SCALE:8X



SOLDER MASK DETAILS

4214825/C 02/2019

NOTES: (continued)

- 6. Publication IPC-7351 may have alternate designs.
- 7. Solder mask tolerances between and around signal pads can vary based on board fabrication site.

# EXAMPLE STENCIL DESIGN

D0008A

SOIC - 1.75 mm max height

SMALL OUTLINE INTEGRATED CIRCUIT



SOLDER PASTE EXAMPLE  
BASED ON .005 INCH [0.125 MM] THICK STENCIL  
SCALE:8X

4214825/C 02/2019

NOTES: (continued)

8. Laser cutting apertures with trapezoidal walls and rounded corners may offer better paste release. IPC-7525 may have alternate design recommendations.
9. Board assembly site may have different recommendations for stencil design.

## GENERIC PACKAGE VIEW

**DSG 8**

**WSON - 0.8 mm max height**

2 x 2, 0.5 mm pitch

PLASTIC SMALL OUTLINE - NO LEAD

This image is a representation of the package family, actual package may vary.  
Refer to the product data sheet for package details.

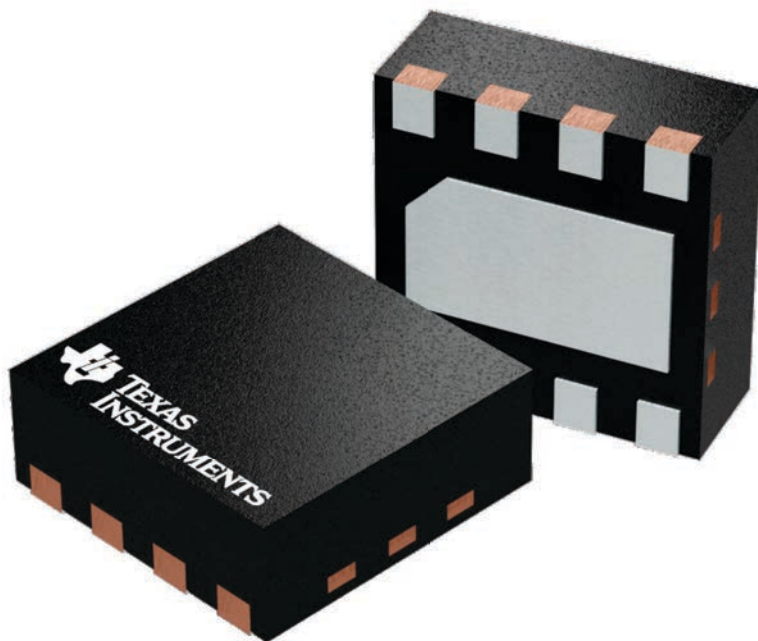

4224783/A

# DSG0008B

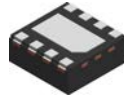

# PACKAGE OUTLINE

## WSON - 0.8 mm max height

PLASTIC SMALL OUTLINE - NO LEAD

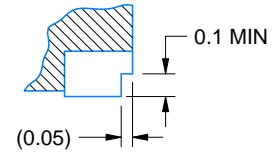
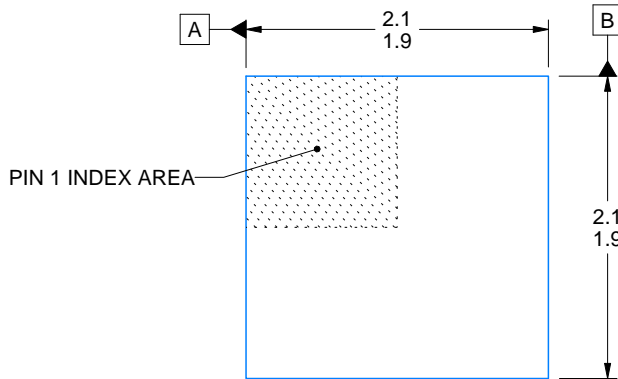

SECTION A-A TYPICAL

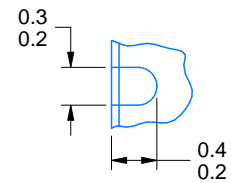

ALTERNATIVE TERMINAL SHAPE TYPICAL

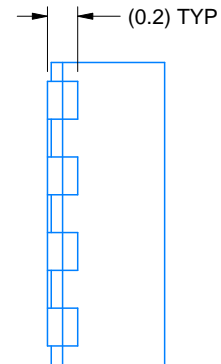
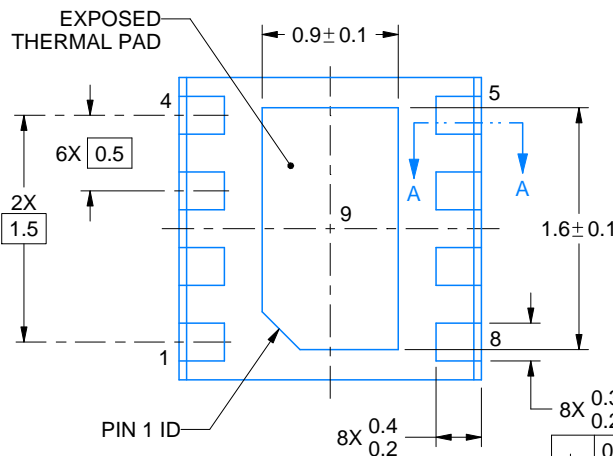
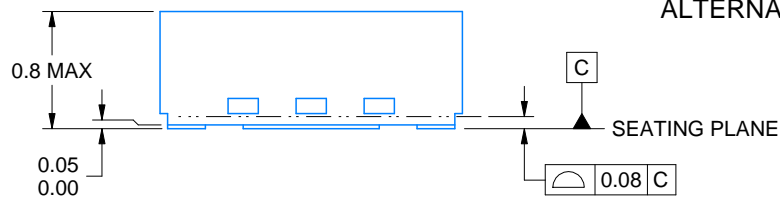

|   |          |   |   |   |
|---|----------|---|---|---|
| ⌀ | 0.1 (M)  | C | A | B |
|   | 0.05 (M) | C |   |   |

4222124/E 05/2020

NOTES:

1. All linear dimensions are in millimeters. Any dimensions in parenthesis are for reference only. Dimensioning and tolerancing per ASME Y14.5M.
2. This drawing is subject to change without notice.
3. The package thermal pad must be soldered to the printed circuit board for thermal and mechanical performance.

# EXAMPLE BOARD LAYOUT

DSG0008B

WSON - 0.8 mm max height

PLASTIC SMALL OUTLINE - NO LEAD

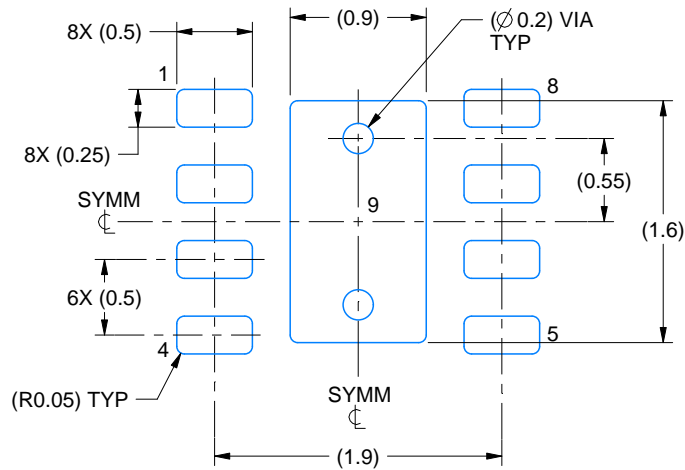

LAND PATTERN EXAMPLE  
EXPOSED METAL SHOWN  
SCALE:20X

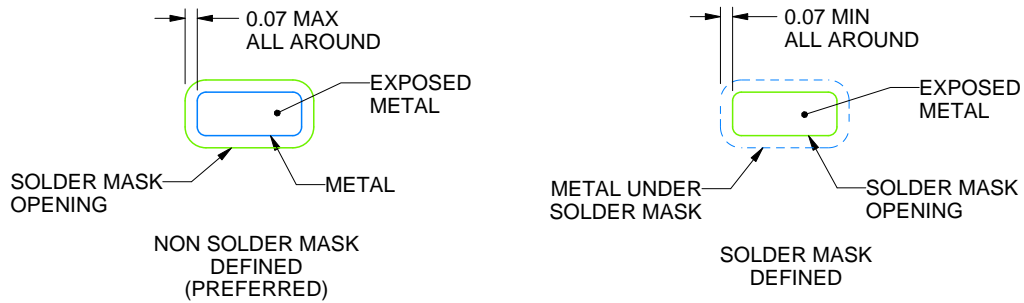

SOLDER MASK DETAILS

4222124/E 05/2020

NOTES: (continued)

4. This package is designed to be soldered to a thermal pad on the board. For more information, see Texas Instruments literature number SLUA271 ([www.ti.com/lit/slua271](http://www.ti.com/lit/slua271)).
5. Vias are optional depending on application, refer to device data sheet. If any vias are implemented, refer to their locations shown on this view. It is recommended that vias under paste be filled, plugged or tented.

# EXAMPLE STENCIL DESIGN

DSG0008B

WSON - 0.8 mm max height

PLASTIC SMALL OUTLINE - NO LEAD

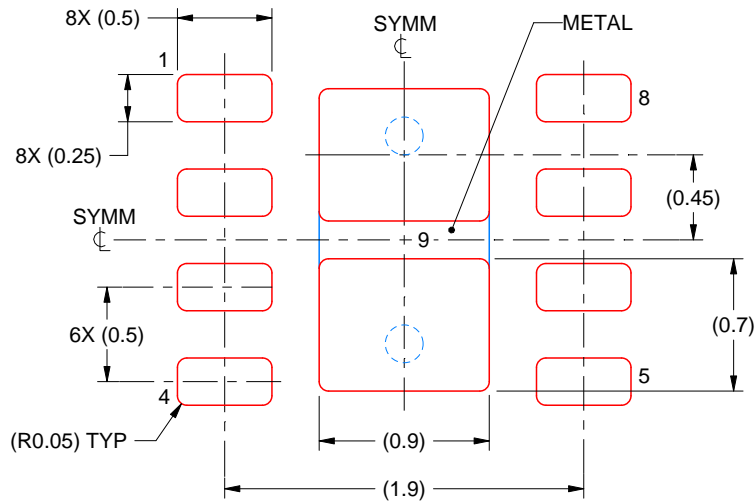

SOLDER PASTE EXAMPLE  
BASED ON 0.125 mm THICK STENCIL

EXPOSED PAD 9:  
87% PRINTED SOLDER COVERAGE BY AREA UNDER PACKAGE  
SCALE:25X

4222124/E 05/2020

NOTES: (continued)

6. Laser cutting apertures with trapezoidal walls and rounded corners may offer better paste release. IPC-7525 may have alternate design recommendations.

PW0008A



PACKAGE OUTLINE  
TSSOP - 1.2 mm max height

SMALL OUTLINE PACKAGE

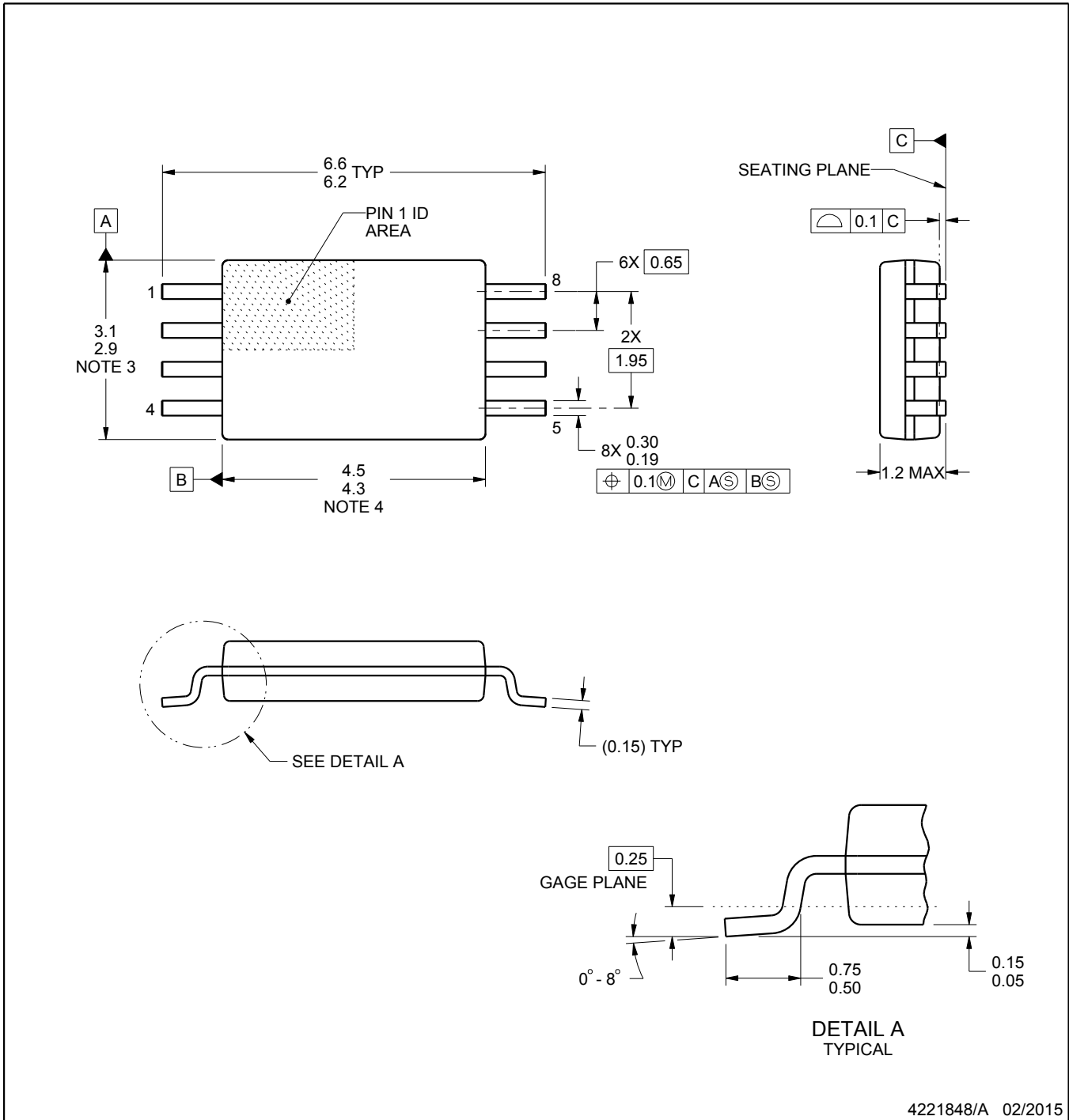

4221848/A 02/2015

NOTES:

1. All linear dimensions are in millimeters. Any dimensions in parenthesis are for reference only. Dimensioning and tolerancing per ASME Y14.5M.
2. This drawing is subject to change without notice.
3. This dimension does not include mold flash, protrusions, or gate burrs. Mold flash, protrusions, or gate burrs shall not exceed 0.15 mm per side.
4. This dimension does not include interlead flash. Interlead flash shall not exceed 0.25 mm per side.
5. Reference JEDEC registration MO-153, variation AA.

# EXAMPLE BOARD LAYOUT

PW0008A

TSSOP - 1.2 mm max height

SMALL OUTLINE PACKAGE



LAND PATTERN EXAMPLE  
SCALE:10X

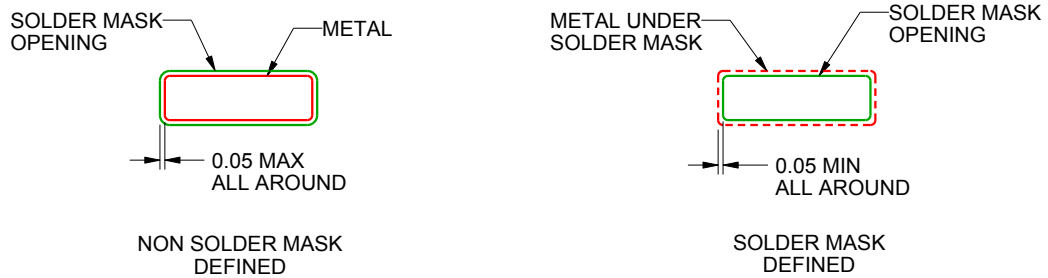

SOLDER MASK DETAILS  
NOT TO SCALE

4221848/A 02/2015

NOTES: (continued)

- 6. Publication IPC-7351 may have alternate designs.
- 7. Solder mask tolerances between and around signal pads can vary based on board fabrication site.

# EXAMPLE STENCIL DESIGN

PW0008A

TSSOP - 1.2 mm max height

SMALL OUTLINE PACKAGE



SOLDER PASTE EXAMPLE  
BASED ON 0.125 mm THICK STENCIL  
SCALE:10X

4221848/A 02/2015

NOTES: (continued)

8. Laser cutting apertures with trapezoidal walls and rounded corners may offer better paste release. IPC-7525 may have alternate design recommendations.
9. Board assembly site may have different recommendations for stencil design.

# DGK0008A



# PACKAGE OUTLINE

VSSOP - 1.1 mm max height

SMALL OUTLINE PACKAGE



**NOTES:**

PowerPAD is a trademark of Texas Instruments.

1. All linear dimensions are in millimeters. Any dimensions in parenthesis are for reference only. Dimensioning and tolerancing per ASME Y14.5M.
2. This drawing is subject to change without notice.
3. This dimension does not include mold flash, protrusions, or gate burrs. Mold flash, protrusions, or gate burrs shall not exceed 0.15 mm per side.
4. This dimension does not include interlead flash. Interlead flash shall not exceed 0.25 mm per side.
5. Reference JEDEC registration MO-187.

# EXAMPLE BOARD LAYOUT

DGK0008A

™ VSSOP - 1.1 mm max height

SMALL OUTLINE PACKAGE



LAND PATTERN EXAMPLE  
EXPOSED METAL SHOWN  
SCALE: 15X

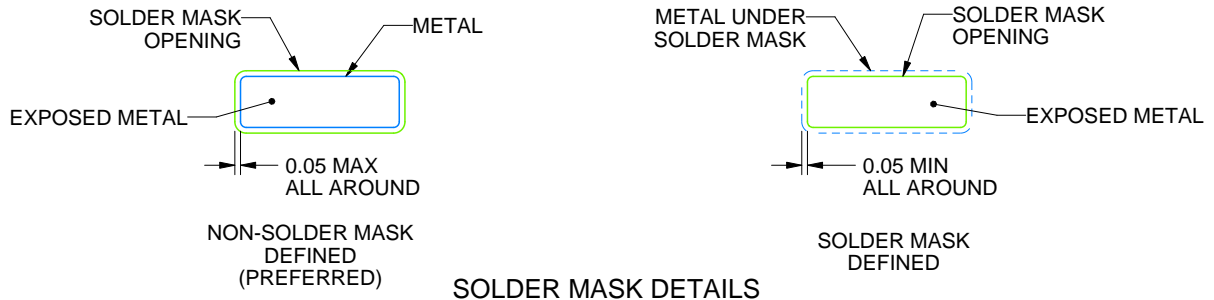

SOLDER MASK DETAILS

4214862/A 04/2023

NOTES: (continued)

6. Publication IPC-7351 may have alternate designs.
7. Solder mask tolerances between and around signal pads can vary based on board fabrication site.
8. Vias are optional depending on application, refer to device data sheet. If any vias are implemented, refer to their locations shown on this view. It is recommended that vias under paste be filled, plugged or tented.
9. Size of metal pad may vary due to creepage requirement.

# EXAMPLE STENCIL DESIGN

DGK0008A

<sup>TM</sup> VSSOP - 1.1 mm max height

SMALL OUTLINE PACKAGE



SOLDER PASTE EXAMPLE  
SCALE: 15X

4214862/A 04/2023

NOTES: (continued)

11. Laser cutting apertures with trapezoidal walls and rounded corners may offer better paste release. IPC-7525 may have alternate design recommendations.
12. Board assembly site may have different recommendations for stencil design.

## 重要なお知らせと免責事項

TI は、技術データと信頼性データ (データシートを含みます)、設計リソース (リファレンス デザインを含みます)、アプリケーションや設計に関する各種アドバイス、Web ツール、安全性情報、その他のリソースを、欠陥が存在する可能性のある「現状のまま」提供しており、商品性および特定目的に対する適合性の黙示保証、第三者の知的財産権の非侵害保証を含むいかなる保証も、明示的または黙示的にかかわらず拒否します。

これらのリソースは、TI 製品を使用する設計の経験を積んだ開発者への提供を意図したものです。(1) お客様のアプリケーションに適した TI 製品の選定、(2) お客様のアプリケーションの設計、検証、試験、(3) お客様のアプリケーションに該当する各種規格や、その他のあらゆる安全性、セキュリティ、規制、または他の要件への確実な適合に関する責任を、お客様のみが単独で負うものとし、

上記の各種リソースは、予告なく変更される可能性があります。これらのリソースは、リソースで説明されている TI 製品を使用するアプリケーションの開発の目的でのみ、TI はその使用をお客様に許諾します。これらのリソースに関して、他の目的で複製することや掲載することは禁止されています。TI や第三者の知的財産権のライセンスが付与されている訳ではありません。お客様は、これらのリソースを自身で使用した結果発生するあらゆる申し立て、損害、費用、損失、責任について、TI およびその代理人を完全に補償するものとし、TI は一切の責任を拒否します。

TI の製品は、[TI の販売条件](#)、[TI の総合的な品質ガイドライン](#)、[ti.com](#) または TI 製品などに関連して提供される他の適用条件に従い提供されます。TI がこれらのリソースを提供することは、適用される TI の保証または他の保証の放棄の拡大や変更を意味するものではありません。TI がカスタム、またはカスタマー仕様として明示的に指定していない限り、TI の製品は標準的なカタログに掲載される汎用機器です。

お客様がいかなる追加条項または代替条項を提案する場合も、TI はそれらに異議を唱え、拒否します。

Copyright © 2026, Texas Instruments Incorporated

最終更新日 : 2025 年 10 月