

LM393B、LM2903B、LM193、LM293、LM393、LM2903 デュアルコンパレータ

1 特長

- 新しい **LM393B** および **LM2903B**
- **B** バージョンの仕様を改善
 - 最大定格:最大 38V
 - ESD 定格 (HBM):2kV
 - 低入力オフセット:0.37mV
 - 低い入力バイアス電流:3.5nA
 - 低消費電流:200µA (コンパレータあたり)
 - 1µsec の短い応答時間
 - 拡張温度範囲 (LM393B)
 - 超小型の 2 x 2mm WSON パッケージで提供
- **B** バージョンは、LM293、LM393、LM2903 の **A** および **V** バージョンをそのまま置き換えることが可能
- 同相入力電圧範囲にグランドを含む
- 差動入力電圧範囲が最大定格電源電圧と同じ:±38V
- 低い出力飽和電圧
- TTL、MOS、CMOS 互換出力

2 アプリケーション

- ロボット掃除機
- 単相 UPS
- サーバー PSU
- コードレス電動工具
- ワイヤレス インフラ
- 電化製品
- ビル オートメーション
- ファクトリ オートメーション / 制御
- モータードライブ
- インフォテインメントおよびクラスタ

3 概要

LM393B および **LM2903B** デバイスは、業界標準の **LM393** および **LM2903** コンパレータ ファミリの次世代バージョンです。これらの次世代 **B** バージョン コンパレータは、小さいオフセット電圧、高い電源電圧への対応、小さい消費電流、小さい入力バイアス電流、短い伝搬遅延、および専用の ESD クランプによる優れた 2kV の ESD 性能と入力の耐久性が特長です。LM393B および LM2903B は、LM293、LM393 および LM2903 (「A」および「V」グレード) をそのまま置き換えることができます。

すべてのデバイスは、広い電圧範囲にわたって単一電源で動作するように設計された 2 つの独立した電圧コンパレータで構成されています。静止電流は、電源電圧にかかわらず一定です。

製品情報

部品番号	パッケージ (1)	本体サイズ (公称)
LM393B、LM2903B、LM193、LM293、LM293A、LM393、LM393A、LM2903、LM2903V、LM2903AV	SOIC (8)	4.90 mm × 3.91mm
LM393B、LM2903B、LM293、LM293A、LM393、LM393A、LM2903	VSSOP (8)	3.00 mm × 3.00mm
LM293、LM393、LM393A、LM2903	PDIP (8)	9.81mm × 6.35mm
LM393、LM393A、LM2903	SO (8)	6.20 mm × 5.30mm
LM393B、LM2903B、LM393、LM393A、LM2903、LM2903V、LM2903AV	TSSOP (8)	3.00 mm × 4.40mm
LM393B、LM2903B	SOT-23 (8)	2.90 mm × 1.60mm
LM393B、LM2903B	WSON (8)	2.00mm × 2.00mm

(1) 利用可能なすべてのパッケージについては、データシートの末尾にある注文情報を参照してください。

ファミリ比較表

仕様	LM393B	LM2903B	LM393 LM393A	LM2903	LM2903V LM2903AV	LM193	LM293 LM293A	単位
電源電圧	2~36	2~36	2~30	2~30	2~32	2~30	2~30	V
総電源電流 (5V~36V、最大値)	0.6~0.8	0.6~0.8	1~2.5	1~2.5	1~2.5	1~2.5	1~2.5	mA
温度範囲	-40~85	-40~125	0~70	-40~125	-40~125	-55~125	-25~85	°C
静電気放電 (HBM)	2000	2000	1000	1000	1000	1000	1000	V
オフセット電圧 (全温度範囲での最大値)	±4	±4	±9 ±4	±15	±15 ±4	±9	±9 ±4	mV
入力バイアス電流 (標準値 / 最大値)	3.5 / 25	3.5 / 25	25 / 250	25 / 250	25 / 250	25 / 100	25 / 250	nA
応答時間 (標準値)	1	1	1.3	1.3	1.3	1.3	1.3	µsec

目次

1 特長.....	1	5.12 代表的特性、LMx93x および LM2903x.....	11
2 アプリケーション.....	1	6 詳細説明.....	17
3 概要.....	1	6.1 概要.....	17
4 ピン構成および機能.....	3	6.2 機能ブロック図.....	17
5 仕様.....	4	6.3 機能説明.....	17
5.1 絶対最大定格.....	4	6.4 デバイスの機能モード.....	17
5.2 推奨動作条件.....	4	7 アプリケーションと実装.....	18
5.3 熱に関する情報: LMx93x、LM2903x.....	5	7.1 アプリケーション情報.....	18
5.4 ESD 定格.....	5	7.2 代表的なアプリケーション.....	18
5.5 電気的特性 LM393B.....	6	8 デバイスおよびドキュメントのサポート.....	21
5.6 電気的特性 LM2903B.....	7	8.1 ドキュメントの更新通知を受け取る方法.....	21
5.7 LM393B および LM2903B のスイッチング特性.....	7	8.2 サポート・リソース.....	21
5.8 LM193、LM293、LM393 の電気的特性 (接尾辞 A なし).....	8	8.3 商標.....	21
5.9 LM293A および LM393A の電気的特性.....	9	8.4 静電気放電に関する注意事項.....	21
5.10 LM2903、LM2903V、LM2903AV の電気的特性.....	10	8.5 用語集.....	21
5.11 スwitchング特性: LM193、LM293、LM393、 LM2903、すべて「A」および「V」バージョン.....	10	9 改訂履歴.....	21
		10 メカニカル、パッケージ、および注文情報.....	22

4 ピン構成および機能



図 4-1. D、DGK、JG、P、PS、DDF、PW パッケージ 8 ピン SOIC、VSSOP、PDIP、SO、TSSOP 上面図



サーマル・パッドは GND ピンに直接接続します。

図 4-2. DSG パッケージ 8 ピン WSON (露出パッド付き) 上面図

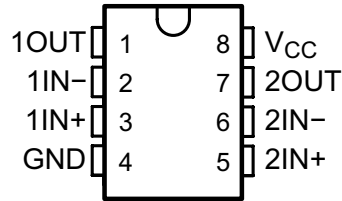
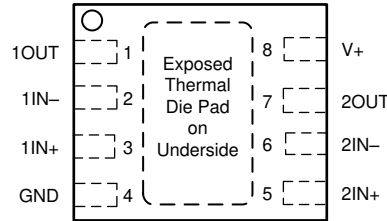
表 4-1. ピン機能

名称	ピン		I/O	説明
	SOIC、VSSOP、PDIP、SO、DDF、TSSOP	DSG		
1OUT	1	1	出力	コンパレータ 1 の出力ピン
1IN-	2	2	入力	コンパレータ 1 の負の入力ピン
1IN+	3	3	入力	コンパレータ 1 の正の入力ピン
GND	4	4	—	グラウンド
2IN+	5	5	入力	コンパレータ 2 の正の入力ピン
2IN-	6	6	入力	コンパレータ 2 の負の入力ピン
2OUT	7	7	出力	コンパレータ 2 の出力ピン
V _{CC}	8	8	—	正の電源
サーマル・パッド	—	PAD	—	GND ピンに直接接続

5 仕様

5.1 絶対最大定格

自由空気での動作温度範囲内 (特に記述のない限り)⁽¹⁾

		最小値	最大値	単位
V _{CC} 電源電圧 ⁽²⁾	B 以外のバージョン	-0.3	36	V
	B バージョンのみ		38	
V _{ID} 差動入力電圧 ⁽³⁾	B 以外のバージョン	-36	36	V
	B バージョンのみ	-38	38	
V _I 入力電圧 (いずれかの入力)	B 以外のバージョン	-0.3	36	V
	B バージョンのみ		38	
I _{IK} 入力電流 ⁽⁵⁾			-50	mA
V _O 出力電圧	B 以外のバージョン	-0.3	36	V
	B バージョンのみ		38	
I _O 出力電流	B 以外のバージョン		20	mA
	B バージョンのみ		25	
I _{SC} 出力のグラウンドへの短絡時間 ⁽⁴⁾		制限なし		
T _J 動作時の仮想接合部温度			150	°C
T _{stg} 保存温度		-65	150	°C

- (1) 絶対最大定格を上回るストレスが加わった場合、デバイスに永続的な損傷が発生する可能性があります。これらはあくまでもストレス評価であり、データシートの「推奨動作条件」に示された値と等しい、またはそれを超える条件で本製品が正しく動作することを暗黙的に示すものではありません。絶対最大定格の状態に長時間置くと、デバイスの信頼性に影響を及ぼす場合があります。量産プロセスにすべてのパラメータのテストが含まれているとは限りません。
- (2) 差動電圧を除くすべての電圧値は、ネットワーク グラウンドを基準にしています。
- (3) 差動電圧は、IN- を基準とする IN+ です。
- (4) 出力から V_{CC} への短絡が発生すると、過熱や最終的な破壊につながる可能性があります。
- (5) 入力電流は、寄生ダイオードを通してグラウンドに流れ、寄生トランジスタをオンにします。これにより I_{CC} が増加し、出力が不正確になる可能性があります。入力電流が除去されると、通常動作に復帰します。

5.2 推奨動作条件

自由気流での動作温度範囲内 (特に記述のない限り)

		最小値	最大値	単位
電源電圧、V _S = (V+) - (V-)	V 以外のデバイス	2	30	V
	V デバイス	2	32	
	「B」バージョンのデバイス	2	36	
入力電圧範囲、V _{IVR}	B 以外のデバイス	0	(V+) - 2.0	V
	「B」バージョンのデバイス	-0.1		
周囲温度、T _A	LM193	-55	125	°C
	LM2903, LM2903V, LM2903AV, LM2903B	-40	125	
	LM393B	-40	85	
	LM293, LM293A	-25	85	
	LM393, LM393A	0	70	

5.3 熱に関する情報 : LMx93x、LM2903x

熱評価基準 ⁽¹⁾		LMx93x、LM2903x					単位
		D (SOIC)	PW (TSSOP)	DGK (VSSOP)	DDF (SOT-23)	DSG (WSON)	
		8ピン	8ピン	8ピン	8ピン	8ピン	
R _{θJA}	接合部から周囲への熱抵抗	148.5	200.6	193.7	197.9	96.9	°C/W
R _{θJC(top)}	接合部からケース (上面) への熱抵抗	90.2	89.6	82.9	119.2	119.0	°C/W
R _{θJB}	接合部から基板への熱抵抗	91.8	131.3	115.5	115.4	63.1	°C/W
Ψ _{JT}	接合部から上面への特性パラメータ	38.5	22.1	20.8	19.4	12.4	°C/W
Ψ _{JB}	接合部から基板への特性パラメータ	91.1	129.6	113.9	113.7	63.0	°C/W
R _{θJC(bot)}	接合部からケース (底面) への熱抵抗	-	-	-	-	37.8	°C/W

(1) 従来および最新の熱評価基準の詳細については、『[半導体および IC パッケージの熱評価基準](#)』アプリケーションレポートを参照してください。

5.4 ESD 定格

		値	単位
V _(ESD)	静電放電	人体モデル (HBM)、ANSI/ESDA/JEDEC JS-001 準拠 ⁽¹⁾	V
		デバイス帯電モデル (CDM)、JEDEC 仕様 JESD22-C101 準拠 ⁽²⁾	

(1) JEDEC のドキュメント JEP155 に、500V HBM では標準の ESD 管理プロセスで安全な製造が可能であると規定されています。

(2) JEDEC のドキュメント JEP157 に、250V CDM では標準の ESD 管理プロセスで安全な製造が可能であると規定されています。

5.5 電気的特性 LM393B

$V_S = 5V$ 、 $V_{CM} = (V-)$ 、 $T_A = 25^\circ C$ (特に記述のない限り)。

パラメータ		テスト条件	最小値	標準値	最大値	単位
V_{IO}	入力オフセット電圧	$V_S = 5 \sim 36V$	-2.5	± 0.37	2.5	mV
		$V_S = 5 \sim 36V$ 、 $T_A = -40^\circ C \sim +85^\circ C$	-4		4	
	入力オフセット電圧、DGK パッケージのみ	$V_S = 5 \sim 36V$	-3.5	± 0.37	3.5	
		$V_S = 5 \sim 36V$ 、 $T_A = -40^\circ C \sim +85^\circ C$	-5		5	
I_B	入力バイアス電流			-3.5	-25	nA
		$T_A = -40^\circ C \sim +85^\circ C$			-50	nA
I_{OS}	入力オフセット電流		-10	± 0.5	10	nA
		$T_A = -40^\circ C \sim +85^\circ C$	-25		25	nA
V_{CM}	同相範囲 ⁽¹⁾	$V_S = 3 \sim 36V$	(V-)		(V+) - 1.5	V
		$V_S = 3 \sim 36V$ 、 $T_A = -40^\circ C \sim +85^\circ C$	(V-)		(V+) - 2.0	V
A_{VD}	大信号差動電圧増幅	$V_S = 15V$ 、 $V_O = 1.4V \sim 11.4V$ 、 $R_L \geq 15k$ を (V+) に接続	50	200		V/mV
V_{OL}	Low レベル出力電圧 {(V-) からのスイング}	$I_{SINK} \leq 4mA$ 、 $V_{ID} = -1V$		110	400	mV
		$I_{SINK} \leq 4mA$ 、 $V_{ID} = -1V$ 、 $T_A = -40^\circ C \sim +85^\circ C$			550	mV
I_{OH-LKG}	High レベルの出力リーク電流	(V+) = $V_O = 5V$ 、 $V_{ID} = 1V$		0.1	20	nA
		(V+) = $V_O = 36V$ 、 $V_{ID} = 1V$		0.3	50	nA
I_{OL}	Low レベル出力電流	$V_{OL} = 1.5V$ 、 $V_{ID} = -1V$ 、 $V_S = 5V$	6	21		mA
I_Q	静止電流 (すべてのコンパレータ)	$V_S = 5V$ 、無負荷		400	600	μA
		$V_S = 36V$ 、無負荷、 $T_A = -40^\circ C \sim +85^\circ C$		550	800	μA

- (1) いずれかの入力の電圧が 0.3V を超えて負になることはできません。この値を超えた場合、出力が不正確になり、入力電流が過剰に流れる可能性があります。同相電圧範囲の上限は、 $V_{CC} - 2V$ に制限されます。ただし、入力の片方のみが有効な同相範囲内であれば十分です。もう片方の入力は最大 V_{CC} レベルまで上昇でき、コンパレータは正しい出力状態を維持します。どちらか、または両方の入力が最大 V_{CC} レベルに達しても、デバイスは損傷しません。

5.6 電気的特性 LM2903B

$V_S = 5V$ 、 $V_{CM} = (V_-)$ 、 $T_A = 25^\circ C$ (特に記述のない限り)。

パラメータ		テスト条件	最小値	標準値	最大値	単位
V_{IO}	入力オフセット電圧	$V_S = 5 \sim 36V$	-2.5	± 0.37	2.5	mV
		$V_S = 5 \sim 36V$ 、 $T_A = -40^\circ C \sim +125^\circ C$	-4		4	
	入力オフセット電圧、DGK パッケージのみ	$V_S = 5 \sim 36V$	-3.5	± 0.37	3.5	
		$V_S = 5 \sim 36V$ 、 $T_A = -40^\circ C \sim +125^\circ C$	-5		5	
I_B	入力バイアス電流			-3.5	-25	nA
		$T_A = -40^\circ C \sim +125^\circ C$				-50
I_{OS}	入力オフセット電流		-10	± 0.5	10	nA
		$T_A = -40^\circ C \sim +125^\circ C$	-25		25	nA
V_{CM}	同相範囲 ⁽¹⁾	$V_S = 3 \sim 36V$	(V-)		(V+) - 1.5	V
		$V_S = 3 \sim 36V$ 、 $T_A = -40^\circ C \sim +125^\circ C$	(V-)		(V+) - 2.0	V
A_{VD}	大信号差動電圧増幅	$V_S = 15V$ 、 $V_O = 1.4V \sim 11.4V$ 、 $R_L \geq 15k$ を (V+) に接続	50	200		V/mV
V_{OL}	Low レベル出力電圧 {(V-) からのスイング}	$I_{SINK} \leq 4mA$ 、 $V_{ID} = -1V$		110	400	mV
		$I_{SINK} \leq 4mA$ 、 $V_{ID} = -1V$ 、 $T_A = -40^\circ C \sim +125^\circ C$			550	mV
I_{OH-LKG}	High レベルの出力リーク電流	(V+) = $V_O = 5V$ 、 $V_{ID} = 1V$		0.1	20	nA
		(V+) = $V_O = 36V$ 、 $V_{ID} = 1V$		0.3	50	nA
I_{OL}	Low レベル出力電流	$V_{OL} = 1.5V$ 、 $V_{ID} = -1V$ 、 $V_S = 5V$	6	21		mA
I_Q	静止電流 (すべてのコンパレータ)	$V_S = 5V$ 、無負荷		400	600	μA
		$V_S = 36V$ 、無負荷、 $T_A = -40^\circ C \sim +125^\circ C$		550	800	μA

- (1) いずれかの入力の電圧が 0.3V を超えて負になることはできません。この値を超えた場合、出力が不正確になり、入力電流が過剰に流れる可能性があります。同相電圧範囲の上限は、 $V_{CC} - 2V$ に制限されます。ただし、入力の片方のみが有効な同相範囲内にあれば十分です。もう片方の入力は最大 V_{CC} レベルまで上昇でき、コンパレータは正しい出力状態を維持します。どちらか、または両方の入力が最大 V_{CC} レベルに達しても、デバイスは損傷しません。

5.7 LM393B および LM2903B のスイッチング特性

$V_S = 5V$ 、 $V_{O_PULLUP} = 5V$ 、 $V_{CM} = V_S/2$ 、 $C_L = 15pF$ 、 $R_L = 5.1k\Omega$ 、 $T_A = 25^\circ C$ (特に記述のない限り)。

パラメータ		テスト条件	最小値	標準値	最大値	単位
$t_{response}$	伝搬遅延時間、High から Low へ、TTL 入力信号 ⁽¹⁾	$V_{ref} = 1.4V$ の TTL 入力		300		ns
$t_{response}$	伝搬遅延時間、High から Low へ、小スケール入力信号 ⁽¹⁾	入力オーバードライブ = 5mV、入力ステップ = 100mV		1000		ns

- (1) 「High から Low」および「Low から High」は、入力側の遷移です。

5.8 LM193、LM293、LM393 の電気的特性 (接尾辞 A なし)

指定された自由空気温度で、 $V_{CC} = 5V$ (特に記述のない限り)

パラメータ	テスト条件	T_A (1)	LM193			LM293 LM393			単位	
			最小値	標準値	最大値	最小値	標準値	最大値		
V_{IO} 入力オフセット電圧	$V_{CC} = 5V \sim 30V$ 、 $V_{IC} = V_{ICR}$ 最小値、 $V_O = 1.4V$	25°C		2	5		2	5	mV	
		フルレンジ			9		9			
I_{IO} 入力オフセット電流	$V_O = 1.4V$	25°C		3	25		5	50	nA	
		フルレンジ			100		250			
I_{IB} 入力バイアス電流	$V_O = 1.4V$	25°C		-25	-100		-25	-250	nA	
		フルレンジ			-300		-400			
V_{ICR} 同相入力電圧範囲(2)		25°C		0~ $V_{CC} - 1.5$			0~ $V_{CC} - 1.5$		V	
		フルレンジ		0~ $V_{CC} - 2$			0~ $V_{CC} - 2$			
A_{VD} 大信号の差動電圧増幅	$V_{CC} = 15V$ 、 $V_O = 1.4V \sim 11.4V$ 、 $R_L \geq 15k\Omega$ を V_{CC} に接続	25°C		50	200		50	200	V/mV	
I_{OH} High レベル出力電流	$V_{OH} = 5V$	$V_{ID} = 1V$	25°C		0.1		0.1	50	nA	
	$V_{OH} = 30V$	$V_{ID} = 1V$	フルレンジ			1		1	μA	
V_{OL} Low レベル出力電圧	$I_{OL} = 4mA$	$V_{ID} = -1V$	25°C		150	400		130	400	mV
		フルレンジ			700		700			
I_{OL} Low レベル出力電流	$V_{OL} = 1.5V$ 、	$V_{ID} = -1V$	25°C		6		6		mA	
I_{CC} 電源電流	$R_L = \infty$	$V_{CC} = 5V$	25°C		0.8	1		0.45	1	mA
		$V_{CC} = 30V$	フルレンジ			2.5		0.55	2.5	

- (1) LM193 のフルレンジ (最小値または最大値) は $-55^\circ C \sim 125^\circ C$ 、LM293 は $-25^\circ C \sim 85^\circ C$ 、LM393 は $0^\circ C \sim 70^\circ C$ です。特に記述のない限り、すべての特性はゼロ同相入力電圧で測定されます。
- (2) いずれかの入力の電圧が $0.3V$ を超えて負になることはできません。この値を超えた場合、出力が不正確になり、入力電流が過剰に流れる可能性があります。同相電圧範囲の上限は、 $V_{CC} - 2V$ に制限されます。ただし、入力の片方のみが有効な同相範囲内にあれば十分です。もう片方の入力は最大 V_{CC} レベルまで上昇でき、コンパレータは正しい出力状態を維持します。どちらか、または両方の入力が最大 V_{CC} レベルに達しても、デバイスは損傷しません。

5.9 LM293A および LM393A の電気的特性

指定された自由空気温度で、 $V_{CC} = 5V$ (特に記述のない限り)

パラメータ	テスト条件	T_A (1)	LM293A LM393A		単位
			最小値	標準値 最大値	
V_{IO} 入力オフセット電圧	$V_{CC} = 5V \sim 30V$, $V_O = 1.4V$ $V_{IC} = V_{ICR(min)}$	25°C	1	2	mV
		フルレンジ		4	
I_{IO} 入力オフセット電流	$V_O = 1.4V$	25°C	5	50	nA
		フルレンジ		150	
I_{IB} 入力バイアス電流	$V_O = 1.4V$	25°C	-25	-250	nA
		フルレンジ		-400	
V_{ICR} 同相入力電圧範囲(2)		25°C	0~ $V_{CC} - 1.5$		V
		フルレンジ	0~ $V_{CC} - 2$		
A_{VD} 大信号の差動電圧増幅	$V_{CC} = 15V$, $V_O = 1.4V \sim 11.4V$, $R_L \geq 15k\Omega$ を V_{CC} に接続	25°C	50	200	V/mV
I_{OH} High レベル出力電流	$V_{OH} = 5V$, $V_{ID} = 1V$	25°C	0.1	50	nA
	$V_{OH} = 30V$, $V_{ID} = 1V$	フルレンジ		1	μA
V_{OL} Low レベル出力電圧	$I_{OL} = 4mA$ $V_{ID} = -1V$	25°C	110	400	mV
		フルレンジ		700	
I_{OL} Low レベル出力電流	$V_{OL} = 1.5V$, $V_{ID} = -1V$	25°C	6		mA
I_{CC} 電源電流	$R_L = \infty$	$V_{CC} = 5V$	0.60	1	mA
		フルレンジ $V_{CC} = 30V$	0.72	2.5	

- (1) LM293A のフルレンジ (最小値または最大値) は $-25^\circ C \sim 85^\circ C$ 、LM393A は $0^\circ C \sim 70^\circ C$ です。特に記述のない限り、すべての特性はゼロ同相入力電圧で測定されます。
- (2) いずれかの入力の電圧が $0.3V$ を超えて負になることはできません。この値を超えた場合、出力が不正確になり、入力電流が過剰に流れる可能性があります。同相電圧範囲の上限は、 $V_{CC} - 2V$ に制限されます。ただし、入力の片方のみが有効な同相範囲内であれば十分です。もう片方の入力は最大 V_{CC} レベルまで上昇でき、コンパレータは正しい出力状態を維持します。どちらか、または両方の入力が最大 V_{CC} レベルに達しても、デバイスは損傷しません。

5.10 LM2903、LM2903V、LM2903AV の電气的特性

指定された自由空気温度で、 $V_{CC} = 5V$ (特に記述のない限り)

パラメータ	テスト条件	T_A (1)	LM2903、LM2903V			LM2903AV			単位	
			最小値	標準値	最大値	最小値	標準値	最大値		
V_{IO} 入力オフセット電圧	$V_{CC} = 5V \sim$ 最大値(2)、 $V_O = 1.4V$ 、 $V_{IC} = V_{ICR(min)}$	25°C		2	7		1	2	mV	
		フルレンジ			15			4		
I_{IO} 入力オフセット電流	$V_O = 1.4V$	25°C		5	50		5	50	nA	
		フルレンジ			200			200		
I_{IB} 入力バイアス電流	$V_O = 1.4V$	25°C		-25	-250		-25	-250	nA	
		フルレンジ			-500			-500		
V_{ICR} 同相入力電圧範囲(3)		25°C		0 ~ $V_{CC} - 1.5$			0 ~ $V_{CC} - 1.5$		V	
		フルレンジ		0 ~ $V_{CC} - 2$			0 ~ $V_{CC} - 2$			
A_{VD} 大信号の差動電圧増幅	$V_{CC} = 15V$ 、 $V_O = 1.4V \sim 11.4V$ 、 $R_L \geq 15k\Omega$ を V_{CC} に接続	25°C		25	100		25	100	V/mV	
I_{OH} High レベル出力電流	$V_{OH} = 5V$ 、 $V_{ID} = 1V$	25°C			0.1	50		0.1	50	nA
	$V_{OH} = V_{CC}$ 最大値(2)、 $V_{ID} = 1V$	フルレンジ				1			1	μA
V_{OL} Low レベル出力電圧	$I_{OL} = 4mA$ 、 $V_{ID} = -1V$ 、	25°C			150	400		150	400	mV
		フルレンジ				700			700	
I_{OL} Low レベル出力電流	$V_{OL} = 1.5V$ 、 $V_{ID} = -1V$	25°C			6			6	mA	
I_{CC} 電源電流	$R_L = \infty$	$V_{CC} = 5V$	25°C			0.8		0.8	1	mA
		$V_{CC} =$ 最大値	フルレンジ				2.5			

- (1) LM2903 のフルレンジ (最小値または最大値) は $-40^\circ C \sim 125^\circ C$ です。特に記述のない限り、すべての特性はゼロ同相入力電圧で測定されます。
- (2) V_{CC} の最大値は、V 以外のデバイスでは 30V、接尾辞 V のデバイスでは 32V です。
- (3) いずれかの入力の電圧が 0.3V を超えて負になることはできません。この値を超えた場合、出力が不正確になり、入力電流が過剰に流れる可能性があります。同相電圧範囲の上限は、 $V_{CC} - 2V$ に制限されます。ただし、入力の片方のみが有効な同相範囲内にあれば十分です。もう片方の入力は最大 V_{CC} レベルまで上昇でき、コンパレータは正しい出力状態を維持します。どちらか、または両方の入力が最大 V_{CC} レベルに達しても、デバイスは損傷しません。

5.11 スイッチング特性 : LM193、LM239、LM393、LM2903、すべて「A」および「V」バージョン

$V_{CC} = 5V$ 、 $T_A = 25^\circ C$

パラメータ	テスト条件	標準値	単位	
応答時間	R_L は 5.1k Ω 経由で 5V に接続、 $C_L = 15pF$ (1) (2)	5mV オーバードライブで 100mV の入カステップ	1.3	μs
		TTL レベルの入カステップ	0.3	

- (1) C_L にはプローブと治具の容量が含まれます。
- (2) 記載されている応答時間は、入カステップの動作から、出力が 1.4V を超える瞬間までの時間です。

5.12 代表的特性、LMx93x および LM2903x

$T_A = 25^\circ\text{C}$ 、 $V_S = 5\text{V}$ 、 $R_{PULLUP} = 5.1\text{k}$ 、 $C_L = 15\text{pF}$ 、 $V_{CM} = 0\text{V}$ 、 $V_{UNDERDRIVE} = 100\text{mV}$ 、 $V_{OVERDRIVE} = 100\text{mV}$ (特に記述のない限り)。



図 5-1. 合計電源電流と電源電圧との関係



図 5-2. 合計電源電流と入力電圧との関係、3V

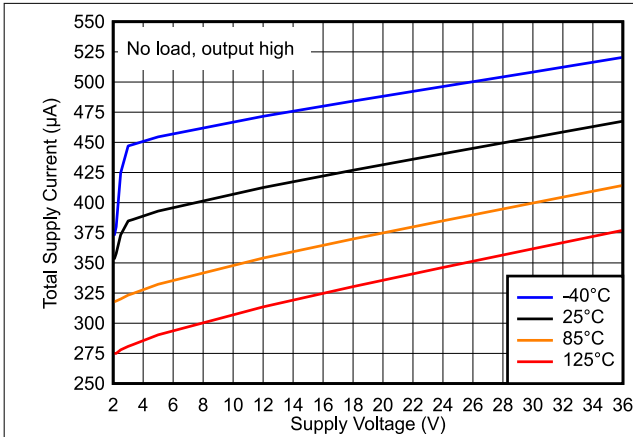

図 5-3. 合計電源電流と入力電圧との関係、3.3V

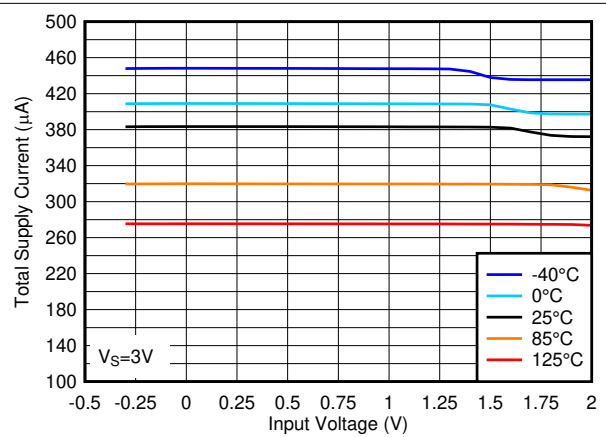

図 5-4. 合計電源電流と入力電圧との関係、5V

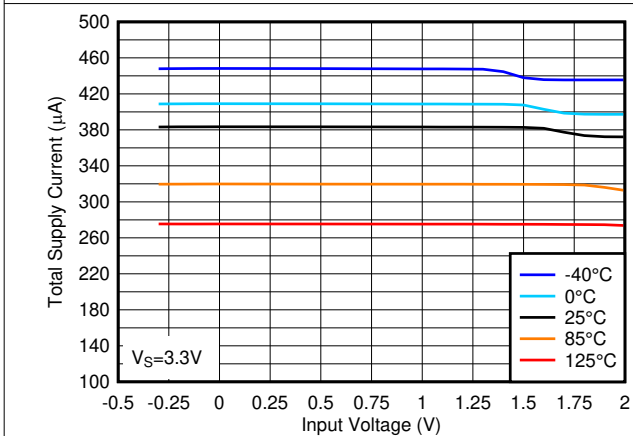

図 5-5. 合計電源電流と入力電圧との関係、12V

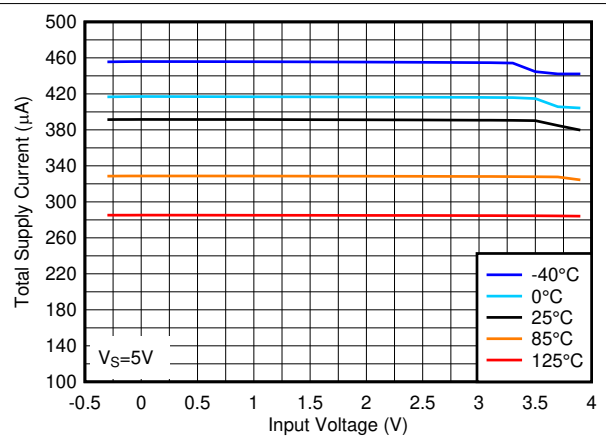

図 5-6. 合計電源電流と入力電圧との関係、36V

5.12 代表的特性、LMx93x および LM2903x (続き)

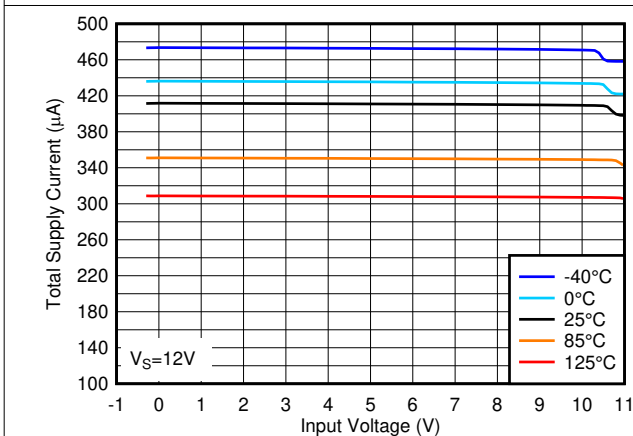
$T_A = 25^\circ\text{C}$ 、 $V_S = 5\text{V}$ 、 $R_{PULLUP} = 5.1\text{k}$ 、 $C_L = 15\text{pF}$ 、 $V_{CM} = 0\text{V}$ 、 $V_{UNDERDRIVE} = 100\text{mV}$ 、 $V_{OVERDRIVE} = 100\text{mV}$ (特に記述のない限り)。

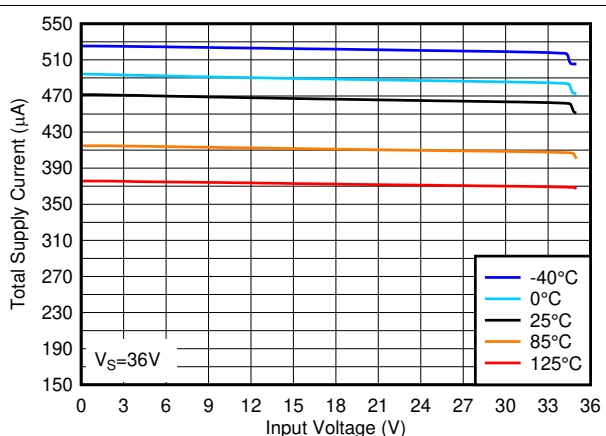

図 5-7. 入力オフセット電圧と温度との関係、3V



図 5-8. 入力オフセット電圧と温度との関係、5V

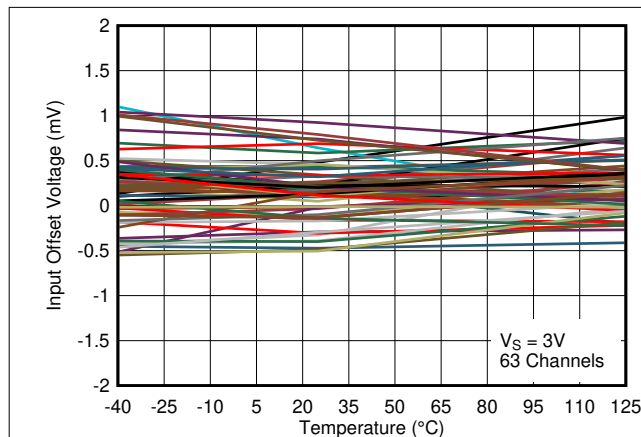

図 5-9. 入力オフセット電圧と温度との関係、12V

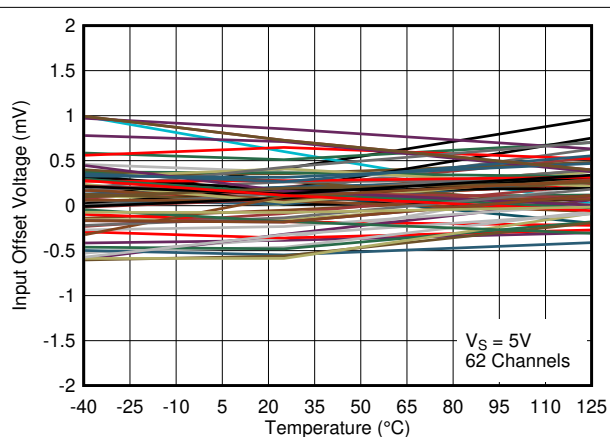

図 5-10. 入力オフセット電圧と温度との関係、36V

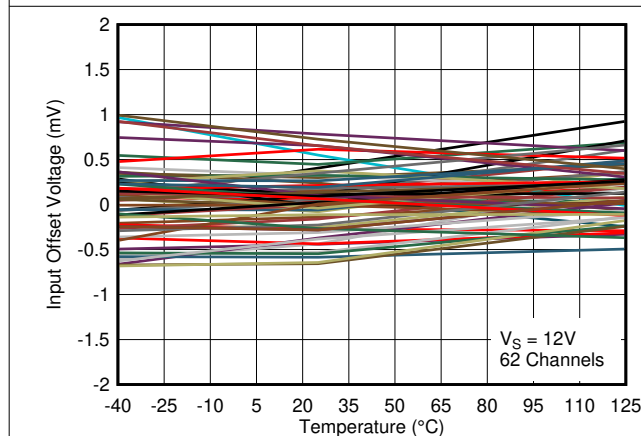

図 5-11. -40°C での入力オフセット電圧と電源電圧との関係

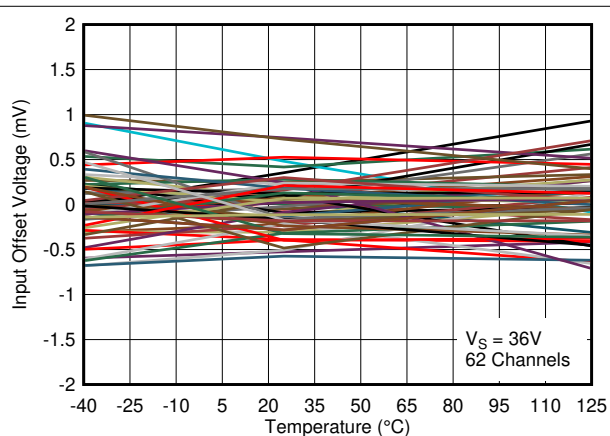

図 5-12. 25°C での入力オフセット電圧と電源電圧との関係

5.12 代表的特性、LMx93x および LM2903x (続き)

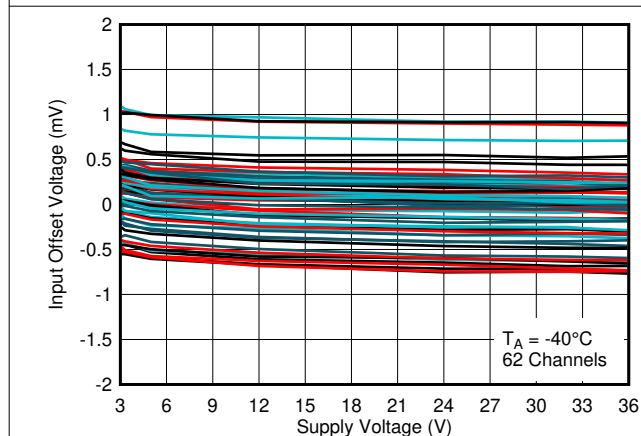
$T_A = 25^\circ\text{C}$ 、 $V_S = 5\text{V}$ 、 $R_{PULLUP} = 5.1\text{k}$ 、 $C_L = 15\text{pF}$ 、 $V_{CM} = 0\text{V}$ 、 $V_{UNDERDRIVE} = 100\text{mV}$ 、 $V_{OVERDRIVE} = 100\text{mV}$ (特に記述のない限り)。

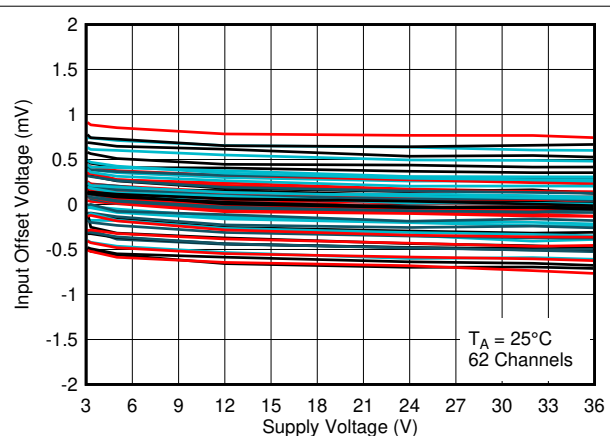

図 5-13. 85°Cでの入力オフセット電圧と電源電圧との関係



図 5-14. 125°Cでの入力オフセット電圧と電源電圧との関係

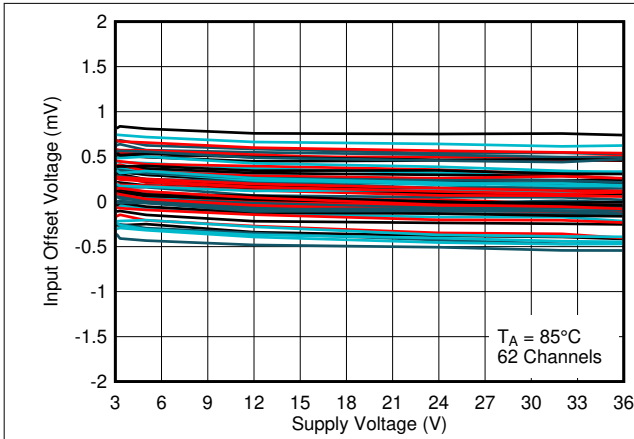

図 5-15. 入力バイアス電流と電源電圧との関係

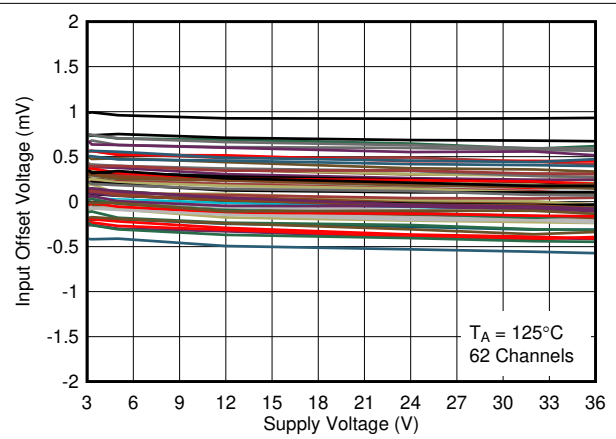

図 5-16. 入力バイアス電流と入力電圧との関係、5V

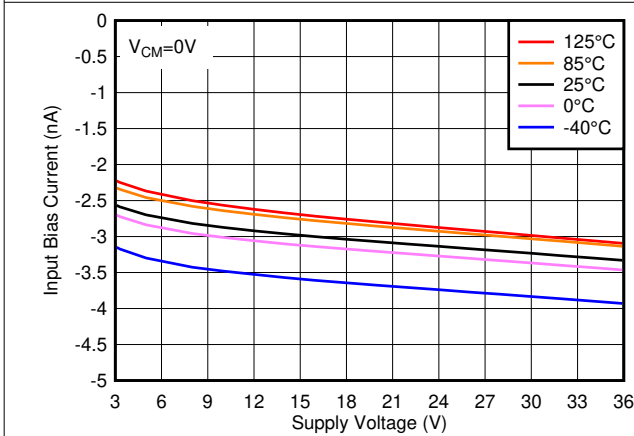

図 5-17. 入力バイアス電流と入力電圧との関係、12V

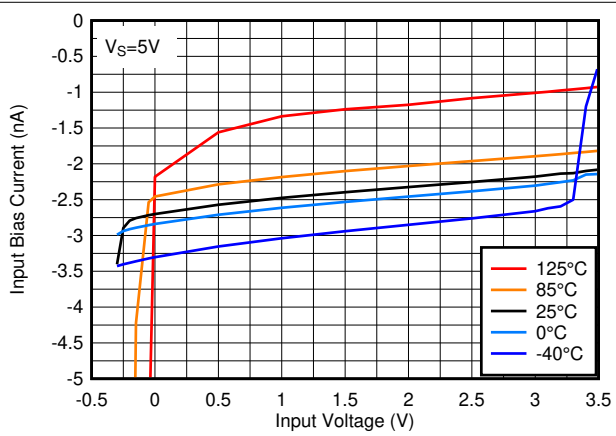

図 5-18. 入力バイアス電流と入力電圧との関係、36V

5.12 代表的特性、LMx93x および LM2903x (続き)

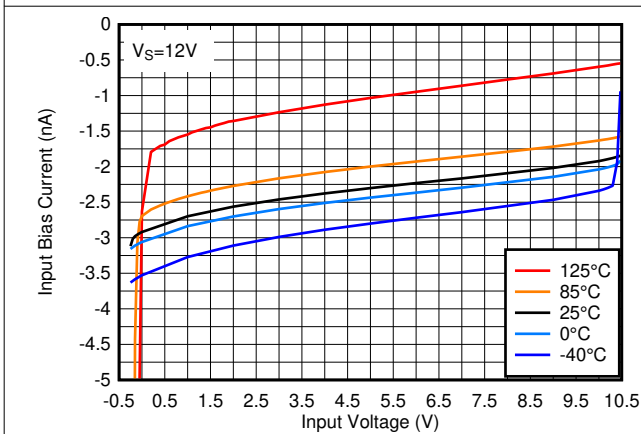
$T_A = 25^\circ\text{C}$ 、 $V_S = 5\text{V}$ 、 $R_{PULLUP} = 5.1\text{k}$ 、 $C_L = 15\text{pF}$ 、 $V_{CM} = 0\text{V}$ 、 $V_{UNDERDRIVE} = 100\text{mV}$ 、 $V_{OVERDRIVE} = 100\text{mV}$ (特に記述のない限り)。

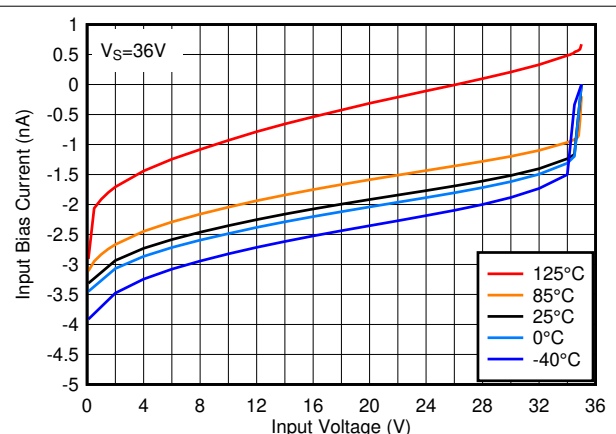

図 5-19. 出力 Low 電圧と出力シンク電流の関係、3V



図 5-20. 出力 Low 電圧と出力シンク電流の関係、5V

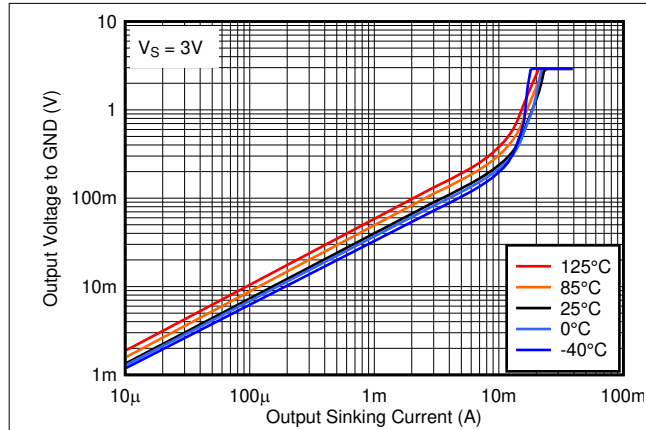

図 5-21. 出力 Low 電圧と出力シンク電流の関係、12V

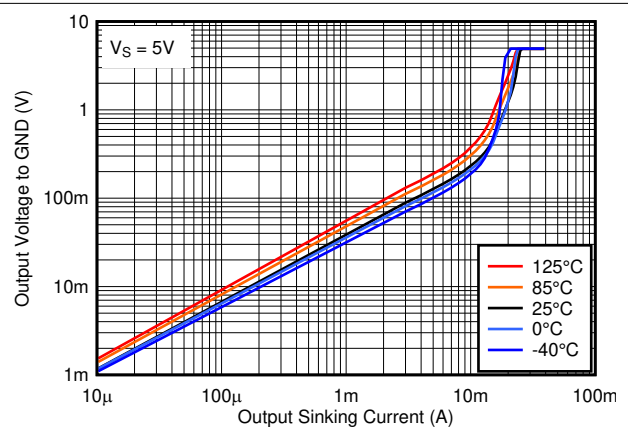

図 5-22. 出力 Low 電圧と出力シンク電流との関係、36V

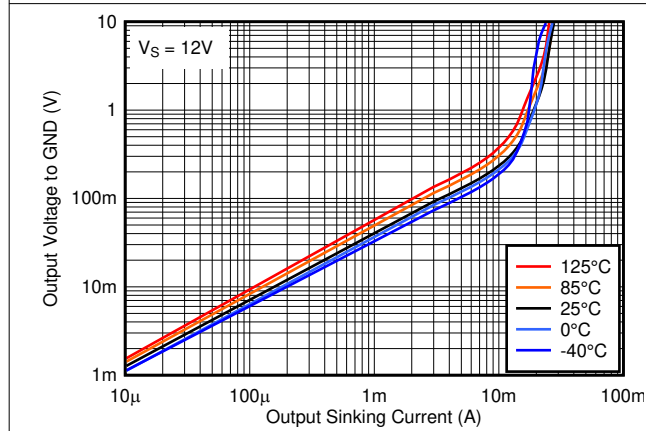

図 5-23. 出力 High リーク電流と温度との関係、5V

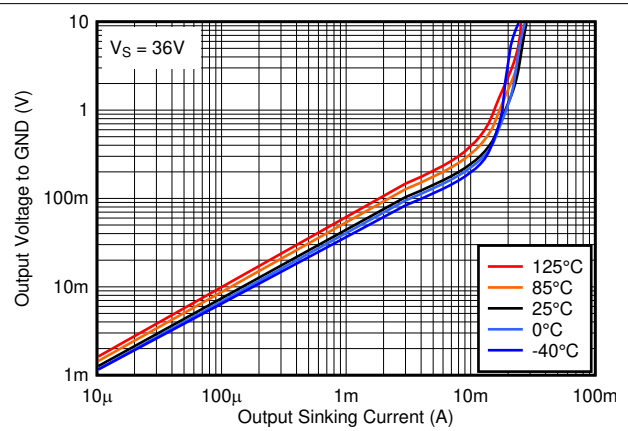

図 5-24. 出力 High リーク電流と温度との関係、36V

5.12 代表的特性、LMx93x および LM2903x (続き)

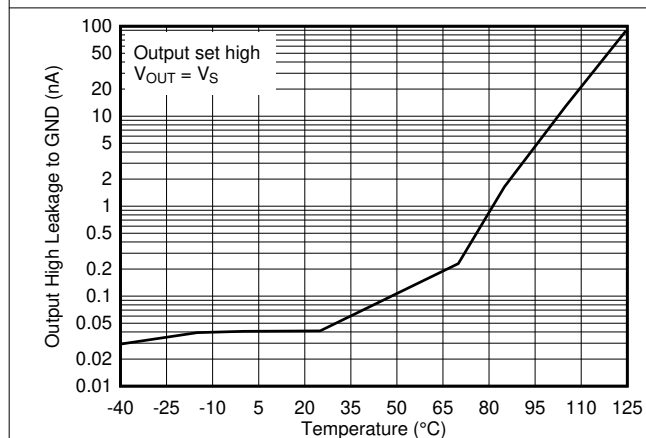
$T_A = 25^\circ\text{C}$ 、 $V_S = 5\text{V}$ 、 $R_{PULLUP} = 5.1\text{k}$ 、 $C_L = 15\text{pF}$ 、 $V_{CM} = 0\text{V}$ 、 $V_{UNDERDRIVE} = 100\text{mV}$ 、 $V_{OVERDRIVE} = 100\text{mV}$ (特に記述のない限り)。

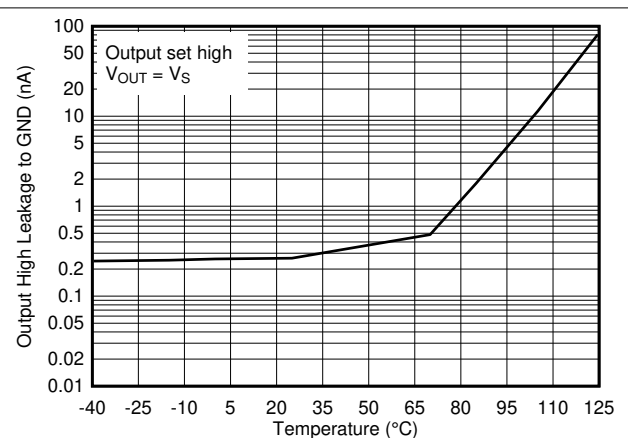

図 5-25. High から Low までの伝搬遅延と入力オーバードライブ電圧との関係、5V



図 5-26. Low から High までの伝搬遅延と入力オーバードライブ電圧との関係、5V

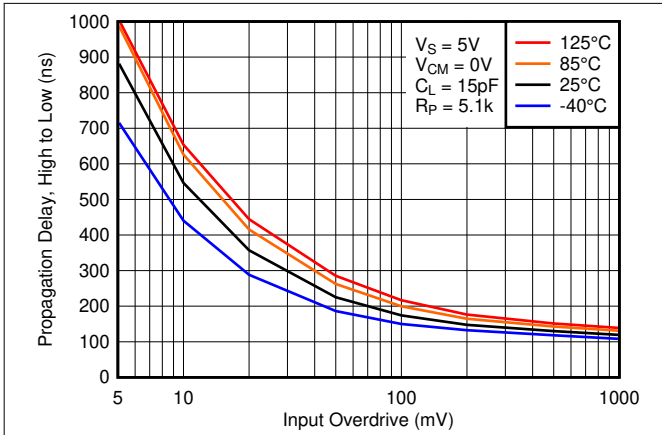

図 5-27. High から Low までの伝搬遅延と入力オーバードライブ電圧との関係、12V

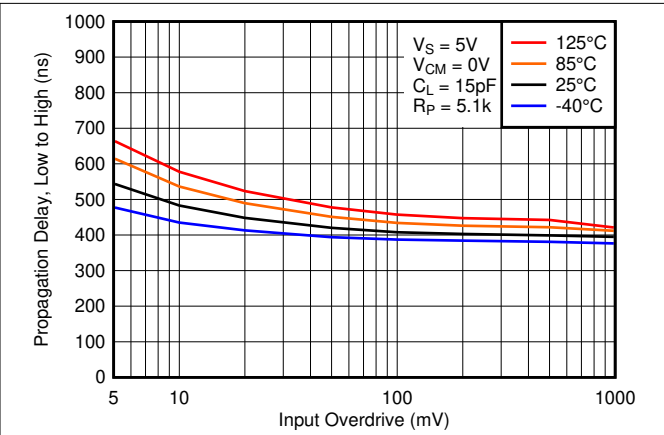

図 5-28. Low から High までの伝搬遅延と入力オーバードライブ電圧との関係、12V

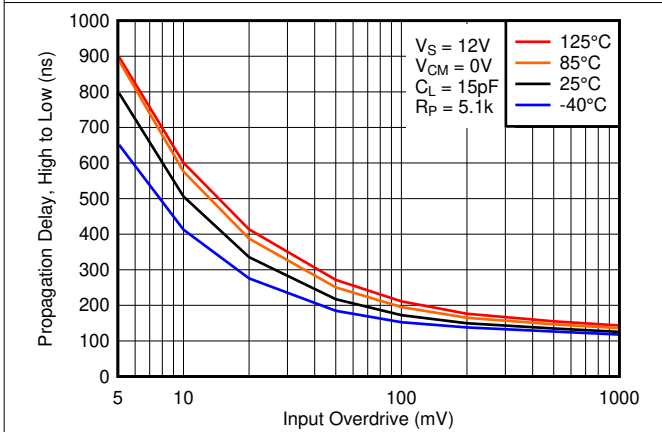

図 5-29. High から Low までの伝搬遅延と入力オーバードライブ電圧との関係、36V

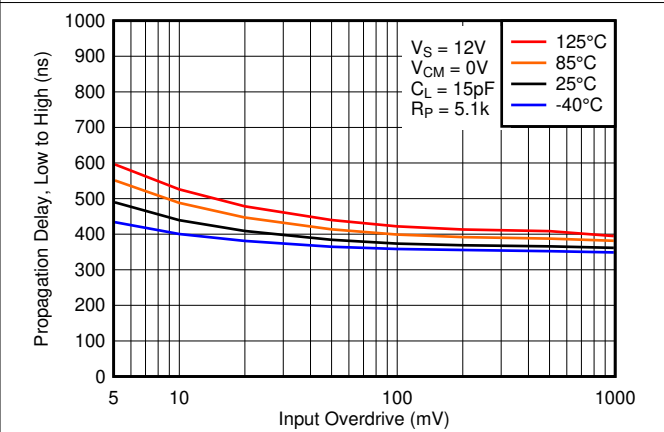

図 5-30. Low から High までの伝搬遅延と入力オーバードライブ電圧との関係、36V

5.12 代表的特性、LMx93x および LM2903x (続き)

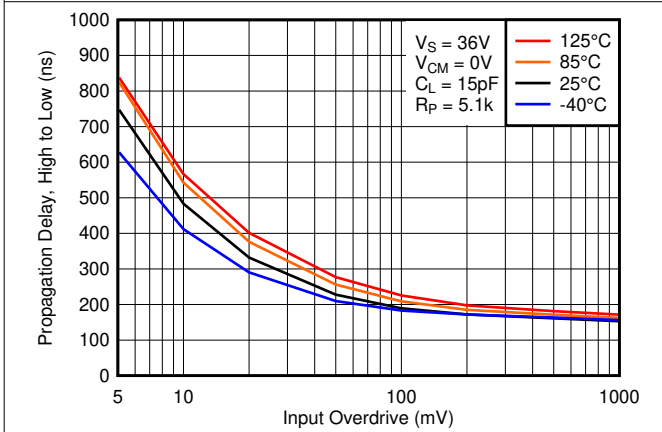
$T_A = 25^\circ\text{C}$ 、 $V_S = 5\text{V}$ 、 $R_{PULLUP} = 5.1\text{k}$ 、 $C_L = 15\text{pF}$ 、 $V_{CM} = 0\text{V}$ 、 $V_{UNDERDRIVE} = 100\text{mV}$ 、 $V_{OVERDRIVE} = 100\text{mV}$ (特に記述のない限り)。

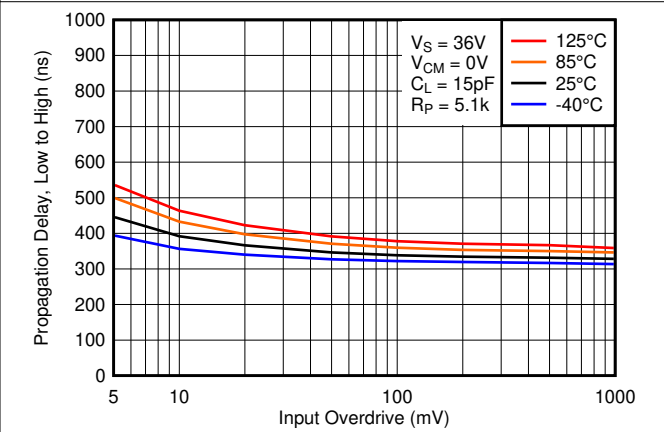

図 5-31. 各種オーバードライブの応答時間、High から Low への遷移



図 5-32. 各種オーバードライブの応答時間、Low から High への遷移

6 詳細説明

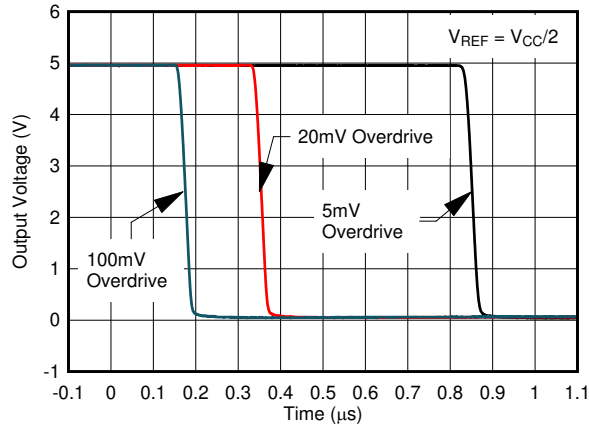
6.1 概要

これらのデュアル コンパレータは、電源ピンで絶対最大定格 36V (「B」バージョンでは 38V) まで動作できます。本デバイスは、広範なアプリケーションにわたる普遍性と汎用性が証明されています。これは、非常に広い電源電圧範囲、低 I_q 、およびデバイスの高速な応答によるものです。

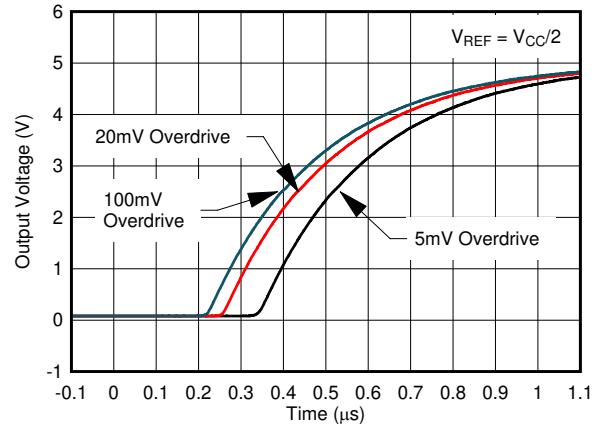
オープン コレクタ出力により、VCC に依存しない目的のロジックレベルにレベル シフトできると同時に、複数の出力を一緒に接続した場合、AND で機能を有効化することもできます。

6.2 機能ブロック図



図 6-1. 回路図 (各コンパレータ)

6.3 機能説明

このコンパレータは PNP ダーリントン ペア入力で構成されており、入力バイアス電流を最小限に抑えながら、非常に高いゲインと高速な応答で動作できます。入力ダーリントン ペアにより、入力同相電圧能力に制限が生じ、コンパレータは全温度範囲においてグラウンドから $V_{CC} - 2V$ までの入力で正確に機能できます。元の従来型シリコンの入力電圧範囲を上回る動作を模倣するため、Q3 の周囲にクランプを追加しました。

出力は、オープンドレインの NPN (プルダウンまたはローサイド) トランジスタで構成されています。負の入力電圧が正の入力電圧およびオフセット電圧よりも高い場合、出力 NPN は電流をシンクします。V_{OL} は抵抗性で、出力電流に応じてスケールアップされます。出力電流の V_{OL} 値については、「出力 Low 電圧と出力シンク電流」のグラフを参照してください。

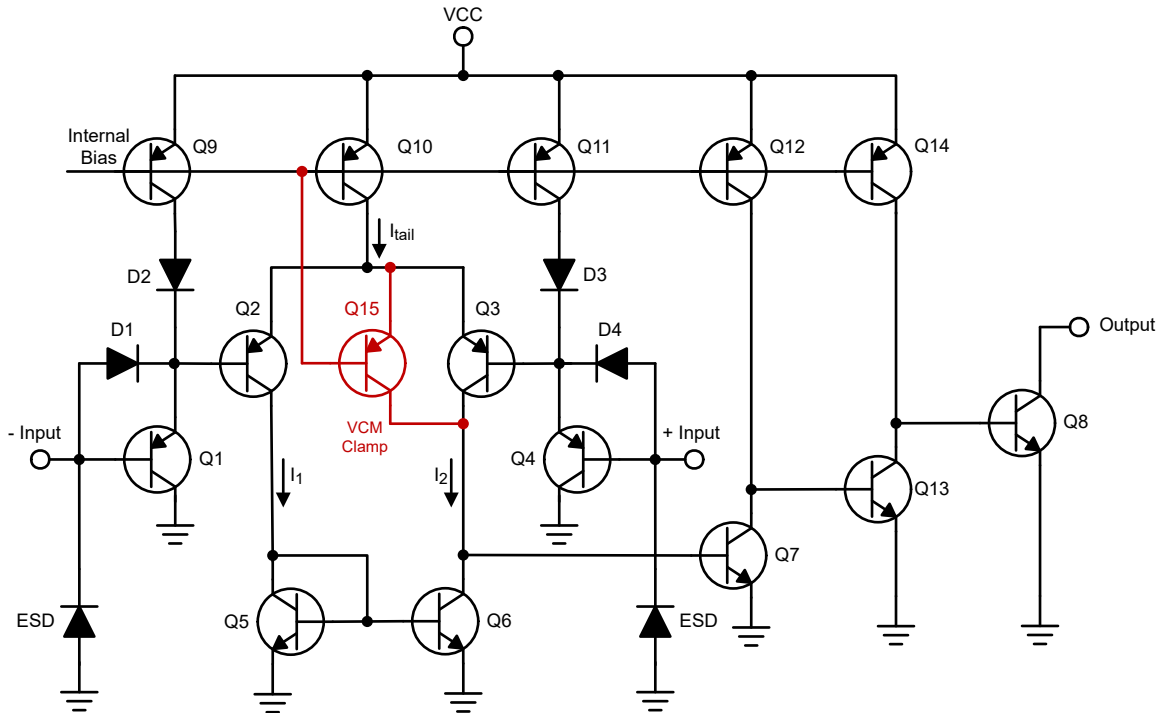
6.4 デバイスの機能モード

6.4.1 電圧の比較

本デバイスは電圧コンパレータとしてのみ動作し、正のピンと負のピンとの差動電圧を比較して、入力差動極性に基づいて論理 Low または高インピーダンス (プルアップにより論理 High) を出力します。

7 アプリケーションと実装

注

以下のアプリケーション情報は、TI の製品仕様に含まれるものではなく、TI ではその正確性または完全性を保証いたしません。個々の目的に対する製品の適合性については、お客様の責任で判断していただくこととなります。お客様は自身の設計実装を検証しテストすることで、システムの機能を確認する必要があります。

7.1 アプリケーション情報

このデバイスは通常、単一の信号を基準電圧と比較する、あるいは 2 つの信号を互いに比較するために使用されます。多くのユーザーは、オープンドレイン出力を活用して、比較ロジックの出力を、MCU またはロジック デバイスのロジック電圧レベルに駆動します。広い電源電圧範囲と高い電圧能力から、このコンパレータは高電圧または低電圧へのレベルシフトに最適です。

7.2 代表的なアプリケーション



図 7-1. シングル エンドおよび差動コンパレータの構成

7.2.1 設計要件

この設計例では、表 7-1 に記載されているパラメータを入力パラメータとして使用します。

表 7-1. 設計パラメータ

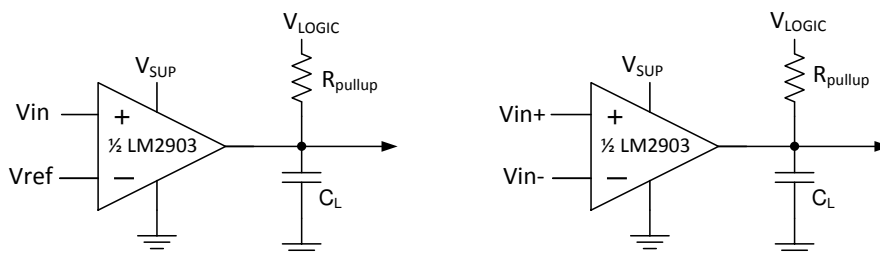
設計パラメータ	数値の例
入力電圧範囲	0V ~ $V_{sup} - 2V$
電源電圧	4.5V ~ V_{CC} 最大値
ロジック電源電圧	0V ~ V_{CC} 最大値
出力電流 (R_{PULLUP})	1 μ A ~ 4mA
入力オーバードライブ電圧	100mV
基準電圧	2.5V
負荷容量 (C_L)	15pF

7.2.2 詳細な設計手順

一般的なコンパレータ アプリケーションで本デバイスを使用する場合、次の仕様を決定します。

- 入力電圧範囲
- 最小オーバードライブ電圧
- 出力および駆動電流
- 応答時間

7.2.2.1 入力電圧範囲

入力電圧範囲を選択するときは、入力同相電圧範囲 (V_{ICR}) を考慮する必要があります。動作温度が 25°C よりも低い場合、 V_{ICR} の範囲は $0\text{V} \sim V_{CC} - 2.0\text{V}$ です。これにより、入力電圧範囲は最大 $V_{CC} - 2.0\text{V}$ 、最小 0V に制限されます。この範囲外の動作では、誤った比較が行われる可能性があります。

入力電圧の状況と、それぞれの結果の一覧を、以下に示します。

1. IN- と IN+ の両方が同相範囲内の場合:
 - a. IN- が IN+ およびオフセット電圧より高い場合、出力は Low になり、出力トランジスタは電流をシンクします
 - b. IN- が IN+ およびオフセット電圧より低い場合、出力は高インピーダンスになり、出力トランジスタは導通しません
2. IN- が同相範囲より高く、IN+ が同相範囲内のとき、出力は Low になり、出力トランジスタは電流をシンクします
3. IN+ が同相範囲より高く、IN- が同相範囲内のとき、出力は高インピーダンスになり、出力トランジスタは導通しません
4. IN- と IN+ の両方が同相範囲より高い場合は、『[LM339, LM393, TL331 ファミリー コンパレータ \(新しい B バージョンを含む\) のアプリケーション設計ガイドライン](#)』のセクション 2 を参照してください。

7.2.2.2 最小オーバードライブ電圧

オーバードライブ電圧は、オフセット電圧 (V_{IO}) 上で、コンパレータの正の入力と負の入力の間で生成される差動電圧です。正確な比較を行うには、オーバードライブ電圧 (V_{OD}) を入力オフセット電圧 (V_{IO}) よりも高くする必要があります。オーバードライブ電圧は、コンパレータの応答時間を決定することもできます。オーバードライブが増加すると、応答時間が短くなります。オーバードライブ電圧に対する正と負の応答時間を、[図 7-2](#) と [図 7-3](#) に示します。

7.2.2.3 出力および駆動電流

出力電流は、負荷 / プルアップ抵抗と、ロジック / プルアップ電圧によって決定されます。出力電流は、コンパレータから出力 Low 電圧 (V_{OL}) を生成します。この場合、 V_{OL} は出力電流に比例します。出力電流に基づいて V_{OL} を決定するには、[代表的特性, LMx93x および LM2903x](#) セクションの「出力 Low 電流とシンク電流」のグラフを参照してください。

出力電流は、過渡応答にも影響を及ぼすことがあります。詳細については「[セクション 7.2.2.4](#)」を参照してください。

7.2.2.4 応答時間

応答時間は、駆動に対する入力の関数です。標準応答時間については、[アプリケーション曲線](#) を参照してください。立ち上がりおよび立ち下がり時間は、負荷容量 (C_L)、負荷 I_L 、負荷 / プルアップ抵抗 (R_{PULLUP})、および等価コレクタ-エミッタ抵抗 (R_{CE}) によって決定できます。

- 立ち上がり時間 (T_R) は、約 $T_R = R_{PULLUP} \times C_L$ です。
- 立ち下がり時間 (T_F) は、約 $T_F = R_{CE} \times C_L$ です。
 - R_{CE} は、[図 5-20](#) で目的の温度における線形領域の勾配を計測するか、 V_{OL} を I_{out} で除算することで決定できます。

7.2.3 アプリケーション曲線

以下の曲線は、 V_{CC} および V_{Logic} が 5V、 $R_{PULLUP} = 5.1k\Omega$ で、50pF のスコープ プローブを使用して生成されたものです。

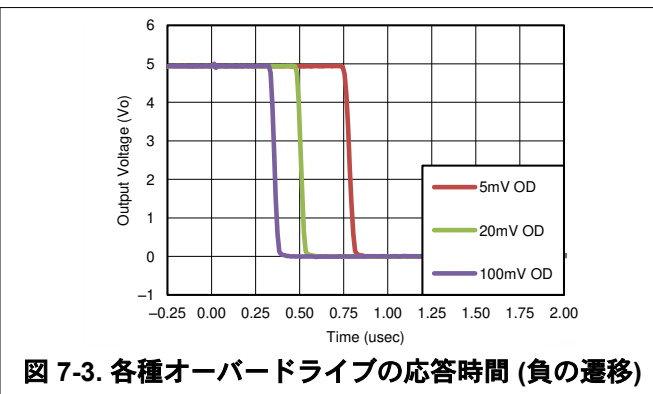
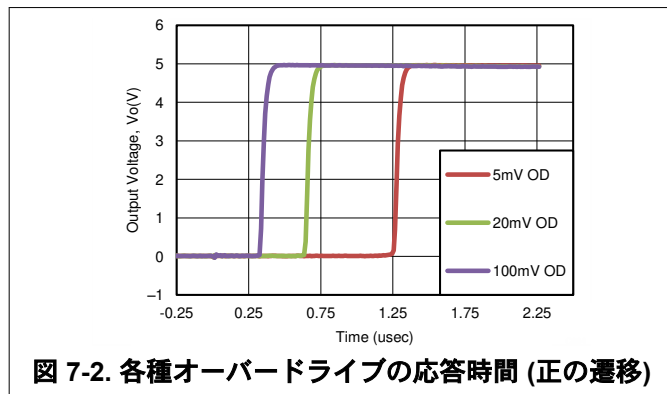

7.2.4 電源に関する推奨事項

ノイズの多い入力や AC 入力を使用し、高速な応答と比較を行うアプリケーションでは、電源ピンにバイパス コンデンサを使用して、電源電圧の変動を除去することを推奨します。このような変動がコンパレータの入力同相範囲に侵入し、比較が不正確になる可能性があります。

7.2.5 レイアウト

7.2.5.1 レイアウトのガイドライン

高精度でヒステリシスなしのコンパレータ アプリケーションでは、ノイズやグリッチを最小限に抑えながら、安定した電源を維持することが重要です。電源電圧とグランドとの間にバイパス コンデンサを追加するのが最良の事例です。このコンデンサは、正の電源と負の電源 (存在する場合) に実装できます。負の電源を使用しない場合は、IC の GND ピンとシステム グランドとの間にコンデンサを配置しないでください。

出力の発振を防ぐため、出力と反転入力との間のカップリングを最小限に抑えます。カップリングを低減するため、出力と反転入力の配線の間には V_{CC} または GND の配線が存在する場合を除いて、出力と反転入力の配線を並列に配置してはいけません。入力に直列抵抗を追加する場合、デバイスの近くに抵抗を配置します。

7.2.5.2 レイアウト例



図 7-4. LM2903 のレイアウト例

8 デバイスおよびドキュメントのサポート

8.1 ドキュメントの更新通知を受け取る方法

ドキュメントの更新についての通知を受け取るには、www.tij.co.jp のデバイス製品フォルダを開いてください。[通知] をクリックして登録すると、変更されたすべての製品情報に関するダイジェストを毎週受け取ることができます。変更の詳細については、修正されたドキュメントに含まれている改訂履歴をご覧ください。

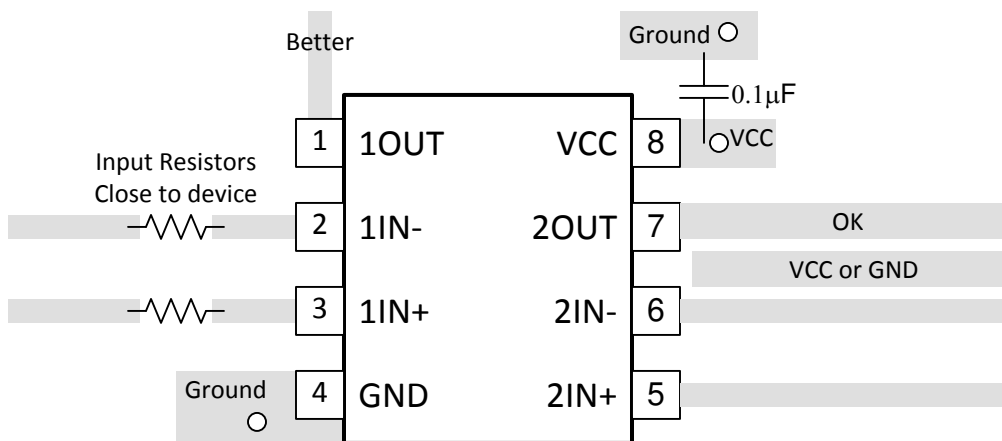
8.2 サポート・リソース

テキサス・インスツルメンツ E2E™ サポート・フォーラムは、エンジニアが検証済みの回答と設計に関するヒントをエキスパートから迅速かつ直接得ることができる場所です。既存の回答を検索したり、独自の質問をしたりすることで、設計に必要な支援を迅速に得ることができます。

リンクされているコンテンツは、各寄稿者により「現状のまま」提供されるものです。これらはテキサス・インスツルメンツの仕様を構成するものではなく、必ずしもテキサス・インスツルメンツの見解を反映したものではありません。テキサス・インスツルメンツの[使用条件](#)を参照してください。

8.3 商標

テキサス・インスツルメンツ E2E™ is a trademark of Texas Instruments.
すべての商標は、それぞれの所有者に帰属します。

8.4 静電気放電に関する注意事項



この IC は、ESD によって破損する可能性があります。テキサス・インスツルメンツは、IC を取り扱う際には常に適切な注意を払うことを推奨します。正しい取り扱いおよび設置手順に従わない場合、デバイスを破損するおそれがあります。

ESD による破損は、わずかな性能低下からデバイスの完全な故障まで多岐にわたります。精密な IC の場合、パラメータがわずかに変化するだけで公表されている仕様から外れる可能性があるため、破損が発生しやすくなっています。

8.5 用語集

[テキサス・インスツルメンツ用語集](#) この用語集には、用語や略語の一覧および定義が記載されています。

9 改訂履歴

資料番号末尾の英字は改訂を表しています。その改訂履歴は英語版に準じています。

Changes from Revision AF (August 2023) to Revision AG (January 2025)	Page
• 従来のデバイス グラフを削除.....	11
• 内部回路図を更新	17

Changes from Revision AE (November 2020) to Revision AF (August 2023)	Page
• アプリケーションの注記にリファレンスを追加.....	19

Changes from Revision AD (October 2020) to Revision AE (November 2020)	Page
• 「ファミリ比較表」のオフセット電圧の単位を mV に訂正.....	1
• 文書全体を通して LM393B および LM2903B の推奨最小電源電圧を 2V に変更.....	1
• LM393B と LM2903B DGK パッケージに別々のオフセット電圧行を追加.....	1
• 「B」デバイスの推奨最小電源電圧を 2V に変更.....	4
• 「B」デバイスの電源電流と電源電圧との関係のグラフを 2V 用に更新.....	11

Changes from Revision AC (February 2020) to Revision AD (October 2020) Page

- ドキュメント全体にわたって表、図、相互参照の採番方法を更新。..... 1

Changes from Revision AB (December 2019) to Revision AC (February 2020) Page

- 先頭ページの「特長」、「アプリケーション」、「概要」のテキストを、B バージョンを強調するように変更..... 1
- WSON および SOT-23-8 パッケージを追加..... 1
- 「ファミリ表」にリンクを追加..... 1
- DDF および DSG パッケージを熱に関する情報の表に追加..... 5

Changes from Revision AA (September 2019) to Revision AB (December 2019) Page

- LM393B と LM2903B のステータスをプレビューからアクティブに変更..... 1
- 「ファミリ比較表」を追加。..... 1

Changes from Revision Z (October 2017) to Revision AA (September 2019) Page

- データシート全体にわたって各種のテキスト変更を加えた「B」デバイスを追加。..... 1
- デバイス情報から古い LM193 CDIP および LCCC パッケージの参照と図面を削除。これらは LM139-MIL データシートに記載されています。..... 1
- 「B」デバイスの熱に関する情報の表を追加。..... 5
- 「B」デバイスの電氣的表を追加..... 5
- B デバイスのグラフを追加..... 11

10 メカニカル、パッケージ、および注文情報

以下のページには、メカニカル、パッケージ、および注文に関する情報が記載されています。この情報は、指定のデバイスに対して提供されている最新のデータです。このデータは予告なく変更されることがあり、ドキュメントが改訂される場合もあります。このデータシートのブラウザ対応版については、左側にあるナビゲーションを参照してください。

重要なお知らせと免責事項

テキサス・インスツルメンツは、技術データと信頼性データ (データシートを含みます)、設計リソース (リファレンス デザインを含みます)、アプリケーションや設計に関する各種アドバイス、Web ツール、安全性情報、その他のリソースを、欠陥が存在する可能性のある「現状のまま」提供しており、商品性および特定目的に対する適合性の黙示保証、第三者の知的財産権の非侵害保証を含むいかなる保証も、明示的または黙示的にかかわらず拒否します。

これらのリソースは、テキサス・インスツルメンツ製品を使用する設計の経験を積んだ開発者への提供を意図したものです。(1) お客様のアプリケーションに適した テキサス・インスツルメンツ製品の選定、(2) お客様のアプリケーションの設計、検証、試験、(3) お客様のアプリケーションに該当する各種規格や、その他のあらゆる安全性、セキュリティ、規制、または他の要件への確実な適合に関する責任を、お客様のみが単独で負うものとします。

上記の各種リソースは、予告なく変更される可能性があります。これらのリソースは、リソースで説明されている テキサス・インスツルメンツ製品を使用するアプリケーションの開発の目的でのみ、テキサス・インスツルメンツはその使用をお客様に許諾します。これらのリソースに関して、他の目的で複製することや掲載することは禁止されています。テキサス・インスツルメンツや第三者の知的財産権のライセンスが付与されている訳ではありません。お客様は、これらのリソースを自身で使用した結果発生するあらゆる申し立て、損害、費用、損失、責任について、テキサス・インスツルメンツおよびその代理人を完全に補償するものとし、テキサス・インスツルメンツは一切の責任を拒否します。

テキサス・インスツルメンツの製品は、[テキサス・インスツルメンツの販売条件](#)、または [ti.com](https://www.ti.com) やかかる テキサス・インスツルメンツ製品の関連資料などのいずれかを通じて提供する適用可能な条項の下で提供されています。テキサス・インスツルメンツがこれらのリソースを提供することは、適用されるテキサス・インスツルメンツの保証または他の保証の放棄の拡大や変更を意味するものではありません。

お客様がいかなる追加条項または代替条項を提案した場合でも、テキサス・インスツルメンツはそれらに異議を唱え、拒否します。

郵送先住所: Texas Instruments, Post Office Box 655303, Dallas, Texas 75265

Copyright © 2025, Texas Instruments Incorporated

PACKAGING INFORMATION

Orderable Device	Status (1)	Package Type	Package Drawing	Pins	Package Qty	Eco Plan (2)	Lead finish/ Ball material (6)	MSL Peak Temp (3)	Op Temp (°C)	Device Marking (4/5)	Samples
LM193DR	ACTIVE	SOIC	D	8	2500	RoHS & Green	NIPDAU	Level-1-260C-UNLIM	-55 to 125	LM193	Samples
LM193DRG4	ACTIVE	SOIC	D	8	2500	RoHS & Green	NIPDAU	Level-1-260C-UNLIM	-55 to 125	LM193	Samples
LM2903AVQDR	ACTIVE	SOIC	D	8	2500	RoHS & Green	NIPDAU	Level-1-260C-UNLIM	-40 to 125	L2903AV	Samples
LM2903AVQDRG4	ACTIVE	SOIC	D	8	2500	RoHS & Green	NIPDAU	Level-1-260C-UNLIM	-40 to 125	L2903AV	Samples
LM2903AVQPWR	ACTIVE	TSSOP	PW	8	2000	RoHS & Green	NIPDAU	Level-1-260C-UNLIM	-40 to 125	L2903AV	Samples
LM2903AVQPWRG4	ACTIVE	TSSOP	PW	8	2000	RoHS & Green	NIPDAU	Level-1-260C-UNLIM	-40 to 125	L2903AV	Samples
LM2903BIDDFR	ACTIVE	SOT-23-THIN	DDF	8	3000	RoHS & Green	NIPDAU	Level-1-260C-UNLIM	-40 to 125	2903B	Samples
LM2903BIDGKR	ACTIVE	VSSOP	DGK	8	2500	RoHS & Green	NIPDAU	Level-1-260C-UNLIM	-40 to 125	903B	Samples
LM2903BIDR	ACTIVE	SOIC	D	8	2500	RoHS & Green	NIPDAU	Level-1-260C-UNLIM	-40 to 125	L2903B	Samples
LM2903BIDSGR	ACTIVE	WSON	DSG	8	3000	RoHS & Green	NIPDAU	Level-1-260C-UNLIM	-40 to 125	903B	Samples
LM2903BIPWR	ACTIVE	TSSOP	PW	8	2000	RoHS & Green	NIPDAU	Level-1-260C-UNLIM	-40 to 125	L2903B	Samples
LM2903DGKR	ACTIVE	VSSOP	DGK	8	2500	RoHS & Green	NIPDAU SN NIPDAUAG	Level-1-260C-UNLIM	-40 to 125	(MAP, MAS, MAU)	Samples
LM2903DR	ACTIVE	SOIC	D	8	2500	RoHS & Green	NIPDAU SN	Level-1-260C-UNLIM	-40 to 125	LM2903	Samples
LM2903DRG3	ACTIVE	SOIC	D	8	2500	RoHS & Green	SN	Level-1-260C-UNLIM	-40 to 125	LM2903	Samples
LM2903P	ACTIVE	PDIP	P	8	50	RoHS & Green	NIPDAU	N / A for Pkg Type	-40 to 125	LM2903P	Samples
LM2903PSR	ACTIVE	SO	PS	8	2000	RoHS & Green	NIPDAU	Level-1-260C-UNLIM	-40 to 125	L2903	Samples
LM2903PWR	ACTIVE	TSSOP	PW	8	2000	RoHS & Green	NIPDAU SN	Level-1-260C-UNLIM	-40 to 125	L2903	Samples
LM2903PWRG3	ACTIVE	TSSOP	PW	8	2000	RoHS & Green	SN	Level-1-260C-UNLIM	-40 to 125	L2903	Samples
LM2903PWRG4	ACTIVE	TSSOP	PW	8	2000	RoHS & Green	NIPDAU	Level-1-260C-UNLIM	-40 to 125	L2903	Samples
LM2903QD	ACTIVE	SOIC	D	8	75	RoHS & Green	NIPDAU	Level-1-260C-UNLIM	-40 to 125	2903Q	Samples

Orderable Device	Status (1)	Package Type	Package Drawing	Pins	Package Qty	Eco Plan (2)	Lead finish/ Ball material (6)	MSL Peak Temp (3)	Op Temp (°C)	Device Marking (4/5)	Samples
LM2903QDRG4	OBSOLETE	SOIC	D	8		TBD	Call TI	Call TI	-40 to 125	2903Q	
LM2903VQDR	ACTIVE	SOIC	D	8	2500	RoHS & Green	NIPDAU	Level-1-260C-UNLIM	-40 to 125	L2903V	Samples
LM2903VQDRG4	OBSOLETE	SOIC	D	8		TBD	Call TI	Call TI	-40 to 125	L2903V	
LM2903VQPWR	ACTIVE	TSSOP	PW	8	2000	RoHS & Green	NIPDAU	Level-1-260C-UNLIM	-40 to 125	L2903V	Samples
LM2903VQPWRG4	OBSOLETE	TSSOP	PW	8		TBD	Call TI	Call TI	-40 to 125	L2903V	
LM293ADGKR	ACTIVE	VSSOP	DGK	8	2500	RoHS & Green	NIPDAU SN	Level-1-260C-UNLIM	-25 to 85	(MDP, MDS, MDU)	Samples
LM293ADGKRG4	ACTIVE	VSSOP	DGK	8	2500	TBD	Call TI	Call TI	-25 to 85		Samples
LM293ADR	ACTIVE	SOIC	D	8	2500	RoHS & Green	NIPDAU	Level-1-260C-UNLIM	-25 to 85	LM293A	Samples
LM293D	OBSOLETE	SOIC	D	8		TBD	Call TI	Call TI	-25 to 85	LM293	
LM293DGKR	ACTIVE	VSSOP	DGK	8	2500	RoHS & Green	NIPDAU SN	Level-2-260C-1 YEAR	-25 to 85	(MCP, MCS, MCU)	Samples
LM293DGKRG4	ACTIVE	VSSOP	DGK	8	2500	TBD	Call TI	Call TI	-25 to 85		Samples
LM293DR	ACTIVE	SOIC	D	8	2500	RoHS & Green	NIPDAU SN	Level-1-260C-UNLIM	-25 to 85	LM293	Samples
LM293DRG3	ACTIVE	SOIC	D	8	2500	RoHS & Green	SN	Level-1-260C-UNLIM	-25 to 85	LM293	Samples
LM293P	ACTIVE	PDIP	P	8	50	RoHS & Green	NIPDAU	N / A for Pkg Type	-25 to 85	LM293P	Samples
LM293PE4	ACTIVE	PDIP	P	8	50	TBD	Call TI	Call TI	-25 to 85		Samples
LM393ADGKR	ACTIVE	VSSOP	DGK	8	2500	RoHS & Green	NIPDAU NIPDAUAG	Level-1-260C-UNLIM	0 to 70	(M8P, M8S, M8U)	Samples
LM393ADGKRG4	ACTIVE	VSSOP	DGK	8	2500	TBD	Call TI	Call TI	0 to 70		Samples
LM393ADR	ACTIVE	SOIC	D	8	2500	RoHS & Green	NIPDAU SN	Level-1-260C-UNLIM	0 to 70	LM393A	Samples
LM393ADRG4	OBSOLETE	SOIC	D	8		TBD	Call TI	Call TI	0 to 70	LM393A	
LM393AP	ACTIVE	PDIP	P	8	50	RoHS & Green	NIPDAU SN	N / A for Pkg Type	0 to 70	LM393AP	Samples
LM393APE4	ACTIVE	PDIP	P	8	50	TBD	Call TI	Call TI	0 to 70		Samples
LM393APSR	ACTIVE	SO	PS	8	2000	RoHS & Green	NIPDAU	Level-1-260C-UNLIM	0 to 70	L393A	Samples
LM393APWR	ACTIVE	TSSOP	PW	8	2000	RoHS & Green	NIPDAU SN	Level-1-260C-UNLIM	0 to 70	L393A	Samples

Orderable Device	Status (1)	Package Type	Package Drawing	Pins	Package Qty	Eco Plan (2)	Lead finish/ Ball material (6)	MSL Peak Temp (3)	Op Temp (°C)	Device Marking (4/5)	Samples
LM393APWRG4	OBSOLETE	TSSOP	PW	8		TBD	Call TI	Call TI	0 to 70	L393A	
LM393BIDDFR	ACTIVE	SOT-23-THIN	DDF	8	3000	RoHS & Green	NIPDAU	Level-1-260C-UNLIM	-40 to 85	393B	Samples
LM393BIDGKR	ACTIVE	VSSOP	DGK	8	2500	RoHS & Green	NIPDAU	Level-1-260C-UNLIM	-40 to 85	393B	Samples
LM393BIDR	ACTIVE	SOIC	D	8	2500	RoHS & Green	NIPDAU	Level-1-260C-UNLIM	-40 to 85	LM393B	Samples
LM393BIDSGR	ACTIVE	WSON	DSG	8	3000	RoHS & Green	NIPDAU	Level-1-260C-UNLIM	-40 to 85	393B	Samples
LM393BIPWR	ACTIVE	TSSOP	PW	8	2000	RoHS & Green	NIPDAU	Level-1-260C-UNLIM	-40 to 85	LM393B	Samples
LM393D	OBSOLETE	SOIC	D	8		TBD	Call TI	Call TI	0 to 70	LM393	
LM393DGKR	ACTIVE	VSSOP	DGK	8	2500	RoHS & Green	NIPDAU SN	Level-1-260C-UNLIM	0 to 70	(M9P, M9S, M9U)	Samples
LM393DGKRG4	ACTIVE	VSSOP	DGK	8	2500	TBD	Call TI	Call TI	0 to 70		Samples
LM393DR	ACTIVE	SOIC	D	8	2500	RoHS & Green	NIPDAU	Level-1-260C-UNLIM	0 to 70	LM393	Samples
LM393DRG3	ACTIVE	SOIC	D	8	2500	RoHS & Green	SN	Level-1-260C-UNLIM	0 to 70	LM393	Samples
LM393DRG4	OBSOLETE	SOIC	D	8		TBD	Call TI	Call TI	0 to 70	LM393	
LM393P	ACTIVE	PDIP	P	8	50	RoHS & Green	NIPDAU SN	N / A for Pkg Type	0 to 70	LM393P	Samples
LM393PE3	ACTIVE	PDIP	P	8	50	RoHS & Non-Green	SN	N / A for Pkg Type	0 to 70	LM393P	Samples
LM393PE4	ACTIVE	PDIP	P	8	50	RoHS & Green	NIPDAU	N / A for Pkg Type	0 to 70	LM393P	Samples
LM393PS	ACTIVE	SO	PS	8	80	RoHS & Green	NIPDAU	Level-1-260C-UNLIM	0 to 70	L393	Samples
LM393PSR	ACTIVE	SO	PS	8	2000	RoHS & Green	NIPDAU	Level-1-260C-UNLIM	0 to 70	L393	Samples
LM393PSRG4	ACTIVE	SO	PS	8	2000	RoHS & Green	NIPDAU	Level-1-260C-UNLIM	0 to 70	L393	Samples
LM393PWR	ACTIVE	TSSOP	PW	8	2000	RoHS & Green	NIPDAU SN	Level-1-260C-UNLIM	0 to 70	L393	Samples
LM393PWRG3	ACTIVE	TSSOP	PW	8	2000	RoHS & Green	SN	Level-1-260C-UNLIM	0 to 70	L393	Samples
LM393PWRG4	ACTIVE	TSSOP	PW	8	2000	RoHS & Green	NIPDAU	Level-1-260C-UNLIM	0 to 70	L393	Samples

⁽¹⁾ The marketing status values are defined as follows:

ACTIVE: Product device recommended for new designs.

LIFEBUY: TI has announced that the device will be discontinued, and a lifetime-buy period is in effect.

NRND: Not recommended for new designs. Device is in production to support existing customers, but TI does not recommend using this part in a new design.

PREVIEW: Device has been announced but is not in production. Samples may or may not be available.

OBSOLETE: TI has discontinued the production of the device.

⁽²⁾ **RoHS:** TI defines "RoHS" to mean semiconductor products that are compliant with the current EU RoHS requirements for all 10 RoHS substances, including the requirement that RoHS substance do not exceed 0.1% by weight in homogeneous materials. Where designed to be soldered at high temperatures, "RoHS" products are suitable for use in specified lead-free processes. TI may reference these types of products as "Pb-Free".

RoHS Exempt: TI defines "RoHS Exempt" to mean products that contain lead but are compliant with EU RoHS pursuant to a specific EU RoHS exemption.

Green: TI defines "Green" to mean the content of Chlorine (Cl) and Bromine (Br) based flame retardants meet JS709B low halogen requirements of <=1000ppm threshold. Antimony trioxide based flame retardants must also meet the <=1000ppm threshold requirement.

⁽³⁾ MSL, Peak Temp. - The Moisture Sensitivity Level rating according to the JEDEC industry standard classifications, and peak solder temperature.

⁽⁴⁾ There may be additional marking, which relates to the logo, the lot trace code information, or the environmental category on the device.

⁽⁵⁾ Multiple Device Markings will be inside parentheses. Only one Device Marking contained in parentheses and separated by a "~" will appear on a device. If a line is indented then it is a continuation of the previous line and the two combined represent the entire Device Marking for that device.

⁽⁶⁾ Lead finish/Ball material - Orderable Devices may have multiple material finish options. Finish options are separated by a vertical ruled line. Lead finish/Ball material values may wrap to two lines if the finish value exceeds the maximum column width.

Important Information and Disclaimer:The information provided on this page represents TI's knowledge and belief as of the date that it is provided. TI bases its knowledge and belief on information provided by third parties, and makes no representation or warranty as to the accuracy of such information. Efforts are underway to better integrate information from third parties. TI has taken and continues to take reasonable steps to provide representative and accurate information but may not have conducted destructive testing or chemical analysis on incoming materials and chemicals. TI and TI suppliers consider certain information to be proprietary, and thus CAS numbers and other limited information may not be available for release.

In no event shall TI's liability arising out of such information exceed the total purchase price of the TI part(s) at issue in this document sold by TI to Customer on an annual basis.

OTHER QUALIFIED VERSIONS OF LM2903, LM2903B, LM293 :

● Automotive : [LM2903-Q1](#), [LM2903B-Q1](#)

● Enhanced Product : [LM293-EP](#)

NOTE: Qualified Version Definitions:

● Automotive - Q100 devices qualified for high-reliability automotive applications targeting zero defects

- Enhanced Product - Supports Defense, Aerospace and Medical Applications

TAPE AND REEL INFORMATION

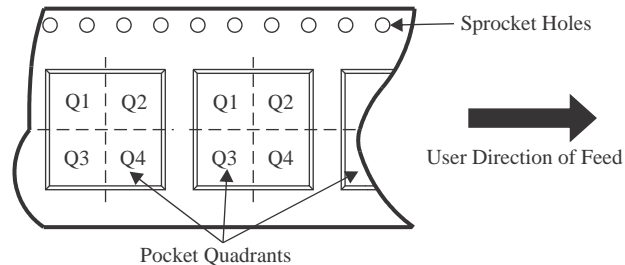
QUADRANT ASSIGNMENTS FOR PIN 1 ORIENTATION IN TAPE

*All dimensions are nominal

Device	Package Type	Package Drawing	Pins	SPQ	Reel Diameter (mm)	Reel Width W1 (mm)	A0 (mm)	B0 (mm)	K0 (mm)	P1 (mm)	W (mm)	Pin1 Quadrant
LM193DR	SOIC	D	8	2500	330.0	12.4	6.4	5.2	2.1	8.0	12.0	Q1
LM193DRG4	SOIC	D	8	2500	330.0	12.4	6.4	5.2	2.1	8.0	12.0	Q1
LM2903AVQDR	SOIC	D	8	2500	330.0	12.4	6.4	5.2	2.1	8.0	12.0	Q1
LM2903AVQDRG4	SOIC	D	8	2500	330.0	12.4	6.4	5.2	2.1	8.0	12.0	Q1
LM2903AVQPWR	TSSOP	PW	8	2000	330.0	12.4	7.0	3.6	1.6	8.0	12.0	Q1
LM2903AVQPWRG4	TSSOP	PW	8	2000	330.0	12.4	7.0	3.6	1.6	8.0	12.0	Q1
LM2903BIDDFR	SOT-23-THIN	DDF	8	3000	180.0	8.4	3.2	3.2	1.4	4.0	8.0	Q3
LM2903BIDGKR	VSSOP	DGK	8	2500	330.0	12.4	5.3	3.4	1.4	8.0	12.0	Q1
LM2903BIDR	SOIC	D	8	2500	330.0	12.4	6.4	5.2	2.1	8.0	12.0	Q1
LM2903BIDSGR	WSO	DSG	8	3000	180.0	8.4	2.3	2.3	1.15	4.0	8.0	Q2
LM2903BIPWR	TSSOP	PW	8	2000	330.0	12.4	7.0	3.6	1.6	8.0	12.0	Q1
LM2903DGKR	VSSOP	DGK	8	2500	330.0	12.4	6.4	5.2	2.1	8.0	12.0	Q1
LM2903DGKR	VSSOP	DGK	8	2500	330.0	12.4	5.3	3.4	1.4	8.0	12.0	Q1
LM2903DR	SOIC	D	8	2500	330.0	12.4	6.4	5.2	2.1	8.0	12.0	Q1
LM2903DR	SOIC	D	8	2500	330.0	12.4	6.4	5.2	2.1	8.0	12.0	Q1

Device	Package Type	Package Drawing	Pins	SPQ	Reel Diameter (mm)	Reel Width W1 (mm)	A0 (mm)	B0 (mm)	K0 (mm)	P1 (mm)	W (mm)	Pin1 Quadrant
LM2903DR	SOIC	D	8	2500	330.0	12.4	6.4	5.2	2.1	8.0	12.0	Q1
LM2903DR	SOIC	D	8	2500	330.0	12.4	6.4	5.2	2.1	8.0	12.0	Q1
LM2903DRG3	SOIC	D	8	2500	330.0	12.8	6.4	5.2	2.1	8.0	12.0	Q1
LM2903PSR	SO	PS	8	2000	330.0	16.4	8.35	6.6	2.4	12.0	16.0	Q1
LM2903PWR	TSSOP	PW	8	2000	330.0	12.4	7.0	3.6	1.6	8.0	12.0	Q1
LM2903PWR	TSSOP	PW	8	2000	330.0	12.4	7.0	3.6	1.6	8.0	12.0	Q1
LM2903PWRG3	TSSOP	PW	8	2000	330.0	12.4	7.0	3.6	1.6	8.0	12.0	Q1
LM2903PWRG4	TSSOP	PW	8	2000	330.0	12.4	7.0	3.6	1.6	8.0	12.0	Q1
LM2903VQDR	SOIC	D	8	2500	330.0	12.4	6.4	5.2	2.1	8.0	12.0	Q1
LM2903VQPWR	TSSOP	PW	8	2000	330.0	12.4	7.0	3.6	1.6	8.0	12.0	Q1
LM2903VQPWR	TSSOP	PW	8	2000	330.0	12.4	7.0	3.6	1.6	8.0	12.0	Q1
LM293ADGKR	VSSOP	DGK	8	2500	330.0	12.4	5.3	3.4	1.4	8.0	12.0	Q1
LM293ADGKR	VSSOP	DGK	8	2500	330.0	12.4	5.3	3.3	1.3	8.0	12.0	Q1
LM293ADGKR	VSSOP	DGK	8	2500	330.0	12.4	5.25	3.35	1.25	8.0	12.0	Q1
LM293ADR	SOIC	D	8	2500	330.0	12.4	6.4	5.2	2.1	8.0	12.0	Q1
LM293ADR	SOIC	D	8	2500	330.0	12.4	6.4	5.2	2.1	8.0	12.0	Q1
LM293DGKR	VSSOP	DGK	8	2500	330.0	12.4	5.3	3.4	1.4	8.0	12.0	Q1
LM293DGKR	VSSOP	DGK	8	2500	330.0	12.4	5.3	3.4	1.4	8.0	12.0	Q1
LM293DR	SOIC	D	8	2500	330.0	12.4	6.4	5.2	2.1	8.0	12.0	Q1
LM293DR	SOIC	D	8	2500	330.0	12.4	6.4	5.2	2.1	8.0	12.0	Q1
LM293DR	SOIC	D	8	2500	330.0	12.4	6.4	5.2	2.1	8.0	12.0	Q1
LM293DRG3	SOIC	D	8	2500	330.0	12.8	6.4	5.2	2.1	8.0	12.0	Q1
LM393ADGKR	VSSOP	DGK	8	2500	330.0	12.4	5.3	3.3	1.3	8.0	12.0	Q1
LM393ADGKR	VSSOP	DGK	8	2500	330.0	12.4	5.3	3.4	1.4	8.0	12.0	Q1
LM393ADGKR	VSSOP	DGK	8	2500	330.0	12.4	5.3	3.4	1.4	8.0	12.0	Q1
LM393ADR	SOIC	D	8	2500	330.0	12.4	6.4	5.2	2.1	8.0	12.0	Q1
LM393ADR	SOIC	D	8	2500	330.0	12.4	6.4	5.2	2.1	8.0	12.0	Q1
LM393ADR	SOIC	D	8	2500	330.0	12.4	6.4	5.2	2.1	8.0	12.0	Q1
LM393APSR	SO	PS	8	2000	330.0	16.4	8.35	6.6	2.4	12.0	16.0	Q1
LM393APWR	TSSOP	PW	8	2000	330.0	12.4	7.0	3.6	1.6	8.0	12.0	Q1
LM393APWR	TSSOP	PW	8	2000	330.0	12.4	7.0	3.6	1.6	8.0	12.0	Q1
LM393BIDDFR	SOT-23-THIN	DDF	8	3000	180.0	8.4	3.2	3.2	1.4	4.0	8.0	Q3
LM393BIDGKR	VSSOP	DGK	8	2500	330.0	12.4	6.4	5.2	2.1	8.0	12.0	Q1
LM393BIDR	SOIC	D	8	2500	330.0	12.4	6.4	5.2	2.1	8.0	12.0	Q1
LM393BIDSGR	WSON	DSG	8	3000	180.0	8.4	2.3	2.3	1.15	4.0	8.0	Q2
LM393BIPWR	TSSOP	PW	8	2000	330.0	12.4	7.0	3.6	1.6	8.0	12.0	Q1
LM393DGKR	VSSOP	DGK	8	2500	330.0	12.4	5.3	3.4	1.4	8.0	12.0	Q1
LM393DGKR	VSSOP	DGK	8	2500	330.0	12.4	5.25	3.35	1.25	8.0	12.0	Q1
LM393DGKR	VSSOP	DGK	8	2500	330.0	12.4	5.3	3.4	1.4	8.0	12.0	Q1
LM393DGKR	VSSOP	DGK	8	2500	330.0	12.4	5.3	3.3	1.3	8.0	12.0	Q1
LM393DGKR	VSSOP	DGK	8	2500	330.0	12.4	5.3	3.4	1.4	8.0	12.0	Q1

Device	Package Type	Package Drawing	Pins	SPQ	Reel Diameter (mm)	Reel Width W1 (mm)	A0 (mm)	B0 (mm)	K0 (mm)	P1 (mm)	W (mm)	Pin1 Quadrant
LM393DR	SOIC	D	8	2500	330.0	12.4	6.4	5.2	2.1	8.0	12.0	Q1
LM393DR	SOIC	D	8	2500	330.0	12.4	6.4	5.2	2.1	8.0	12.0	Q1
LM393DR	SOIC	D	8	2500	330.0	12.4	6.4	5.2	2.1	8.0	12.0	Q1
LM393DR	SOIC	D	8	2500	330.0	12.4	6.4	5.2	2.1	8.0	12.0	Q1
LM393DRG3	SOIC	D	8	2500	330.0	12.8	6.4	5.2	2.1	8.0	12.0	Q1
LM393PSR	SO	PS	8	2000	330.0	16.4	8.35	6.6	2.4	12.0	16.0	Q1
LM393PWR	TSSOP	PW	8	2000	330.0	12.4	7.0	3.6	1.6	8.0	12.0	Q1
LM393PWRG3	TSSOP	PW	8	2000	330.0	12.4	7.0	3.6	1.6	8.0	12.0	Q1
LM393PWRG4	TSSOP	PW	8	2000	330.0	12.4	7.0	3.6	1.6	8.0	12.0	Q1

TAPE AND REEL BOX DIMENSIONS

*All dimensions are nominal

Device	Package Type	Package Drawing	Pins	SPQ	Length (mm)	Width (mm)	Height (mm)
LM193DR	SOIC	D	8	2500	353.0	353.0	32.0
LM193DRG4	SOIC	D	8	2500	353.0	353.0	32.0
LM2903AVQDR	SOIC	D	8	2500	353.0	353.0	32.0
LM2903AVQDRG4	SOIC	D	8	2500	353.0	353.0	32.0
LM2903AVQPWR	TSSOP	PW	8	2000	356.0	356.0	35.0
LM2903AVQPWRG4	TSSOP	PW	8	2000	356.0	356.0	35.0
LM2903BIDDFR	SOT-23-THIN	DDF	8	3000	210.0	185.0	35.0
LM2903BIDGKR	VSSOP	DGK	8	2500	353.0	353.0	32.0
LM2903BIDR	SOIC	D	8	2500	353.0	353.0	32.0
LM2903BIDSGR	WSON	DSG	8	3000	210.0	185.0	35.0
LM2903BIPWR	TSSOP	PW	8	2000	356.0	356.0	35.0
LM2903DGKR	VSSOP	DGK	8	2500	353.0	353.0	32.0
LM2903DGKR	VSSOP	DGK	8	2500	356.0	356.0	35.0
LM2903DR	SOIC	D	8	2500	340.5	338.1	20.6
LM2903DR	SOIC	D	8	2500	356.0	356.0	35.0
LM2903DR	SOIC	D	8	2500	353.0	353.0	32.0
LM2903DR	SOIC	D	8	2500	353.0	353.0	32.0
LM2903DRG3	SOIC	D	8	2500	364.0	364.0	27.0

Device	Package Type	Package Drawing	Pins	SPQ	Length (mm)	Width (mm)	Height (mm)
LM2903PSR	SO	PS	8	2000	356.0	356.0	35.0
LM2903PWR	TSSOP	PW	8	2000	356.0	356.0	35.0
LM2903PWR	TSSOP	PW	8	2000	356.0	356.0	35.0
LM2903PWRG3	TSSOP	PW	8	2000	364.0	364.0	27.0
LM2903PWRG4	TSSOP	PW	8	2000	356.0	356.0	35.0
LM2903VQDR	SOIC	D	8	2500	353.0	353.0	32.0
LM2903VQPWR	TSSOP	PW	8	2000	356.0	356.0	35.0
LM2903VQPWR	TSSOP	PW	8	2000	356.0	356.0	35.0
LM293ADGKR	VSSOP	DGK	8	2500	358.0	335.0	35.0
LM293ADGKR	VSSOP	DGK	8	2500	370.0	355.0	55.0
LM293ADGKR	VSSOP	DGK	8	2500	366.0	364.0	50.0
LM293ADR	SOIC	D	8	2500	353.0	353.0	32.0
LM293ADR	SOIC	D	8	2500	356.0	356.0	35.0
LM293DGKR	VSSOP	DGK	8	2500	356.0	356.0	35.0
LM293DGKR	VSSOP	DGK	8	2500	353.0	353.0	32.0
LM293DR	SOIC	D	8	2500	356.0	356.0	35.0
LM293DR	SOIC	D	8	2500	356.0	356.0	35.0
LM293DR	SOIC	D	8	2500	353.0	353.0	32.0
LM293DRG3	SOIC	D	8	2500	364.0	364.0	27.0
LM393ADGKR	VSSOP	DGK	8	2500	346.0	346.0	35.0
LM393ADGKR	VSSOP	DGK	8	2500	364.0	364.0	27.0
LM393ADGKR	VSSOP	DGK	8	2500	358.0	335.0	35.0
LM393ADR	SOIC	D	8	2500	356.0	356.0	35.0
LM393ADR	SOIC	D	8	2500	353.0	353.0	32.0
LM393ADR	SOIC	D	8	2500	356.0	356.0	35.0
LM393APSR	SO	PS	8	2000	356.0	356.0	35.0
LM393APWR	TSSOP	PW	8	2000	356.0	356.0	35.0
LM393APWR	TSSOP	PW	8	2000	356.0	356.0	35.0
LM393BIDDFR	SOT-23-THIN	DDF	8	3000	210.0	185.0	35.0
LM393BIDGKR	VSSOP	DGK	8	2500	353.0	353.0	32.0
LM393BIDR	SOIC	D	8	2500	353.0	353.0	32.0
LM393BIDSGR	WSON	DSG	8	3000	210.0	185.0	35.0
LM393BIPWR	TSSOP	PW	8	2000	356.0	356.0	35.0
LM393DGKR	VSSOP	DGK	8	2500	353.0	353.0	32.0
LM393DGKR	VSSOP	DGK	8	2500	366.0	364.0	50.0
LM393DGKR	VSSOP	DGK	8	2500	356.0	356.0	35.0
LM393DGKR	VSSOP	DGK	8	2500	346.0	346.0	35.0
LM393DGKR	VSSOP	DGK	8	2500	358.0	335.0	35.0
LM393DR	SOIC	D	8	2500	353.0	353.0	32.0
LM393DR	SOIC	D	8	2500	356.0	356.0	35.0
LM393DR	SOIC	D	8	2500	353.0	353.0	32.0
LM393DR	SOIC	D	8	2500	340.5	338.1	20.6
LM393DRG3	SOIC	D	8	2500	364.0	364.0	27.0

Device	Package Type	Package Drawing	Pins	SPQ	Length (mm)	Width (mm)	Height (mm)
LM393PSR	SO	PS	8	2000	356.0	356.0	35.0
LM393PWR	TSSOP	PW	8	2000	356.0	356.0	35.0
LM393PWRG3	TSSOP	PW	8	2000	364.0	364.0	27.0
LM393PWRG4	TSSOP	PW	8	2000	356.0	356.0	35.0

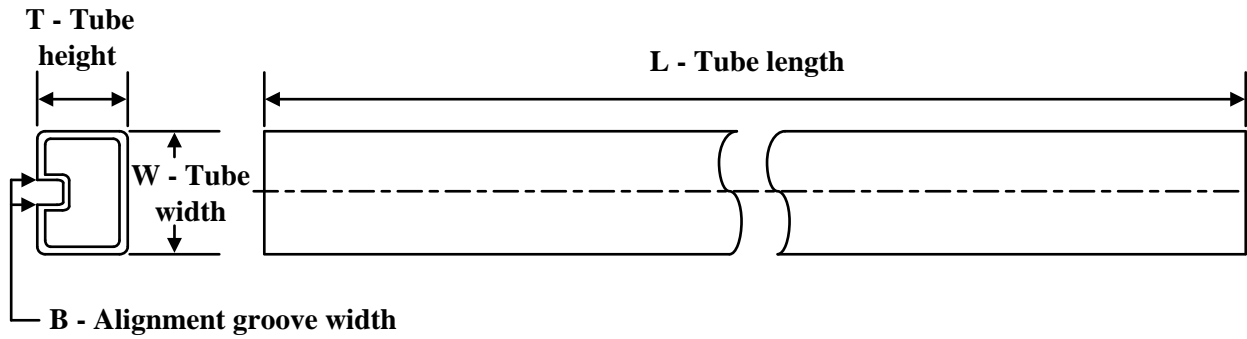
TUBE

*All dimensions are nominal

Device	Package Name	Package Type	Pins	SPQ	L (mm)	W (mm)	T (μm)	B (mm)
LM2903P	P	PDIP	8	50	506	13.97	11230	4.32
LM2903QD	D	SOIC	8	75	505.46	6.76	3810	4
LM293P	P	PDIP	8	50	506	13.97	11230	4.32
LM393AP	P	PDIP	8	50	506.1	9	600	5.4
LM393AP	P	PDIP	8	50	506	13.97	11230	4.32
LM393P	P	PDIP	8	50	506	13.97	11230	4.32
LM393P	P	PDIP	8	50	506.1	9	600	5.4
LM393PE3	P	PDIP	8	50	506.1	9	600	5.4
LM393PE4	P	PDIP	8	50	506	13.97	11230	4.32
LM393PS	PS	SOP	8	80	530	10.5	4000	4.1

EXAMPLE BOARD LAYOUT

DDF0008A

SOT-23-THIN - 1.1 mm max height

PLASTIC SMALL OUTLINE

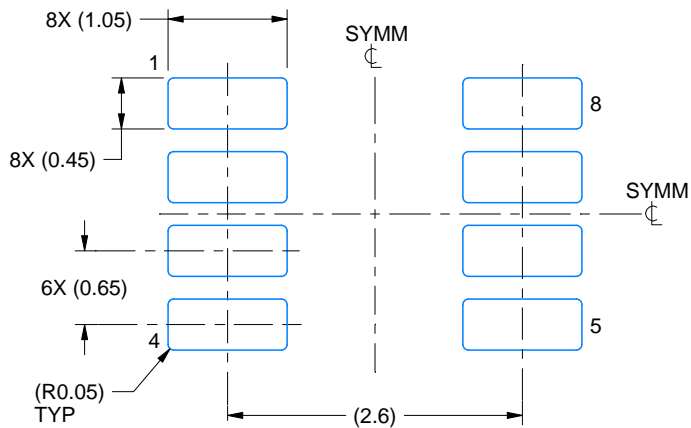

LAND PATTERN EXAMPLE
EXPOSED METAL SHOWN
SCALE:15X

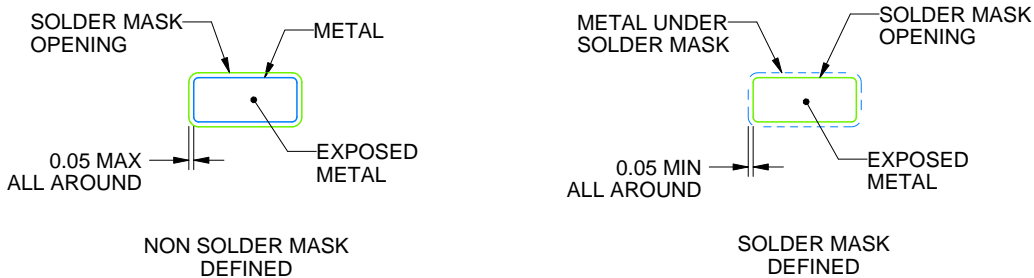

SOLDER MASK DETAILS

4222047/E 07/2024

NOTES: (continued)

4. Publication IPC-7351 may have alternate designs.
5. Solder mask tolerances between and around signal pads can vary based on board fabrication site.

EXAMPLE STENCIL DESIGN

DDF0008A

SOT-23-THIN - 1.1 mm max height

PLASTIC SMALL OUTLINE

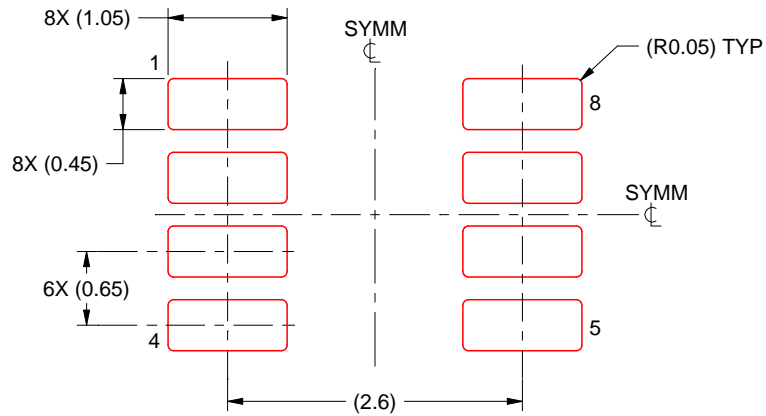

SOLDER PASTE EXAMPLE
BASED ON 0.125 mm THICK STENCIL
SCALE:15X

4222047/E 07/2024

NOTES: (continued)

6. Laser cutting apertures with trapezoidal walls and rounded corners may offer better paste release. IPC-7525 may have alternate design recommendations.
7. Board assembly site may have different recommendations for stencil design.

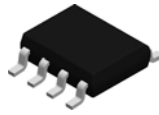

D0008A

PACKAGE OUTLINE

SOIC - 1.75 mm max height

SMALL OUTLINE INTEGRATED CIRCUIT

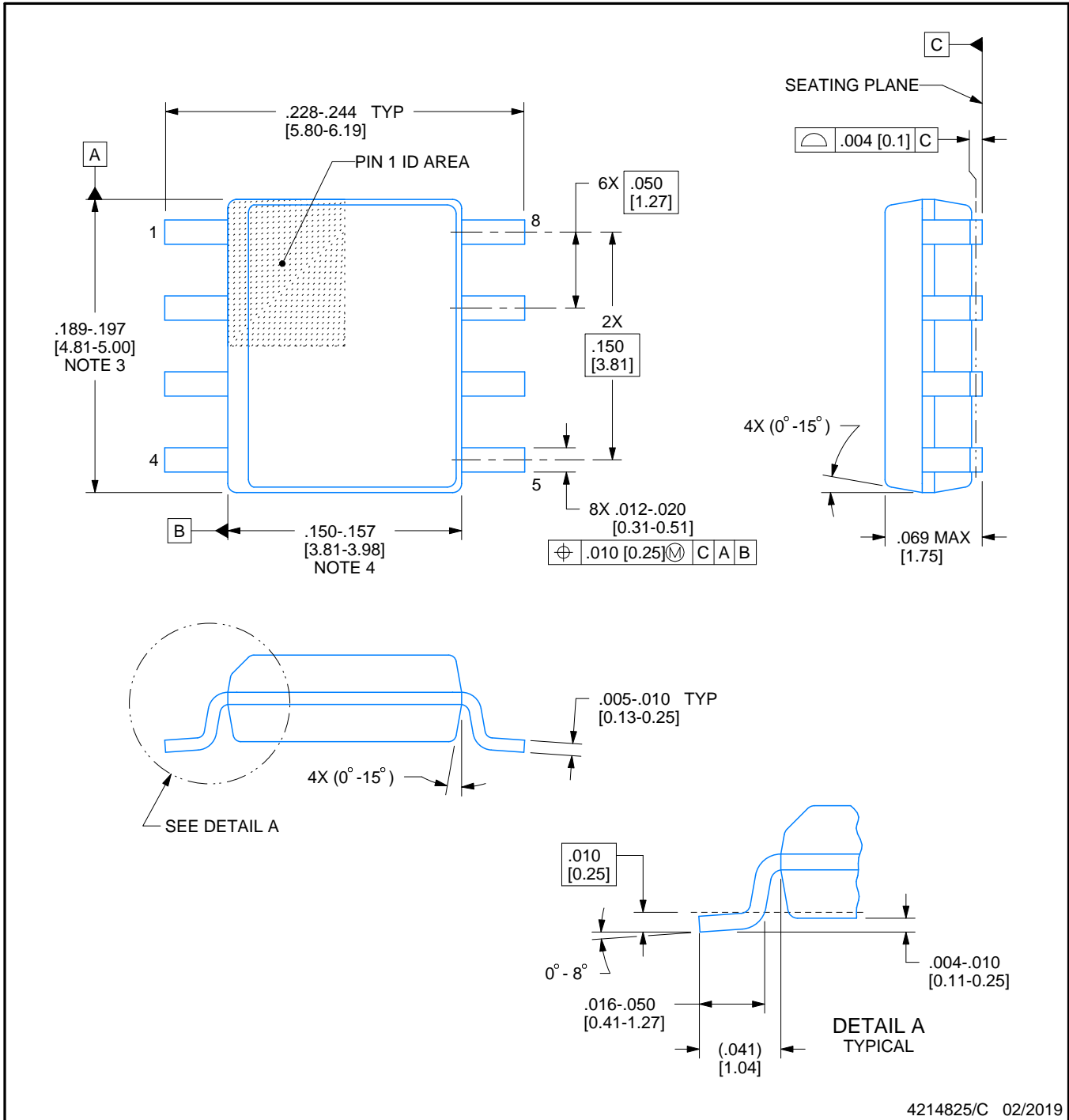

4214825/C 02/2019

NOTES:

- Linear dimensions are in inches [millimeters]. Dimensions in parenthesis are for reference only. Controlling dimensions are in inches. Dimensioning and tolerancing per ASME Y14.5M.
- This drawing is subject to change without notice.
- This dimension does not include mold flash, protrusions, or gate burrs. Mold flash, protrusions, or gate burrs shall not exceed $.006$ [0.15] per side.
- This dimension does not include interlead flash.
- Reference JEDEC registration MS-012, variation AA.

EXAMPLE BOARD LAYOUT

D0008A

SOIC - 1.75 mm max height

SMALL OUTLINE INTEGRATED CIRCUIT

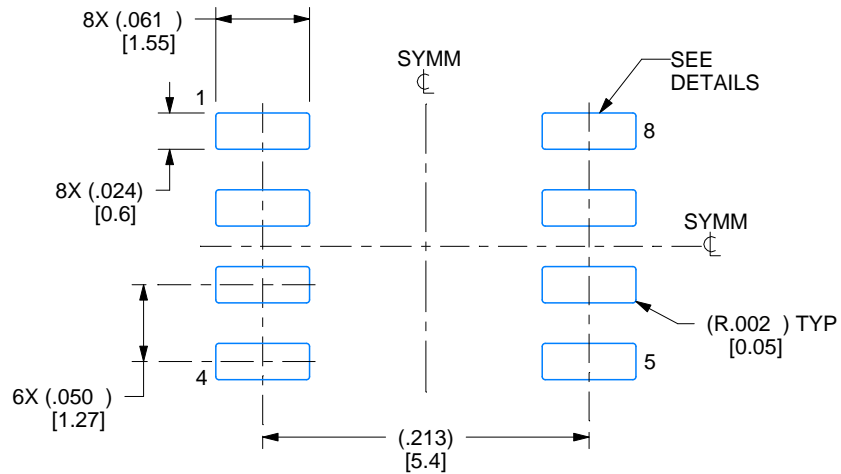

LAND PATTERN EXAMPLE
EXPOSED METAL SHOWN
SCALE:8X

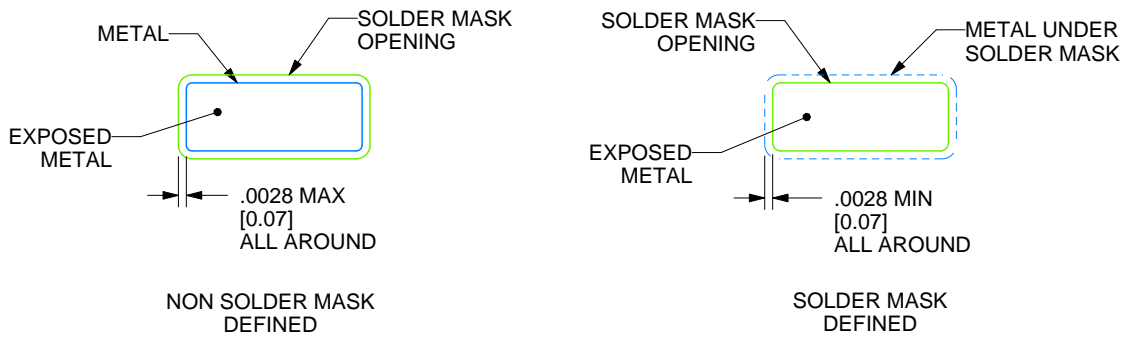

SOLDER MASK DETAILS

4214825/C 02/2019

NOTES: (continued)

- 6. Publication IPC-7351 may have alternate designs.
- 7. Solder mask tolerances between and around signal pads can vary based on board fabrication site.

EXAMPLE STENCIL DESIGN

D0008A

SOIC - 1.75 mm max height

SMALL OUTLINE INTEGRATED CIRCUIT

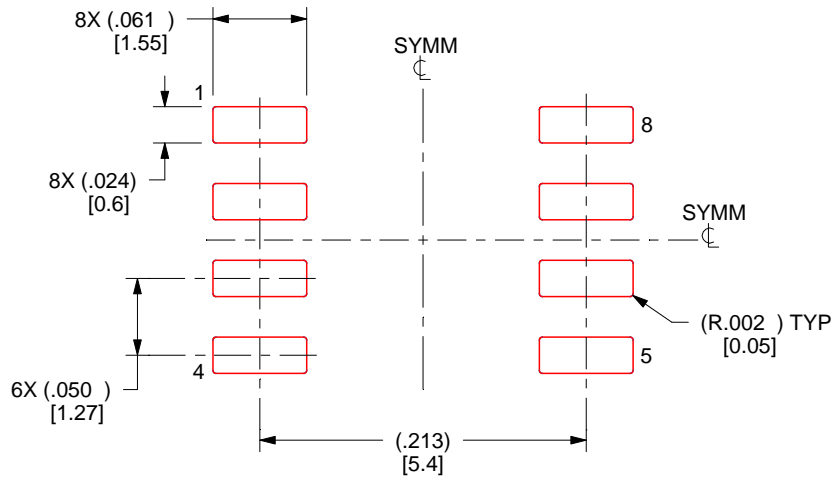

SOLDER PASTE EXAMPLE
BASED ON .005 INCH [0.125 MM] THICK STENCIL
SCALE:8X

4214825/C 02/2019

NOTES: (continued)

8. Laser cutting apertures with trapezoidal walls and rounded corners may offer better paste release. IPC-7525 may have alternate design recommendations.
9. Board assembly site may have different recommendations for stencil design.

MECHANICAL DATA

PS (R-PDSO-G8)

PLASTIC SMALL-OUTLINE PACKAGE

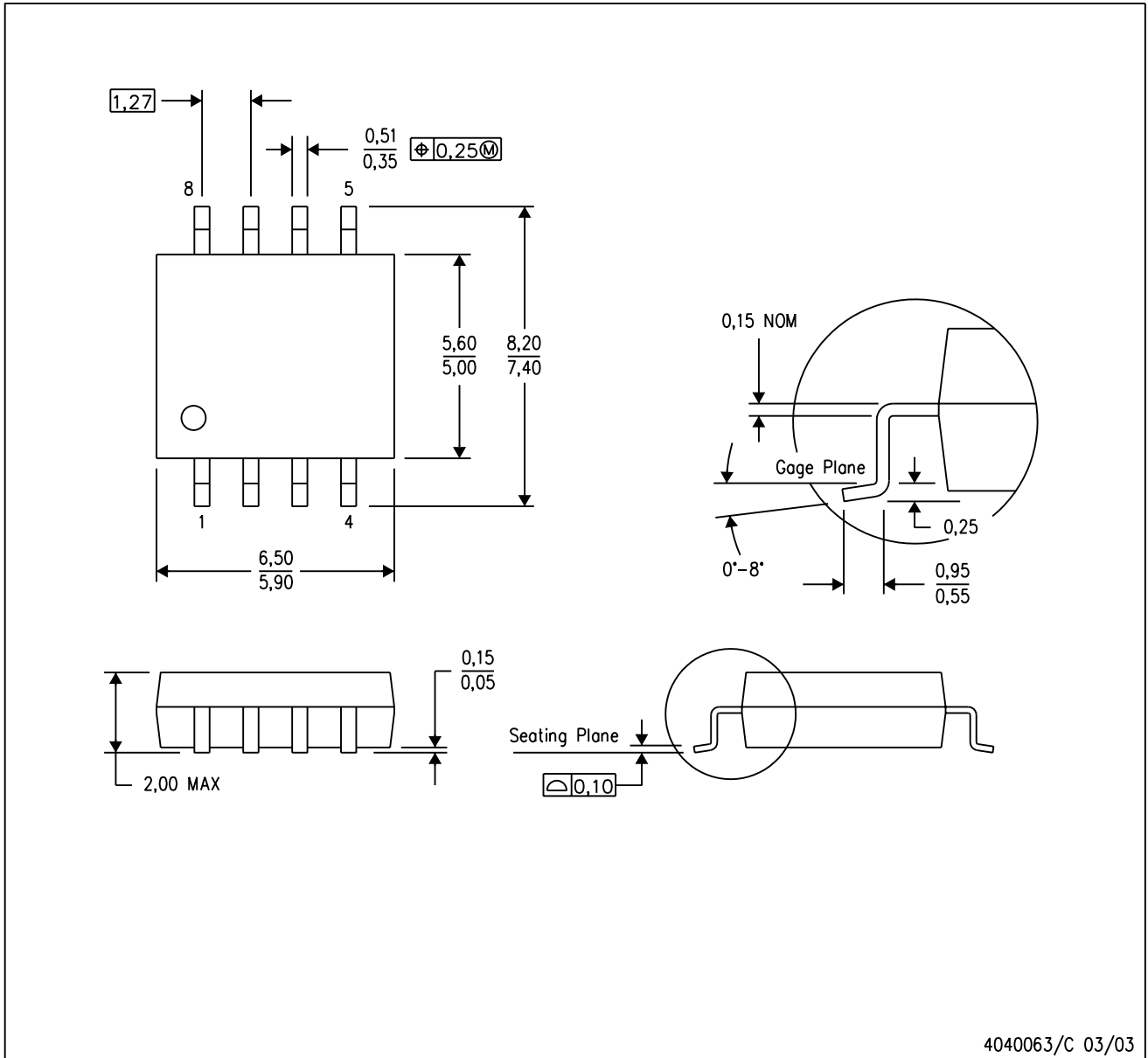

- NOTES:
- A. All linear dimensions are in millimeters.
 - B. This drawing is subject to change without notice.
 - C. Body dimensions do not include mold flash or protrusion, not to exceed 0,15.

PS (R-PDSO-G8)

PLASTIC SMALL OUTLINE

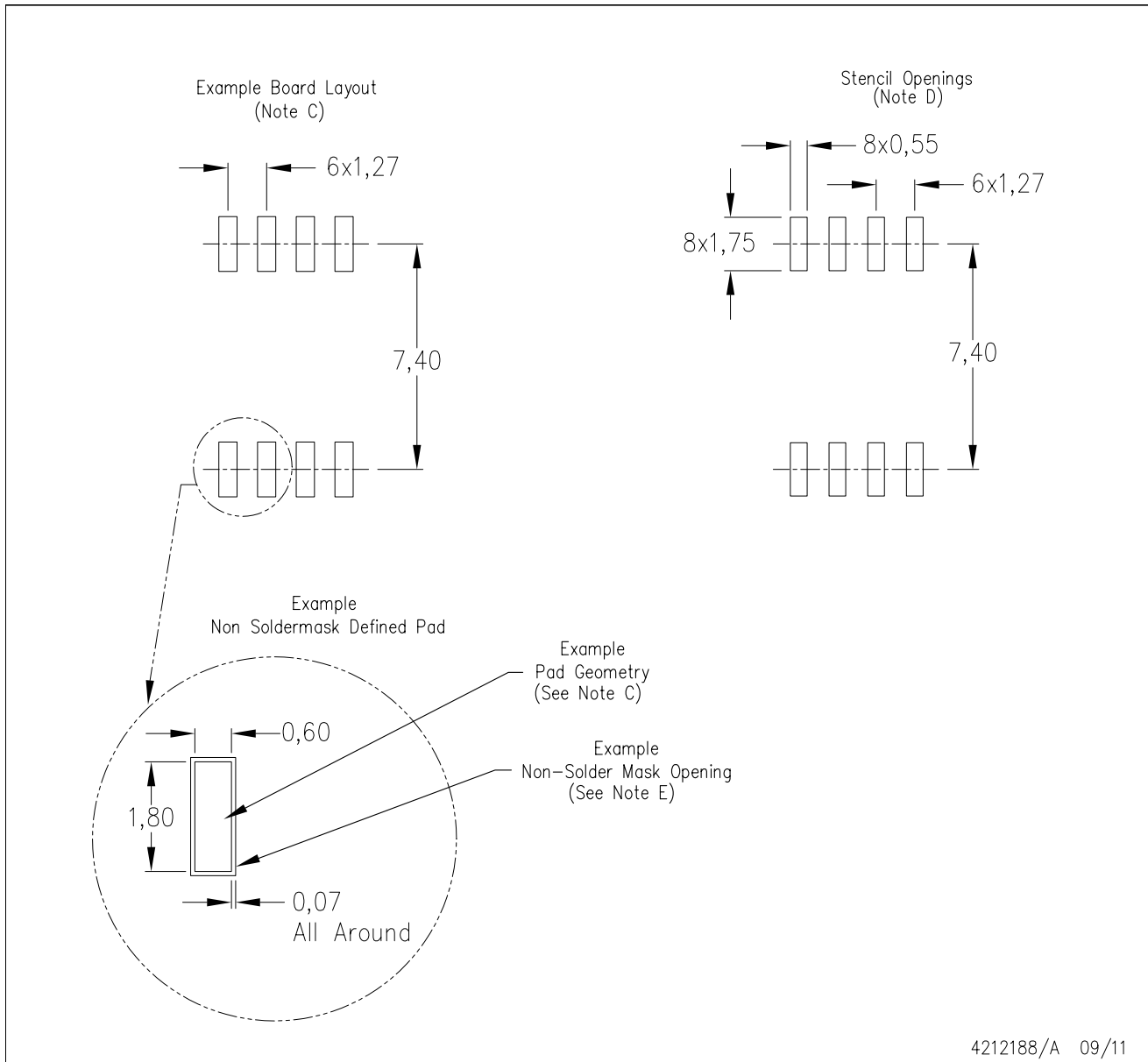

- NOTES:
- All linear dimensions are in millimeters.
 - This drawing is subject to change without notice.
 - Publication IPC-7351 is recommended for alternate designs.
 - Laser cutting apertures with trapezoidal walls and also rounding corners will offer better paste release. Customers should contact their board assembly site for stencil design recommendations. Refer to IPC-7525 for other stencil recommendations.
 - Customers should contact their board fabrication site for solder mask tolerances between and around signal pads.

P (R-PDIP-T8)

PLASTIC DUAL-IN-LINE PACKAGE

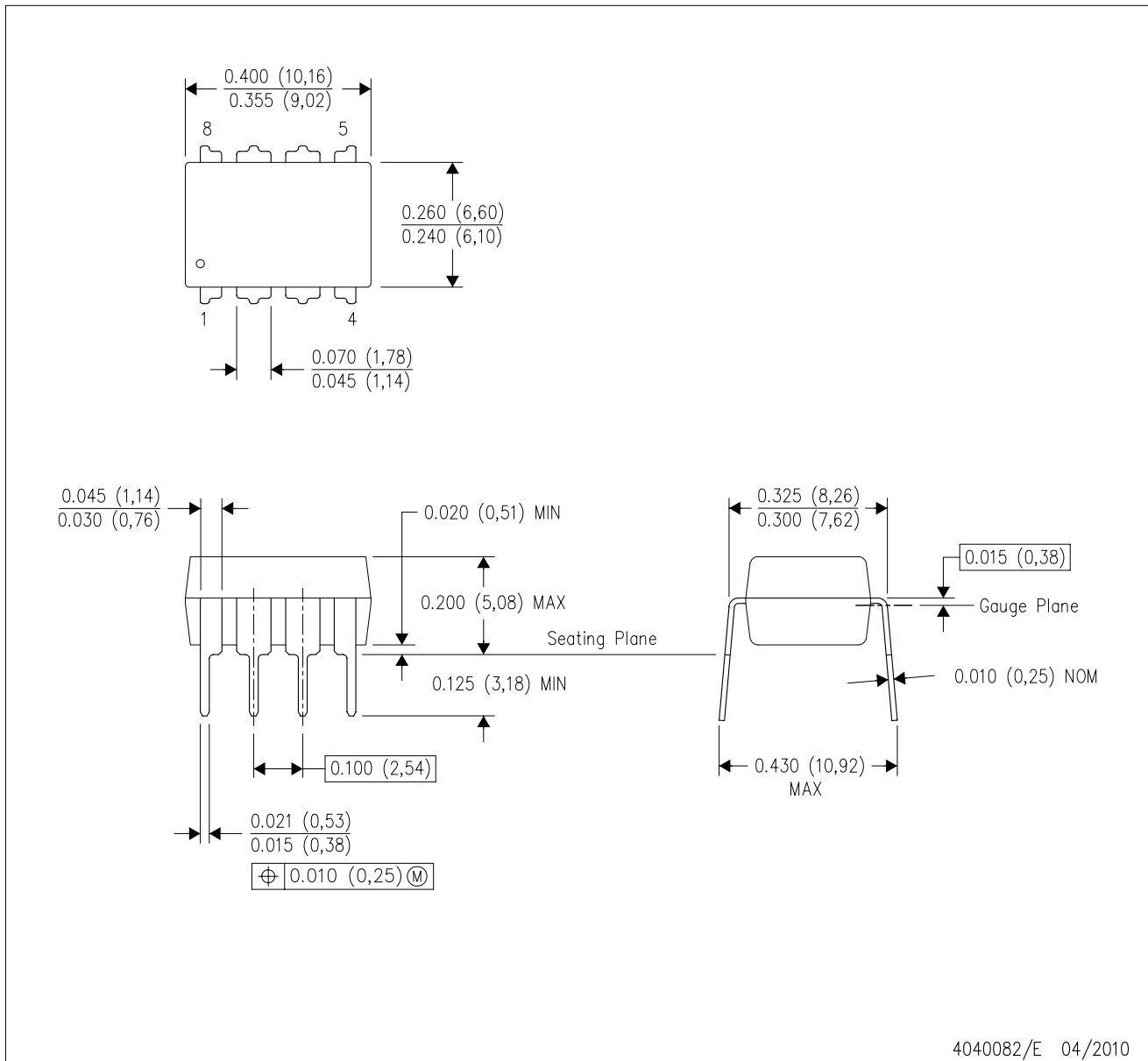

- NOTES:
- A. All linear dimensions are in inches (millimeters).
 - B. This drawing is subject to change without notice.
 - C. Falls within JEDEC MS-001 variation BA.

GENERIC PACKAGE VIEW

DSG 8

WSON - 0.8 mm max height

2 x 2, 0.5 mm pitch

PLASTIC SMALL OUTLINE - NO LEAD

This image is a representation of the package family, actual package may vary.
Refer to the product data sheet for package details.

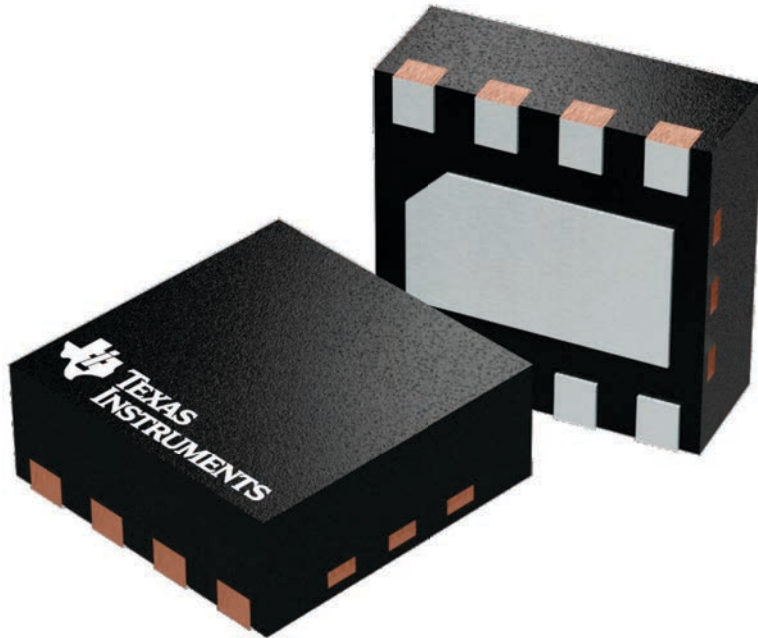

4224783/A

DSG0008A

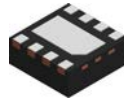

PACKAGE OUTLINE

WSON - 0.8 mm max height

PLASTIC SMALL OUTLINE - NO LEAD

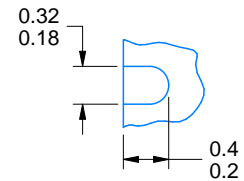
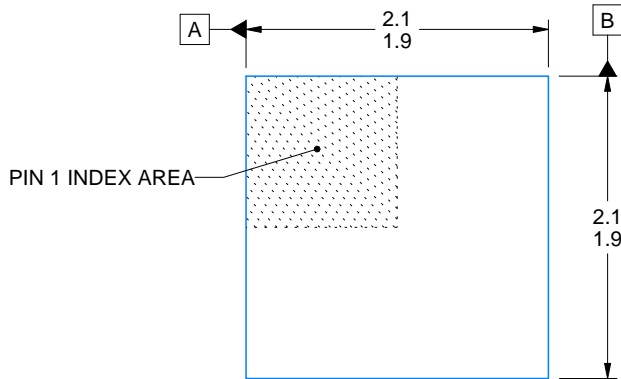

ALTERNATIVE TERMINAL SHAPE TYPICAL

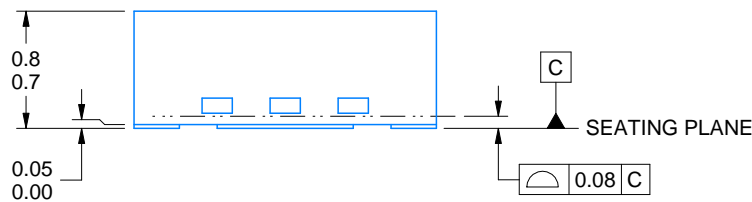

SIDE WALL METAL THICKNESS DIM A	
OPTION 1	OPTION 2
0.1	0.2

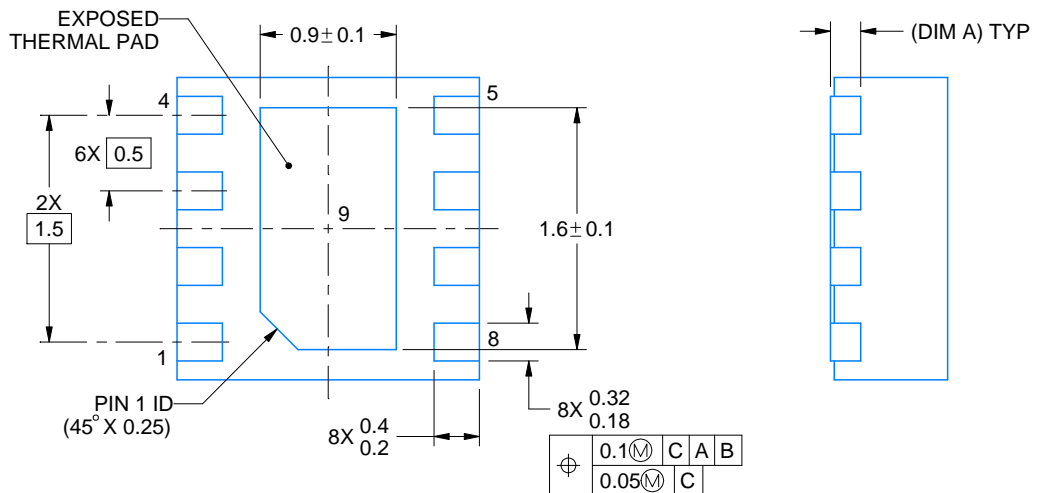

4218900/E 08/2022

NOTES:

1. All linear dimensions are in millimeters. Any dimensions in parenthesis are for reference only. Dimensioning and tolerancing per ASME Y14.5M.
2. This drawing is subject to change without notice.
3. The package thermal pad must be soldered to the printed circuit board for thermal and mechanical performance.

EXAMPLE BOARD LAYOUT

DSG0008A

WSON - 0.8 mm max height

PLASTIC SMALL OUTLINE - NO LEAD

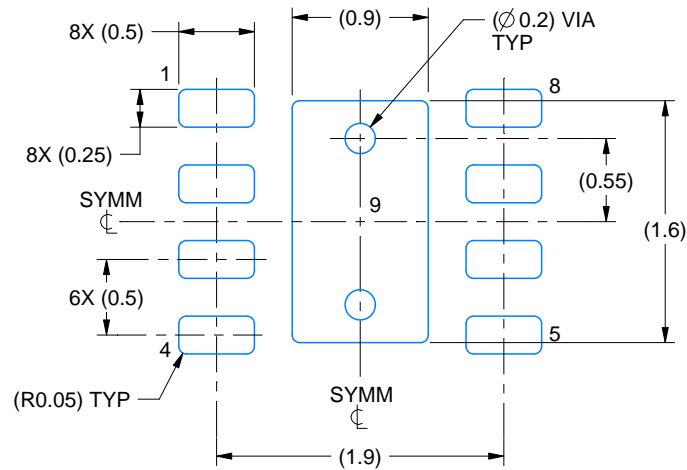

LAND PATTERN EXAMPLE
SCALE:20X

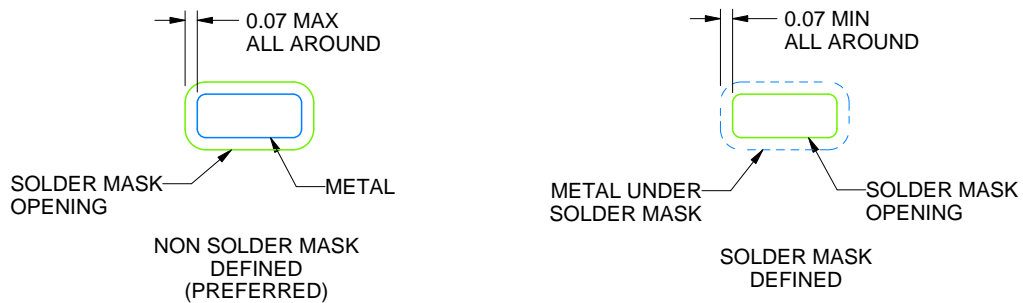

SOLDER MASK DETAILS

4218900/E 08/2022

NOTES: (continued)

4. This package is designed to be soldered to a thermal pad on the board. For more information, see Texas Instruments literature number SLUA271 (www.ti.com/lit/slua271).
5. Vias are optional depending on application, refer to device data sheet. If any vias are implemented, refer to their locations shown on this view. It is recommended that vias under paste be filled, plugged or tented.

EXAMPLE STENCIL DESIGN

DSG0008A

WSON - 0.8 mm max height

PLASTIC SMALL OUTLINE - NO LEAD

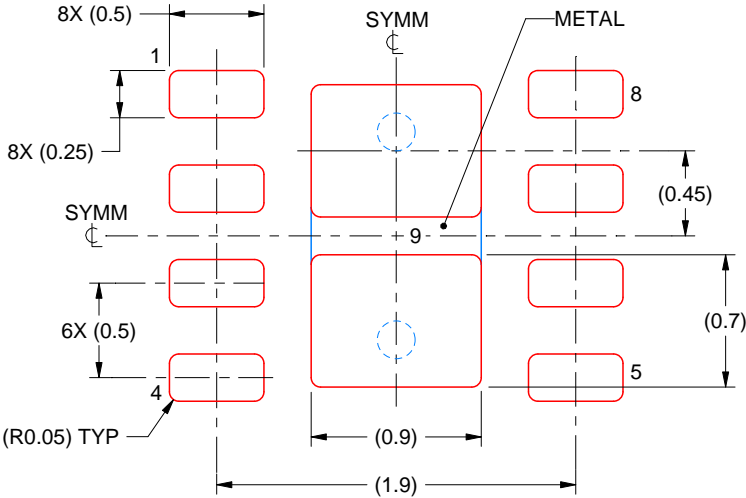

SOLDER PASTE EXAMPLE
 BASED ON 0.125 mm THICK STENCIL

EXPOSED PAD 9:
 87% PRINTED SOLDER COVERAGE BY AREA UNDER PACKAGE
 SCALE:25X

4218900/E 08/2022

NOTES: (continued)

6. Laser cutting apertures with trapezoidal walls and rounded corners may offer better paste release. IPC-7525 may have alternate design recommendations.

PW0008A

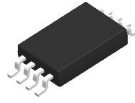

PACKAGE OUTLINE

TSSOP - 1.2 mm max height

SMALL OUTLINE PACKAGE

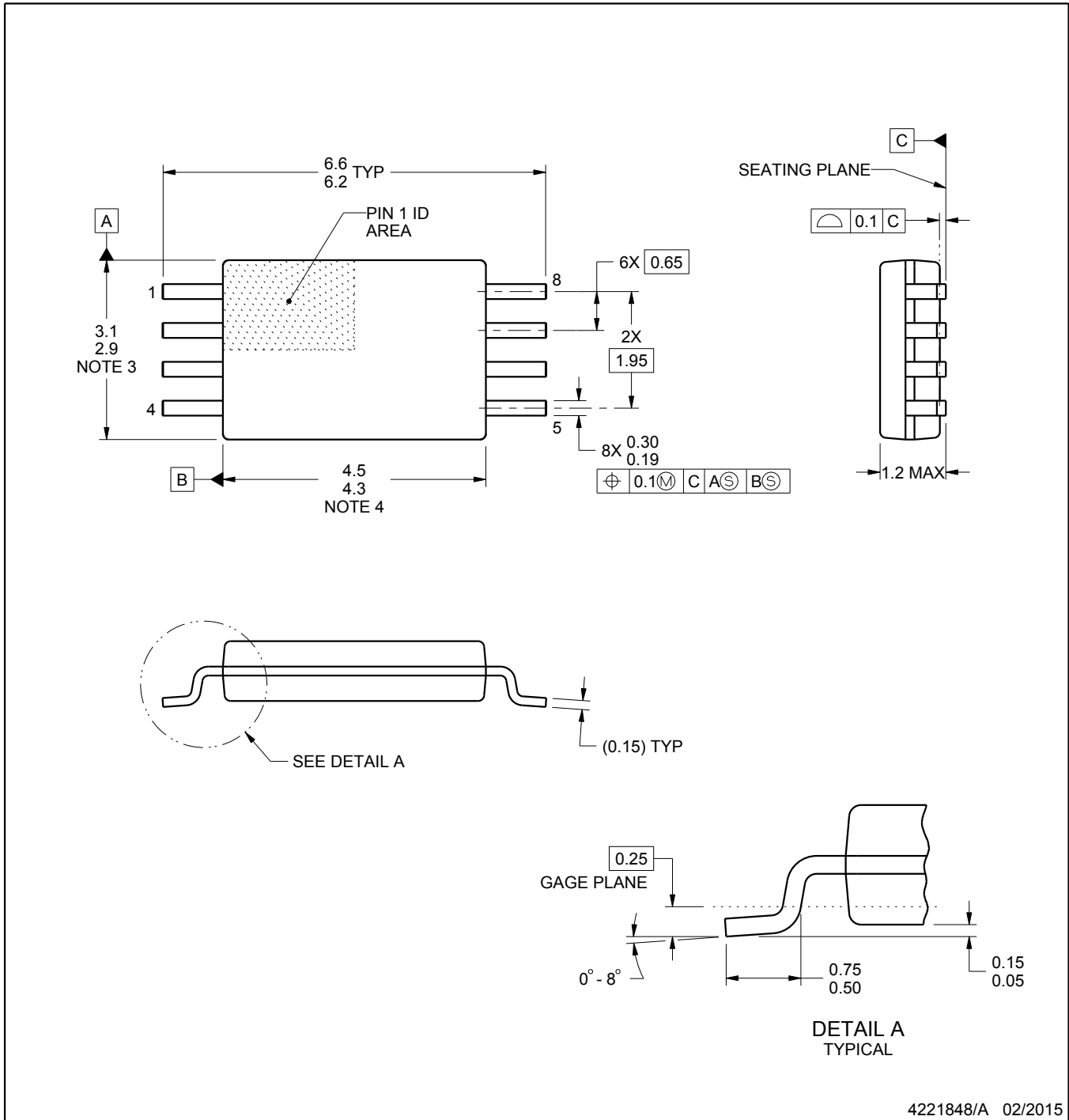

4221848/A 02/2015

NOTES:

1. All linear dimensions are in millimeters. Any dimensions in parenthesis are for reference only. Dimensioning and tolerancing per ASME Y14.5M.
2. This drawing is subject to change without notice.
3. This dimension does not include mold flash, protrusions, or gate burrs. Mold flash, protrusions, or gate burrs shall not exceed 0.15 mm per side.
4. This dimension does not include interlead flash. Interlead flash shall not exceed 0.25 mm per side.
5. Reference JEDEC registration MO-153, variation AA.

EXAMPLE BOARD LAYOUT

PW0008A

TSSOP - 1.2 mm max height

SMALL OUTLINE PACKAGE

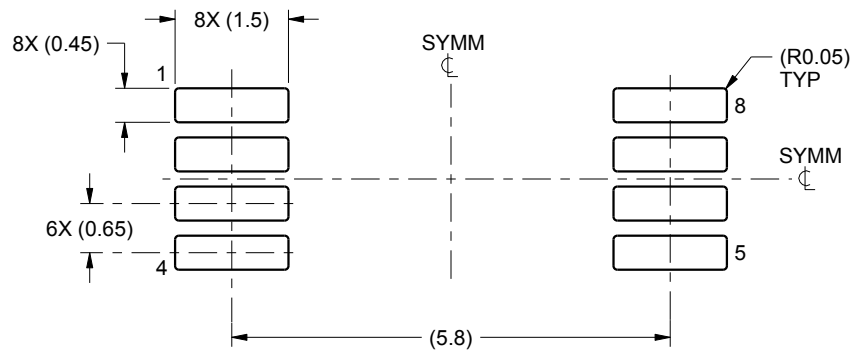

LAND PATTERN EXAMPLE
SCALE:10X

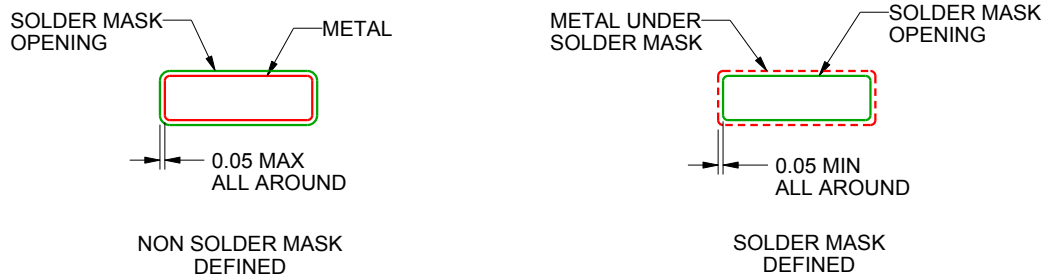

SOLDER MASK DETAILS
NOT TO SCALE

4221848/A 02/2015

NOTES: (continued)

- 6. Publication IPC-7351 may have alternate designs.
- 7. Solder mask tolerances between and around signal pads can vary based on board fabrication site.

EXAMPLE STENCIL DESIGN

PW0008A

TSSOP - 1.2 mm max height

SMALL OUTLINE PACKAGE

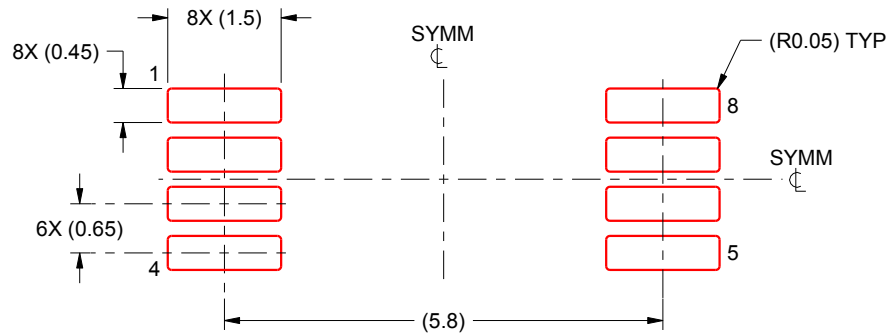

SOLDER PASTE EXAMPLE
BASED ON 0.125 mm THICK STENCIL
SCALE:10X

4221848/A 02/2015

NOTES: (continued)

8. Laser cutting apertures with trapezoidal walls and rounded corners may offer better paste release. IPC-7525 may have alternate design recommendations.
9. Board assembly site may have different recommendations for stencil design.

DGK0008A

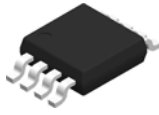

PACKAGE OUTLINE

VSSOP - 1.1 mm max height

SMALL OUTLINE PACKAGE

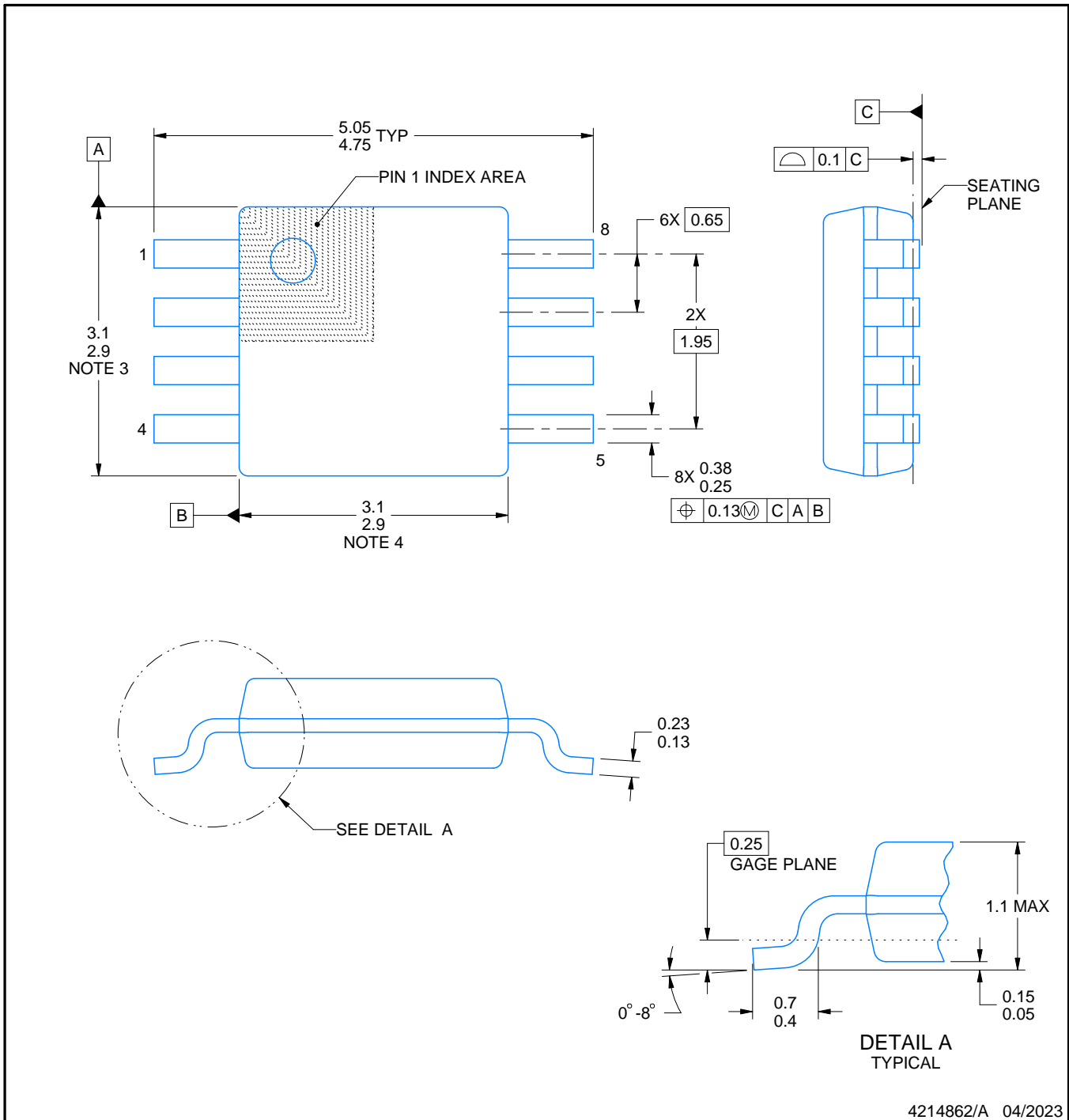

NOTES:

PowerPAD is a trademark of Texas Instruments.

1. All linear dimensions are in millimeters. Any dimensions in parenthesis are for reference only. Dimensioning and tolerancing per ASME Y14.5M.
2. This drawing is subject to change without notice.
3. This dimension does not include mold flash, protrusions, or gate burrs. Mold flash, protrusions, or gate burrs shall not exceed 0.15 mm per side.
4. This dimension does not include interlead flash. Interlead flash shall not exceed 0.25 mm per side.
5. Reference JEDEC registration MO-187.

EXAMPLE BOARD LAYOUT

DGK0008A

TM VSSOP - 1.1 mm max height

SMALL OUTLINE PACKAGE

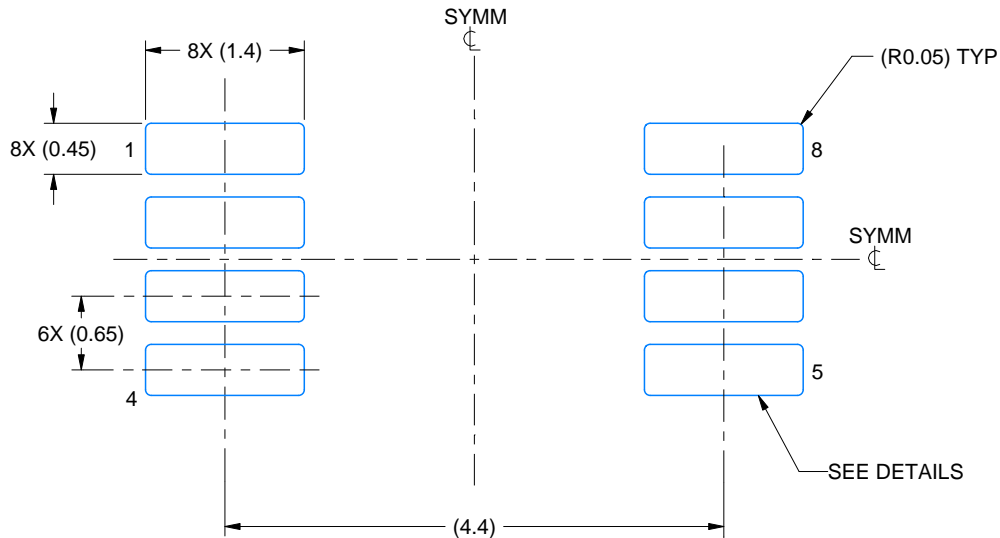

LAND PATTERN EXAMPLE
EXPOSED METAL SHOWN
SCALE: 15X

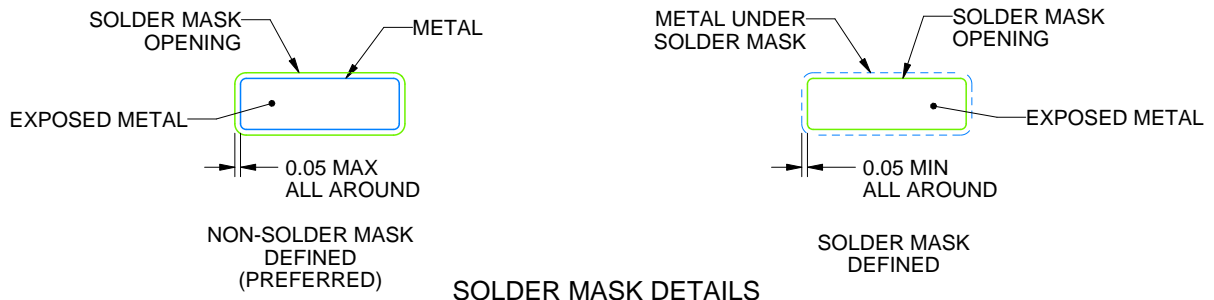

SOLDER MASK DETAILS

4214862/A 04/2023

NOTES: (continued)

6. Publication IPC-7351 may have alternate designs.
7. Solder mask tolerances between and around signal pads can vary based on board fabrication site.
8. Vias are optional depending on application, refer to device data sheet. If any vias are implemented, refer to their locations shown on this view. It is recommended that vias under paste be filled, plugged or tented.
9. Size of metal pad may vary due to creepage requirement.

EXAMPLE STENCIL DESIGN

DGK0008A

TM VSSOP - 1.1 mm max height

SMALL OUTLINE PACKAGE

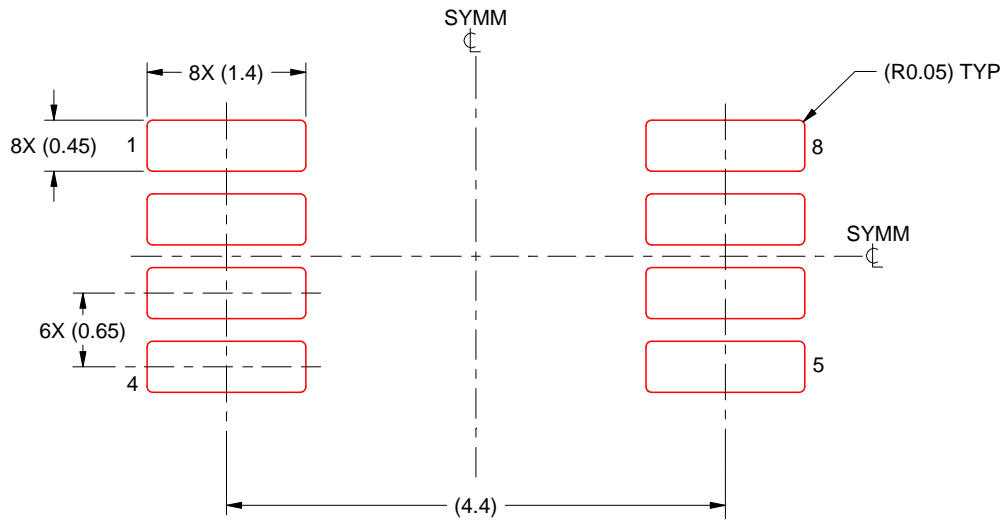

SOLDER PASTE EXAMPLE
SCALE: 15X

4214862/A 04/2023

NOTES: (continued)

11. Laser cutting apertures with trapezoidal walls and rounded corners may offer better paste release. IPC-7525 may have alternate design recommendations.
12. Board assembly site may have different recommendations for stencil design.

重要なお知らせと免責事項

テキサス・インスツルメンツは、技術データと信頼性データ(データシートを含みます)、設計リソース(リファレンス デザインを含みます)、アプリケーションや設計に関する各種アドバイス、Web ツール、安全性情報、その他のリソースを、欠陥が存在する可能性のある「現状のまま」提供しており、商品性および特定目的に対する適合性の黙示保証、第三者の知的財産権の非侵害保証を含むいかなる保証も、明示的または黙示的にかかわらず拒否します。

これらのリソースは、テキサス・インスツルメンツ製品を使用する設計の経験を積んだ開発者への提供を意図したものです。(1) お客様のアプリケーションに適したテキサス・インスツルメンツ製品の選定、(2) お客様のアプリケーションの設計、検証、試験、(3) お客様のアプリケーションに該当する各種規格や、その他のあらゆる安全性、セキュリティ、規制、または他の要件への確実な適合に関する責任を、お客様のみが単独で負うものとし、ます。

上記の各種リソースは、予告なく変更される可能性があります。これらのリソースは、リソースで説明されているテキサス・インスツルメンツ製品を使用するアプリケーションの開発の目的でのみ、テキサス・インスツルメンツはその使用をお客様に許諾します。これらのリソースに関して、他の目的で複製することや掲載することは禁止されています。テキサス・インスツルメンツや第三者の知的財産権のライセンスが付与されている訳ではありません。お客様は、これらのリソースを自身で使用した結果発生するあらゆる申し立て、損害、費用、損失、責任について、テキサス・インスツルメンツおよびその代理人を完全に補償するものとし、テキサス・インスツルメンツは一切の責任を拒否します。

テキサス・インスツルメンツの製品は、[テキサス・インスツルメンツの販売条件](#)、または [ti.com](https://www.ti.com) やかかるテキサス・インスツルメンツ製品の関連資料などのいずれかを通じて提供する適用可能な条項の下で提供されています。テキサス・インスツルメンツがこれらのリソースを提供することは、適用されるテキサス・インスツルメンツの保証または他の保証の放棄の拡大や変更を意味するものではありません。

お客様がいかなる追加条項または代替条項を提案した場合でも、テキサス・インスツルメンツはそれらに異議を唱え、拒否します。

郵送先住所：Texas Instruments, Post Office Box 655303, Dallas, Texas 75265
Copyright © 2025, Texas Instruments Incorporated