

# OPA166x 低消費電力、低ノイズおよび低歪、バイポーラ入力、SoundPlus™ オーディオ オペアンプ



## 1 特長

- 低ノイズ: 1kHz で  $3.3\text{nV}/\sqrt{\text{Hz}}$
- 低歪: 1kHz 時に 0.00006%
- 小さい静止電流:  
1.5mA (チャンネルあたり)
- スルーレート:  $17\text{V}/\mu\text{s}$
- 広いゲイン帯域幅: 22MHz (G = +1)
- ユニティゲイン安定
- レール ツー レール出力
- 広い電源電圧範囲:  
 $\pm 1.5\text{V} \sim \pm 18\text{V}$  または  $3\text{V} \sim 36\text{V}$
- デュアルおよびクワッドのバージョンで供給
- 小型のパッケージ  
デュアル: SOIC-8、VSSOP-8  
クワッド: SOIC-14、TSSOP-14

## 2 アプリケーション

- USB および FireWire オーディオ システム
- アナログ/デジタル ミキサ
- ポータブル レコーディング システム
- オーディオ エフェクト プロセッサ
- ハイエンド A/V レシーバ
- ハイエンド DVD および Blu-Ray™ プレーヤ
- ハイエンド カー オーディオ

## 3 概要

デュアル OPA1662 およびクワッド OPA1664 (OPA166x) バイポーラ入力 SoundPlus™ オーディオ オペアンプ シリーズは、 $3.3\text{nV}/\sqrt{\text{Hz}}$  の低ノイズ密度と 0.00006% (1kHz 時) の超低歪みを実現しています。OPA166x オペアンプ シリーズは、 $2\text{k}\Omega$  の負荷で 600mV 以内のレール ツー レール出力が可能のため、ヘッドルームが増大し、ダイナミック レンジが最大化されます。これらのデバイスは、 $\pm 30\text{mA}$  の高い出力駆動能力も持っています。

これらのデバイスは  $\pm 1.5\text{V} \sim \pm 18\text{V}$  または  $3\text{V} \sim 36\text{V}$  の非常に広い範囲の電源電圧において、チャンネルごとにわずか  $1.5\text{mA}$  の消費電流で動作します。OPA166x オペアンプは、ユニティゲインにおいて安定であり、幅広い負荷条件にわたって優れた動的挙動を示します。

これらのデバイスは完全に独立した回路を使用しているため、オーバードライブまたは過負荷時でも、クロストークが最小限に抑えられ、チャンネル間干渉が発生しません。

OPA166x は、 $-40^\circ\text{C} \sim +85^\circ\text{C}$  で動作が規定されています。

### 製品情報

製品名	チャンネル数	パッケージ (1)
OPA1662	デュアル	D (SOIC, 8)
		DGK (VSSOP, 8)
OPA1664	クワッド	D (SOIC, 14)
		PW (TSSOP, 14)

(1) 詳細については、[セクション 9](#) を参照してください。



## Table of Contents

1 特長.....	1	5.8 Typical Characteristics.....	8
2 アプリケーション.....	1	<b>6 Application and Implementation.....</b>	<b>15</b>
3 概要.....	1	6.1 Application Information.....	15
4 Pin Configurations.....	2	6.2 Typical Application.....	21
5 Specifications.....	3	<b>7 Device and Documentation Support.....</b>	<b>22</b>
5.1 Absolute Maximum Ratings.....	3	7.1 ドキュメントの更新通知を受け取る方法.....	22
5.2 ESD Ratings.....	3	7.2 サポート・リソース.....	22
5.3 Recommended Operating Conditions.....	3	7.3 Trademarks.....	22
5.4 Thermal Information: OPA1662.....	4	7.4 静電気放電に関する注意事項.....	22
5.5 Thermal Information: OPA1664.....	4	7.5 用語集.....	22
5.6 Electrical Characteristics: $V_S = \pm 15V$ .....	5	<b>8 Revision History.....</b>	<b>22</b>
5.7 Electrical Characteristics: $V_S = 5V$ .....	6	<b>9 Mechanical, Packaging, and Orderable Information..</b>	<b>22</b>

## 4 Pin Configurations



図 4-1. OPA1662: D and DGK Packages, SOIC-8 and VSSOP-8 (Top View)



図 4-2. OPA1664: D and PW Packages, SOIC-14 and TSSOP-14 (Top View)

## 5 Specifications

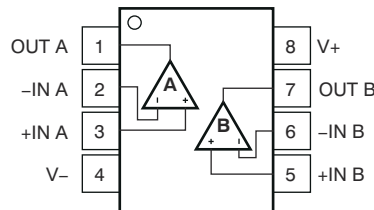
### 5.1 Absolute Maximum Ratings

over operating free-air temperature range (unless otherwise noted).<sup>(1)</sup>

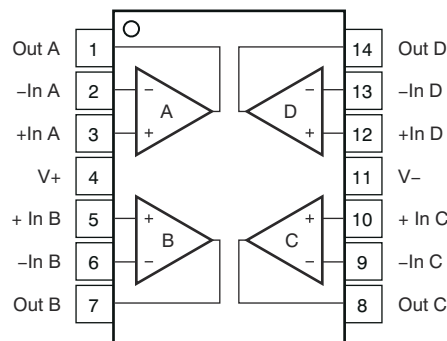
		MIN	MAX	UNIT
V <sub>S</sub>	Supply voltage, V <sub>S</sub> = (V+) – (V–)		40	V
	Input voltage	(V–) – 0.5	(V+) + 0.5	V
	Input current (all pins except power-supply pins)		±10	mA
	Output short-circuit <sup>(2)</sup>	Continuous		
T <sub>A</sub>	Operating temperature	–55	125	°C
T <sub>J</sub>	Junction temperature		150	°C
T <sub>stg</sub>	Storage temperature	–65	150	°C

- (1) Operation outside the *Absolute Maximum Ratings* may cause permanent device damage. *Absolute Maximum Ratings* do not imply functional operation of the device at these or any other conditions beyond those listed under *Recommended Operating Conditions*. If used outside the *Recommended Operating Conditions* but within the *Absolute Maximum Ratings*, the device may not be fully functional, and this may affect device reliability, functionality, performance, and shorten the device lifetime.
- (2) Short-circuit to V<sub>S</sub>/2 (ground in symmetrical dual supply setups), one amplifier per package.

### 5.2 ESD Ratings

			VALUE	UNIT
V <sub>(ESD)</sub>	Electrostatic discharge	Human-body model (HBM), per ANSI/ESDA/JEDEC JS-001 <sup>(1)</sup>	2000	V
		Charged-device model (CDM), per JEDEC specification JESD22-C101 <sup>(2)</sup>	1000	
		Machine model (MM)	200	

- (1) JEDEC document JEP155 states that 500V HBM allows safe manufacturing with a standard ESD control process.
- (2) JEDEC document JEP157 states that 250V CDM allows safe manufacturing with a standard ESD control process.

### 5.3 Recommended Operating Conditions

over operating free-air temperature range (unless otherwise noted)

		MIN	NOM	MAX	UNIT
V <sub>S</sub>	Supply voltage, (V+) – (V–)	±1.5		±18	V
T <sub>A</sub>	Ambient temperature	–40		85	°C

## 5.4 Thermal Information: OPA1662

THERMAL METRIC <sup>(1)</sup>		OPA1662		UNITS
		D (SOIC)	DGK (VSSOP)	
		8 PINS	8 PINS	
$R_{\theta JA}$	Junction-to-ambient thermal resistance	156.3	225.4	°C/W
$R_{\theta JCTop}$	Junction-to-case (top) thermal resistance	85.5	78.8	°C/W
$R_{\theta JB}$	Junction-to-board thermal resistance	64.9	110.5	°C/W
$\Psi_{JT}$	Junction-to-top characterization parameter	33.8	14.6	°C/W
$\Psi_{JB}$	Junction-to-board characterization parameter	64.3	108.5	°C/W
$R_{\theta JCbott}$	Junction-to-case (bottom) thermal resistance	N/A	N/A	°C/W

(1) For information about traditional and new thermal metrics, see the [Semiconductor and IC Package Thermal Metrics application report](#).

## 5.5 Thermal Information: OPA1664

THERMAL METRIC <sup>(1)</sup>		OPA1664		UNITS
		D (SOIC)	PW (TSSOP)	
		14 PINS	14 PINS	
$R_{\theta JA}$	Junction-to-ambient thermal resistance	78.6	125.8	°C/W
$R_{\theta JCTop}$	Junction-to-case (top) thermal resistance	37.0	45.2	°C/W
$R_{\theta JB}$	Junction-to-board thermal resistance	24.9	57.5	°C/W
$\Psi_{JT}$	Junction-to-top characterization parameter	9.7	5.5	°C/W
$\Psi_{JB}$	Junction-to-board characterization parameter	24.6	56.7	°C/W
$R_{\theta JCbott}$	Junction-to-case (bottom) thermal resistance	N/A	N/A	°C/W

(1) For information about traditional and new thermal metrics, see the [Semiconductor and IC Package Thermal Metrics application report](#).

## 5.6 Electrical Characteristics: $V_S = \pm 15V$

at  $T_A = 25^\circ C$  and  $R_L = 2k\Omega$ , and  $V_{CM} = V_{OUT} = \text{mid-supply}$  (unless otherwise noted)

PARAMETER		TEST CONDITIONS		MIN	TYP	MAX	UNIT
<b>AUDIO PERFORMANCE</b>							
THD+N	Total harmonic distortion + noise	$G = +1, f = 1\text{kHz}, V_O = 3V_{RMS}$			0.00006		%
					-124		dB
IMD	Intermodulation distortion	$G = +1, V_O = 3V_{RMS}$	SMPTE/DIN two-tone, 4:1 (60Hz and 7kHz)		0.00004		%
					-128		dB
			DIM 30 (3kHz square wave and 15kHz sine wave)		0.00004		%
					-128		dB
		CCIF twin-tone (19kHz and 20kHz)			0.00004		%
					-128		dB
<b>FREQUENCY RESPONSE</b>							
GBW	Gain-bandwidth product	$G = +1$			22		MHz
SR	Slew rate	$G = -1$			17		V/ $\mu s$
	Full power bandwidth <sup>(1)</sup>	$V_O = 1V_P$			2.7		MHz
	Overload recovery time	$G = -10$			1		$\mu s$
	Channel separation (dual and quad)	$f = 1\text{kHz}$			-120		dB
<b>NOISE</b>							
$e_n$	Input voltage noise	$f = 20\text{Hz to } 20\text{kHz}$			2.8		$\mu V_{PP}$
	Input voltage noise density	$f = 1\text{kHz}$			3.3		nV/ $\sqrt{Hz}$
		$f = 100\text{Hz}$			5		
$i_n$	Input current noise density	$f = 1\text{kHz}$			1		pA/ $\sqrt{Hz}$
		$f = 100\text{Hz}$			2		
<b>OFFSET VOLTAGE</b>							
$V_{OS}$	Input offset voltage	$V_S = \pm 1.5V \text{ to } \pm 18V$			$\pm 0.5$	$\pm 1.5$	mV
		$V_S = \pm 1.5V \text{ to } \pm 18V, T_A = -40^\circ C \text{ to } +85^\circ C^{(2)}$			2	8	$\mu V/^\circ C$
PSRR	Power-supply rejection ratio	$V_S = \pm 1.5V \text{ to } \pm 18V$			1	3	$\mu V/V$
<b>INPUT BIAS CURRENT</b>							
$I_B$	Input bias current	$V_{CM} = 0V$			600	1200	nA
$I_{OS}$	Input offset current	$V_{CM} = 0V$			$\pm 25$	$\pm 100$	nA
<b>INPUT VOLTAGE</b>							
$V_{CM}$	Common-mode voltage			$(V-) + 0.5$		$(V+) - 1$	V
CMRR	Common-mode rejection ratio			106	114		dB
<b>INPUT IMPEDANCE</b>							
	Differential				170    2		k $\Omega$    pF
	Common-mode				600    2.5		M $\Omega$    pF
<b>OPEN-LOOP GAIN</b>							
$A_{OL}$	Open-loop voltage gain	$(V-) + 0.6V \leq V_O \leq (V+) - 0.6V, R_L = 2k\Omega$			106	114	dB
<b>OUTPUT</b>							
$V_{OUT}$	Output voltage	$R_L = 2k\Omega$		$(V-) + 0.6$		$(V+) - 0.6$	V
$I_{OUT}$	Output current			See <a href="#">Typical Characteristics</a>			mA
$Z_O$	Open-loop output impedance			See <a href="#">Typical Characteristics</a>			$\Omega$
$I_{SC}$	Short-circuit current <sup>(3)</sup>				$\pm 50$		mA
$C_{LOAD}$	Capacitive load drive				200		pF
<b>POWER SUPPLY</b>							
$I_Q$	Quiescent current (per channel)	$I_{OUT} = 0A$			1.5	1.8	mA
				$T_A = -40^\circ C \text{ to } +85^\circ C^{(2)}$		2	

(1) Full-power bandwidth =  $SR / (2\pi \times V_P)$ , where SR = slew rate.

(2) Specified by design and characterization.

**OPA1662, OPA1664**

JAJSVW9A – DECEMBER 2011 – REVISED DECEMBER 2024

(3) One channel at a time.

**5.7 Electrical Characteristics:  $V_S = 5V$** 

 at  $T_A = 25^\circ C$  and  $R_L = 2k\Omega$ , and  $V_{CM} = V_{OUT} = \text{mid-supply}$  (unless otherwise noted)

PARAMETER		TEST CONDITIONS		MIN	TYP	MAX	UNIT
<b>AUDIO PERFORMANCE</b>							
THD+N	Total harmonic distortion + noise	$G = +1, f = 1\text{kHz}, V_O = 3V_{RMS}$			0.0001		%
					-120		dB
IMD	Intermodulation distortion	$G = +1, V_O = 3V_{RMS}$	SMPTE/DIN two-tone, 4:1 (60Hz and 7kHz)		0.00004		%
					-128		dB
			DIM 30 (3kHz square wave and 15kHz sine wave)		0.00004		%
					-128		dB
			CCIF twin-tone (19kHz and 20kHz)		0.00004		%
					-128		dB
<b>FREQUENCY RESPONSE</b>							
GBW	Gain-bandwidth product	$G = +1$			20		MHz
SR	Slew rate	$G = -1$			13		V/ $\mu s$
	Full power bandwidth <sup>(1)</sup>	$V_O = 1V_P$			2		MHz
	Overload recovery time	$G = -10$			1		$\mu s$
	Channel separation (dual and quad)	$f = 1\text{kHz}$			-120		dB
<b>NOISE</b>							
$e_n$	Input voltage noise	$f = 20\text{Hz to } 20\text{kHz}$			3.3		$\mu V_{PP}$
	Input voltage noise density	$f = 1\text{kHz}$			3.3		$nV/\sqrt{Hz}$
		$f = 100\text{Hz}$			5		
$i_n$	Input current noise density	$f = 1\text{kHz}$			1		$pA/\sqrt{Hz}$
		$f = 100\text{Hz}$			2		
<b>OFFSET VOLTAGE</b>							
$V_{OS}$	Input offset voltage	$V_S = \pm 1.5V \text{ to } \pm 18V$			$\pm 0.5$	$\pm 1.5$	mV
		$V_S = \pm 1.5V \text{ to } \pm 18V, T_A = -40^\circ C \text{ to } +85^\circ C^{(2)}$			2	8	$\mu V/^\circ C$
PSRR	Power-supply rejection ratio	$V_S = \pm 1.5V \text{ to } \pm 18V$			1	3	$\mu V/V$
<b>INPUT BIAS CURRENT</b>							
$I_B$	Input bias current	$V_{CM} = 0V$			600	1200	nA
$I_{OS}$	Input offset current	$V_{CM} = 0V$			$\pm 25$	$\pm 100$	nA
<b>INPUT VOLTAGE</b>							
$V_{CM}$	Common-mode voltage			$(V-) + 0.5$		$(V+) - 1$	V
CMRR	Common-mode rejection ratio			86	100		dB
<b>INPUT IMPEDANCE</b>							
	Differential				$170 \parallel 2$		$k\Omega \parallel pF$
	Common-mode				$600 \parallel 2.5$		$M\Omega \parallel pF$
<b>OPEN-LOOP GAIN</b>							
$A_{OL}$	Open-loop voltage gain	$(V-) + 0.6V \leq V_O \leq (V+) - 0.6V, R_L = 2k\Omega$			90	100	dB
<b>OUTPUT</b>							
$V_{OUT}$	Output voltage	$R_L = 2k\Omega$		$(V-) + 0.6$		$(V+) - 0.6$	V
$I_{OUT}$	Output current			See <a href="#">Typical Characteristics</a>			mA
$Z_O$	Open-loop output impedance			See <a href="#">Typical Characteristics</a>			$\Omega$
$I_{SC}$	Short-circuit current <sup>(3)</sup>			$\pm 40$			mA
$C_{LOAD}$	Capacitive load drive			200			pF
<b>POWER SUPPLY</b>							
$I_Q$	Quiescent current (per channel)	$I_{OUT} = 0A$			1.4	1.7	mA
				$T_A = -40^\circ C \text{ to } +85^\circ C^{(2)}$		2	

 (1) Full-power bandwidth =  $SR / (2\pi \times V_P)$ , where SR = slew rate.

- (2) Specified by design and characterization.
- (3) One channel at a time.

### 5.8 Typical Characteristics

at  $T_A = +25^\circ\text{C}$ ,  $V_S = \pm 15\text{V}$ , and  $R_L = 2\text{k}\Omega$  (unless otherwise noted)

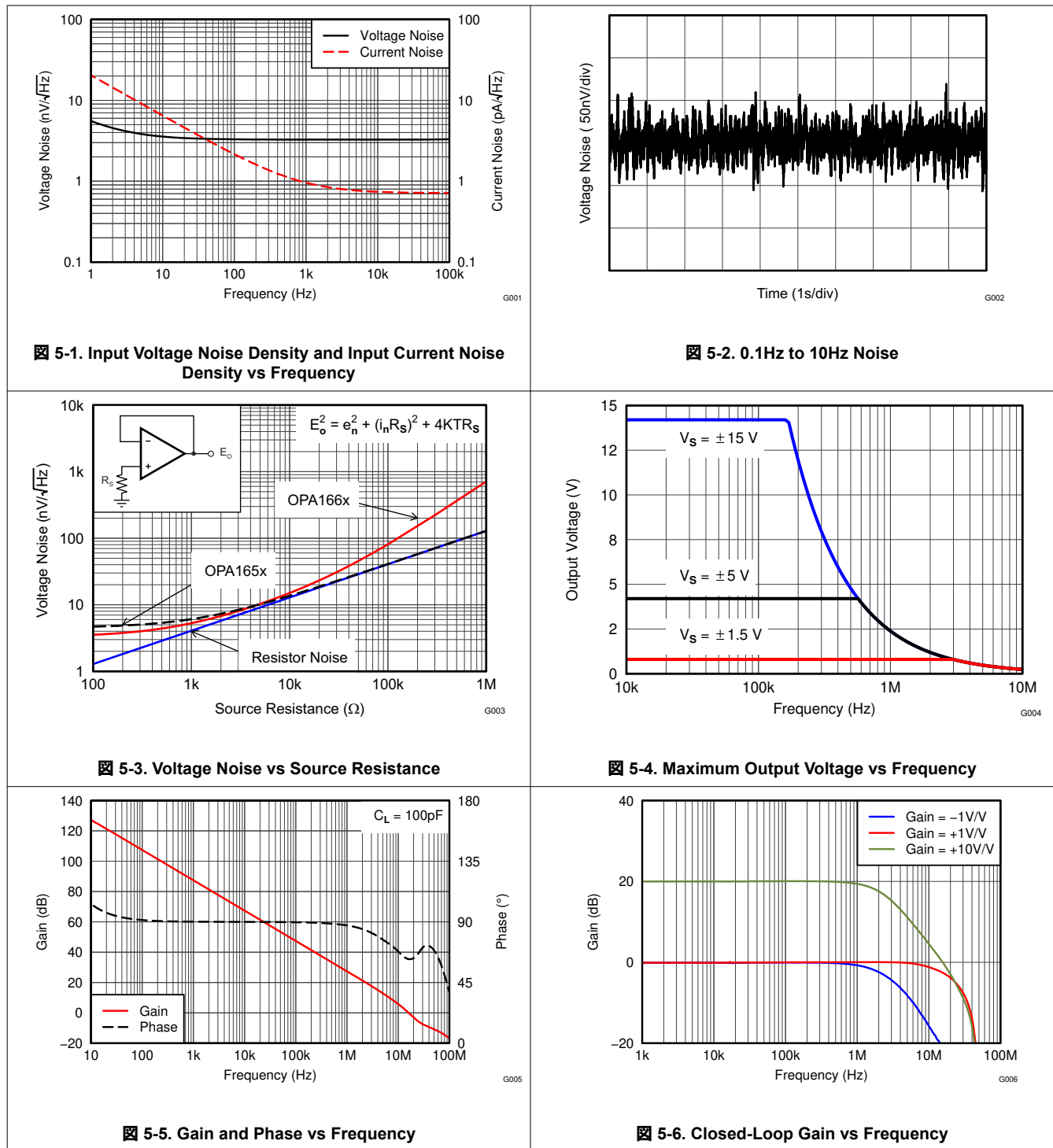

### 5.8 Typical Characteristics (continued)

at  $T_A = +25^\circ\text{C}$ ,  $V_S = \pm 15\text{V}$ , and  $R_L = 2\text{k}\Omega$  (unless otherwise noted)

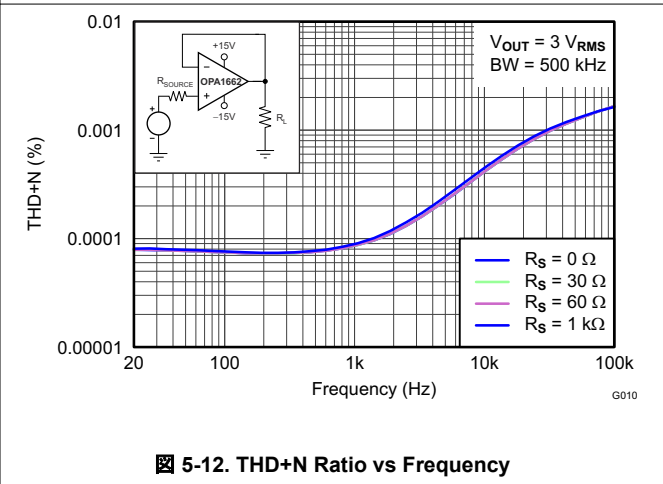
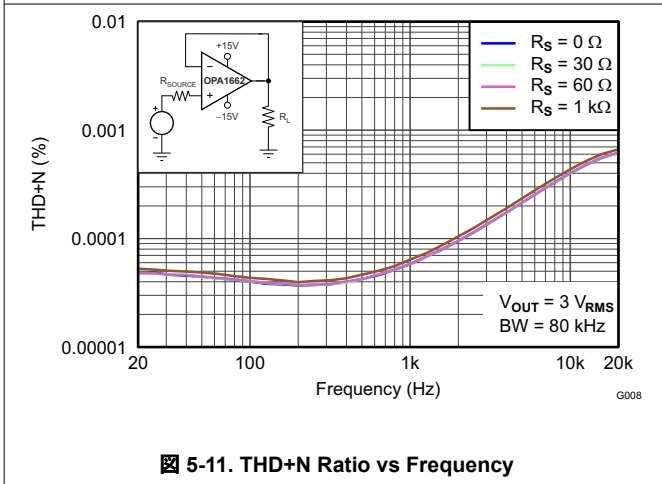
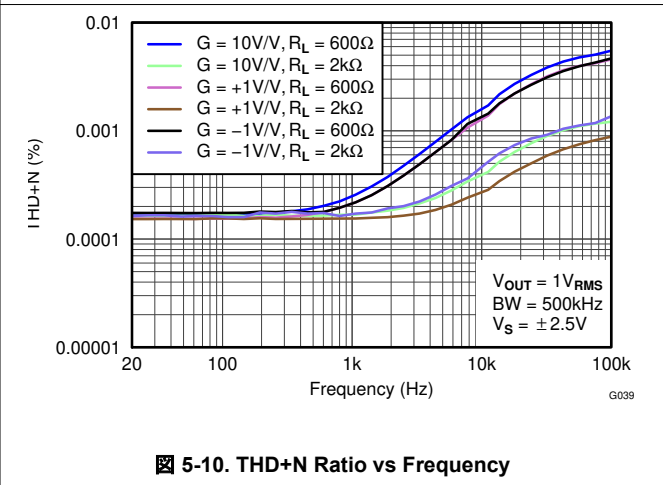
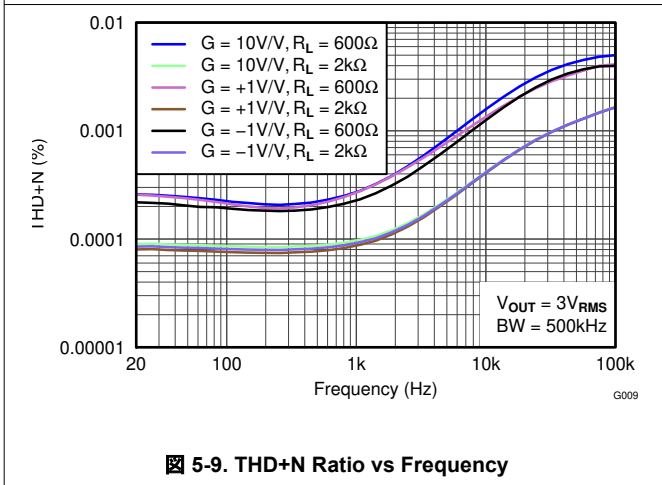
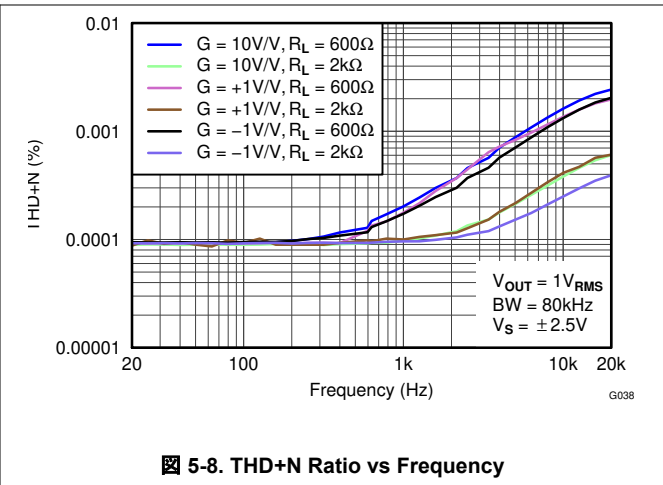
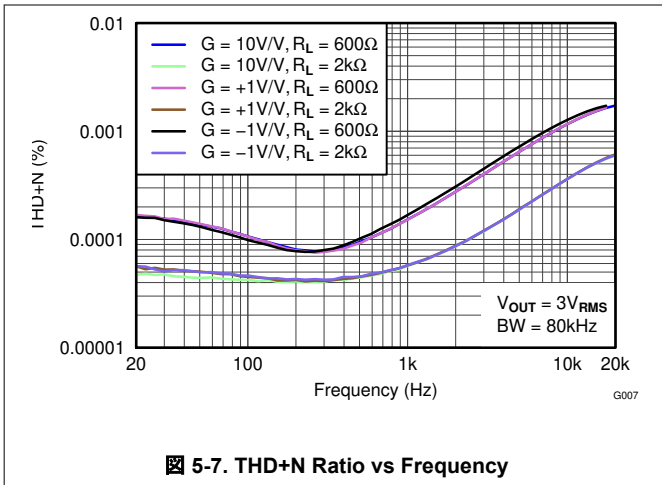

### 5.8 Typical Characteristics (continued)

at  $T_A = +25^\circ\text{C}$ ,  $V_S = \pm 15\text{V}$ , and  $R_L = 2\text{k}\Omega$  (unless otherwise noted)

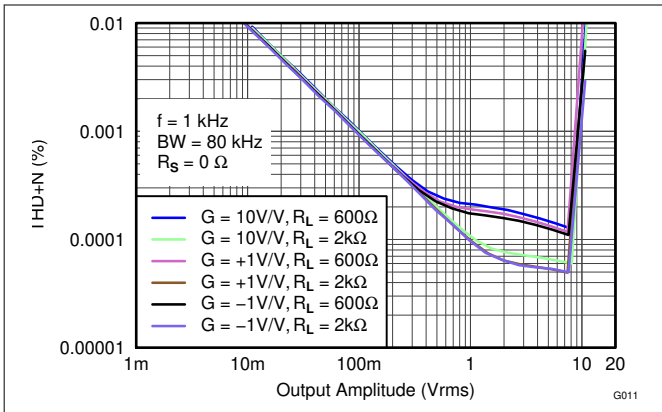

Figure 5-13. THD+N Ratio vs Output Amplitude

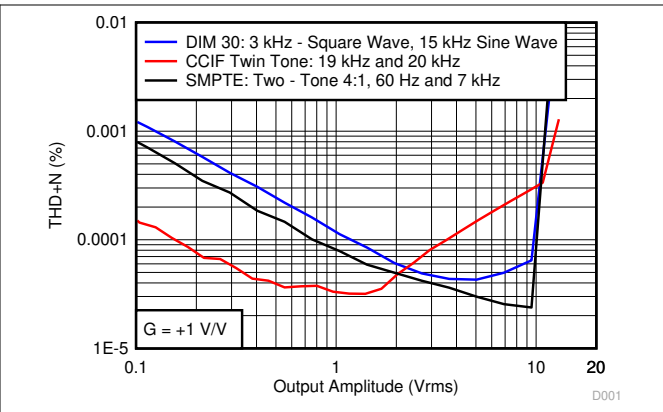

Figure 5-14. Intermodulation Distortion vs Output Amplitude

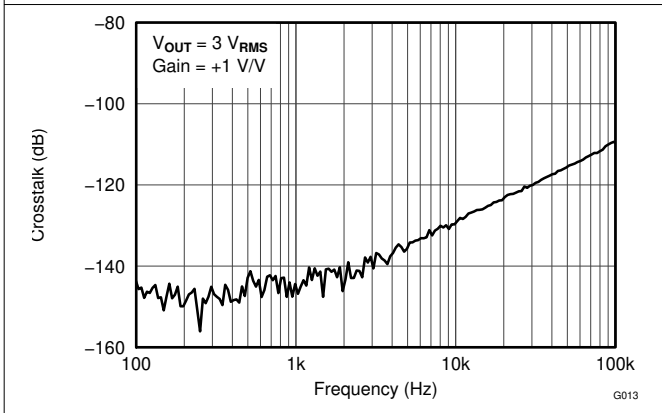

Figure 5-15. Channel Separation vs Frequency

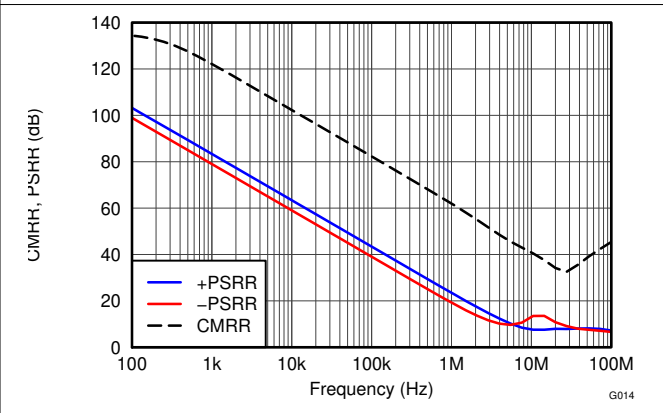

Figure 5-16. CMRR and PSRR vs Frequency (Referred-to-Input)

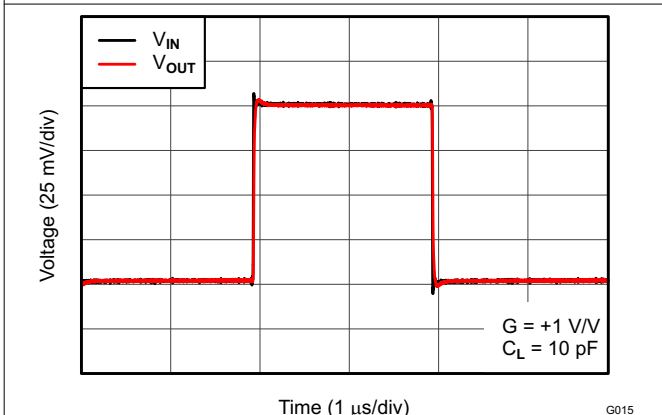

Figure 5-17. Small-Signal Step Response

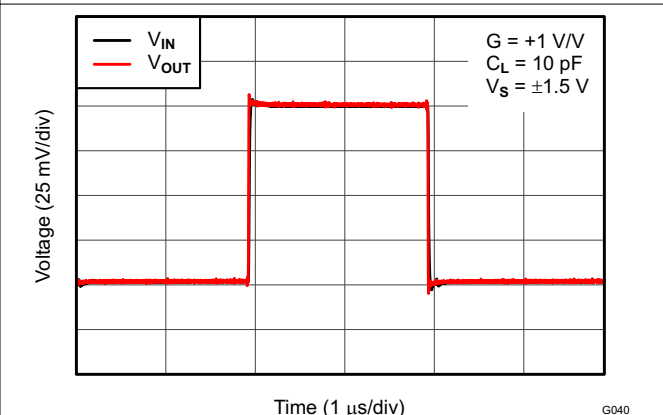
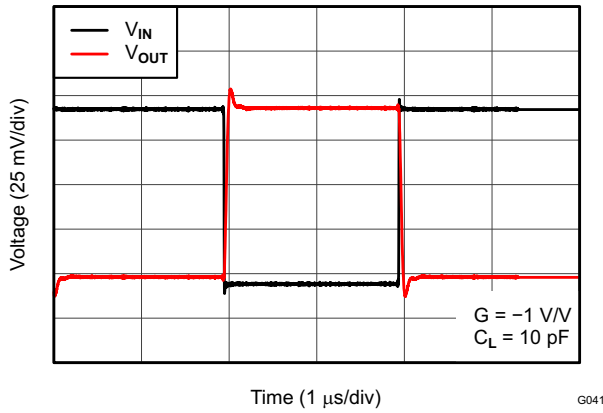

Figure 5-18. Small-Signal Step Response

## 5.8 Typical Characteristics (continued)

at  $T_A = +25^\circ\text{C}$ ,  $V_S = \pm 15\text{V}$ , and  $R_L = 2\text{k}\Omega$  (unless otherwise noted)



5-19. Small-Signal Step Response

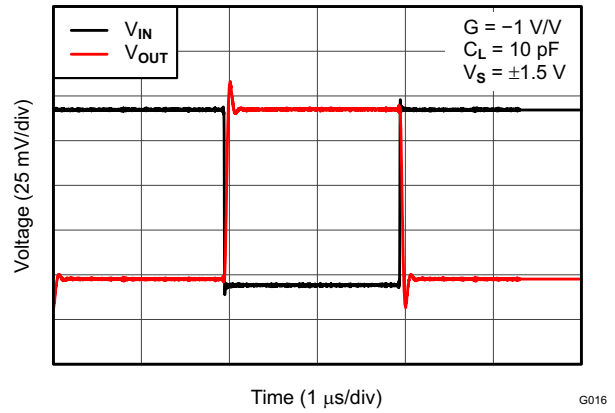

5-20. Small-Signal Step Response

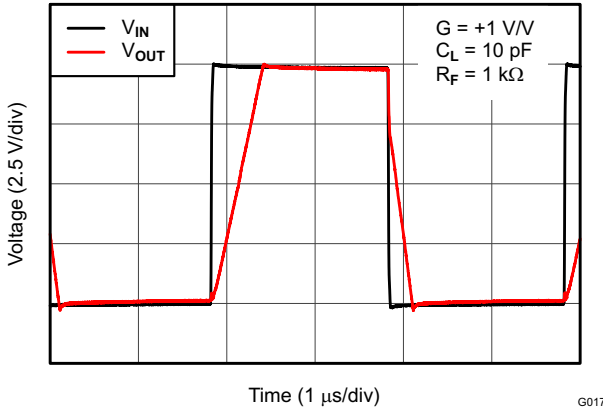

5-21. Large-Signal Step Response

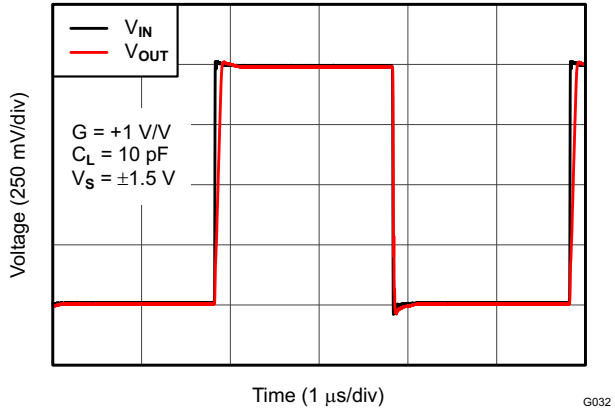

5-22. Large-Signal Step Response

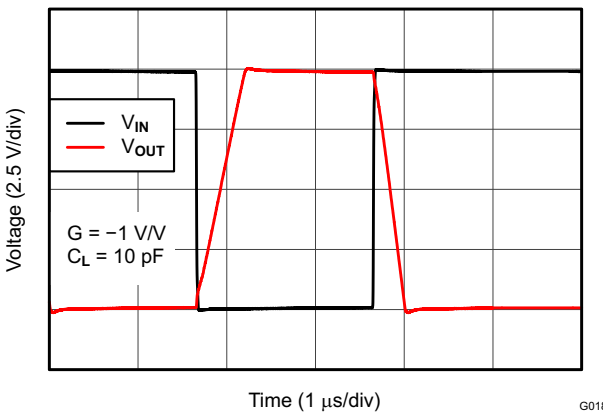

5-23. Large-Signal Step Response

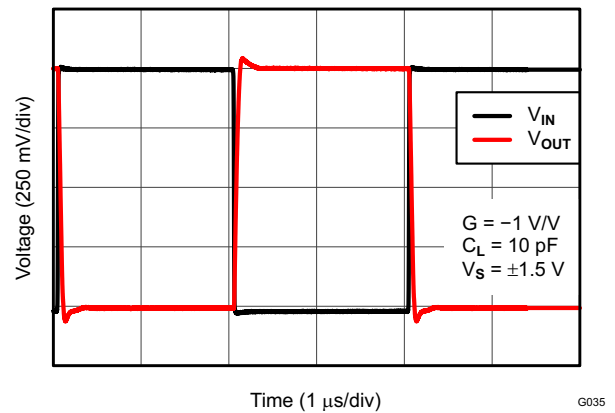

5-24. Large-Signal Step Response

### 5.8 Typical Characteristics (continued)

at  $T_A = +25^\circ\text{C}$ ,  $V_S = \pm 15\text{V}$ , and  $R_L = 2\text{k}\Omega$  (unless otherwise noted)



图 5-25. Small-Signal Overshoot vs Capacitive Load



图 5-26. Small-Signal Overshoot vs Capacitive Load

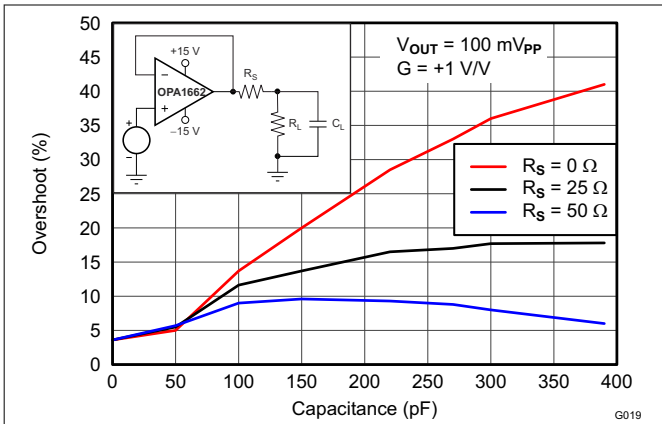

图 5-27. Small-Signal Overshoot vs Capacitive Load

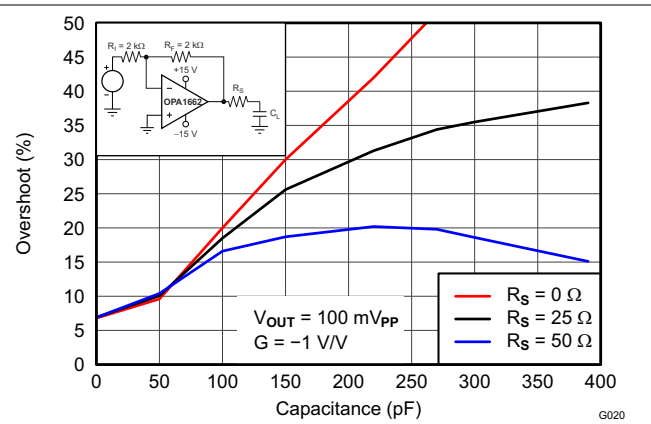

图 5-28. Small-Signal Overshoot vs Capacitive Load

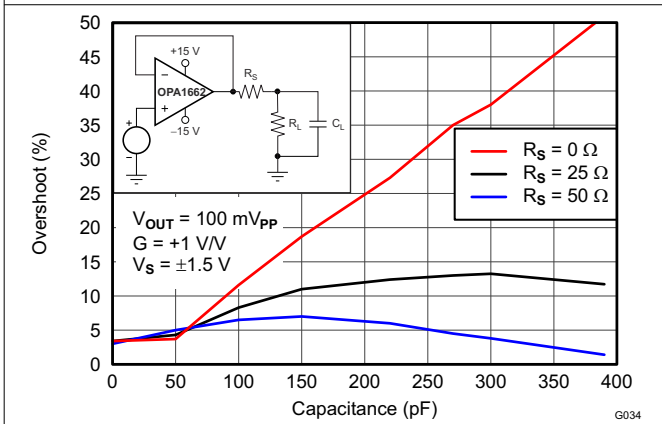

图 5-29. Small-Signal Overshoot vs Feedback Capacitor

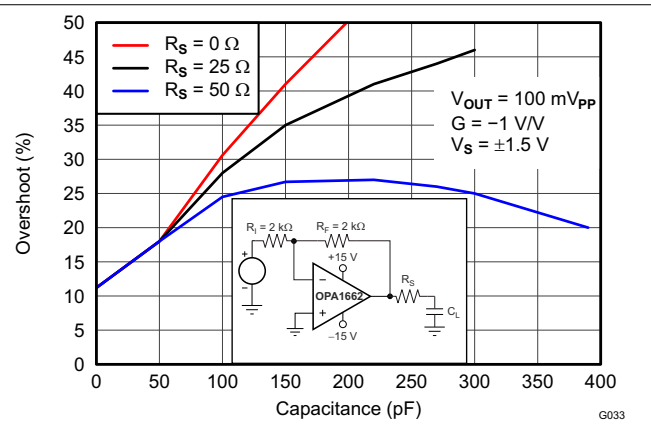

图 5-30. Percent Overshoot vs Capacitive Load

### 5.8 Typical Characteristics (continued)

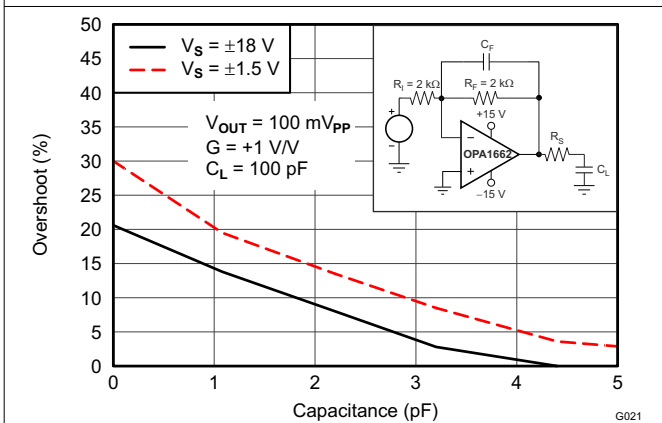
at  $T_A = +25^\circ\text{C}$ ,  $V_S = \pm 15\text{V}$ , and  $R_L = 2\text{k}\Omega$  (unless otherwise noted)

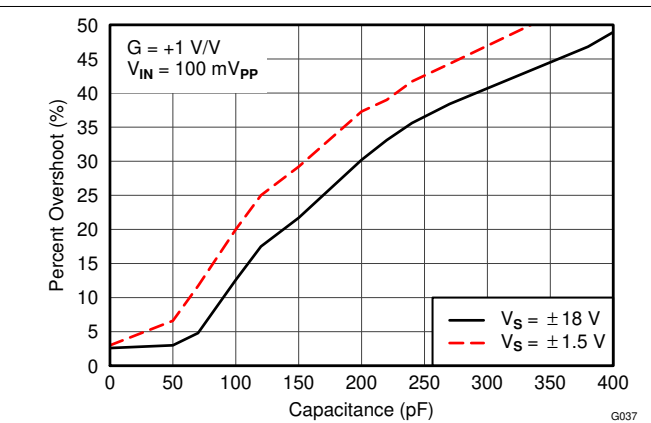

图 5-31. Phase Margin vs Capacitive Load



图 5-32. Open-Loop Gain vs Temperature

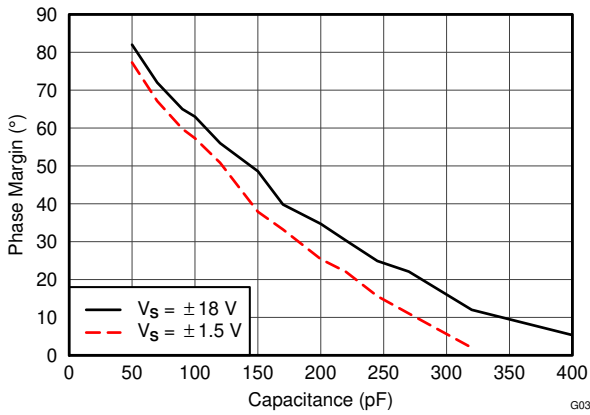

图 5-33.  $I_B$  and  $I_{OS}$  vs Temperature

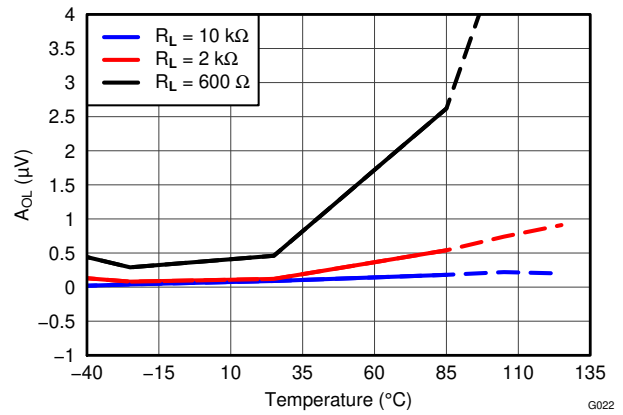

图 5-34.  $I_B$  and  $I_{OS}$  vs Common-Mode Voltage

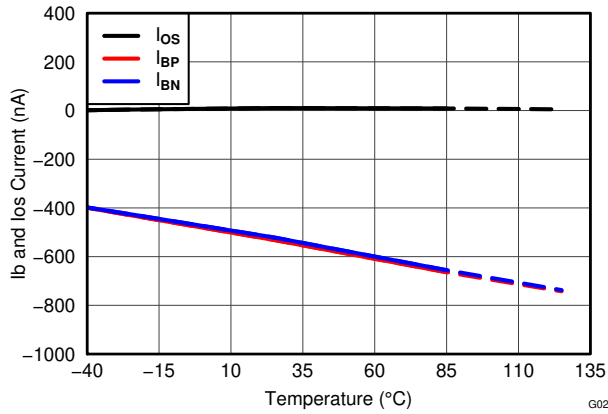

图 5-35. Supply Current vs Temperature

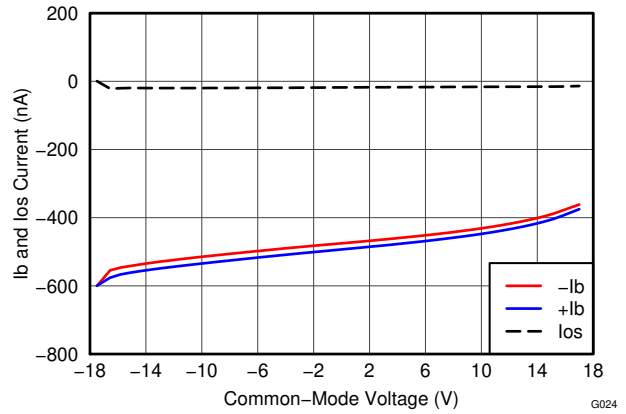

图 5-36. Supply Current vs Supply Voltage

### 5.8 Typical Characteristics (continued)

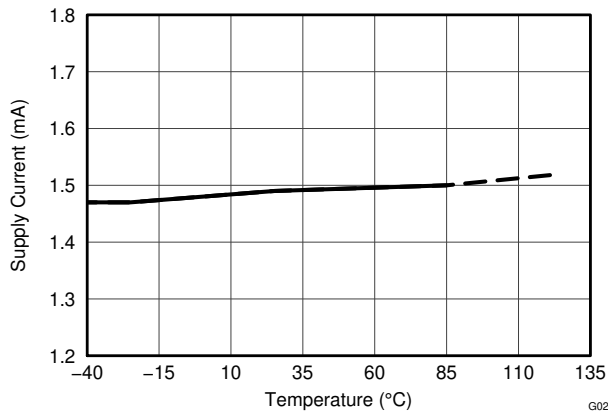
at  $T_A = +25^\circ\text{C}$ ,  $V_S = \pm 15\text{V}$ , and  $R_L = 2\text{k}\Omega$  (unless otherwise noted)

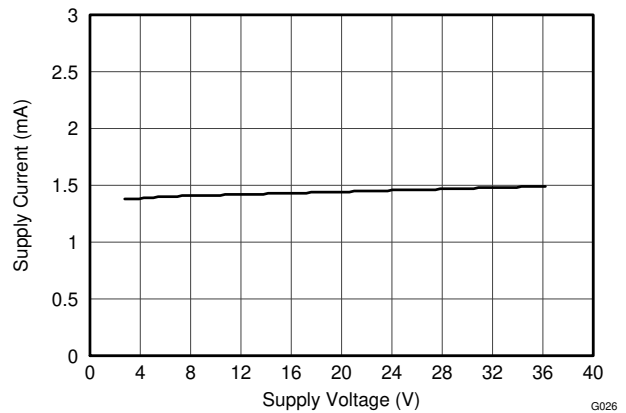
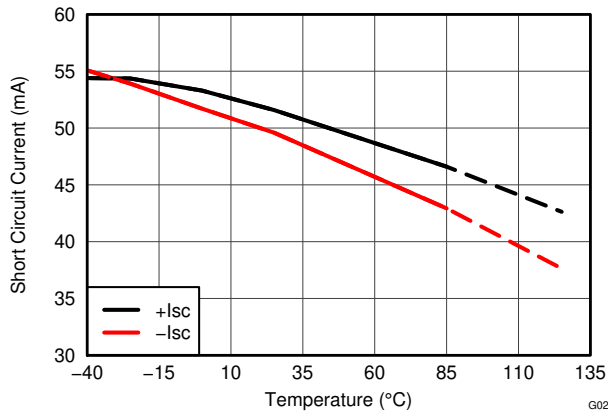

Figure 5-37. Short-Circuit Current vs Temperature

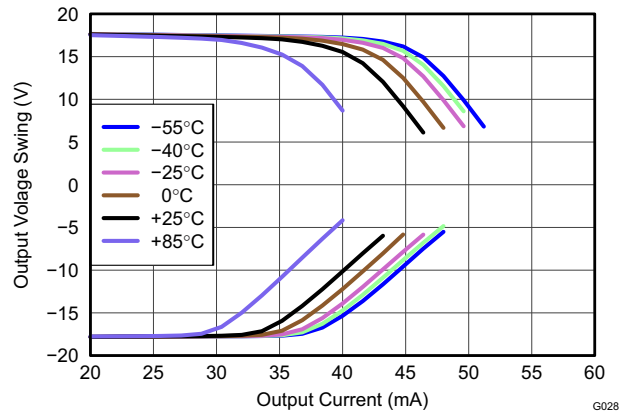

Figure 5-38. Output Voltage vs Output Current

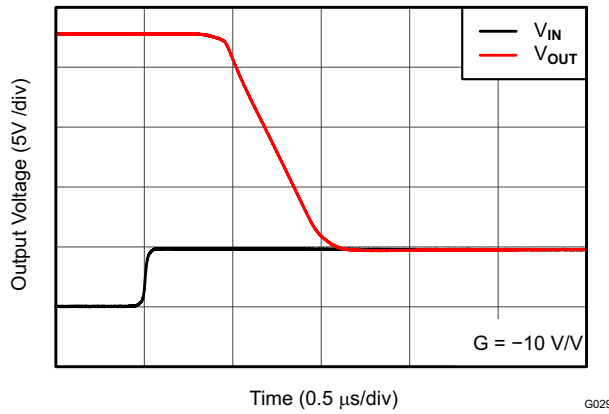

Figure 5-39. Positive Overload Recovery

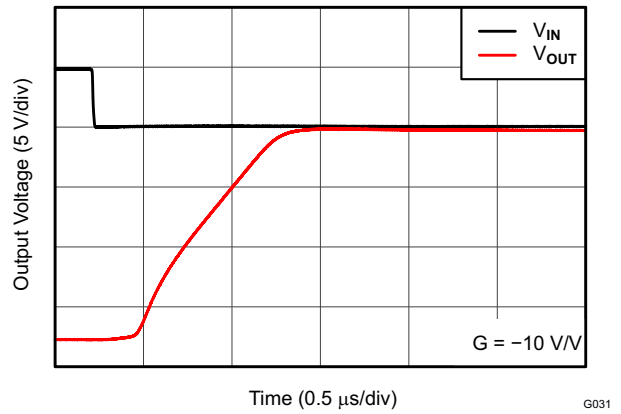

Figure 5-40. Negative Overload Recovery

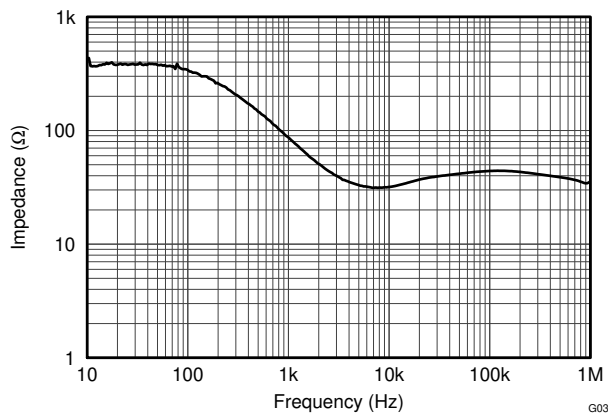

Figure 5-41. Open-Loop Output Impedance vs Frequency

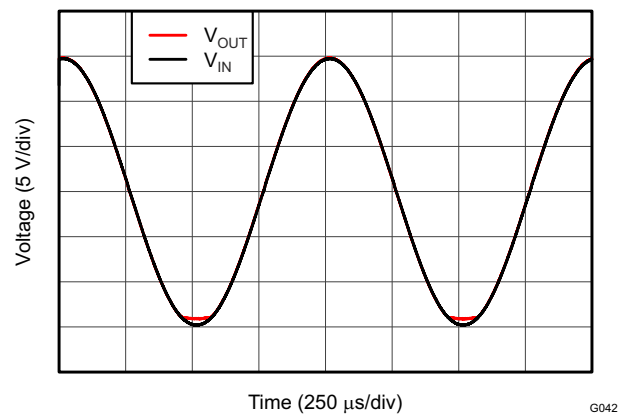

Figure 5-42. No Phase Reversal

## 6 Application and Implementation

### 注

以下のアプリケーション情報は、TI の製品仕様に含まれるものではなく、TI ではその正確性または完全性を保証いたしません。個々の目的に対する製品の適合性については、お客様の責任で判断していただくこととなります。お客様は自身の設計実装を検証しテストすることで、システムの機能を確認する必要があります。

### 6.1 Application Information

The OPA166x are unity-gain stable, precision dual and quad op amps with very low noise. Applications with noisy or high-impedance power supplies require decoupling capacitors close to the device pins. In most cases, 0.1 $\mu$ F capacitors are adequate. 図 6-1 shows a simplified schematic of the OPA166x (one channel shown).

#### 6.1.1 Operating Voltage

The OPA166x series op amps operate from  $\pm 1.5\text{V}$  to  $\pm 18\text{V}$  supplies while maintaining excellent performance. The OPA166x series can operate with as little as 3V between the supplies and with up to 36V between the supplies. However, some applications do not require equal positive and negative output voltage swing. With the OPA166x series, power-supply voltages do not need to be equal. For example, set the positive supply to 25V with the negative supply at  $-5\text{V}$ .

In all cases, the common-mode voltage must be maintained within the specified range. In addition, key parameters are specified over the specified temperature range of  $T_A = -40^\circ\text{C}$  to  $+85^\circ\text{C}$ . Parameters that vary significantly with operating voltage or temperature are shown in the [Typical Characteristics](#).

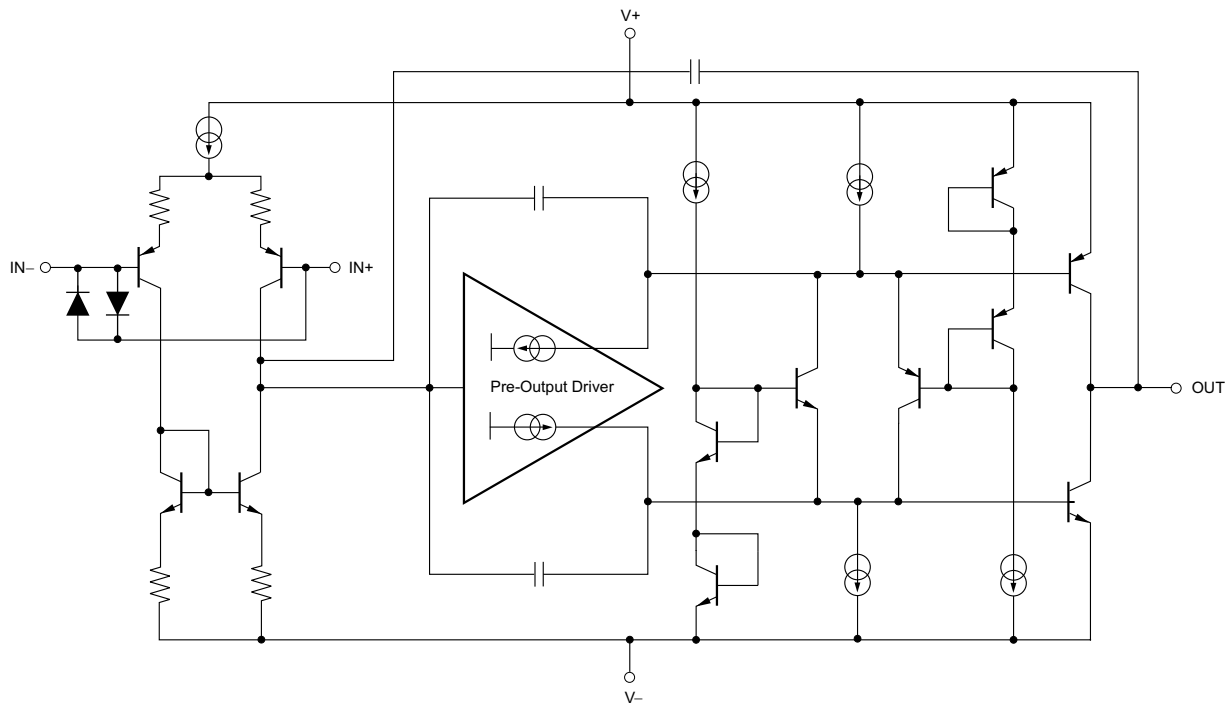

Copyright © 2016, Texas Instruments Incorporated

図 6-1. OPA166x Simplified Schematic

### 6.1.2 Input Protection

The input terminals of the OPA166x are protected from excessive differential voltage with back-to-back diodes, as [Figure 6-2](#) illustrates. In most circuit applications, the input protection circuitry has no consequence. However, in low-gain or  $G = +1$  circuits, fast ramping input signals can forward bias these diodes because the output of the amplifier cannot respond rapidly enough to the input ramp. If the input signal is fast enough to create this forward bias condition, the input signal current must be limited to 10mA or less. If the input signal current is not inherently limited, an input series resistor ( $R_I$ ), a feedback resistor ( $R_F$ ), or both, can be used to limit the signal input current. This resistor degrades the low-noise performance of the OPA166x and is examined in [Section 6.1.3](#). [Figure 6-2](#) shows an example configuration when both current-limiting input and feedback resistors are used.

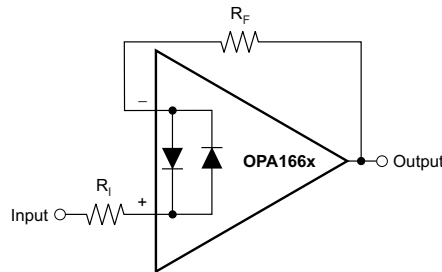

**Figure 6-2. Pulsed Operation**

### 6.1.3 Noise Performance

[Figure 6-3](#) shows the total circuit noise for varying source impedance values with the op amp in a unity-gain configuration (no feedback resistor network, and therefore no additional noise contributions).

The OPA166x (GBW = 22MHz,  $G = +1$ ) is shown with total circuit noise calculated. The op amp contributes both a voltage noise component and a current noise component. The voltage noise is commonly modeled as a time-varying component of the offset voltage. The current noise is modeled as the time-varying component of the input bias current and reacts with the source resistance to create a voltage component of noise. Therefore, the lowest noise op amp for a given application depends on the source impedance. For low source impedance, current noise is negligible, and voltage noise generally dominates. The low voltage noise of the OPA166x series op amps makes them a better choice for low source impedances of less than 1kΩ.

The equation in [Figure 6-3](#) shows the calculation of the total circuit noise, with these parameters:

- $e_n$  = Voltage noise
- $i_n$  = Current noise
- $R_S$  = Source impedance
- $k$  = Boltzmann's constant =  $1.38 \times 10^{-23}$  J/K
- $T$  = Temperature in kelvins (K)

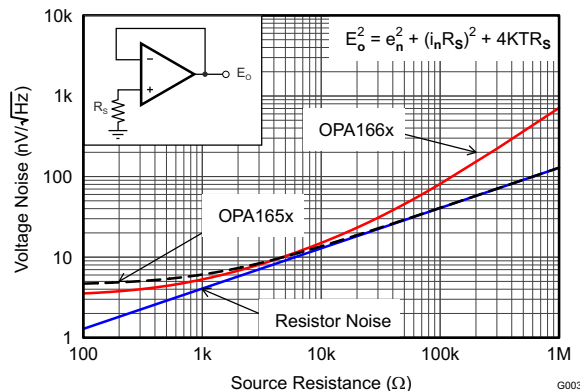
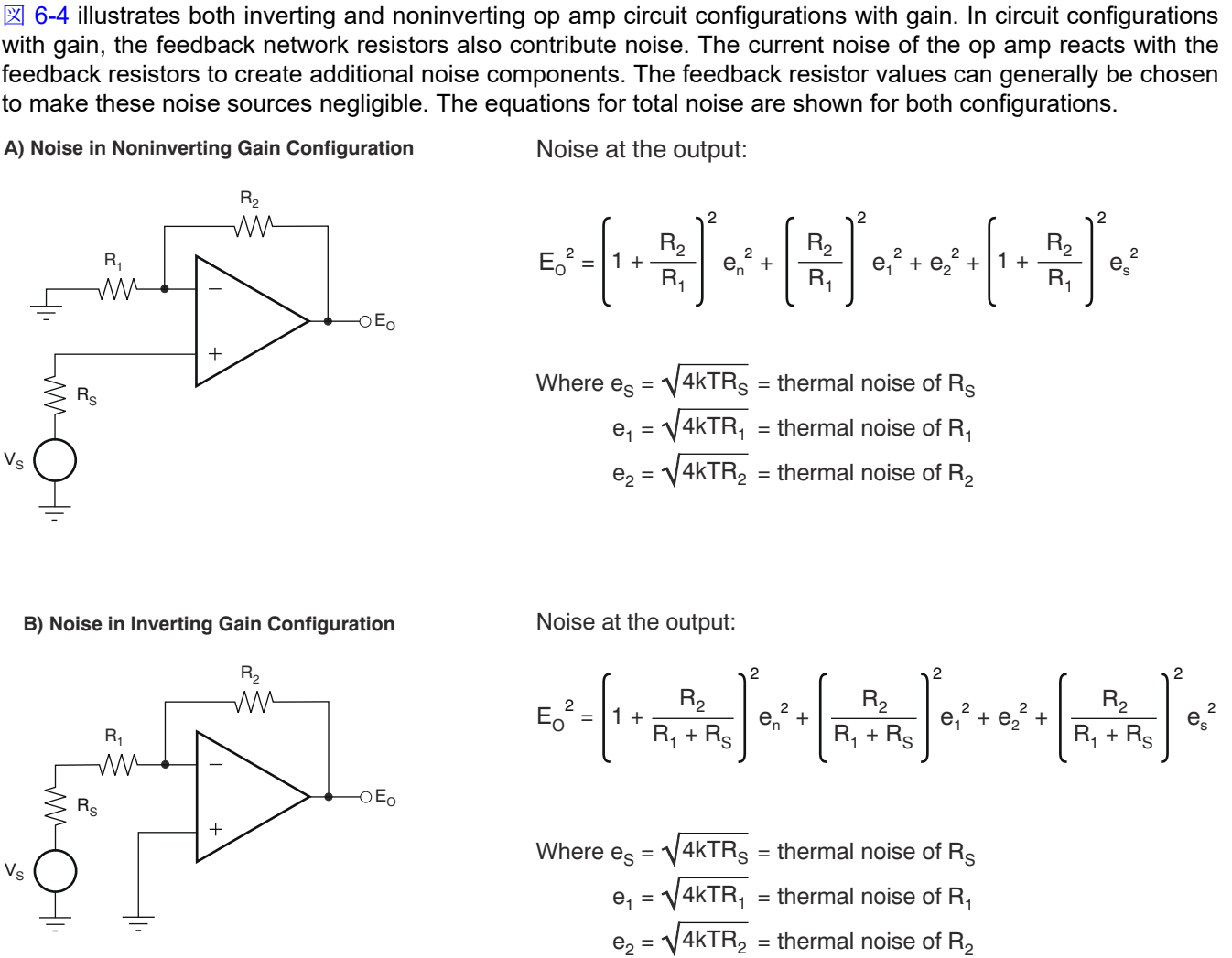

**Figure 6-3. Noise Performance of the OPA166x in Unity-Gain Buffer Configuration**

### 6.1.4 Basic Noise Calculations

Design of low-noise op amp circuits requires careful consideration of a variety of possible noise contributors: noise from the signal source, noise generated in the op amp, and noise from the feedback network resistors. The total noise of the circuit is the root-sum-square combination of all noise components.

The resistive portion of the source impedance produces thermal noise proportional to the square root of the resistance.  6-3 plots this equation. The source impedance is usually fixed; consequently, select the op amp and the feedback resistors to minimize the respective contributions to the total noise.

 6-4 illustrates both inverting and noninverting op amp circuit configurations with gain. In circuit configurations with gain, the feedback network resistors also contribute noise. The current noise of the op amp reacts with the feedback resistors to create additional noise components. The feedback resistor values can generally be chosen to make these noise sources negligible. The equations for total noise are shown for both configurations.

#### A) Noise in Noninverting Gain Configuration

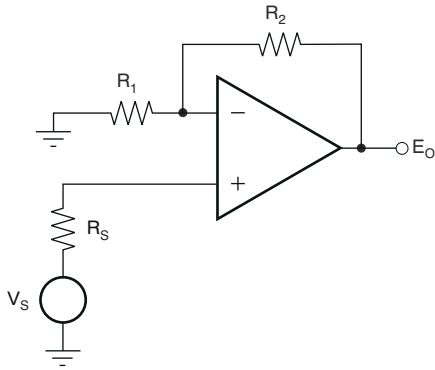

Noise at the output:

$$E_o^2 = \left(1 + \frac{R_2}{R_1}\right)^2 e_n^2 + \left(\frac{R_2}{R_1}\right)^2 e_1^2 + e_2^2 + \left(1 + \frac{R_2}{R_1}\right)^2 e_s^2$$

Where  $e_s = \sqrt{4kTR_s}$  = thermal noise of  $R_s$

$e_1 = \sqrt{4kTR_1}$  = thermal noise of  $R_1$

$e_2 = \sqrt{4kTR_2}$  = thermal noise of  $R_2$

#### B) Noise in Inverting Gain Configuration

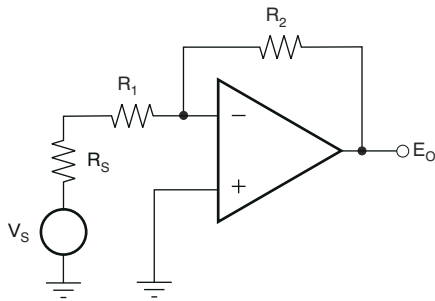

Noise at the output:

$$E_o^2 = \left(1 + \frac{R_2}{R_1 + R_s}\right)^2 e_n^2 + \left(\frac{R_2}{R_1 + R_s}\right)^2 e_1^2 + e_2^2 + \left(\frac{R_2}{R_1 + R_s}\right)^2 e_s^2$$

Where  $e_s = \sqrt{4kTR_s}$  = thermal noise of  $R_s$

$e_1 = \sqrt{4kTR_1}$  = thermal noise of  $R_1$

$e_2 = \sqrt{4kTR_2}$  = thermal noise of  $R_2$

For the OPA166x series of op amps at 1kHz,  $e_n = 3.3\text{nV}/\sqrt{\text{Hz}}$ .

 6-4. Noise Calculation in Gain Configurations

### 6.1.5 Total Harmonic Distortion Measurements

The OPA166x series op amps have excellent distortion characteristics. THD + noise is below 0.0006% ( $G = +1$ ,  $V_O = 3V_{RMS}$ ,  $BW = 80kHz$ ) throughout the audio frequency range, 20Hz to 20kHz, with a 2kΩ load (see [Figure 5-7](#) for characteristic performance).

The distortion produced by the OPA166x series op amps is below the measurement limit of many commercially available distortion analyzers. However, a special test circuit (such as [Figure 6-5](#) shows) can be used to extend the measurement capabilities.

Op amp distortion is considered an internal error source that is referred to the input. [Figure 6-5](#) shows a circuit that causes the op amp distortion to be gained up (refer to the table in [Figure 6-5](#) for the distortion gain factor for various signal gains). The addition of  $R_3$  to the otherwise standard non-inverting amplifier configuration alters the feedback factor or noise gain of the circuit. The closed-loop gain is unchanged, but the feedback available for error correction is reduced by the distortion gain factor, thus extending the resolution by the same amount. Note that the input signal and load applied to the op amp are the same as with conventional feedback without  $R_3$ . The value of  $R_3$  must be kept small to minimize the effect on the distortion measurements.

The validity of this technique can be verified by duplicating measurements at high gain and/or high frequency where the distortion is within the measurement capability of the test equipment. Measurements for this data sheet were made with an Audio Precision System Two distortion/noise analyzer, which greatly simplifies such repetitive measurements. The measurement technique can, however, be performed with manual distortion measurement instruments.

### 6.1.6 Capacitive Loads

The dynamic characteristics of the OPA1662 and OPA1664 have been optimized for commonly encountered gains, loads, and operating conditions. The combination of low closed-loop gain and high capacitive loads decreases the phase margin of the amplifier and can lead to gain peaking or oscillations. As a result, heavier capacitive loads must be isolated from the output. The simplest way to achieve this isolation is to add a small resistor ( $R_S$  equal to 50Ω, for example) in series with the output.

This small series resistor also prevents excess power dissipation if the output of the device becomes shorted. [Figure 5-25](#) illustrates a graph of *Small-Signal Overshoot vs Capacitive Load* for several values of  $R_S$ . Also, refer to [Applications Bulletin AB-028](#) (literature number [SBOA015](#), available for download from the TI web site) for details of analysis techniques and application circuits.

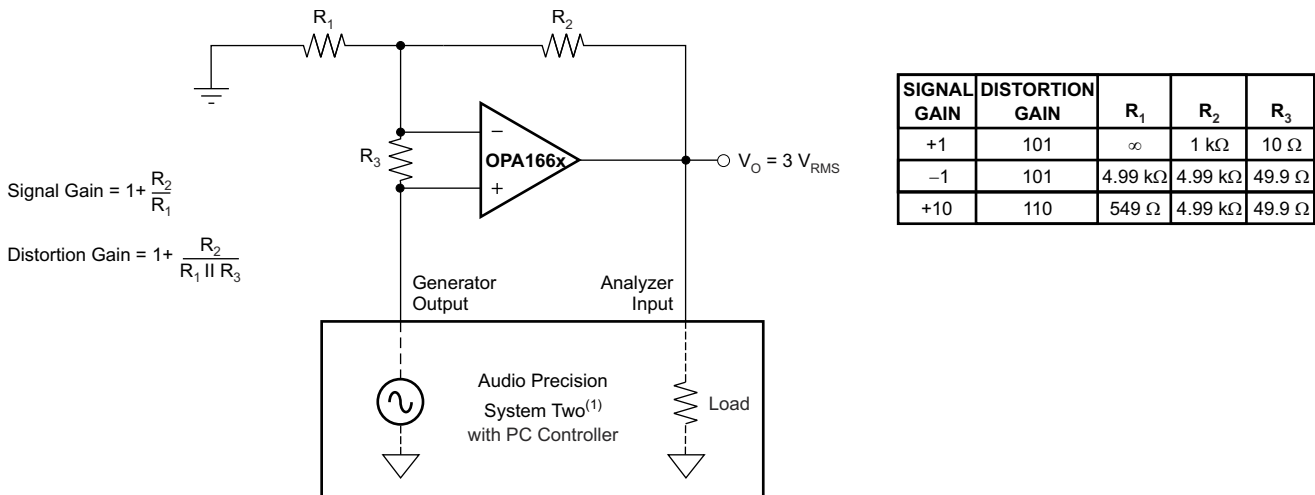

(1) For measurement bandwidth, see [Figure 5-7](#) through [Figure 5-12](#).

**Figure 6-5. Distortion Test Circuit**

### 6.1.7 Power Dissipation

The OPA1662 and OPA1664 series op amps are capable of driving 2k $\Omega$  loads with a power-supply voltage up to  $\pm 18\text{V}$  and full operating temperature range. Internal power dissipation increases when operating at high supply voltages. Copper leadframe construction used in the OPA166x series op amps improves heat dissipation compared to conventional materials. Circuit board layout can also help minimize junction temperature rise. Wide copper traces help dissipate the heat by acting as an additional heat sink. Temperature rise can be further minimized by soldering the devices to the circuit board rather than using a socket.

### 6.1.8 Electrical Overstress

Designers often ask questions about the capability of an operational amplifier to withstand electrical overstress. These questions tend to focus on the device inputs, but can involve the supply voltage pins or even the output pin. Each of these different pin functions have electrical stress limits determined by the voltage breakdown characteristics of the particular semiconductor fabrication process and specific circuits connected to the pin. Additionally, internal electrostatic discharge (ESD) protection is built into these circuits to protect them from accidental ESD events both before and during product assembly.

A good understanding of this basic ESD circuitry and the relevance to an electrical overstress event is important.  6-6 illustrates the ESD circuits contained in the OPA166x (indicated by the dashed line area). The ESD protection circuitry involves several current-steering diodes connected from the input and output pins and routed back to the internal power-supply lines, where the diodes meet at an absorption device internal to the operational amplifier. This protection circuitry is intended to remain inactive during normal circuit operation.

An ESD event produces a short duration, high-voltage pulse that is transformed into a short duration, high-current pulse when discharging through a semiconductor device. The ESD protection circuits are designed to provide a current path around the operational amplifier core to prevent the amplifier from being damaged. The energy absorbed by the protection circuitry is then dissipated as heat.

When an ESD voltage develops across two or more of the amplifier device pins, current flows through one or more of the steering diodes. Depending on the path that the current takes, the absorption device can activate. The absorption device internal to the OPA166x triggers when a fast ESD voltage pulse is impressed across the supply pins. Once triggered, the ESD cell quickly activates, clamping the ESD pulse to a safe voltage level.

When the operational amplifier connects into a circuit such as that illustrated in  6-6, the ESD protection components are intended to remain inactive and not become involved in the application circuit operation. However, circumstances can arise where an applied voltage exceeds the operating voltage range of a given pin. During this condition, there is a risk that some of the internal ESD protection circuits can be biased on, and conduct current. Any such current flow occurs through steering diode paths and rarely involves the absorption device.

 6-6 depicts a specific example where the input voltage,  $V_{\text{IN}}$ , exceeds the positive supply voltage ( $+V_{\text{S}}$ ) by 500mV or more. Much of what happens in the circuit depends on the supply characteristics. If  $+V_{\text{S}}$  can sink the current, one of the upper input steering diodes conducts and directs current to  $+V_{\text{S}}$ . Excessively high current levels can flow with increasingly higher  $V_{\text{IN}}$ . As a result, the data sheet specifications recommend that applications limit the input current to 10mA.

If the supply is not capable of sinking the current,  $V_{\text{IN}}$  can begin sourcing current to the operational amplifier, and then take over as the source of positive supply voltage. The danger in this case is that the voltage can rise to levels that exceed the operational amplifier absolute maximum ratings. In extreme but rare cases, the absorption device triggers on while  $+V_{\text{S}}$  and  $-V_{\text{S}}$  are applied. If this event happens, a direct current path is established between the  $+V_{\text{S}}$  and  $-V_{\text{S}}$  supplies. The power dissipation of the absorption device is quickly exceeded, and the extreme internal heating destroys the operational amplifier.

Another common question involves what happens to the amplifier if an input signal is applied to the input while the power supplies  $+V_{\text{S}}$  and/or  $-V_{\text{S}}$  are at 0V. This also depends on the supply characteristic while at 0V, or at a level below the input signal amplitude. If the supplies appear as high impedance, then the operational amplifier supply current can be supplied by the input source via the current steering diodes. This state is not a normal bias

condition; the amplifier does not operate normally. If the supplies are low impedance, then the current through the steering diodes can become quite high. The current level depends on the ability of the input source to deliver current, and any resistance in the input path.

If there is an uncertainty about the ability of the supply to absorb this current, external zener diodes can be added to the supply pins as shown in 6-6.

The zener voltage must be selected such that the diode does not turn on during normal operation. However, the zener voltage must be low enough so that the zener diode conducts if the supply pin begins to rise above the safe operating supply voltage level.

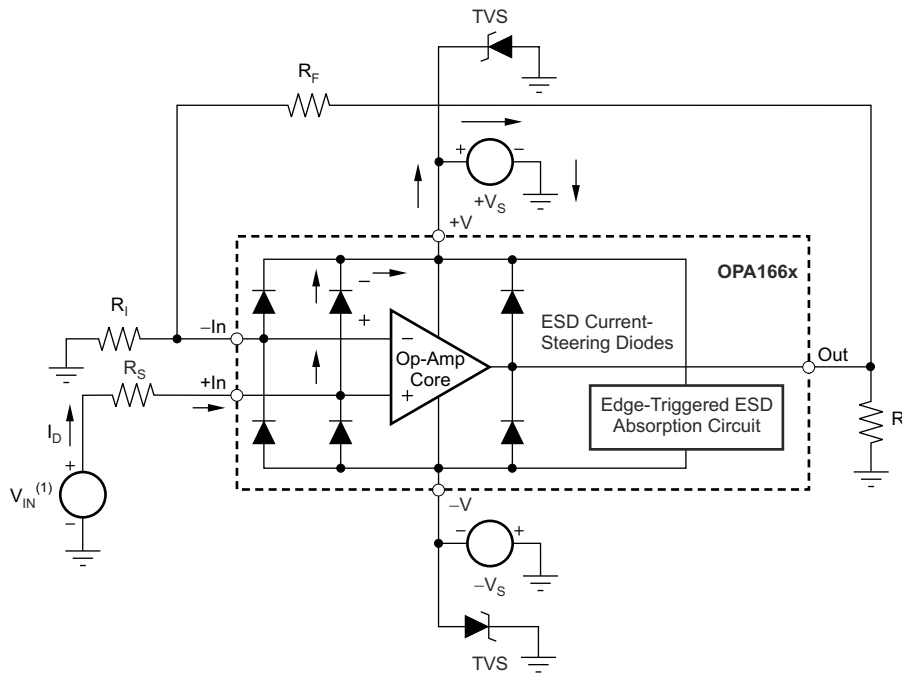

(1)  $V_{IN} = +V_S + 500mV$ .

6-6. Equivalent Internal ESD Circuitry and the Relation to a Typical Circuit Application (Single Channel Shown)

## 6.2 Typical Application

Figure 6-7 shows an additional application idea.

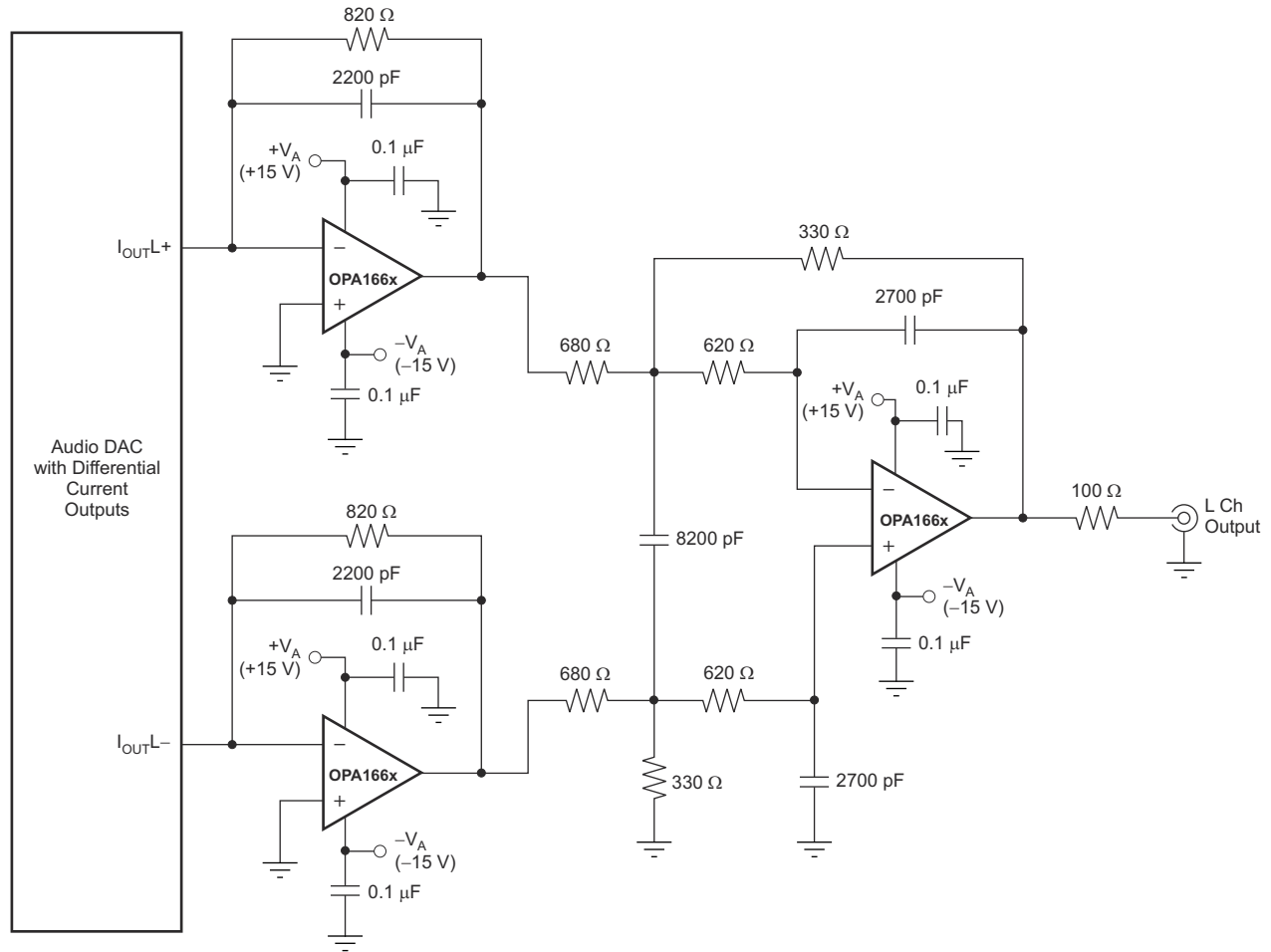

Figure 6-7. Audio DAC I/V Converter and Output Filter

## 7 Device and Documentation Support

TI offers an extensive line of development tools. Tools and software to evaluate the performance of the device, generate code, and develop solutions are listed below.

### 7.1 ドキュメントの更新通知を受け取る方法

ドキュメントの更新についての通知を受け取るには、[www.tij.co.jp](http://www.tij.co.jp) のデバイス製品フォルダを開いてください。[通知] をクリックして登録すると、変更されたすべての製品情報に関するダイジェストを毎週受け取ることができます。変更の詳細については、改訂されたドキュメントに含まれている改訂履歴をご覧ください。

### 7.2 サポート・リソース

テキサス・インスツルメンツ E2E™ サポート・フォーラムは、エンジニアが検証済みの回答と設計に関するヒントをエキスパートから迅速かつ直接得ることができる場所です。既存の回答を検索したり、独自の質問をしたりすることで、設計に必要な支援を迅速に得ることができます。

リンクされているコンテンツは、各寄稿者により「現状のまま」提供されるものです。これらはテキサス・インスツルメンツの仕様を構成するものではなく、必ずしもテキサス・インスツルメンツの見解を反映したものではありません。テキサス・インスツルメンツの[使用条件](#)を参照してください。

### 7.3 Trademarks

Blu-Ray™ is a trademark of Blu-Ray Disc Association.

SoundPlus™ is a trademark of Texas Instruments Incorporated.

テキサス・インスツルメンツ E2E™ is a trademark of Texas Instruments.

すべての商標は、それぞれの所有者に帰属します。

### 7.4 静電気放電に関する注意事項



この IC は、ESD によって破損する可能性があります。テキサス・インスツルメンツは、IC を取り扱う際には常に適切な注意を払うことを推奨します。正しい取り扱いおよび設置手順に従わない場合、デバイスを破損するおそれがあります。

ESD による破損は、わずかな性能低下からデバイスの完全な故障まで多岐にわたります。精密な IC の場合、パラメータがわずかに変化するだけで公表されている仕様から外れる可能性があるため、破損が発生しやすくなっています。

### 7.5 用語集

[テキサス・インスツルメンツ用語集](#) この用語集には、用語や略語の一覧および定義が記載されています。

## 8 Revision History

資料番号末尾の英字は改訂を表しています。その改訂履歴は英語版に準じています。

Changes from Revision * (December 2011) to Revision A (December 2024)	Page
ドキュメント全体にわたって表、図、相互参照の採番方法を更新.....	1
「仕様」、「ESD 定格」、「推奨動作条件」、「アプリケーションと実装」、「代表的なアプリケーション」、「デバイスおよびドキュメントのサポート」、「改訂履歴」、「メカニカル、パッケージ、および注文情報」の各セクションを追加 .....	1
Updated table note 1 in <i>Absolute Maximum Ratings</i> .....	3
Changed junction temperature from 200°C to 150°C in <i>Absolute Maximum Ratings</i> .....	3

## 9 Mechanical, Packaging, and Orderable Information

The following pages include mechanical, packaging, and orderable information. This information is the most current data available for the designated devices. This data is subject to change without notice and revision of this document. For browser-based versions of this data sheet, refer to the left-hand navigation.

**PACKAGING INFORMATION**

Orderable part number	Status (1)	Material type (2)	Package   Pins	Package qty   Carrier	RoHS (3)	Lead finish/ Ball material (4)	MSL rating/ Peak reflow (5)	Op temp (°C)	Part marking (6)
<a href="#">OPA1662AID</a>	Active	Production	SOIC (D)   8	75   TUBE	Yes	NIPDAU	Level-2-260C-1 YEAR	-40 to 85	OP1662
OPA1662AID.B	Active	Production	SOIC (D)   8	75   TUBE	Yes	NIPDAU	Level-2-260C-1 YEAR	-40 to 85	OP1662
<a href="#">OPA1662AIDGK</a>	Active	Production	VSSOP (DGK)   8	80   TUBE	Yes	NIPDAUAG	Level-1-260C-UNLIM	-40 to 85	OUQI
OPA1662AIDGK.B	Active	Production	VSSOP (DGK)   8	80   TUBE	Yes	NIPDAUAG	Level-1-260C-UNLIM	-40 to 85	OUQI
<a href="#">OPA1662AIDGKR</a>	Active	Production	VSSOP (DGK)   8	2500   LARGE T&R	Yes	NIPDAU   NIPDAUAG   SN	Level-1-260C-UNLIM	-40 to 85	OUQI
OPA1662AIDGKR.B	Active	Production	VSSOP (DGK)   8	2500   LARGE T&R	Yes	NIPDAU	Level-1-260C-UNLIM	-40 to 85	OUQI
OPA1662AIDGKRG4	Active	Production	VSSOP (DGK)   8	2500   LARGE T&R	Yes	NIPDAU	Level-1-260C-UNLIM	-40 to 85	OUQI
OPA1662AIDGKRG4.B	Active	Production	VSSOP (DGK)   8	2500   LARGE T&R	Yes	NIPDAU	Level-1-260C-UNLIM	-40 to 85	OUQI
<a href="#">OPA1662AIDR</a>	Active	Production	SOIC (D)   8	2500   LARGE T&R	Yes	NIPDAU	Level-2-260C-1 YEAR	-40 to 85	OP1662
OPA1662AIDR.B	Active	Production	SOIC (D)   8	2500   LARGE T&R	Yes	NIPDAU	Level-2-260C-1 YEAR	-40 to 85	OP1662
OPA1662AIDRG4	Active	Production	SOIC (D)   8	2500   LARGE T&R	Yes	NIPDAU	Level-2-260C-1 YEAR	-40 to 85	OP1662
OPA1662AIDRG4.B	Active	Production	SOIC (D)   8	2500   LARGE T&R	Yes	NIPDAU	Level-2-260C-1 YEAR	-40 to 85	OP1662
<a href="#">OPA1664AID</a>	Active	Production	SOIC (D)   14	50   TUBE	Yes	NIPDAU	Level-2-260C-1 YEAR	-40 to 85	OPA1664
OPA1664AID.B	Active	Production	SOIC (D)   14	50   TUBE	Yes	NIPDAU	Level-2-260C-1 YEAR	-40 to 85	OPA1664
<a href="#">OPA1664AIDR</a>	Active	Production	SOIC (D)   14	2500   LARGE T&R	Yes	NIPDAU	Level-2-260C-1 YEAR	-40 to 85	OPA1664
OPA1664AIDR.B	Active	Production	SOIC (D)   14	2500   LARGE T&R	Yes	NIPDAU	Level-2-260C-1 YEAR	-40 to 85	OPA1664
OPA1664AIDRG4	Active	Production	SOIC (D)   14	2500   LARGE T&R	Yes	NIPDAU	Level-2-260C-1 YEAR	-40 to 85	OPA1664
OPA1664AIDRG4.B	Active	Production	SOIC (D)   14	2500   LARGE T&R	Yes	NIPDAU	Level-2-260C-1 YEAR	-40 to 85	OPA1664
<a href="#">OPA1664AIPW</a>	Active	Production	TSSOP (PW)   14	90   TUBE	Yes	NIPDAU	Level-2-260C-1 YEAR	-40 to 85	OPA1664
OPA1664AIPW.B	Active	Production	TSSOP (PW)   14	90   TUBE	Yes	NIPDAU	Level-2-260C-1 YEAR	-40 to 85	OPA1664
<a href="#">OPA1664AIPWR</a>	Active	Production	TSSOP (PW)   14	2000   LARGE T&R	Yes	NIPDAU	Level-2-260C-1 YEAR	-40 to 85	OPA1664
OPA1664AIPWR.B	Active	Production	TSSOP (PW)   14	2000   LARGE T&R	Yes	NIPDAU	Level-2-260C-1 YEAR	-40 to 85	OPA1664

(1) **Status:** For more details on status, see our [product life cycle](#).

(2) **Material type:** When designated, preproduction parts are prototypes/experimental devices, and are not yet approved or released for full production. Testing and final process, including without limitation quality assurance, reliability performance testing, and/or process qualification, may not yet be complete, and this item is subject to further changes or possible discontinuation. If available for ordering, purchases will be subject to an additional waiver at checkout, and are intended for early internal evaluation purposes only. These items are sold without warranties of any kind.

(3) **RoHS values:** Yes, No, RoHS Exempt. See the [TI RoHS Statement](#) for additional information and value definition.

(4) **Lead finish/Ball material:** Parts may have multiple material finish options. Finish options are separated by a vertical ruled line. Lead finish/Ball material values may wrap to two lines if the finish value exceeds the maximum column width.

(5) **MSL rating/Peak reflow:** The moisture sensitivity level ratings and peak solder (reflow) temperatures. In the event that a part has multiple moisture sensitivity ratings, only the lowest level per JEDEC standards is shown. Refer to the shipping label for the actual reflow temperature that will be used to mount the part to the printed circuit board.

(6) **Part marking:** There may be an additional marking, which relates to the logo, the lot trace code information, or the environmental category of the part.

Multiple part markings will be inside parentheses. Only one part marking contained in parentheses and separated by a "~" will appear on a part. If a line is indented then it is a continuation of the previous line and the two combined represent the entire part marking for that device.

**Important Information and Disclaimer:** The information provided on this page represents TI's knowledge and belief as of the date that it is provided. TI bases its knowledge and belief on information provided by third parties, and makes no representation or warranty as to the accuracy of such information. Efforts are underway to better integrate information from third parties. TI has taken and continues to take reasonable steps to provide representative and accurate information but may not have conducted destructive testing or chemical analysis on incoming materials and chemicals. TI and TI suppliers consider certain information to be proprietary, and thus CAS numbers and other limited information may not be available for release.

In no event shall TI's liability arising out of such information exceed the total purchase price of the TI part(s) at issue in this document sold by TI to Customer on an annual basis.

**OTHER QUALIFIED VERSIONS OF OPA1662 :**

- Automotive : [OPA1662-Q1](#)

NOTE: Qualified Version Definitions:

- Automotive - Q100 devices qualified for high-reliability automotive applications targeting zero defects

**TAPE AND REEL INFORMATION**

**QUADRANT ASSIGNMENTS FOR PIN 1 ORIENTATION IN TAPE**

\*All dimensions are nominal

Device	Package Type	Package Drawing	Pins	SPQ	Reel Diameter (mm)	Reel Width W1 (mm)	A0 (mm)	B0 (mm)	K0 (mm)	P1 (mm)	W (mm)	Pin1 Quadrant
OPA1662AIDGKR	VSSOP	DGK	8	2500	330.0	12.4	5.3	3.4	1.4	8.0	12.0	Q1
OPA1662AIDGKRG4	VSSOP	DGK	8	2500	330.0	12.4	5.3	3.4	1.4	8.0	12.0	Q1
OPA1662AIDR	SOIC	D	8	2500	330.0	12.4	6.4	5.2	2.1	8.0	12.0	Q1
OPA1662AIDRG4	SOIC	D	8	2500	330.0	12.4	6.4	5.2	2.1	8.0	12.0	Q1
OPA1664AIDR	SOIC	D	14	2500	330.0	16.4	6.5	9.0	2.1	8.0	16.0	Q1
OPA1664AIDRG4	SOIC	D	14	2500	330.0	16.4	6.5	9.0	2.1	8.0	16.0	Q1
OPA1664AIPWR	TSSOP	PW	14	2000	330.0	12.4	6.9	5.6	1.6	8.0	12.0	Q1

**TAPE AND REEL BOX DIMENSIONS**

\*All dimensions are nominal

Device	Package Type	Package Drawing	Pins	SPQ	Length (mm)	Width (mm)	Height (mm)
OPA1662AIDGKR	VSSOP	DGK	8	2500	353.0	353.0	32.0
OPA1662AIDGKRG4	VSSOP	DGK	8	2500	353.0	353.0	32.0
OPA1662AIDR	SOIC	D	8	2500	353.0	353.0	32.0
OPA1662AIDRG4	SOIC	D	8	2500	353.0	353.0	32.0
OPA1664AIDR	SOIC	D	14	2500	353.0	353.0	32.0
OPA1664AIDRG4	SOIC	D	14	2500	353.0	353.0	32.0
OPA1664AIPWR	TSSOP	PW	14	2000	353.0	353.0	32.0

**TUBE**

\*All dimensions are nominal

Device	Package Name	Package Type	Pins	SPQ	L (mm)	W (mm)	T (μm)	B (mm)
OPA1662AID	D	SOIC	8	75	506.6	8	3940	4.32
OPA1662AID.B	D	SOIC	8	75	506.6	8	3940	4.32
OPA1662AIDGK	DGK	VSSOP	8	80	274	6.55	500	2.88
OPA1662AIDGK.B	DGK	VSSOP	8	80	274	6.55	500	2.88
OPA1664AID	D	SOIC	14	50	506.6	8	3940	4.32
OPA1664AID.B	D	SOIC	14	50	506.6	8	3940	4.32
OPA1664AIPW	PW	TSSOP	14	90	530	10.2	3600	3.5
OPA1664AIPW.B	PW	TSSOP	14	90	530	10.2	3600	3.5

# DGK0008A



# PACKAGE OUTLINE

VSSOP - 1.1 mm max height

SMALL OUTLINE PACKAGE



4214862/A 04/2023

**NOTES:**

PowerPAD is a trademark of Texas Instruments.

1. All linear dimensions are in millimeters. Any dimensions in parenthesis are for reference only. Dimensioning and tolerancing per ASME Y14.5M.
2. This drawing is subject to change without notice.
3. This dimension does not include mold flash, protrusions, or gate burrs. Mold flash, protrusions, or gate burrs shall not exceed 0.15 mm per side.
4. This dimension does not include interlead flash. Interlead flash shall not exceed 0.25 mm per side.
5. Reference JEDEC registration MO-187.

# EXAMPLE BOARD LAYOUT

DGK0008A

™ VSSOP - 1.1 mm max height

SMALL OUTLINE PACKAGE



LAND PATTERN EXAMPLE  
EXPOSED METAL SHOWN  
SCALE: 15X

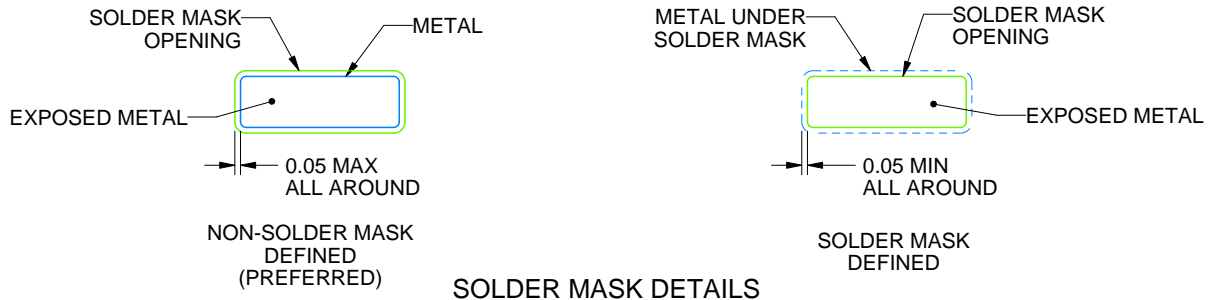

4214862/A 04/2023

NOTES: (continued)

6. Publication IPC-7351 may have alternate designs.
7. Solder mask tolerances between and around signal pads can vary based on board fabrication site.
8. Vias are optional depending on application, refer to device data sheet. If any vias are implemented, refer to their locations shown on this view. It is recommended that vias under paste be filled, plugged or tented.
9. Size of metal pad may vary due to creepage requirement.

# EXAMPLE STENCIL DESIGN

DGK0008A

<sup>TM</sup> VSSOP - 1.1 mm max height

SMALL OUTLINE PACKAGE



SOLDER PASTE EXAMPLE  
SCALE: 15X

4214862/A 04/2023

NOTES: (continued)

11. Laser cutting apertures with trapezoidal walls and rounded corners may offer better paste release. IPC-7525 may have alternate design recommendations.
12. Board assembly site may have different recommendations for stencil design.



# D0014A

# PACKAGE OUTLINE

## SOIC - 1.75 mm max height

SMALL OUTLINE INTEGRATED CIRCUIT



4220718/A 09/2016

### NOTES:

1. All linear dimensions are in millimeters. Dimensions in parenthesis are for reference only. Dimensioning and tolerancing per ASME Y14.5M.
2. This drawing is subject to change without notice.
3. This dimension does not include mold flash, protrusions, or gate burrs. Mold flash, protrusions, or gate burrs shall not exceed 0.15 mm, per side.
4. This dimension does not include interlead flash. Interlead flash shall not exceed 0.43 mm, per side.
5. Reference JEDEC registration MS-012, variation AB.

# EXAMPLE BOARD LAYOUT

D0014A

SOIC - 1.75 mm max height

SMALL OUTLINE INTEGRATED CIRCUIT



LAND PATTERN EXAMPLE  
SCALE:8X



SOLDER MASK DETAILS

4220718/A 09/2016

NOTES: (continued)

- 6. Publication IPC-7351 may have alternate designs.
- 7. Solder mask tolerances between and around signal pads can vary based on board fabrication site.





D0008A

# PACKAGE OUTLINE

SOIC - 1.75 mm max height

SMALL OUTLINE INTEGRATED CIRCUIT



4214825/C 02/2019

### NOTES:

- Linear dimensions are in inches [millimeters]. Dimensions in parenthesis are for reference only. Controlling dimensions are in inches. Dimensioning and tolerancing per ASME Y14.5M.
- This drawing is subject to change without notice.
- This dimension does not include mold flash, protrusions, or gate burrs. Mold flash, protrusions, or gate burrs shall not exceed  $.006$  [0.15] per side.
- This dimension does not include interlead flash.
- Reference JEDEC registration MS-012, variation AA.

# EXAMPLE BOARD LAYOUT

D0008A

SOIC - 1.75 mm max height

SMALL OUTLINE INTEGRATED CIRCUIT



LAND PATTERN EXAMPLE  
 EXPOSED METAL SHOWN  
 SCALE:8X



SOLDER MASK DETAILS

4214825/C 02/2019

NOTES: (continued)

- 6. Publication IPC-7351 may have alternate designs.
- 7. Solder mask tolerances between and around signal pads can vary based on board fabrication site.

# EXAMPLE STENCIL DESIGN

D0008A

SOIC - 1.75 mm max height

SMALL OUTLINE INTEGRATED CIRCUIT



SOLDER PASTE EXAMPLE  
BASED ON .005 INCH [0.125 MM] THICK STENCIL  
SCALE:8X

4214825/C 02/2019

NOTES: (continued)

8. Laser cutting apertures with trapezoidal walls and rounded corners may offer better paste release. IPC-7525 may have alternate design recommendations.
9. Board assembly site may have different recommendations for stencil design.

PW0014A



**PACKAGE OUTLINE**  
**TSSOP - 1.2 mm max height**

SMALL OUTLINE PACKAGE



NOTES:

1. All linear dimensions are in millimeters. Any dimensions in parenthesis are for reference only. Dimensioning and tolerancing per ASME Y14.5M.
2. This drawing is subject to change without notice.
3. This dimension does not include mold flash, protrusions, or gate burrs. Mold flash, protrusions, or gate burrs shall not exceed 0.15 mm per side.
4. This dimension does not include interlead flash. Interlead flash shall not exceed 0.25 mm per side.
5. Reference JEDEC registration MO-153.

# EXAMPLE BOARD LAYOUT

PW0014A

TSSOP - 1.2 mm max height

SMALL OUTLINE PACKAGE



LAND PATTERN EXAMPLE  
EXPOSED METAL SHOWN  
SCALE: 10X



4220202/B 12/2023

NOTES: (continued)

- 6. Publication IPC-7351 may have alternate designs.
- 7. Solder mask tolerances between and around signal pads can vary based on board fabrication site.

# EXAMPLE STENCIL DESIGN

PW0014A

TSSOP - 1.2 mm max height

SMALL OUTLINE PACKAGE



SOLDER PASTE EXAMPLE  
BASED ON 0.125 mm THICK STENCIL  
SCALE: 10X

4220202/B 12/2023

NOTES: (continued)

8. Laser cutting apertures with trapezoidal walls and rounded corners may offer better paste release. IPC-7525 may have alternate design recommendations.
9. Board assembly site may have different recommendations for stencil design.

## 重要なお知らせと免責事項

TI は、技術データと信頼性データ(データシートを含みます)、設計リソース(リファレンス デザインを含みます)、アプリケーションや設計に関する各種アドバイス、Web ツール、安全性情報、その他のリソースを、欠陥が存在する可能性のある「現状のまま」提供しており、商品性および特定目的に対する適合性の黙示保証、第三者の知的財産権の非侵害保証を含むいかなる保証も、明示的または黙示的にかかわらず拒否します。

これらのリソースは、TI 製品を使用する設計の経験を積んだ開発者への提供を意図したものです。(1) お客様のアプリケーションに適した TI 製品の選定、(2) お客様のアプリケーションの設計、検証、試験、(3) お客様のアプリケーションに該当する各種規格や、その他のあらゆる安全性、セキュリティ、規制、または他の要件への確実な適合に関する責任を、お客様のみが単独で負うものとし、

上記の各種リソースは、予告なく変更される可能性があります。これらのリソースは、リソースで説明されている TI 製品を使用するアプリケーションの開発の目的でのみ、TI はその使用をお客様に許諾します。これらのリソースに関して、他の目的で複製することや掲載することは禁止されています。TI や第三者の知的財産権のライセンスが付与されている訳ではありません。お客様は、これらのリソースを自身で使用した結果発生するあらゆる申し立て、損害、費用、損失、責任について、TI およびその代理人を完全に補償するものとし、TI は一切の責任を拒否します。

TI の製品は、[TI の販売条件](#)、[TI の総合的な品質ガイドライン](#)、[ti.com](#) または TI 製品などに関連して提供される他の適用条件に従い提供されます。TI がこれらのリソースを提供することは、適用される TI の保証または他の保証の放棄の拡大や変更を意味するものではありません。TI がカスタム、またはカスタマー仕様として明示的に指定していない限り、TI の製品は標準的なカタログに掲載される汎用機器です。

お客様がいかなる追加条項または代替条項を提案する場合も、TI はそれらに異議を唱え、拒否します。

Copyright © 2026, Texas Instruments Incorporated

最終更新日 : 2025 年 10 月