

OPAx210 2.2nV/√Hz、高精度、低消費電力 36V オペアンプ

1 特長

- 高精度のスーパーベータ入力性能:
 - 低オフセット電圧: 5μV (標準値)
 - 非常に低いドリフト: 0.1μV/°C (標準値)
 - 低入力バイアス電流: 0.3nA (標準値)
- 超低ノイズ:
 - 0.1Hz~10Hz のノイズ: 90μV_{pp}
 - 低い電圧ノイズ: 1kHz 時に 2.2nV/√Hz
- 高い CMRR: 132 dB (最小値)
- ゲイン帯域幅積: 18MHz
- スルーレート: 6.4 V/μs
- 低い静止電流: 2.5mA/ チャンネル (最大値)
- 短絡電流: ±65mA
- 広い電源電圧範囲: ±2.25V~±18V
- 位相反転なし
- レール・ツー・レール出力
- 業界標準パッケージ

2 アプリケーション

- 超音波スキャナ
- マルチパラメータ・メディカル・モニタ
- 商用ネットワークとサーバーの PSU (電源)
- 半導体テスト
- スペクトル・アナライザ
- 実験室およびフィールド計測
- データ・アキュイジション (DAQ)
- 業務用マイク/ワイヤレス・システム

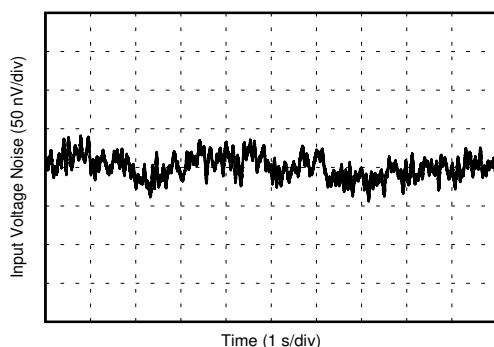

OPAx210 0.1Hz~10Hz のノイズ

3 概要

OPA210 および OPA2210 (OPAx210) は次世代の OPAx209 オペアンプです。OPAx210 高精度オペアンプは、TI の高精度スーパーベータ相補型バイポーラ半導体プロセスで製造され、非常に低いフリッカ・ノイズ、低いオフセット電圧、低いオフセット電圧温度ドリフトを実現しています。

OPAx210 は非常に低い電圧ノイズ密度 (2.2nV/√Hz) を実現し、消費電流はアンプごとにわずか 2.5 mA (最大値) です。また、レール・ツー・レールの出力シングが可能なため、ダイナミック・レンジを最大限に拡大できます。

高精度データ収集アプリケーションでは、OPAx210 は 10V の出力シングでも、16 ビット精度へ高速にセトリングできます。優れた AC 性能と小さなオフセット (全温度範囲で最大 35μV) と小さなドリフト (全温度範囲で最大 0.6μV/°C) を兼ね備える OPAx210 は、高速高精度アプリケーションに非常に適しています。

OPAx210 は ±2.25V~±18V のデュアル電源、または 4.5V~36V のシングル電源という広い電圧範囲と、-40°C~+125°C の温度範囲で動作が規定されています。

製品情報

部品番号	パッケージ ⁽¹⁾	本体サイズ (公称)
OPA210	SOIC (8)	2.90mm×1.60mm
	SOT-23 (5)	2.90mm × 1.60mm
	VSSOP (8)	3.00mm × 3.00mm
OPA2210	SOIC (8)	4.90mm × 3.91mm
	VSSOP (8)	3.00mm × 3.00mm
	WSOP (8)	3.00mm × 3.00mm

- (1) 提供されているすべてのパッケージについては、データシートの末尾にあるパッケージ・オプションについての付録を参照してください。

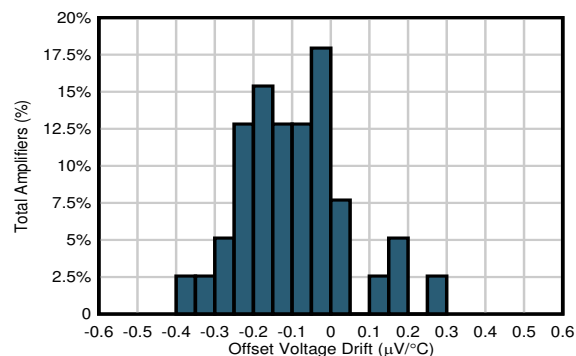

OPAx210 オフセット電圧ドリフトの分布



Table of Contents

1 特長	1	8 Application and Implementation	19
2 アプリケーション	1	8.1 Application Information.....	19
3 概要	1	8.2 Typical Application.....	21
4 Revision History	2	8.3 System Example.....	22
5 Pin Configuration and Functions	3	9 Power Supply Recommendations	23
6 Specifications	4	10 Layout	23
6.1 Absolute Maximum Ratings	4	10.1 Layout Guidelines.....	23
6.2 ESD Ratings	4	10.2 Layout Example.....	23
6.3 Recommended Operating Conditions	4	11 Device and Documentation Support	24
6.4 Thermal Information: OPA210	5	11.1 Device Support.....	24
6.5 Thermal Information: OPA2210	5	11.2 Documentation Support.....	25
6.6 Electrical Characteristics	6	11.3 Receiving Notification of Documentation Updates..	25
6.7 Typical Characteristics.....	8	11.4 サポート・リソース.....	25
7 Detailed Description	15	11.5 Trademarks.....	25
7.1 Overview.....	15	11.6 Electrostatic Discharge Caution.....	25
7.2 Functional Block Diagram.....	15	11.7 Glossary.....	25
7.3 Feature Description.....	16	12 Mechanical, Packaging, and Orderable Information	25
7.4 Device Functional Modes.....	18		

4 Revision History

資料番号末尾の英字は改訂を表しています。その改訂履歴は英語版に準じています。

Changes from Revision G (April 2021) to Revision H (August 2021)	Page
• OPA210 DBV (SOT-23-5) および DGK (VSSOP-8) パッケージを事前情報 (プレビュー) から量産データ (アクティブ)に変更.....	1
<hr/>	
Changes from Revision F (January 2021) to Revision G (April 2021)	Page
• OPA210 D (SOIC-8) パッケージを事前情報 (プレビュー) から量産データ (アクティブ) に変更.....	1
• OPA210 DBV (SOT-23-5) パッケージを事前情報 (プレビュー) として追加.....	1
<hr/>	
Changes from Revision E (November 2020) to Revision F (January 2021)	Page
• OPA210 デバイスの D および DGK パッケージを事前情報 (プレビュー) として追加.....	1
<hr/>	
Changes from Revision D (January 2020) to Revision E (November 2020)	Page
• OPA2210 DRG パッケージを事前情報 (プレビュー) から量産データ (アクティブ) に変更.....	1
<hr/>	
Changes from Revision C (September 2019) to Revision D (January 2020)	Page
• OPA2210 DRG パッケージを事前情報 (プレビュー) としてデータシートに追加.....	1
<hr/>	
Changes from Revision B (March 2019) to Revision C (September 2019)	Page
• 検索を容易にするために super-β をスーパーベータに変更.....	1
• SOIC パッケージを追加.....	1
<hr/>	
Changes from Revision A (December 2018) to Revision B (February 2019)	Page
• Changed "OPAx145" to "OPA2210".....	19
• Fixed link to TIDA-01427	22
<hr/>	
Changes from Revision * (September 2018) to Revision A (December 2018)	Page
• 量産データのデータシートの初版.....	1

5 Pin Configuration and Functions



图 5-1. OPA210: D (8-Pin SOIC) and DGK (8-Pin VSSOP) Packages, Top View



图 5-2. OPA210: DBV (5-Pin SOT-23) Package, Top View

表 5-1. Pin Functions: OPA210

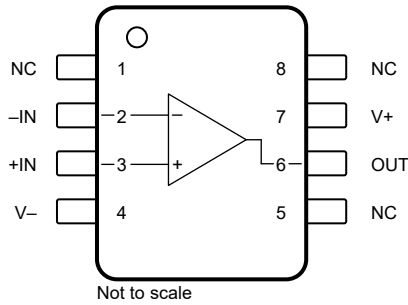
NAME	PIN		I/O	DESCRIPTION
	SOIC, VSSOP	SOT-23		
-IN	2	4	I	Inverting input
+IN	3	3	I	Noninverting input
NC	1, 5, 8	—	—	No internal connection
OUT	6	1	O	Output
V-	4	2	—	Negative (lowest) power supply
V+	7	5	—	Positive (highest) power supply

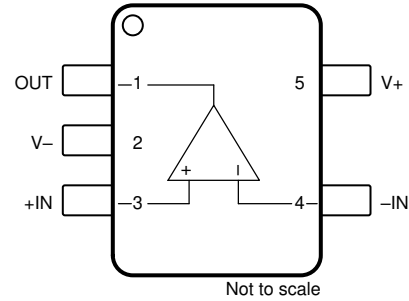

图 5-3. OPA2210: D (SOIC-8), DGK (VSSOP-8), and DRG (WSON-8) Packages, Top View

表 5-2. Pin Functions: OPA2210

NAME	PIN		I/O	DESCRIPTION
	NO.			
-IN A	2		I	Inverting input, channel A
+IN A	3		I	Noninverting input, channel A
-IN B	6		I	Inverting input, channel B
+IN B	5		I	Noninverting input, channel B
OUT A	1		O	Output, channel A
OUT B	7		O	Output, channel B
V-	4		—	Negative (lowest) power supply
V+	8		—	Positive (highest) power supply

6 Specifications

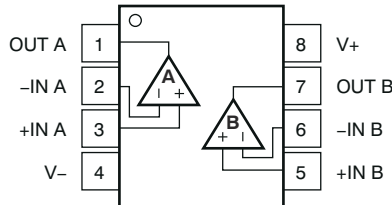
6.1 Absolute Maximum Ratings

over operating free-air temperature range (unless otherwise noted)⁽¹⁾

		MIN	MAX	UNIT
Voltage	Supply voltage, $V_S = (V+) - (V-)$		40	V
	Signal input pins ⁽²⁾	$(V-) - 0.5$	$(V+) + 0.5$	
	Signal input pins Differential		1	
Current	Signal input pins ⁽²⁾	-10	10	mA
	Output short circuit ⁽³⁾	Continuous		
Temperature	Junction, T_J		150	°C
	Storage temperature, T_{stg}	-65	150	

- (1) Stresses beyond those listed under *Absolute Maximum Ratings* may cause permanent damage to the device. These are stress ratings only, which do not imply functional operation of the device at these or any other conditions beyond those indicated under *Recommended Operating Conditions*. Exposure to absolute-maximum-rated conditions for extended periods may affect device reliability.
- (2) For input voltages beyond the power-supply rails, voltage current must be limited.
- (3) Short circuit to ground, one amplifier per package.

6.2 ESD Ratings

			VALUE	UNIT
$V_{(ESD)}$	Electrostatic discharge	Human-body model (HBM), per ANSI/ESDA/JEDEC JS-001 ⁽¹⁾	±4000	V
		Charged-device model (CDM), per JEDEC specification JESD22-C101 ⁽²⁾	±1500	

- (1) JEDEC document JEP155 states that 500-V HBM allows safe manufacturing with a standard ESD control process.
- (2) JEDEC document JEP157 states that 250-V CDM allows safe manufacturing with a standard ESD control process.

6.3 Recommended Operating Conditions

over operating free-air temperature range (unless otherwise noted)

	MIN	MAX	UNIT
Specified voltage, V_S	±2.25	±18	V
Specified temperature	-40	125	°C
Operating temperature, T_A	-55	150	°C

6.4 Thermal Information: OPA210

THERMAL METRIC ⁽¹⁾		OPA210			UNIT
		D (SOIC)	DGK (VSSOP)	DBV (SOT-23)	
		8 PINS	8 PINS	5 PINS	
R _{θJA}	Junction-to-ambient thermal resistance	131.2	171.3	180.4	°C/W
R _{θJC(top)}	Junction-to-case (top) thermal resistance	71.6	64.7	67.9	°C/W
R _{θJB}	Junction-to-board thermal resistance	74.6	92.4	102.1	°C/W
ψ _{JT}	Junction-to-top characterization parameter	22.4	10.4	10.4	°C/W
ψ _{JB}	Junction-to-board characterization parameter	73.8	90.9	100.3	°C/W
R _{θJC(bottom)}	Junction-to-case (bottom) thermal resistance	N/A	N/A	N/A	°C/W

(1) For more information about traditional and new thermalmetrics, see the [Semiconductor and IC Package Thermal Metrics](#) application report.

6.5 Thermal Information: OPA2210

THERMAL METRIC ⁽¹⁾		OPA2210			UNIT
		D (SOIC)	DGK (VSSOP)	DRG (SON)	
		8 PINS	8 PINS	8 PINS	
R _{θJA}	Junction-to-ambient thermal resistance	126.1	132.7	52.1	°C/W
R _{θJC(top)}	Junction-to-case (top) thermal resistance	65.7	38.5	51.8	°C/W
R _{θJB}	Junction-to-board thermal resistance	69.5	52.1	24.8	°C/W
ψ _{JT}	Junction-to-top characterization parameter	17.4	2.4	1.1	°C/W
ψ _{JB}	Junction-to-board characterization parameter	68.9	52.8	24.8	°C/W
R _{θJC(bot)}	Junction-to-case (bottom) thermal resistance	n/a	n/a	9.0	°C/W

(1) For more information about traditional and new thermal metrics, see the [Semiconductor and IC Package Thermal Metrics](#) application report.

6.6 Electrical Characteristics

at $V_S = \pm 15\text{ V}$, $T_A = 25^\circ\text{C}$, $R_L = 10\text{ k}\Omega$ connected to midsupply, and $V_{CM} = V_{OUT} = \text{midsupply}$ (unless otherwise noted)

PARAMETER		TEST CONDITIONS		MIN	TYP	MAX	UNIT	
OFFSET VOLTAGE								
V_{OS}	Input offset voltage	$V_S = \pm 15\text{ V}$, $V_{CM} = 0\text{ V}$			± 5	± 35	μV	
dV_{OS}/dT	Input offset voltage drift	$T_A = -40^\circ\text{C}$ to 125°C			± 0.1	± 0.5	$\mu\text{V}/^\circ\text{C}$	
V_{OS} - matching	Input offset voltage matching				± 5	± 35	μV	
PSRR	vs power supply	$V_S = \pm 2.25\text{ V}$ to $\pm 18\text{ V}$	$T_A = 25^\circ\text{C}$		0.05	0.5	$\mu\text{V}/\text{V}$	
			$T_A = -40^\circ\text{C}$ to 125°C					± 1
	Channel separation	DC			± 0.1		$\mu\text{V}/\text{V}$	
INPUT BIAS OPERATION								
I_B	Input bias current	$V_{CM} = 0\text{ V}$	$T_A = 25^\circ\text{C}$		± 0.3	± 2	nA	
			$T_A = -40^\circ\text{C}$ to 85°C					± 4
			$T_A = -40^\circ\text{C}$ to 125°C					± 7
I_{OS}	Input offset current	$V_{CM} = 0\text{ V}$	$T_A = 25^\circ\text{C}$		± 0.1	± 2	nA	
			$T_A = -40^\circ\text{C}$ to 85°C					± 4
			$T_A = -40^\circ\text{C}$ to 125°C					± 7
NOISE								
$e_{n,p-p}$	Input voltage noise	$f = 0.1\text{ Hz}$ to 10 Hz			0.09		μV_{pp}	
e_n	Noise density	$f = 10\text{ Hz}$			2.5		nV/ $\sqrt{\text{Hz}}$	
		$f = 100\text{ Hz}$			2.25			
		$f = 1\text{ kHz}$			2.2			
I_n	Input current noise density	$f = 1\text{ kHz}$			400		fA/ $\sqrt{\text{Hz}}$	
INPUT VOLTAGE RANGE								
V_{CM}	Common-mode voltage range			$(V-) + 1.5$		$(V+) - 1.5$	V	
CMRR	Common-mode rejection ratio	$(V-) + 1.5\text{ V} < V_{CM} < (V+) - 1.5\text{ V}$		132	140		dB	
		$(V-) + 1.5\text{ V} < V_{CM} < (V+) - 1.5\text{ V}$, $T_A = -40^\circ\text{C}$ to 125°C		120	130			
INPUT IMPEDANCE								
	Differential				400 9		k Ω pF	
	Common-mode				10 ⁹ 0.5		Ω pF	
OPEN-LOOP GAIN								
A_{OL}	Open-loop voltage gain	$(V-) + 0.2\text{ V} < V_O < (V+) - 0.2\text{ V}$, $R_L = 10\text{ k}\Omega$	$T_A = 25^\circ\text{C}$	126	132		dB	
			$T_A = -40^\circ\text{C}$ to 125°C	120				
		$(V-) + 0.6\text{ V} < V_O < (V+) - 0.6\text{ V}$, $R_L = 600\ \Omega$ ⁽¹⁾	$T_A = 25^\circ\text{C}$	114	120			
			$T_A = -40^\circ\text{C}$ to 85°C	110				
FREQUENCY RESPONSE								
GBW	Gain bandwidth product				18		MHz	
SR	Slew rate				6.4		V/ μs	
	Phase margin (Φ_m)	$R_L = 10\text{ k}\Omega$, $C_L = 25\text{ pF}$			80		degrees	
t_s	Settling time	0.1%, $G = -1$, 10-V step, $C_L = 100\text{ pF}$			2.1		μs	
		0.0015% (16-bit), $G = -1$, 10-V step, $C_L = 100\text{ pF}$			2.6			
	Overload recovery time	$G = -10$			0.5		μs	
	Total harmonic distortion + noise (THD+N)	$G = +1$, $f = 1\text{ kHz}$, $V_O = 20\text{ V}_{pp}$, $600\ \Omega$			0.000025		%	

6.6 Electrical Characteristics (continued)

at $V_S = \pm 15\text{ V}$, $T_A = 25^\circ\text{C}$, $R_L = 10\text{ k}\Omega$ connected to midsupply, and $V_{CM} = V_{OUT} = \text{midsupply}$ (unless otherwise noted)

PARAMETER	TEST CONDITIONS	MIN	TYP	MAX	UNIT	
OUTPUT						
Voltage output swing	$R_L = 10\text{ k}\Omega$, $A_{OL} > 130\text{ dB}$	$(V-) + 0.2$		$(V+) - 0.2$	V	
	$R_L = 600\ \Omega$, $A_{OL} > 114\text{ dB}$	$(V-) + 0.6$		$(V+) - 0.6$		
	$R_L = 10\text{ k}\Omega$, $A_{OL} > 120\text{ dB}$, $T_A = -40^\circ\text{C}$ to 125°C	$(V-) + 0.2$		$(V+) - 0.2$		
I_{SC}	Short-circuit current $V_S = \pm 18\text{ V}$		± 65		mA	
C_{LOAD}	Capacitive load drive (stable operation)		See セクション 6.7			
Z_O	Open-loop output impedance		See セクション 6.7			
POWER SUPPLY						
I_Q	Quiescent current (per amplifier)	$I_O = 0\text{ A}$	$T_A = 25^\circ\text{C}$	2.2	2.5	mA
			$T_A = -40^\circ\text{C}$ to 125°C		3.25	

(1) Temperature range limited by thermal performance of the package.

6.7 Typical Characteristics

at $T_A = 25^\circ\text{C}$, $V_S = \pm 15\text{ V}$, $R_L = 10\text{ k}\Omega$ connected to midsupply, and $V_{CM} = V_{OUT} = \text{midsupply}$ (unless otherwise noted)

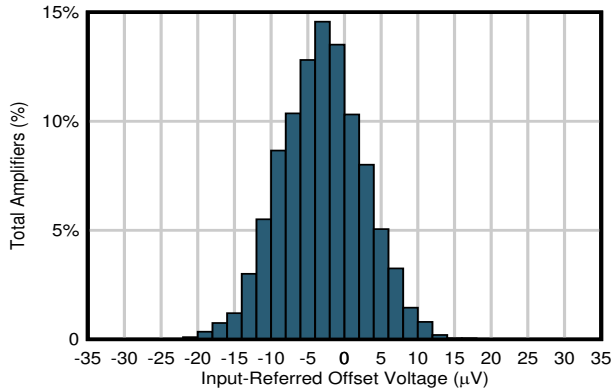

6-1. Offset Voltage Production Distribution

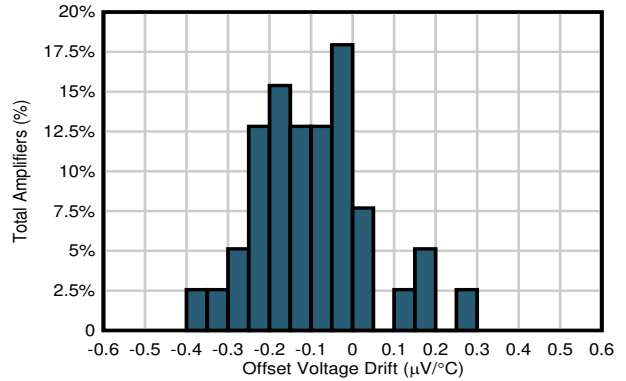

6-2. Offset Voltage Drift Distribution

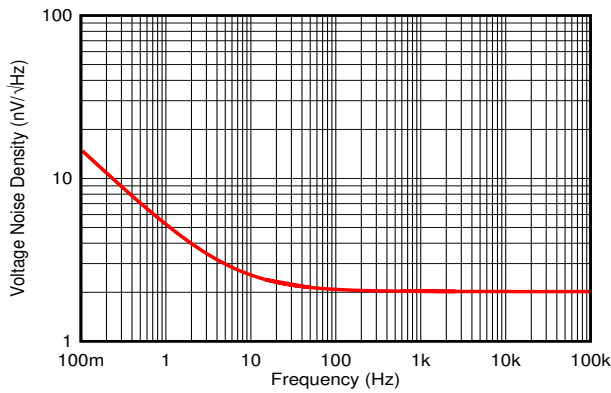

6-3. Input Voltage Noise Spectral Density vs Frequency

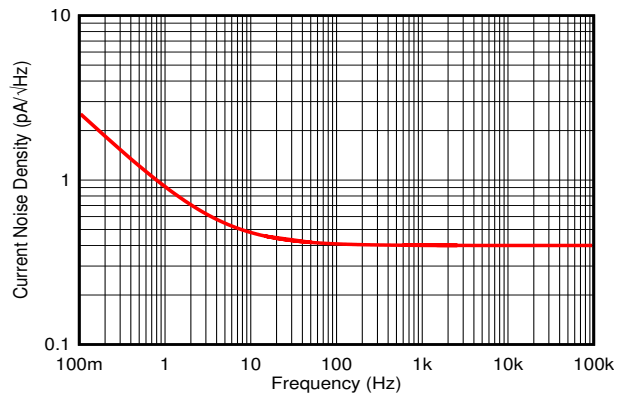

6-4. Input Current Noise Spectral Density vs Frequency

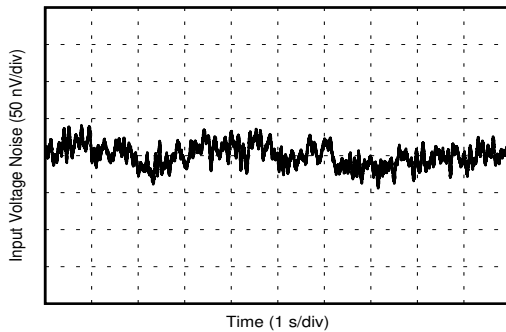

6-5. 0.1-Hz to 10-Hz Voltage Noise

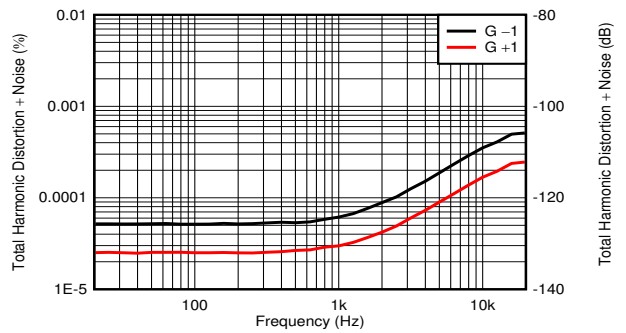

$V_{OUT} = 3.5 V_{RMS}$ $R_L = 600\ \Omega$

6-6. THD+N Ratio vs Frequency

6.7 Typical Characteristics (continued)

at $T_A = 25^\circ\text{C}$, $V_S = \pm 15\text{ V}$, $R_L = 10\text{ k}\Omega$ connected to midsupply, and $V_{CM} = V_{OUT} = \text{midsupply}$ (unless otherwise noted)

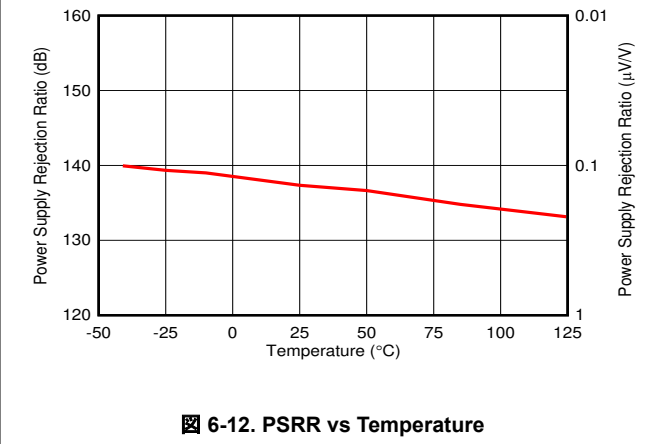
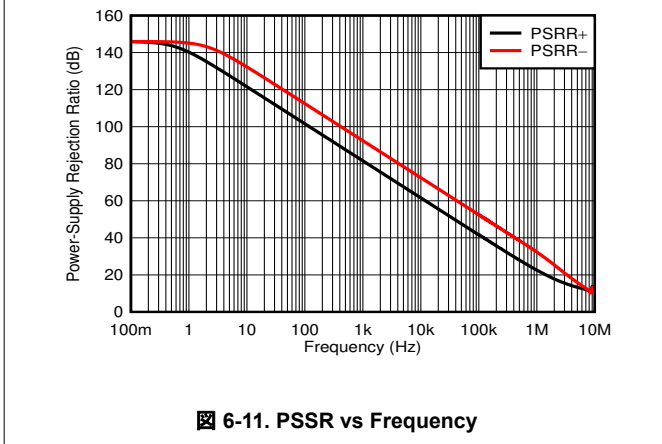
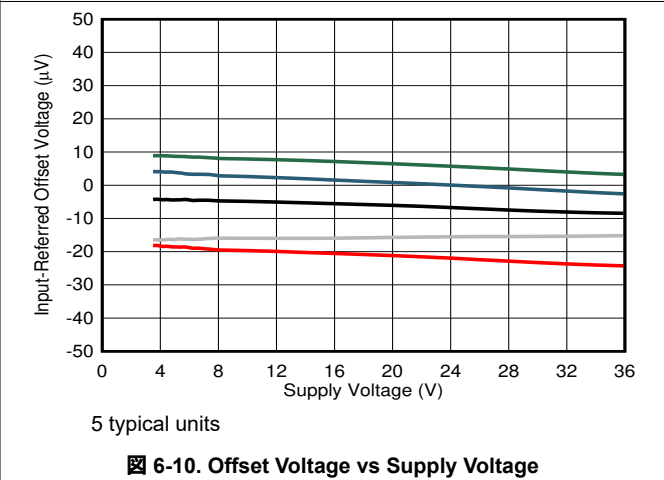
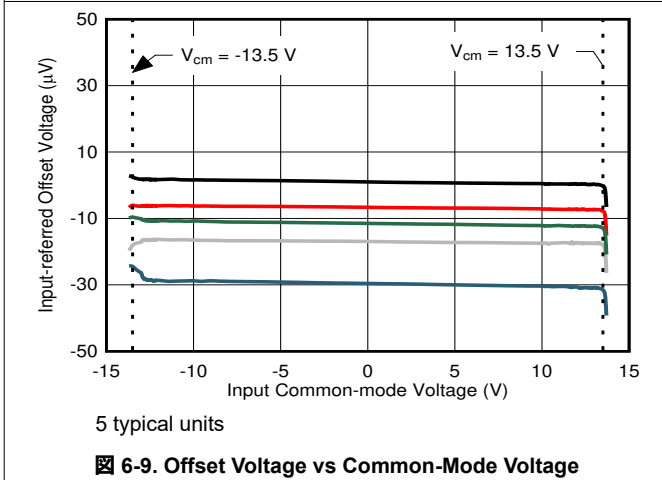
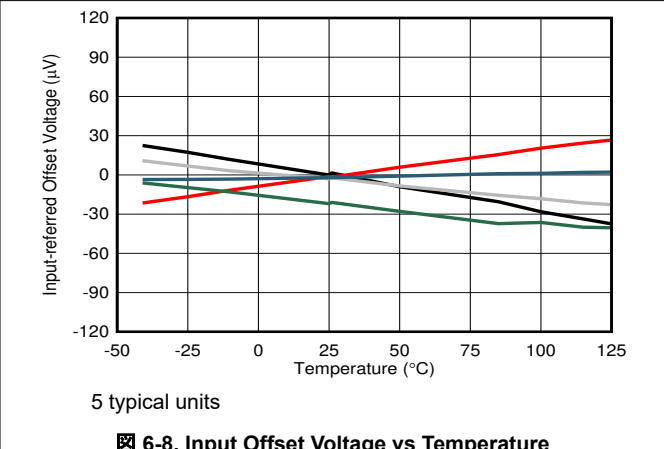
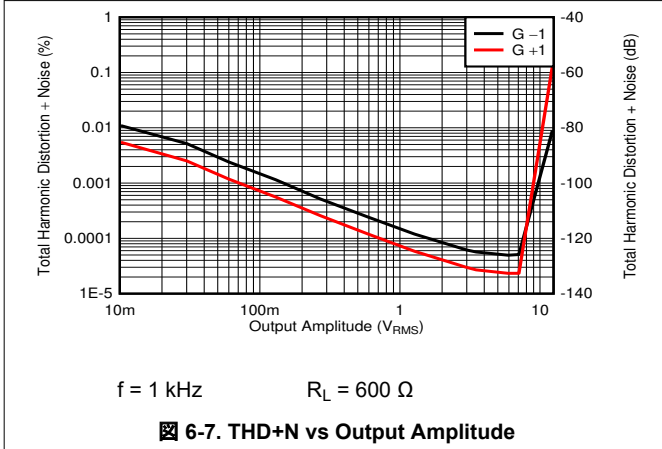

6.7 Typical Characteristics (continued)

at $T_A = 25^\circ\text{C}$, $V_S = \pm 15\text{ V}$, $R_L = 10\text{ k}\Omega$ connected to midsupply, and $V_{CM} = V_{OUT} = \text{midsupply}$ (unless otherwise noted)

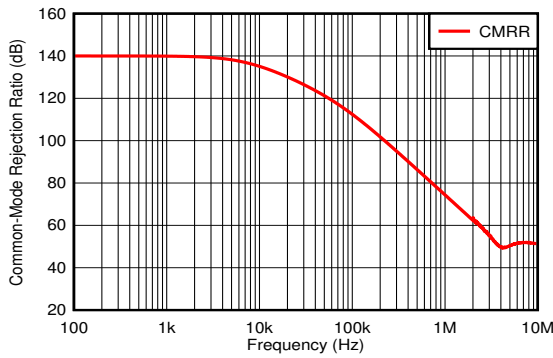

6-13. CMRR vs Frequency

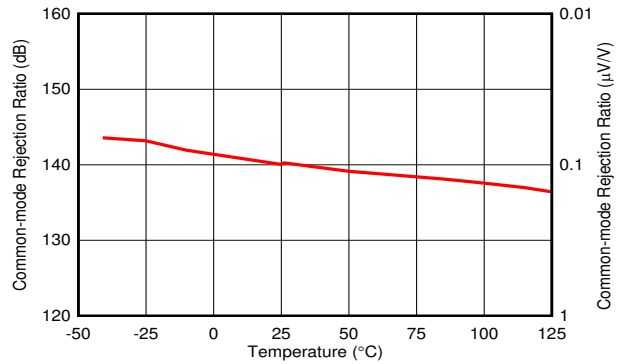

6-14. CMRR vs Temperature

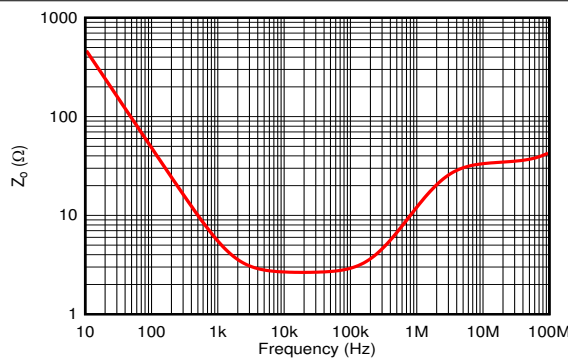

6-15. Open-Loop Output Impedance vs Frequency

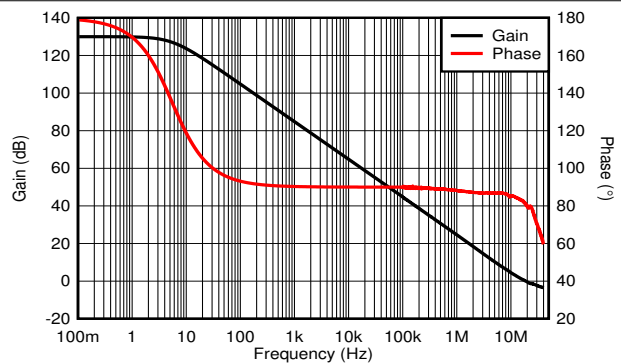

6-16. Open-Loop Gain and Phase vs Frequency

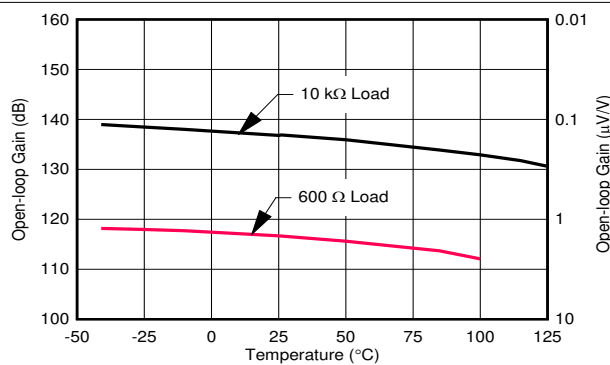

6-17. Open-Loop Gain vs Temperature

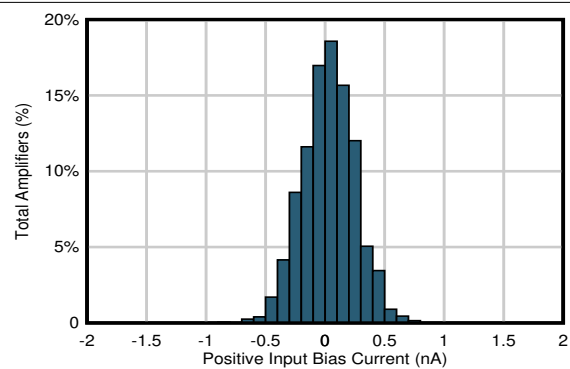

6-18. Positive Input Bias Current Production Distribution

6.7 Typical Characteristics (continued)

at $T_A = 25^\circ\text{C}$, $V_S = \pm 15\text{ V}$, $R_L = 10\text{ k}\Omega$ connected to midsupply, and $V_{CM} = V_{OUT} = \text{midsupply}$ (unless otherwise noted)

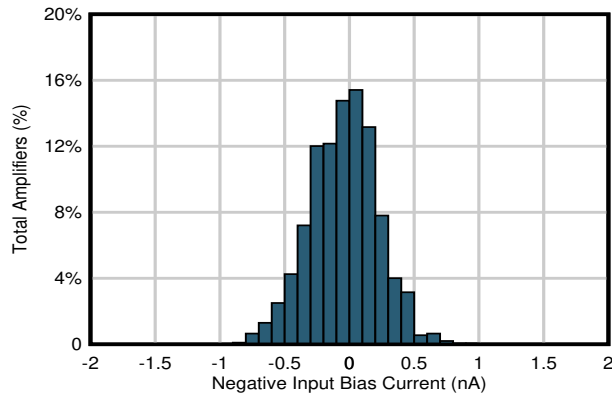

6-19. Negative Input Bias Current Production Distribution

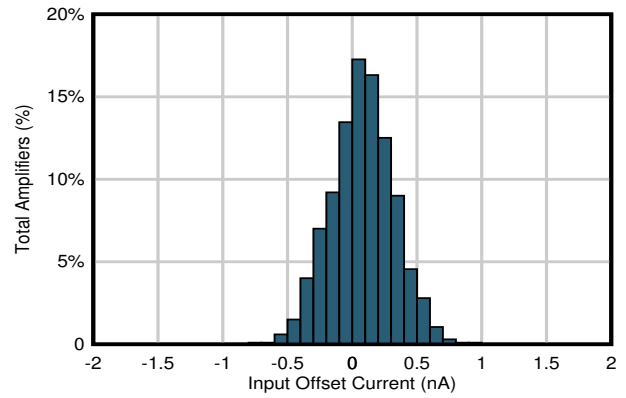

6-20. Input Offset Current Production Distribution

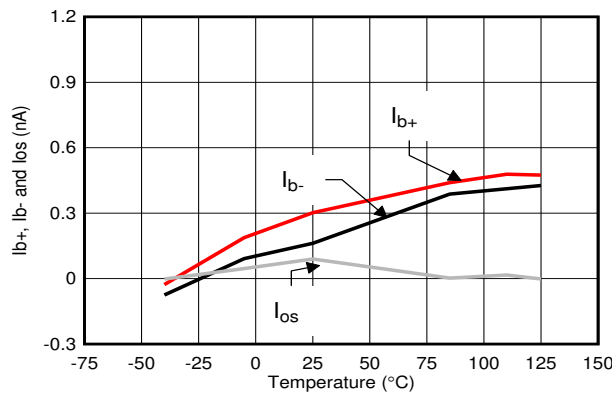

6-21. Input Bias and Input Offset Currents vs Temperature

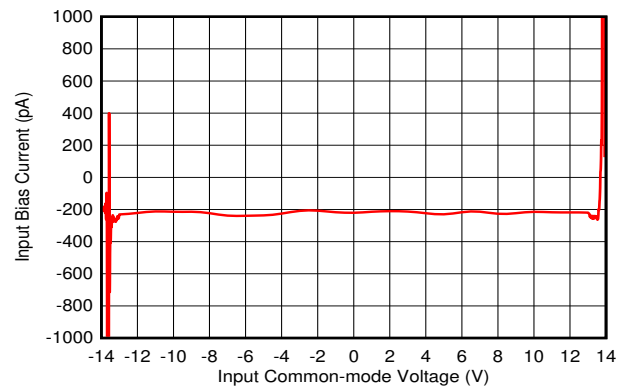

6-22. Positive Input Bias Current vs Common-Mode Voltage

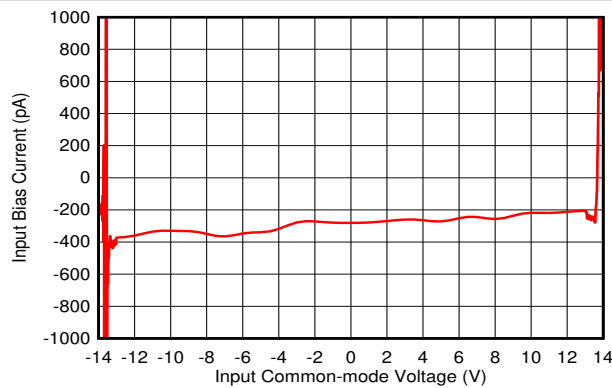

6-23. Negative Input Bias Current vs Common-Mode Voltage

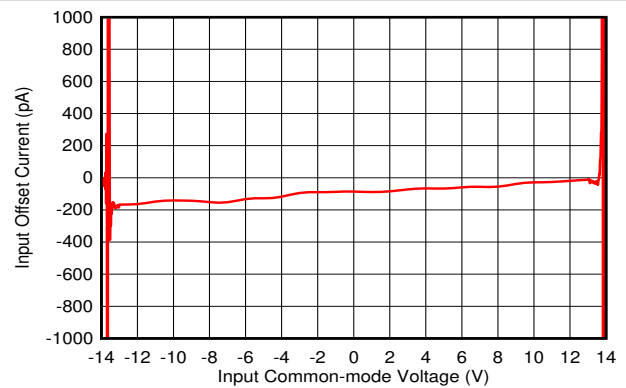

6-24. Input Offset Current vs Common-Mode Voltage

6.7 Typical Characteristics (continued)

at $T_A = 25^\circ\text{C}$, $V_S = \pm 15\text{ V}$, $R_L = 10\text{ k}\Omega$ connected to midsupply, and $V_{CM} = V_{OUT} = \text{midsupply}$ (unless otherwise noted)

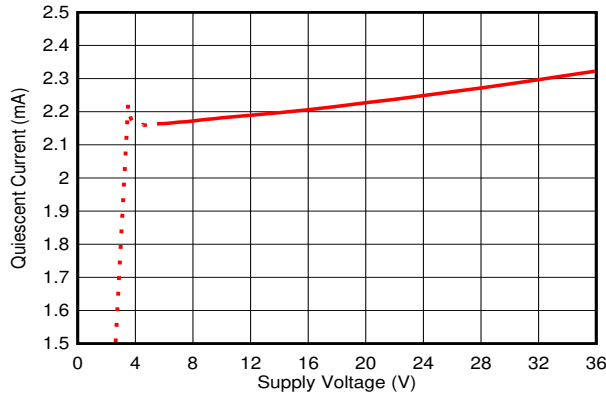

6-25. Quiescent Current vs Supply Voltage

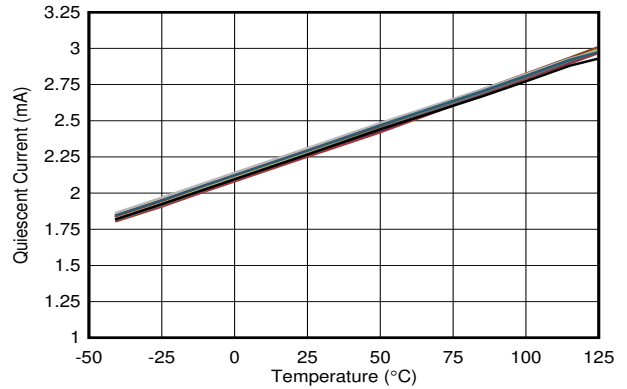

6-26. Quiescent Current vs Temperature

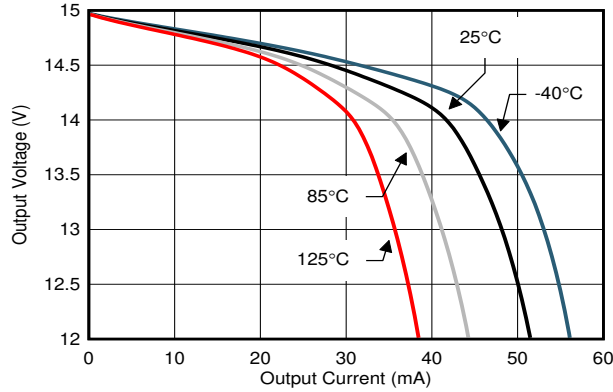

A.

6-27. Output Voltage vs Output Current (Sourcing)

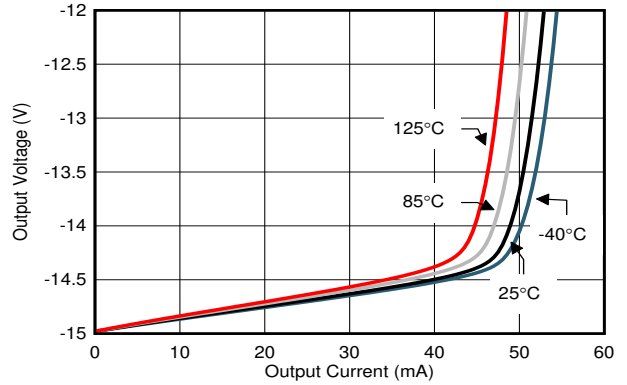

A.

6-28. Output Voltage vs Output Current (Sinking)

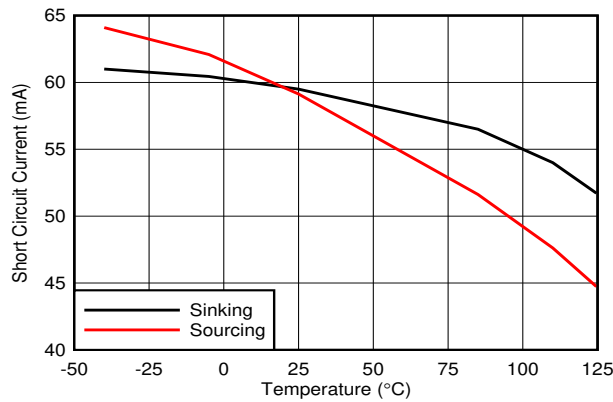

6-29. Short-Circuit Current vs Temperature

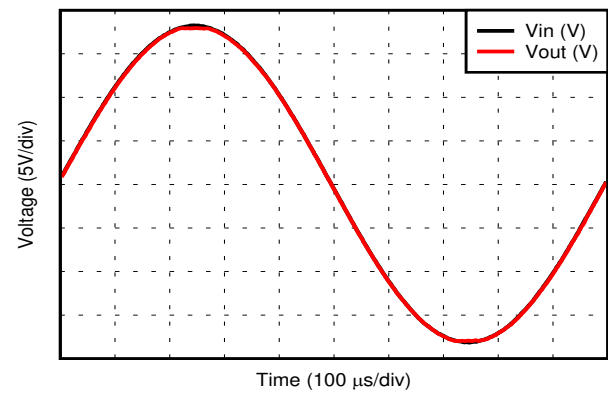

6-30. No Phase Reversal

6.7 Typical Characteristics (continued)

at $T_A = 25^\circ\text{C}$, $V_S = \pm 15\text{ V}$, $R_L = 10\text{ k}\Omega$ connected to midsupply, and $V_{CM} = V_{OUT} = \text{midsupply}$ (unless otherwise noted)

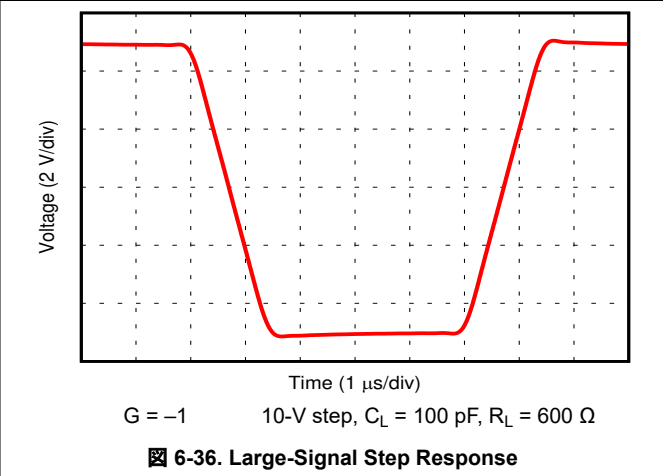
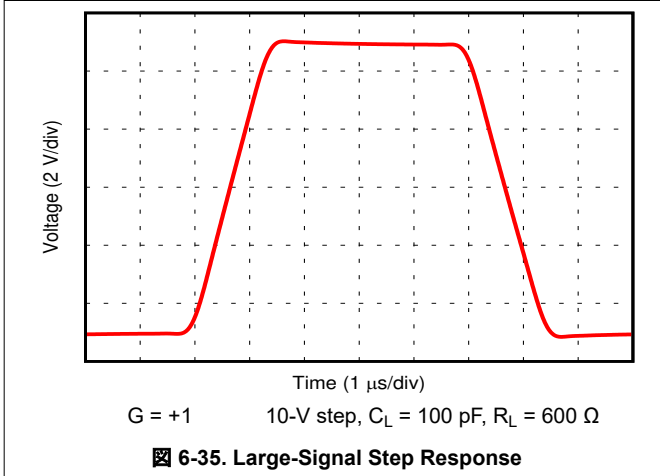
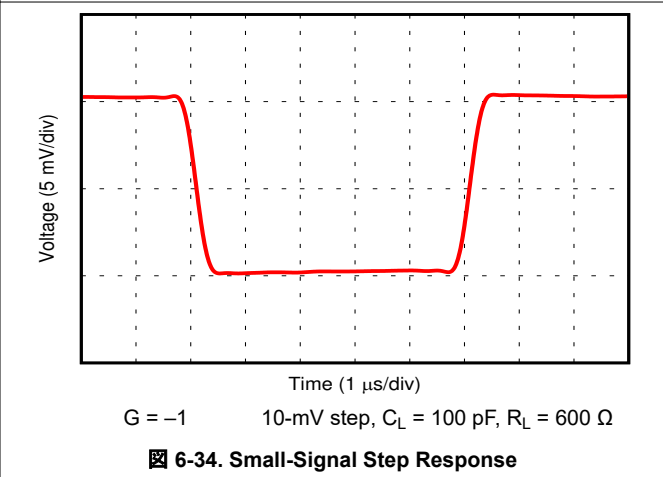
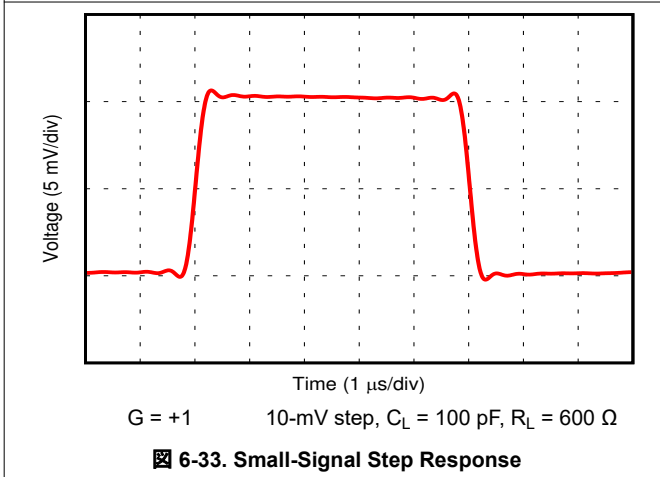
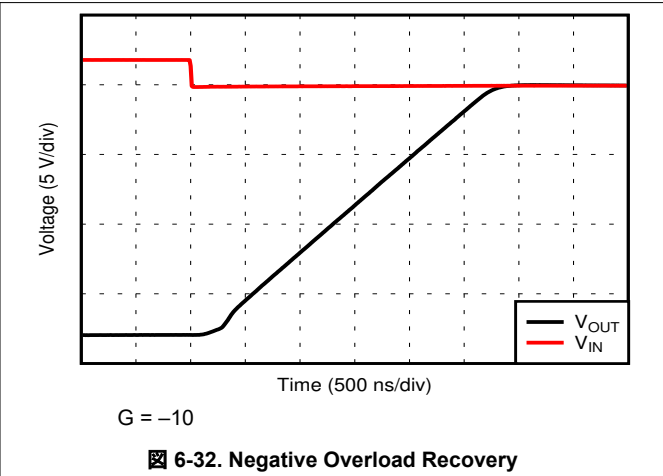
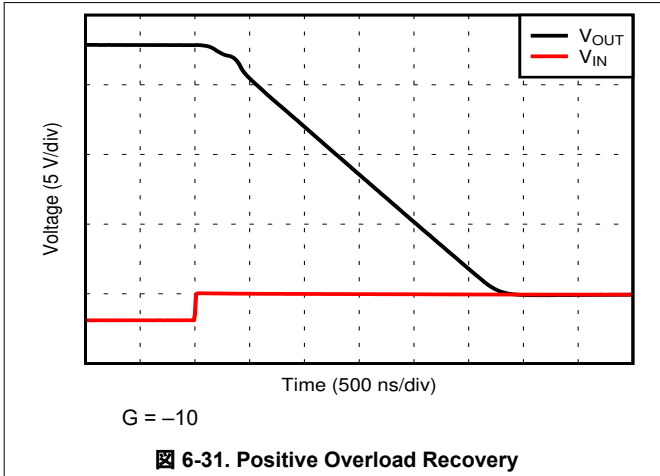

6.7 Typical Characteristics (continued)

at $T_A = 25^\circ\text{C}$, $V_S = \pm 15\text{ V}$, $R_L = 10\text{ k}\Omega$ connected to midsupply, and $V_{CM} = V_{OUT} = \text{midsupply}$ (unless otherwise noted)

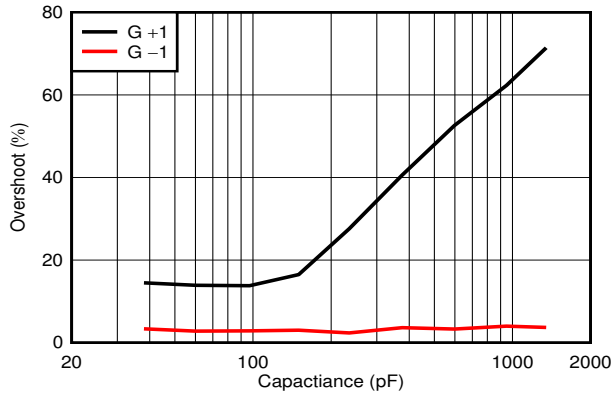

6-37. Small-Signal Overshoot vs Capacitive Load

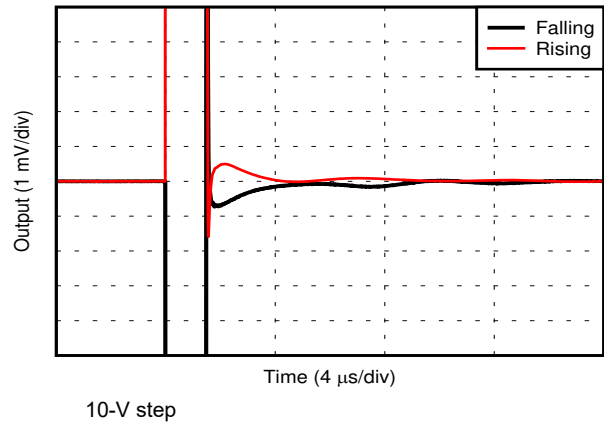

6-38. Settling Time

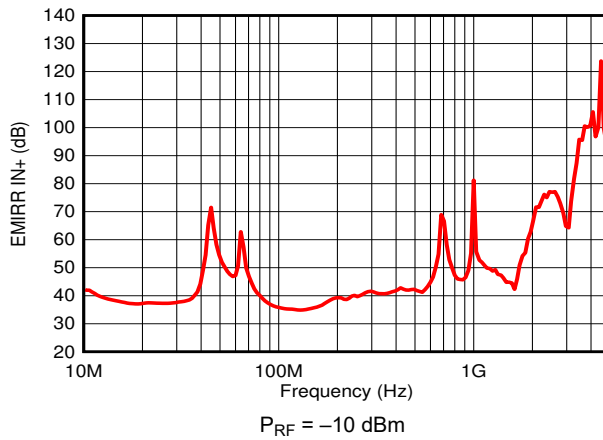

6-39. EMIRR vs Frequency

7 Detailed Description

7.1 Overview

The OPAX210 are the next generation of the OPAX209 operational amplifiers. The OPAX210 offer improved input offset voltage, offset voltage temperature drift, input bias current, and lower $1/f$ noise corner frequency. In addition, these devices offer excellent overall performance with high CMRR, PSRR, and A_{OL} . The OPAX210 precision operational amplifiers are unity-gain stable, and free from unexpected output and phase reversal. Applications with noisy or high-impedance power supplies require decoupling capacitors placed close to the device pins. In most cases, $0.1\text{-}\mu\text{F}$ capacitors are adequate. [セクション 7.2](#) shows a simplified schematic of the OPAX210. The die uses a SiGe bipolar process and contains 180 transistors.

7.2 Functional Block Diagram

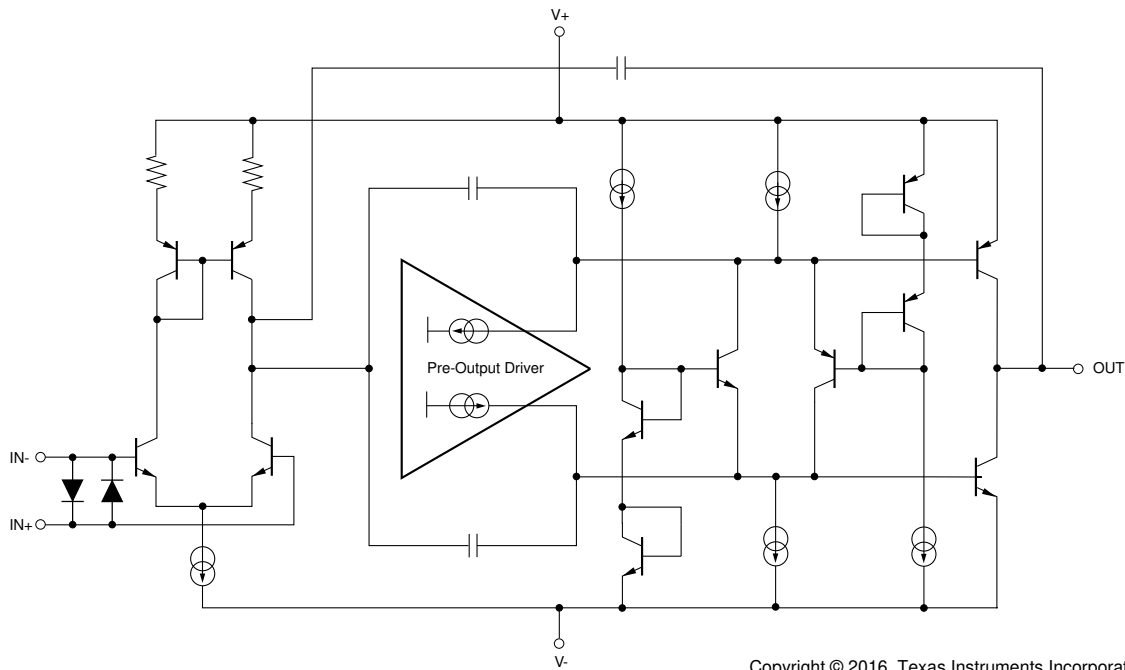

Copyright © 2016, Texas Instruments Incorporated

7.3 Feature Description

7.3.1 Operating Voltage

The OPAx210 op amps can be used with single or dual supplies within an operating range of $V_S = 4.5\text{ V} (\pm 2.25\text{ V})$ up to $36\text{ V} (\pm 18\text{ V})$.

CAUTION

Supply voltages greater than 40 V total can permanently damage the device.

In addition, key parameters are specified over the temperature range of $T_A = -40^\circ\text{C}$ to $+125^\circ\text{C}$. Parameters that vary significantly with operating voltage or temperature are shown in [セクション 6.7](#).

7.3.2 Input Protection

The input pins of the OPAx210 are protected from excessive differential voltage with back-to-back diodes, as shown in [図 7-1](#). In most circuit applications, the input protection circuitry has no consequence. However, in low-gain or $G = 1$ circuits, fast-ramping input signals can forward-bias these diodes because the output of the amplifier cannot respond rapidly enough to the input ramp. This effect is illustrated in [図 6-35](#) and [図 6-36](#) in [セクション 6.7](#). If the input signal is fast enough to create this forward-bias condition, the input signal current must be limited to 10 mA or less. If the input signal current is not inherently limited, an input series resistor can be used to limit the signal input current. This input series resistor degrades the low-noise performance of the OPAx210. See [セクション 7.3.3](#) for further information on noise performance.

[図 7-1](#) shows an example configuration that implements a current-limiting feedback resistor.



図 7-1. Pulsed Operation

7.3.3 Noise Performance

[図 7-2](#) shows the total circuit noise for varying source impedances with the op amp in a unity-gain configuration (no feedback resistor network, and therefore, no additional noise contributions). Two different op amps are shown with the total circuit noise calculated. The OPAx210 have very low voltage noise, making these devices a great choice for low source impedances (less than 2 k Ω). As a comparable, precision FET-input op amp (very low current noise), the [OPA827](#) has somewhat higher voltage noise, but lower current noise. The device provides excellent noise performance at moderate to high source impedance (10 k Ω and up). For source impedance lower than 300 Ω , the [OPA211](#) may provide lower noise.

The equation in [図 7-2](#) shows the calculation of the total circuit noise, with these parameters:

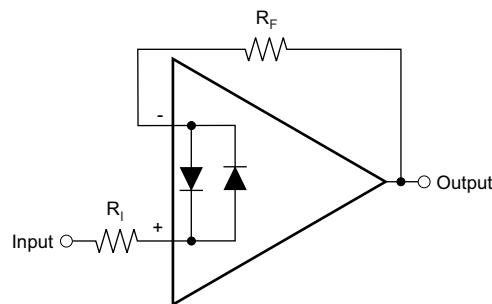
- e_n = voltage noise,
- i_n = current noise,
- R_S = source impedance,
- k = Boltzmann's constant = 1.38×10^{-23} J/K, and
- T = temperature in kelvins

For more details on calculating noise, see [セクション 8.1.1](#).

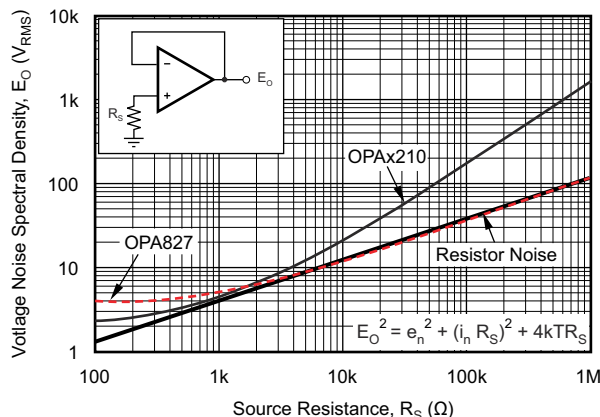

7-2. Noise Performance of the OPAx210 and OPA827 in Unity-Gain Buffer Configuration

7.3.4 Phase-Reversal Protection

The OPAx210 have internal phase-reversal protection. Many FET- and bipolar-input op amps exhibit a phase reversal when the input is driven beyond the linear common-mode range. This condition is most often encountered in noninverting circuits when the input is driven beyond the specified common-mode voltage range, causing the output to reverse into the opposite rail. The input circuitry of the OPAx210 prevents phase reversal with excessive common-mode voltage; instead, the output limits into the appropriate rail (see 6-30).

7.3.5 Electrical Overstress

Designers often ask questions about the capability of an operational amplifier to withstand electrical overstress. These questions tend to focus on the device inputs, but may involve the supply voltage pins or even the output pin. Each of these different pin functions have electrical stress limits determined by the voltage breakdown characteristics of the particular semiconductor fabrication process and specific circuits connected to the pin. Additionally, internal electrostatic discharge (ESD) protection is built into these circuits to protect them from accidental ESD events both before and during product assembly.

It is helpful to have a good understanding of this basic ESD circuitry and its relevance to an electrical overstress event. See 7-3 for an illustration of the ESD circuits contained in the OPAx210 (indicated by the dashed line area). The ESD protection circuitry involves several current-steering diodes connected from the input and output pins and routed back to the internal power-supply lines, where they meet at an absorption device internal to the operational amplifier. This protection circuitry is intended to remain inactive during normal circuit operation.

An ESD event produces a short duration, high-voltage pulse that is transformed into a short duration, high-current pulse as it discharges through a semiconductor device. The ESD protection circuits are designed to provide a current path around the operational amplifier core to prevent it from being damaged. The energy absorbed by the protection circuitry is then dissipated as heat.

When an ESD voltage develops across two or more of the amplifier device pins, current flows through one or more of the steering diodes. Depending on the path that the current takes, the absorption device may activate. The absorption device has a trigger, or threshold voltage, that is greater than the normal operating voltage of the OPAx210 but less than the device breakdown voltage level. After this threshold is exceeded, the absorption device quickly activates and clamps the voltage across the supply rails to a safe level.

When the operational amplifier connects into a circuit such as the one 7-3 shows, the ESD protection components are intended to remain inactive and not become involved in the application circuit operation. However, circumstances may arise where an applied voltage exceeds the operating voltage range of a given pin. If this condition occur, there is a risk that some of the internal ESD protection circuits may be biased on, and conduct current. Any such current flow occurs through steering diode paths and rarely involves the absorption device.

7-3 depicts a specific example where the input voltage, V_{IN} , exceeds the positive supply voltage, $+V_S$, by 500 mV or more. Much of what happens in the circuit depends on the supply characteristics. If $+V_S$ can sink the

current, one of the upper input steering diodes conducts and directs current to $+V_S$. Excessively high current levels can flow with increasingly higher V_{IN} . As a result, the data sheet specifications recommend that applications limit the input current to 10 mA.

If the supply is not capable of sinking the current, V_{IN} may begin sourcing current to the operational amplifier, and then take over as the source of positive supply voltage. The danger in this case is that the voltage can rise to levels that exceed the operational amplifier absolute maximum ratings.

Another common question involves what happens to the amplifier if an input signal is applied to the input while power supplies $+V_S$, $-V_S$, or both are at 0 V.

Again, the answer depends on the supply characteristic while at 0 V, or at a level less than the input signal amplitude. If the supplies appear as high impedance, then the operational amplifier supply current may be supplied by the input source through the current steering diodes. This state is not a normal bias condition; the amplifier will not operate normally. If the supplies are low impedance, then the current through the steering diodes can become quite high. The current level depends on the ability of the input source to deliver current, and any resistance in the input path.

If there is an uncertainty about the ability of the supply to absorb this current, external transient voltage suppressor (TVS) diodes may be added to the supply pins as shown in [Figure 7-3](#). The breakdown voltage must be selected so that the diode does not turn on during normal operation. However, the breakdown voltage must be low enough so that the TVS diode conducts if the supply pin begins to rise to greater than the safe operating supply voltage level.

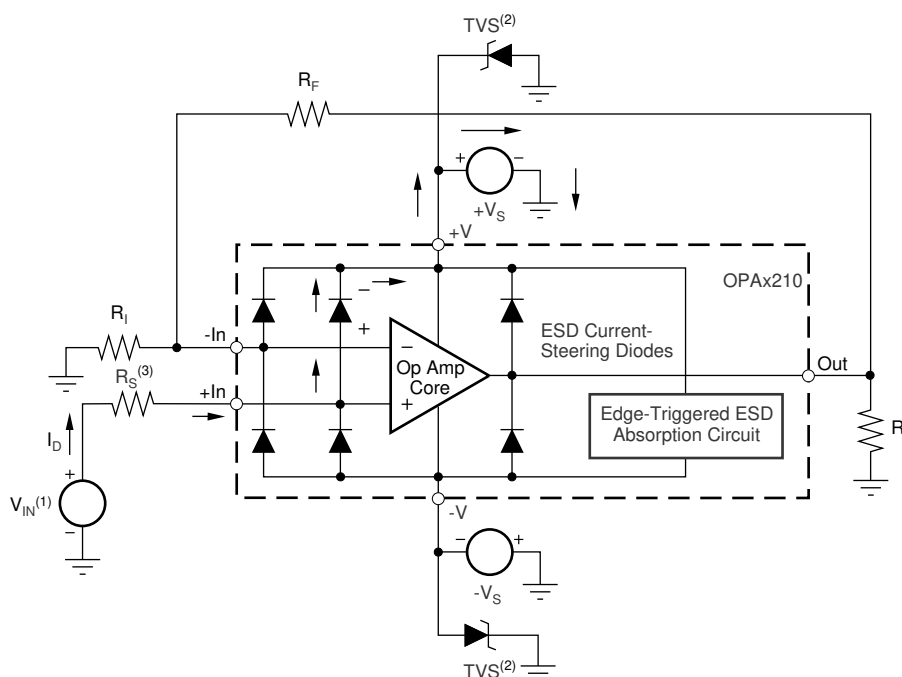

(1) $V_{IN} = +V_S + 500 \text{ mV}$.

(2) TVS: $+V_{S(max)} > V_{TVSBR (Min)} > +V_S$.

(3) Suggested value approximately 1 k Ω .

Figure 7-3. Equivalent Internal ESD Circuitry and Relation to a Typical Circuit Application

7.4 Device Functional Modes

The OPAx210 are operational when the power-supply voltage is greater than 4.5 V (± 2.25 V). The maximum power-supply voltage for the OPAx210 is 36 V (± 18 V).

8 Application and Implementation

Note

以下のアプリケーション情報は、TI の製品仕様に含まれるものではなく、TI ではその正確性または完全性を保証いたしません。個々の目的に対する製品の適合性については、お客様の責任で判断していただくこととなります。お客様は自身の設計実装を検証しテストすることで、システムの機能を確認する必要があります。

8.1 Application Information

The OPAx210 are unity-gain stable, precision operational amplifiers with very low noise. Applications with noisy or high-impedance power supplies require decoupling capacitors close to the device pins. In most cases, 0.1- μ F capacitors are adequate.

8.1.1 Basic Noise Calculations

Low-noise circuit design requires careful analysis of all noise sources. External noise sources can dominate in many cases; consider the effect of source resistance on overall op amp noise performance. Total noise of the circuit is the root-sum-square combination of all noise components.

The resistive portion of the source impedance produces thermal noise proportional to the square root of the resistance. This function is plotted in [Figure 7-2](#). The source impedance is usually fixed; consequently, select the op amp and the feedback resistors to minimize the respective contributions to the total noise.

[Figure 8-1](#) illustrates both noninverting (**A**) and inverting (**B**) op amp circuit configurations with gain. In circuit configurations with gain, the feedback network resistors also contribute noise. In general, the current noise of the op amp reacts with the feedback resistors to create additional noise components. However, the extremely low current noise of the OPAx210 means that the device current noise contribution can be neglected.

Generally, the feedback resistor values are chosen to make these noise sources negligible. Low impedance feedback resistors load the output of the amplifier. The equations for total noise are shown for both configurations.

(A) Noise in Noninverting Gain Configuration

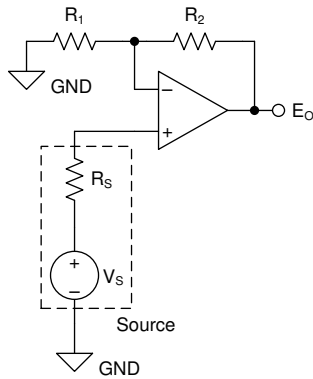

Noise at the output is given as E_O , where

$$(1) \quad E_O = \left(1 + \frac{R_2}{R_1}\right) \cdot \sqrt{(e_S)^2 + (e_N)^2 + (e_{R_1 \parallel R_2})^2 + (i_N \cdot R_S)^2 + \left(i_N \cdot \left[\frac{R_1 \cdot R_2}{R_1 + R_2}\right]\right)^2} \quad [V_{RMS}]$$

$$(2) \quad e_S = \sqrt{4 \cdot k_B \cdot T(K) \cdot R_S} \quad \left[\frac{V}{\sqrt{Hz}}\right] \quad \text{Thermal noise of } R_S$$

$$(3) \quad e_{R_1 \parallel R_2} = \sqrt{4 \cdot k_B \cdot T(K) \cdot \left[\frac{R_1 \cdot R_2}{R_1 + R_2}\right]} \quad \left[\frac{V}{\sqrt{Hz}}\right] \quad \text{Thermal noise of } R_1 \parallel R_2$$

$$(4) \quad k_B = 1.38065 \cdot 10^{-23} \quad \left[\frac{J}{K}\right] \quad \text{Boltzmann Constant}$$

$$(5) \quad T(K) = 237.15 + T(^{\circ}C) \quad [K] \quad \text{Temperature in kelvins}$$

(B) Noise in Inverting Gain Configuration

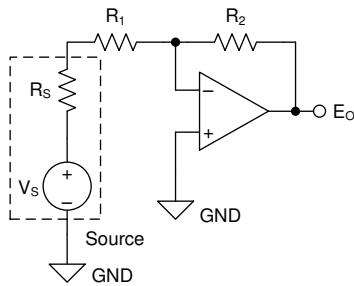

Noise at the output is given as E_O , where

$$(6) \quad E_O = \left(1 + \frac{R_2}{R_S + R_1}\right) \cdot \sqrt{(e_N)^2 + (e_{R_1 + R_S \parallel R_2})^2 + \left(i_N \cdot \left[\frac{(R_S + R_1) \cdot R_2}{R_S + R_1 + R_2}\right]\right)^2} \quad [V_{RMS}]$$

$$(7) \quad e_{R_1 + R_S \parallel R_2} = \sqrt{4 \cdot k_B \cdot T(K) \cdot \left[\frac{(R_S + R_1) \cdot R_2}{R_S + R_1 + R_2}\right]} \quad \left[\frac{V}{\sqrt{Hz}}\right] \quad \text{Thermal noise of } (R_1 + R_S) \parallel R_2$$

$$(8) \quad k_B = 1.38065 \cdot 10^{-23} \quad \left[\frac{J}{K}\right] \quad \text{Boltzmann Constant}$$

$$(9) \quad T(K) = 237.15 + T(^{\circ}C) \quad [K] \quad \text{Temperature in kelvins}$$

Copyright © 2017, Texas Instruments Incorporated

Where e_N is the voltage noise of the amplifier. For the OPAX210 op amp, $e_N = 2.2 \text{ nV}/\sqrt{\text{Hz}}$ at 1 kHz.

Where i_N is the current noise of the amplifier. For the OPAX210 op amp, $i_N = 400 \text{ fA}/\sqrt{\text{Hz}}$ at 1 kHz.

NOTE: For additional resources on noise calculations visit the [TI Precision Labs Series](#).

8-1. Noise Calculation in Gain Configurations

8.2 Typical Application

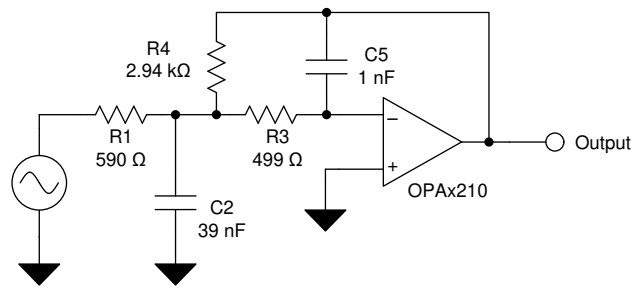

Figure 8-2. Low-Pass Filter

8.2.1 Design Requirements

Low-pass filters are commonly used in signal processing applications to reduce noise and prevent aliasing. The OPAx210 are designed to construct high-speed, high-precision active filters. Figure 8-2 shows a second-order, low-pass filter commonly encountered in signal-processing applications.

Use the following parameters for this design example:

- Gain = 5 V/V (inverting gain)
- Low-pass cutoff frequency = 25 kHz
- Second-order Chebyshev filter response with 3-dB gain peaking in the pass band

8.2.2 Detailed Design Procedure

The infinite-gain, multiple-feedback circuit for a low-pass network function is shown in Figure 8-2. Use Equation 1 to calculate the voltage transfer function.

$$\frac{\text{Output}}{\text{Input}}(s) = \frac{-1/R_1 R_3 C_2 C_5}{s^2 + (s/C_2)(1/R_1 + 1/R_3 + 1/R_4) + 1/R_3 R_4 C_2 C_5} \quad (1)$$

This circuit produces a signal inversion. For this circuit, the gain at dc and the low-pass cutoff frequency are calculated by Equation 2:

$$\text{Gain} = \frac{R_4}{R_1}$$

$$f_c = \frac{1}{2\pi} \sqrt{(1/R_3 R_4 C_2 C_5)} \quad (2)$$

8.2.3 Application Curve

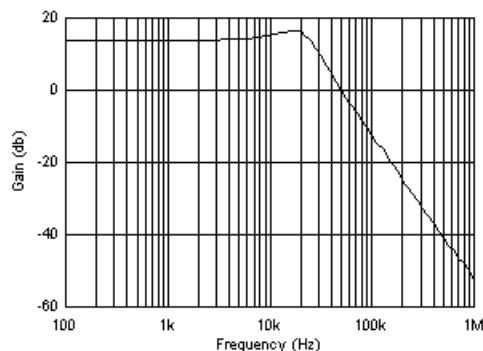

Figure 8-3. OPAx210 Second-Order, 25-kHz, Chebyshev, Low-Pass Filter

8.3 System Example

8.3.1 Time Gain Control System for Ultrasound Applications

During an ultrasound send-receive cycle, the magnitude of reflected signal depends on the depth of penetration. The ultrasound signal incident on the receiver decreases in amplitude as a function of the time elapsed since transmission. The time gain control (TGC) system helps achieve the best possible signal-to-noise ratio (SNR), even with the decreasing signal amplitude. When the image is displayed, similar materials have similar brightness, regardless of depth. *Linear-in-dB* gain, which means the decibel gain is a linear function of the control voltage (V_{CNTL}), is used to generate this image.

There are multiple approaches for a TGC control circuit that are based on the type of DAC. [Figure 8-4](#) shows a high-level block diagram for the topology using a current-output multiplying DAC (MDAC) to generate the drive for V_{CNTL} . The op amp used for current-to-voltage (I-to-V) conversion must have low-voltage noise, as well as low-current noise density. The current density helps reduce the overall noise performance because of the DAC output configuration. The DAC output can go up to ± 10 V; therefore, the op amp must have bipolar operation. The OPAx210 is used here because of the low-voltage noise density of $2.2 \text{ nV}/\sqrt{\text{Hz}}$, low-current noise density of $500 \text{ fA}/\sqrt{\text{Hz}}$, rail-to-rail output, and the ability to accept a wide supply range of $\pm 2.25 \text{ V}$ to $\pm 18 \text{ V}$ and provide rail-to-rail output. The low offset voltage and offset drift of the OPAx210 facilitate excellent dc accuracy for the circuit.

The OPAx210 is used to filter and buffer the 10-V reference voltage generated by the REF5010. The REF5010 serves as the reference voltage for the DAC8802, which generates a current output on I_{OUT} corresponding to the digital input code. The I_{OUT} pin of the DAC8802 is connected to the virtual ground (negative terminal) of the OPAx210; the feedback resistor (R_{FB} is internal to the DAC8802) is connected to the output of the OPAx210, and results in a current-to-voltage conversion. The output of the OPAx210 has a range of -10 V to 0 V , which is fed to the THS4130 configured as a Sallen-Key filter. Finally, the 10-V range is attenuated down to a 1.5-V range, with a common-mode voltage of 0.75 V using a resistive attenuator. See the [2.3-nV/√Hz, Differential, Time Gain Control DAC Reference Design for Ultrasound](#) for an in-depth analysis of [Figure 8-4](#).

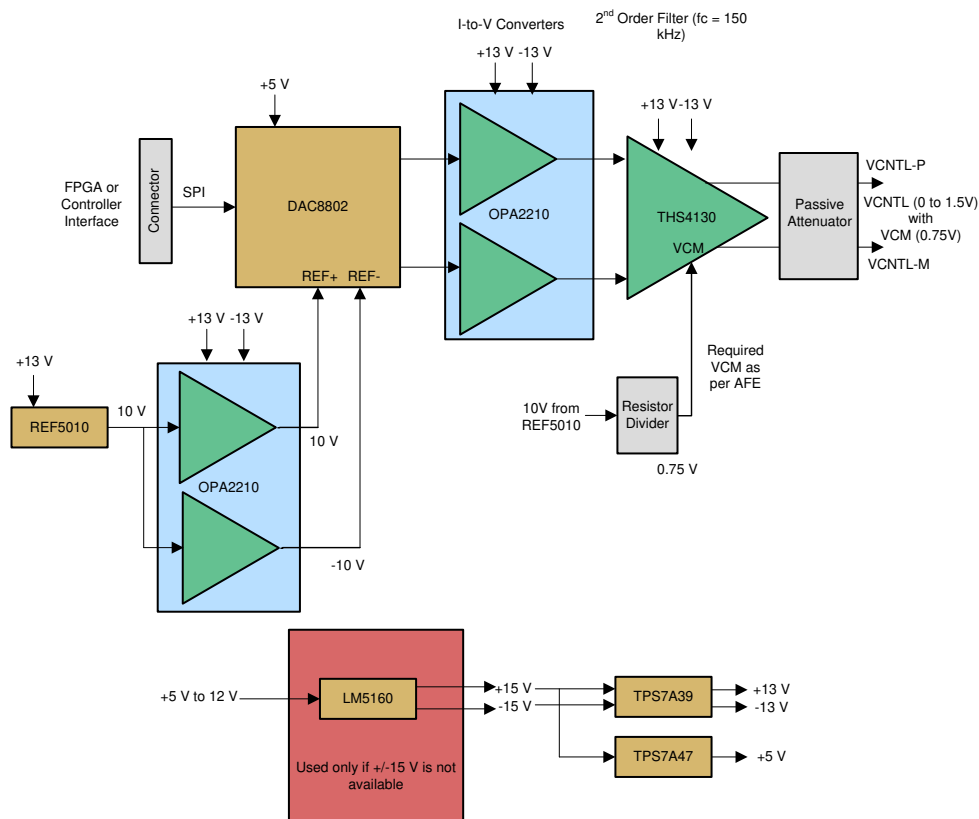

Figure 8-4. Block Diagram for Time Gain Control System for Ultrasound

9 Power Supply Recommendations

The OPAx210 are specified for operation from 4.5 V to 36 V (± 2.25 V to ± 18 V); many specifications apply from -40°C to $+125^{\circ}\text{C}$. Parameters that can exhibit significant variance with regard to operating voltage or temperature are presented in [セクション 6.7](#).

10 Layout

10.1 Layout Guidelines

For best operational performance of the device, use good printed circuit board (PCB) layout practices, including the following guidelines:

- Noise from the amplifier can propagate into other analog circuits through the power pins of the amplifiers. Use bypass capacitors to reduce the coupled noise by providing low-impedance power sources local to the analog circuitry.
- Connect low-ESR, 0.1- μF ceramic bypass capacitors between each supply pin and ground, placed as close to the device as possible. A single bypass capacitor from V+ to ground is applicable for single-supply applications.
- Separate grounding for analog and digital portions of circuitry is one of the simplest and most-effective methods of noise suppression. One or more layers on multilayer PCBs are usually devoted to ground planes. A ground plane helps distribute heat and reduces EMI noise pickup. Make sure to physically separate digital and analog grounds paying attention to the flow of the ground current.
- To reduce parasitic coupling, run the input traces as far away from the supply or output traces as possible. If these traces cannot be kept separate, crossing the sensitive trace perpendicular is much better than running in parallel with the noisy trace.
- Place the external components as close to the device as possible.
- Keep the length of input traces as short as possible. Always remember that the input traces are the most sensitive part of the circuit.
- Consider a driven, low-impedance guard ring around the critical traces. A guard ring can significantly reduce leakage currents from nearby traces that are at different potentials.
- For best performance, clean the PCB following board assembly.
- Any precision integrated circuit may experience performance shifts due to moisture ingress into the plastic package. Following any aqueous PCB cleaning process, bake the PCB to remove moisture introduced into the device packaging during the cleaning process. A low-temperature, post-cleaning bake at 85°C for 30 minutes is sufficient for most circumstances.

10.2 Layout Example

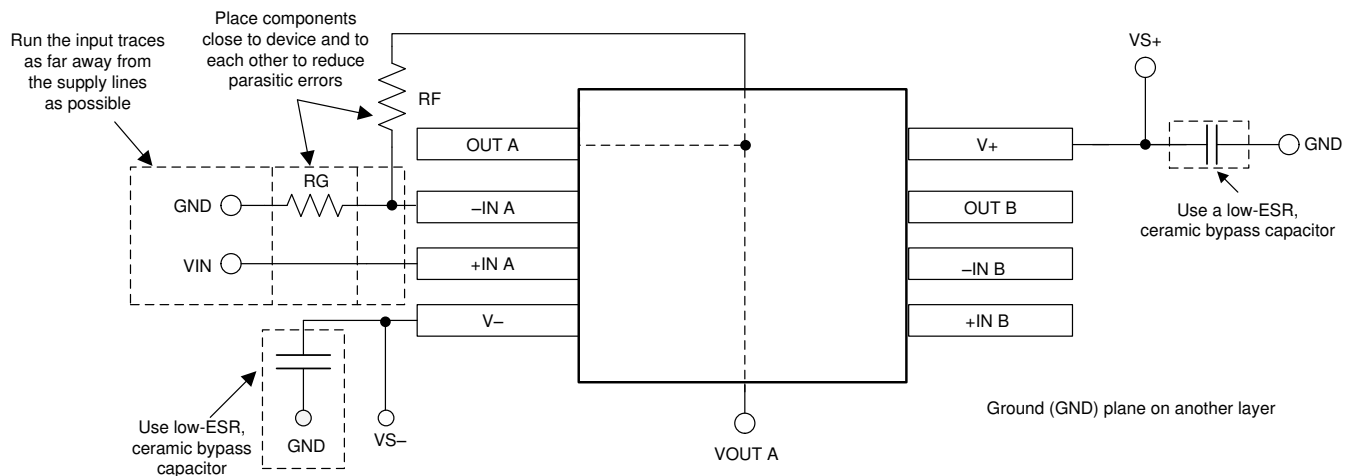

10-1. OPA2210 Layout Example

11 Device and Documentation Support

11.1 Device Support

11.1.1 Development Support

11.1.1.1 TINA-TI™ Simulation Software (Free Download)

TINA™ is a simple, powerful, and easy-to-use circuit simulation program based on a SPICE engine. TINA-TI™ simulation software is a free, fully-functional version of the TINA software, preloaded with a library of macro models in addition to a range of both passive and active models. TINA-TI simulation software provides all the conventional dc, transient, and frequency domain analysis of SPICE, as well as additional design capabilities.

Available as a [free download](#) from the Analog eLab Design Center, TINA-TI simulation software offers extensive post-processing capability that allows users to format results in a variety of ways. Virtual instruments offer the ability to select input waveforms and probe circuit nodes, voltages, and waveforms, creating a dynamic quick-start tool.

Note

These files require that either the TINA software or TINA-TI software be installed. Download the free TINA-TI software from the [TINA-TI software folder](#).

11.1.1.2 DIP Adapter EVM

The [DIP Adapter EVM](#) tool provides an easy, low-cost way to prototype small, surface-mount integrated circuits (ICs). The EVM includes footprint options for the following TI packages:

- D or U (SOIC-8)
- PW (TSSOP-8)
- DGK (VSSOP-8)
- DBV (SOT23-6, SOT23-5 and SOT23-3)
- DCK (SC70-6 and SC70-5)
- DRL (SOT563-6)

The DIP Adapter EVM may also be used with terminal strips or may be wired directly to existing circuits.

11.1.1.3 Universal Operational Amplifier EVM

The [Universal Op Amp evaluation module \(EVM\)](#) is a series of general-purpose, blank circuit boards that simplify prototyping circuits for a variety of IC package types. The EVM board design allows many different circuits to be constructed easily and quickly. Five models are offered, with each model intended for a specific package type. The PDIP, SOIC, VSSOP, TSSOP, and SOT-23 packages are all supported.

Note

These boards are unpopulated, so users must provide their own ICs. TI recommends requesting several op amp device samples when ordering the Universal Op Amp EVM.

11.1.1.4 TI Precision Designs

[TI Precision Designs](#) are analog solutions created by TI's precision analog applications experts. These designs offer the theory of operation, component selection, simulation, complete PCB schematic and layout, bill of materials, and measured performance of many useful circuits.

11.1.1.5 WEBENCH® Filter Designer

The [WEBENCH® Filter Designer](#) is a simple, powerful, and easy-to-use active filter design program. The WEBENCH® Filter Designer lets you create optimized filter designs using a selection of TI operational amplifiers and passive components from TI's vendor partners.

Available as a web-based tool from the WEBENCH® Design Center, the WEBENCH® Filter Designer allows you to design, optimize, and simulate complete multistage active filter solutions within minutes.

11.2 Documentation Support

11.2.1 Related Documentation

The following documents are relevant to using the OPAx210 and recommended for reference. All are available for download at www.ti.com (unless otherwise noted):

- Texas Instruments, [OPA827 Low-Noise, High-Precision, JFET-Input Operational Amplifier data sheet](#)
- Texas Instruments, [OPA2x11 1.1-nV/ \$\sqrt{\text{Hz}}\$ Noise, Low-Power, Precision Operational Amplifier data sheet](#)
- Texas Instruments, [OPA210, OPA2210, OPA4210 EMI Immunity Performance technical brief](#)
- Texas Instruments, [OPA209 2.2-nV/ \$\sqrt{\text{Hz}}\$, Low-Power, 36-V Operational Amplifier data sheet](#)
- Texas Instruments, [Microcontroller PWM to 12-Bit Analog Out design guide](#)
- Texas Instruments, [Capacitive Load Drive Solution Using an Isolation Resistor design guide](#)
- Texas Instruments, [Noise Measurement Post Amp design guide](#)

11.3 Receiving Notification of Documentation Updates

To receive notification of documentation updates, navigate to the device product folder on ti.com. Click on *Subscribe to updates* to register and receive a weekly digest of any product information that has changed. For change details, review the revision history included in any revised document.

11.4 サポート・リソース

TI E2E™ サポート・フォーラムは、エンジニアが検証済みの回答と設計に関するヒントをエキスパートから迅速かつ直接得ることができる場所です。既存の回答を検索したり、独自の質問をしたりすることで、設計に必要な支援を迅速に得ることができます。

リンクされているコンテンツは、該当する貢献者により、現状のまま提供されるものです。これらは TI の仕様を構成するものではなく、必ずしも TI の見解を反映したものではありません。TI の [使用条件](#)を参照してください。

11.5 Trademarks

TINA™ is a trademark of DesignSoft, Inc.

TINA-TI™ and TI E2E™ are trademarks of Texas Instruments.

WEBENCH® is a registered trademark of Texas Instruments.

すべての商標は、それぞれの所有者に帰属します。

11.6 Electrostatic Discharge Caution



This integrated circuit can be damaged by ESD. Texas Instruments recommends that all integrated circuits be handled with appropriate precautions. Failure to observe proper handling and installation procedures can cause damage.

ESD damage can range from subtle performance degradation to complete device failure. Precision integrated circuits may be more susceptible to damage because very small parametric changes could cause the device not to meet its published specifications.

11.7 Glossary

[TI Glossary](#) This glossary lists and explains terms, acronyms, and definitions.

12 Mechanical, Packaging, and Orderable Information

The following pages include mechanical, packaging, and orderable information. This information is the most current data available for the designated devices. This data is subject to change without notice and revision of this document. For browser-based versions of this data sheet, refer to the left-hand navigation.

PACKAGING INFORMATION

Orderable Device	Status (1)	Package Type	Package Drawing	Pins	Package Qty	Eco Plan (2)	Lead finish/ Ball material (6)	MSL Peak Temp (3)	Op Temp (°C)	Device Marking (4/5)	Samples
OPA210IDBVR	ACTIVE	SOT-23	DBV	5	3000	RoHS & Green	NIPDAU	Level-2-260C-1 YEAR	-40 to 125	26T2	Samples
OPA210IDBVT	ACTIVE	SOT-23	DBV	5	250	RoHS & Green	NIPDAU	Level-2-260C-1 YEAR	-40 to 125	26T2	Samples
OPA210IDGKR	ACTIVE	VSSOP	DGK	8	2500	RoHS & Green	NIPDAU	Level-2-260C-1 YEAR	-40 to 125	2D5J	Samples
OPA210IDGKT	ACTIVE	VSSOP	DGK	8	250	RoHS & Green	NIPDAU	Level-2-260C-1 YEAR	-40 to 125	2D5J	Samples
OPA210IDR	ACTIVE	SOIC	D	8	3000	RoHS & Green	NIPDAU	Level-2-260C-1 YEAR	-40 to 125	OPA210	Samples
OPA210IDT	ACTIVE	SOIC	D	8	250	RoHS & Green	NIPDAU	Level-2-260C-1 YEAR	-40 to 125	OPA210	Samples
OPA2210ID	ACTIVE	SOIC	D	8	75	RoHS & Green	NIPDAU	Level-2-260C-1 YEAR	-40 to 125	OP2210	Samples
OPA2210IDGKR	ACTIVE	VSSOP	DGK	8	2500	RoHS & Green	NIPDAUAG SN	Level-2-260C-1 YEAR	-40 to 125	1OHQ	Samples
OPA2210IDGKT	ACTIVE	VSSOP	DGK	8	250	RoHS & Green	NIPDAUAG SN	Level-2-260C-1 YEAR	-40 to 125	1OHQ	Samples
OPA2210IDR	ACTIVE	SOIC	D	8	2500	RoHS & Green	NIPDAU	Level-2-260C-1 YEAR	-40 to 125	OP2210	Samples
OPA2210IDRGR	ACTIVE	SON	DRG	8	3000	RoHS & Green	NIPDAU	Level-1-260C-UNLIM	-40 to 125	O2210	Samples
OPA2210IDRGT	ACTIVE	SON	DRG	8	250	RoHS & Green	NIPDAU	Level-1-260C-UNLIM	-40 to 125	O2210	Samples

(1) The marketing status values are defined as follows:

ACTIVE: Product device recommended for new designs.

LIFEBUY: TI has announced that the device will be discontinued, and a lifetime-buy period is in effect.

NRND: Not recommended for new designs. Device is in production to support existing customers, but TI does not recommend using this part in a new design.

PREVIEW: Device has been announced but is not in production. Samples may or may not be available.

OBSELETE: TI has discontinued the production of the device.

(2) **RoHS:** TI defines "RoHS" to mean semiconductor products that are compliant with the current EU RoHS requirements for all 10 RoHS substances, including the requirement that RoHS substance do not exceed 0.1% by weight in homogeneous materials. Where designed to be soldered at high temperatures, "RoHS" products are suitable for use in specified lead-free processes. TI may reference these types of products as "Pb-Free".

RoHS Exempt: TI defines "RoHS Exempt" to mean products that contain lead but are compliant with EU RoHS pursuant to a specific EU RoHS exemption.

Green: TI defines "Green" to mean the content of Chlorine (Cl) and Bromine (Br) based flame retardants meet JS709B low halogen requirements of <=1000ppm threshold. Antimony trioxide based flame retardants must also meet the <=1000ppm threshold requirement.

- (3) MSL, Peak Temp. - The Moisture Sensitivity Level rating according to the JEDEC industry standard classifications, and peak solder temperature.
- (4) There may be additional marking, which relates to the logo, the lot trace code information, or the environmental category on the device.
- (5) Multiple Device Markings will be inside parentheses. Only one Device Marking contained in parentheses and separated by a "~" will appear on a device. If a line is indented then it is a continuation of the previous line and the two combined represent the entire Device Marking for that device.
- (6) Lead finish/Ball material - Orderable Devices may have multiple material finish options. Finish options are separated by a vertical ruled line. Lead finish/Ball material values may wrap to two lines if the finish value exceeds the maximum column width.

Important Information and Disclaimer:The information provided on this page represents TI's knowledge and belief as of the date that it is provided. TI bases its knowledge and belief on information provided by third parties, and makes no representation or warranty as to the accuracy of such information. Efforts are underway to better integrate information from third parties. TI has taken and continues to take reasonable steps to provide representative and accurate information but may not have conducted destructive testing or chemical analysis on incoming materials and chemicals. TI and TI suppliers consider certain information to be proprietary, and thus CAS numbers and other limited information may not be available for release.

In no event shall TI's liability arising out of such information exceed the total purchase price of the TI part(s) at issue in this document sold by TI to Customer on an annual basis.

TAPE AND REEL INFORMATION

QUADRANT ASSIGNMENTS FOR PIN 1 ORIENTATION IN TAPE



*All dimensions are nominal

Device	Package Type	Package Drawing	Pins	SPQ	Reel Diameter (mm)	Reel Width W1 (mm)	A0 (mm)	B0 (mm)	K0 (mm)	P1 (mm)	W (mm)	Pin1 Quadrant
OPA210IDBVR	SOT-23	DBV	5	3000	180.0	8.4	3.23	3.17	1.37	4.0	8.0	Q3
OPA210IDBVT	SOT-23	DBV	5	250	180.0	8.4	3.23	3.17	1.37	4.0	8.0	Q3
OPA210IDGKR	VSSOP	DGK	8	2500	330.0	12.4	5.3	3.4	1.4	8.0	12.0	Q1
OPA210IDGKT	VSSOP	DGK	8	250	180.0	12.4	5.3	3.4	1.4	8.0	12.0	Q1
OPA210IDR	SOIC	D	8	3000	330.0	12.4	6.4	5.2	2.1	8.0	12.0	Q1
OPA210IDT	SOIC	D	8	250	180.0	12.4	6.4	5.2	2.1	8.0	12.0	Q1
OPA2210IDGKR	VSSOP	DGK	8	2500	330.0	12.4	5.25	3.35	1.25	8.0	12.0	Q1
OPA2210IDGKT	VSSOP	DGK	8	250	330.0	12.4	5.25	3.35	1.25	8.0	12.0	Q1
OPA2210IDR	SOIC	D	8	2500	330.0	12.4	6.4	5.2	2.1	8.0	12.0	Q1
OPA2210IDRGR	SON	DRG	8	3000	330.0	12.4	3.3	3.3	1.1	8.0	12.0	Q2
OPA2210IDRGT	SON	DRG	8	250	180.0	12.4	3.3	3.3	1.1	8.0	12.0	Q2

TAPE AND REEL BOX DIMENSIONS

*All dimensions are nominal

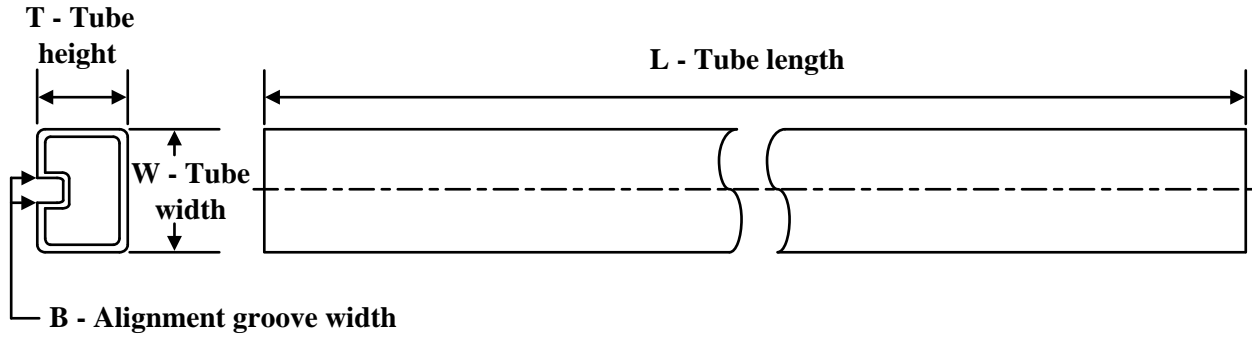
Device	Package Type	Package Drawing	Pins	SPQ	Length (mm)	Width (mm)	Height (mm)
OPA210IDBVR	SOT-23	DBV	5	3000	213.0	191.0	35.0
OPA210IDBVT	SOT-23	DBV	5	250	213.0	191.0	35.0
OPA210IDGKR	VSSOP	DGK	8	2500	356.0	356.0	35.0
OPA210IDGKT	VSSOP	DGK	8	250	210.0	185.0	35.0
OPA210IDR	SOIC	D	8	3000	356.0	356.0	35.0
OPA210IDT	SOIC	D	8	250	210.0	185.0	35.0
OPA2210IDGKR	VSSOP	DGK	8	2500	366.0	364.0	50.0
OPA2210IDGKT	VSSOP	DGK	8	250	366.0	364.0	50.0
OPA2210IDR	SOIC	D	8	2500	356.0	356.0	35.0
OPA2210IDRGR	SON	DRG	8	3000	367.0	367.0	35.0
OPA2210IDRGT	SON	DRG	8	250	210.0	185.0	35.0

TUBE

*All dimensions are nominal

Device	Package Name	Package Type	Pins	SPQ	L (mm)	W (mm)	T (μm)	B (mm)
OPA2210ID	D	SOIC	8	75	506.6	8	3940	4.32



D0008A

PACKAGE OUTLINE

SOIC - 1.75 mm max height

SMALL OUTLINE INTEGRATED CIRCUIT



4214825/C 02/2019

NOTES:

1. Linear dimensions are in inches [millimeters]. Dimensions in parenthesis are for reference only. Controlling dimensions are in inches. Dimensioning and tolerancing per ASME Y14.5M.
2. This drawing is subject to change without notice.
3. This dimension does not include mold flash, protrusions, or gate burrs. Mold flash, protrusions, or gate burrs shall not exceed $.006$ [0.15] per side.
4. This dimension does not include interlead flash.
5. Reference JEDEC registration MS-012, variation AA.

EXAMPLE BOARD LAYOUT

D0008A

SOIC - 1.75 mm max height

SMALL OUTLINE INTEGRATED CIRCUIT



LAND PATTERN EXAMPLE
 EXPOSED METAL SHOWN
 SCALE:8X



SOLDER MASK DETAILS

4214825/C 02/2019

NOTES: (continued)

- 6. Publication IPC-7351 may have alternate designs.
- 7. Solder mask tolerances between and around signal pads can vary based on board fabrication site.

EXAMPLE STENCIL DESIGN

D0008A

SOIC - 1.75 mm max height

SMALL OUTLINE INTEGRATED CIRCUIT



SOLDER PASTE EXAMPLE
BASED ON .005 INCH [0.125 MM] THICK STENCIL
SCALE:8X

4214825/C 02/2019

NOTES: (continued)

8. Laser cutting apertures with trapezoidal walls and rounded corners may offer better paste release. IPC-7525 may have alternate design recommendations.
9. Board assembly site may have different recommendations for stencil design.

DRG (S-PWSON-N8)

PLASTIC SMALL OUTLINE NO-LEAD

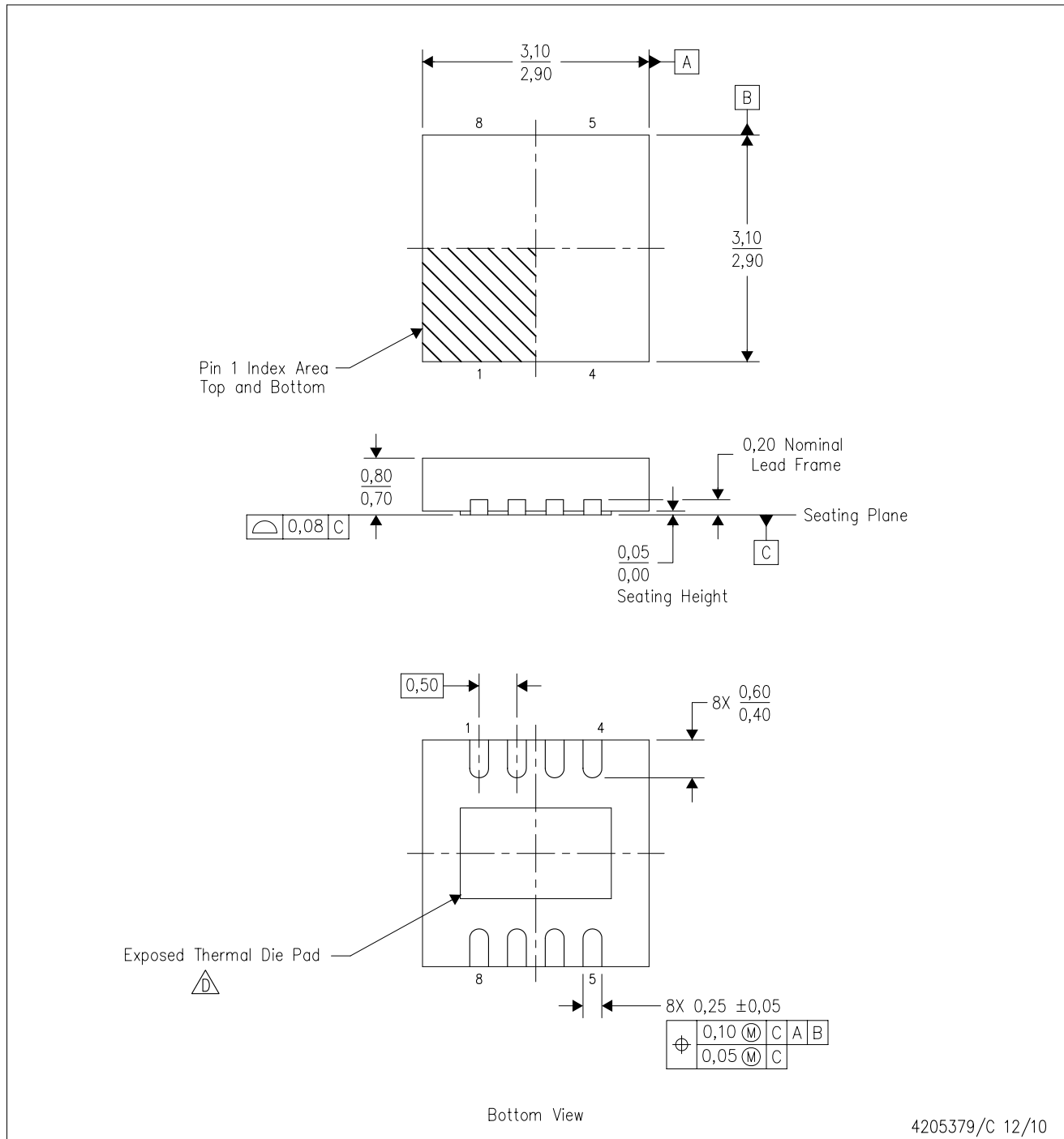

- NOTES:
- A. All linear dimensions are in millimeters. Dimensioning and tolerancing per ASME Y14.5M-1994.
 - B. This drawing is subject to change without notice.
 - C. SON (Small Outline No-Lead) package configuration.
 - D. The package thermal pad must be soldered to the board for thermal and mechanical performance. See the Product Data Sheet for details regarding the exposed thermal pad dimensions.
 - E. JEDEC MO-229 package registration pending.

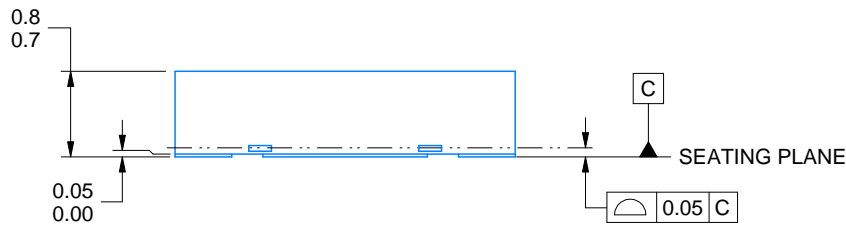
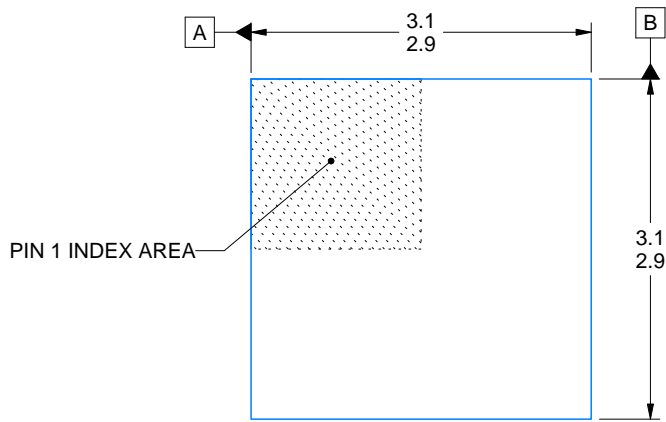
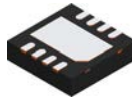

DIMENSION A	
OPTION 01	(0.1)
OPTION 02	(0.2)

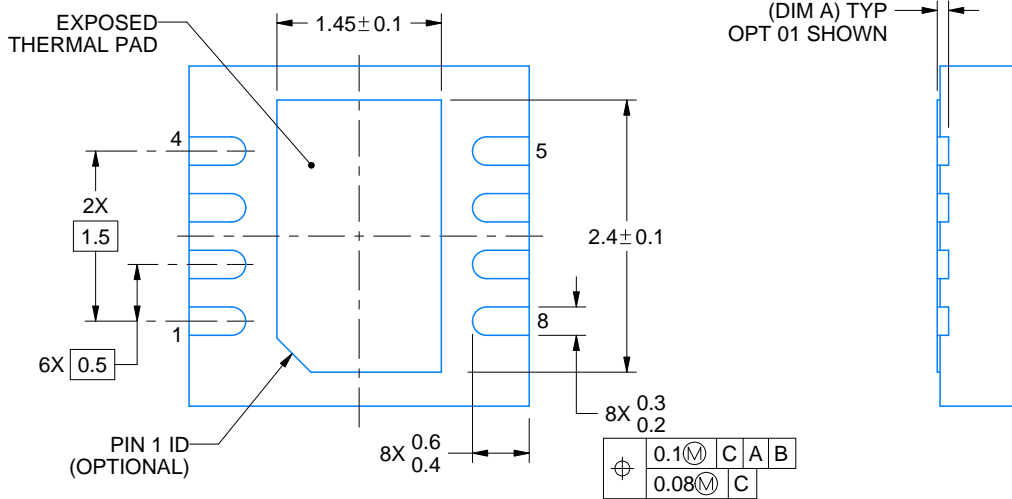

4218886/A 01/2020

NOTES:

1. All linear dimensions are in millimeters. Any dimensions in parenthesis are for reference only. Dimensioning and tolerancing per ASME Y14.5M.
2. This drawing is subject to change without notice.
3. The package thermal pad must be soldered to the printed circuit board for thermal and mechanical performance.

EXAMPLE BOARD LAYOUT

DRG0008B

WSON - 0.8 mm max height

PLASTIC SMALL OUTLINE - NO LEAD

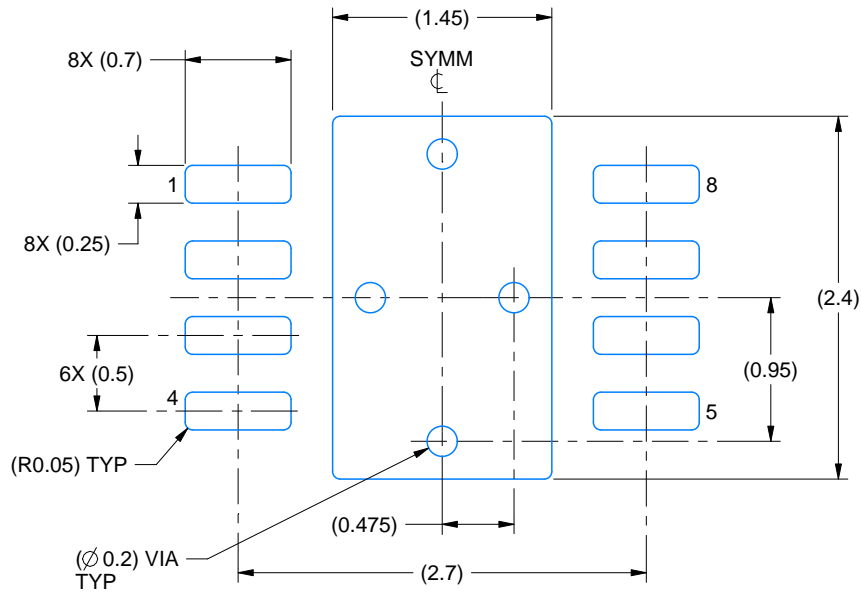

LAND PATTERN EXAMPLE
SCALE:20X

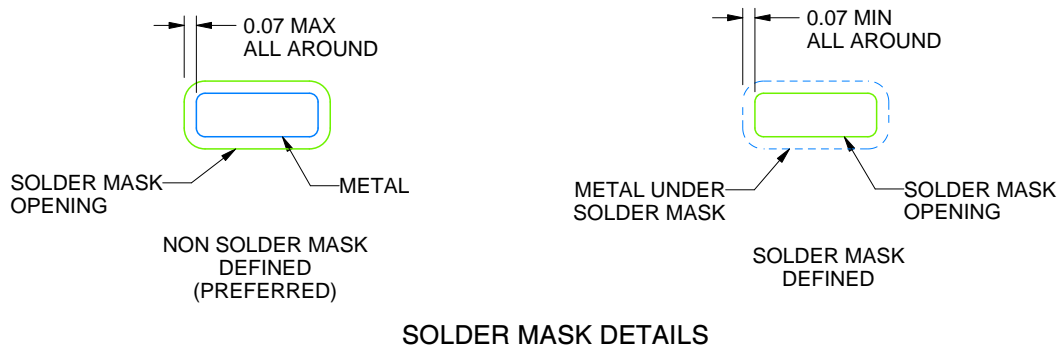

SOLDER MASK DETAILS

4218886/A 01/2020

NOTES: (continued)

4. This package is designed to be soldered to a thermal pad on the board. For more information, see Texas Instruments literature number SLUA271 (www.ti.com/lit/slua271).
5. Vias are optional depending on application, refer to device data sheet. If any vias are implemented, refer to their locations shown on this view. It is recommended that vias under paste be filled, plugged or tented.

EXAMPLE STENCIL DESIGN

DRG0008B

WSO - 0.8 mm max height

PLASTIC SMALL OUTLINE - NO LEAD

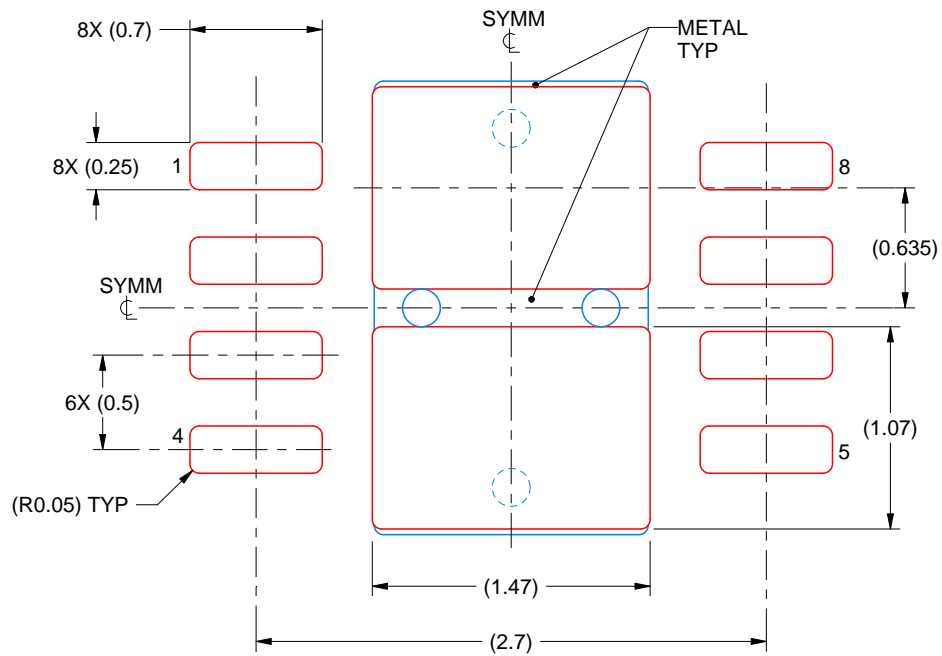

SOLDER PASTE EXAMPLE
BASED ON 0.125 mm THICK STENCIL

EXPOSED PAD
82% PRINTED SOLDER COVERAGE BY AREA
SCALE:25X

4218886/A 01/2020

NOTES: (continued)

6. Laser cutting apertures with trapezoidal walls and rounded corners may offer better paste release. IPC-7525 may have alternate design recommendations.

DBV0005A



PACKAGE OUTLINE

SOT-23 - 1.45 mm max height

SMALL OUTLINE TRANSISTOR

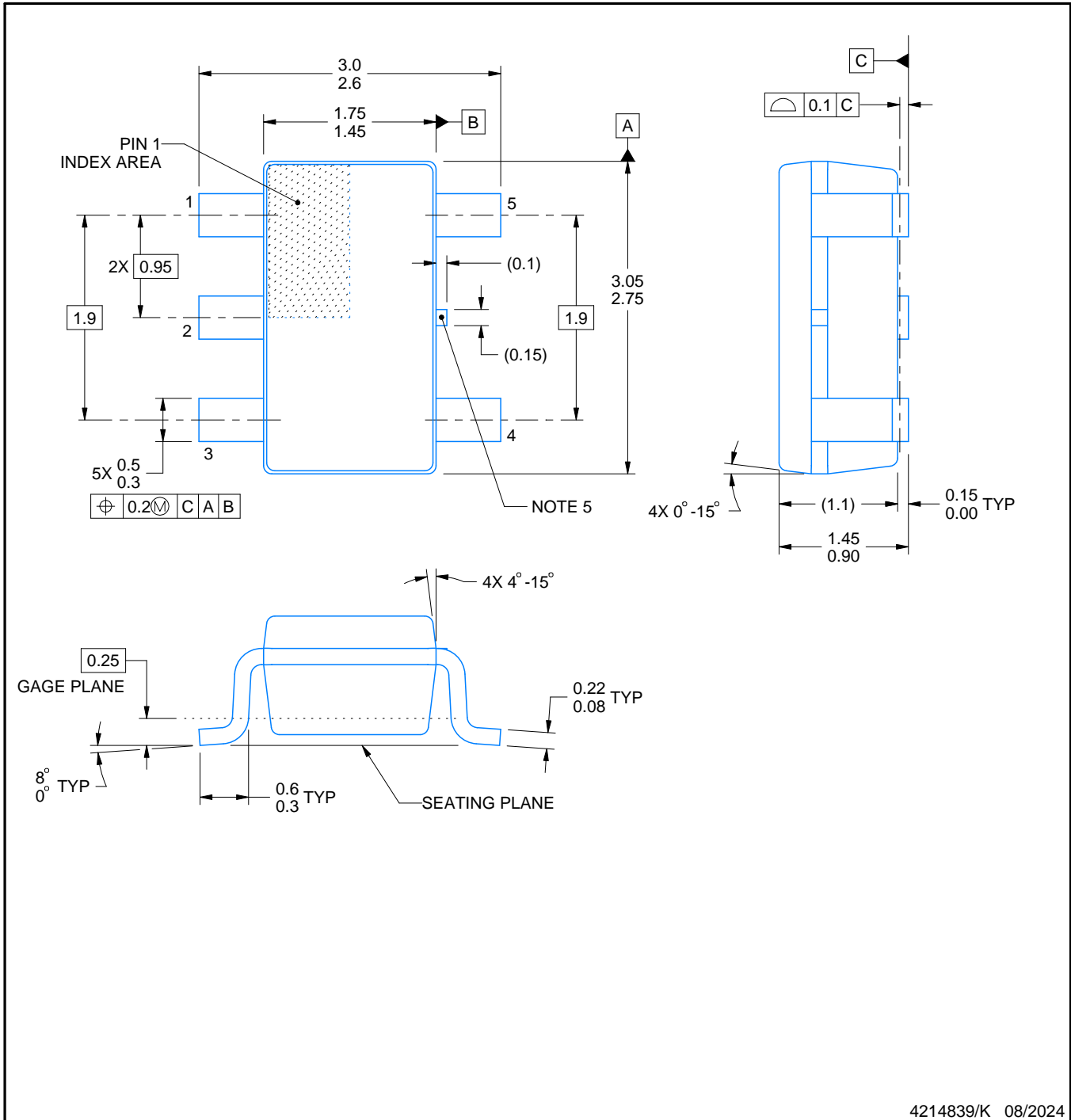

4214839/K 08/2024

NOTES:

1. All linear dimensions are in millimeters. Any dimensions in parenthesis are for reference only. Dimensioning and tolerancing per ASME Y14.5M.
2. This drawing is subject to change without notice.
3. Reference JEDEC MO-178.
4. Body dimensions do not include mold flash, protrusions, or gate burrs. Mold flash, protrusions, or gate burrs shall not exceed 0.25 mm per side.
5. Support pin may differ or may not be present.

EXAMPLE BOARD LAYOUT

DBV0005A

SOT-23 - 1.45 mm max height

SMALL OUTLINE TRANSISTOR



LAND PATTERN EXAMPLE
EXPOSED METAL SHOWN
SCALE:15X



SOLDER MASK DETAILS

4214839/K 08/2024

NOTES: (continued)

- 6. Publication IPC-7351 may have alternate designs.
- 7. Solder mask tolerances between and around signal pads can vary based on board fabrication site.

EXAMPLE STENCIL DESIGN

DBV0005A

SOT-23 - 1.45 mm max height

SMALL OUTLINE TRANSISTOR



SOLDER PASTE EXAMPLE
BASED ON 0.125 mm THICK STENCIL
SCALE:15X

4214839/K 08/2024

NOTES: (continued)

8. Laser cutting apertures with trapezoidal walls and rounded corners may offer better paste release. IPC-7525 may have alternate design recommendations.
9. Board assembly site may have different recommendations for stencil design.

DGK0008A



PACKAGE OUTLINE

VSSOP - 1.1 mm max height

SMALL OUTLINE PACKAGE



4214862/A 04/2023

NOTES:

PowerPAD is a trademark of Texas Instruments.

1. All linear dimensions are in millimeters. Any dimensions in parenthesis are for reference only. Dimensioning and tolerancing per ASME Y14.5M.
2. This drawing is subject to change without notice.
3. This dimension does not include mold flash, protrusions, or gate burrs. Mold flash, protrusions, or gate burrs shall not exceed 0.15 mm per side.
4. This dimension does not include interlead flash. Interlead flash shall not exceed 0.25 mm per side.
5. Reference JEDEC registration MO-187.

EXAMPLE BOARD LAYOUT

DGK0008A

™ VSSOP - 1.1 mm max height

SMALL OUTLINE PACKAGE

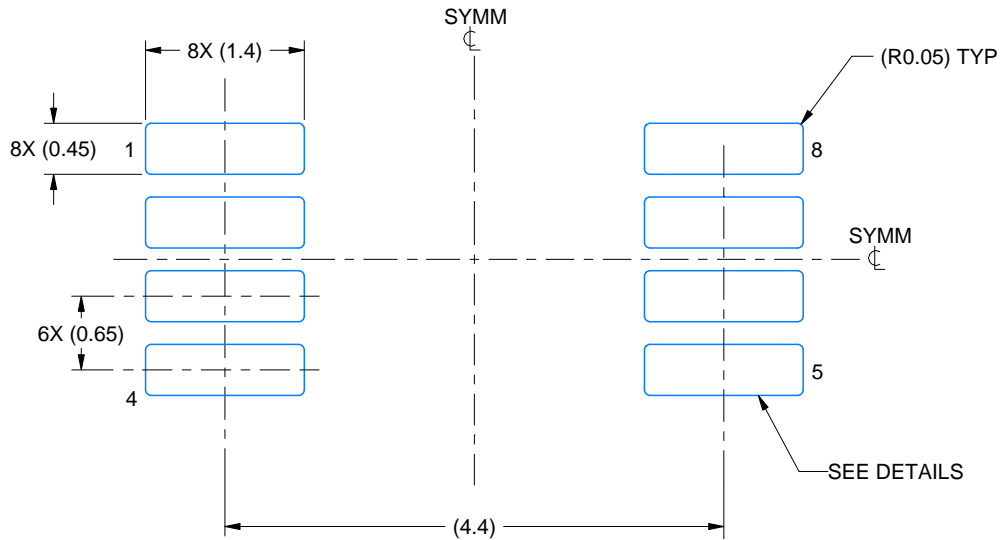

LAND PATTERN EXAMPLE
EXPOSED METAL SHOWN
SCALE: 15X

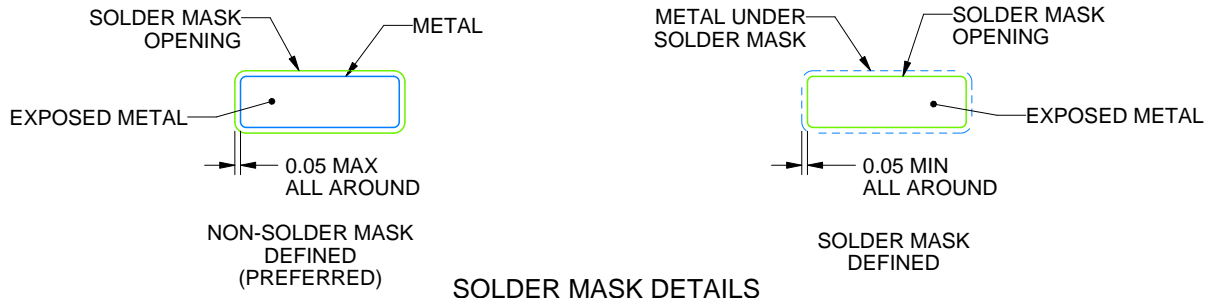

SOLDER MASK DETAILS

4214862/A 04/2023

NOTES: (continued)

6. Publication IPC-7351 may have alternate designs.
7. Solder mask tolerances between and around signal pads can vary based on board fabrication site.
8. Vias are optional depending on application, refer to device data sheet. If any vias are implemented, refer to their locations shown on this view. It is recommended that vias under paste be filled, plugged or tented.
9. Size of metal pad may vary due to creepage requirement.

EXAMPLE STENCIL DESIGN

DGK0008A

™ VSSOP - 1.1 mm max height

SMALL OUTLINE PACKAGE



SOLDER PASTE EXAMPLE
SCALE: 15X

4214862/A 04/2023

NOTES: (continued)

11. Laser cutting apertures with trapezoidal walls and rounded corners may offer better paste release. IPC-7525 may have alternate design recommendations.
12. Board assembly site may have different recommendations for stencil design.

重要なお知らせと免責事項

TI は、技術データと信頼性データ（データシートを含みます）、設計リソース（リファレンス・デザインを含みます）、アプリケーションや設計に関する各種アドバイス、Web ツール、安全性情報、その他のリソースを、欠陥が存在する可能性のある「現状のまま」提供しており、商品性および特定目的に対する適合性の黙示保証、第三者の知的財産権の非侵害保証を含むいかなる保証も、明示的または黙示的にかかわらず拒否します。

これらのリソースは、TI 製品を使用する設計の経験を積んだ開発者への提供を意図したものです。(1) お客様のアプリケーションに適した TI 製品の選定、(2) お客様のアプリケーションの設計、検証、試験、(3) お客様のアプリケーションに該当する各種規格や、その他のあらゆる安全性、セキュリティ、規制、または他の要件への確実な適合に関する責任を、お客様のみが単独で負うものとし、

上記の各種リソースは、予告なく変更される可能性があります。これらのリソースは、リソースで説明されている TI 製品を使用するアプリケーションの開発の目的でのみ、TI はその使用をお客様に許諾します。これらのリソースに関して、他の目的で複製することや掲載することは禁止されています。TI や第三者の知的財産権のライセンスが付与されている訳ではありません。お客様は、これらのリソースを自身で使用した結果発生するあらゆる申し立て、損害、費用、損失、責任について、TI およびその代理人を完全に補償するものとし、TI は一切の責任を拒否します。

TI の製品は、[TI の販売条件](#)、または [ti.com](#) やかかる TI 製品の関連資料などのいずれかを通じて提供する適用可能な条項の下で提供されています。TI がこれらのリソースを提供することは、適用される TI の保証または他の保証の放棄の拡大や変更を意味するものではありません。

お客様がいかなる追加条項または代替条項を提案した場合でも、TI はそれらに異議を唱え、拒否します。

郵送先住所：Texas Instruments, Post Office Box 655303, Dallas, Texas 75265
Copyright © 2024, Texas Instruments Incorporated