

OPAx322-Q1 20-MHz, Low-Noise, 1.8-V, RRI/O, CMOS Operational Amplifier

1 Features

- Qualified for Automotive Applications
- AEC-Q100 Qualified With the Following Results:
 - Device Temperature Grade 1: -40°C to $+125^{\circ}\text{C}$ Ambient Operating Temperature Range
 - Device HBM ESD Classification Level H3A
 - Device CDM ESD Classification Level C5
- Gain Bandwidth: 20 MHz
- Low Noise: $8.5\text{ nV}\sqrt{\text{Hz}}$ at 1 kHz
- Slew Rate: $10\text{ V}/\mu\text{s}$
- Low THD+N: 0.0005%
- Rail-to-Rail I/O
- Offset Voltage: 2 mV (Maximum)
- Supply Voltage: 1.8 V to 5.5 V
- Supply Current:
 - Single-Supply Current: 1.6 mA/ch
 - Dual-Supply Current: 1.5 mA/ch
 - Quad-Supply Current: 1.4 mA/ch
- Unity-Gain Stable
- Small Packages:
 - SOT-23, VSSOP, TSSOP

2 Applications

- Automotive
- Sensor Signal Conditioning
- Consumer Audio
- Multi-Pole Active Filters
- Control-Loop Amplifiers
- Communications
- Security
- Scanners

3 Description

The OPAx322-Q1 series consists of single-, dual-, and quad-channel CMOS operational amplifiers featuring low noise and rail-to-rail inputs and outputs optimized for low-power, single-supply applications. Specified over a wide supply range from 1.8 V to 5.5 V, the low quiescent current of only 1.5 mA per channel makes these devices well-suited for power-sensitive applications.

The combination of very-low noise ($8.5\text{ nV}\sqrt{\text{Hz}}$ at 1 kHz), high-gain bandwidth (20 MHz), and fast slew rate ($10\text{ V}/\mu\text{s}$) make the OPAx322-Q1 family ideal for a wide range of applications, including signal conditioning and sensor amplification requiring high gains. Featuring low THD+N, the OPAx322-Q1 family is also excellent for consumer audio applications, particularly for single-supply systems.

The OPA322-Q1 (single version) is available in 5-pin SOT-23 package, while the OPA2322-Q1 (dual version) is offered in a 8-pin VSSOP package. The OPA4322-Q1 (quad version) is available in a 14-pin TSSOP package. All versions are specified for operation from -40°C to $+125^{\circ}\text{C}$.

Device Information⁽¹⁾

PART NUMBER	PACKAGE	BODY SIZE (NOM)
OPA322-Q1	SOT-23 (5)	2.90 mm × 1.60 mm
OPA2322-Q1	VSSOP (8)	3.00 mm × 3.00 mm
OPA4322-Q1	TSSOP (14)	5.00 mm × 4.40 mm

(1) For all available packages, see the orderable addendum at the end of the data sheet.

Zero-Crossover Rail-to-Rail Input Stage Eliminates Distortion

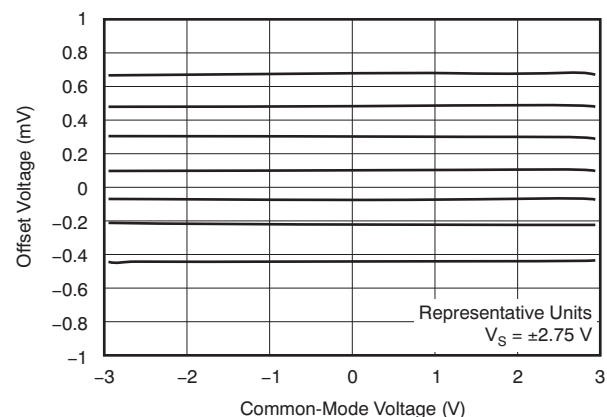

Table of Contents

1 Features	1	8.4 Device Functional Modes	20
2 Applications	1	9 Application and Implementation	21
3 Description	1	9.1 Application Information	21
4 Revision History	2	9.2 Typical Application	22
5 Pin Configuration and Functions	4	10 Power Supply Recommendations	23
6 Specifications	7	11 Layout	24
6.1 Absolute Maximum Ratings	7	11.1 Layout Guidelines	24
6.2 ESD Ratings	7	11.2 Layout Example	24
6.3 Recommended Operating Conditions	7	12 Device and Documentation Support	25
6.4 Thermal Information: OPA322-Q1	8	12.1 Device Support	25
6.5 Thermal Information: OPA2322-Q1	8	12.2 Documentation Support	26
6.6 Thermal Information: OPA4322-Q1	8	12.3 Related Links	26
6.7 Electrical Characteristics	9	12.4 Receiving Notification of Documentation Updates	26
7 Typical Characteristics	11	12.5 Community Resources	26
8 Detailed Description	16	12.6 Trademarks	27
8.1 Overview	16	12.7 Electrostatic Discharge Caution	27
8.2 Functional Block Diagram	16	12.8 Glossary	27
8.3 Feature Description	16	13 Mechanical, Packaging, and Orderable Information	28

4 Revision History

NOTE: Page numbers for previous revisions may differ from page numbers in the current version.

Changes from Revision A (June 2013) to Revision B	Page
• Updated data sheet text to the latest documentation and translation standards	1
• Deleted "x" device marking and "with shutdown" from document title	1
• Deleted "Shutdown: 0.1 μ A/ch" from <i>Features</i> list	1
• Deleted SON package from <i>Features</i> list	1
• Deleted OPA322S-Q1, OPA2322S-Q1, OPA4322S-Q1 devices from data sheet	1
• Changed single-supply current from 1.5 mA/ch to 1.6 mA/ch in <i>Features</i> section	1
• Changed quad-supply current from 1.5 ma/ch to 1.4 ma/ch in <i>Features</i> section	1
• Deleted "x" device marking, 6-pin SOT-23, 16-pin TSSOP, 10-pin VSSOP, 8-pin SOIC, 8-pin SON packages and shutdown text from <i>Description</i> section	1
• Deleted OPA322S-Q1, OPA2322S-Q1, and OPA4322S-Q1 devices from <i>Device Information</i> table	1
• Deleted 8-pin SOIC and 8-pin SON packages from <i>Device Information</i> table	1
• Deleted OPA322S-Q1 pinout drawing and pin table information in <i>Pin Configuration and Functions</i> section	4
• Deleted OPA2322-Q1 DRG package pinout drawing in <i>Pin Configuration and Functions</i> section	4
• Deleted OPA2322S-Q1 pinout drawing and table information in <i>Pin Configuration and Functions</i> section	4
• Deleted OPA4322S-Q1 pinout drawing and table information in <i>Pin Configuration and Functions</i> section	4
• Updated OPA2322-Q1 pinout tables in <i>Pin Configuration and Functions</i> section	5
• Updated OPA4322-Q1 pinout table in <i>Pin Configuration and Functions</i> section	6
• Deleted Operating Temperature, T_A values from <i>Absolute Maximum Ratings</i> table	7
• Added automotive <i>ESD Ratings</i> table to the <i>Specifications</i> section	7
• Added <i>Recommended Operating Conditions</i> table to the <i>Specifications</i> section	7
• Deleted OPA322S-Q1 <i>Thermal Information</i> table	8
• Deleted OPA2322S-Q1 D and DRG package <i>Thermal Information</i> values	8
• Deleted OPA2322S-Q1 <i>Thermal Information</i> table values	8
• Deleted OPA4322S-Q1 <i>Thermal Information</i> table values	8

Revision History (continued)

• Deleted shutdown information from <i>Electrical Characteristics</i> table	9
• Changed typical input voltage noise value from 2.8 to 4.5 μV_{pp} in <i>Electrical Characteristics</i> table	9
• Deleted repeating Open-Loop Gain test conditions in <i>Electrical Characteristics</i> table	9
• Deleted Figure 26, Figure 27, Figure 28, and Figure 29 from <i>Typical Characteristics</i> section	11
• Updated x-axis of Figure 2	11
• Updated x-axis of Figure 5	11
• Added <i>Detailed Description</i> section and Functional Block Diagram	16
• Added <i>Feature Description</i> section	16
• Deleted shutdown text in <i>Feature Description</i> section	16
• Deleted text regarding the unity-gain stability of the OPAx322-Q1 in 1-nF capacitive loads <i>Capacitive Load and Stability</i> section	18
• Added <i>Device Functional Modes</i> section	20
• Deleted shutdown text in <i>Device Functional Modes</i> section	20
• Changed FilterPro™ link in <i>Application Information</i> section	21
• Updated Figure 35	22
• Added <i>Power Supply Recommendations</i> section	23
• Added <i>Layout</i> section	24
• Deleted <i>Leadless DFN Package</i> subsection in <i>Layout</i> section	24
• Updated Figure 37 (Layout Example).....	24
• Deleted OPA322S-Q1, OPA2322S-Q1, and OPA4322S-Q1 devices from <i>Related Links</i> table.....	26

Changes from Original (June 2013) to Revision A

Page

• Changed document status to <i>Production Data</i>	1
---	---

5 Pin Configuration and Functions

OPA322-Q1 DBV Package
 5-Pin SOT-23
 Top View

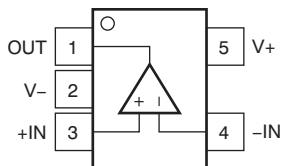

Pin Functions: OPA322-Q1

PIN		I/O	DESCRIPTION
NAME	NO.		
-IN	4	I	Inverting input
+IN	3	I	Noninverting input
OUT	1	O	Output
V-	2	—	Negative (lowest) power supply
V+	5	—	Positive (highest) power supply

**OPA2322-Q1 DGK Packages
8-Pin VSSOP
Top View**

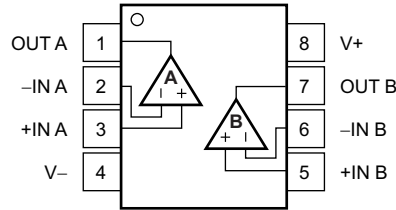

Pin Functions: OPA2322-Q1

PIN		I/O	DESCRIPTION
NAME	NO.		
-IN A	2	I	Inverting input, channel A
+IN A	3	I	Noninverting input, channel A
-IN B	6	I	Inverting input, channel B
+IN B	5	I	Noninverting input, channel B
OUT A	1	O	Output, channel A
OUT B	7	O	Output, channel B
V-	4	—	Negative (lowest) power supply
V+	8	—	Positive (highest) power supply

OPA4322-Q1 PW Package
 14-Pin TSSOP
 Top View

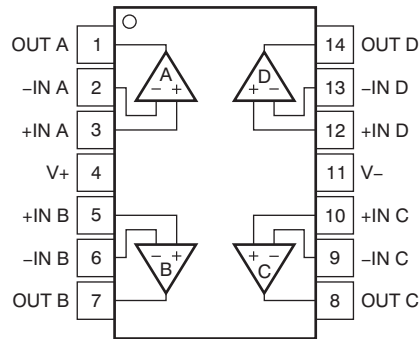

Pin Functions: OPA4322-Q1

PIN		I/O	DESCRIPTION
NAME	NO.		
-IN A	2	I	Inverting input, channel A
+IN A	3	I	Noninverting input, channel A
-IN B	6	I	Inverting input, channel B
+IN B	5	I	Noninverting input, channel B
-IN C	9	I	Inverting input, channel C
+IN C	10	I	Noninverting input, channel C
-IN D	13	I	Inverting input, channel D
+IN D	12	I	Noninverting input, channel D
OUT A	1	O	Output, channel A
OUT B	7	O	Output, channel B
OUT C	8	O	Output, channel C
OUT D	14	O	Output, channel D
V-	11	—	Negative (lowest) power supply
V+	4	—	Positive (highest) power supply

6 Specifications

6.1 Absolute Maximum Ratings

over operating free-air temperature range (unless otherwise noted)⁽¹⁾

		MIN	MAX	UNIT
Voltage	Supply voltage, $V_S = (V+) - (V-)$		6	V
	Signal input pins ⁽²⁾	$(V-) - 0.5$	$(V+) + 0.5$	V
Current	Signal input pins ⁽²⁾	-10	10	mA
	Output short-circuit ⁽³⁾	Continuous		
Temperature	Junction, T_J		150	°C
	Storage, T_{stg}	-65	150	°C

- (1) Stresses beyond those listed under *Absolute Maximum Ratings* may cause permanent damage to the device. These are stress ratings only, which do not imply functional operation of the device at these or any other conditions beyond those indicated under *Recommended Operating Conditions*. Exposure to absolute-maximum-rated conditions for extended periods may affect device reliability.
- (2) Input terminals are diode-clamped to the power-supply rails. Input signals that can swing more than 0.5 V beyond the supply rails must be current limited to 10 mA or less.
- (3) Short-circuit to ground, one amplifier per package.

6.2 ESD Ratings

		VALUE	UNIT
$V_{(ESD)}$	Electrostatic discharge	Human-body model (HBM), per AEC Q100-002 ⁽¹⁾	±4000
		Charged-device model (CDM), per AEC Q100-011	±1000

- (1) AEC Q100-002 indicates that HBM stressing shall be in accordance with the ANSI/ESDA/JEDEC JS-001 specification.

6.3 Recommended Operating Conditions

over operating free-air temperature range (unless otherwise noted)

		MIN	MAX	UNIT
V_S	Specified voltage	1.8	5.5	V
T_A	Specified temperature	-40	125	°C

6.4 Thermal Information: OPA322-Q1

THERMAL METRIC ⁽¹⁾		OPA322-Q1	
		DBV (SOT-23)	
		5 PINS	
			UNIT
$R_{\theta JA}$	Junction-to-ambient thermal resistance	219.3	°C/W
$R_{\theta JC(top)}$	Junction-to-case(top) thermal resistance	107.5	°C/W
$R_{\theta JB}$	Junction-to-board thermal resistance	57.5	°C/W
Ψ_{JT}	Junction-to-top characterization parameter	7.4	°C/W
Ψ_{JB}	Junction-to-board characterization parameter	56.9	°C/W
$R_{\theta JC(bot)}$	Junction-to-case(bottom) thermal resistance	—	°C/W

(1) For more information about traditional and new thermal metrics, see the [Semiconductor and IC Package Thermal Metrics](#) application report.

6.5 Thermal Information: OPA2322-Q1

THERMAL METRIC ⁽¹⁾		OPA2322-Q1	
		DGK (VSSOP)	
		8 PINS	
			UNIT
$R_{\theta JA}$	Junction-to-ambient thermal resistance	174.8	°C/W
$R_{\theta JC(top)}$	Junction-to-case (top) thermal resistance	43.9	°C/W
$R_{\theta JB}$	Junction-to-board thermal resistance	95	°C/W
Ψ_{JT}	Junction-to-top characterization parameter	2	°C/W
Ψ_{JB}	Junction-to-board characterization parameter	93.5	°C/W
$R_{\theta JC(bot)}$	Junction-to-case (bottom) thermal resistance	—	°C/W

(1) For more information about traditional and new thermal metrics, see the [Semiconductor and IC Package Thermal Metrics](#) application report.

6.6 Thermal Information: OPA4322-Q1

THERMAL METRIC ⁽¹⁾		OPA4322-Q1	
		PW (TSSOP)	
		14 PINS	
			UNIT
$R_{\theta JA}$	Junction-to-ambient thermal resistance	109.8	°C/W
$R_{\theta JC(top)}$	Junction-to-case(top) thermal resistance	34.9	°C/W
$R_{\theta JB}$	Junction-to-board thermal resistance	52.5	°C/W
Ψ_{JT}	Junction-to-top characterization parameter	2.2	°C/W
Ψ_{JB}	Junction-to-board characterization parameter	51.8	°C/W
$R_{\theta JC(bot)}$	Junction-to-case(bottom) thermal resistance	—	°C/W

(1) For more information about traditional and new thermal metrics, see the [Semiconductor and IC Package Thermal Metrics](#) application report.

6.7 Electrical Characteristics

at $V_S = 1.8\text{ V}$ to 5.5 V , or $\pm 0.9\text{ V}$ to $\pm 2.75\text{ V}$, $T_A = 25^\circ\text{C}$, $R_L = 10\text{ k}\Omega$ connected to $V_S / 2$, $V_{CM} = V_S / 2$, $V_{OUT} = V_S / 2$, (unless otherwise noted)

PARAMETER		TEST CONDITIONS	MIN	TYP	MAX	UNIT
OFFSET VOLTAGE						
V_{OS}	Input offset voltage			0.5	2	mV
dV_{OS}/dT	vs temperature	$V_S = 5.5\text{ V}$		1.8	6	$\mu\text{V}/^\circ\text{C}$
PSR	vs power supply	$V_S = 1.8\text{ V}$ to 5.5 V	$T_A = 25^\circ\text{C}$	10	50	$\mu\text{V}/\text{V}$
			$T_A = -40^\circ\text{C}$ to 125°C	20	65	
	Channel separation	at 1 kHz		130		dB
INPUT VOLTAGE						
V_{CM}	Common-mode voltage range		$(V-) - 0.1$		$(V+) + 0.1$	V
CMRR	Common-mode rejection ratio	$(V-) - 0.1\text{ V} < V_{CM} < (V+) + 0.1\text{ V}$	$T_A = 25^\circ\text{C}$	90	100	dB
			$T_A = -40^\circ\text{C}$ to 125°C	90		
INPUT BIAS CURRENT						
I_B	Input bias current		$T_A = 25^\circ\text{C}$	± 0.2	± 10	pA
			$T_A = -40^\circ\text{C}$ to 85°C		± 50	
			OPA322-Q1: $T_A = -40^\circ\text{C}$ to 125°C		± 800	
			OPA2322-Q1: $T_A = -40^\circ\text{C}$ to 125°C		± 400	
			OPA4322-Q1: $T_A = -40^\circ\text{C}$ to 125°C		± 400	
I_{OS}	Input offset current		$T_A = 25^\circ\text{C}$	± 0.2	± 10	pA
			$T_A = -40^\circ\text{C}$ to 85°C		± 50	
			$T_A = -40^\circ\text{C}$ to 125°C		± 400	
NOISE						
	Input voltage noise	$f = 0.1\text{ Hz}$ to 10 Hz		4.5		μV_{PP}
e_n	Input voltage noise density	$f = 1\text{ kHz}$		8.5		$\text{nV}/\sqrt{\text{Hz}}$
		$f = 10\text{ kHz}$		7		
i_n	Input current noise density	$f = 1\text{ kHz}$		0.6		$\text{fA}/\sqrt{\text{Hz}}$
INPUT CAPACITANCE						
	Differential			5		pF
	Common-mode			4		pF
OPEN-LOOP GAIN						
A_{OL}	Open-loop voltage gain	$0.1\text{ V} < V_O < (V+) - 0.1\text{ V}$ $R_L = 10\text{ k}\Omega$	100	130		dB
PM	Phase margin	$V_S = 5\text{ V}$ $C_L = 50\text{ pF}$		47		$^\circ$
FREQUENCY RESPONSE						
GBP	Gain bandwidth product	$V_S = 5\text{ V}$ $C_L = 50\text{ pF}$, unity gain		20		MHz
SR	Slew rate	$V_S = 5\text{ V}$ $C_L = 50\text{ pF}$, $G = 1$		10		$\text{V}/\mu\text{s}$
t_s	Settling time	$V_S = 5\text{ V}$ $C_L = 50\text{ pF}$, to 0.1%, 2-V step, $G = 1$		0.25		μs
			$V_S = 5\text{ V}$ $C_L = 50\text{ pF}$, to 0.01%, 2-V step, $G = 1$		0.32	
	Overload recovery time	$V_S = 5\text{ V}$ $C_L = 50\text{ pF}$ $V_{IN} \times G > V_S$		100		ns
THD+N	Total harmonic distortion + noise ⁽¹⁾	$V_S = 5\text{ V}$ $C_L = 50\text{ pF}$ $V_O = 4\text{ V}_{PP}$, $G = 1$, $f = 10\text{ kHz}$ $R_L = 10\text{ k}\Omega$		0.0005%		
			$V_S = 5\text{ V}$, $C_L = 50\text{ pF}$, $V_O = 2\text{ V}_{PP}$, $G = 1$, $f = 10\text{ kHz}$ $R_L = 600\ \Omega$		0.0011%	

(1) Third-order filter; bandwidth = 80 kHz at -3 dB

Electrical Characteristics (continued)

at $V_S = 1.8\text{ V to }5.5\text{ V}$, or $\pm 0.9\text{ V to } \pm 2.75\text{ V}$, $T_A = 25^\circ\text{C}$, $R_L = 10\text{ k}\Omega$ connected to $V_S / 2$, $V_{CM} = V_S / 2$, $V_{OUT} = V_S / 2$, (unless otherwise noted)

PARAMETER		TEST CONDITIONS		MIN	TYP	MAX	UNIT
OUTPUT							
V_O	Voltage output (swing from both rails)	$R_L = 10\text{ k}\Omega$	$T_A = 25^\circ\text{C}$		10	20	mV
			$T_A = -40^\circ\text{C to }125^\circ\text{C}$			30	
I_{SC}	Short-circuit current	$V_S = 5.5\text{ V}$			± 65		mA
C_L	Capacitive load drive			See Typical Characteristics			
R_O	Open-loop output resistance	$I_O = 0\text{ mA}$ $f = 1\text{ MHz}$			90		Ω
POWER SUPPLY							
V_S	Specified voltage range			1.8		5.5	V
I_Q	Quiescent current per amplifier	OPA322-Q1: $I_O = 0\text{ mA}$ $V_S = 5.5\text{ V}$	$T_A = 25^\circ\text{C}$		1.6	1.9	mA
			$T_A = -40^\circ\text{C to }125^\circ\text{C}$			2	
		OPA2322-Q1: $I_O = 0\text{ mA}$ $V_S = 5.5\text{ V}$	$T_A = 25^\circ\text{C}$		1.5	1.75	
			$T_A = -40^\circ\text{C to }125^\circ\text{C}$			1.85	
		OPA4322-Q1: $I_O = 0\text{ mA}$ $V_S = 5.5\text{ V}$	$T_A = 25^\circ\text{C}$		1.4	1.65	
			$T_A = -40^\circ\text{C to }125^\circ\text{C}$			1.75	
	Power-on time	$V_{S\ddagger} = 0\text{ V to }5\text{ V}$, to 90% I_Q level			28		μs

7 Typical Characteristics

at $T_A = 25^\circ\text{C}$, $V_{CM} = V_{OUT} = \text{midsupply}$, and $R_L = 10\text{ k}\Omega$ (unless otherwise noted)

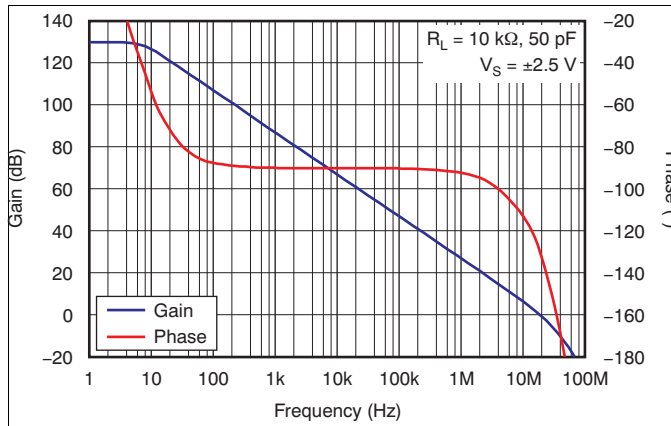

Figure 1. Open-Loop Gain and Phase vs Frequency

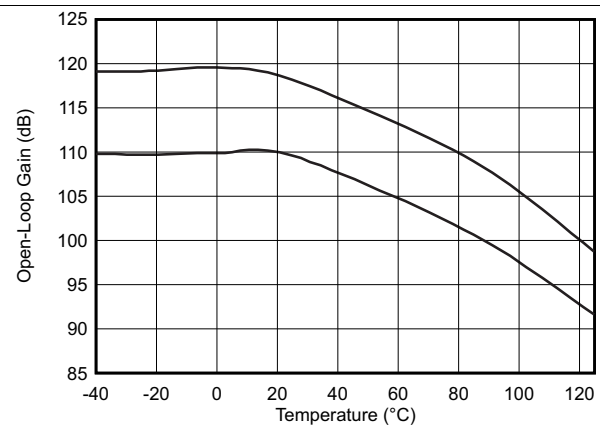

Figure 2. Open-Loop Gain vs Temperature

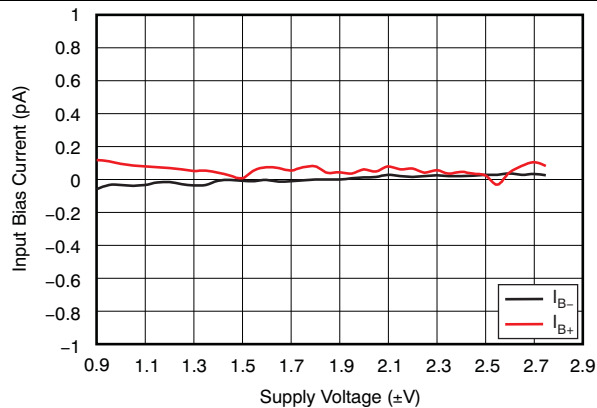

Figure 3. Input Bias Current vs Supply Voltage

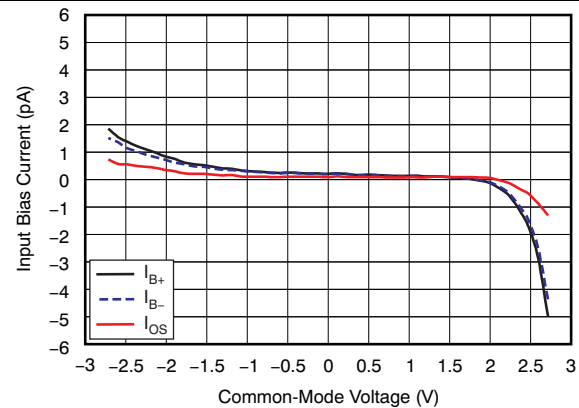

Figure 4. Input Bias Current vs Common-Mode Voltage

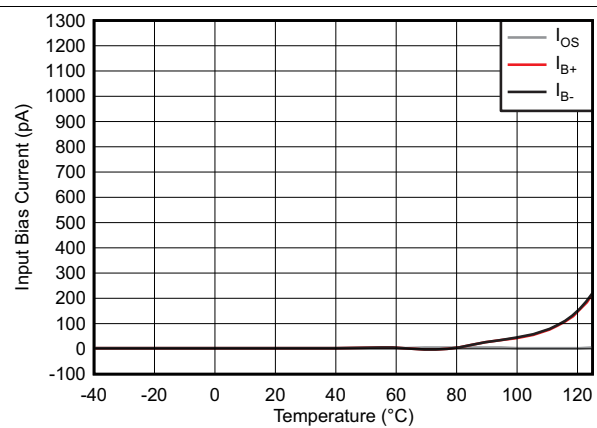

Figure 5. Input Bias Current vs Temperature

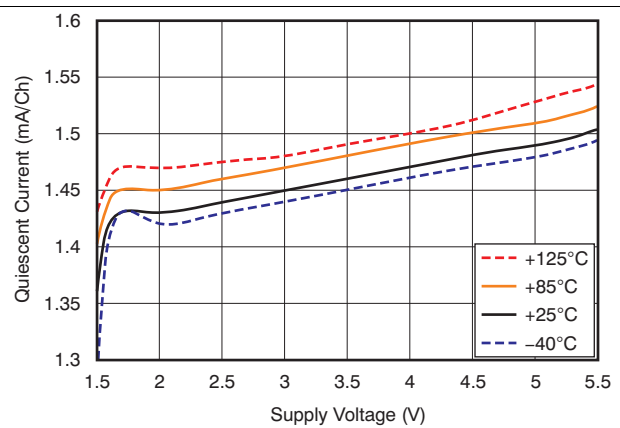
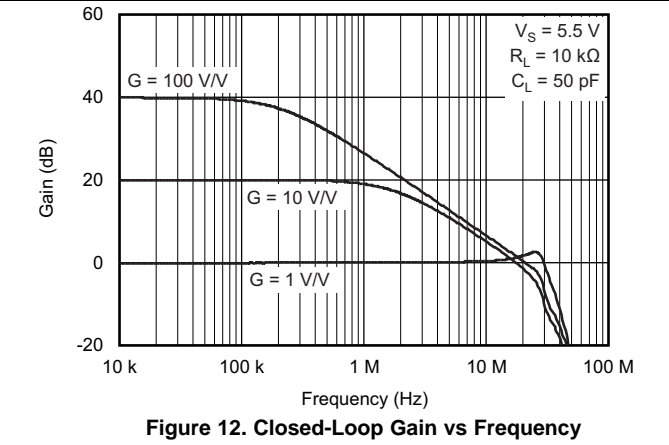
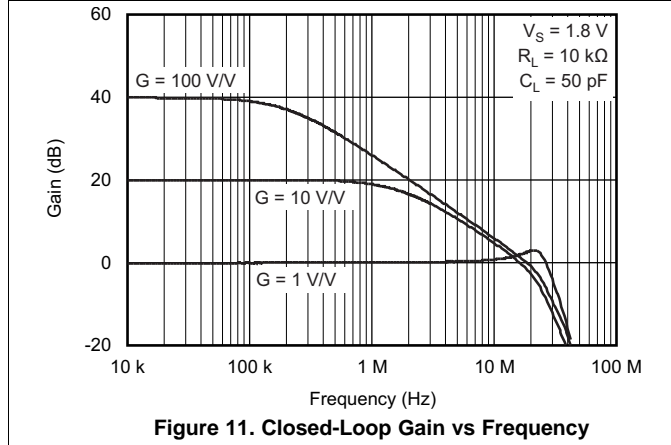
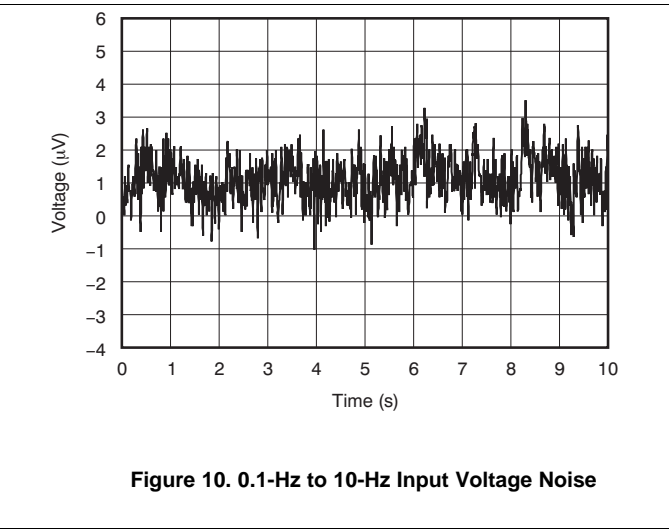
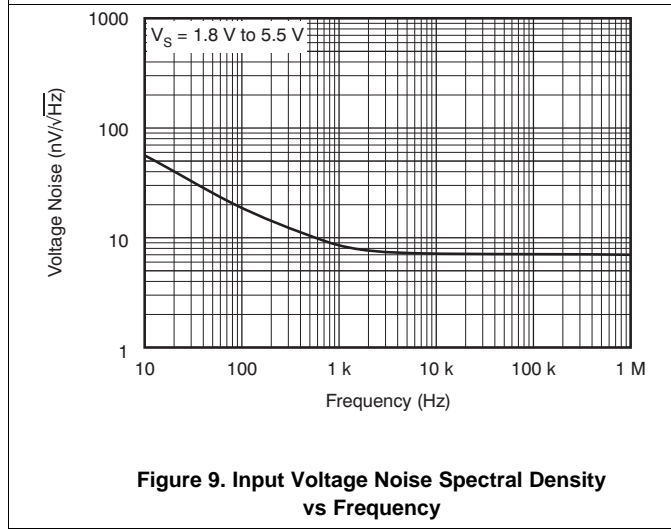
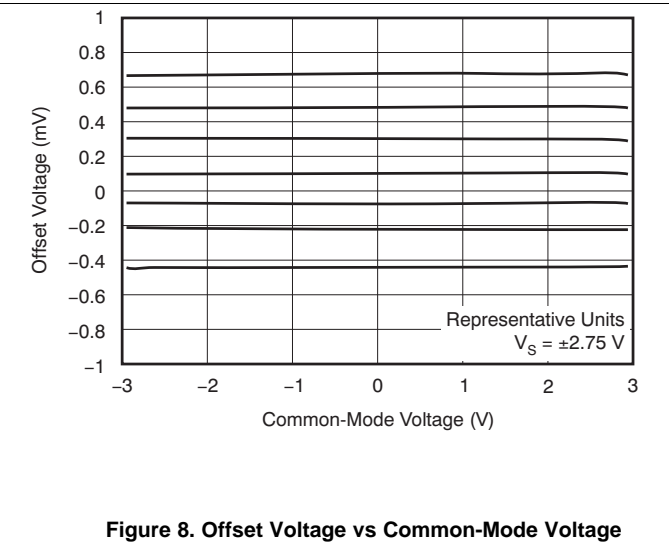
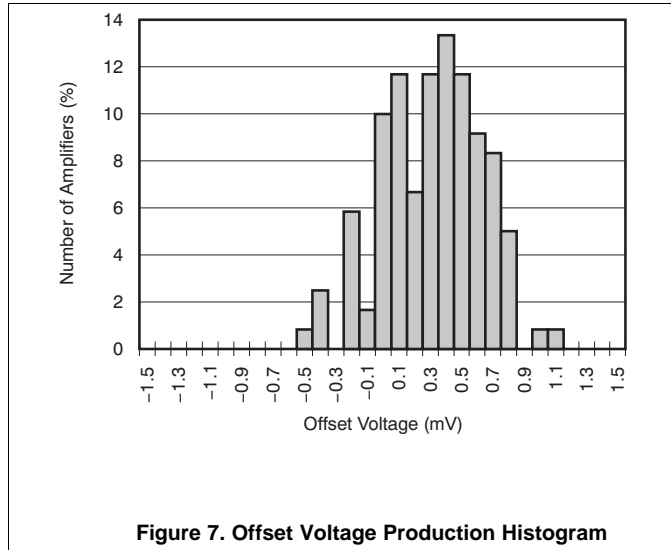

Figure 6. Quiescent Current vs Supply Voltage Per Amplifier

Typical Characteristics (continued)

at $T_A = 25^\circ\text{C}$, $V_{CM} = V_{OUT} = \text{midsupply}$, and $R_L = 10\text{ k}\Omega$ (unless otherwise noted)



Typical Characteristics (continued)

at $T_A = 25^\circ\text{C}$, $V_{CM} = V_{OUT} = \text{midsupply}$, and $R_L = 10\text{ k}\Omega$ (unless otherwise noted)

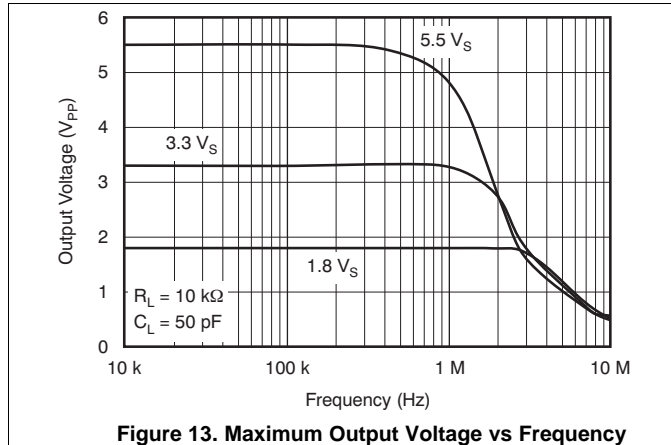

Figure 13. Maximum Output Voltage vs Frequency

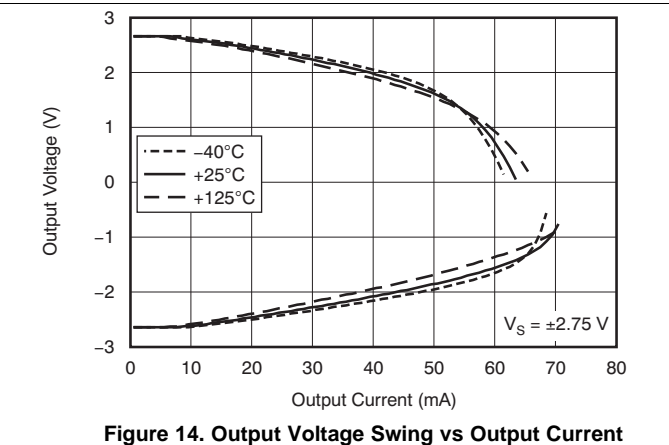

Figure 14. Output Voltage Swing vs Output Current

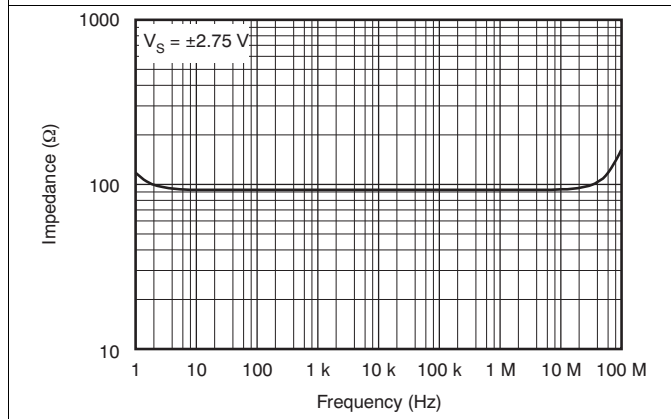

Figure 15. Open-Loop Output Impedance vs Frequency

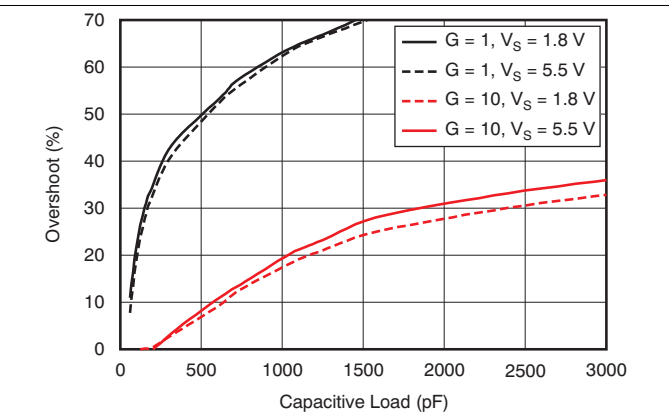

Figure 16. Small-Signal Overshoot vs Load Capacitance

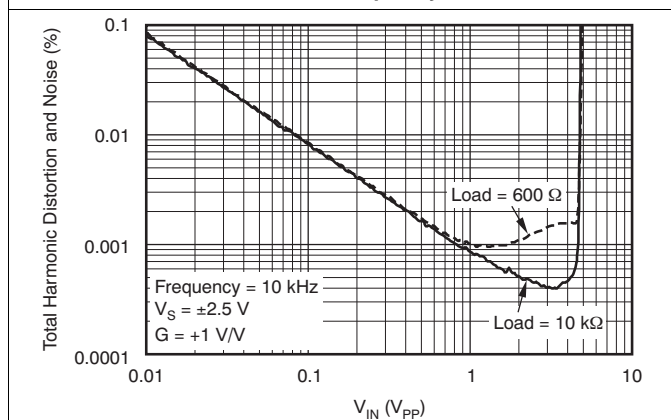

Figure 17. THD+N vs Amplitude

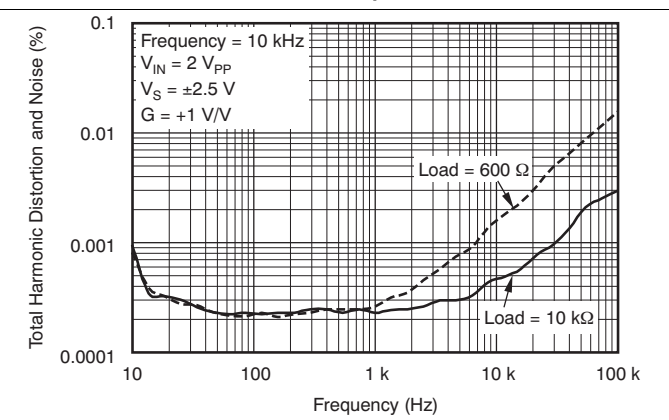
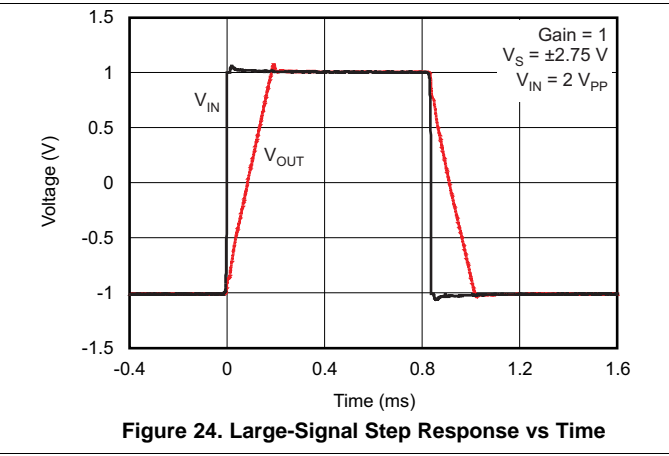
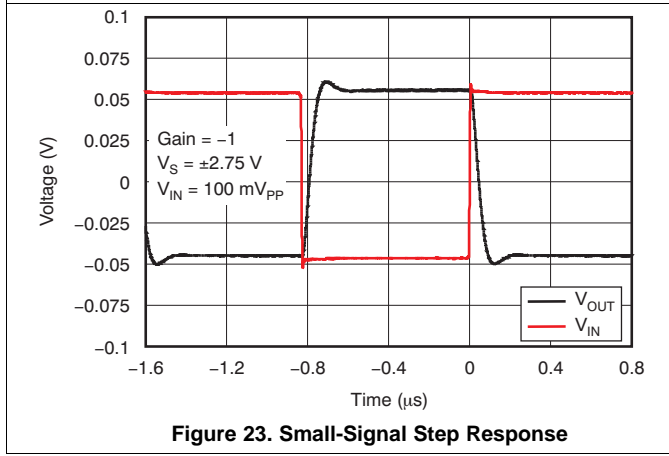
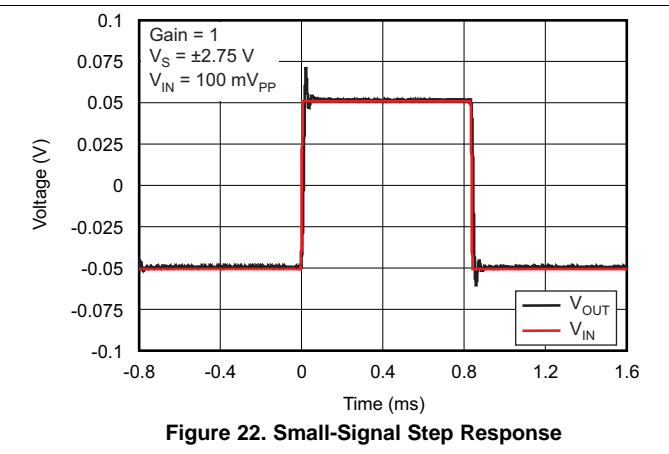
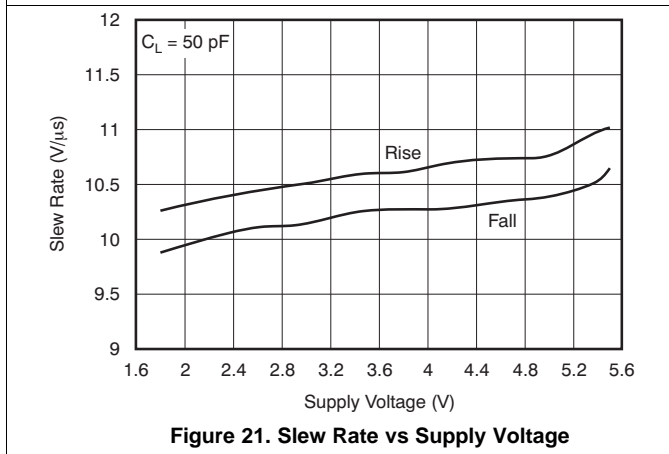
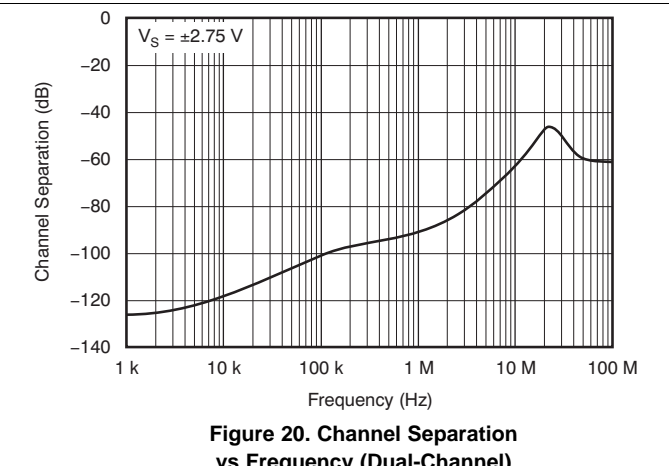
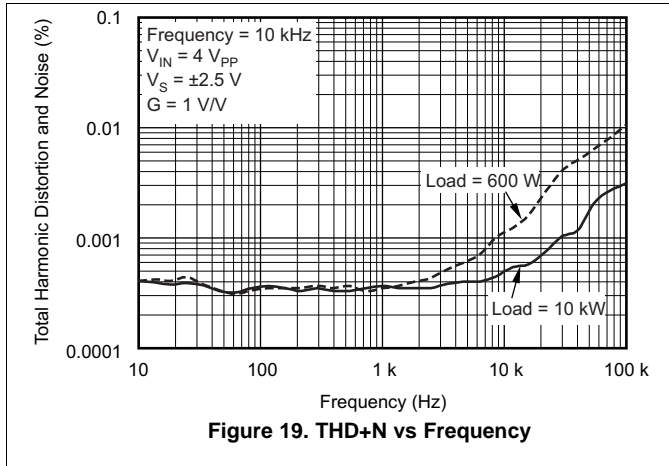

Figure 18. THD+N vs Frequency

Typical Characteristics (continued)

at $T_A = 25^\circ\text{C}$, $V_{CM} = V_{OUT} = \text{midsupply}$, and $R_L = 10\text{ k}\Omega$ (unless otherwise noted)



Typical Characteristics (continued)

at $T_A = 25^\circ\text{C}$, $V_{CM} = V_{OUT} = \text{midsupply}$, and $R_L = 10\text{ k}\Omega$ (unless otherwise noted)

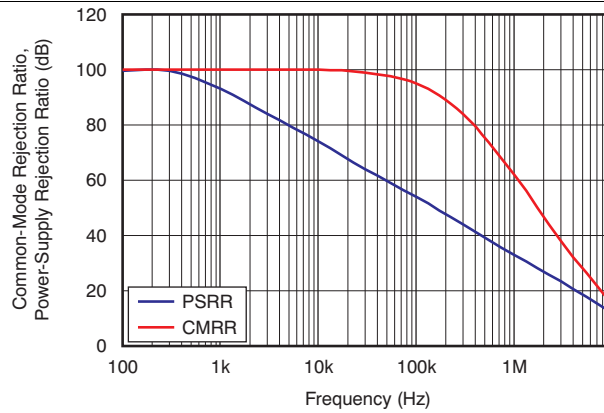

Figure 25. CMRR and PSRR vs Frequency

8 Detailed Description

8.1 Overview

The OPAx322-Q1 family of operational amplifiers (op amps) are high-speed precision amplifiers well-suited to drive 12-, 14-, and 16-bit analog-to-digital converters. Low-output impedance with flat frequency characteristics and zero-crossover distortion circuitry enable high linearity over the full input common-mode range, achieving true rail-to-rail input from a 1.8-V to 5.5-V single-supply.

8.2 Functional Block Diagram

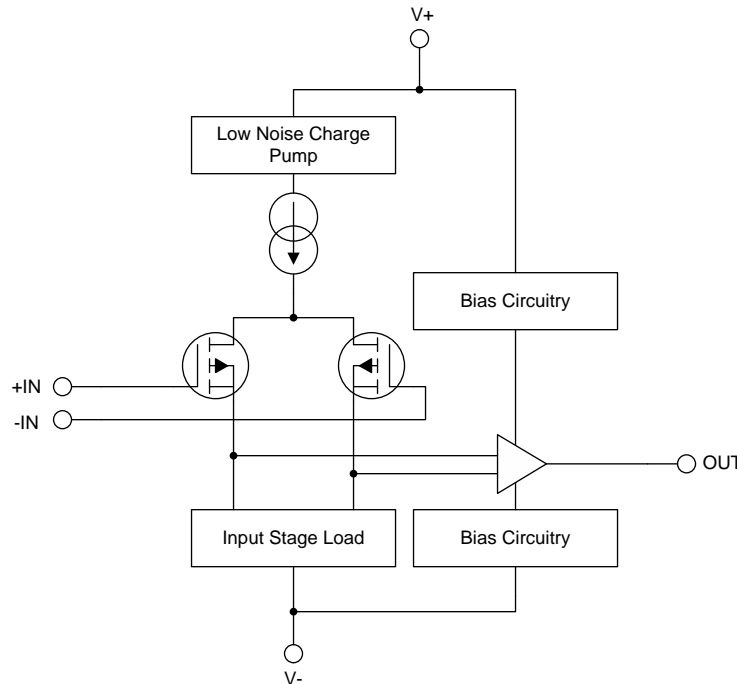

Copyright © 2016, Texas Instruments Incorporated

8.3 Feature Description

8.3.1 Operating Voltage

The OPAx322-Q1 series op amps are unity-gain stable and can operate on a single-supply voltage (1.8 V to 5.5 V), or a split-supply voltage (± 0.9 V to ± 2.75 V), which makes the op amps highly versatile and easy to use. The power-supply pins must have local bypass ceramic capacitors (typically 0.001 μ F to 0.1 μ F). These amplifiers are fully specified from 1.8 V to 5.5 V and over the extended temperature range from -40°C to $+125^{\circ}\text{C}$. Parameters that can exhibit variance with regard to operating voltage or temperature are presented in [Typical Characteristics](#).

8.3.2 Input and ESD Protection

The OPAx322-Q1 incorporates internal electrostatic discharge (ESD) protection circuits on all pins. In the case of input and output pins, this protection primarily consists of current-steering diodes connected between the input and power-supply pins. These ESD protection diodes also provide in-circuit input overdrive protection, as long as the current is limited to 10 mA as stated in [Absolute Maximum Ratings](#). Many input signals are inherently current-limited to less than 10 mA; therefore, a limiting resistor is not required. [Figure 26](#) shows how a series input resistor (R_S) may be added to the driven input to limit the input current. The added resistor contributes thermal noise at the amplifier input and the value must be kept to the minimum in noise-sensitive applications.

Feature Description (continued)

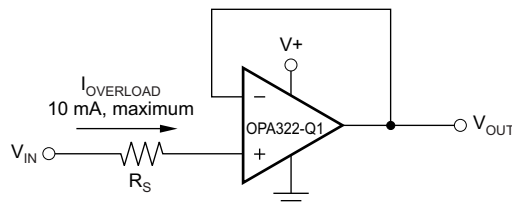

Copyright © 2016, Texas Instruments Incorporated

Figure 26. Input Current Protection

8.3.3 Phase Reversal

The OPAx322-Q1 family of op amps are designed to be immune to phase reversal when the input pins exceed the supply voltages, which provides further in-system stability and predictability. Figure 27 shows the input voltage exceeding the supply voltage without any phase reversal.

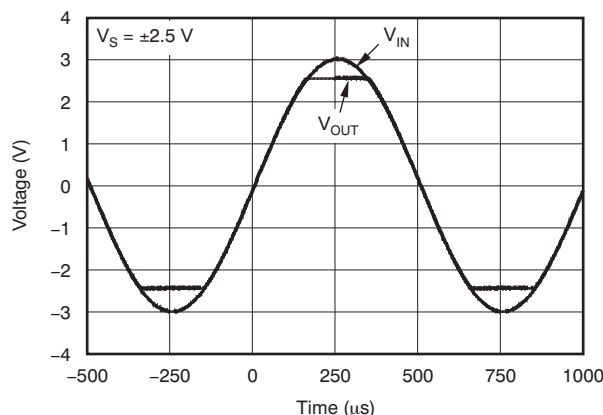
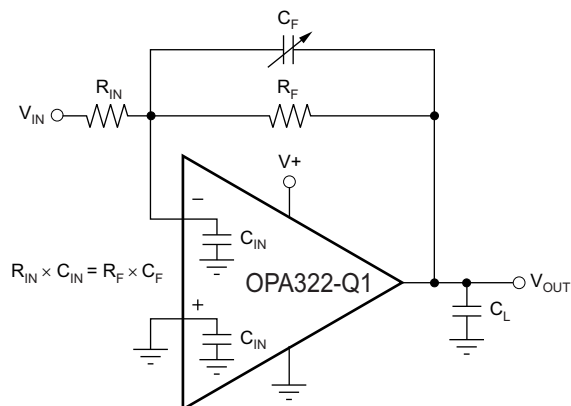

Figure 27. No Phase Reversal

8.3.4 Feedback Capacitor Improves Response

For optimum settling time and stability with high-impedance feedback networks, it may be necessary to add a feedback capacitor across the feedback resistor (R_F), as shown in Figure 28. This capacitor compensates for the zero created by the feedback network impedance and the OPAx322-Q1 input capacitance (and any parasitic layout capacitance). The effect becomes more significant with higher impedance networks.



Copyright © 2016, Texas Instruments Incorporated

NOTE: Where C_{IN} is equal to the OPAx322-Q1 input capacitance (approximately 9 pF) plus any parasitic layout capacitance.

Figure 28. Feedback Capacitor Improves Dynamic Performance

Feature Description (continued)

For the circuit shown in [Figure 28](#), the value of the variable feedback capacitor must be selected so that the input resistance times the input capacitance of the OPAx322-Q1 (typically 9 pF) plus the estimated parasitic layout capacitance equals the feedback capacitor times the feedback resistor with [Equation 1](#).

$$R_{IN} \times C_{IN} = R_F \times C_F$$

where

- C_{IN} is equal to the OPAx322-Q1 input capacitance (sum of differential and common-mode) plus the layout capacitance (1)

The capacitor value can be adjusted until optimum performance is obtained.

8.3.5 EMI Susceptibility and Input Filtering

Operational amplifiers vary in susceptibility to electromagnetic interference (EMI). If conducted EMI enters the device, the DC offset observed at the amplifier output may shift from the nominal value while EMI is present. This shift is a result of signal rectification associated with the internal semiconductor junctions. While all operational amplifier pin functions can be affected by EMI, the input pins are likely to be the most susceptible. The OPAx322-Q1 operational amplifier family incorporates an internal input low-pass filter that reduces the amplifier response to EMI. Both common-mode and differential mode filtering are provided by the input filter. The filter is designed for a cutoff frequency of approximately 580 MHz (–3 dB), with a roll-off of 20 dB per decade.

8.3.6 Output Impedance

The open-loop output impedance of the OPAx322-Q1 common-source output stage is approximately 90 Ω . When the op amp is connected with feedback, the loop gain significantly reduces this value. For each decade rise in the closed-loop gain, the loop gain is reduced by the same amount, which results in a tenfold increase in effective output impedance. While the OPAx322-Q1 output impedance remains flat over a wide frequency range. At higher frequencies the output impedance rises as the open-loop gain of the op amp drops. However, at these frequencies the output becomes capacitive as a result of parasitic capacitance. This characteristic prevents the output impedance from becoming too high, which can cause stability problems when driving large capacitive loads. As mentioned previously, the OPAx322-Q1 has excellent capacitive load drive capability for an op amp with a bandwidth of this value.

8.3.7 Capacitive Load and Stability

The OPAx322-Q1 is designed to be used in applications where driving a capacitive load is required. As with all op amps, there may be specific instances where the OPAx322-Q1 can become unstable. The particular op amp circuit configuration, layout, gain, and output loading are some of the factors to consider when establishing whether an amplifier is stable in operation. An op amp in the unity-gain (1-V/V) buffer configuration and driving a capacitive load exhibits a greater tendency to become unstable than an amplifier operating at a higher noise gain. The capacitive load, in conjunction with the op amp output resistance, creates a pole within the feedback loop that degrades the phase margin.

The equivalent series resistance (ESR) of some very large capacitors ($C_L > 1 \mu\text{F}$) is sufficient to alter the phase characteristics in the feedback loop so the amplifier remains stable. Increasing the amplifier closed-loop gain allows the amplifier to drive increasingly larger capacitance. This increased capability is evident when observing the overshoot response of the amplifier at higher voltage gains, as shown in [Figure 29](#). One technique for increasing the capacitive load drive capability of the amplifier operating in unity gain is to insert a small resistor (R_S , typically 10- Ω to 20- Ω) in series with the output, as shown in [Figure 30](#).

This resistor significantly reduces the overshoot and ringing associated with large capacitive loads. A possible problem with this technique is that a voltage divider is created with the added series resistor and any resistor connected in parallel with the capacitive load. The voltage divider introduces a gain error at the output that reduces the output swing. However, the error contributed by the voltage divider may be insignificant. For example, with a load resistance of $R_L = 10 \text{ k}\Omega$ and $R_S = 20 \Omega$, the gain error is approximately 0.2%. When R_L decreases to 600 Ω (which the OPAx322-Q1 is able to drive), the error increases to 7.5%.

Feature Description (continued)

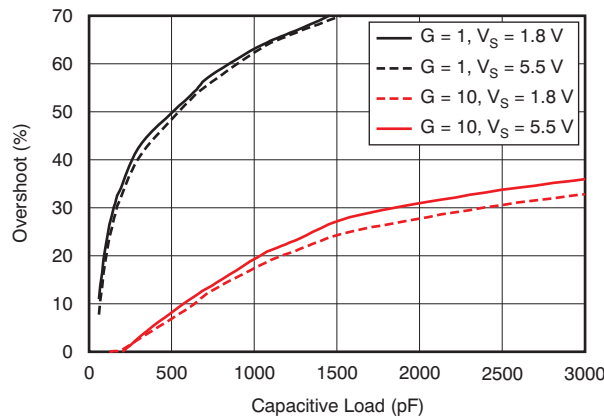
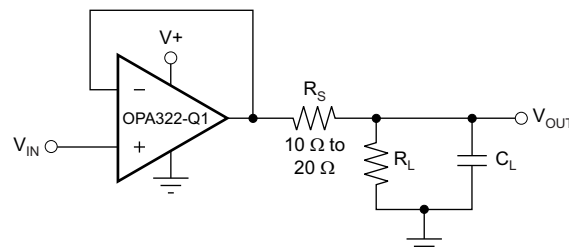

Figure 29. Small-Signal Overshoot vs Capacitive Load (100-mV_{PP} Output Step)



Copyright © 2016, Texas Instruments Incorporated

Figure 30. Improving Capacitive Load Drive

8.3.8 Overload Recovery Time

Overload recovery time is the time required for the output of the amplifier to come out of saturation and recover to the linear region. Overload recovery is particularly important in applications where small signals must be amplified in the presence of large transients. Figure 31 and Figure 32 show the positive and negative overload recovery times of the OPAx322-Q1, respectively. In both cases, the time elapsed before the OPAx322-Q1 comes out of saturation is less than 100 ns. The symmetry between the positive and negative recovery times allows excellent signal rectification without distortion of the output signal.

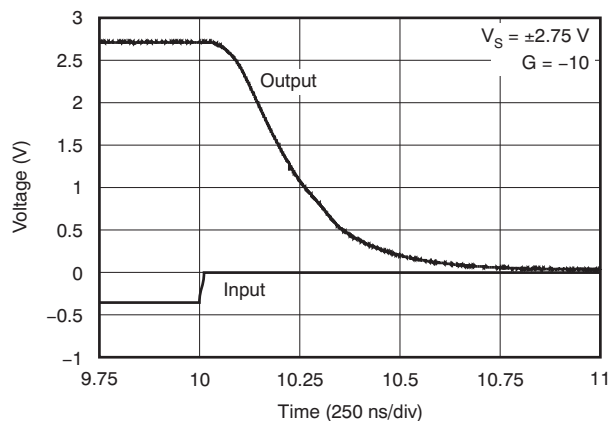

Figure 31. Positive Recovery Time

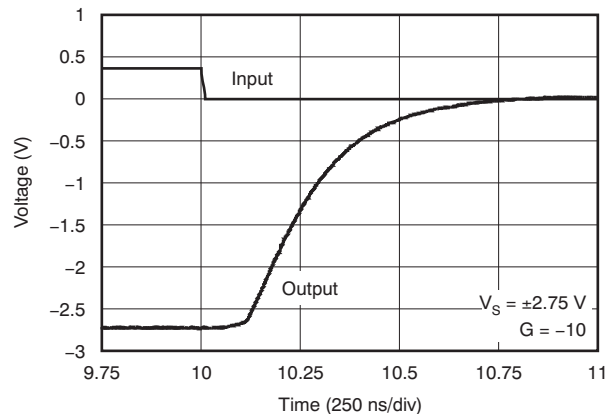

Figure 32. Negative Recovery Time

8.4 Device Functional Modes

The OPAx322-Q1 family of operational amplifiers are operational when power-supply voltages between 1.8 V to 5.5 V are applied.

9 Application and Implementation

NOTE

Information in the following applications sections is not part of the TI component specification, and TI does not warrant its accuracy or completeness. TI's customers are responsible for determining suitability of components for their purposes. Customers should validate and test their design implementation to confirm system functionality.

9.1 Application Information

The OPAx322-Q1 family offers outstanding DC and AC performance. These devices operate up to a 5.5-V power supply and offer ultra-low input bias current and 20-MHz bandwidth. These features make the OPAx322-Q1 family a robust operational amplifier for both battery-powered and industrial applications.

9.1.1 Active Filter

The OPAx322-Q1 is well-suited for active filter applications that require a wide bandwidth, fast slew rate, low-noise, single-supply operational amplifier. Figure 33 shows a 500-kHz, second-order, low-pass filter using the multiple-feedback (MFB) topology. The components are selected to provide a maximally flat Butterworth response. Beyond the cutoff frequency, roll-off is -40 dB/dec. The Butterworth response is ideal for applications that require predictable gain characteristics, such as the anti-aliasing filter used in front of an ADC.

One point to observe when considering the MFB filter is that the output is inverted relative to the input. If this inversion is not required (or not desired) a noninverting output can be achieved through one of these options:

1. Adding an inverting amplifier
2. Adding an additional second-order MFB stage
3. Using a noninverting filter topology, such as the Sallen-Key (shown in Figure 34).

MFB, Sallen-Key, low-pass, and high-pass filter synthesis is quickly accomplished using TI's FilterPro™ program. This software is available as a free download at www.ti.com.

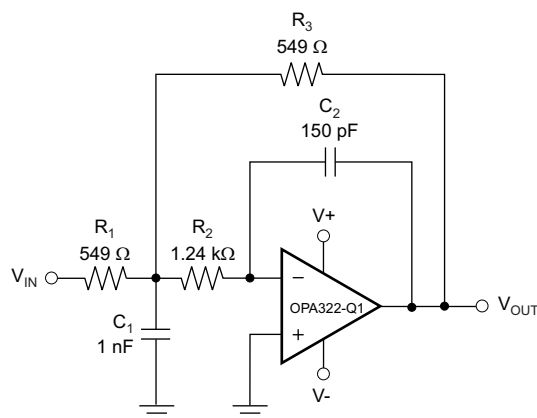

Copyright © 2016, Texas Instruments Incorporated

Figure 33. Second-Order, Butterworth, 500-kHz Low-Pass Filter

Application Information (continued)

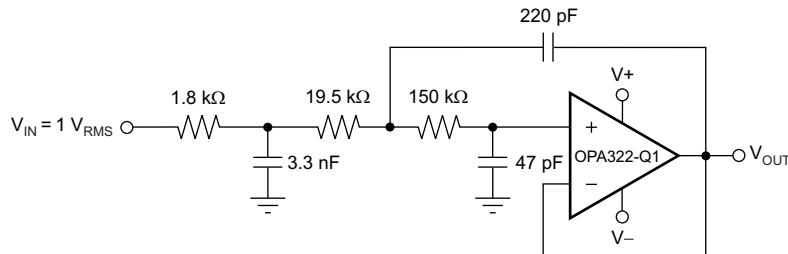

Copyright © 2016, Texas Instruments Incorporated

Figure 34. OPAx322-Q1 Configured as a Three-Pole, 20-kHz, Sallen-Key Filter

9.2 Typical Application

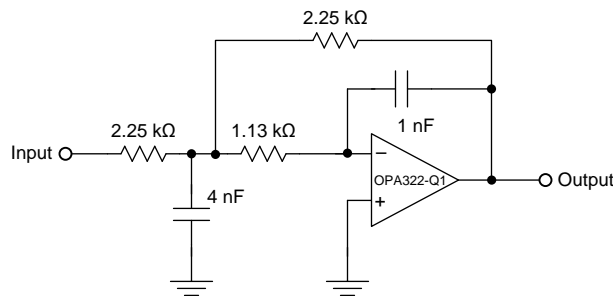

Copyright © 2017, Texas Instruments Incorporated

Figure 35. Second-Order, Low-Pass Filter Schematic

9.2.1 Design Requirements

- Gain = 1 V/V
- Low-pass cutoff frequency = 50 kHz
- –40-dB/dec filter response
- Maintain less than 3-dB gain peaking in the gain versus frequency response

9.2.2 Detailed Design Procedure

The infinite-gain multiple-feedback circuit for a low-pass network function is shown in [Equation 2](#). Use [Equation 2](#) to calculate the voltage transfer function.

$$\frac{\text{Output}}{\text{Input}}(s) = \frac{-1/R_1 R_3 C_2 C_5}{s^2 + (s/C_2)(1/R_1 + 1/R_3 + 1/R_4) + 1/R_3 R_4 C_2 C_5} \quad (2)$$

This circuit produces a signal inversion. For this circuit, the gain at DC and the low-pass cutoff frequency are calculated by [Equation 3](#).

$$\text{Gain} = \frac{R_4}{R_1}$$

$$f_c = \frac{1}{2\pi} \sqrt{(1/R_3 R_4 C_2 C_5)} \quad (3)$$

Software tools are readily available to simplify filter design. WEBENCH® Filter Designer is a simple, powerful, and easy-to-use active filter design program. The [WEBENCH® Filter Designer](#) allows the user to create optimized filter designs using a selection of TI operational amplifiers and passive components from TI's vendor partners.

Typical Application (continued)

Available as a web-based tool from the WEBENCH® Design Center, WEBENCH® Filter Designer allows the user to design, optimize, and simulate complete multistage active filter solutions within minutes.

9.2.3 Application Curve

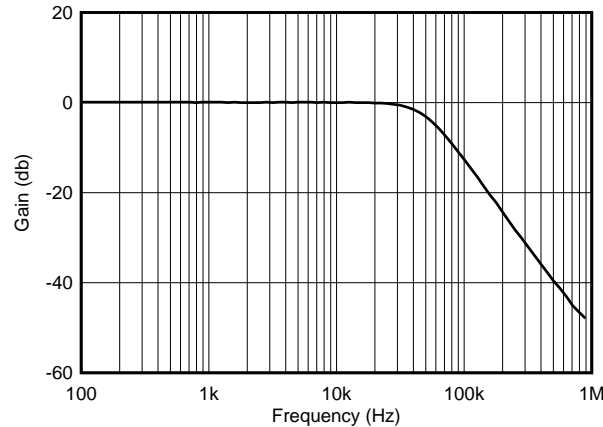

Figure 36. OPAx322-Q1 Second-Order, 50-kHz, Low-Pass Filter

10 Power Supply Recommendations

The OPAx322-Q1 family is specified for operation from 1.8 V to 5.5 V (± 0.9 V to ± 2.75 V); many specifications apply from -40°C to $+125^{\circ}\text{C}$. Parameters that can exhibit significant variance with regard to operating voltage or temperature are presented in [Typical Characteristics](#).

CAUTION

Supply voltages larger than 6 V can permanently damage the device; see the [Absolute Maximum Ratings](#).

Place 0.1- μF bypass capacitors close to the power-supply pins to reduce errors coupling in from noisy or high-impedance power supplies. For more detailed information on bypass capacitor placement, see [Layout](#).

11 Layout

11.1 Layout Guidelines

The OPAx322-Q1 is a wideband amplifier. To realize the full operational performance of the device, follow good high-frequency printed-circuit board (PCB) layout practices. The bypass capacitors must be connected between each supply pin and ground as close as possible to the device. The bypass capacitor traces must be designed for minimum inductance.

11.2 Layout Example

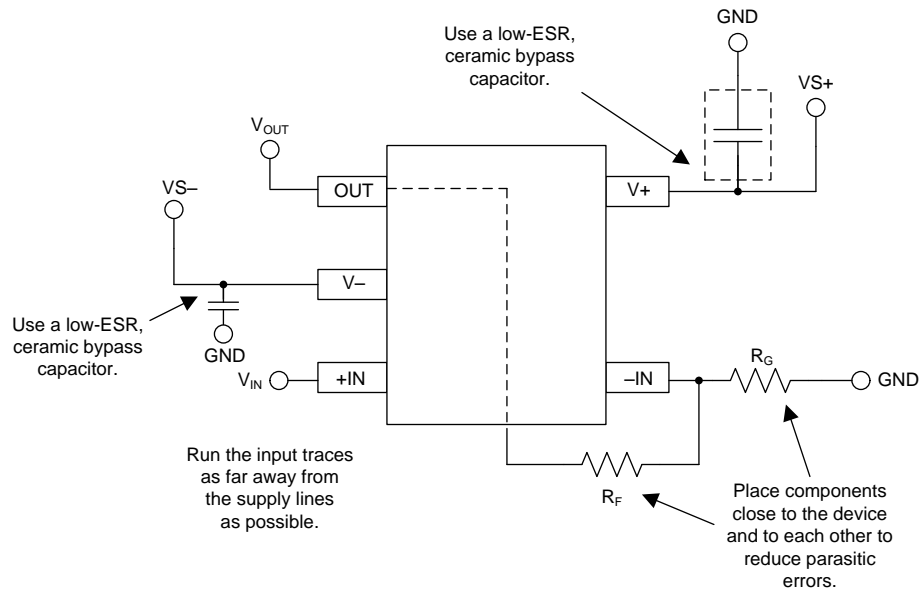

Copyright © 2017, Texas Instruments Incorporated

Figure 37. Layout Example

12 Device and Documentation Support

12.1 Device Support

12.1.1 Third-Party Products Disclaimer

TI'S PUBLICATION OF INFORMATION REGARDING THIRD-PARTY PRODUCTS OR SERVICES DOES NOT CONSTITUTE AN ENDORSEMENT REGARDING THE SUITABILITY OF SUCH PRODUCTS OR SERVICES OR A WARRANTY, REPRESENTATION OR ENDORSEMENT OF SUCH PRODUCTS OR SERVICES, EITHER ALONE OR IN COMBINATION WITH ANY TI PRODUCT OR SERVICE.

12.1.2 Development Support

12.1.2.1 TINA-TI™ (Free Software Download)

TINA™ is a simple, powerful, and easy-to-use circuit simulation program based on a SPICE engine. TINA-TI™ is a free, fully-functional version of the TINA software, preloaded with a library of macro models in addition to a range of both passive and active models. TINA-TI provides all the conventional DC, transient, and frequency domain analysis of SPICE, as well as additional design capabilities.

Available as a [free download](#) from the Analog eLab Design Center, TINA-TI offers extensive post-processing capability that allows users to format results in a variety of ways. Virtual instruments offer the ability to select input waveforms and probe circuit nodes, voltages, and waveforms, creating a dynamic quick-start tool.

NOTE

These files require that either the TINA software (from DesignSoft™) or TINA-TI software be installed. Download the free TINA-TI software from the [TINA-TI folder](#).

12.1.2.2 DIP Adapter EVM

The [DIP Adapter EVM](#) tool provides an easy, low-cost way to prototype small surface mount devices. The evaluation tool these TI packages: D or U (SOIC-8), PW (TSSOP-8), DGK (VSSOP-8), DBV (SOT23-6, SOT23-5 and SOT23-3), DCK (SC70-6 and SC70-5), and DRL (SOT563-6). The DIP Adapter EVM may also be used with terminal strips or may be wired directly to existing circuits.

12.1.2.3 Universal Operational Amplifier EVM

The [Universal Op Amp EVM](#) is a series of general-purpose, blank circuit boards that simplify prototyping circuits for a variety of device package types. The evaluation module board design allows many different circuits to be constructed easily and quickly. Five models are offered, with each model intended for a specific package type. PDIP, SOIC, VSSOP, TSSOP and SOT-23 packages are all supported.

NOTE

These boards are unpopulated, so users must provide their own devices. TI recommends requesting several op amp device samples when ordering the Universal Op Amp EVM.

12.1.2.4 TI Precision Designs

TI Precision Designs are analog solutions created by TI's precision analog applications experts and offer the theory of operation, component selection, simulation, complete PCB schematic and layout, bill of materials, and measured performance of many useful circuits. TI Precision Designs are available online at <http://www.ti.com/ww/en/analog/precision-designs/>.

12.1.2.5 WEBENCH® Filter Designer

[WEBENCH® Filter Designer](#) is a simple, powerful, and easy-to-use active filter design program. The WEBENCH® Filter Designer allows the user to create optimized filter designs using a selection of TI operational amplifiers and passive components from TI's vendor partners.

Device Support (continued)

Available as a web-based tool from the WEBENCH® Design Center, [WEBENCH® Filter Designer](#) allows the user to design, optimize, and simulate complete multistage active filter solutions within minutes.

12.2 Documentation Support

12.2.1 Related Documentation

The following documents are relevant to using the OPAx322x-Q1 family, and recommended for reference. All are available for download at www.ti.com unless otherwise noted.

- [QFN/SON PCB Attachment](#)(SLVA271)
- [Quad Flatpack No-Lead Logic Packages](#) (SCBA017)
- [OPA322, OPA2322, OPA4322 EMIR Immunity Performance](#) (SBOT005)
- [FilterPro™ User's Guide](#) (SBFA001)
- [AFE for Transient Recorder and Digital Fault Recorder Using High-Speed ADCs and Differential Amplifiers](#) (TIDUAT7)
- [Reference Design for Interfacing Current Output Hall Sensors and CTs With Differential ADCs/MCUs](#) (TIDUA57A)
- [Single-Ended Signal Conditioning Circuit for Current and Voltage Measurement Using Fluxgate Sensors](#) (TIDU585)
- [Differential Signal Conditioning Circuit for Current and Voltage Measurement Using Fluxgate Sensors](#) (TIDU569)

12.3 Related Links

The table below lists quick access links. Categories include technical documents, support and community resources, tools and software, and quick access to sample or buy.

Table 1. Related Links

PARTS	PRODUCT FOLDER	ORDER NOW	TECHNICAL DOCUMENTS	TOOLS & SOFTWARE	SUPPORT & COMMUNITY
OPA322-Q1	Click here	Click here	Click here	Click here	Click here
OPA2322-Q1	Click here	Click here	Click here	Click here	Click here
OPA4322-Q1	Click here	Click here	Click here	Click here	Click here

12.4 Receiving Notification of Documentation Updates

To receive notification of documentation updates, navigate to the device product folder on ti.com. In the upper right corner, click on *Alert me* to register and receive a weekly digest of any product information that has changed. For change details, review the revision history included in any revised document.

12.5 Community Resources

The following links connect to TI community resources. Linked contents are provided "AS IS" by the respective contributors. They do not constitute TI specifications and do not necessarily reflect TI's views; see TI's [Terms of Use](#).

TI E2E™ Online Community *TI's Engineer-to-Engineer (E2E) Community*. Created to foster collaboration among engineers. At e2e.ti.com, you can ask questions, share knowledge, explore ideas and help solve problems with fellow engineers.

Design Support *TI's Design Support* Quickly find helpful E2E forums along with design support tools and contact information for technical support.

12.6 Trademarks

FilterPro, TINA-TI, E2E are trademarks of Texas Instruments.
WEBENCH is a registered trademark of Texas Instruments.
TINA, DesignSoft are trademarks of DesignSoft, Inc.
is a trademark of ~ Texas Instruments.
All other trademarks are the property of their respective owners.

12.7 Electrostatic Discharge Caution



These devices have limited built-in ESD protection. The leads should be shorted together or the device placed in conductive foam during storage or handling to prevent electrostatic damage to the MOS gates.

12.8 Glossary

[SLYZ022](#) — *TI Glossary*.

This glossary lists and explains terms, acronyms, and definitions.

13 Mechanical, Packaging, and Orderable Information

The following pages include mechanical, packaging, and orderable information. This information is the most current data available for the designated devices. This data is subject to change without notice and revision of this document. For browser-based versions of this data sheet, refer to the left-hand navigation.

PACKAGING INFORMATION

Orderable Device	Status (1)	Package Type	Package Drawing	Pins	Package Qty	Eco Plan (2)	Lead finish/ Ball material (6)	MSL Peak Temp (3)	Op Temp (°C)	Device Marking (4/5)	Samples
OPA2322AQDGKRQ1	ACTIVE	VSSOP	DGK	8	2500	RoHS & Green	NIPDAU NIPDAUAG	Level-2-260C-1 YEAR	-40 to 125	OVDQ	Samples
OPA322AQDBVRQ1	ACTIVE	SOT-23	DBV	5	3000	RoHS & Green	NIPDAU	Level-2-260C-1 YEAR	-40 to 125	19AD	Samples
OPA4322AQPWRQ1	ACTIVE	TSSOP	PW	14	2000	RoHS & Green	NIPDAU	Level-3-260C-168 HR	-40 to 125	4322AQ1	Samples

(1) The marketing status values are defined as follows:

ACTIVE: Product device recommended for new designs.

LIFEBUY: TI has announced that the device will be discontinued, and a lifetime-buy period is in effect.

NRND: Not recommended for new designs. Device is in production to support existing customers, but TI does not recommend using this part in a new design.

PREVIEW: Device has been announced but is not in production. Samples may or may not be available.

OBSOLETE: TI has discontinued the production of the device.

(2) **RoHS:** TI defines "RoHS" to mean semiconductor products that are compliant with the current EU RoHS requirements for all 10 RoHS substances, including the requirement that RoHS substance do not exceed 0.1% by weight in homogeneous materials. Where designed to be soldered at high temperatures, "RoHS" products are suitable for use in specified lead-free processes. TI may reference these types of products as "Pb-Free".

RoHS Exempt: TI defines "RoHS Exempt" to mean products that contain lead but are compliant with EU RoHS pursuant to a specific EU RoHS exemption.

Green: TI defines "Green" to mean the content of Chlorine (Cl) and Bromine (Br) based flame retardants meet JS709B low halogen requirements of <=1000ppm threshold. Antimony trioxide based flame retardants must also meet the <=1000ppm threshold requirement.

(3) MSL, Peak Temp. - The Moisture Sensitivity Level rating according to the JEDEC industry standard classifications, and peak solder temperature.

(4) There may be additional marking, which relates to the logo, the lot trace code information, or the environmental category on the device.

(5) Multiple Device Markings will be inside parentheses. Only one Device Marking contained in parentheses and separated by a "~" will appear on a device. If a line is indented then it is a continuation of the previous line and the two combined represent the entire Device Marking for that device.

(6) Lead finish/Ball material - Orderable Devices may have multiple material finish options. Finish options are separated by a vertical ruled line. Lead finish/Ball material values may wrap to two lines if the finish value exceeds the maximum column width.

Important Information and Disclaimer:The information provided on this page represents TI's knowledge and belief as of the date that it is provided. TI bases its knowledge and belief on information provided by third parties, and makes no representation or warranty as to the accuracy of such information. Efforts are underway to better integrate information from third parties. TI has taken and continues to take reasonable steps to provide representative and accurate information but may not have conducted destructive testing or chemical analysis on incoming materials and chemicals. TI and TI suppliers consider certain information to be proprietary, and thus CAS numbers and other limited information may not be available for release.

In no event shall TI's liability arising out of such information exceed the total purchase price of the TI part(s) at issue in this document sold by TI to Customer on an annual basis.

OTHER QUALIFIED VERSIONS OF OPA2322-Q1, OPA322-Q1, OPA4322-Q1 :

- Catalog : [OPA2322](#), [OPA322](#), [OPA4322](#)

NOTE: Qualified Version Definitions:

- Catalog - TI's standard catalog product

TAPE AND REEL INFORMATION

QUADRANT ASSIGNMENTS FOR PIN 1 ORIENTATION IN TAPE

*All dimensions are nominal

Device	Package Type	Package Drawing	Pins	SPQ	Reel Diameter (mm)	Reel Width W1 (mm)	A0 (mm)	B0 (mm)	K0 (mm)	P1 (mm)	W (mm)	Pin1 Quadrant
OPA2322AQDGKRQ1	VSSOP	DGK	8	2500	330.0	12.4	5.3	3.4	1.4	8.0	12.0	Q1
OPA322AQDBVRQ1	SOT-23	DBV	5	3000	178.0	9.0	3.3	3.2	1.4	4.0	8.0	Q3
OPA4322AQPWRQ1	TSSOP	PW	14	2000	330.0	12.4	6.9	5.6	1.6	8.0	12.0	Q1

TAPE AND REEL BOX DIMENSIONS

*All dimensions are nominal

Device	Package Type	Package Drawing	Pins	SPQ	Length (mm)	Width (mm)	Height (mm)
OPA2322AQDGKRQ1	VSSOP	DGK	8	2500	353.0	353.0	32.0
OPA322AQDBVRQ1	SOT-23	DBV	5	3000	180.0	180.0	18.0
OPA4322AQPWRQ1	TSSOP	PW	14	2000	356.0	356.0	35.0

PW0014A



PACKAGE OUTLINE

TSSOP - 1.2 mm max height

SMALL OUTLINE PACKAGE

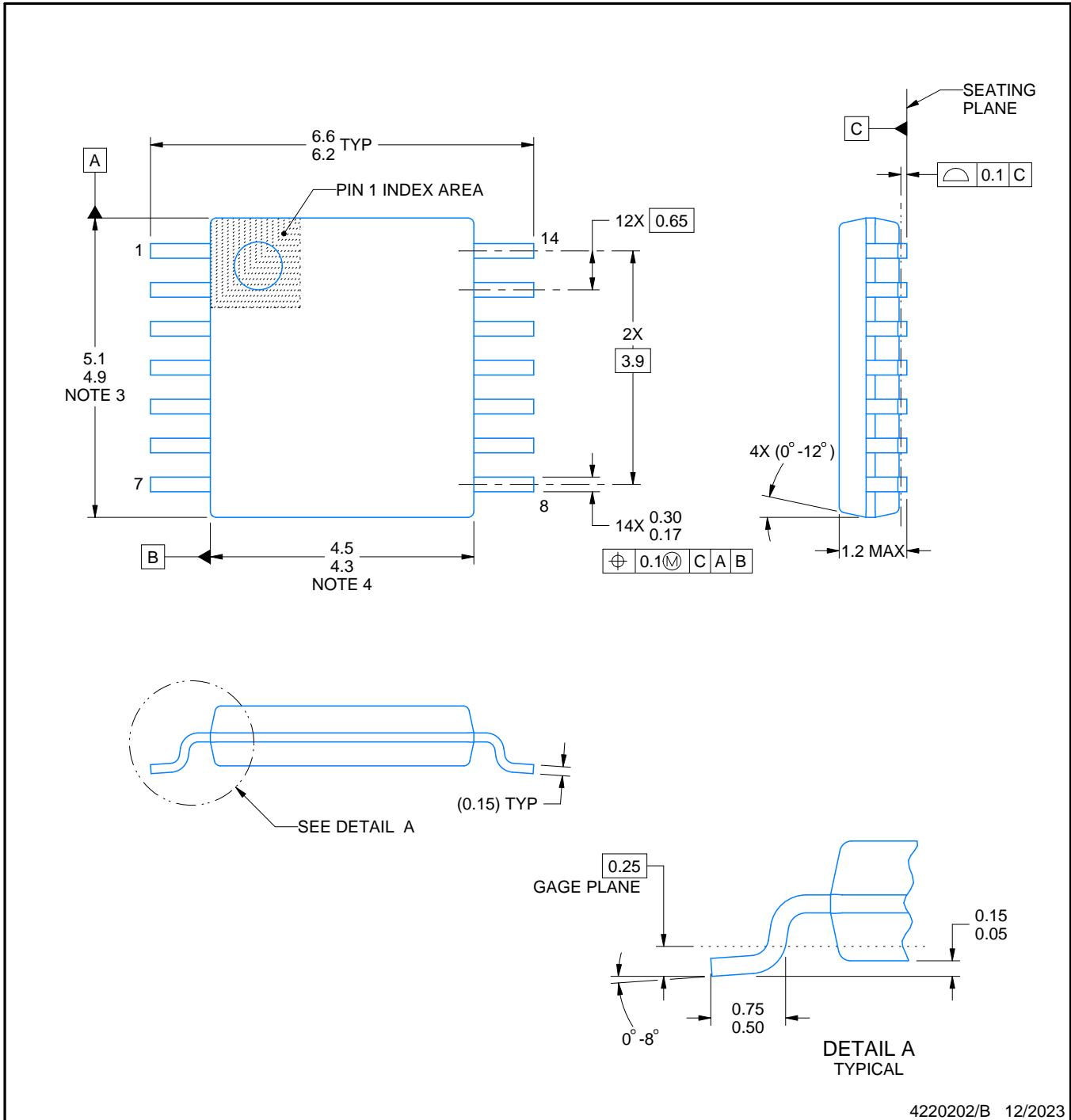

NOTES:

1. All linear dimensions are in millimeters. Any dimensions in parenthesis are for reference only. Dimensioning and tolerancing per ASME Y14.5M.
2. This drawing is subject to change without notice.
3. This dimension does not include mold flash, protrusions, or gate burrs. Mold flash, protrusions, or gate burrs shall not exceed 0.15 mm per side.
4. This dimension does not include interlead flash. Interlead flash shall not exceed 0.25 mm per side.
5. Reference JEDEC registration MO-153.

EXAMPLE BOARD LAYOUT

PW0014A

TSSOP - 1.2 mm max height

SMALL OUTLINE PACKAGE



LAND PATTERN EXAMPLE
EXPOSED METAL SHOWN
SCALE: 10X



4220202/B 12/2023

NOTES: (continued)

- 6. Publication IPC-7351 may have alternate designs.
- 7. Solder mask tolerances between and around signal pads can vary based on board fabrication site.

EXAMPLE STENCIL DESIGN

PW0014A

TSSOP - 1.2 mm max height

SMALL OUTLINE PACKAGE



SOLDER PASTE EXAMPLE
BASED ON 0.125 mm THICK STENCIL
SCALE: 10X

4220202/B 12/2023

NOTES: (continued)

8. Laser cutting apertures with trapezoidal walls and rounded corners may offer better paste release. IPC-7525 may have alternate design recommendations.
9. Board assembly site may have different recommendations for stencil design.

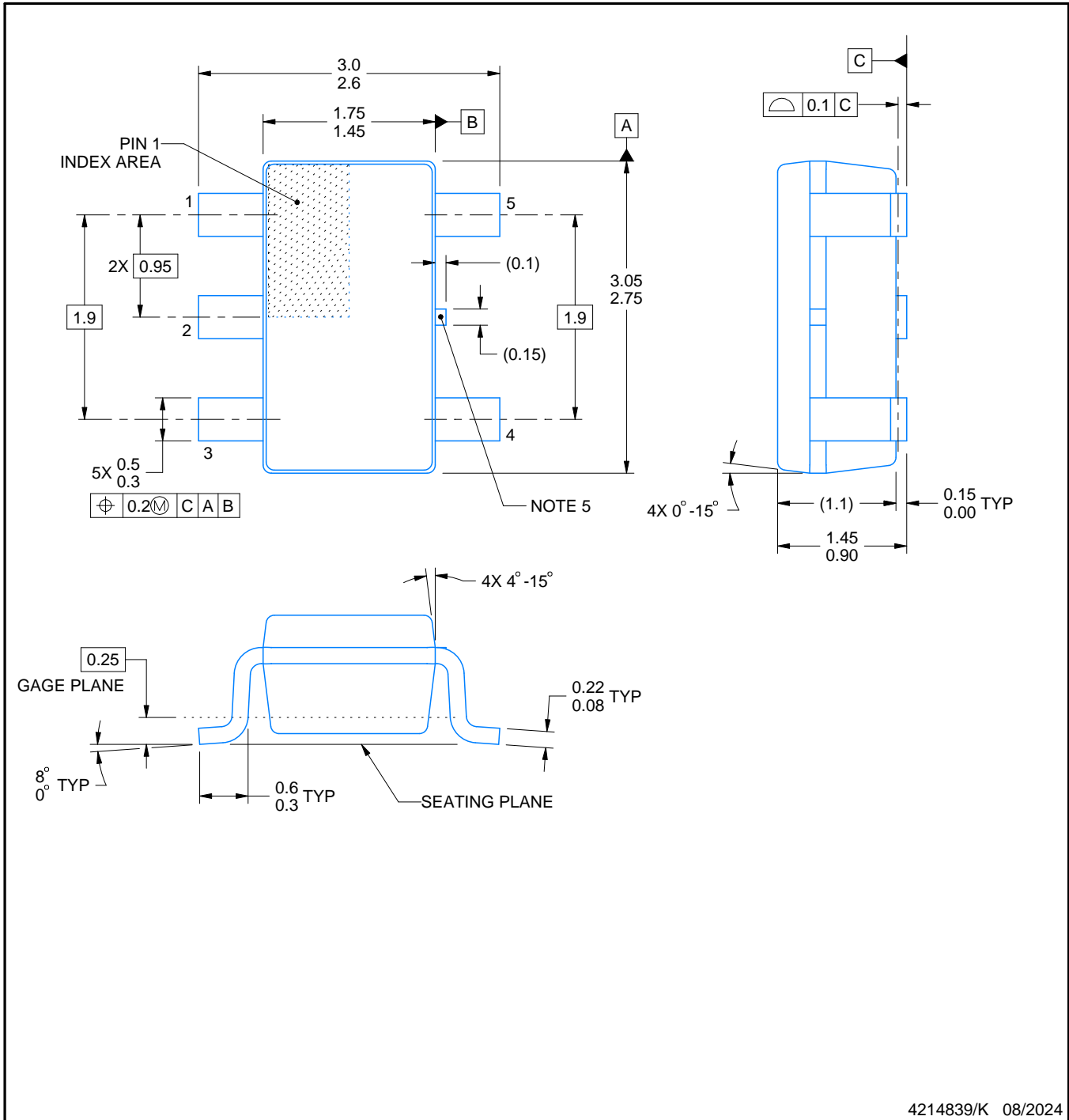

4214839/K 08/2024

NOTES:

1. All linear dimensions are in millimeters. Any dimensions in parenthesis are for reference only. Dimensioning and tolerancing per ASME Y14.5M.
2. This drawing is subject to change without notice.
3. Reference JEDEC MO-178.
4. Body dimensions do not include mold flash, protrusions, or gate burrs. Mold flash, protrusions, or gate burrs shall not exceed 0.25 mm per side.
5. Support pin may differ or may not be present.

EXAMPLE BOARD LAYOUT

DBV0005A

SOT-23 - 1.45 mm max height

SMALL OUTLINE TRANSISTOR



LAND PATTERN EXAMPLE
EXPOSED METAL SHOWN
SCALE:15X



SOLDER MASK DETAILS

4214839/K 08/2024

NOTES: (continued)

- 6. Publication IPC-7351 may have alternate designs.
- 7. Solder mask tolerances between and around signal pads can vary based on board fabrication site.

EXAMPLE STENCIL DESIGN

DBV0005A

SOT-23 - 1.45 mm max height

SMALL OUTLINE TRANSISTOR



SOLDER PASTE EXAMPLE
BASED ON 0.125 mm THICK STENCIL
SCALE:15X

4214839/K 08/2024

NOTES: (continued)

8. Laser cutting apertures with trapezoidal walls and rounded corners may offer better paste release. IPC-7525 may have alternate design recommendations.
9. Board assembly site may have different recommendations for stencil design.

DGK0008A



PACKAGE OUTLINE

VSSOP - 1.1 mm max height

SMALL OUTLINE PACKAGE



4214862/A 04/2023

NOTES:

PowerPAD is a trademark of Texas Instruments.

- All linear dimensions are in millimeters. Any dimensions in parenthesis are for reference only. Dimensioning and tolerancing per ASME Y14.5M.
- This drawing is subject to change without notice.
- This dimension does not include mold flash, protrusions, or gate burrs. Mold flash, protrusions, or gate burrs shall not exceed 0.15 mm per side.
- This dimension does not include interlead flash. Interlead flash shall not exceed 0.25 mm per side.
- Reference JEDEC registration MO-187.

EXAMPLE BOARD LAYOUT

DGK0008A

™ VSSOP - 1.1 mm max height

SMALL OUTLINE PACKAGE



LAND PATTERN EXAMPLE
EXPOSED METAL SHOWN
SCALE: 15X



SOLDER MASK DETAILS

4214862/A 04/2023

NOTES: (continued)

6. Publication IPC-7351 may have alternate designs.
7. Solder mask tolerances between and around signal pads can vary based on board fabrication site.
8. Vias are optional depending on application, refer to device data sheet. If any vias are implemented, refer to their locations shown on this view. It is recommended that vias under paste be filled, plugged or tented.
9. Size of metal pad may vary due to creepage requirement.

EXAMPLE STENCIL DESIGN

DGK0008A

™ VSSOP - 1.1 mm max height

SMALL OUTLINE PACKAGE



SOLDER PASTE EXAMPLE
SCALE: 15X

4214862/A 04/2023

NOTES: (continued)

11. Laser cutting apertures with trapezoidal walls and rounded corners may offer better paste release. IPC-7525 may have alternate design recommendations.
12. Board assembly site may have different recommendations for stencil design.

IMPORTANT NOTICE AND DISCLAIMER

TI PROVIDES TECHNICAL AND RELIABILITY DATA (INCLUDING DATA SHEETS), DESIGN RESOURCES (INCLUDING REFERENCE DESIGNS), APPLICATION OR OTHER DESIGN ADVICE, WEB TOOLS, SAFETY INFORMATION, AND OTHER RESOURCES "AS IS" AND WITH ALL FAULTS, AND DISCLAIMS ALL WARRANTIES, EXPRESS AND IMPLIED, INCLUDING WITHOUT LIMITATION ANY IMPLIED WARRANTIES OF MERCHANTABILITY, FITNESS FOR A PARTICULAR PURPOSE OR NON-INFRINGEMENT OF THIRD PARTY INTELLECTUAL PROPERTY RIGHTS.

These resources are intended for skilled developers designing with TI products. You are solely responsible for (1) selecting the appropriate TI products for your application, (2) designing, validating and testing your application, and (3) ensuring your application meets applicable standards, and any other safety, security, regulatory or other requirements.

These resources are subject to change without notice. TI grants you permission to use these resources only for development of an application that uses the TI products described in the resource. Other reproduction and display of these resources is prohibited. No license is granted to any other TI intellectual property right or to any third party intellectual property right. TI disclaims responsibility for, and you will fully indemnify TI and its representatives against, any claims, damages, costs, losses, and liabilities arising out of your use of these resources.

TI's products are provided subject to [TI's Terms of Sale](#) or other applicable terms available either on [ti.com](https://www.ti.com) or provided in conjunction with such TI products. TI's provision of these resources does not expand or otherwise alter TI's applicable warranties or warranty disclaimers for TI products.

TI objects to and rejects any additional or different terms you may have proposed.

Mailing Address: Texas Instruments, Post Office Box 655303, Dallas, Texas 75265

Copyright © 2025, Texas Instruments Incorporated